



MEX-BTS

MXM System

User's Manual 2nd Ed

Copyright Notice

This document is copyrighted, 2026. All rights are reserved. The original manufacturer reserves the right to make improvements to the products described in this manual at any time without notice.

No part of this manual may be reproduced, copied, translated, or transmitted in any form or by any means without the prior written permission of the original manufacturer. Information provided in this manual is intended to be accurate and reliable. However, the original manufacturer assumes no responsibility for its use, or for any infringements upon the rights of third parties that may result from its use.

The material in this document is for product information only and is subject to change without notice. While reasonable efforts have been made in the preparation of this document to assure its accuracy, AAEMON assumes no liabilities resulting from errors or omissions in this document, or from the use of the information contained herein.

AAEMON reserves the right to make changes in the product design without notice to its users.

Acknowledgements

All other products' name or trademarks are properties of their respective owners.

- Microsoft Windows® is a registered trademark of Microsoft Corp.
- Intel® is a registered trademark of Intel Corporation
- Intel Core™ is a trademark of Intel Corporation
- Realtek is a trademark of Realtek Semiconductor Corporation.
- Ubuntu is a trademark of Canonical.
- Linux® is a registered trademark of Linus Torvalds in the U.S. and other countries.

All other product names or trademarks are properties of their respective owners.

Packing List

Before setting up your product, please make sure the following items have been shipped:

Item	Quantity
• MEX-BTS	1

If any of these items are missing or damaged, please contact your distributor or sales representative immediately.

About this Document

This User's Manual contains all the essential information, such as detailed descriptions and explanations on the product's hardware and software features (if any), its specifications, dimensions, jumper/connector settings/definitions, and driver installation instructions (if any), to facilitate users in setting up their product.

Users may refer to the product page at AAEON.com for the latest version of this document.

Safety Precautions

Please read the following safety instructions carefully. It is advised that you keep this manual for future references

1. All cautions and warnings on the device should be noted.
2. Make sure the power source matches the power rating of the device.
3. Position the power cord so that people cannot step on it. Do not place anything over the power cord.
4. Always completely disconnect the power before working on the system's hardware.
5. No connections should be made when the system is powered as a sudden rush of power may damage sensitive electronic components.
6. If the device is not to be used for a long time, disconnect it from the power supply to avoid damage by transient over-voltage.
7. Always disconnect this device from any AC supply before cleaning.
8. While cleaning, use a damp cloth instead of liquid or spray detergents.
9. Make sure the device is installed near a power outlet and is easily accessible.
10. Keep this device away from humidity.
11. Place the device on a solid surface during installation to prevent falls
12. Do not cover the openings on the device to ensure optimal heat dissipation.
13. Watch out for high temperatures when the system is running.
14. Do not touch the heat sink or heat spreader when the system is running
15. Never pour any liquid into the openings. This could cause fire or electric shock.
16. As most electronic components are sensitive to static electrical charge, be sure to ground yourself to prevent static charge when installing the internal components. Use a grounding wrist strap and contain all electronic components in any static-shielded containers.

17. If any of the following situations arises, please contact our service personnel:
 - i. Damaged power cord or plug
 - ii. Liquid intrusion to the device
 - iii. Exposure to moisture
 - iv. Device is not working as expected or in a manner as described in this manual
 - v. The device is dropped or damaged
 - vi. Any obvious signs of damage displayed on the device
18. **DO NOT LEAVE THIS DEVICE IN AN UNCONTROLLED ENVIRONMENT WITH TEMPERATURES BEYOND THE DEVICE'S PERMITTED STORAGE TEMPERATURES (SEE CHAPTER 1) TO PREVENT DAMAGE.**

Warning!



This device complies with Part 15 FCC Rules. Operation is subject to the following two conditions: (1) this device may not cause harmful interference, and (2) this device must accept any interference received including interference that may cause undesired operation.

Caution:

There is a danger of explosion if the battery is incorrectly replaced. Replace only with the same or equivalent type recommended by the manufacturer. Dispose of used batteries according to the manufacturer's instructions and your local government's recycling or disposal directives.

Attention:

Il y a un risque d'explosion si la batterie est remplacée de façon incorrecte. Ne la remplacer qu'avec le même modèle ou équivalent recommandé par le constructeur. Recycler les batteries usées en accord avec les instructions du fabricant et les directives gouvernementales de recyclage.

产品中有毒有害物质或元素名称及含量

AAEON System

QO4-381 Rev.A2

部件名称	有毒有害物质或元素					
	铅 (Pb)	汞 (Hg)	镉 (Cd)	六价铬 (Cr(VI))	多溴联苯 (PBB)	多溴二苯醚 (PBDE)
印刷电路板 及其电子组件	×	○	○	○	○	○
外部信号 连接器及线材	×	○	○	○	○	○
外壳	○	○	○	○	○	○
中央处理器 与内存	×	○	○	○	○	○
硬盘	×	○	○	○	○	○
液晶模块	×	○	○	○	○	○
光驱	×	○	○	○	○	○
触控模块	×	○	○	○	○	○
电源	×	○	○	○	○	○
电池	×	○	○	○	○	○

本表格依据 SJ/T 11364 的规定编制。

○：表示该有毒有害物质在该部件所有均质材料中的含量均在 GB/T 26572 标准规定的限量要求以下。

×：表示该有害物质的某一均质材料超出了 GB/T 26572 的限量要求，然而该部件仍符合欧盟指令 2011/65/EU 的规范。

环保使用期限(EFUP (Environmental Friendly Use Period))：10 年

备注：

一、此产品所标示之环保使用期限，系指在一般正常使用状况下。

二、上述部件物质中央处理器、内存、硬盘、光驱、电源为选购品。

三、上述部件物质液晶模块、触控模块仅一体机产品适用。

China RoHS Requirement (EN)

MM System

MEX-BTS

Name and content of hazardous substances in product

AAEON System

QO4-381 Rev.A2

Part Name	Hazardous Substances					
	铅 (Pb)	汞 (Hg)	镉 (Cd)	六价铬 (Cr(VI))	多溴联苯 (PBB)	多溴二苯醚 (PBDE)
PCB Assemblies	×	○	○	○	○	○
Connector and Cable	×	○	○	○	○	○
Chassis	○	○	○	○	○	○
CPU and Memory	×	○	○	○	○	○
Hard Disk	×	○	○	○	○	○
LCD Modules	×	○	○	○	○	○
CD-ROM/DVD-ROM	×	○	○	○	○	○
Touch Modules	×	○	○	○	○	○
Power	×	○	○	○	○	○
Battery	×	○	○	○	○	○

The table is prepared in accordance with the provisions of SJ/T 11364.
 ○ : Indicates that said hazardous substance contained in all of the homogenous materials for this product is below the limit requirement of GB/T 26572.
 × : Indicates that said hazardous substance contained in at least one of the homogenous materials used for this part is above the limit requirement of GB/T 26572. But this product still be compliance with 2011/65/EU Directive (allowed with 2011/65/EU Annex III of RoHS exemption with number 6(c),7(a),7(c)-1).
 EFUP (Environment Friendly Use Period) value: 10 years.
 Notes:
 1. This product defined period of use is under normal condition.
 2. In above part, CPU/Memory/ Hard Disk/CD-ROM/DVD-ROM/ Power are optional.
 3. In above part, LCD Modules/ Touch Modules are for all-in-one product model.

Table of Contents

Chapter 1 - Product Specifications	1
1.1 Specifications	2
1.2 Block Diagram	6
Chapter 2 – Hardware Information	7
2.1 Dimensions	8
2.2 Jumpers and Connectors.....	11
2.3 List of Jumpers	13
2.3.1 COM 1 RI Jumper (JP1).....	14
2.3.2 COM2 RI Jumper (JP2).....	15
2.3.3 Auto Power Button AT/ATX Selection / Clear CMOS Jumper (JP3)....	16
2.4 List of Connectors.....	17
2.4.1 GPIO Port (8~15) Connector (CN1)	19
2.4.2 GPIO Port (0~7) Connector (CN2)	20
2.4.3 4-Pin Fan Connector (90D) System (CN3).....	21
2.4.4 4-Pin Fan Connector (90D) MXM (CN4).....	21
2.4.5 IMVP9 FW Reflash (CN5).....	22
2.4.6 Front Panel (10Pin*1 Board to Wire) (CN6)	23
2.4.7 USB 2.0 Port 5/Port 6 (CN7)	24
2.4.8 External +5VSB Input (CN8)	25
2.4.9 4-Pin Fan Connector (90D) CPU (CN9).....	25
2.4.10 DDR5 SODIMM Slot (CN12).....	26
2.4.11 DDR5 SODIMM Slot (CN13).....	26
2.4.12 MXM Connector (CN14)	27
2.4.13 COM Port 4 (9Pin*1 Board to Wire) RS-232 (CN15)	27
2.4.14 COM Port 3 (9Pin*1 Board to Wire) RS-232 (CN16)	28
2.4.15 SMBus / I2C Connector (CN18).....	29
2.4.16 SPI Flash Programming Port (7Pin*1 Board to Wire) (CN19).....	30

2.4.17	Port 80 Debug Port (10Pin*1 Board to Wire) (CN20).....	31
2.4.18	COM Port 2 (9Pin*1 Board to Wire) RS-232/422/485 (CN21)	32
2.4.19	COM Port 1 (9Pin*1 Board to Wire) RS-232/422/485 (CN22).....	33
2.4.20	Quad RJ-45 LAN Port (CN24).....	35
2.4.21	Dual RJ-45 LAN Port (FPC LAN).....	37
2.4.22	Audio Line In/Line Out/Mic (CN26).....	38
2.4.23	USB 3.2/USB 2.0 Port 3/Port 4 (CN27).....	39
2.4.24	USB 3.2/USB 2.0 Port 1/Port 2 (CN28).....	40
2.4.25	RTC Battery Connector (CN29).....	41
2.4.26	DP Port A (CN30).....	41
2.4.27	DP Port C (CN31).....	42
2.4.28	HDMI Port (CN32).....	43
2.4.29	Terminal Block DC Input Connector (19V – 24V) (CN33).....	44
2.4.30	FPC Connector (PCIe [x1] x 4)	45
2.4.31	M.2 M-Key Slot (From CPU) (CN35)	46
2.4.32	M.2 B-Key Slot (CN36).....	49
2.4.33	Nano SIM Card Slot (CN37).....	51
2.4.34	Full-size Mini Card Slot (CN38).....	52
2.4.35	M.2 M-Key Slot (From PCH) (CN39)	54
2.5	Hardware Installation	57
2.5.1	MXM Card Cooler Installation	57
2.5.2	MXM Card Installation	60
2.5.3	RAM Installation	63
2.5.4	M.2 Module Installation	65
Chapter 3 - AMI BIOS Setup		66
3.1	System Test and Initialization	67
3.2	AMI BIOS Setup	68
3.3	Setup Submenu: Main	69

3.4	Setup Submenu: Advanced.....	70
3.4.1	CPU Configuration.....	71
3.4.2	PCH-FW Configuration.....	72
3.4.3	Firmware Update Configuration.....	73
3.4.4	PTT Configuration.....	74
3.4.5	Trusted Computing.....	75
3.4.6	SATA Configuration.....	77
3.4.7	Hardware Monitor.....	78
3.4.7.1	Smart Fan Mode Configuration.....	79
3.4.8	SIO Configuration.....	80
3.4.8.1	Serial Port 1 Configuration.....	81
3.4.8.2	Serial Port 2 Configuration.....	82
3.4.8.3	Serial Port 3 Configuration.....	83
3.4.8.4	Serial Port 4 Configuration.....	84
3.4.9	Serial Port Console Redirection.....	85
3.4.10	Legacy Console Redirection Settings.....	86
3.4.11	AAEON BIOS Robot.....	87
3.4.12	Power Management.....	89
3.4.13	GPIO Port Configuration.....	90
3.4.14	AAEON Smart Boost.....	91
3.5	Setup Submenu: Chipset.....	92
3.5.1	System Agent (SA) Configuration.....	93
3.5.2	Memory Configuration.....	94
3.5.3	VMD Setup Menu.....	95
3.5.4	PCH-IO Configuration.....	96
3.5.5	NVMe Configuration.....	97
3.6	Setup Submenu: Security.....	98
3.6.1	Secure Boot.....	99

3.6.2	Key Management.....	100
3.7	Setup Submenu: Boot	102
3.8	Setup Submenu: Save & Exit.....	103
Chapter 4 – Drivers Installation.....		104
4.1	Drivers Download and Installation.....	105
Appendix A – I/O Information		107
A.1	I/O Address Map	108
A.2	Memory Address Map	110
A.3	Large Memory	112
A.4	IRQ Mapping Chart.....	113
Appendix B – Mating Connectors and Cables.....		121
B.1	Mating Connectors and Cables.....	122

Chapter 1

Product Specifications

1.1 Specifications

System

Form Factor	MXM System
CPU	12th/13th/14th Generation Intel® Core™ & Intel® Core™ Processors (Series 2), up to 65W
Chipset	Intel® R680E Chipset Intel® Q670E Chipset Intel® H610E Chipset (Optional)
Memory Type	Dual-Channel DDR5 SODIMM x 2, up to 5200, 64GB (ECC support for R680E SKU only) Note: DDR speed is dependent on CPU SKU
BIOS	UEFI
Wake on LAN	Yes (Onboard LAN only)
Watchdog Timer	255 Levels
Security	TPM 2.0 (Optional)
RTC Battery	Lithium Battery 3V/240mAh
Dimensions	11.6" x 7.3" x 1.9" (295mm x 186mm x 50mm)
OS Support	Windows® 10 (Versions 22H2 and later) Windows® 11 Ubuntu 24.04 Kernel 6.11

Power

Power Requirement	19V – 24V DC in
Power Supply Type	AT/ATX (Default: AT)
Connector	4-pin Phoenix Connector
Power Consumption	Intel® Core™ 7 251E, DDR5 32GB x 2, 6.58A @24V, 157.92W (Typical) Intel® Core™ 7 251E, DDR5 32GB x 2, 12.16A @24V, 291.84 (Max)

Display

Controller	CPU Graphic Controller Intel® UHD Graphics 770 (i5 SKU and above) Intel® UHD Graphics 730 (i3 SKU)
LVDS/eDP	-
Display Interface	HDMI 2.0 x 1, up to 3840 x 2160 @60Hz (from Main Board) DP++ 1.4 x 2 (from MXM Module, optional)
Multiple Display	1 Display from Main Board Up to 2 Simultaneous Displays from MXM Module

Audio

CODEC	Realtek ALC897
Audio Interface	Line-In/Line-Out/Mic
Speaker	-

External I/O

Ethernet	Intel® Ethernet Controller I226-LM, 2.5GbE RJ-45 x 2, from FPC (optional) Intel® Ethernet Controller I226-V, 2.5GbE RJ-45 x 3 Intel® Ethernet Connection I219-LM, GbE RJ-45 x 1
USB	USB 3.2 Gen 2 x 4 USB 2.0 x 2
Serial Port	-
Video	HDMI 2.0 x 1, up to 3840 x 2160 @60Hz (from Main Board) DP++ 1.4 x 2, up to 3840 x 2160 (from MXM Module, optional)

Internal I/O

USB	-
Serial Port	COM 1 / COM 2 (RS-232/422/485) COM 3 / COM 4 (RS-232) RI as default, 5V/12V selected by BOM change
Video	-
SATA	SATA 6Gb/s x 1 (Optional)
Audio	Audio Header x 1
DIO/GPIO	GPIO-16 bit
SMBus/I2C	SMBus (Default) / I2C
Touch	-
Fan	4-Pin Smart Fan (CPU) x 1 3-Pin Fan (MXM Module) x 1 System Fan x 1
SIM	Nano SIM x 1

Internal I/O

Front Panel	Power Button, Power LED
Others	-

Expansion

Mini PCIe/mSATA	-
M.2	M.2 2280 M-Key x 2 (PCIe 4.0 [x4] x 1 + PCIe 3.0 [x4] x 1) M.2 3052 B-Key x 1 (PCIe 3.0 [x2] + USB 3.2 + USB 2.0) Full-size Mini Card x 1 (PCIe 3.0 [x1] + USB 2.0)
Others	MXM 3.1 Type A / Type B Module Slot, TGP up to 120W

Environmental

Operating Temperature	32°F – 122°F (0°C – 50°C) with 0.5m/sec airflow
Storage Temperature	-40°F – 185°F (-40°C – 85°C)
Operating Humidity	0% – 90% relative humidity, non-condensing
MTBF (Hours)	768,724
EMC	CE/FCC Class A

1.2 Block Diagram

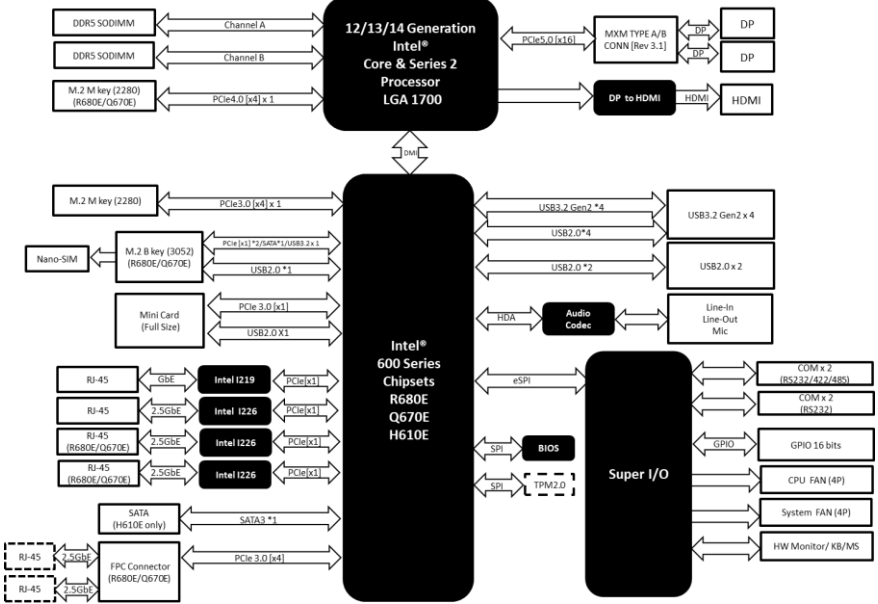

MXM System

MEX-BTS

Chapter 2

Hardware Information

2.1 Dimensions

System

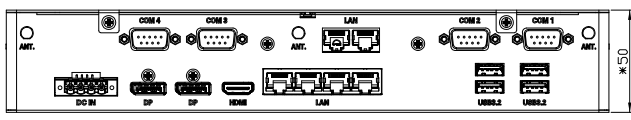
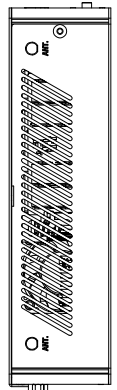
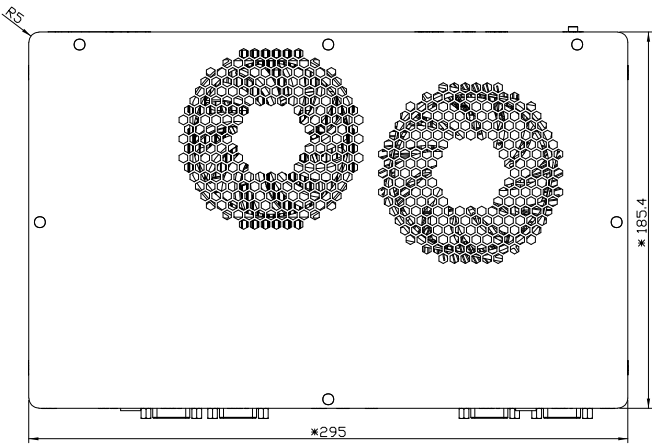
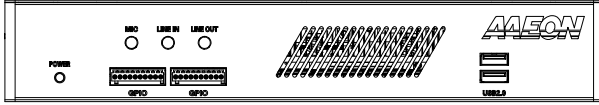

System Bottom

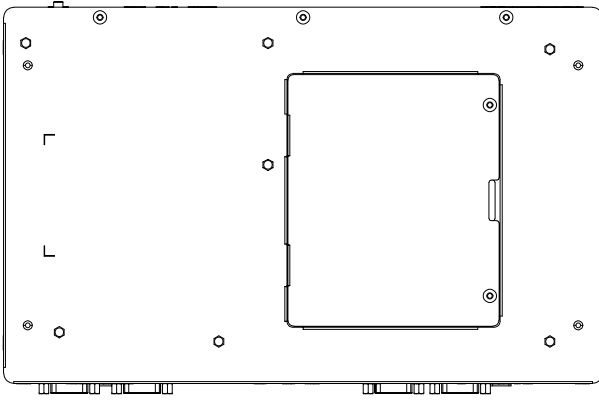

Board Top

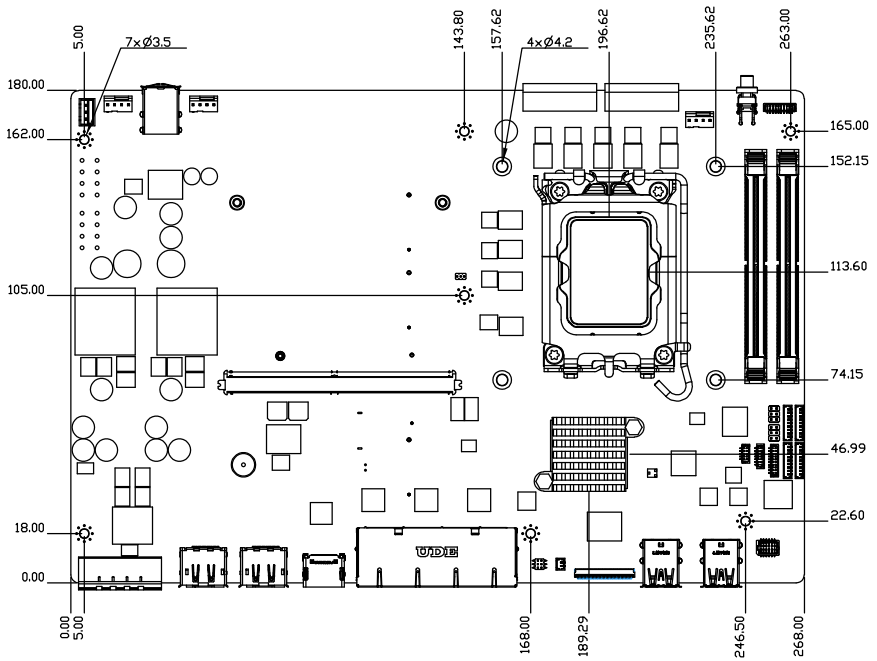

Board Bottom

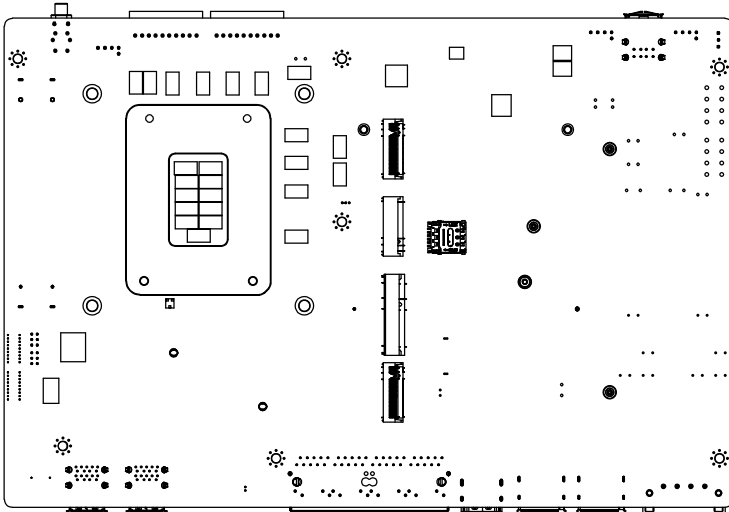

2.2 Jumpers and Connectors

Top

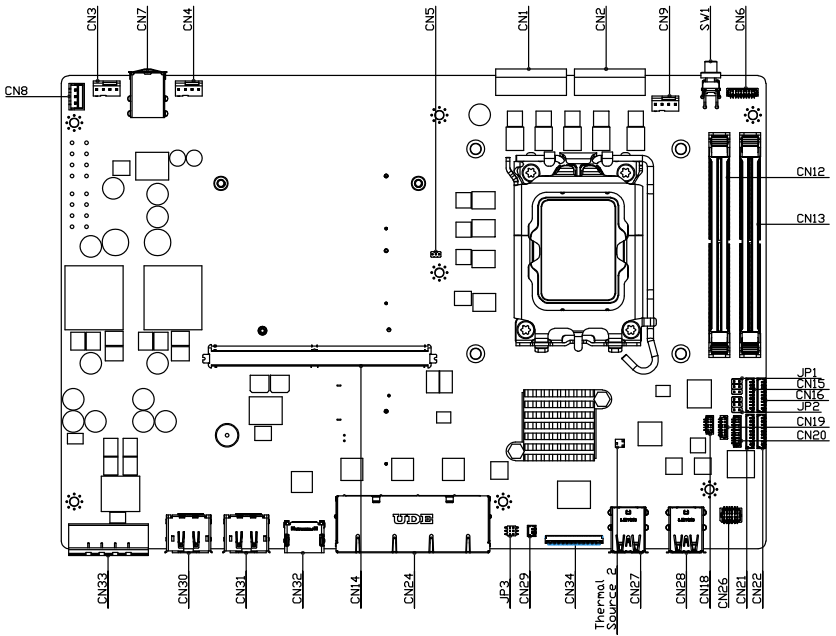

Bottom

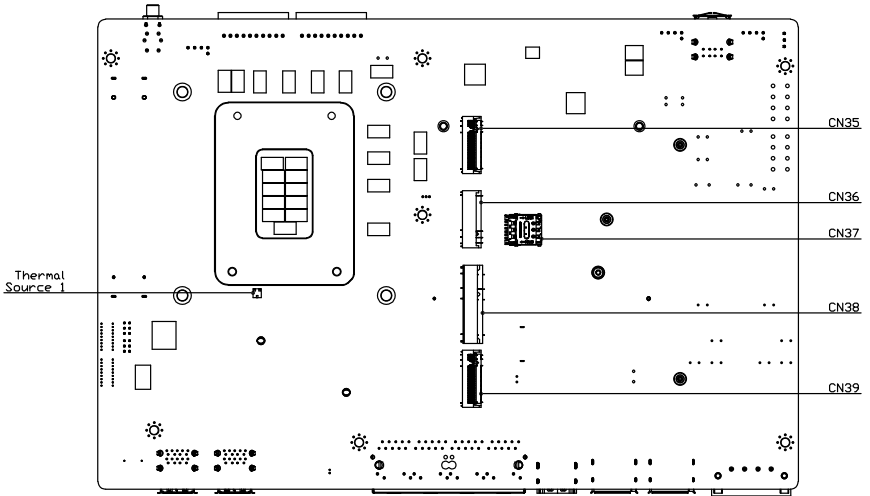

2.3 List of Jumpers

Please refer to the table below for all of the board's jumpers that you can configure for your application

Label	Function
JP1	COM 1 RI Jumper
JP2	COM 2 RI Jumper
JP3	Auto Power Button AT/ATX Selection Clear CMOS Jumper

2.3.1 COM 1 RI Jumper (JP1)

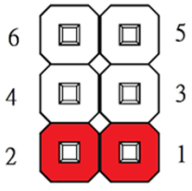
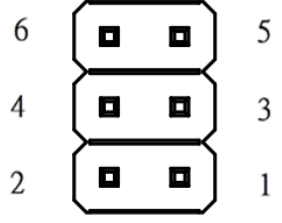
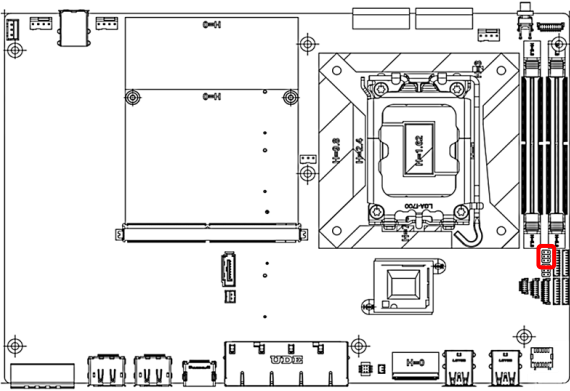

+12V

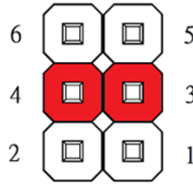

Ring (Default)

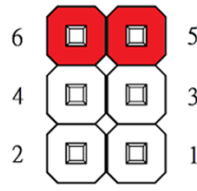

+5V

2.3.2 COM2 RI Jumper (JP2)

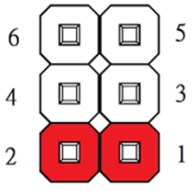
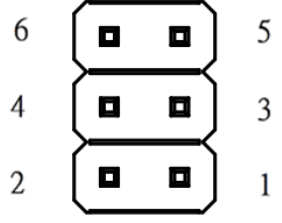
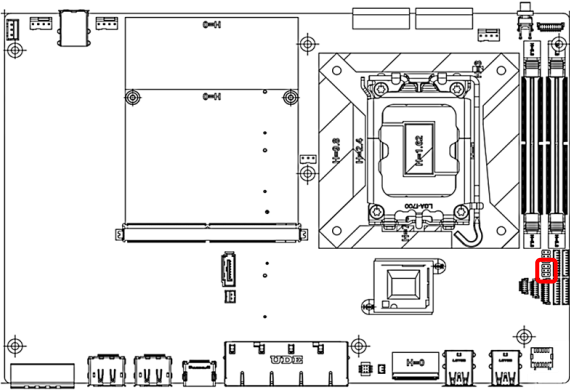

+12V

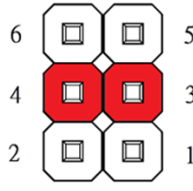

Ring (Default)

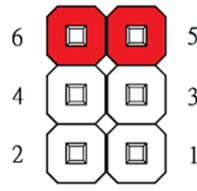

+5V

2.3.3 Auto Power Button AT/ATX Selection / Clear CMOS Jumper (JP3)

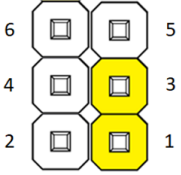
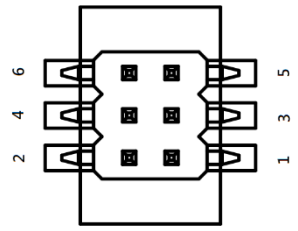
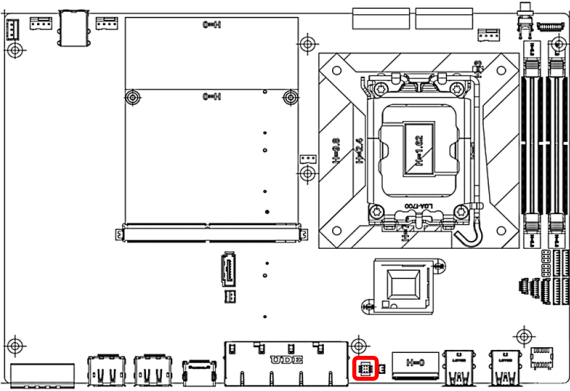

Disable Auto Power Button

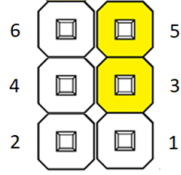

Enable Auto Power Button (Default)

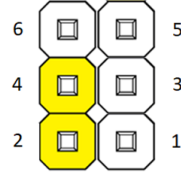

Normal (Default)

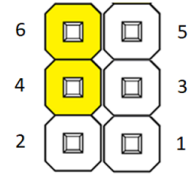

Clear CMOS

2.4 List of Connectors

Please refer to the table below for all of the board's connectors that you can configure for your application

Label	Function
CN1	GPIO Port (8~15) Connector
CN2	GPIO Port (0~7) Connector
CN3	4-Pin Fan Connector (90D) System
CN4	4-Pin Fan Connector (90D) MXM
CN5	IMVP9 FW Reflash
CN6	Front Panel (10Pin*1 Board to Wire)
CN7	USB 2.0 Port 5/Port 6
CN8	External +5VSB Input
CN9	4-Pin Fan Connector (90D) CPU
CN12	DDR5 SODIMM Slot
CN13	DDR5 SODIMM Slot
CN14	MXM Connector
CN15	COM Port 4 (9Pin*1 Board to Wire) RS-232
CN16	COM Port 3 (9Pin*1 Board to Wire) RS-232
CN18	SMBus / I2C Connector (With SMB_ALERT / INT_SERIRQ)
CN19	SPI Flash Programming Port (7Pin*1 Board to Wire)
CN20	Port 80 Debug Port (10Pin*1 Board to Wire)
CN21	COM Port 2 (9Pin*1 Board to Wire) RS-232/422/485
CN22	COM Port 1 (9Pin*1 Board to Wire) RS-232/422/485
CN24	Quad RJ-45 LAN Port
FPC LAN	Dual RJ-45 LAN Port
CN26	Audio Line In/Line Out/Mic
CN27	USB 3.2/USB 2.0 Port 3/Port 4
CN28	USB 3.2/USB 2.0 Port 1/Port 2
CN29	RTC Battery Connector
CN30	DP Port A
CN31	DP Port C
CN32	HDMI Port
CN33	Terminal Block DC Input Connector (19V~24V)
CN34	FPC Connector (PCIe [x1] x 4)
CN35	M.2 M-Key Slot (From CPU)
CN36	M.2 B-Key Slot
CN37	Nano SIM Card Slot

Label	Function
CN38	Full-size Mini Card Slot
CN39	M.2 M-Key Slot (From PCH)

2.4.1 GPIO Port (8~15) Connector (CN1)

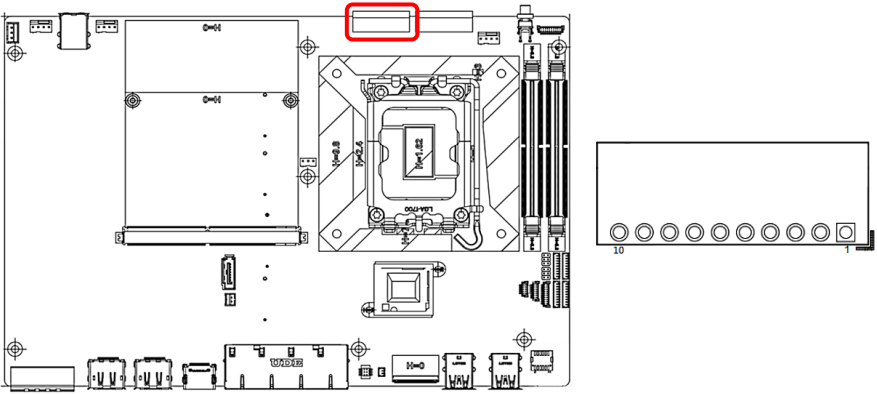

Pin	Pin Name	Signal Type	Signal Level
1	+V5S	PWR	+5V
2	GND	GND	GND
3	GPIO_8	IN/OUT	+5V
4	GPIO_9	IN/OUT	+5V
5	GPIO_10	IN/OUT	+5V
6	GPIO_11	IN/OUT	+5V
7	GPIO_12	IN/OUT	+5V
8	GPIO_13	IN/OUT	+5V
9	GPIO_14	IN/OUT	+5V
10	GPIO_15	IN/OUT	+5V

Note: The driving current of +V5S supports up to 0.5A.

2.4.2 GPIO Port (0~7) Connector (CN2)

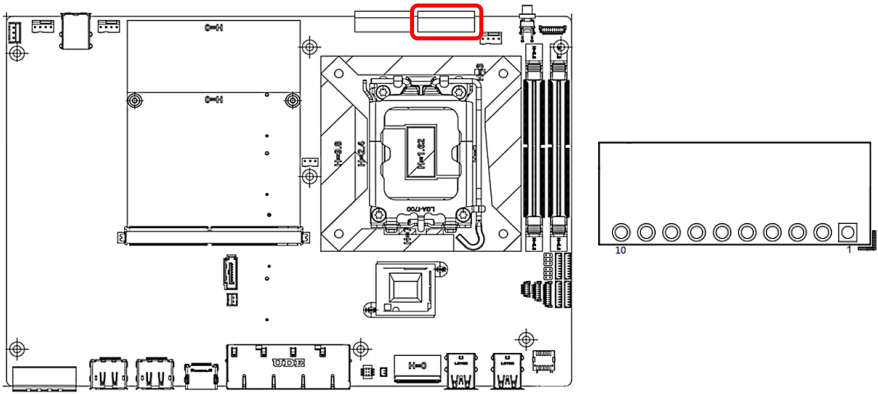

Pin	Pin Name	Signal Type	Signal Level
1	+V5S	PWR	+5V
2	GND	GND	GND
3	GPIO_0	IN/OUT	+5V
4	GPIO_1	IN/OUT	+5V
5	GPIO_12	IN/OUT	+5V
6	GPIO_3	IN/OUT	+5V
7	GPIO_4	IN/OUT	+5V
8	GPIO_5	IN/OUT	+5V
9	GPIO_6	IN/OUT	+5V
10	GPIO_7	IN/OUT	+5V

Note: The driving current of +V5S supports up to 0.5A.

2.4.3 4-Pin Fan Connector (90D) System (CN3)

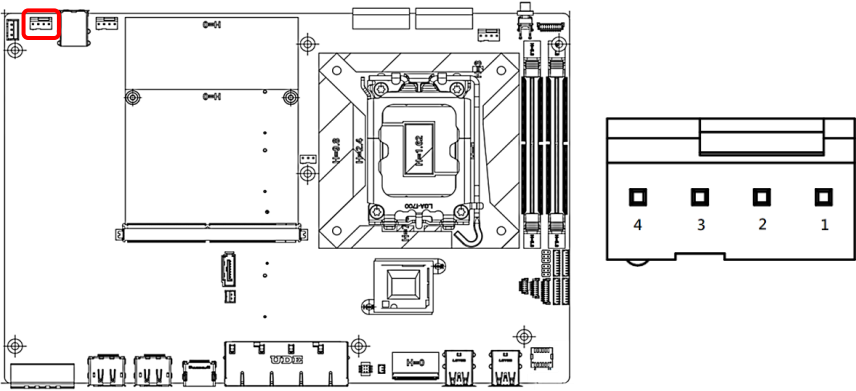

Pin	Pin Name	Signal Type	Signal Level
1	GND	GND	GND
2	FAN_POWER	PWR	+12V
3	FAN_TAC	IN	-
4	FAN_CTL	OUT	-

Note: The driving current of FAN_POWER supports up to 1A.

2.4.4 4-Pin Fan Connector (90D) MXM (CN4)

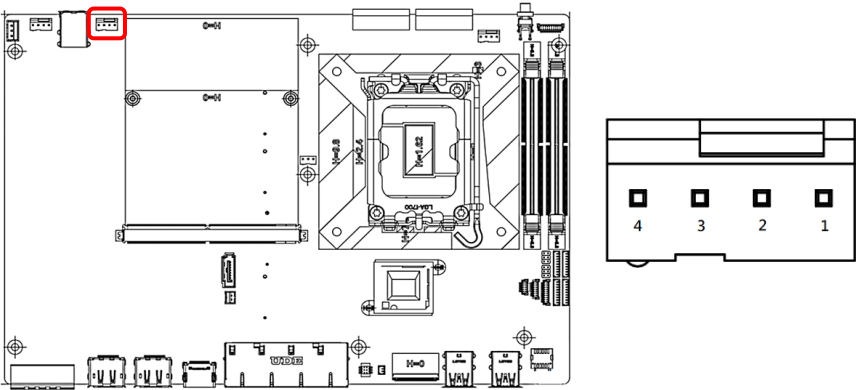

Pin	Pin Name	Signal Type	Signal Level
1	GND	GND	GND
2	FAN_POWER	PWR	+12V
3	FAN_TAC	IN	-
4	FAN_CTL	OUT	-

Note: The driving current of FAN_POWER supports up to 1A.

2.4.5 IMVP9 FW Reflash (CN5)

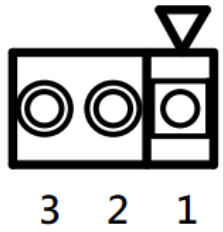
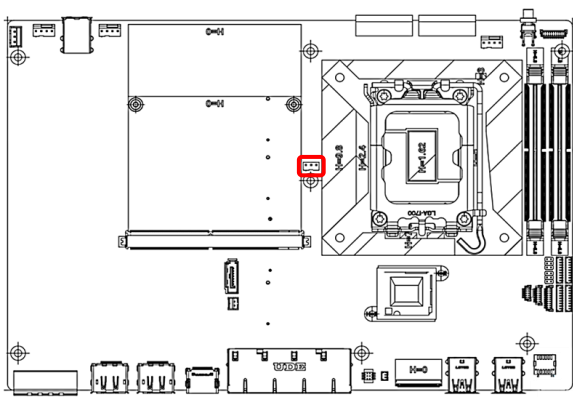

Pin	Pin Name	Signal Type	Signal Level
1	PM_SCL	I/O	+3.3V
2	PM_DAT	OUT	+3.3V
3	GND	GND	GND

2.4.6 Front Panel (10Pin*1 Board to Wire) (CN6)

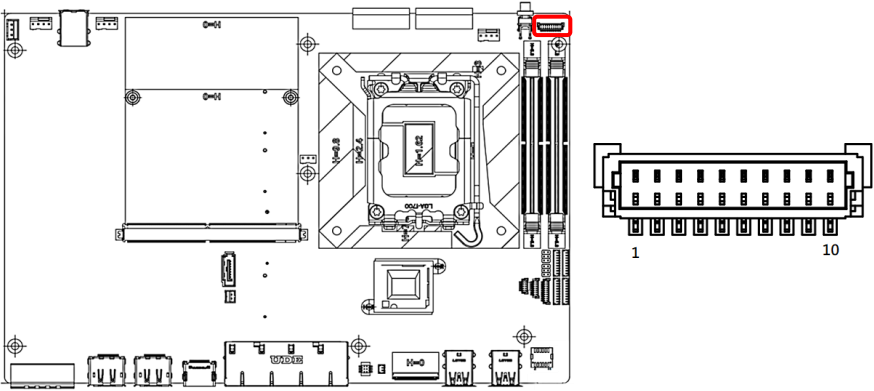

Pin	Pin Name	Signal Type	Signal Level
1	EXT_PWRBTN#	IN	-
2	GND	GND	GND
3	SATA_LED-	OUT	-
4	SATA_LED+	OUT	-
5	BUZZER-	OUT	-
6	BUZZER+	OUT	-
7	GND	GND	GND
8	PWR_LED+	OUT	-
9	GND	GND	GND
10	HWRST#	IN	-

2.4.7 USB 2.0 Port 5/Port 6 (CN7)

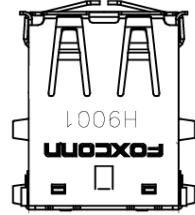
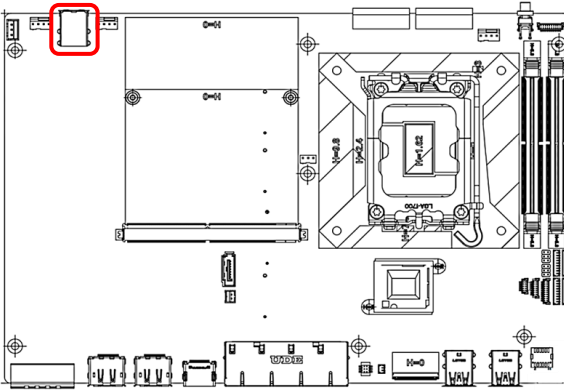

Pin	Pin Name	Signal Type	Signal Level
1	+5VSB	PWR	+5V
2	USB2_5_DN	DIFF	-
3	USB2_5_DP	DIFF	-
4	GND	GND	GND
5	+5VSB	PWR	+5V
6	USB2_6_DN	DIFF	-
7	USB2_6_DP	DIFF	-
8	GND	GND	GND

Note: The driving current of +5VSB supports up to 0.5A/Port.

2.4.8 External +5VSB Input (CN8)

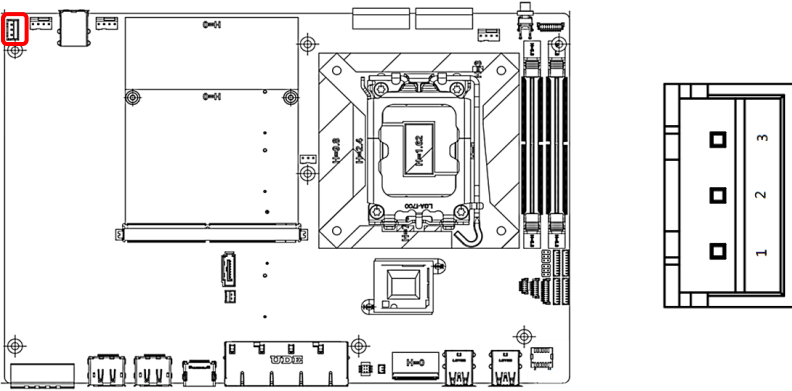

Pin	Pin Name	Signal Type	Signal Level
1	PS_ON#	OUT	+5V
2	GND	GND	GND
3	+5VSB	PWR	+5V

Note: The driving current of +5VSB supports up to 2A.

2.4.9 4-Pin Fan Connector (90D) CPU (CN9)

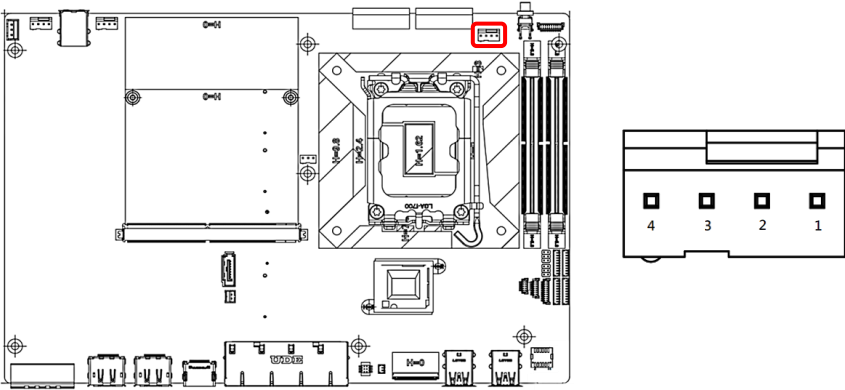

Pin	Pin Name	Signal Type	Signal Level
1	GND	GND	GND

Pin	Pin Name	Signal Type	Signal Level
2	FAN_POWER	PWR	+12V
3	FAN_TAC	IN	-
4	FAN_CTL	OUT	-

Note: The driving current of FAN_POWER supports up to 1A.

2.4.10 DDR5 SODIMM Slot (CN12)

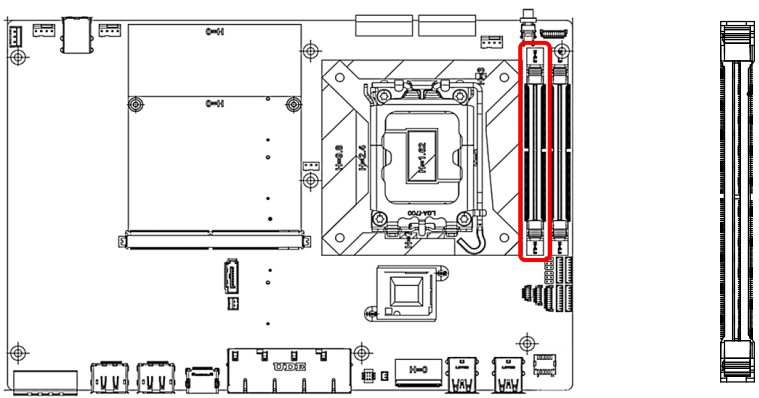

2.4.11 DDR5 SODIMM Slot (CN13)

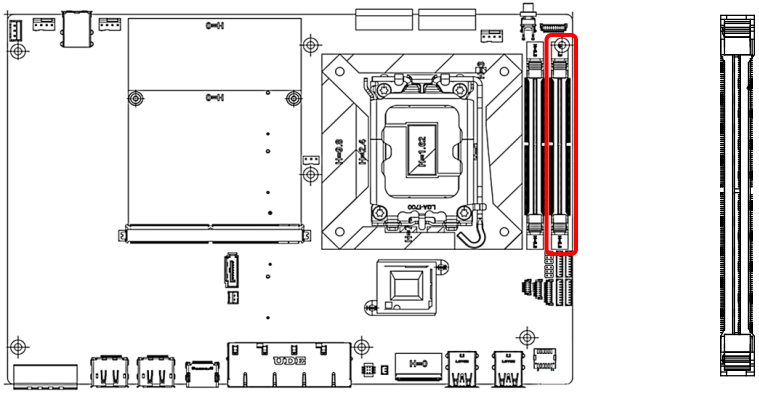

Standard specification.

2.4.12 MXM Connector (CN14)

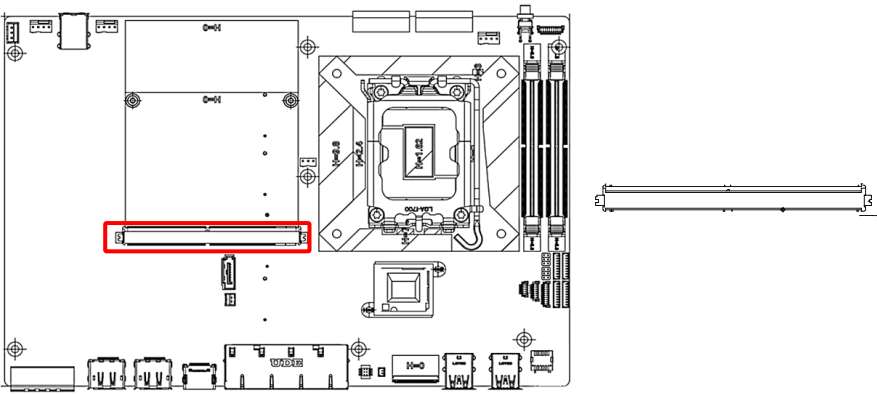

Standard specification.

2.4.13 COM Port 4 (9Pin*1 Board to Wire) RS-232 (CN15)

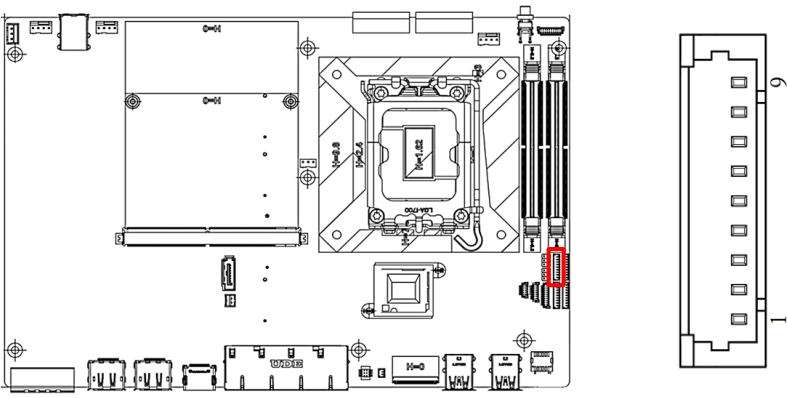

Pin	Pin Name	Signal Type	Signal Level
1	DCD4	IN	-
2	DSR4	IN	-
3	RX4	IN	-
4	RTS4	OUT	±9V
5	TX4	OUT	±9V

Pin	Pin Name	Signal Type	Signal Level
6	CTS4	IN	-
7	DTR4	OUT	±9V
8	RI4	IN	-
9	GND	GND	GND

2.4.14 COM Port 3 (9Pin*1 Board to Wire) RS-232 (CN16)

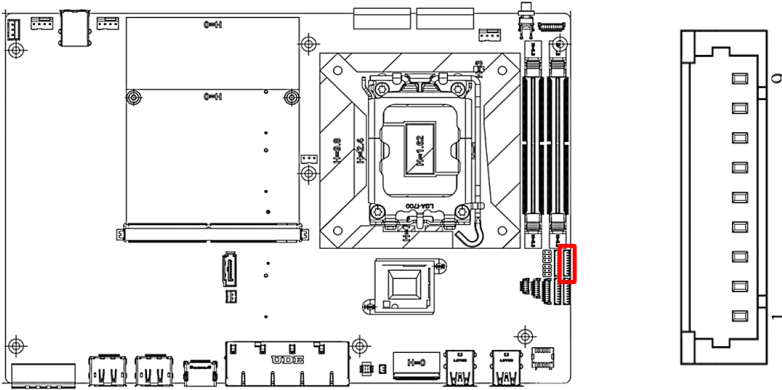

Pin	Pin Name	Signal Type	Signal Level
1	DCD3	IN	-
2	DSR3	IN	-
3	RX3	IN	-
4	RTS3	OUT	±9V
5	TX3	OUT	±9V
6	CTS3	IN	-
7	DTR3	OUT	±9V
8	RI3	IN	-
9	GND	GND	GND

2.4.15 SMBus / I2C Connector (CN18)

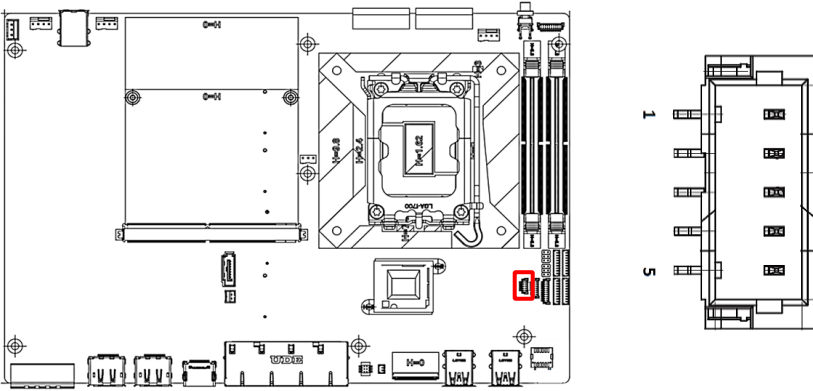

Pin	Pin Name	Signal Type	Signal Level
1	+V3P3S	PWR	+3.3V
2	SMB_CLK/ I2C_CLK/TIME_SYNC0	OUT	+3.3V
3	SMB_DAT/ I2C_DAT/TIME_SYNC1	IN/OUT	+3.3V
4	SMB_ALERT/ INT_SERIRQ/LAN_SDP	IN	+3.3V
5	GND	GND	GND

Note: Default function is SMBus.

2.4.16 SPI Flash Programming Port (7Pin*1 Board to Wire) (CN19)

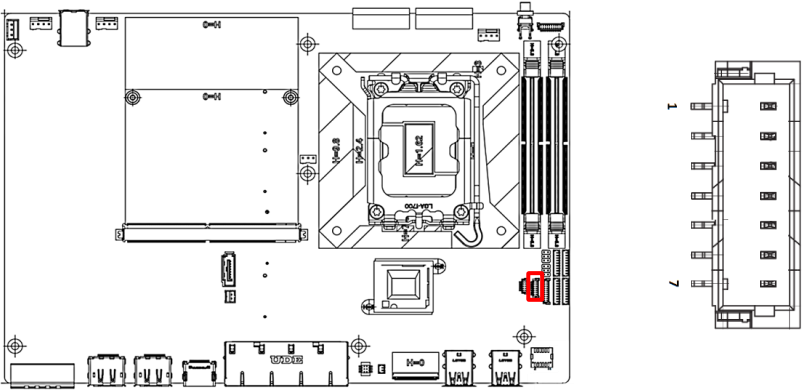

Pin	Pin Name	Signal Type	Signal Level
1	SPI_MISO	OUT	-
2	GND	GND	GND
3	SPI_CLK	IN	-
4	+V3P3A_SPI	PWR	+3.3V
5	SPI_MOSI	IN	-
6	SPI_CS	IN	-
7	NC	-	-

2.4.17 Port 80 Debug Port (10Pin*1 Board to Wire) (CN20)

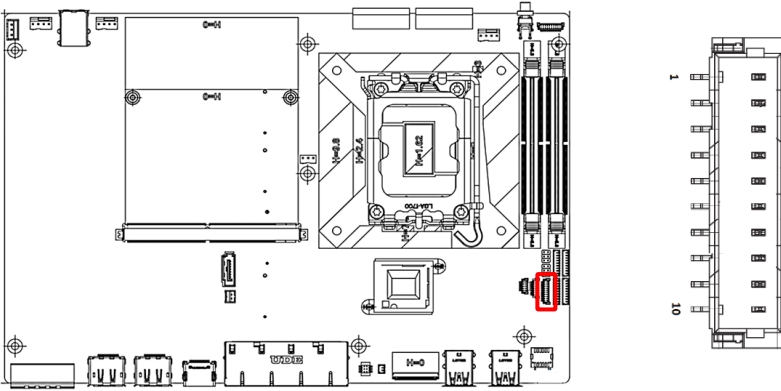

Pin	Pin Name	Signal Type	Signal Level
1	ESPI_IO0_EC_R	IN/OUT	+1.8V
2	ESPI_IO1_EC_R	IN/OUT	+1.8V
3	ESPI_IO2_EC_R	IN/OUT	+1.8V
4	ESPI_IO3_EC_R	IN/OUT	+1.8V
5	+V3P3S	PWR	+3.3V
6	ESPI_CS_EC_R_N	OUT	+1.8V
7	ESPI_RST_EC_R_N	OUT	+1.8V
8	GND	GND	GND
9	ESPI_CLK_EC_R	OUT	+1.8V
10	+V3P3A	PWR	+3.3V

2.4.18 COM Port 2 (9Pin*1 Board to Wire) RS-232/422/485 (CN21)

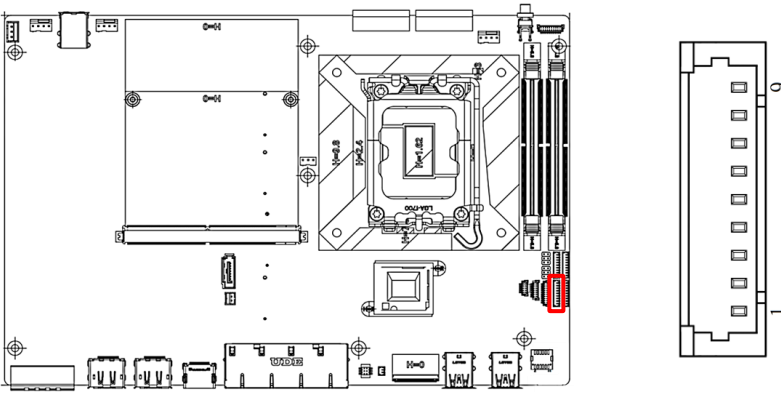

RS-232 (Default)			
Pin	Pin Name	Signal Type	Signal Level
1	DCD2	IN	-
2	DSR2	IN	-
3	RX2	IN	-
4	RTS2	OUT	±9V
5	TX2	OUT	±9V
6	CTS2	IN	-
7	DTR2	OUT	±9V
8	RI2/ +5V/ +12V	IN/ PWR	+5V/+12V
9	GND	GND	GND

RS-422			
Pin	Pin Name	Signal Type	Signal Level
1	RS422_TX-	OUT	±9V
2	NC	-	-
3	RS422_TX+	OUT	±9V
4	NC	-	-
5	RS422_RX+	IN	-
6	NC	-	-
7	RS422_RX-	IN	-
8	NC	-	-
9	GND	GND	GND

RS-485

Pin	Pin Name	Signal Type	Signal Level
1	RS485_D-	IN/OUT	±9V
2	NC	-	-
3	RS485_D+	IN/OUT	±9V
4	NC	-	-
5	NC	-	-
6	NC	-	-
7	NC	-	-
8	NC	-	-
9	GND	GND	GND

Note: COM 2 RS-232/422/485 can be set by BIOS setting. Default is RS-232.

Note: Pin 8 function can be set by JP2.

2.4.19 COM Port 1 (9Pin*1 Board to Wire) RS-232/422/485 (CN22)

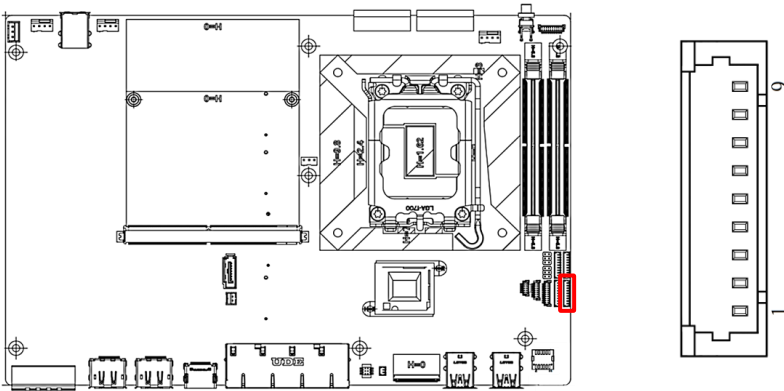

RS-232 (Default)

Pin	Pin Name	Signal Type	Signal Level
1	DCD1	IN	-
2	DSR1	IN	-
3	RX1	IN	-
4	RTS1	OUT	±9V
5	TX1	OUT	±9V
6	CTS1	IN	-
7	DTR1	OUT	±9V
8	RI1/ +5V/ +12V	IN/ PWR	+5V/+12V

RS-232 (Default)			
Pin	Pin Name	Signal Type	Signal Level
9	GND	GND	GND

RS-422			
Pin	Pin Name	Signal Type	Signal Level
1	RS422_TX-	OUT	±9V
2	NC	-	-
3	RS422_TX+	OUT	±9V
4	NC	-	-
5	RS422_RX+	IN	-
6	NC	-	-
7	RS422_RX-	IN	-
8	NC	-	-
9	GND	GND	GND

RS-485			
Pin	Pin Name	Signal Type	Signal Level
1	RS485_D-	IN/OUT	±9V
2	NC	-	-
3	RS485_D+	IN/OUT	±9V
4	NC	-	-
5	NC	-	-
6	NC	-	-
7	NC	-	-
8	NC	-	-
9	GND	GND	GND

Note: COM 1 RS-232/422/485 can be set by BIOS setting. Default is RS-232.

Note: Pin 8 function can be set by JP1.

2.4.20 Quad RJ-45 LAN Port (CN24)

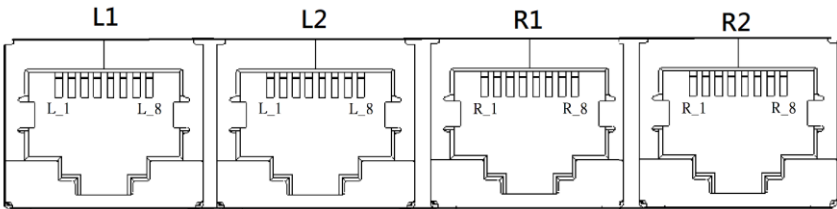
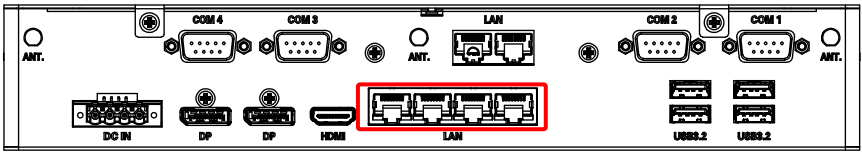
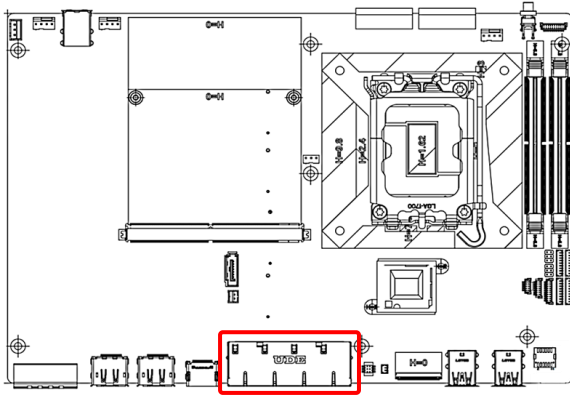

L1, L2, R1: Intel® Ethernet Controller I226-V.

R2: Intel® Ethernet Connection I219-LM.

Pin	Pin Name	Signal Type	Signal Level
L1_1	LAN4_MDIO_P	DIFF	-
L1_2	LAN4_MDIO_N	DIFF	-
L1_3	LAN4_MDI1_P	DIFF	-
L1_4	LAN4_MDI1_N	DIFF	-
L1_5	LAN4_MDI2_P	DIFF	-
L1_6	LAN4_MDI2_N	DIFF	-
L1_7	LAN4_MDI3_P	DIFF	-

Pin	Pin Name	Signal Type	Signal Level
L1_8	LAN4_MDI3_N	DIFF	-
L2_1	LAN3_MDI0_P	DIFF	-
L2_2	LAN3_MDI0_N	DIFF	-
L2_3	LAN3_MDI1_P	DIFF	-
L2_4	LAN3_MDI1_N	DIFF	-
L2_5	LAN3_MDI2_P	DIFF	-
L2_6	LAN3_MDI2_N	DIFF	-
L2_7	LAN3_MDI3_P	DIFF	-
L2_8	LAN3_MDI3_N	DIFF	-
R1_1	LAN2_MDI0_P	DIFF	-
R1_2	LAN2_MDI0_N	DIFF	-
R1_3	LAN2_MDI1_P	DIFF	-
R1_4	LAN2_MDI1_N	DIFF	-
R1_5	LAN2_MDI2_P	DIFF	-
R1_6	LAN2_MDI2_N	DIFF	-
R1_7	LAN2_MDI3_P	DIFF	-
R1_8	LAN2_MDI3_N	DIFF	-
R2_1	LAN1_MDI0_P	DIFF	-
R2_2	LAN1_MDI0_N	DIFF	-
R2_3	LAN1_MDI1_P	DIFF	-
R2_4	LAN1_MDI1_N	DIFF	-
R2_5	LAN1_MDI2_P	DIFF	-
R2_6	LAN1_MDI2_N	DIFF	-
R2_7	LAN1_MDI3_P	DIFF	-
R2_8	LAN1_MDI3_N	DIFF	-

2.4.21 Dual RJ-45 LAN Port (FPC LAN)

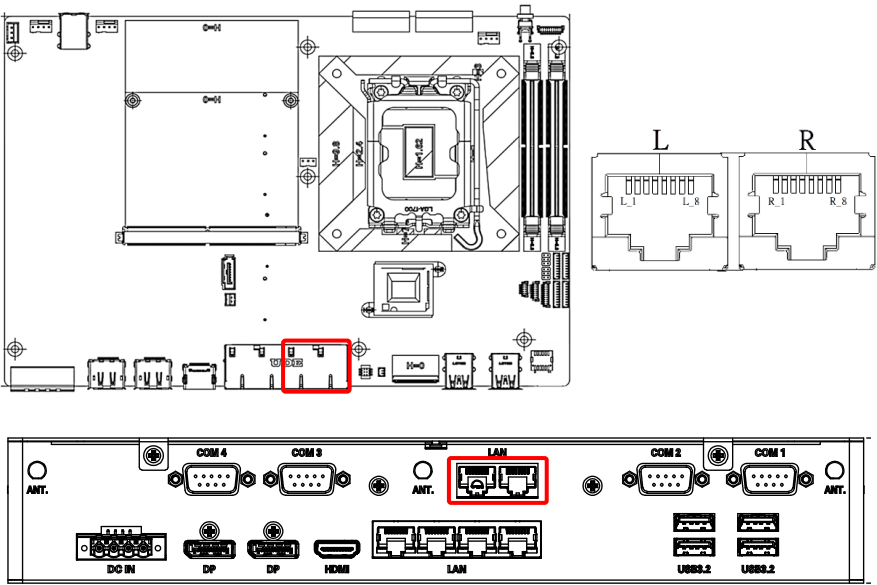

L: Intel® Ethernet Controller I226-LM.
 R: Intel® Ethernet Controller I226-LM.

Pin	Pin Name	Signal Type	Signal Level
L_1	LAN2_MDIO_P	DIFF	-
L_2	LAN2_MDIO_N	DIFF	-
L_3	LAN2_MDIO1_P	DIFF	-
L_4	LAN2_MDIO1_N	DIFF	-
L_5	LAN2_MDIO2_P	DIFF	-
L_6	LAN2_MDIO2_N	DIFF	-
L_7	LAN2_MDIO3_P	DIFF	-
L_8	LAN2_MDIO3_N	DIFF	-
R_1	LAN1_MDIO_P	DIFF	-
R_2	LAN1_MDIO_N	DIFF	-
R_3	LAN1_MDIO1_P	DIFF	-
R_4	LAN1_MDIO1_N	DIFF	-
R_5	LAN1_MDIO2_P	DIFF	-
R_6	LAN1_MDIO2_N	DIFF	-
R_7	LAN1_MDIO3_P	DIFF	-

Pin	Pin Name	Signal Type	Signal Level
R_8	LAN1_MD13_N	DIFF	-

2.4.22 Audio Line In/Line Out/Mic (CN26)

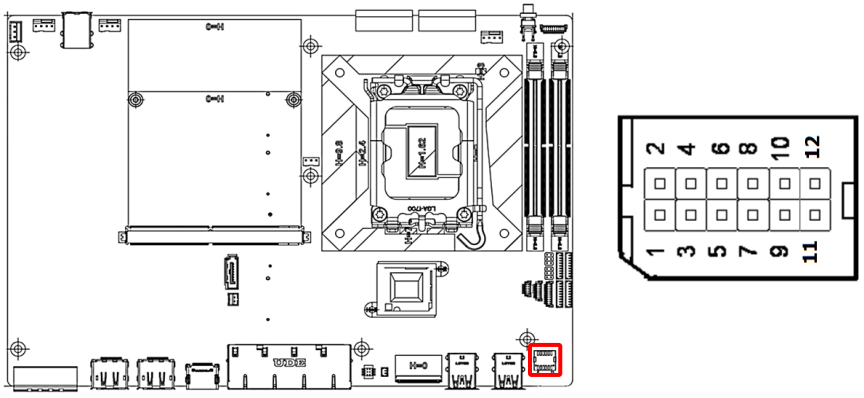

Pin	Pin Name	Signal Type	Signal Level
1	FRONT_R	OUT	-
2	MIC_R	IN	-
3	FRONT_L	OUT	-
4	MIC_L	IN	-
5	FRONT_JD	IN	-
6	MIC_JD	IN	-
7	GND	GND	GND
8	GND	GND	GND
9	LINE_JD	IN	-
10	LINE_R	IN	-
11	+V5A_AUD	PWR	PWR
12	LINE_L	IN	-

2.4.23 USB 3.2/USB 2.0 Port 3/Port 4 (CN27)

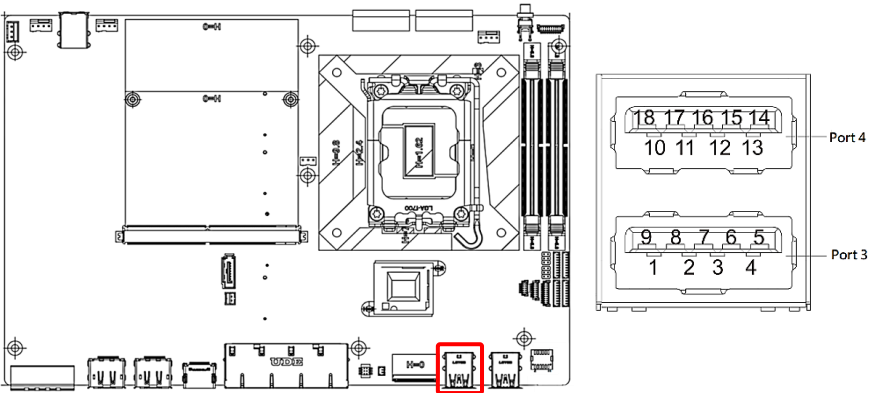

Pin	Pin Name	Signal Type	Signal Level
1	+5VSB	PWR	+5V
2	USB2_3_DN	DIFF	-
3	USB2_3_DP	DIFF	-
4	GND	GND	GND
5	USB3_3_RXN	DIFF	-
6	USB3_3_RXP	DIFF	-
7	GND	GND	GND
8	USB3_3_TXN	DIFF	-
9	USB3_3_TXP	DIFF	-
10	+5VSB	PWR	+5V
11	USB2_4_DN	DIFF	-
12	USB2_4_DP	DIFF	-
13	GND	GND	GND
14	USB3_4_RXN	DIFF	-
15	USB3_4_RXP	DIFF	-
16	GND	GND	GND
17	USB3_4_TXN	DIFF	-
18	USB3_4_TXP	DIFF	-

Note: The driving current of +5VSB supports up to 0.9A/Port.

2.4.24 USB 3.2/USB 2.0 Port 1/Port 2 (CN28)

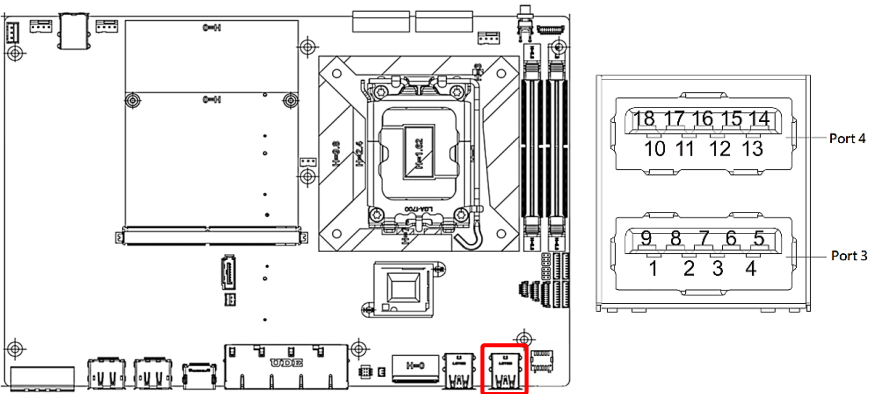

Pin	Pin Name	Signal Type	Signal Level
1	+5VSB	PWR	+5V
2	USB2_1_DN	DIFF	-
3	USB2_1_DP	DIFF	-
4	GND	GND	GND
5	USB3_1_RXN	DIFF	-
6	USB3_1_RXP	DIFF	-
7	GND	GND	GND
8	USB3_1_TXN	DIFF	-
9	USB3_1_TXP	DIFF	-
10	+5VSB	PWR	+5V
11	USB2_2_DN	DIFF	-
12	USB2_2_DP	DIFF	-
13	GND	GND	GND
14	USB3_2_RXN	DIFF	-
15	USB3_2_RXP	DIFF	-
16	GND	GND	GND
17	USB3_2_TXN	DIFF	-
18	USB3_2_TXP	DIFF	-

Note: The driving current of +5VSB supports up to 0.9A/Port.

2.4.25 RTC Battery Connector (CN29)

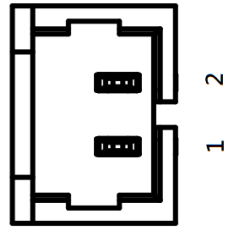
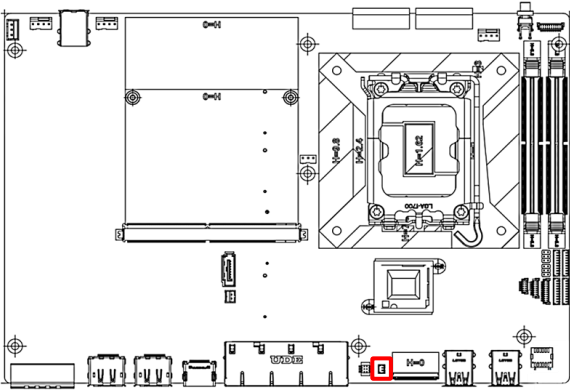

Pin	Pin Name	Signal Type	Signal Level
1	+3.3V	PWR	+3.3V
2	GND	GND	GND

2.4.26 DP Port A (CN30)

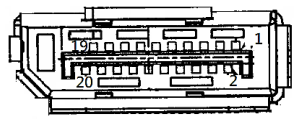
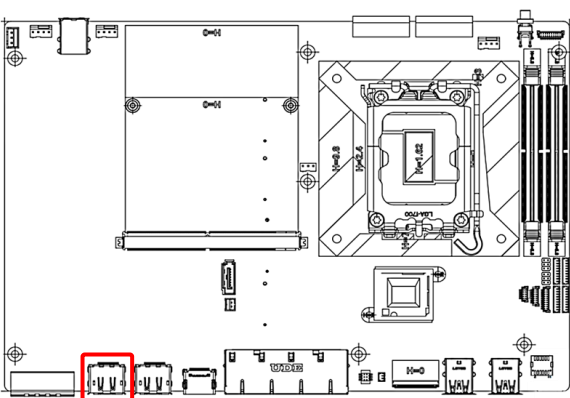

Pin	Pin Name	Signal Type	Signal Level
1	LANE0P	DIFF	-
2	GND	GND	GND
3	LANE0N	DIFF	-
4	LANE1P	DIFF	-

Pin	Pin Name	Signal Type	Signal Level
5	GND	GND	GND
6	LANE1N	DIFF	-
7	LANE2P	DIFF	-
8	GND	GND	GND
9	LANE2N	DIFF	-
10	LANE3P	DIFF	-
11	GND	GND	GND
12	LANE3N	DIFF	-
13	CAB_DET_N	IN	-
14	GND	GND	GND
15	AUXP	DIFF	-
16	GND	GND	GND
17	AUXN	DIFF	-
18	HPD	IN	-
19	GND	GND	GND
20	+V3P3S	PWR	+3.3V

2.4.27 DP Port C (CN31)

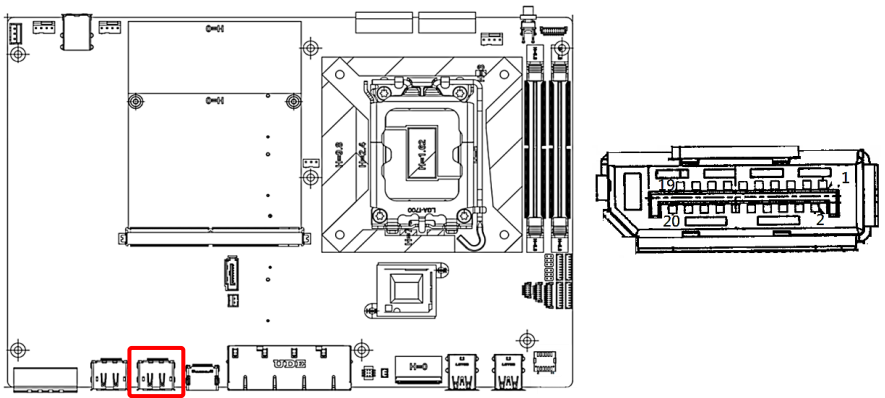

Pin	Pin Name	Signal Type	Signal Level
1	LANE0P	DIFF	-
2	GND	GND	GND
3	LANE0N	DIFF	-
4	LANE1P	DIFF	-
5	GND	GND	GND

Pin	Pin Name	Signal Type	Signal Level
6	LANE1N	DIFF	-
7	LANE2P	DIFF	-
8	GND	GND	GND
9	LANE2N	DIFF	-
10	LANE3P	DIFF	-
11	GND	GND	GND
12	LANE3N	DIFF	-
13	CAB_DET_N	IN	-
14	GND	GND	GND
15	AUXP	DIFF	-
16	GND	GND	GND
17	AUXN	DIFF	-
18	HPD	IN	-
19	GND	GND	GND
20	+V3P3S	PWR	+3.3V

2.4.28 HDMI Port (CN32)

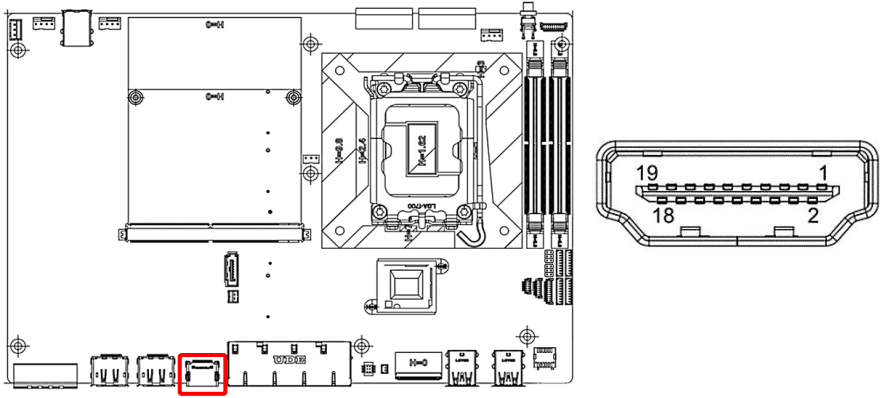

Pin	Pin Name	Signal Type	Signal Level
1	HDMI_TX2+	DIFF	-
2	GND	GND	GND
3	HDMI_TX2-	DIFF	-
4	HDMI_TX1+	DIFF	-
5	GND	GND	GND
6	HDMI_TX1-	DIFF	-

Pin	Pin Name	Signal Type	Signal Level
7	HDMI_TX0+	DIFF	-
8	GND	GND	GND
9	HDMI_TX0-	DIFF	-
10	HDMI_CLK+	DIFF	-
11	GND	GND	GND
12	HDMI_CLK-	DIFF	-
13	N/A	N/A	N/A
14	N/A	N/A	N/A
15	DDC_CLK	IN/OUT	-
16	DDC_DATA	IN/OUT	-
17	GND	GND	GND
18	+V5S	PWR	+5V
19	HDMI_HPD	IN	-

2.4.29 Terminal Block DC Input Connector (19V – 24V) (CN33)

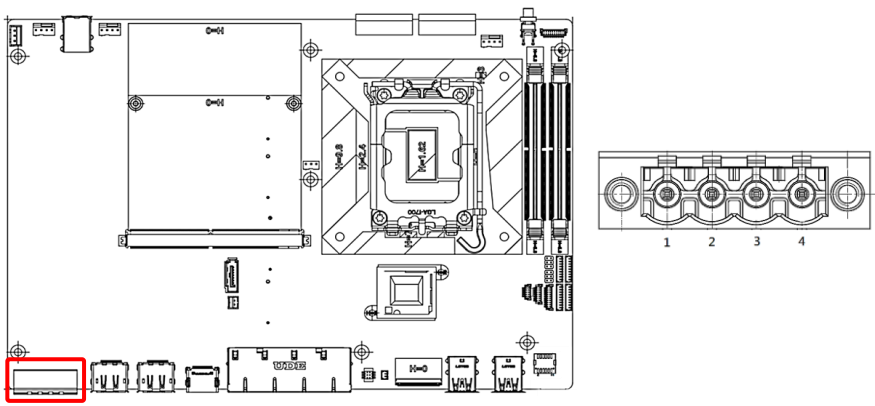

Pin	Pin Name	Signal Type	Signal Level
1	+VIN	PWR	+19V/24V
2	+VIN	PWR	+19V/24V
4	GND	GND	GND
4	GND	GND	GND

2.4.30 FPC Connector (PCIe [x1] x 4) (CN34)

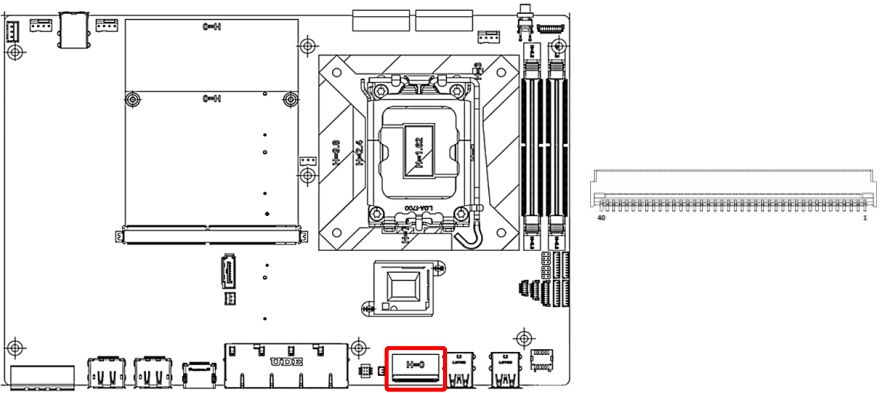

Pin	Pin Name	Signal Type	Signal Level
1	+V12S	PWR	+12V
2	+V12S	PWR	+12V
3	+V12S	PWR	+12V
4	+V12S	PWR	+12V
5	+V12S	PWR	+12V
6	GND	GND	GND
7	PCIE1_TXP	DIFF	-
8	PCIE1_TXN	DIFF	-
9	GND	GND	GND
10	PCIE_REF_CLK+	DIFF	-
11	PCIE_REF_CLK-	DIFF	-
12	GND	GND	GND
13	PCIE2_TXP	DIFF	-
14	PCIE2_TXN	DIFF	-
15	GND	GND	GND
16	PCIE3_TXP	DIFF	-
17	PCIE3_TXN	DIFF	-
18	GND	GND	GND
19	PCIE4_TXP	DIFF	-
20	PCIE4_TXN	DIFF	-
21	GND	GND	GND
22	PCIE1_RXN	DIFF	-
23	PCIE1_RXP	DIFF	-
24	GND	GND	GND

Pin	Pin Name	Signal Type	Signal Level
25	PCIE2_RXN	DIFF	-
26	PCIE2_RXP	DIFF	-
27	GND	GND	GND
28	PCIE3_RXN	DIFF	-
29	PCIE3_RXP	DIFF	-
30	GND	GND	GND
31	PCIE4_RXN	DIFF	-
32	PCIE4_RXP	DIFF	-
33	GND	GND	GND
34	+V3P3A	PWR	+3.3V
35	PLT_RESET#	OUT	+3.3V
36	SMB_CLK	IN/OUT	+3.3V
37	SMB_DATA	IN/OUT	+3.3V
38	+V3P3S	PWR	+3.3V -
39	+V3P3S	PWR	+3.3V
40	+V3P3S	PWR	+3.3V

2.4.31 M.2 M-Key Slot (From CPU) (CN35)

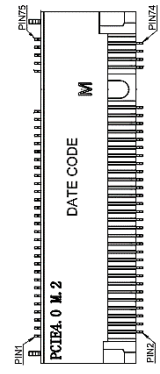
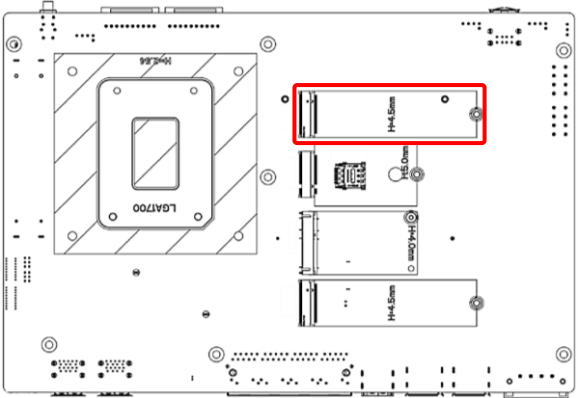

Pin	Pin Name	Signal Type	Signal Level
1	GND	GND	GND
2	+V3P3S	PWR	+3.3V
3	GND	GND	GND
4	+V3P3S	PWR	+3.3V
5	PCIE3_RXN	DIFF	-

Pin	Pin Name	Signal Type	Signal Level
6	NC	-	-
7	PCIE3_RXP	DIFF	-
8	NC	-	-
9	GND	GND	GND
10	PCH_SATA_LED_N	OUT	+3.3V
11	PCIE3_TXN	DIFF	-
12	+V3P3S	PWR	+3.3V
13	PCIE3_TXN	DIFF	-
14	+V3P3S	PWR	+3.3V
15	GND	GND	GND
16	+V3P3S	PWR	+3.3V
17	PCIE2_RXN	DIFF	-
18	+V3P3S	PWR	+3.3V
19	PCIE2_RXP	DIFF	-
20	NC	-	-
21	GND	GND	GND
22	NC	-	-
23	PCIE2_TXN	DIFF	-
24	NC	-	-
25	PCIE2_TXN	DIFF	-
26	NC	-	-
27	GND	GND	GND
28	NC	-	-
29	PCIE1_RXN	DIFF	-
30	NC	-	-
31	PCIE1_RXP	DIFF	-
32	NC	-	-
33	GND	GND	GND
34	NC	-	-
35	PCIE1_TXN	DIFF	-
36	NC	-	-
37	PCIE1_TXP	DIFF	-
38	DEVSLP	OUT	-
39	GND	GND	GND
40	SMB_CLK	IN/OUT	+1.8V
41	PCIE_3_RXN	DIFF	-
42	SMB_DATA	IN/OUT	+1.8V
43	PCIE_3_RXP	DIFF	-
44	SMB_ALERT_N	OUT	+1.8V

Pin	Pin Name	Signal Type	Signal Level
45	GND	GND	GND
46	NC	-	-
47	PCIE0_TXN	DIFF	-
48	NC	-	-
49	PCIE0_TXP	DIFF	-
50	BUF_PLT_RST#	OUT	
51	GND	GND	GND
52	M2B_CLKREQ#	IN	-
53	PCIE_M1_CLK_DN	DIFF	-
54	KEYB_WAKE_N	IN	-
55	PCIE_M1_CLK_DN	DIFF	-
56	NC	-	-
57	GND	GND	GND
58	NC	-	-
59	NC	-	-
60	NC	-	-
61	NC	-	-
62	NC	-	-
63	NC	-	-
64	NC	-	-
65	NC	-	-
66	NC	-	-
67	NC	-	-
68	PCH_SUS_CLK	IN	-
69	NC	-	-
70	+V3P3S	PWR	+3.3V
71	GND	GND	GND
72	+V3P3S	PWR	+3.3V
73	GND	GND	GND
74	+V3P3S	PWR	+3.3V
75	NC	-	-

2.4.32 M.2 B-Key Slot (CN36)

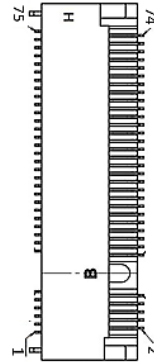
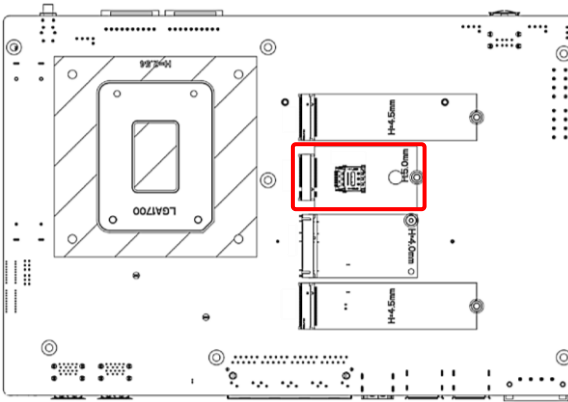

Pin	Pin Name	Signal Type	Signal Level
1	NC		
2	+V3P3S	PWR	+3.3V
3	GND	GND	GND
4	+V3P3S	PWR	+3.3V
5	GND	GND	GND
6	NC		
7	USB2_2_DP	DIFF	-
8	KEYB_DISABLE_N	IN	
9	USB2_2_DN	DIFF	-
10	PCH_SATA_LED_N	OUT	+3.3V
11	GND	GND	GND
20	NC	-	-
21	NC	-	-
22	NC	-	-
23	NC	-	-
24	NC	-	-
25	NC	-	-
26	NC	-	-
27	GND	GND	GND
28	NC	-	-
29	PCIE_4_RXN/ USB3_2_RXN	DIFF	-
30	UIM_RST_M2B	OUT	-

Pin	Pin Name	Signal Type	Signal Level
31	PCIE4_1_RXP/ USB3_2_RXP	DIFF	-
32	UIM_CLK_M2B	-	-
33	GND	GND	GND
34	UIM_DAT_M2B	IN/OUT	-
35	PCIE4_TXN/ USB3_2_TXN	DIFF	-
36	UIM_PWR	PWR	-
37	PCIE4_TXP/ USB3_2_TXP	DIFF	-
38	NC	-	-
39	GND	GND	GND
40	NC	-	-
41	PCIE_3_RXN	DIFF	-
42	NC	-	-
43	PCIE_3_RXP	DIFF	-
44	NC	-	-
45	GND	GND	GND
46	NC	-	-
47	PCIE_3_TXN	DIFF	-
48	NC	-	-
49	PCIE_3_TXP	DIFF	-
50	BUF_PLT_RST#	OUT	-
51	GND	GND	GND
52	M2B_CLKREQ#	IN	-
53	PCIE_4_CLK_DN	DIFF	-
54	KEYB_WAKE_N	IN	-
55	PCIE_4_CLK_DN	DIFF	-
56	NC	-	-
57	GND	GND	GND
58	NC	-	-
59	NC	-	-
60	NC	-	-
61	NC	-	-
62	NC	-	-
63	NC	-	-
64	NC	-	-
65	NC	-	-
66	SIM_Detect	IN	-

Pin	Pin Name	Signal Type	Signal Level
67	KEYB_WWAN_RST_N	OUT	-
68	PCH_SUS_CLK	IN	-
69	NC	-	-
70	+V3P3A	PWR	+3.3V
71	GND	GND	GND
72	+V3P3A	PWR	+3.3V
73	GND	GND	GND
74	+V3P3A	PWR	+3.3V
75	NC	-	-

2.4.33 Nano SIM Card Slot (CN37)

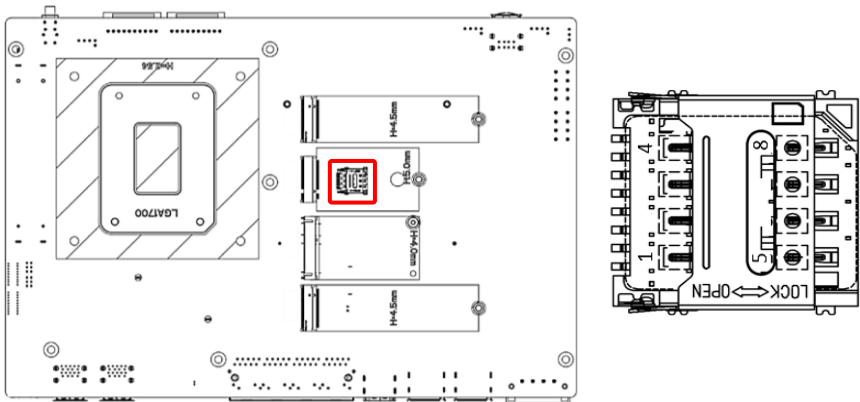

Pin	Pin Name	Signal Type	Signal Level
1	UIM_PWR	PWR	-
2	UIM_RST	IN	-
3	UIM_CLK	IN	-
4	N/A	N/A	-
5	GND	GND	GND
6	UIM_VPP	PWR	-
7	UIM_DATA	IN/OUT	-
8	N/A	N/A	-

2.4.34 Full-size Mini Card Slot (CN38)

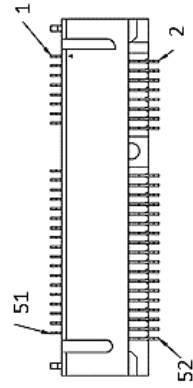
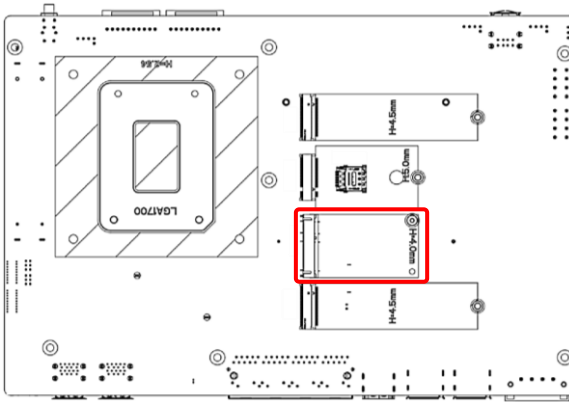

Pin	Pin Name	Signal Type	Signal Level
1	PCIE_WAKE#	IN	-
2	+3.3V	PWR	+3.3V
3	NC	NC	NC
4	GND	GND	GND
5	NC	NC	NC
6	+1.5V	PWR	+1.5V
7	PCIE_CLK_REQ#	IN	-
8	NC	NC	NC
9	GND	GND	GND
10	NC	NC	NC
11	PCIE_REF_CLK-	DIFF	-
12	NC	NC	NC
13	PCIE_REF_CLK+	DIFF	-
14	NC	NC	NC
15	GND	GND	GND
16	NC	NC	NC
17	NC	NC	NC
18	GND	GND	GND
19	NC	NC	NC
20	W_DISABLE#	OUT	+3.3V
21	GND	GND	GND
22	PCIE_RST3	OUT	+3.3V
23	PCIE_RX-	DIFF	GND
24	+3.3V	PWR	+3.3V

Pin	Pin Name	Signal Type	Signal Level
25	PCIE_RX	DIFF	-
26	GND	GND	GND
27	GND	GND	GND
28	+1.5V	PWR	+1.5V
29	GND	GND	GND
30	SMB_CLK	IN/OUT	+3.3V
31	PCIE_TX-	DIFF	-
32	SMB_DATA	IN/OUT	+3.3V
33	PCIE_TX+/S	DIFF	-
34	GND	GND	GND
35	GND	GND	GND
36	USB_D-	DIFF	-
37	GND	GND	GND
38	USB_D+	DIFF	-
39	+3.3V	PWR	+3.3V
40	GND	GND	GND
41	+3.3V	PWR	+3.3V
42	NC	NC	NC
43	GND	GND	GND
44	NC	NC	NC
45	NC	NC	NC
46	NC	NC	NC
47	NC	NC	NC
48	+1.5V	PWR	+1.5V
49	NC	NC	NC
50	GND	GND	GND
51	NC	NC	NC
52	+3.3V	PWR	+3.3V

2.4.35 M.2 M-Key Slot (From PCH) (CN39)

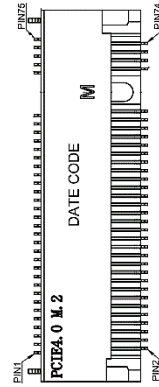
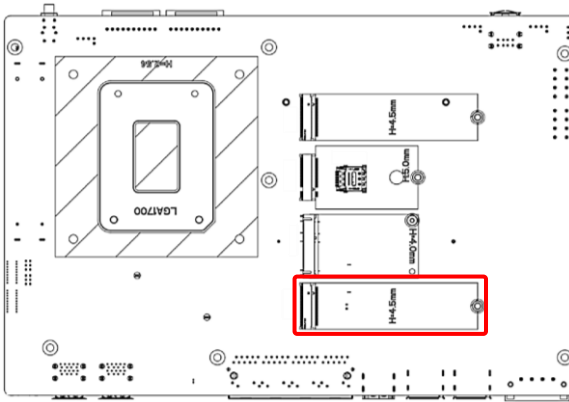

Pin	Pin Name	Signal Type	Signal Level
1	GND	GND	GND
2	+V3P3S	PWR	+3.3V
3	GND	GND	GND
4	+V3P3S	PWR	+3.3V
5	PCIE3_RXN	DIFF	-
6	NC	-	-
7	PCIE3_RXP	DIFF	-
8	NC	-	-
9	GND	GND	GND
10	PCH_SATA_LED_N	OUT	+3.3V
11	PCIE3_TXN	DIFF	-
12	+V3P3S	PWR	+3.3V
13	PCIE3_TXN	DIFF	-
14	+V3P3S	PWR	+3.3V
15	GND	GND	GND
16	+V3P3S	PWR	+3.3V
17	PCIE2_RXN	DIFF	-
18	+V3P3S	PWR	+3.3V
19	PCIE2_RXP	DIFF	-
20	NC	-	-
21	GND	GND	GND
22	NC	-	-
23	PCIE2_TXN	DIFF	-
24	NC	-	-

Pin	Pin Name	Signal Type	Signal Level
25	PCIE2_TXN	DIFF	-
26	NC	-	-
27	GND	GND	GND
28	NC	-	-
29	PCIE1_RXN	DIFF	-
30	NC	-	-
31	PCIE1_RXP	DIFF	-
32	NC	-	-
33	GND	GND	GND
34	NC	-	-
35	PCIE1_TXN	DIFF	-
36	NC	-	-
37	PCIE1_TXP	DIFF	-
38	DEVSLP	OUT	-
39	GND	GND	GND
40	SMB_CLK	IN/OUT	+1.8V
41	PCIE_3_RXN	DIFF	-
42	SMB_DATA	IN/OUT	+1.8V
43	PCIE_3_RXP	DIFF	-
44	SMB_ALERT_N	OUT	+1.8V
45	GND	GND	GND
46	NC	-	-
47	PCIE0_TXN	DIFF	-
48	NC	-	-
49	PCIE0_TXP	DIFF	-
50	BUF_PLT_RST#	OUT	
51	GND	GND	GND
52	M2B_CLKREQ#	IN	-
53	PCIE_M1_CLK_DN	DIFF	-
54	KEYB_WAKE_N	IN	-
55	PCIE_M1_CLK_DN	DIFF	-
56	NC	-	-
57	GND	GND	GND
58	NC	-	-
59	NC	-	-
60	NC	-	-
61	NC	-	-
62	NC	-	-
63	NC	-	-

Pin	Pin Name	Signal Type	Signal Level
64	NC	-	-
65	NC	-	-
66	NC	-	-
67	NC	-	-
68	PCH_SUS_CLK	IN	-
69	NC	-	-
70	+V3P3S	PWR	+3.3V
71	GND	GND	GND
72	+V3P3S	PWR	+3.3V
73	GND	GND	GND
74	+V3P3S	PWR	+3.3V
75	NC	-	-

2.5 Hardware Installation

This section details the steps needed to install various hardware components for the MEX-BTS. It is recommended that you read through each step before beginning installation and to make sure you have all necessary tools and components. For hardware installation, you will need a Phillips head screwdriver.

2.5.1 MXM Card Cooler Installation

Before starting, please note that the required amount of thermal grease has already been pre-applied to the bottom of the heatsink, and applying additional thermal grease is not recommended.

Step 1: The back plate is pre-attached to the underside of the MXM card. Remove the protective release paper from the back plate before proceeding.

Step 2: Place the heatsink directly on top of the GPU, ensuring that the heatsink screws are aligned with the mounting holes on the back plate.

Step 3: Set the screwdriver torque to no more than 5.0 kgf-cm (4.3 lbf-in). Keep the screwdriver vertical while tightening the screws.

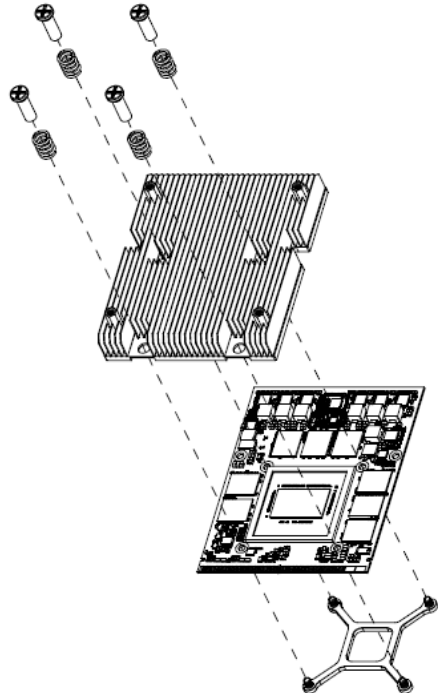

Step 4: Partially tighten the two diagonal screws (screws #1 and #2 as shown in the below diagram) until they are just seated.

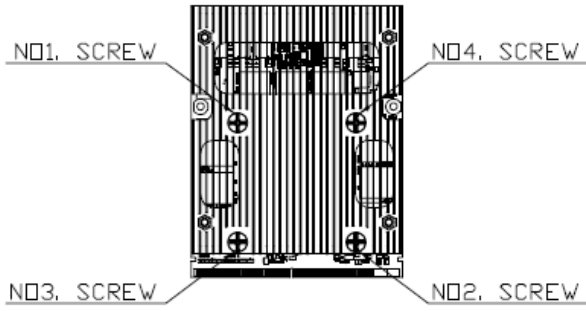

Do not fully tighten at this stage. Repeat this process for the remaining two diagonal screws (screws #3 and #4).

Step 5: Once all four screws are properly seated, fully tighten all screws to secure the heatsink.

Step 6: Install the MXM card on the MEX-BTS motherboard (for detailed instructions, please see section 2.5.2).

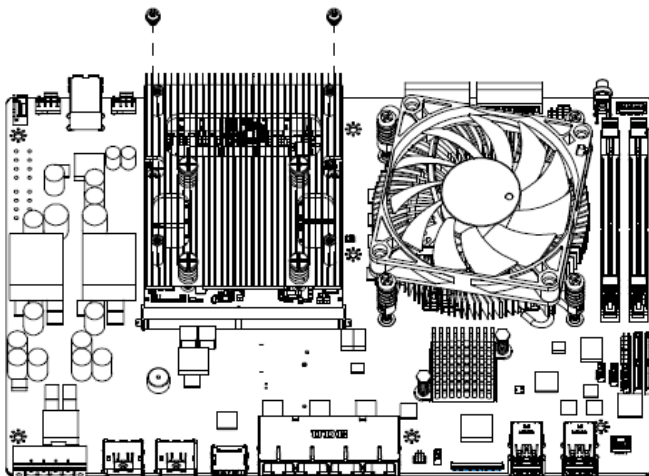

Step 7: Place the GPU cooler on top of the heatsink and secure it with the appropriate screws.

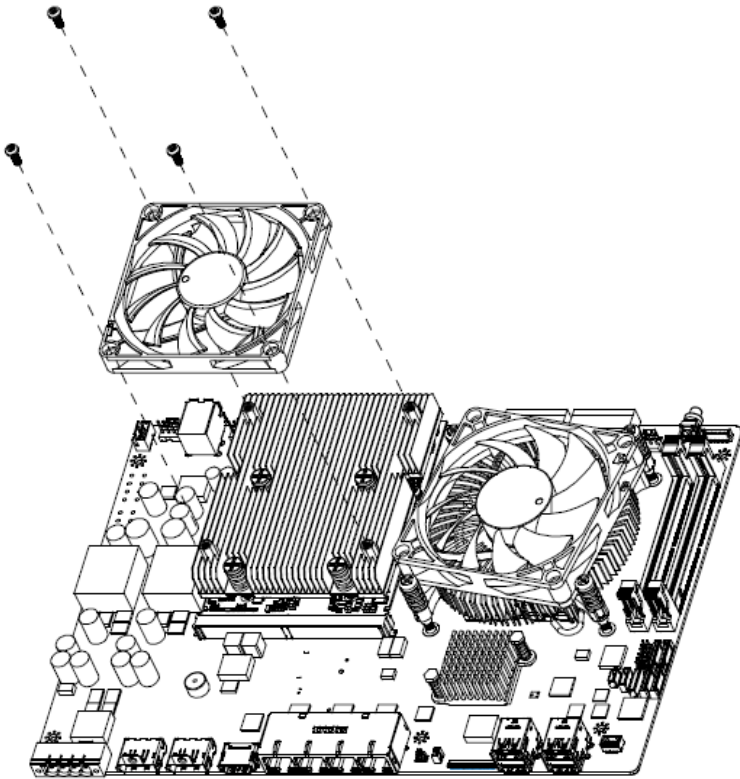

Step 8: Connect the fan cable to the GPU fan connector on the motherboard.

2.5.2 MXM Card Installation

Step 1: Remove the two black screws as below.



Step 2: Open the top panel to expose the system interior, noting the location of the MXM connector slot.

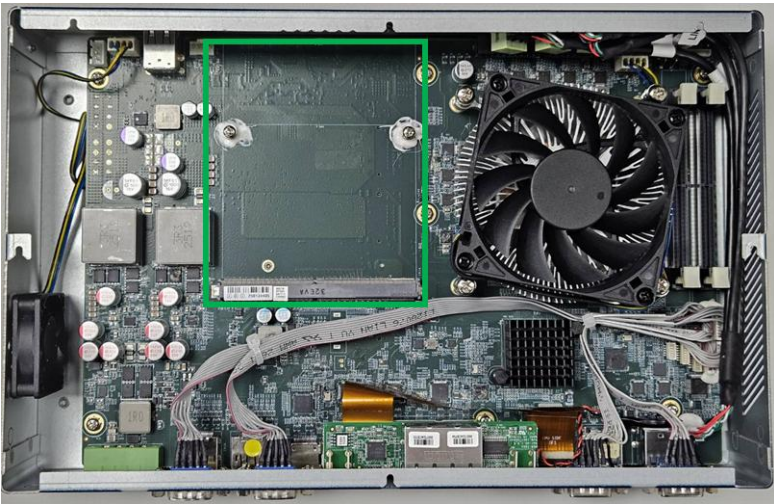

Step 3: Remove the two (2) screws as shown on the motherboards below.

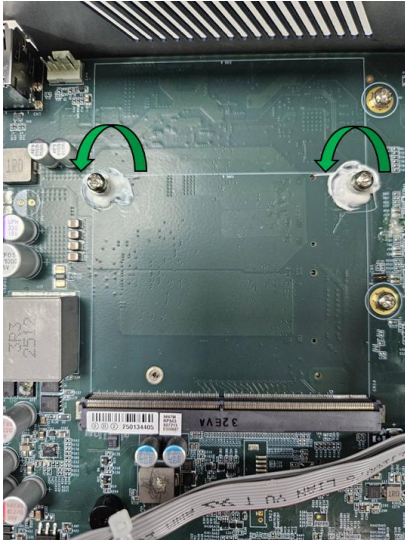

Step 4: Insert the MXM module, securing it to the motherboard with the screws removed in Step 3.

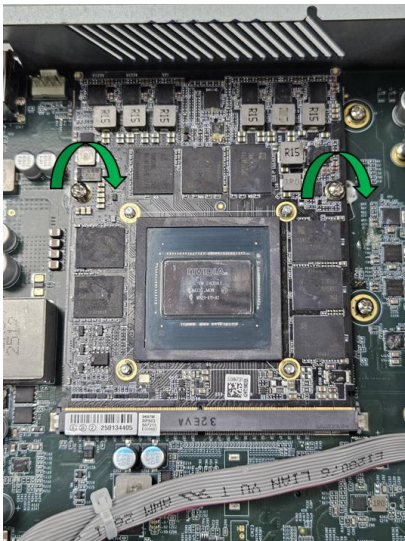

Step 5: Affix the MXM fan and backplane to the motherboard, making sure all four (4) screws are secured to the MXM backplane, as shown below.



Note: Please ensure the required heatsink and GPU fan has been installed prior to completion (refer to section 2.5.1 for detailed instructions).

2.5.3 RAM Installation

Step 1: Remove the two black screws as below.



Step 2: Open the top panel to expose the system interior, noting the location of the two RAM slots.



Step 3: Unclip the RAM slots, align the notch on the DDR5 module with the notch in the slot, and push down firmly on both ends until the clips snap into place.

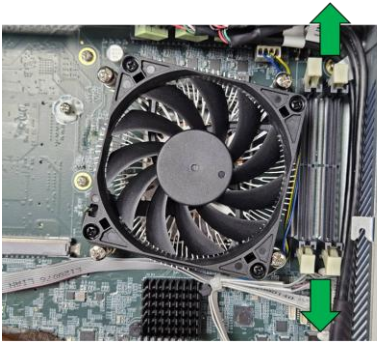

2.5.4 M.2 Module Installation

Step 1: Remove the two black screws from the bottom panel, and note the location of the system's M.2 slots and adjacent mounting screws.

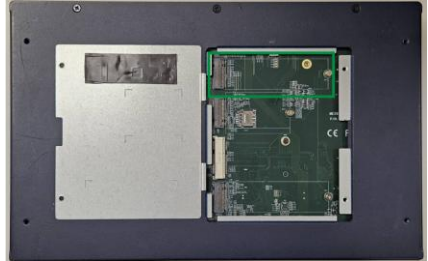

Step 2: Follow standard procedures for expansion card installation, aligning the notch on the modules with their corresponding slots, securing with the mounting screws.

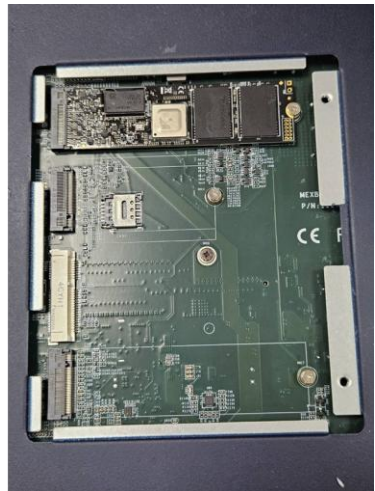

Chapter 3

AMI BIOS Setup

3.1 System Test and Initialization

These routines test and initialize board hardware. If the routines encounter an error during the tests, you will either hear a few short beeps or see an error message on the screen. There are two kinds of errors: fatal and non-fatal. The system can usually continue the boot up sequence with non-fatal errors.

System configuration verification

These routines check the current system configuration stored in the CMOS memory and BIOS NVRAM. If system configuration is not found or system configuration data error is detected, system will load optimized default and re-boot with this default system configuration automatically.

There are four situations in which you will need to setup system configuration:

1. You are starting your system for the first time
2. You have changed the hardware attached to your system
3. The system configuration is reset by Clear-CMOS jumper
4. The CMOS memory has lost power and the configuration information has been erased.

The MEX-BTS CMOS memory has an integral lithium battery backup for data retention. However, you will need to replace the battery unit when it finally runs down.

3.2 AMI BIOS Setup

AMI BIOS ROM has a built-in Setup program that allows users to modify the basic system configuration. This type of information is stored in battery-backed CMOS RAM and BIOS NVRAM so that it retains the Setup information when the power is turned off.

Entering Setup

Power on the computer and press or <ESC> immediately. This will allow you to enter Setup.

Main

Set the date, use tab to switch between date elements.

Advanced

Enable/disable boot option for legacy network devices.

Chipset

Host bridge parameters.

Security

Set setup administrator password.

Boot

Enables/disables quiet boot option.

Save & Exit

Exit system setup after saving the changes.

3.3 Setup Submenu: Main

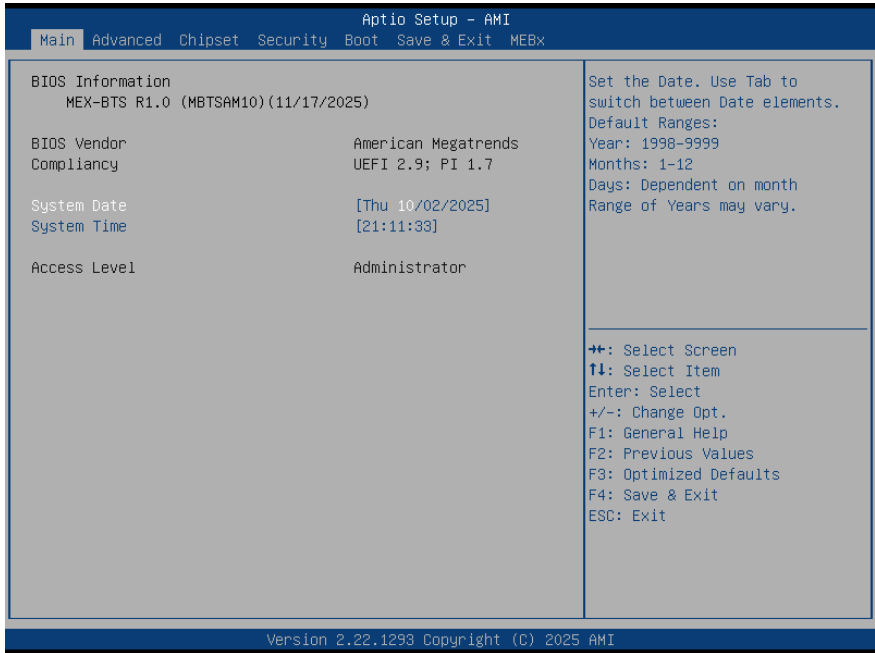

3.4 Setup Submenu: Advanced



3.4.1 CPU Configuration

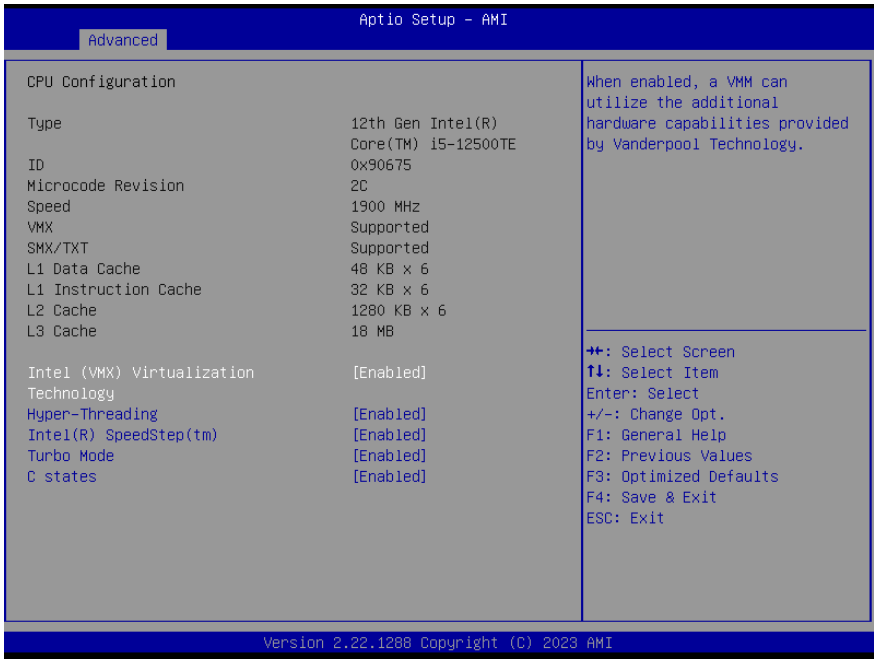

Options Summary		
Intel (VMX) Virtualization Technology	Disabled	
	Enabled	Optimal Default, Failsafe Default
When enabled, a virtual machine monitor (VMM) can use the additional hardware capabilities provided by Vanderpool Technology.		
Hyper-Threading	Disabled	
	Enabled	Optimal Default, Failsafe Default
Enable or Disable Hyper-Threading Technology.		
Intel® SpeedStep™	Disabled	
	Enabled	Optimal Default, Failsafe Default
Allows more than two frequency ranges to be supported.		
Turbo Mode	Disabled	
	Enabled	Optimal Default, Failsafe Default
Enables or disables Processor Turbo Mode (also requires EMTTM to be enabled).		
AUTO defaults to enabling Turbo Mode.		

Options Summary

C states	Disabled	
	Enabled	Optimal Default, Failsafe Default

Enables or disables CPU power management. When enabled, the CPU can enter C-states when it is not fully utilized.

3.4.2 PCH-FW Configuration

The screenshot shows the 'Advanced' menu of the Aptio Setup - AMI BIOS. The menu items are as follows:

- ME Firmware Version: 16.1.30.2269
- ME Firmware Mode: Normal Mode
- ME Firmware SKU: Consumer SKU
- ME Firmware Status 1: 0x90000255
- ME Firmware Status 2: 0x3B850106
- ▶ Firmware Update Configuration

On the right side of the screen, the 'Configure Management Engine Technology Parameters' menu is visible. At the bottom right, the following navigation options are listed:

- ↔: Select Screen
- ↑↓: Select Item
- Enter: Select
- +/-: Change Opt.
- F1: General Help
- F2: Previous Values
- F3: Optimized Defaults
- F4: Save & Exit
- ESC: Exit

At the bottom of the screen, the text reads: 'Version 2.22.1290 Copyright (C) 2025 AMI'.

3.4.3 Firmware Update Configuration



Options Summary		
Me FW Image Re-Flash	Enabled	
	Disabled	Optimal Default, Failsafe Default
Enable/Disable Me FW Image Re-Flash function.		
FW Update	Disabled	
	Enabled	Optimal Default, Failsafe Default
Enable/Disable ME FW Update function.		

3.4.4 PTT Configuration



Options Summary		
TPM Device Selection	dTPM	Optimal Default, Failsafe Default
	PTT	
Selects the TPM device: PTT or Discrete TPM (dTPM). PTT – Enables PTT in SkuMgr. dTPM – Disables PTT in SkuMgr. Warning: Enabling dTPM will disable PTT, and all data stored on the TPM will be lost.		

3.4.5 Trusted Computing

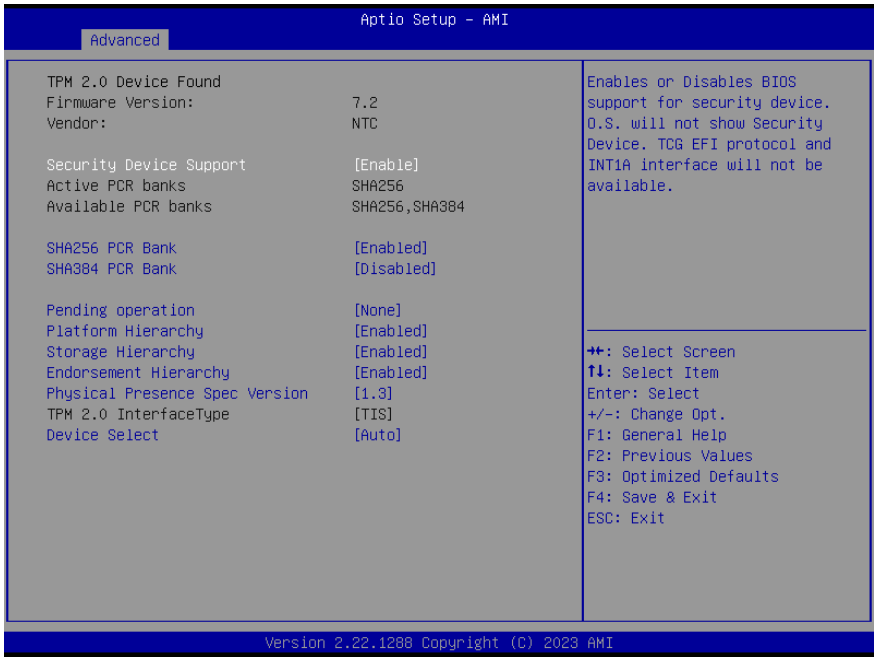

Options Summary		
Security Device Support	Enable	Optimal Default, Failsafe Default
	Disable	
Enables or disables BIOS support for the security device. When disabled, the operating system will not detect the security device, and the TCG EFI protocol and INT1A interface will be unavailable.		
SHA256 PCR Bank	Enabled	Optimal Default, Failsafe Default
	Disabled	
Enable or Disable SHA256 PCR Bank.		
SHA384 PCR Bank	Enabled	Optimal Default, Failsafe Default
	Disabled	
Enable or Disable SHA384 PCR Bank.		
Pending operation	None	Optimal Default, Failsafe Default
	TPM Clear	

Options Summary

Schedule an Operation for the Security Device.

NOTE: Your Computer will reboot during restart in order to change State of Security Device.

Platform Hierarchy	Enabled	Optimal Default, Failsafe Default
	Disabled	

Enable or Disable Platform Hierarchy.

Storage Hierarchy	Enabled	Optimal Default, Failsafe Default
	Disabled	

Enable or Disable Storage Hierarchy.

Endorsement Hierarchy	Enabled	Optimal Default, Failsafe Default
	Disabled	

Enable or Disable Endorsement Hierarchy.

Physical Presence Spec Version	1.3	Optimal Default, Failsafe Default
	1.2	

Select to Tell O.S. to support PPI Spec Version 1.2 or 1.3. Note some HCK tests might not support 1.3.

Device Select	Auto	Optimal Default, Failsafe Default
	TPM 1.2	
	TPM 2.0	

TPM 1.2 will restrict support to TPM 1.2 devices.

TPM 2.0 will restrict support to TPM 2.0 devices.

Auto will support both with the default set to TPM 2.0 devices if not found.

TPM 1.2 devices will be enumerated.

3.4.6 SATA Configuration

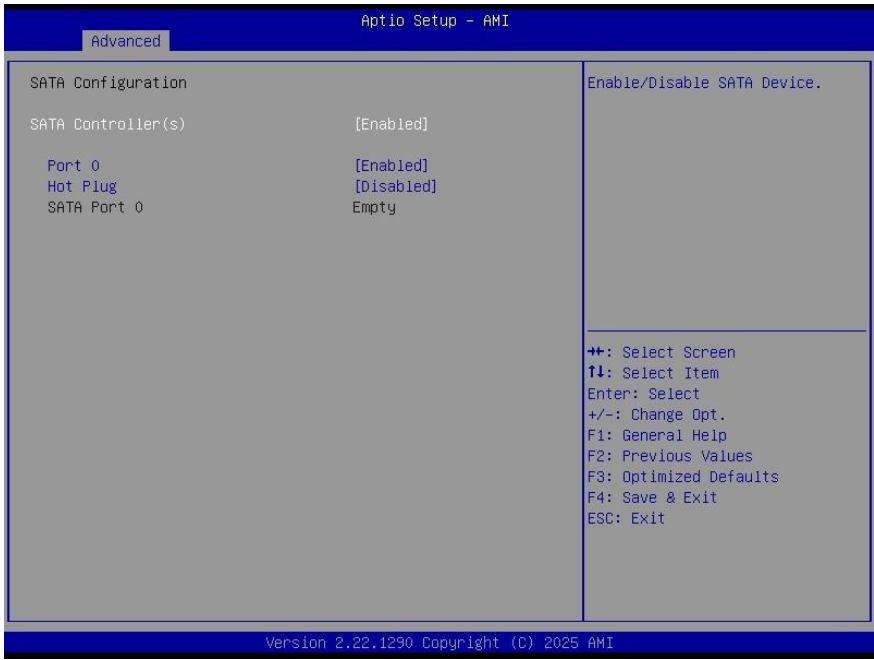

Options Summary		
SATA Controller(s)	Enabled	Optimal Default, Failsafe Default
	Disabled	
Enable/Disable SATA Device.		
Port 0	Enabled	Optimal Default, Failsafe Default
	Disabled	
Enable or Disable SATA Port.		
Hot Plug	Disabled	Optimal Default, Failsafe Default
	Enabled	
Designates this port as Hot Pluggable.		

3.4.7 Hardware Monitor

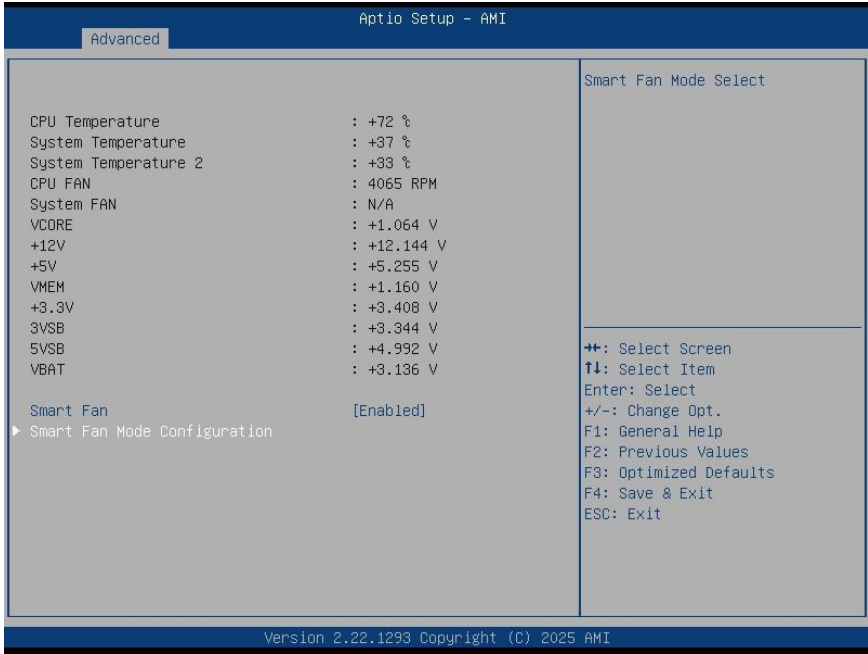

Options Summary		
Smart Fan	Disable	
	Enable	Optimal Default, Failsafe Default
Enables or Disables Smart Fan.		

3.4.7.1 Smart Fan Mode Configuration

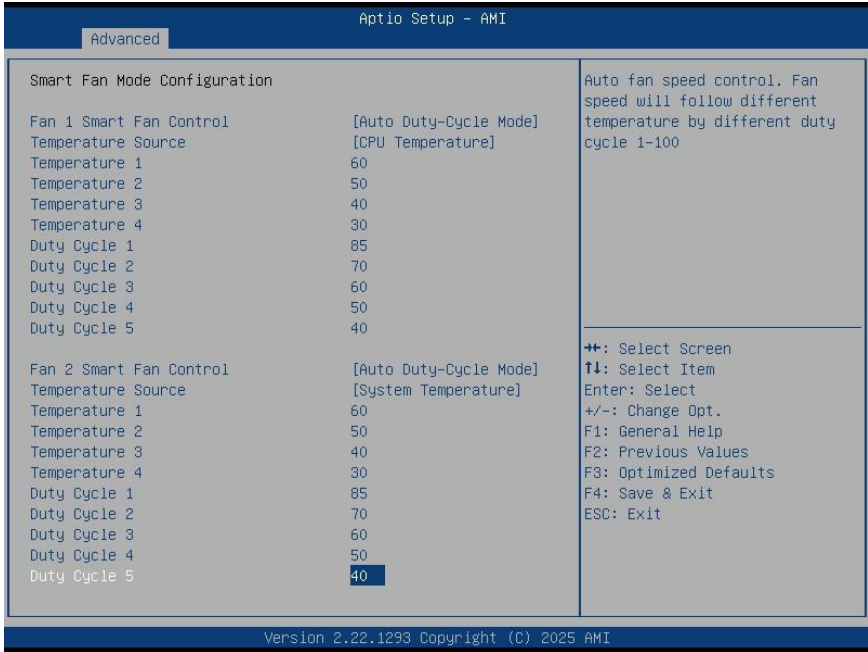

Options Summary		
Fan 1 Smart Fan Control	Manual Duty Mode	
	Auto Duty-Cycle Mode	Optimal Default, Failsafe Default
Smart Fan Mode Select.		
Temperature Source	CPU Temperature	Optimal Default, Failsafe Default
Select the monitored temperature source for this fan.		
Temperature 1	60	
Duty Cycle 1	85	
Enables automatic fan speed control. Fan speed adjusts according to temperature, using a duty cycle ranging from 1% to 100%.		
Fan 2 Smart Fan Control	Manual Duty Mode	
	Auto Duty-Cycle Mode	Optimal Default, Failsafe Default
Smart Fan Mode Select.		
Temperature Source	CPU Temperature	Optimal Default, Failsafe Default
Select the monitored temperature source for this fan.		
Temperature 1	60	

3.4.8.1 Serial Port 1 Configuration

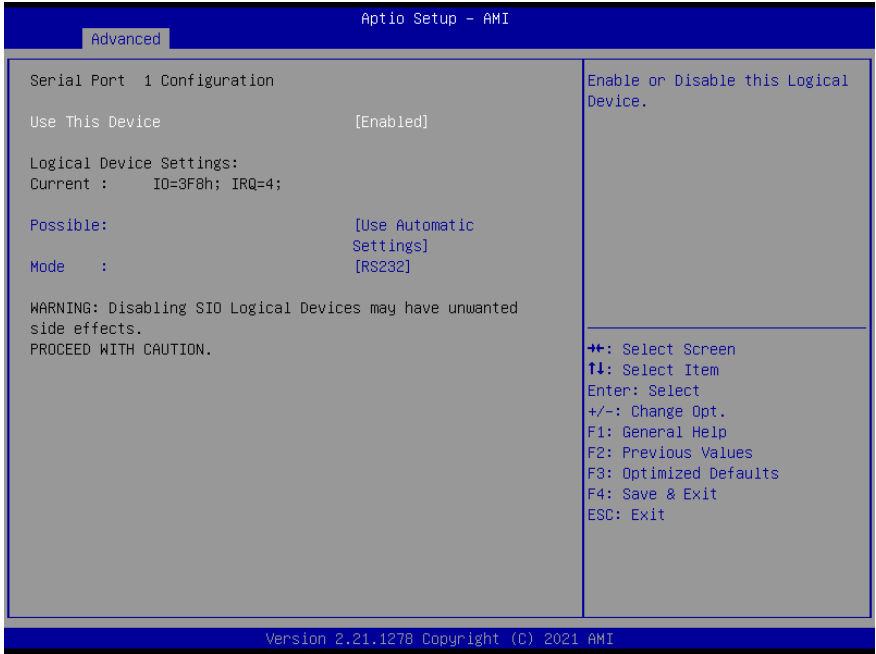

Options Summary		
Use This Device	Disable	
	Enable	Optimal Default, Failsafe Default
Enable or Disable this Logical Device.		
Possible:	Use Automatic Settings	Optimal Default, Failsafe Default
	IO=3F8h; IRQ=4	
	IO=2F8h; IRQ=3	
Allows the user to modify the device's resource settings. Changes will take effect on this setup page after the system restarts.		
Mode:	RS232	Optimal Default, Failsafe Default
	RS422	
	RS485	
UART RS232, 422, 485 selection.		

3.4.8.2 Serial Port 2 Configuration

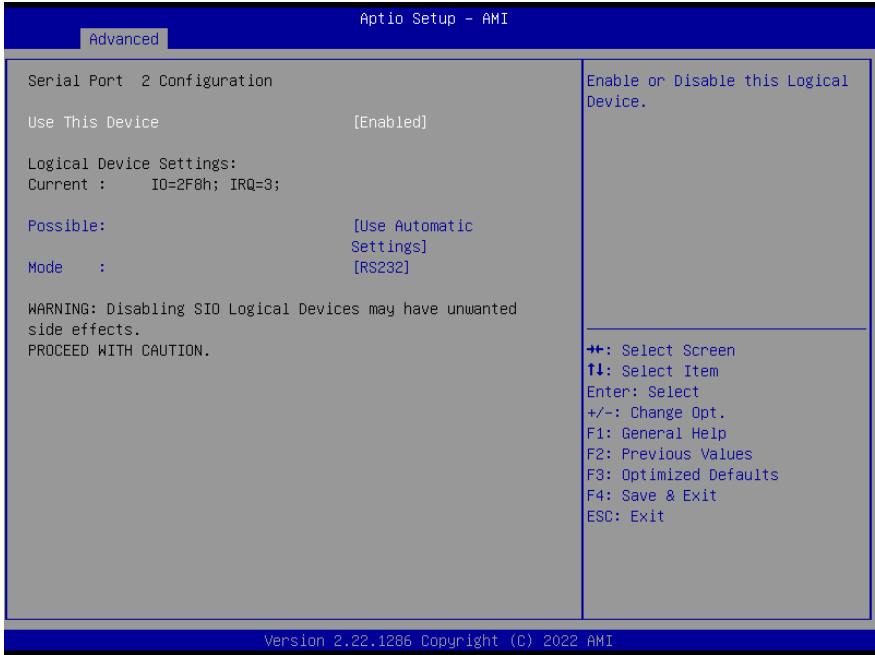

Options Summary		
Use This Device	Disable	
	Enable	Optimal Default, Failsafe Default
Enable or Disable this Logical Device.		
Possible:	Use Automatic Settings	Optimal Default, Failsafe Default
	IO=2F8h; IRQ=3	
	IO=3F8h; IRQ=4	
Allows the user to modify the device's resource settings. Changes will take effect on this setup page after the system restarts.		
Mode:	RS232	Optimal Default, Failsafe Default
	RS422	
	RS485	
UART RS232, 422, 485 selection.		

3.4.8.3 Serial Port 3 Configuration

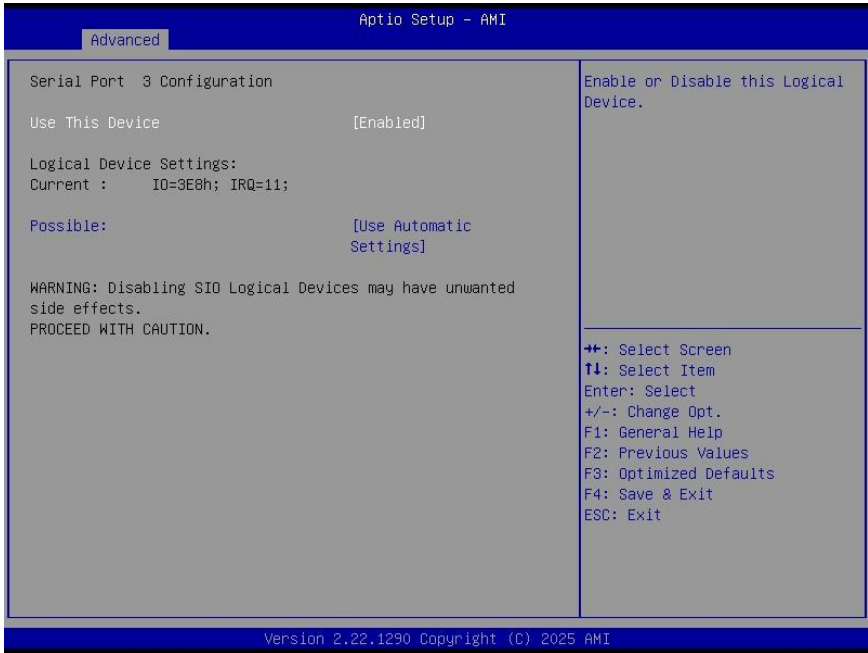

Options Summary		
Use This Device	Disable	
	Enable	Optimal Default, Failsafe Default
Enable or Disable this Logical Device.		
Possible:	Use Automatic Settings	Optimal Default, Failsafe Default
	IO=2F8h; IRQ=11	
	IO=3F8h; IRQ=11	
Allows the user to modify the device's resource settings. Changes will take effect on this setup page after the system restarts.		

3.4.8.4 Serial Port 4 Configuration

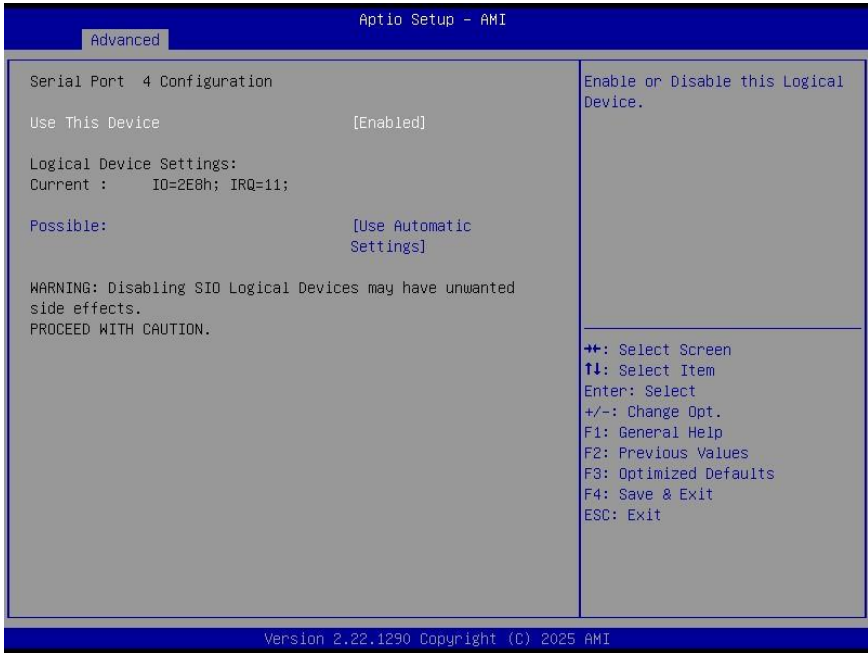

Options Summary		
Use This Device	Disable	
	Enable	Optimal Default, Failsafe Default
Enable or Disable this Logical Device.		
Possible:	Use Automatic Settings	Optimal Default, Failsafe Default
	IO=2F8h; IRQ=11	
	IO=3F8h; IRQ=11	
Allows the user to modify the device's resource settings. Changes will take effect on this setup page after the system restarts.		

3.4.9 Serial Port Console Redirection

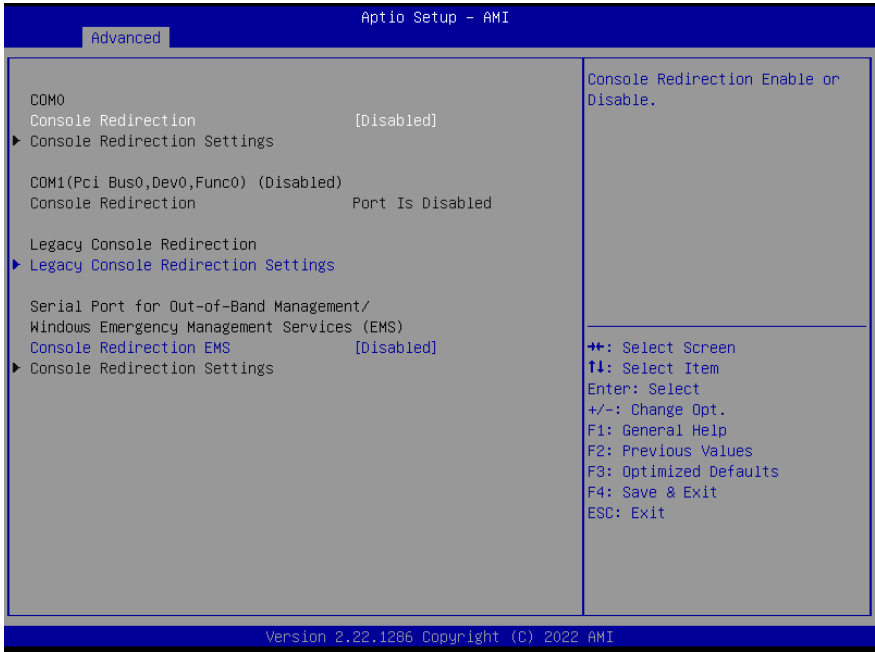

Options Summary		
Console Redirection	Disabled	Optimal Default, Failsafe Default
	Enabled	
Enable or Disable Console Redirection.		
Console Redirection EMS	Disabled	Optimal Default, Failsafe Default
	Enabled	
Enable or Disable Console Redirection EMS.		

3.4.10 Legacy Console Redirection Settings

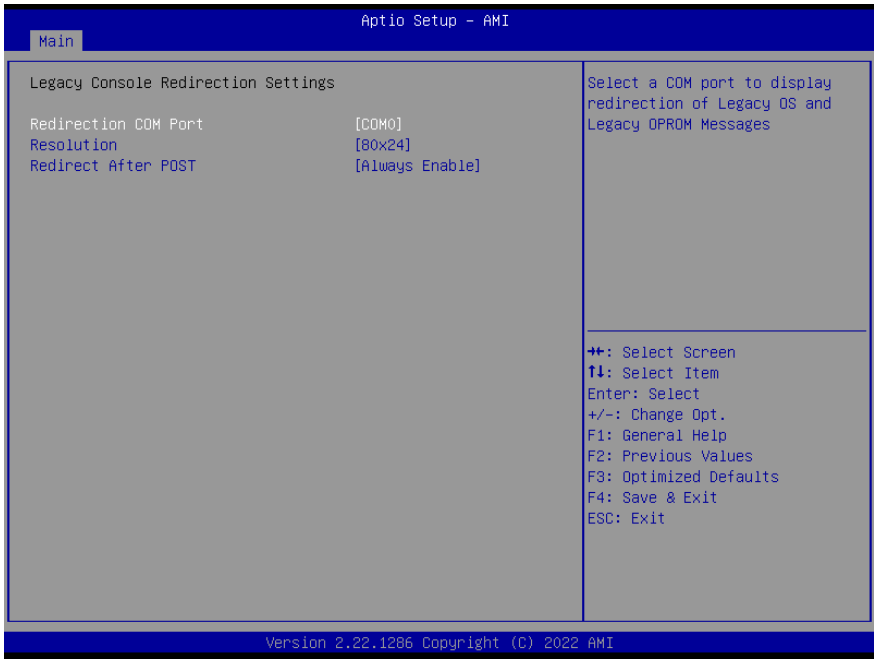

Options Summary		
Redirection COM port	COM0	Optimal Default, Failsafe Default
	COM1(Pci Bus0, Dev0, Func0) (Disabled)	
Select a COM port for displaying redirection messages from Legacy OS and Legacy Option ROM (OPROM).		
Resolution	80x24	Optimal Default, Failsafe Default
	80x25	
Specifies the number of rows and columns supported for redirection on a Legacy OS.		
Redirect After POST	Always Enable	Optimal Default, Failsafe Default
	BootLoader	
<p>Bootloader: Disables Legacy Console Redirection until the system boots into a legacy OS.</p> <p>Always Enable: Keeps Legacy Console Redirection enabled for legacy OS. The default option is Always Enable.</p>		

3.4.11 AAEON BIOS Robot



Options Summary		
Sends watch dog before BIOS POST	Disabled	Optimal Default, Failsafe Default
	Enabled	
<p>Enabled – The system sets the Watchdog Timer (WDT) immediately after power-on, before the BIOS begins the POST process. The WDT is cleared automatically upon completion of POST. If the WDT is not cleared before the timer reaches zero, the system will reset automatically.</p>		
POST Timer (second)	30	Optimal Default, Failsafe Default
<p>Specifies the timer duration for the Watchdog Timer (WDT) during POST.</p> <p>Warning: Do not set the timer to a value equal to or shorter than the normal POST time, as this may prevent the system from completing POST unless BIOS settings are cleared. A timer value of more than twice the normal POST duration is recommended.</p>		
Sends watch dog before booting OS	Disabled	Optimal Default, Failsafe Default
	Enabled	

Options Summary

Enabled – The system sets the Watchdog Timer (WDT) after POST completes, before the BIOS transfers control to the operating system.

Warning: Before enabling this feature, ensure that an OS program is responsible for clearing the WDT. This function should be disabled if the OS will perform an update.

OS Timer (minute)	3	Optimal Default, Failsafe Default
--------------------------	---	-----------------------------------

Specifies the timer duration for the Watchdog Timer (WDT) during OS loading.

Delayed POST (PEI phase)	Disabled	Optimal Default, Failsafe Default
	Enabled	

Enabled – The system delays the start of BIOS POST immediately after power-on. This allows POST to begin with stable power or after the system has physically warmed up.

Note: This delay occurs before the Watchdog Timer is activated.

Delayed time (second)	10	Optimal Default, Failsafe Default
------------------------------	----	-----------------------------------

Specifies the duration for which the system delays BIOS POST.

Delayed POST (DXE phase)	Disabled	Optimal Default, Failsafe Default
	Enabled	

Enabled – The system delays BIOS POST before its completion. This allows POST to proceed with stable power or after the system has physically warmed up.

Note: This delay occurs after the Watchdog Timer is activated before BIOS POST.

Delayed time (second)	10	Optimal Default, Failsafe Default
------------------------------	----	-----------------------------------

Specifies the duration for which the system delays BIOS POST.

Reset system once	Disabled	Optimal Default, Failsafe Default
	Enabled	

Enabled – The system performs a one-time reset on each boot. This sends a soft or hard reset to onboard devices, helping to ensure they start in a stable state.

Soft or hard reset	Soft reset	Optimal Default, Failsafe Default
	Hard reset"	

Select the type of reset the system should perform on each boot.

3.4.12 Power Management

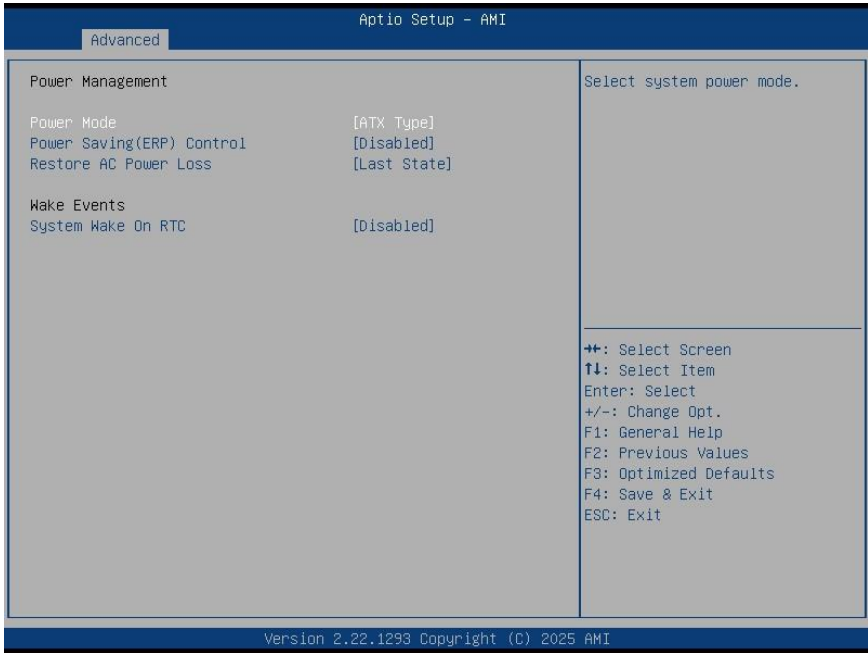

Options Summary		
Power Mode	ATX Type	Optimal Default, Failsafe Default
	AT Type	
Select power supply mode.		
Power Saving (ERP) Control	Enable	Optimal Default, Failsafe Default
	Disable	
Configure power mode for power saving function.		
Restore AC Power Loss	Last State	Optimal Default, Failsafe Default
	Always On	
	Always Off	
Select power state when power is re-applied after a power failure.		
System Wake On RTC	Disable	Optimal Default, Failsafe Default
	By Date	
	Bypass	

Options Summary

By Date: The system will wake on the specified day at the designated hour, minute, and second.

By Weekday: The system will wake on the selected weekdays at the designated hour, minute, and second.

Bypass: BIOS will not control the RTC wake function.

3.4.13 GPIO Port Configuration

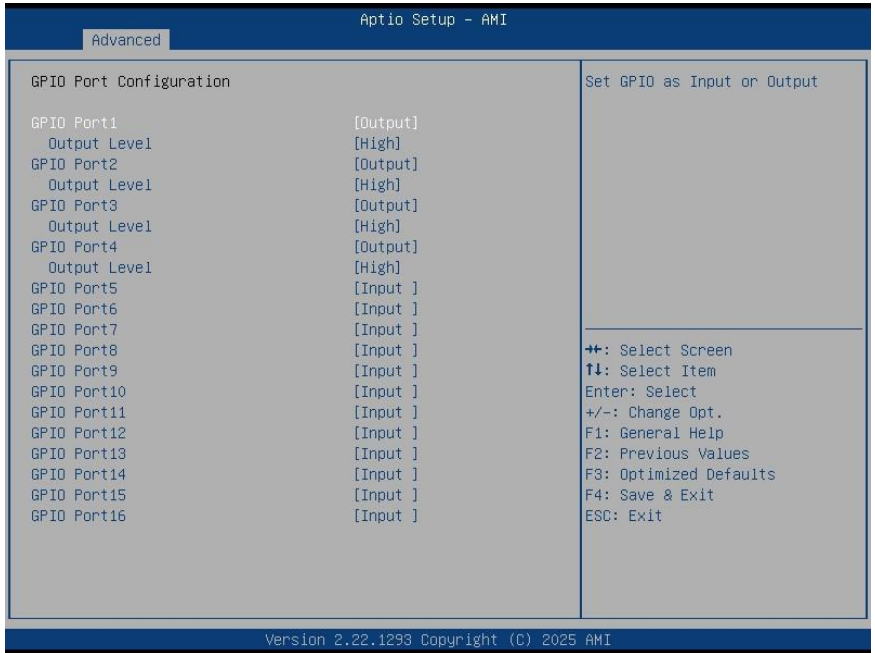

Options Summary

GDIO Port*	Output	
	Input	
Set GPIO as Input or Output.		
Output Level	High	
	Low	
Set output level when GDIO pin is output.		

3.4.14 AAEON Smart Boost

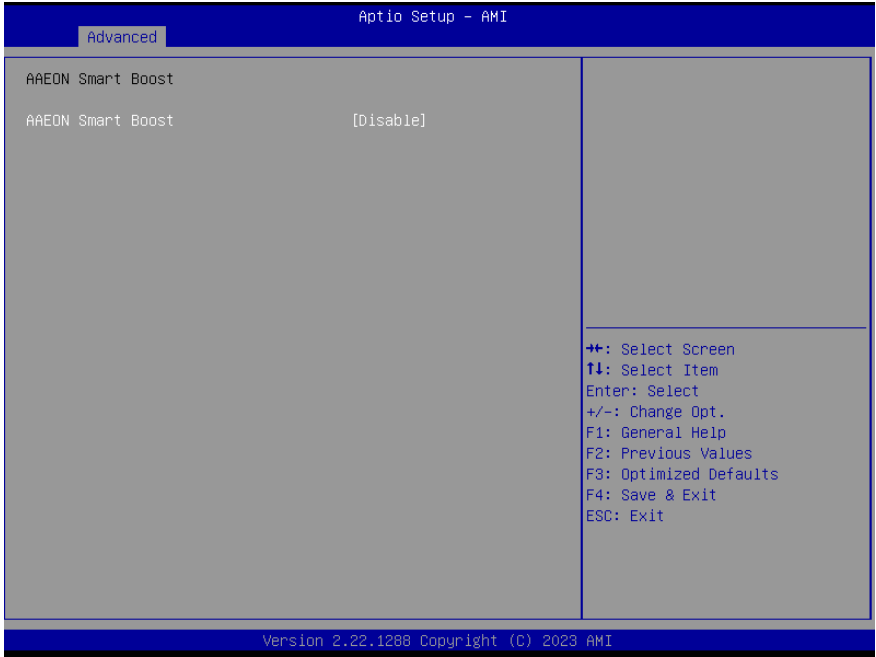

3.5 Setup Submenu: Chipset



3.5.1 System Agent (SA) Configuration

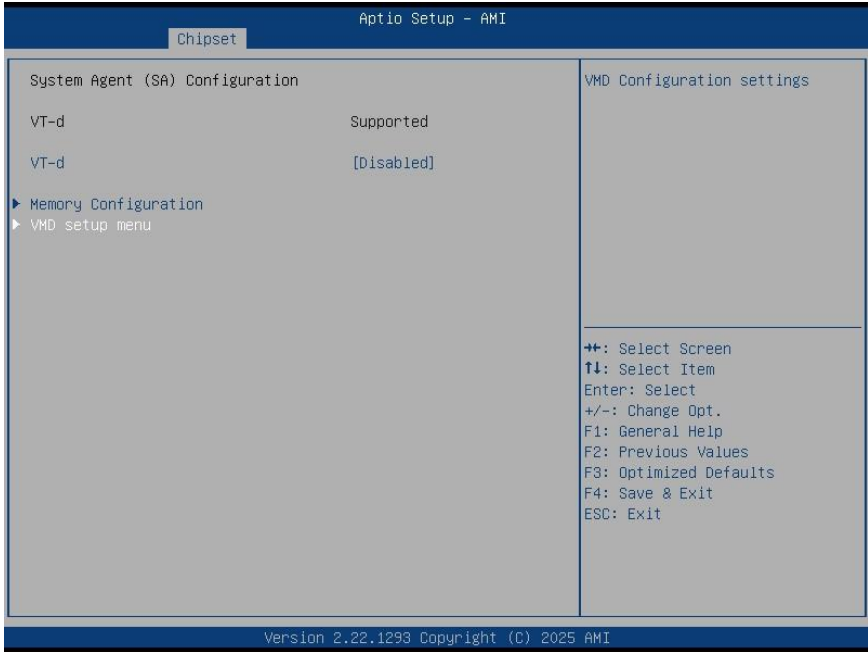

Options Summary		
VT-d	Disabled	Optimal Default, Failsafe Default
	Enabled	
VT-d capability.		

3.5.2 Memory Configuration

Aptio Setup - AMI

Chipset

Memory Configuration	
Total Memory	8192 MB
Memory Frequency	4800 MHz
tCL-tRCD-tRP-tRAS	40-39-39-77
MC 0 Ch 0 DIMM 0	Populated & Enabled
Size	8192 MB (DDR5)
MC 1 Ch 0 DIMM 0	Not Populated / Disabled

⬆⬆: Select Screen
⬆⬆: Select Item
Enter: Select
+/-: Change Opt.
F1: General Help
F2: Previous Values
F3: Optimized Defaults
F4: Save & Exit
ESC: Exit

Version 2.22.1286 Copyright (C) 2022 AMI

3.5.3 VMD Setup Menu

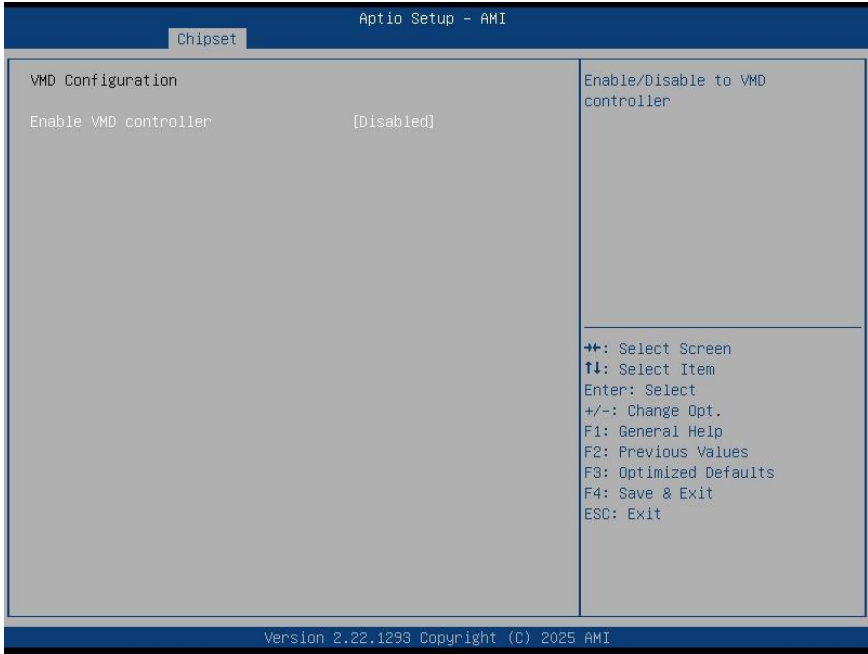

Options Summary		
Enable VMD Controller	Disabled	Optimal Default, Failsafe Default
	Enabled	
Enable/Disable VMD Controller.		

3.5.4 PCH-IO Configuration

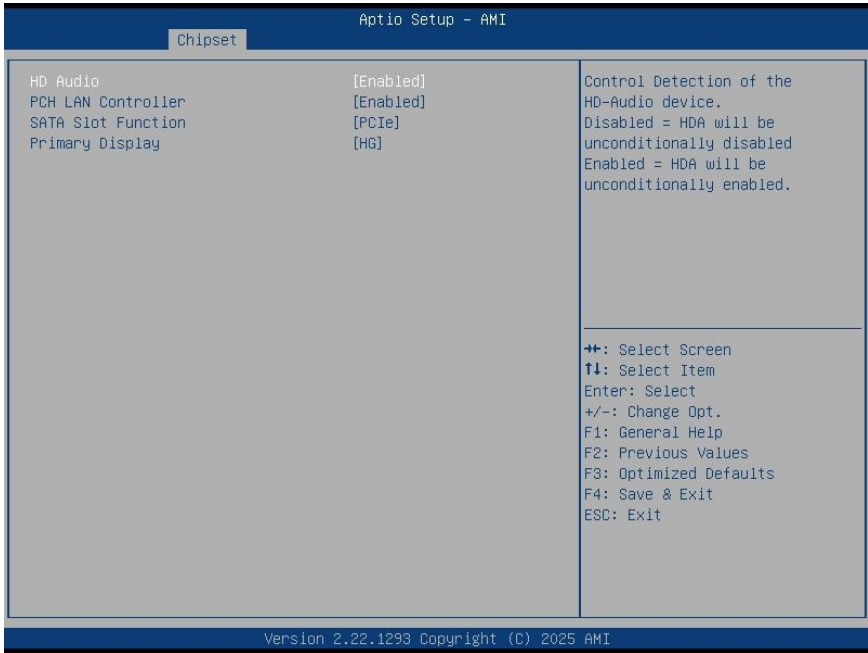

Options Summary		
HD Audio	Disabled	
	Enabled	Optimal Default, Failsafe Default
Controls the detection of the HD-Audio (HDA) device:		
Disabled: HDA is always disabled.		
Enabled: HDA is always enabled.		
PCH LAN Controller	Disabled	
	Enabled	Optimal Default, Failsafe Default
Enable/Disable onboard NIC.		
SATA Slot Function	SATA	
	PCIe	Optimal Default, Failsafe Default
Select the function to be enabled for the SATA slot.		
Primary Display	Auto	
	IGFX	
	PEG Slot	
	PCH PCI	

Options Summary		
Primary Display	HG	Optimal Default, Failsafe Default
Select the primary display device from IGFX, PEG, or PCI, or choose HG for Hybrid Graphics.		

3.5.5 NVMe Configuration

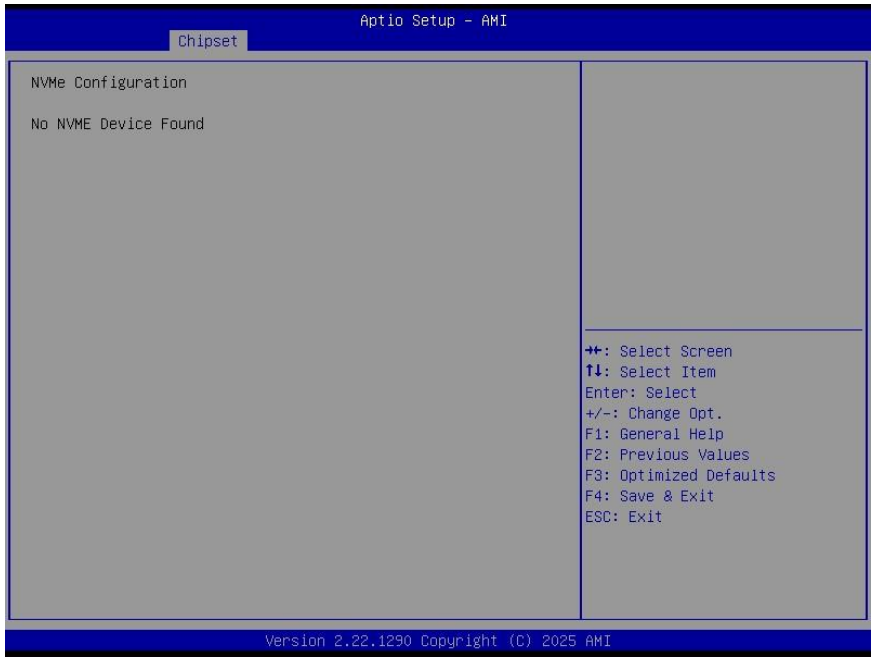

3.6 Setup Submenu: Security

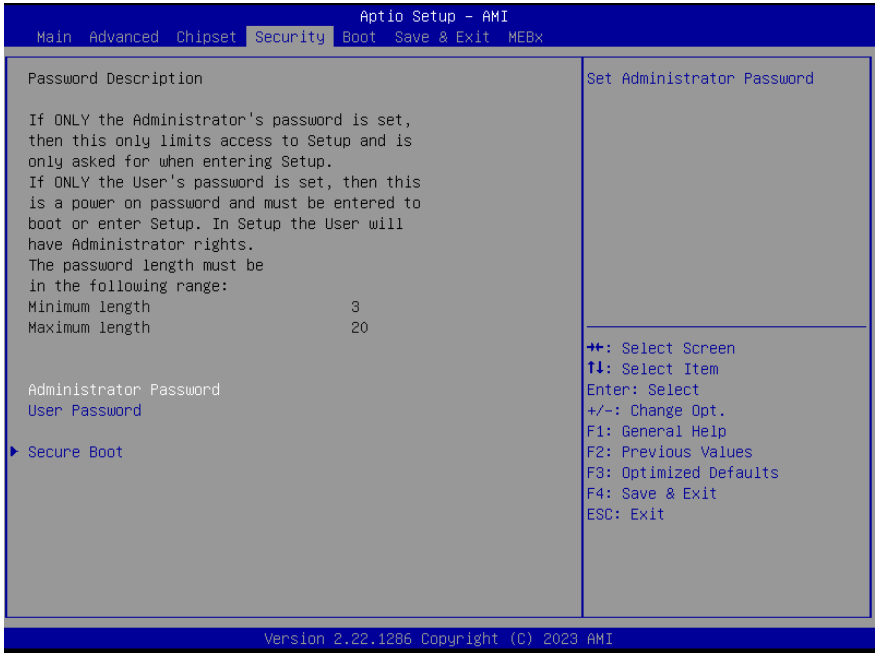

Change User/Supervisor Password

You can install a Supervisor password, and if you install a supervisor password, you can then install a user password. A user password does not provide access to many of the features in the Setup utility.

If you highlight these items and press Enter, a dialog box appears which lets you enter a password. You can enter no more than six letters or numbers. Press Enter after you have typed in the password. A second dialog box asks you to retype the password for confirmation. Press Enter after you have retyped it correctly. The password is required at boot time, or when the user enters the Setup utility.

Removing the Password

Highlight this item and type in the current password. At the next dialog box press Enter to disable password protection.

3.6.1 Secure Boot

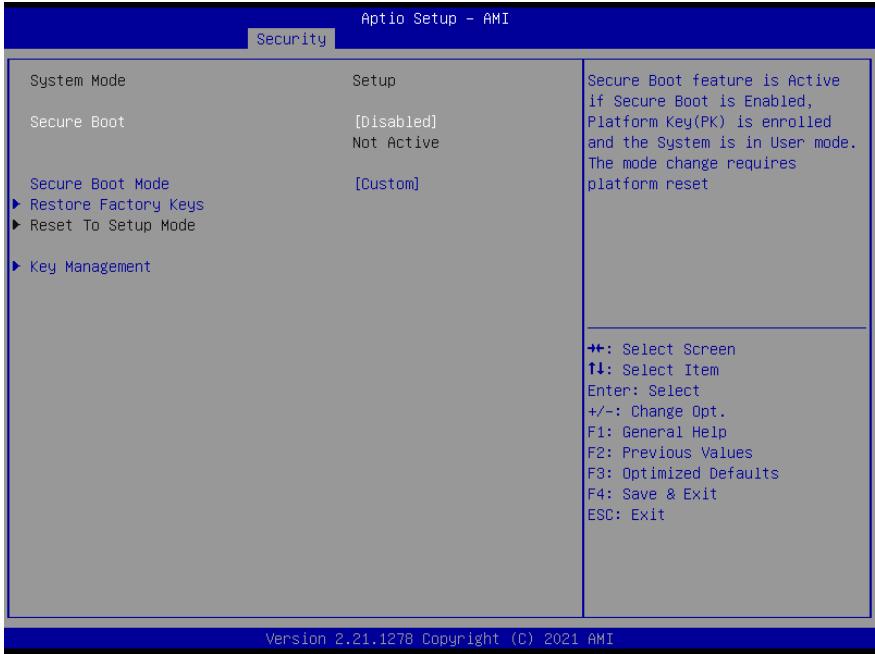

Options Summary		
Secure Boot	Disabled	Optimal Default, Failsafe Default
	Enabled	
The Secure Boot feature is active when Secure Boot is enabled, the Platform Key (PK) is enrolled, and the system is in User mode. Changing the mode requires a platform reset.		
Secure Boot Mode	Custom	Optimal Default, Failsafe Default
	Standard	
Secure Boot mode options: Standard or Custom .		
In Custom mode, a physically present user can configure Secure Boot Policy variables without full authentication.		
Restore Factory Keys		
Force System to User Mode. Install factory default Secure Boot key databases.		
Reset to Setup Mode		
Delete all Secure Boot key databases from NVRAM.		

Options Summary	
Remove 'UEFI CA' from DB	
A Device Guard–ready system must not include the "Microsoft UEFI CA" certificate in the Authorized Signature Database (db).	
Restore DB defaults	
Restore DB variable to factory defaults.	
Platform Key (PK)	Details
	Export
	Update
	Delete
Key Exchange Keys	Details
	Export
	Update
	Append
	Delete
Authorized Signatures	Details
	Export
	Update
	Append
	Delete
Forbidden Signatures	Details
	Export
	Update
	Append
	Delete
Authorized TimeStamps	Update
	Append
OsRecovery Signatures	Update
	Append
Enroll Factory Defaults or load certificates from a file:	
1. Public Key Certificate:	
a) EFI_SIGNATURE_LIST.	
b) EFI_CERT_X509 (DER).	
c) EFI_CERT_RSA2048 (bin).	
d) EFI_CERT_SHAXXX.	
2. Authenticated UEFI Variable.	
3. EFI PE/COFF Image (SHA256).	
Key Source: Factory, External, Mixed.	

3.7 Setup Submenu: Boot

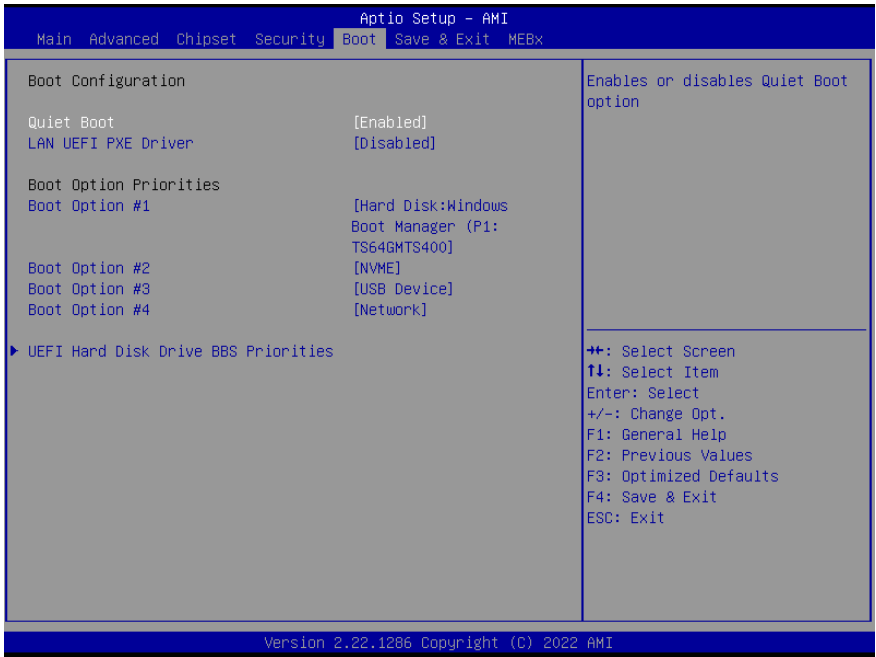

Options Summary		
Quiet Boot	Disabled	
	Enabled	Optimal Default, Failsafe Default
Enable or Disable Quiet Boot option.		
UEFI PXE Support	Disabled	Optimal Default, Failsafe Default
	Enabled	
Enable/Disable UEFI Network Stack.		
FIXED BOOT ORDER Priorities		
Sets the system boot order.		

3.8 Setup Submenu: Save & Exit

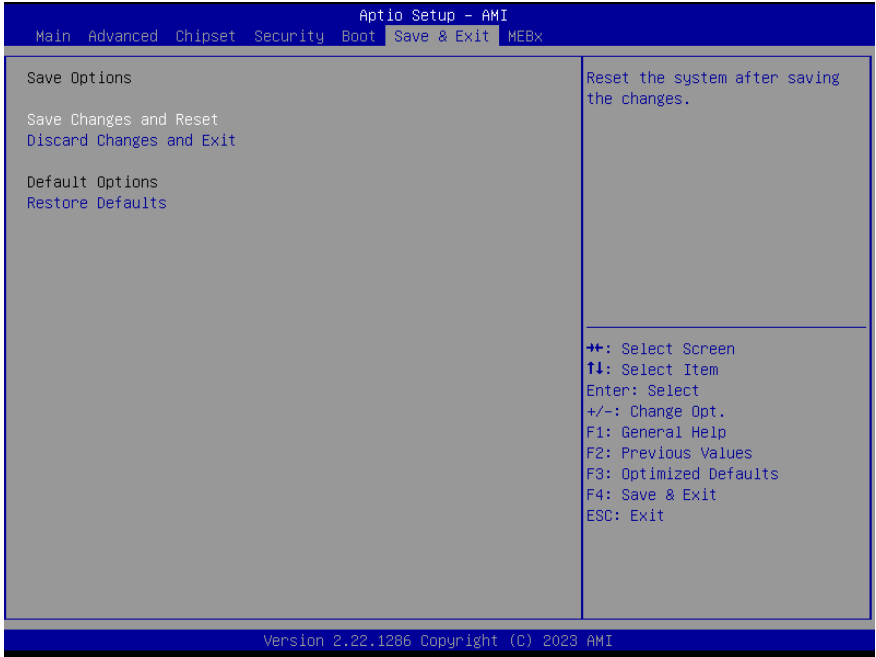

Options Summary	
Save Changes and Reset	Reset the system after saving the changes.
Discard Changes and Exit	Exit system setup without saving any changes.
Restore Defaults	Restore/Load Default values for all the setup options.

Chapter 4

Drivers Installation

4.1 Drivers Download and Installation

Drivers for the MEX-BTS can be downloaded from the product page on the AAEON website by following this link:

<https://www.aaeon.com/en/>

Download the driver(s) you need and follow the steps below to install them.

Install Chipset Drivers

1. Open the **Chipset** folder
2. Open the **SetupChipset.exe** file
3. Follow the instructions
4. Drivers will be installed automatically

Install Graphics Driver

1. Open the **Graphics** folder
2. Open the **Installer.exe** file in the folder
3. Follow the instructions
4. Drivers will be installed automatically

Install LAN Drivers

1. Open the **LAN** folder
2. Right-click on **eld.inf** and select **Install**
3. Follow the on-screen instructions to complete the installation.

Note: These instructions apply to drivers for both Intel® Ethernet Controller I226 and Intel® Ethernet Connection I219 packages.

Install ME & TXE Drivers

1. Open the **ME & TXE Driver** folder
2. Open the **SetupME.exe** file
3. Follow the instructions
4. Drivers will be installed automatically

Install Peripheral Driver

1. Open the **Peripheral Driver** folder
2. Open the **SetupSerialIO.exe** file
3. Follow the instructions
4. Drivers will be installed automatically

Install Audio Drivers

1. Open the **Audio Driver** folder
2. Run the **Setup.exe** file in the folder
3. Follow the instructions
4. Driver will be installed automatically

Install Intel® RST Driver





1. Open the **Intel® RST Driver** folder
2. Open the **SetupRST.exe** file
3. Follow the instructions
4. Drivers will be installed automatically

Appendix A

I/O Information





















A.1 I/O Address Map

Input/output (I/O)	
[0000000000000000 - 000000000000CF7]	PCI Express Root Complex
[0000000000000020 - 000000000000021]	Programmable interrupt controller
[0000000000000024 - 000000000000025]	Programmable interrupt controller
[0000000000000028 - 000000000000029]	Programmable interrupt controller
[000000000000002C - 00000000000002D]	Programmable interrupt controller
[000000000000002E - 00000000000002F]	Motherboard resources
[0000000000000030 - 000000000000031]	Programmable interrupt controller
[0000000000000034 - 000000000000035]	Programmable interrupt controller
[0000000000000038 - 000000000000039]	Programmable interrupt controller
[000000000000003C - 00000000000003D]	Programmable interrupt controller
[0000000000000040 - 000000000000043]	System timer
[000000000000004E - 00000000000004F]	Motherboard resources
[0000000000000050 - 000000000000053]	System timer
[0000000000000061 - 000000000000061]	Motherboard resources
[0000000000000063 - 000000000000063]	Motherboard resources
[0000000000000065 - 000000000000065]	Motherboard resources
[0000000000000067 - 000000000000067]	Motherboard resources
[0000000000000070 - 000000000000070]	Motherboard resources
[0000000000000080 - 000000000000080]	Motherboard resources
[0000000000000092 - 000000000000092]	Motherboard resources
[00000000000000A0 - 0000000000000A1]	Programmable interrupt controller
[00000000000000A4 - 0000000000000A5]	Programmable interrupt controller
[00000000000000A8 - 0000000000000A9]	Programmable interrupt controller
[00000000000000AC - 0000000000000AD]	Programmable interrupt controller
[00000000000000B0 - 0000000000000B1]	Programmable interrupt controller
[00000000000000B2 - 0000000000000B3]	Motherboard resources
[00000000000000B4 - 0000000000000B5]	Programmable interrupt controller
[00000000000000B8 - 0000000000000B9]	Programmable interrupt controller
[00000000000000BC - 0000000000000BD]	Programmable interrupt controller
[00000000000002E8 - 0000000000002EF]	Communications Port (COM4)
[00000000000002F8 - 0000000000002FF]	Communications Port (COM2)
[00000000000003E8 - 0000000000003EF]	Communications Port (COM3)
[00000000000003F8 - 0000000000003FF]	Communications Port (COM1)
[00000000000004D0 - 00000000000004D1]	Programmable interrupt controller
[0000000000000680 - 000000000000069F]	Motherboard resources
[0000000000000A00 - 0000000000000A0F]	Motherboard resources
[0000000000000A10 - 0000000000000A1F]	Motherboard resources
[0000000000000A20 - 0000000000000A2F]	Motherboard resources
[0000000000000D00 - 000000000000FFFF]	PCI Express Root Complex
[000000000000164E - 000000000000164F]	Motherboard resources
[0000000000001854 - 0000000000001857]	Motherboard resources
[0000000000001854 - 0000000000001857]	Motherboard resources
[0000000000002000 - 00000000000020FE]	Motherboard resources
[0000000000003000 - 0000000000003FFF]	Intel(R) PCI Express Root Port #9 - 7A80
[0000000000004000 - 0000000000004FFF]	Intel(R) PCI Express Root Port #1 - 7A88
[0000000000005000 - 000000000000503F]	Intel(R) UHD Graphics 730
[0000000000005000 - 000000000000503F]	Intel(R) UHD Graphics 770
[0000000000005000 - 000000000000503F]	Intel(R) UHD Graphics 770
[0000000000005060 - 000000000000507F]	Standard SATA AHCI Controller
[0000000000005080 - 0000000000005083]	Standard SATA AHCI Controller

-  [0000000000005080 - 0000000000005083] Standard SATA AHCI Controller
-  [0000000000005090 - 0000000000005097] Standard SATA AHCI Controller
-  [000000000000EFA0 - 000000000000EFBF] Intel(R) SMBus - 7AA3
-  [000000000000FFF8 - 000000000000FFFF] Intel(R) Active Management Technology - SOL (COM5)

A.2 Memory Address Map

Address Range	Device Name
[0000000000A0000 - 0000000000BFFFF]	PCI Express Root Complex
[00000000008040000 - 00000000BFFFFFFF]	PCI Express Root Complex
[0000000081000000 - 0000000081FFFFFF]	Intel(R) Arc(TM) A350M Graphics
[0000000081000000 - 0000000081FFFFFF]	Intel(R) Arc(TM) A350M Graphics
[0000000081000000 - 0000000081FFFFFF]	Intel(R) Arc(TM) A350M Graphics
[0000000081000000 - 00000000821FFFFFF]	PCI Express Downstream Switch Port
[0000000081000000 - 00000000821FFFFFF]	PCI Express Downstream Switch Port
[0000000081000000 - 00000000823FFFFFF]	PCI Express Downstream Switch Port
[0000000081000000 - 00000000823FFFFFF]	Intel(R) PCIe RC 010 G5 - A70D
[0000000081000000 - 00000000823FFFFFF]	PCI Express Upstream Switch Port
[0000000081000000 - 00000000823FFFFFF]	PCI Express Upstream Switch Port
[0000000081000000 - 00000000823FFFFFF]	PCI Express Upstream Switch Port
[0000000081000000 - 00000000823FFFFFF]	PCI-to-PCI Bridge
[0000000081000000 - 00000000823FFFFFF]	PCI-to-PCI Bridge
[0000000082300000 - 00000000823FFFFFF]	PCI Express Downstream Switch Port
[0000000082300000 - 00000000823FFFFFF]	PCI Express Downstream Switch Port
[0000000082300000 - 00000000823FFFFFF]	PCI Express Downstream Switch Port
[00000000823FC000 - 00000000823FFFFFF]	High Definition Audio Controller
[0000000082400000 - 0000000082DFFFFFF]	Intel(R) PCI Express Root Port #9 - 7AB0
[0000000082E00000 - 00000000837FFFFFF]	Intel(R) PCI Express Root Port #1 - 7AB8
[0000000083800000 - 00000000839FFFFFF]	Intel(R) PCI Express Root Port #14 - 7AB5
[00000000838FC000 - 0000000083BFFFFFF]	Intel(R) Ethernet Controller I226-V #3
[0000000083900000 - 00000000839FFFFFF]	Intel(R) Ethernet Controller I226-V #3
[0000000083A00000 - 0000000083BFFFFFF]	Intel(R) PCI Express Root Port #13 - 7ABA
[0000000083AFC000 - 0000000083AFFFFFF]	Intel(R) Ethernet Controller I226-V #2
[0000000083B00000 - 0000000083BFFFFFF]	Intel(R) Ethernet Controller I226-V #2
[0000000083C00000 - 0000000083DFFFFFF]	Intel(R) PCI Express Root Port #4 - 7ABB
[0000000083CFC000 - 0000000083CFFFFFF]	Intel(R) Ethernet Controller I226-V
[0000000083D00000 - 0000000083DFFFFFF]	Intel(R) Ethernet Controller I226-V
[0000000083E00000 - 0000000083E03FFF]	Standard NVM Express Controller
[0000000083E00000 - 0000000083E03FFF]	Standard NVM Express Controller
[0000000083E00000 - 0000000083EFFFFFF]	Intel(R) PCI Express Root Port #5 - 7ABC
[0000000083E00000 - 0000000083EFFFFFF]	PCI-to-PCI Bridge
[0000000083F00000 - 0000000083F1FFFF]	Intel(R) Ethernet Connection (17) I219-LM
[0000000083F20000 - 0000000083F21FFF]	Standard SATA AHCI Controller
[0000000083F22000 - 0000000083F227FF]	Standard SATA AHCI Controller
[0000000083F23000 - 0000000083F230FF]	Standard SATA AHCI Controller
[00000000BFFFFFF000 - 00000000BFFFFFFF]	Intel(R) Active Management Technology - SOL (COM5)
[00000000C0000000 - 00000000CFFFFFFF]	Motherboard resources
[00000000E0690000 - 00000000E069FFFF]	Intel(R) Serial IO GPIO Host Controller - INTC1056
[00000000E06A0000 - 00000000E06AFFFF]	Intel(R) Serial IO GPIO Host Controller - INTC1056
[00000000E06B0000 - 00000000E06BFFFF]	Intel(R) Serial IO GPIO Host Controller - INTC1056
[00000000E06D0000 - 00000000E06DFFFF]	Intel(R) Serial IO GPIO Host Controller - INTC1056
[00000000E06E0000 - 00000000E06EFFFF]	Intel(R) Serial IO GPIO Host Controller - INTC1056
[00000000FE010000 - 00000000FE010FFF]	Intel(R) SPI (flash) Controller - 7AA4
[00000000FED00000 - 00000000FED003FF]	High precision event timer
[00000000FED20000 - 00000000FED7FFFF]	Motherboard resources
[00000000FED40000 - 00000000FED44FFF]	Trusted Platform Module 2.0
[00000000FED45000 - 00000000FED8FFFF]	Motherboard resources
[00000000FED90000 - 00000000FED93FFF]	Motherboard resources
[00000000FEDA0000 - 00000000FEDA0FFF]	Motherboard resources





















































-  [00000000FEDA1000 - 00000000FEDA1FFF] Motherboard resources
-  [00000000FEDC0000 - 00000000FEDC7FFF] Motherboard resources
-  [00000000FEE00000 - 00000000FEEFFFFFFF] Motherboard resources
-  [0000004000000000 - 000000400FFFFFFF] Intel(R) UHD Graphics 730
-  [0000004000000000 - 000000400FFFFFFF] Intel(R) UHD Graphics 770
-  [0000004000000000 - 000000400FFFFFFF] Intel(R) UHD Graphics 770
-  [0000006100000000 - 00000061007FFFFFFF] PCI Express Upstream Switch Port
-  [0000006100000000 - 00000061007FFFFFFF] PCI Express Upstream Switch Port
-  [0000006100000000 - 00000061007FFFFFFF] PCI Express Upstream Switch Port
-  [0000006100900000 - 00000061012FFFFFFF] Intel(R) PCI Express Root Port #9 - 7AB0
-  [0000006101300000 - 0000006101CFFFFFFF] Intel(R) PCI Express Root Port #1 - 7AB8
-  [0000006102000000 - 0000006102FFFFFFF] Intel(R) UHD Graphics 730
-  [0000006102000000 - 0000006102FFFFFFF] Intel(R) UHD Graphics 770
-  [0000006102000000 - 0000006102FFFFFFF] Intel(R) UHD Graphics 770
-  [0000006103100000 - 000000610310FFFFFF] Intel(R) USB 3.20 eXtensible Host Controller - 1.20 (Microsoft)
-  [0000006103118000 - 00000061031180FF] Intel(R) SMBus - 7AA3
-  [0000007FFFEF9000 - 0000007FFFEF9FFF] Intel(R) Serial IO I2C Host Controller - 7AFC
-  [0000007FFFEFA000 - 0000007FFFEFAFFF] Intel(R) Management Engine Interface #1
-  [0000007FFFEFB000 - 0000007FFFEFBFFF] Intel(R) Serial IO I2C Host Controller - 7ACC
-  [0000007FFFEFC000 - 0000007FFFEFFFFF] High Definition Audio Controller
-  [0000007FFFEF0000 - 0000007FFFEFFFFF] High Definition Audio Controller





















































A.3 Large Memory





















































- Large Memory
 - [0000004000000000 - 0000007FFFFFFFFF] PCI Express Root Complex
 - [0000006000000000 - 00000060FFFFFFFFF] Intel(R) Arc(TM) A350M Graphics
 - [0000006000000000 - 00000060FFFFFFFFF] Intel(R) Arc(TM) A350M Graphics
 - [0000006000000000 - 00000060FFFFFFFFF] Intel(R) Arc(TM) A350M Graphics
 - [0000006000000000 - 00000060FFFFFFFFF] PCI Express Downstream Switch Port
 - [0000006000000000 - 00000060FFFFFFFFF] PCI Express Downstream Switch Port
 - [0000006000000000 - 00000060FFFFFFFFF] PCI Express Downstream Switch Port
 - [0000006000000000 - 00000060FFFFFFFFF] PCI Express Upstream Switch Port
 - [0000006000000000 - 00000060FFFFFFFFF] PCI Express Upstream Switch Port
 - [0000006000000000 - 00000060FFFFFFFFF] PCI Express Upstream Switch Port
 - [0000006000000000 - 00000061007FFFFF] Intel(R) PCIe RC 010 G5 - A70D
 - [0000006000000000 - 00000061007FFFFF] PCI-to-PCI Bridge
 - [0000006000000000 - 00000061007FFFFF] PCI-to-PCI Bridge





















































A.4 IRQ Mapping Chart





















































Interrupt request (IRQ)	
(ISA) 0x00000000 (00)	System timer
(ISA) 0x00000003 (03)	Communications Port (COM2)
(ISA) 0x00000004 (04)	Communications Port (COM1)
(ISA) 0x0000000B (11)	Communications Port (COM3)
(ISA) 0x0000000B (11)	Communications Port (COM4)
(ISA) 0x0000000E (14)	Intel(R) Serial IO GPIO Host Controller - INTC1056
(ISA) 0x00000037 (55)	Microsoft ACPI-Compliant System
(ISA) 0x00000038 (56)	Microsoft ACPI-Compliant System
(ISA) 0x00000039 (57)	Microsoft ACPI-Compliant System
(ISA) 0x0000003A (58)	Microsoft ACPI-Compliant System
(ISA) 0x0000003B (59)	Microsoft ACPI-Compliant System
(ISA) 0x0000003C (60)	Microsoft ACPI-Compliant System
(ISA) 0x0000003D (61)	Microsoft ACPI-Compliant System
(ISA) 0x0000003E (62)	Microsoft ACPI-Compliant System
(ISA) 0x0000003F (63)	Microsoft ACPI-Compliant System
(ISA) 0x00000040 (64)	Microsoft ACPI-Compliant System
(ISA) 0x00000041 (65)	Microsoft ACPI-Compliant System
(ISA) 0x00000042 (66)	Microsoft ACPI-Compliant System
(ISA) 0x00000043 (67)	Microsoft ACPI-Compliant System
(ISA) 0x00000044 (68)	Microsoft ACPI-Compliant System
(ISA) 0x00000045 (69)	Microsoft ACPI-Compliant System
(ISA) 0x00000046 (70)	Microsoft ACPI-Compliant System
(ISA) 0x00000047 (71)	Microsoft ACPI-Compliant System
(ISA) 0x00000048 (72)	Microsoft ACPI-Compliant System
(ISA) 0x00000049 (73)	Microsoft ACPI-Compliant System
(ISA) 0x0000004A (74)	Microsoft ACPI-Compliant System
(ISA) 0x0000004B (75)	Microsoft ACPI-Compliant System
(ISA) 0x0000004C (76)	Microsoft ACPI-Compliant System
(ISA) 0x0000004D (77)	Microsoft ACPI-Compliant System
(ISA) 0x0000004E (78)	Microsoft ACPI-Compliant System
(ISA) 0x0000004F (79)	Microsoft ACPI-Compliant System
(ISA) 0x00000050 (80)	Microsoft ACPI-Compliant System
(ISA) 0x00000051 (81)	Microsoft ACPI-Compliant System
(ISA) 0x00000052 (82)	Microsoft ACPI-Compliant System
(ISA) 0x00000053 (83)	Microsoft ACPI-Compliant System
(ISA) 0x00000054 (84)	Microsoft ACPI-Compliant System
(ISA) 0x00000055 (85)	Microsoft ACPI-Compliant System
(ISA) 0x00000056 (86)	Microsoft ACPI-Compliant System
(ISA) 0x00000057 (87)	Microsoft ACPI-Compliant System
(ISA) 0x00000058 (88)	Microsoft ACPI-Compliant System
(ISA) 0x00000059 (89)	Microsoft ACPI-Compliant System
(ISA) 0x0000005A (90)	Microsoft ACPI-Compliant System
(ISA) 0x0000005B (91)	Microsoft ACPI-Compliant System
(ISA) 0x0000005C (92)	Microsoft ACPI-Compliant System
(ISA) 0x0000005D (93)	Microsoft ACPI-Compliant System
(ISA) 0x0000005E (94)	Microsoft ACPI-Compliant System
(ISA) 0x0000005F (95)	Microsoft ACPI-Compliant System
(ISA) 0x00000060 (96)	Microsoft ACPI-Compliant System
(ISA) 0x00000061 (97)	Microsoft ACPI-Compliant System
(ISA) 0x00000062 (98)	Microsoft ACPI-Compliant System
(ISA) 0x00000063 (99)	Microsoft ACPI-Compliant System

 (ISA) 0x00000064 (100)	Microsoft ACPI-Compliant System
 (ISA) 0x00000065 (101)	Microsoft ACPI-Compliant System
 (ISA) 0x00000066 (102)	Microsoft ACPI-Compliant System
 (ISA) 0x00000067 (103)	Microsoft ACPI-Compliant System
 (ISA) 0x00000068 (104)	Microsoft ACPI-Compliant System
 (ISA) 0x00000069 (105)	Microsoft ACPI-Compliant System
 (ISA) 0x0000006A (106)	Microsoft ACPI-Compliant System
 (ISA) 0x0000006B (107)	Microsoft ACPI-Compliant System
 (ISA) 0x0000006C (108)	Microsoft ACPI-Compliant System
 (ISA) 0x0000006D (109)	Microsoft ACPI-Compliant System
 (ISA) 0x0000006D (109)	Trusted Platform Module 2.0
 (ISA) 0x0000006E (110)	Microsoft ACPI-Compliant System
 (ISA) 0x0000006F (111)	Microsoft ACPI-Compliant System
 (ISA) 0x00000070 (112)	Microsoft ACPI-Compliant System
 (ISA) 0x00000071 (113)	Microsoft ACPI-Compliant System
 (ISA) 0x00000072 (114)	Microsoft ACPI-Compliant System
 (ISA) 0x00000073 (115)	Microsoft ACPI-Compliant System
 (ISA) 0x00000074 (116)	Microsoft ACPI-Compliant System
 (ISA) 0x00000075 (117)	Microsoft ACPI-Compliant System
 (ISA) 0x00000076 (118)	Microsoft ACPI-Compliant System
 (ISA) 0x00000077 (119)	Microsoft ACPI-Compliant System
 (ISA) 0x00000078 (120)	Microsoft ACPI-Compliant System
 (ISA) 0x00000079 (121)	Microsoft ACPI-Compliant System
 (ISA) 0x0000007A (122)	Microsoft ACPI-Compliant System
 (ISA) 0x0000007B (123)	Microsoft ACPI-Compliant System
 (ISA) 0x0000007C (124)	Microsoft ACPI-Compliant System
 (ISA) 0x0000007D (125)	Microsoft ACPI-Compliant System
 (ISA) 0x0000007E (126)	Microsoft ACPI-Compliant System
 (ISA) 0x0000007F (127)	Microsoft ACPI-Compliant System
 (ISA) 0x00000080 (128)	Microsoft ACPI-Compliant System
 (ISA) 0x00000081 (129)	Microsoft ACPI-Compliant System
 (ISA) 0x00000082 (130)	Microsoft ACPI-Compliant System
 (ISA) 0x00000083 (131)	Microsoft ACPI-Compliant System
 (ISA) 0x00000084 (132)	Microsoft ACPI-Compliant System
 (ISA) 0x00000085 (133)	Microsoft ACPI-Compliant System
 (ISA) 0x00000086 (134)	Microsoft ACPI-Compliant System
 (ISA) 0x00000087 (135)	Microsoft ACPI-Compliant System
 (ISA) 0x00000088 (136)	Microsoft ACPI-Compliant System
 (ISA) 0x00000089 (137)	Microsoft ACPI-Compliant System
 (ISA) 0x0000008A (138)	Microsoft ACPI-Compliant System
 (ISA) 0x0000008B (139)	Microsoft ACPI-Compliant System
 (ISA) 0x0000008C (140)	Microsoft ACPI-Compliant System
 (ISA) 0x0000008D (141)	Microsoft ACPI-Compliant System
 (ISA) 0x0000008E (142)	Microsoft ACPI-Compliant System
 (ISA) 0x0000008F (143)	Microsoft ACPI-Compliant System
 (ISA) 0x00000090 (144)	Microsoft ACPI-Compliant System
 (ISA) 0x00000091 (145)	Microsoft ACPI-Compliant System
 (ISA) 0x00000092 (146)	Microsoft ACPI-Compliant System
 (ISA) 0x00000093 (147)	Microsoft ACPI-Compliant System
 (ISA) 0x00000094 (148)	Microsoft ACPI-Compliant System
 (ISA) 0x00000095 (149)	Microsoft ACPI-Compliant System
 (ISA) 0x00000096 (150)	Microsoft ACPI-Compliant System































 (ISA) 0x00000097 (151)	Microsoft ACPI-Compliant System
 (ISA) 0x00000098 (152)	Microsoft ACPI-Compliant System
 (ISA) 0x00000099 (153)	Microsoft ACPI-Compliant System
 (ISA) 0x0000009A (154)	Microsoft ACPI-Compliant System
 (ISA) 0x0000009B (155)	Microsoft ACPI-Compliant System
 (ISA) 0x0000009C (156)	Microsoft ACPI-Compliant System
 (ISA) 0x0000009D (157)	Microsoft ACPI-Compliant System
 (ISA) 0x0000009E (158)	Microsoft ACPI-Compliant System
 (ISA) 0x0000009F (159)	Microsoft ACPI-Compliant System
 (ISA) 0x000000A0 (160)	Microsoft ACPI-Compliant System
 (ISA) 0x000000A1 (161)	Microsoft ACPI-Compliant System
 (ISA) 0x000000A2 (162)	Microsoft ACPI-Compliant System
 (ISA) 0x000000A3 (163)	Microsoft ACPI-Compliant System
 (ISA) 0x000000A4 (164)	Microsoft ACPI-Compliant System
 (ISA) 0x000000A5 (165)	Microsoft ACPI-Compliant System
 (ISA) 0x000000A6 (166)	Microsoft ACPI-Compliant System
 (ISA) 0x000000A7 (167)	Microsoft ACPI-Compliant System
 (ISA) 0x000000A8 (168)	Microsoft ACPI-Compliant System
 (ISA) 0x000000A9 (169)	Microsoft ACPI-Compliant System
 (ISA) 0x000000AA (170)	Microsoft ACPI-Compliant System
 (ISA) 0x000000AB (171)	Microsoft ACPI-Compliant System
 (ISA) 0x000000AC (172)	Microsoft ACPI-Compliant System
 (ISA) 0x000000AD (173)	Microsoft ACPI-Compliant System
 (ISA) 0x000000AE (174)	Microsoft ACPI-Compliant System
 (ISA) 0x000000AF (175)	Microsoft ACPI-Compliant System
 (ISA) 0x000000B0 (176)	Microsoft ACPI-Compliant System
 (ISA) 0x000000B1 (177)	Microsoft ACPI-Compliant System
 (ISA) 0x000000B2 (178)	Microsoft ACPI-Compliant System
 (ISA) 0x000000B3 (179)	Microsoft ACPI-Compliant System
 (ISA) 0x000000B4 (180)	Microsoft ACPI-Compliant System
 (ISA) 0x000000B5 (181)	Microsoft ACPI-Compliant System
 (ISA) 0x000000B6 (182)	Microsoft ACPI-Compliant System
 (ISA) 0x000000B7 (183)	Microsoft ACPI-Compliant System
 (ISA) 0x000000B8 (184)	Microsoft ACPI-Compliant System
 (ISA) 0x000000B9 (185)	Microsoft ACPI-Compliant System
 (ISA) 0x000000BA (186)	Microsoft ACPI-Compliant System
 (ISA) 0x000000BB (187)	Microsoft ACPI-Compliant System
 (ISA) 0x000000BC (188)	Microsoft ACPI-Compliant System
 (ISA) 0x000000BD (189)	Microsoft ACPI-Compliant System
 (ISA) 0x000000BE (190)	Microsoft ACPI-Compliant System
 (ISA) 0x000000BF (191)	Microsoft ACPI-Compliant System
 (ISA) 0x000000C0 (192)	Microsoft ACPI-Compliant System
 (ISA) 0x000000C1 (193)	Microsoft ACPI-Compliant System
 (ISA) 0x000000C2 (194)	Microsoft ACPI-Compliant System
 (ISA) 0x000000C3 (195)	Microsoft ACPI-Compliant System
 (ISA) 0x000000C4 (196)	Microsoft ACPI-Compliant System
 (ISA) 0x000000C5 (197)	Microsoft ACPI-Compliant System
 (ISA) 0x000000C6 (198)	Microsoft ACPI-Compliant System
 (ISA) 0x000000C7 (199)	Microsoft ACPI-Compliant System
 (ISA) 0x000000C8 (200)	Microsoft ACPI-Compliant System
 (ISA) 0x000000C9 (201)	Microsoft ACPI-Compliant System
 (ISA) 0x000000CA (202)	Microsoft ACPI-Compliant System

 (ISA) 0x000000CB (203)	Microsoft ACPI-Compliant System
 (ISA) 0x000000CC (204)	Microsoft ACPI-Compliant System
 (ISA) 0x00000100 (256)	Microsoft ACPI-Compliant System
 (ISA) 0x00000101 (257)	Microsoft ACPI-Compliant System
 (ISA) 0x00000102 (258)	Microsoft ACPI-Compliant System
 (ISA) 0x00000103 (259)	Microsoft ACPI-Compliant System
 (ISA) 0x00000104 (260)	Microsoft ACPI-Compliant System
 (ISA) 0x00000105 (261)	Microsoft ACPI-Compliant System
 (ISA) 0x00000106 (262)	Microsoft ACPI-Compliant System
 (ISA) 0x00000107 (263)	Microsoft ACPI-Compliant System
 (ISA) 0x00000108 (264)	Microsoft ACPI-Compliant System
 (ISA) 0x00000109 (265)	Microsoft ACPI-Compliant System
 (ISA) 0x0000010A (266)	Microsoft ACPI-Compliant System
 (ISA) 0x0000010B (267)	Microsoft ACPI-Compliant System
 (ISA) 0x0000010C (268)	Microsoft ACPI-Compliant System
 (ISA) 0x0000010D (269)	Microsoft ACPI-Compliant System
 (ISA) 0x0000010E (270)	Microsoft ACPI-Compliant System
 (ISA) 0x0000010F (271)	Microsoft ACPI-Compliant System
 (ISA) 0x00000110 (272)	Microsoft ACPI-Compliant System
 (ISA) 0x00000111 (273)	Microsoft ACPI-Compliant System
 (ISA) 0x00000112 (274)	Microsoft ACPI-Compliant System
 (ISA) 0x00000113 (275)	Microsoft ACPI-Compliant System
 (ISA) 0x00000114 (276)	Microsoft ACPI-Compliant System
 (ISA) 0x00000115 (277)	Microsoft ACPI-Compliant System
 (ISA) 0x00000116 (278)	Microsoft ACPI-Compliant System
 (ISA) 0x00000117 (279)	Microsoft ACPI-Compliant System
 (ISA) 0x00000118 (280)	Microsoft ACPI-Compliant System
 (ISA) 0x00000119 (281)	Microsoft ACPI-Compliant System
 (ISA) 0x0000011A (282)	Microsoft ACPI-Compliant System
 (ISA) 0x0000011B (283)	Microsoft ACPI-Compliant System
 (ISA) 0x0000011C (284)	Microsoft ACPI-Compliant System
 (ISA) 0x0000011D (285)	Microsoft ACPI-Compliant System
 (ISA) 0x0000011E (286)	Microsoft ACPI-Compliant System
 (ISA) 0x0000011F (287)	Microsoft ACPI-Compliant System
 (ISA) 0x00000120 (288)	Microsoft ACPI-Compliant System
 (ISA) 0x00000121 (289)	Microsoft ACPI-Compliant System
 (ISA) 0x00000122 (290)	Microsoft ACPI-Compliant System
 (ISA) 0x00000123 (291)	Microsoft ACPI-Compliant System
 (ISA) 0x00000124 (292)	Microsoft ACPI-Compliant System
 (ISA) 0x00000125 (293)	Microsoft ACPI-Compliant System
 (ISA) 0x00000126 (294)	Microsoft ACPI-Compliant System
 (ISA) 0x00000127 (295)	Microsoft ACPI-Compliant System
 (ISA) 0x00000128 (296)	Microsoft ACPI-Compliant System
 (ISA) 0x00000129 (297)	Microsoft ACPI-Compliant System
 (ISA) 0x0000012A (298)	Microsoft ACPI-Compliant System
 (ISA) 0x0000012B (299)	Microsoft ACPI-Compliant System
 (ISA) 0x0000012C (300)	Microsoft ACPI-Compliant System
 (ISA) 0x0000012D (301)	Microsoft ACPI-Compliant System
 (ISA) 0x0000012E (302)	Microsoft ACPI-Compliant System
 (ISA) 0x0000012F (303)	Microsoft ACPI-Compliant System
 (ISA) 0x00000130 (304)	Microsoft ACPI-Compliant System
 (ISA) 0x00000131 (305)	Microsoft ACPI-Compliant System

 (ISA) 0x00000132 (306)	Microsoft ACPI-Compliant System
 (ISA) 0x00000133 (307)	Microsoft ACPI-Compliant System
 (ISA) 0x00000134 (308)	Microsoft ACPI-Compliant System
 (ISA) 0x00000135 (309)	Microsoft ACPI-Compliant System
 (ISA) 0x00000136 (310)	Microsoft ACPI-Compliant System
 (ISA) 0x00000137 (311)	Microsoft ACPI-Compliant System
 (ISA) 0x00000138 (312)	Microsoft ACPI-Compliant System
 (ISA) 0x00000139 (313)	Microsoft ACPI-Compliant System
 (ISA) 0x0000013A (314)	Microsoft ACPI-Compliant System
 (ISA) 0x0000013B (315)	Microsoft ACPI-Compliant System
 (ISA) 0x0000013C (316)	Microsoft ACPI-Compliant System
 (ISA) 0x0000013D (317)	Microsoft ACPI-Compliant System
 (ISA) 0x0000013E (318)	Microsoft ACPI-Compliant System
 (ISA) 0x0000013F (319)	Microsoft ACPI-Compliant System
 (ISA) 0x00000140 (320)	Microsoft ACPI-Compliant System
 (ISA) 0x00000141 (321)	Microsoft ACPI-Compliant System
 (ISA) 0x00000142 (322)	Microsoft ACPI-Compliant System
 (ISA) 0x00000143 (323)	Microsoft ACPI-Compliant System
 (ISA) 0x00000144 (324)	Microsoft ACPI-Compliant System
 (ISA) 0x00000145 (325)	Microsoft ACPI-Compliant System
 (ISA) 0x00000146 (326)	Microsoft ACPI-Compliant System
 (ISA) 0x00000147 (327)	Microsoft ACPI-Compliant System
 (ISA) 0x00000148 (328)	Microsoft ACPI-Compliant System
 (ISA) 0x00000149 (329)	Microsoft ACPI-Compliant System
 (ISA) 0x0000014A (330)	Microsoft ACPI-Compliant System
 (ISA) 0x0000014B (331)	Microsoft ACPI-Compliant System
 (ISA) 0x0000014C (332)	Microsoft ACPI-Compliant System
 (ISA) 0x0000014D (333)	Microsoft ACPI-Compliant System
 (ISA) 0x0000014E (334)	Microsoft ACPI-Compliant System
 (ISA) 0x0000014F (335)	Microsoft ACPI-Compliant System
 (ISA) 0x00000150 (336)	Microsoft ACPI-Compliant System
 (ISA) 0x00000151 (337)	Microsoft ACPI-Compliant System
 (ISA) 0x00000152 (338)	Microsoft ACPI-Compliant System
 (ISA) 0x00000153 (339)	Microsoft ACPI-Compliant System
 (ISA) 0x00000154 (340)	Microsoft ACPI-Compliant System
 (ISA) 0x00000155 (341)	Microsoft ACPI-Compliant System
 (ISA) 0x00000156 (342)	Microsoft ACPI-Compliant System
 (ISA) 0x00000157 (343)	Microsoft ACPI-Compliant System
 (ISA) 0x00000158 (344)	Microsoft ACPI-Compliant System
 (ISA) 0x00000159 (345)	Microsoft ACPI-Compliant System
 (ISA) 0x0000015A (346)	Microsoft ACPI-Compliant System
 (ISA) 0x0000015B (347)	Microsoft ACPI-Compliant System
 (ISA) 0x0000015C (348)	Microsoft ACPI-Compliant System
 (ISA) 0x0000015D (349)	Microsoft ACPI-Compliant System
 (ISA) 0x0000015E (350)	Microsoft ACPI-Compliant System
 (ISA) 0x0000015F (351)	Microsoft ACPI-Compliant System
 (ISA) 0x00000160 (352)	Microsoft ACPI-Compliant System
 (ISA) 0x00000161 (353)	Microsoft ACPI-Compliant System
 (ISA) 0x00000162 (354)	Microsoft ACPI-Compliant System
 (ISA) 0x00000163 (355)	Microsoft ACPI-Compliant System
 (ISA) 0x00000164 (356)	Microsoft ACPI-Compliant System
 (ISA) 0x00000165 (357)	Microsoft ACPI-Compliant System

 (ISA) 0x0000166 (358)	Microsoft ACPI-Compliant System
 (ISA) 0x0000167 (359)	Microsoft ACPI-Compliant System
 (ISA) 0x0000168 (360)	Microsoft ACPI-Compliant System
 (ISA) 0x0000169 (361)	Microsoft ACPI-Compliant System
 (ISA) 0x000016A (362)	Microsoft ACPI-Compliant System
 (ISA) 0x000016B (363)	Microsoft ACPI-Compliant System
 (ISA) 0x000016C (364)	Microsoft ACPI-Compliant System
 (ISA) 0x000016D (365)	Microsoft ACPI-Compliant System
 (ISA) 0x000016E (366)	Microsoft ACPI-Compliant System
 (ISA) 0x000016F (367)	Microsoft ACPI-Compliant System
 (ISA) 0x0000170 (368)	Microsoft ACPI-Compliant System
 (ISA) 0x0000171 (369)	Microsoft ACPI-Compliant System
 (ISA) 0x0000172 (370)	Microsoft ACPI-Compliant System
 (ISA) 0x0000173 (371)	Microsoft ACPI-Compliant System
 (ISA) 0x0000174 (372)	Microsoft ACPI-Compliant System
 (ISA) 0x0000175 (373)	Microsoft ACPI-Compliant System
 (ISA) 0x0000176 (374)	Microsoft ACPI-Compliant System
 (ISA) 0x0000177 (375)	Microsoft ACPI-Compliant System
 (ISA) 0x0000178 (376)	Microsoft ACPI-Compliant System
 (ISA) 0x0000179 (377)	Microsoft ACPI-Compliant System
 (ISA) 0x000017A (378)	Microsoft ACPI-Compliant System
 (ISA) 0x000017B (379)	Microsoft ACPI-Compliant System
 (ISA) 0x000017C (380)	Microsoft ACPI-Compliant System
 (ISA) 0x000017D (381)	Microsoft ACPI-Compliant System
 (ISA) 0x000017E (382)	Microsoft ACPI-Compliant System
 (ISA) 0x000017F (383)	Microsoft ACPI-Compliant System
 (ISA) 0x0000180 (384)	Microsoft ACPI-Compliant System
 (ISA) 0x0000181 (385)	Microsoft ACPI-Compliant System
 (ISA) 0x0000182 (386)	Microsoft ACPI-Compliant System
 (ISA) 0x0000183 (387)	Microsoft ACPI-Compliant System
 (ISA) 0x0000184 (388)	Microsoft ACPI-Compliant System
 (ISA) 0x0000185 (389)	Microsoft ACPI-Compliant System
 (ISA) 0x0000186 (390)	Microsoft ACPI-Compliant System
 (ISA) 0x0000187 (391)	Microsoft ACPI-Compliant System
 (ISA) 0x0000188 (392)	Microsoft ACPI-Compliant System
 (ISA) 0x0000189 (393)	Microsoft ACPI-Compliant System
 (ISA) 0x000018A (394)	Microsoft ACPI-Compliant System
 (ISA) 0x000018B (395)	Microsoft ACPI-Compliant System
 (ISA) 0x000018C (396)	Microsoft ACPI-Compliant System
 (ISA) 0x000018D (397)	Microsoft ACPI-Compliant System
 (ISA) 0x000018E (398)	Microsoft ACPI-Compliant System
 (ISA) 0x000018F (399)	Microsoft ACPI-Compliant System
 (ISA) 0x0000190 (400)	Microsoft ACPI-Compliant System
 (ISA) 0x0000191 (401)	Microsoft ACPI-Compliant System
 (ISA) 0x0000192 (402)	Microsoft ACPI-Compliant System
 (ISA) 0x0000193 (403)	Microsoft ACPI-Compliant System
 (ISA) 0x0000194 (404)	Microsoft ACPI-Compliant System
 (ISA) 0x0000195 (405)	Microsoft ACPI-Compliant System
 (ISA) 0x0000196 (406)	Microsoft ACPI-Compliant System
 (ISA) 0x0000197 (407)	Microsoft ACPI-Compliant System
 (ISA) 0x0000198 (408)	Microsoft ACPI-Compliant System
 (ISA) 0x0000199 (409)	Microsoft ACPI-Compliant System

(ISA) 0x000001F1 (497)	Microsoft ACPI-Compliant System
(ISA) 0x000001F2 (498)	Microsoft ACPI-Compliant System
(ISA) 0x000001F3 (499)	Microsoft ACPI-Compliant System
(ISA) 0x000001F4 (500)	Microsoft ACPI-Compliant System
(ISA) 0x000001F5 (501)	Microsoft ACPI-Compliant System
(ISA) 0x000001F6 (502)	Microsoft ACPI-Compliant System
(ISA) 0x000001F7 (503)	Microsoft ACPI-Compliant System
(ISA) 0x000001F8 (504)	Microsoft ACPI-Compliant System
(ISA) 0x000001F9 (505)	Microsoft ACPI-Compliant System
(ISA) 0x000001FA (506)	Microsoft ACPI-Compliant System
(ISA) 0x000001FB (507)	Microsoft ACPI-Compliant System
(ISA) 0x000001FC (508)	Microsoft ACPI-Compliant System
(ISA) 0x000001FD (509)	Microsoft ACPI-Compliant System
(ISA) 0x000001FE (510)	Microsoft ACPI-Compliant System
(ISA) 0x000001FF (511)	Microsoft ACPI-Compliant System
(PCI) 0x00000011 (17)	High Definition Audio Controller
(PCI) 0x00000013 (19)	Intel(R) Active Management Technology - SOL (COM)
(PCI) 0x0000001B (27)	Intel(R) Serial IO I2C Host Controller - 7ACC
(PCI) 0x0000001F (31)	Intel(R) Serial IO I2C Host Controller - 7AFC
(PCI) 0xFFFFF1C1 (-63)	Intel(R) Management Engine Interface #1
(PCI) 0xFFFFF1C2 (-62)	Intel(R) Ethernet Controller I226-V #3
(PCI) 0xFFFFF1C3 (-61)	Intel(R) Ethernet Controller I226-V #3
(PCI) 0xFFFFF1C4 (-60)	Intel(R) Ethernet Controller I226-V #3
(PCI) 0xFFFFF1C5 (-59)	Intel(R) Ethernet Controller I226-V #3
(PCI) 0xFFFFF1C6 (-58)	Intel(R) Ethernet Controller I226-V #3
(PCI) 0xFFFFF1C7 (-57)	Intel(R) Ethernet Controller I226-V #3
(PCI) 0xFFFFF1C8 (-56)	Intel(R) Ethernet Controller I226-V #3
(PCI) 0xFFFFF1C9 (-55)	Intel(R) Ethernet Controller I226-V #3
(PCI) 0xFFFFF1CA (-54)	Intel(R) Ethernet Controller I226-V #3
(PCI) 0xFFFFF1CB (-53)	Intel(R) Ethernet Controller I226-V #3
(PCI) 0xFFFFF1CC (-52)	Intel(R) Ethernet Controller I226-V #3
(PCI) 0xFFFFF1CD (-51)	Intel(R) Ethernet Controller I226-V #3
(PCI) 0xFFFFF1CE (-50)	Intel(R) Ethernet Controller I226-V #3
(PCI) 0xFFFFF1CF (-49)	Intel(R) Ethernet Controller I226-V #2
(PCI) 0xFFFFF1D0 (-48)	Intel(R) Ethernet Controller I226-V #2
(PCI) 0xFFFFF1D1 (-47)	Intel(R) Ethernet Controller I226-V #2
(PCI) 0xFFFFF1D2 (-46)	Intel(R) Ethernet Controller I226-V #2
(PCI) 0xFFFFF1D3 (-45)	Intel(R) Ethernet Controller I226-V #2
(PCI) 0xFFFFF1D4 (-44)	Intel(R) Ethernet Controller I226-V #2
(PCI) 0xFFFFF1D5 (-43)	Intel(R) Ethernet Controller I226-V #2
(PCI) 0xFFFFF1D6 (-42)	Intel(R) Ethernet Controller I226-V #2
(PCI) 0xFFFFF1D7 (-41)	Intel(R) Ethernet Controller I226-V #2
(PCI) 0xFFFFF1D8 (-40)	Intel(R) Ethernet Controller I226-V #2
(PCI) 0xFFFFF1D9 (-39)	Intel(R) Ethernet Controller I226-V #2
(PCI) 0xFFFFF1DA (-38)	Intel(R) Ethernet Controller I226-V #2
(PCI) 0xFFFFF1DB (-37)	Intel(R) Ethernet Controller I226-V #2
(PCI) 0xFFFFF1DC (-36)	Intel(R) Ethernet Controller I226-V
(PCI) 0xFFFFF1DD (-35)	Intel(R) Ethernet Controller I226-V
(PCI) 0xFFFFF1DE (-34)	Intel(R) Ethernet Controller I226-V
(PCI) 0xFFFFF1DF (-33)	Intel(R) Ethernet Controller I226-V

	(PCI) 0xFFFFFFFF1 (-31)	Intel(R) Ethernet Controller I226-V
	(PCI) 0xFFFFFFFF2 (-30)	Intel(R) Ethernet Controller I226-V
	(PCI) 0xFFFFFFFF3 (-29)	Intel(R) Ethernet Controller I226-V
	(PCI) 0xFFFFFFFF4 (-28)	Intel(R) Ethernet Controller I226-V
	(PCI) 0xFFFFFFFF5 (-27)	Intel(R) Ethernet Controller I226-V
	(PCI) 0xFFFFFFFF6 (-26)	Intel(R) Ethernet Controller I226-V
	(PCI) 0xFFFFFFFF7 (-25)	Intel(R) Ethernet Controller I226-V
	(PCI) 0xFFFFFFFF8 (-24)	Intel(R) Ethernet Controller I226-V
	(PCI) 0xFFFFFFFF9 (-23)	High Definition Audio Controller
	(PCI) 0xFFFFFFFFEA (-22)	Intel(R) USB 3.20 eXtensible Host Controller - 1.20 (Microsoft)
	(PCI) 0xFFFFFFFFEB (-21)	Intel(R) UHD Graphics 770
	(PCI) 0xFFFFFFFFEC (-20)	Intel(R) Arc(TM) A350M Graphics
	(PCI) 0xFFFFFFFFED (-19)	Intel(R) Ethernet Connection (17) I219-LM
	(PCI) 0xFFFFFFFFEE (-18)	Standard NVM Express Controller
	(PCI) 0xFFFFFFFFEF (-17)	Standard NVM Express Controller
	(PCI) 0xFFFFFFFFF0 (-16)	Standard NVM Express Controller
	(PCI) 0xFFFFFFFFF1 (-15)	Standard NVM Express Controller
	(PCI) 0xFFFFFFFFF2 (-14)	Standard NVM Express Controller
	(PCI) 0xFFFFFFFFF3 (-13)	Standard NVM Express Controller
	(PCI) 0xFFFFFFFFF4 (-12)	Standard NVM Express Controller
	(PCI) 0xFFFFFFFFF5 (-11)	Standard NVM Express Controller
	(PCI) 0xFFFFFFFFF6 (-10)	Standard NVM Express Controller
	(PCI) 0xFFFFFFFFF7 (-9)	Standard NVM Express Controller
	(PCI) 0xFFFFFFFFF8 (-8)	Standard NVM Express Controller
	(PCI) 0xFFFFFFFFF9 (-7)	Standard NVM Express Controller
	(PCI) 0xFFFFFFFFFA (-6)	Standard NVM Express Controller
	(PCI) 0xFFFFFFFFFB (-5)	Standard NVM Express Controller
	(PCI) 0xFFFFFFFFFC (-4)	Standard NVM Express Controller
	(PCI) 0xFFFFFFFFFD (-3)	Standard NVM Express Controller
	(PCI) 0xFFFFFFFFFE (-2)	Standard SATA AHCI Controller

Appendix B

Mating Connectors and Cables

B.1 Mating Connectors and Cables

Label	Function	Mating Connector		Available Cable	Cable P/N
		Vendor	Model no		
CN1 CN2	GPIO	DINKLE	ESC250V-10P-BK	N/A	N/A
CN3 CN4 CN9	4-pin Smart Fan	Molex	4705410s00	N/A	N/A
CN6	Front Panel	JST	SHR-10V-S-B	Front Panel	170X000603
CN8	External +5VSB Power Input & PS_ON#	JST	XHP-3	Power Cable	170215020G
CN15 CN16 CN21 CN22	COM Port	Molex	51021-0900	COM port Cable	1701090140
CN17	SATA Connector	Molex	887505318	SATA Cable	170X000085
CN18	eSPI/I2C/SMBus	JST	SHR-05V-S-B	eSPI/I2C/SMBus	170X000743
CN20	Port 80 Debug Port	JST	SHR-10V-S-B	Port 80 Debug Port Cable	1703100133
CN23	+5V Output for SATA HDD	JST	PHR-2	SATA Power Cable	1702150155
CN29	RTC Battery	Molex	51021-0200	Battery Cable	175011301C
CN33	DC IN	DINKEL	5ESDVM-04P	DC IN Cable	170X001021
CN26	Audio Connector	ACES	50247-012H0H0-001	AUDIO Cable	170X001240