



HPC-ARHm

COM HPC Size Mini

User's Manual 3rd Ed

Copyright Notice

This document is copyrighted, 2026. All rights are reserved. The original manufacturer reserves the right to make improvements to the products described in this manual at any time without notice.

No part of this manual may be reproduced, copied, translated, or transmitted in any form or by any means without the prior written permission of the original manufacturer. Information provided in this manual is intended to be accurate and reliable. However, the original manufacturer assumes no responsibility for its use, or for any infringements upon the rights of third parties that may result from its use.

The material in this document is for product information only and is subject to change without notice. While reasonable efforts have been made in the preparation of this document to assure its accuracy, AAEMON assumes no liabilities resulting from errors or omissions in this document, or from the use of the information contained herein.

AAEMON reserves the right to make changes in the product design without notice to its users.

Acknowledgements

All other products' name or trademarks are properties of their respective owners.

- Microsoft Windows is a registered trademark of Microsoft Corp.
- Intel® is a registered trademark of Intel Corporation
- Core™ and Arc™ are trademarks of Intel Corporation
- IBM, PC/AT, PS/2, and VGA are trademarks of International Business Machines Corporation.
- Linux® is a registered trademark of Linus Torvalds in the United States and other countries
- Ubuntu and Canonical are registered trademarks of Canonical Ltd.

All other product names or trademarks are properties of their respective owners.

Omission from this list does not imply any claim of ownership by the publisher of this document.

Packing List

Before setting up your product, please make sure the following items have been shipped:

Item	Quantity
● HPC-ARHm	1

If any of these items are missing or damaged, please contact your distributor or sales representative immediately.

About this Document

This User's Manual contains all the essential information, such as detailed descriptions and explanations on the product's hardware and software features (if any), its specifications, dimensions, jumper/connector settings/definitions, and driver installation instructions (if any), to facilitate users in setting up their product.

Users may refer to the product page at AAEON.com for the latest version of this document.

Safety Precautions

Please read the following safety instructions carefully. It is advised that you keep this manual for future references

1. All cautions and warnings on the device should be noted.
2. Make sure the power source matches the power rating of the device.
3. Position the power cord so that people cannot step on it. Do not place anything over the power cord.
4. Always completely disconnect the power before working on the system's hardware.
5. No connections should be made when the system is powered as a sudden rush of power may damage sensitive electronic components.
6. If the device is not to be used for a long time, disconnect it from the power supply to avoid damage by transient over-voltage.
7. Always disconnect this device from any AC supply before cleaning.
8. While cleaning, use a damp cloth instead of liquid or spray detergents.
9. Make sure the device is installed near a power outlet and is easily accessible.
10. Keep this device away from humidity.
11. Place the device on a solid surface during installation to prevent falls
12. Do not cover the openings on the device to ensure optimal heat dissipation.
13. Watch out for high temperatures when the system is running.
14. Do not touch the heat sink or heat spreader when the system is running
15. Never pour any liquid into the openings. This could cause fire or electric shock.
16. As most electronic components are sensitive to static electrical charge, be sure to ground yourself to prevent static charge when installing the internal components. Use a grounding wrist strap and contain all electronic components in any static-shielded containers.

17. If any of the following situations arises, please the contact our service personnel:
 - i. Damaged power cord or plug
 - ii. Liquid intrusion to the device
 - iii. Exposure to moisture
 - iv. Device is not working as expected or in a manner as described in this manual
 - v. The device is dropped or damaged
 - vi. Any obvious signs of damage displayed on the device
18. **DO NOT LEAVE THIS DEVICE IN AN UNCONTROLLED ENVIRONMENT WITH TEMPERATURES BEYOND THE DEVICE'S PERMITTED STORAGE TEMPERATURES (SEE CHAPTER 1) TO PREVENT DAMAGE.**

Warning!



This device complies with Part 15 FCC Rules. Operation is subject to the following two conditions: (1) this device may not cause harmful interference, and (2) this device must accept any interference received including interference that may cause undesired operation.

Caution:

There is a danger of explosion if the battery is incorrectly replaced. Replace only with the same or equivalent type recommended by the manufacturer. Dispose of used batteries according to the manufacturer's instructions and your local government's recycling or disposal directives.

Attention:

Il y a un risque d'explosion si la batterie est remplacée de façon incorrecte. Ne la remplacer qu'avec le même modèle ou équivalent recommandé par le constructeur. Recycler les batteries usées en accord avec les instructions du fabricant et les directives gouvernementales de recyclage.

产品中有毒有害物质或元素名称及含量

AAEON 主板/子板/背板

QQ04-381 Rev.A2

部件名称	有毒有害物质或元素					
	铅 (Pb)	汞 (Hg)	镉 (Cd)	六价铬 (Cr(VI))	多溴联苯 (PBB)	多溴二苯醚 (PBDE)
印刷电路板 及其电子组件	×	○	○	○	○	○
外部信号 连接器及线材	×	○	○	○	○	○

本表格依据 SJ/T 11364 的规定编制。

○：表示该有毒有害物质在该部件所有均质材料中的含量均在GB/T 26572标准规定的限量要求以下。

×：表示该有害物质的某一均质材料超出了GB/T 26572的限量要求，然而该部件仍符合欧盟指令2011/65/EU 的规范。

环保使用期限(EFUP (Environmental Friendly Use Period))：10年

备注：此产品所标示之环保使用期限，系指在一般正常使用状况下。

China RoHS Requirement (EN)

Name and content of hazardous substances in product

AAEON Main Board/Daughter Board/Backplane

QO4-381 Rev.A2

Part Name	Hazardous Substances					
	铅 (Pb)	汞 (Hg)	镉 (Cd)	六价铬 (Cr(VI))	多溴联苯 (PBB)	多溴二苯醚 (PBDE)
PCB Assemblies	×	○	○	○	○	○
Connector and Cable	×	○	○	○	○	○

The table is prepared in accordance with the provisions of SJ/T 11364.

○: Indicates that said hazardous substance contained in all of the homogenous materials for this product is below the limit requirement of GB/T 26572.

×: Indicates that said hazardous substance contained in at least one of the homogenous materials used for this part is above the limit requirement of GB/T 26572. But this product still be compliance with 2011/65/EU Directive (allowed with 2011/65/EU Annex III of RoHS exemption with number 6(c),7(a),7(c)-1).

EFUP (Environment Friendly Use Period) value: 10 years

Notes: This product defined period of use is under normal condition.

Table of Contents

Chapter 1 - Product Specifications	1
1.1 Specifications	2
1.2 Block Diagram	5
Chapter 2 – Hardware Information	6
2.1 Dimensions	7
2.2 Jumpers and Connectors.....	10
2.3 List of Connectors.....	11
2.3.1 SPI ROM FLASH (CN1).....	11
2.3.2 MIPI CSI CH1 (CN2)	12
2.3.3 MIPI CSI CH2 (CN3).....	13
2.3.4 Row A/B/C/D Connector (CN4).....	14
Chapter 3 - AMI BIOS Setup	21
3.1 System Test and Initialization	22
3.2 AMI BIOS Setup	23
3.3 Setup Submenu: Main.....	24
3.4 Setup Submenu: Advanced.....	25
3.4.1 Video BIOS Table Configuration	26
3.4.1.1 Boot Display Priority.....	27
3.4.1.2 Display Configuration	29
3.4.1.3 eDP Configuration.....	30
3.4.2 CPU Configuration	32
3.4.2.1 Efficient-Core Information	33
3.4.2.2 Performance-Core Information	34
3.4.3 Memory Configuration.....	35
3.4.4 On-Module H/W Monitor.....	36
3.4.5 PCH-FW Configuration.....	38

3.4.6	On-Module Configuration	39
3.4.7	Power Management.....	40
3.4.8	AAEON BIOS Robot	41
3.4.8.1	Device Detecting Configuration	43
3.4.8.2	Device #1 Detecting Configuration.....	44
3.4.9	AAEON Smart Boost.....	51
3.5	Setup Submenu: System I/O.....	52
3.5.1	PCI Express Configuration.....	53
3.5.2	Storage Configuration	56
3.5.3	NVMe Configuration.....	57
3.5.3.1	PCIe SSD.....	58
3.5.3.2	SATA Configuration	59
3.5.3.3	VMD Setup Menu	60
3.5.4	HD Audio Configuration	62
3.5.5	Digital IO Port Configuration	63
3.5.6	Legacy Logical Devices Configuration	64
3.5.6.1	Serial Port 1 Configuration.....	65
3.5.6.2	Serial Port 2 Configuration	66
3.5.7	Serial Port Console Redirection	67
3.6	Setup Submenu: Security.....	68
3.6.1	Trusted Computing.....	69
3.6.2	Secure Boot.....	71
3.6.3	Key Management.....	72
3.7	Setup Submenu: Boot	74
3.8	Setup Submenu: Save & Exit.....	75
Chapter 4 – Drivers Installation.....		76
4.1	Drivers Download and Installation.....	77

Appendix A - I/O Information..... 80

A.1 I/O Address Map81

A.2 Memory Address Map82

A.3 Large Memory Address Map.....83

A.4 IRQ Mapping Chart.....84

Chapter 1

Product Specifications

1.1 Specifications

System

Form Factor	COM-HPC R1.2 Mini
CPU	Intel® Core™ Ultra Processors: Intel® Core™ Ultra 7 Processor 255H (16C/16T, 2.0GHz, 28W) Intel® Core™ Ultra 5 Processor 225H (14C/14T, 1.7GHz, 28W) Intel® Core™ Ultra 7 Processor 155H (16C/22T, 1.4 GHz, 28W) Intel® Core™ Ultra 5 Processor 125H (14C/18T, 1.2 GHz, 28W)
Chipset	SoC
Memory	Onboard LPDDR5x, up to 64GB
Onboard Storage	Onboard NVMe, up to 256GB
BIOS	AMI UEFI
Wake on LAN	Yes
Watchdog Timer	255 Levels
Dimension	3.74" x 2.76" (95mm x 70mm)
Security	dTPM / fTPM

Power

Power Requirement	+12V for ATX / AT
Power Type	AT/ATX
Power Consumption (Typical)	Intel® Core™ Ultra 7 265H, 4.13 @+12V

Display

Graphics Controller	Series 1 CPU SKU: Intel® Arc™ Graphics Series 2 CPU SKU: Intel® Arc™ 140T/130T GPU
Video Output	DDI1: DP/HDMI, up to 3840 x 2160 DDI2: DP/HDMI, up to 3840 x 2160 eDP: up to 3840 x 2160

I/O

Ethernet	Intel® Ethernet Controller I226, 2.5GbE x 2
Audio	High Definition Audio Interface
USB Port	USB 3.2 (10Gbps) x 4 USB 2.0 x 8
Serial Port	4-Wire UART x 2 (Tx/Rx/RTS/CTS)
HDD Interface	Optional: SATA 6Gb/s x 2, via PCIe lane 6 and lane 7 *BIOS and BOM change required to enable SATA
Expansion	PCIe 4.0 [x8] x 1 PCIe 3.0 [x1] x 4 PCIe 3.0 [x4] x 1 (lanes 6 and 7 co-lay with SATA)
GPIO	12-bit
SMBus/I2C	I2C x 2 SMBus x 1

Environmental

Operating Temperature	-4°F – 158°F (-20°C – 70°C)
Storage Temperature	-40°F – 185°F (-40°C – 85°C)
Operating Humidity	0% – 90% relative humidity, non-condensing
EMC	CE/FCC Class A
OS Support	Windows 11 Ubuntu 24.04/Kernel 6.11
Weight	0.17 lb (0.08 kg)

1.2 Block Diagram

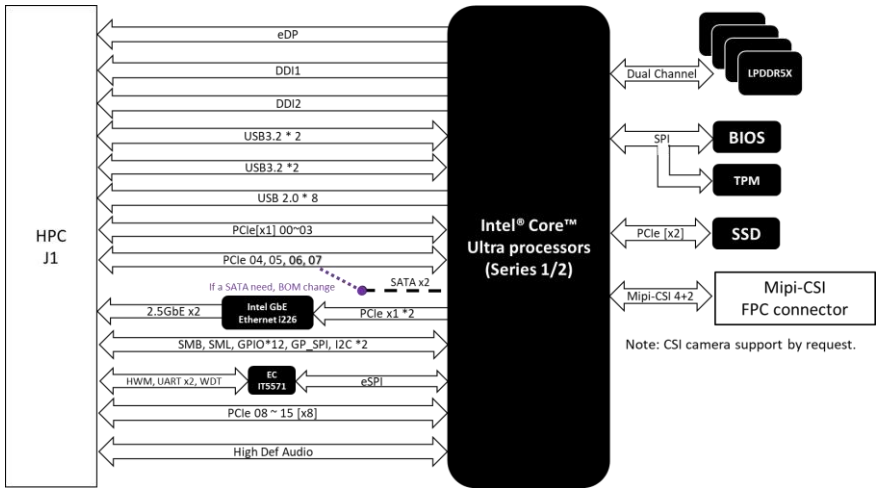

Chapter 2

Hardware Information

2.1 Dimensions

Top Side

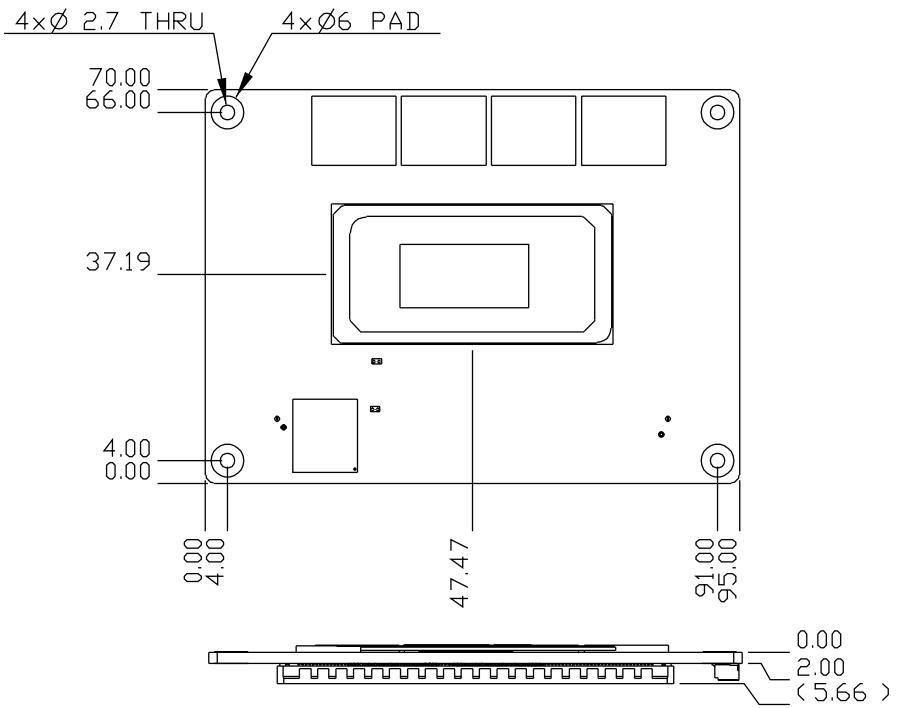

With Active Cooler (P/N HPC-ARHm -FAN01)

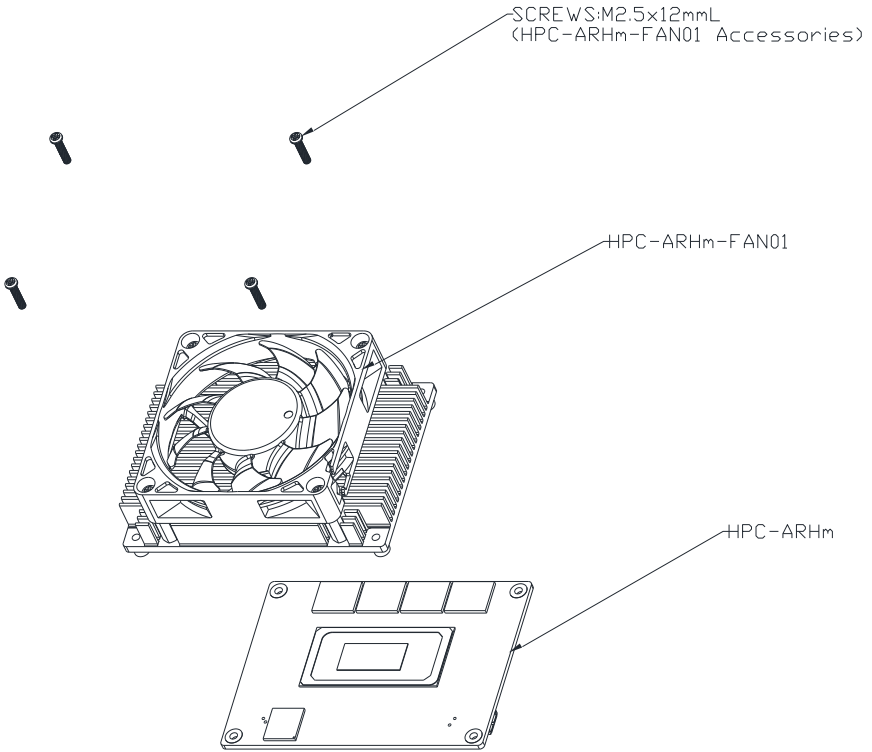

With Heat Spreader (P/N HPC-ARHm -HSP01)

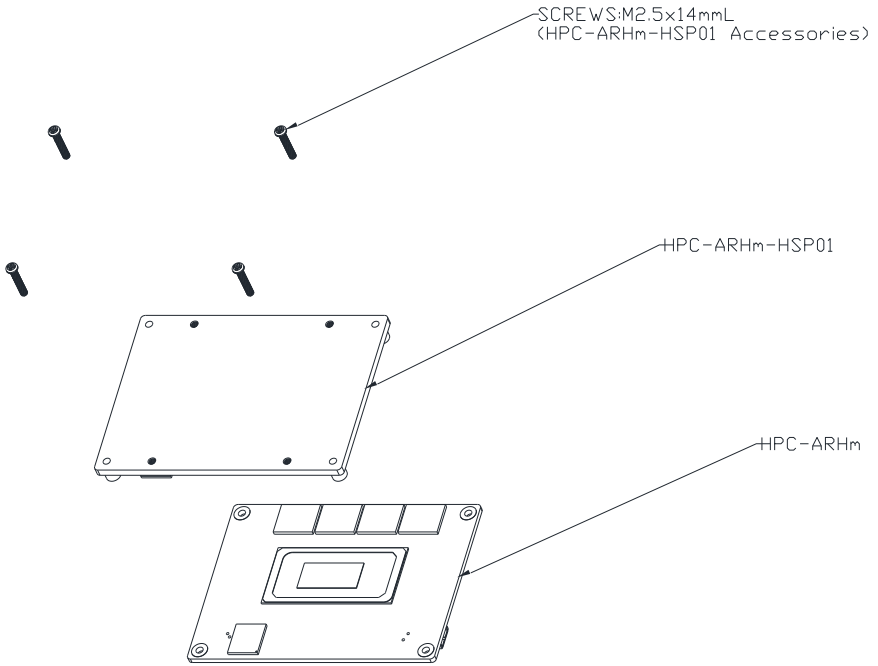

2.2 Jumpers and Connectors

Top Side

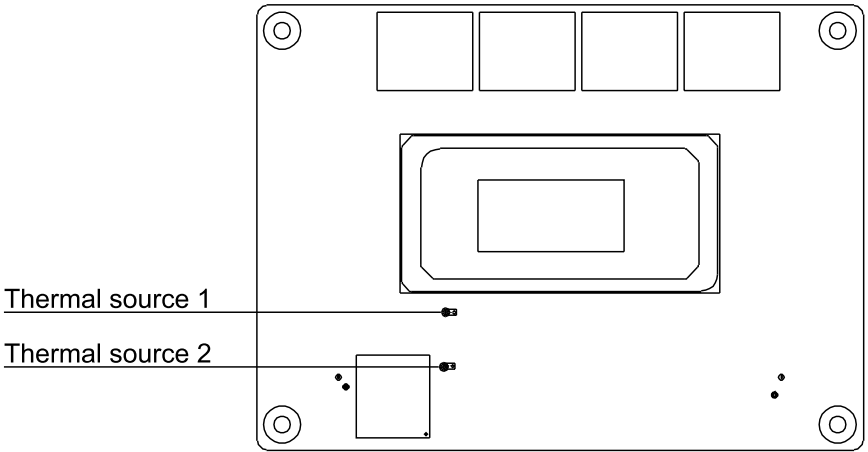

Bottom Side

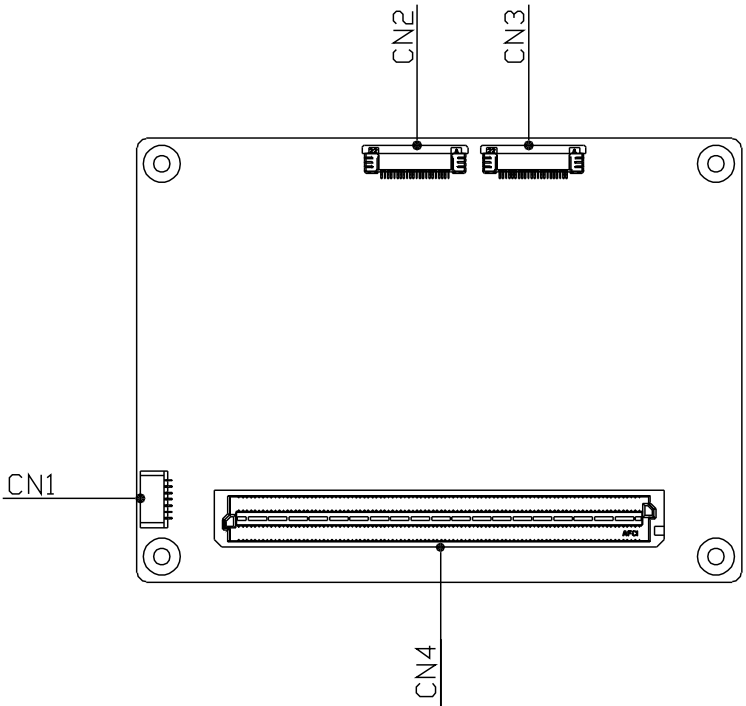

2.3 List of Connectors

Please refer to the table below for all of the board's connectors that you can configure for your application

Label	Function
CN1	SPI ROM FLASH
CN2	MIPI CSI CH 1
CN3	MIPI CSI CH 2
CN4	Row A/B/C/D

2.3.1 SPI ROM FLASH (CN1)

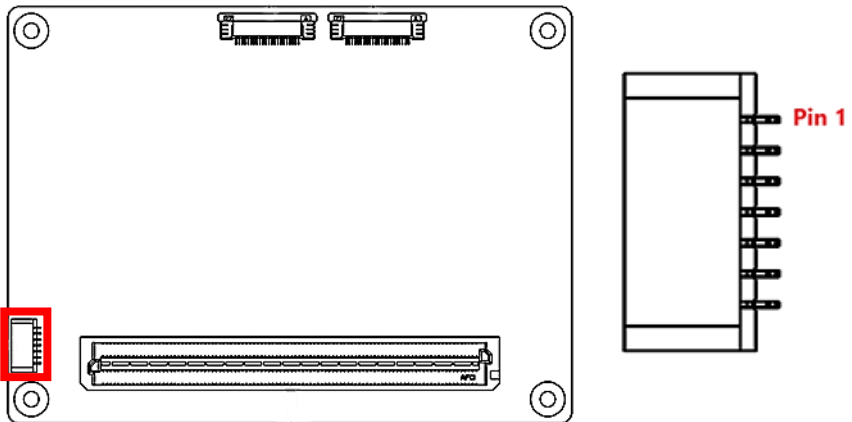

Pin	Signal
1	SPI_SO
2	GND
3	SPI_CLK
4	CSI_DP_0
5	CSI_DN_0
6	GND
7	NC

2.3.2 MIPI CSI CH1 (CN2)

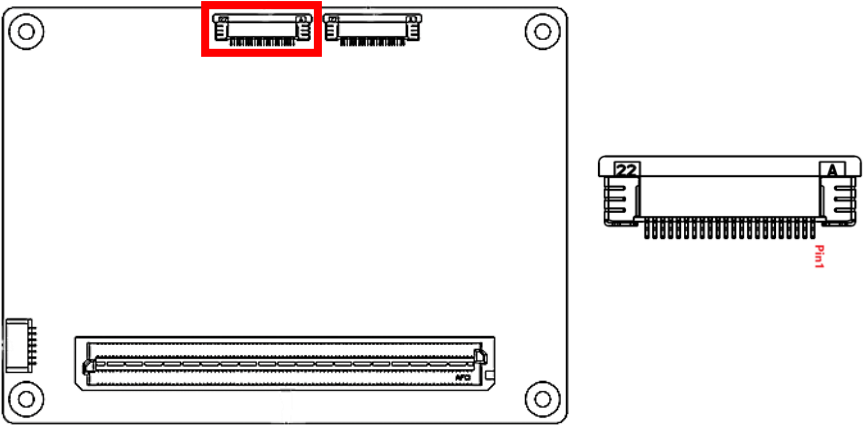

Pin	Signal
1	VCC_3.3V
2	VCC_3.3V
3	GND
4	CSI_DP_0
5	CSI_DN_0
6	GND
7	CSI_DP_1
8	CSI_DN_1
9	GND
10	CSI_DP_2
11	CSI_DN_2
12	CAM_RST#
13	CSI_DP_3
14	CSI_DN_3
15	GND
16	CSI_CLK_P
17	CSI_CLK_N
18	GND
19	I2C_CLK
20	I2C_DAT

Pin	Signal
21	CRD_PWREN
22	IMGCLKOUT

2.3.3 MIPI CSI CH2 (CN3)

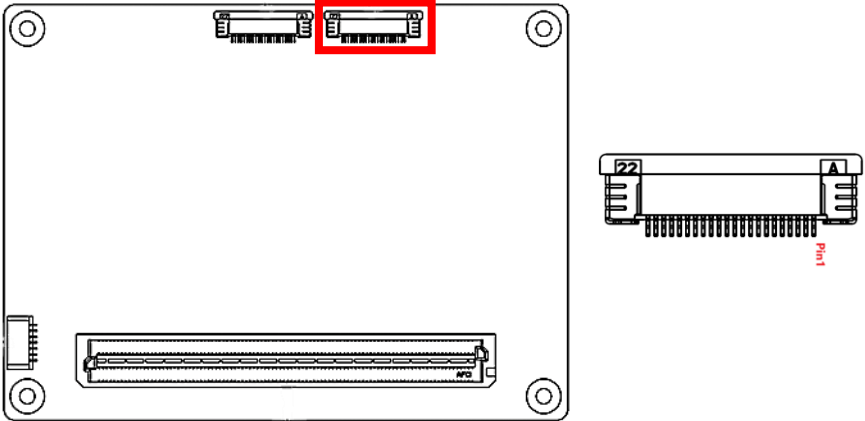

Pin	Signal
1	VCC_3.3V
2	VCC_3.3V
3	GND
4	CSI_DP_0
5	CSI_DN_0
6	GND
7	CSI_DP_1
8	CSI_DN_1
9	GND
10	CSI_DP_2
11	CSI_DN_2
12	CAM_RST#
13	CSI_DP_3
14	CSI_DN_3
15	GND
16	CSI_CLK_P

Pin	Signal
17	CSI_CLK_N
18	GND
19	I2C_CLK
20	I2C_DAT
21	CRD_PWREN
22	IMGCLKOUT

2.3.4 Row A/B/C/D Connector (CN4)

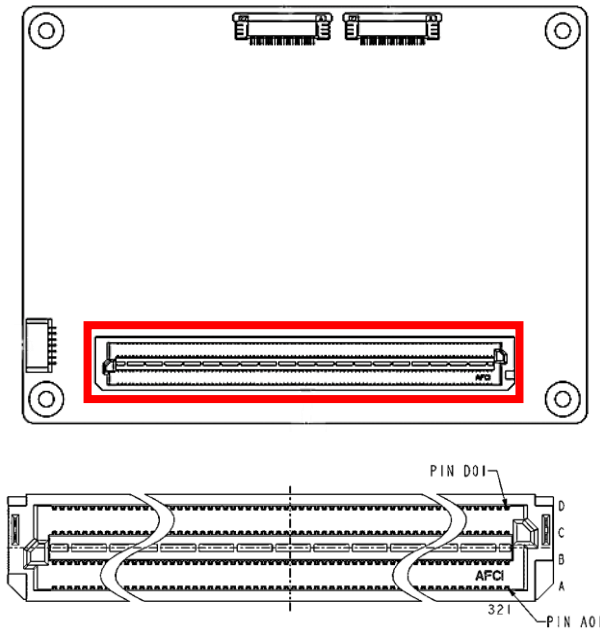

Row A		Row B	
Pin	Signal	Pin	Signal
A1	VCC	B1	VCC
A2	VCC	B2	PWRBTN#
A3	VCC	B3	VCC
A4	VCC	B4	THERMTRIP#
A5	RAPID_SHUTDOWN	B5	N.C
A6	N.C	B6	TAMPER#
A7	N.C	B7	PROCHOT#

Row A		Row B	
Pin	Signal	Pin	Signal
A8	N.C	B8	SUS_S3#
A9	N.C	B9	N.C
A10	GND	B10	WD_STROBE#
A11	N.C	B11	WD_OUT
A12	N.C	B12	GND
A13	GND	B13	USB5-
A14	USB7-	B14	USB5+
A15	USB7+	B15	GND
A16	GND	B16	USB4-
A17	USB6-	B17	USB4+
A18	USB6+	B18	GND
A19	GND	B19	HDA_SYNC
A20	SS23_SDA_AUX-	B20	HDA_SDO
A21	SS23_SDA_AUX+	B21	HDA_RST#
A22	GND	B22	HDA_SDI
A23	SS2_TX-	B23	HDA_BCLK
A24	SS2_TX+	B24	RSVD
A25	GND	B25	USB67_OC#
A26	SS2_RX-	B26	USB45_OC#
A27	SS2_RX+	B27	USB23_OC#
A28	GND	B28	USB01_OC#
A29	SS3_TX-	B29	SML1_CLK
A30	SS3_TX+	B30	SML1_DAT
A31	GND	B31	PMCALERT#
A32	SS3_RX-	B32	SML0_CLK
A33	SS3_RX+	B33	SML0_DAT
A34	GND	B34	USB_PD_ALERT#
A35	eDP_AUX-	B35	USB_PD_I2C_CLK
A36	eDP_AUX+	B36	USB_PD_I2C_DAT
A37	GND	B37	USB_RT_ENA
A38	eDP_TX0-	B38	N.C
A39	eDP_TX0+	B39	N.C
A40	GND	B40	DDIO_DDC_AUX_SEL
A41	eDP_TX1-	B41	DDIO_HPD
A42	eDP_TX1+	B42	GND
A43	GND	B43	USB1_AUX-
A44	eDP_TX2-	B44	USB1_AUX+
A45	eDP_TX2+	B45	LID#

Row A		Row B	
Pin	Signal	Pin	Signal
A46	GND	B46	SLEEP#
A47	eDP_TX3-	B47	VCC_BOOT_SPI
A48	eDP_TX3+	B48	BOOT_SPI_CS#
A49	GND	B49	BSEL0
A50	N.C	B50	BSEL1
A51	N.C	B51	BSEL2
A52	N.C	B52	N.C
A53	N.C	B53	N.C
A54	N.C	B54	N.C
A55	GND	B55	N.C
A56	PCIe_CLKREQ0_LO#	B56	N.C
A57	PCIe_CLKREQ0_HI#	B57	N.C
A58	N.C	B58	NBASET1_LINK_MID#
A59	NBASET1_LINK_MAX#	B59	NBASET1LINK_ACT#
A60	NBASET1_CTREF	B60	GND
A61	GND	B61	PCIe08_RX-
A62	PCIe08_TX-	B62	PCIe08_RX+
A63	PCIe08_TX+	B63	GND
A64	GND	B64	PCIe09_RX-
A65	PCIe09_TX-	B65	PCIe09_RX+
A66	PCIe09_TX+	B66	GND
A67	GND	B67	PCIe10_RX-
A68	PCIe10_TX-	B68	PCIe10_RX+
A69	PCIe10_TX+	B69	GND
A70	GND	B70	PCIe11_RX-
A71	PCIe11_TX-	B71	PCIe11_RX+
A72	PCIe11_TX+	B72	GND
A73	GND	B73	PCIe12_RX-
A74	PCIe12_TX-	B74	PCIe12_RX+
A75	PCIe12_TX+	B75	GND
A76	GND	B76	PCIe13_RX-
A77	PCIe13_TX-	B77	PCIe13_RX+
A78	PCIe13_TX+	B78	GND
A79	GND	B79	PCIe14_RX-
A80	PCIe14_TX-	B80	PCIe14_RX+
A81	PCIe14_TX+	B81	GND
A82	GND	B82	PCIe15_RX-
A83	PCIe15_TX-	B83	PCIe15_RX+

Row A		Row B	
Pin	Signal	Pin	Signal
A84	PCIe15_TX+	B84	GND
A85	GND	B85	N.C
A86	VCC_RTC	B86	RSMRST_OUT#
A87	SUS_CLK	B87	UART1_TX
A88	GPIO_00	B88	UART1_RX
A89	GPIO_01	B89	UART1_RTS#
A90	GPIO_02	B90	UART1_CTS#
A91	GPIO_03	B91	N.C
A92	GPIO_04	B92	N.C
A93	GPIO_05	B93	GP_SPI_MOSI
A94	GPIO_06	B94	GP_SPI_MISO
A95	GPIO_07	B95	GP_SPI_CS0#
A96	GPIO_08	B96	N.C
A97	GPIO_09	B97	N.C
A98	GPIO_10	B98	N.C
A99	GPIO_11	B99	GP_SPI_CLK
A100	PINOUT_TYPE0	B100	GP_SPI_ALERT#

Row C		Row D	
Pin	Signal	Pin	Signal
C1	VCC	D1	VCC
C2	RSTBTN#	D2	VCC
C3	VCC	D3	VCC
C4	CARRIER_HOT#	D4	VCC
C5	N.C	D5	PLTRST#
C6	VIN_PWR_OK	D6	N.C
C7	CATERR#	D7	N.C
C8	SUS_S4_S5#	D8	N.C
C9	N.C	D9	N.C
C10	BATLOW#	D10	WAKE0#
C11	FAN_PWMOUT	D11	WAKE1#
C12	FAN_TACHIN	D12	GND
C13	GND	D13	USB1-
C14	USB3-	D14	USB1+
C15	USB3+	D15	GND
C16	GND	D16	USB0-
C17	USB2-	D17	USB0+
C18	USB2+	D18	GND

Row C		Row D	
Pin	Signal	Pin	Signal
C19	GND	D19	SS01_SDA_AUX-
C20	SNDW_DMIC_CLK1	D20	SS01_SDA_AUX+
C21	SNDW_DMIC_DAT1	D21	GND
C22	GND	D22	SS0_TX-
C23	SNDW_DMIC_CLK0	D23	SS0_TX+
C24	SNDW_DMIC_DAT0	D24	GND
C25	GND	D25	SS0_RX-
C26	DDI1_DDC_AUX_SEL	D26	SS0_RX+
C27	N.C	D27	GND
C28	DDI1_HPD	D28	SS1_TX-
C29	N.C	D29	SS1_TX+
C30	eDP_HPD	D30	GND
C31	eDP_VDD_EN	D31	SS1_RX-
C32	eDP_BKLT_EN	D32	SS1_RX+
C33	eDP_BKLTCTL	D33	GND
C34	GND	D34	ACPRESENT
C35	N.C	D35	NBASET1_SDP
C36	N.C	D36	GND
C37	GND	D37	SS6_TX-
C38	SS6_RX-	D38	SS6_TX+
C39	SS6_RX+	D39	GND
C40	GND	D40	SS7_TX-
C41	SS7_RX-	D41	SS7_TX+
C42	SS7_RX+	D42	GND
C43	GND	D43	SS4_TX-
C44	SS4_RX-	D44	SS4_TX+
C45	SS4_RX+	D45	GND
C46	GND	D46	SS5_TX-
C47	SS5_RX-	D47	SS5_TX+
C48	SS5_RX+	D48	GND
C49	GND	D49	NBASET1_MDI0-
C50	BOOT_SPI_IO0	D50	NBASET1_MDI0+
C51	BOOT_SPI_IO1	D51	GND
C52	BOOT_SPI_IO2	D52	NBASET1_MDI1-
C53	BOOT_SPI_IO3	D53	NBASET1_MDI1+
C54	BOOT_SPI_CLK	D54	GND
C55	GND	D55	NBASET1_MDI2-
C56	PCIe_REFCLK0_HI-	D56	NBASET1_MDI2+

Row C		Row D	
Pin	Signal	Pin	Signal
C57	PCIe_REFCLK0_HI+	D57	GND
C58	GND	D58	NBASET1_MDI3-
C59	PCIe_REFCLK0_LO-	D59	NBASET1_MDI3+
C60	PCIe_REFCLK0_LO+	D60	GND
C61	GND	D61	PCIe00_TX-
C62	PCIe00_RX-	D62	PCIe00_TX+
C63	PCIe00_RX+	D63	GND
C64	GND	D64	PCIe01_TX-
C65	PCIe01_RX-	D65	PCIe01_TX+
C66	PCIe01_RX+	D66	GND
C67	GND	D67	PCIe02_TX-
C68	PCIe02_RX-	D68	PCIe02_TX+
C69	PCIe02_RX+	D69	GND
C70	GND	D70	PCIe03_TX-
C71	PCIe03_RX-	D71	PCIe03_TX+
C72	PCIe03_RX+	D72	GND
C73	GND	D73	PCIe04_TX-
C74	PCIe04_RX-	D74	PCIe04_TX+
C75	PCIe04_RX+	D75	GND
C76	GND	D76	PCIe05_TX-
C77	PCIe05_RX-	D77	PCIe05_TX+
C78	PCIe05_RX+	D78	GND
C79	GND	D79	PCIe06_TX-
C80	PCIe06_RX-/SATA1_RX-	D80	PCIe06_TX+
C81	PCIe06_RX+/SATA1_RX+	D81	GND
C82	GND	D82	PCIe07_TX-
C83	PCIe07_RX-/SATA0_RX-	D83	PCIe07_TX+
C84	PCIe07_RX+/SATA0_RX+	D84	GND
C85	GND	D85	NBASET0_MDI0-
C86	SMB_CLK	D86	NBASET0_MDI0+
C87	SMB_DAT	D87	GND
C88	SMB_ALERT#	D88	NBASET0_MDI1-
C89	UART0_TX	D89	NBASET0_MDI1+
C90	UART0_RX	D90	GND
C91	UART0_RTS#	D91	NBASET0_MDI2-
C92	UART0_CTS#	D92	NBASET0_MDI2+
C93	I2C0_CLK	D93	GND
C94	I2C0_DAT	D94	NBASET0_MDI3-

Row C		Row D	
Pin	Signal	Pin	Signal
C95	I2C0_ALERT#	D95	NBASET0_MDI3+
C96	I2C1_CLK	D96	GND
C97	I2C1_DAT	D97	NBASET0_LINK_MAX#
C98	NBASET0_SDP	D98	NBASET0_LINK_MID#
C99	NBASET0_CTREF	D99	NBASET0_LINK_ACT#
C100	PINOUT_TYPE1	D100	PINOUT_TYPE2

Chapter 3

AMI BIOS Setup

3.1 System Test and Initialization

The board uses certain routines to test and initialize board hardware. If the routines encounter an error during the tests, you will either hear a few short beeps or see an error message on the screen. There are two kinds of errors: fatal and non-fatal. The system can usually continue the boot up sequence with non-fatal errors.

System configuration verification routines check the current system configuration stored in the CMOS memory and BIOS NVRAM. If a system configuration is not found or a system configuration data error is detected, the system will load the optimized default and re-boot with this default system configuration automatically.

There are four situations in which you will need to setup system configuration:

You are starting your system for the first time.

You have changed the hardware attached to your system.

The CMOS memory has lost power and the configuration information has been erased.

The HPC-ARHm CMOS memory uses a backup battery for data retention. The battery must be replaced if it runs out of power.

3.2 AMI BIOS Setup

The AMI BIOS ROM has a built-in Setup program that allows users to modify the basic system configuration. This information is stored in the battery-backed CMOS RAM and BIOS NVRAM so it retains the Setup information when the power is turned off.

To enter Setup, power on the computer and press immediately.

The function of each menu is as follows:

Main – Date and time can be set here. Use <Tab> to switch between date elements.

Advanced – Enable/disable boot option for legacy network devices.

System I/O – Enable/ Disable System input and output port.

Security – Password for setup administrator can be set here.

Boot – Enable/disable Quiet Boot option.

Save & Exit – Save changes and exit Setup.

3.3 Setup Submenu: Main

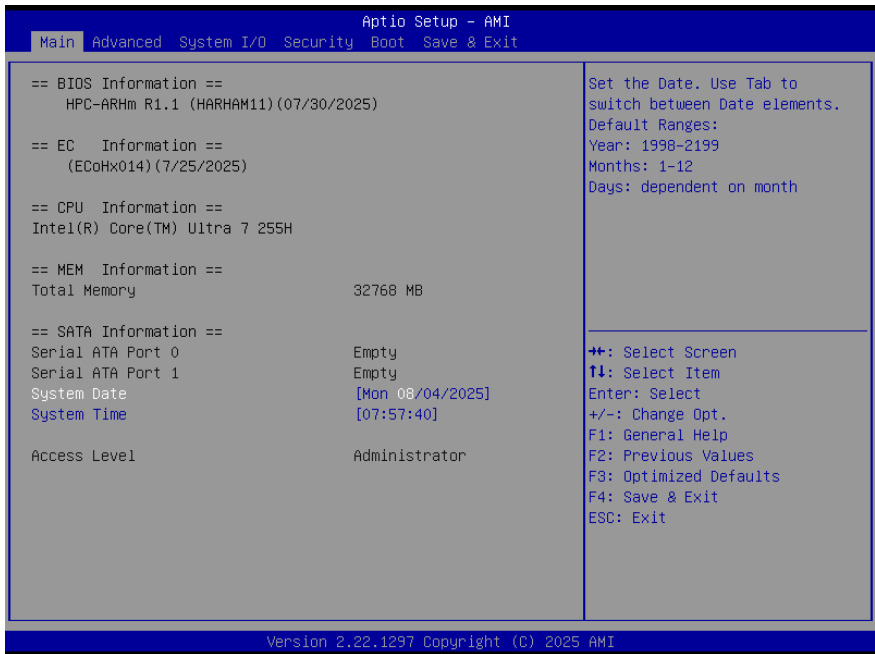

3.4 Setup Submenu: Advanced

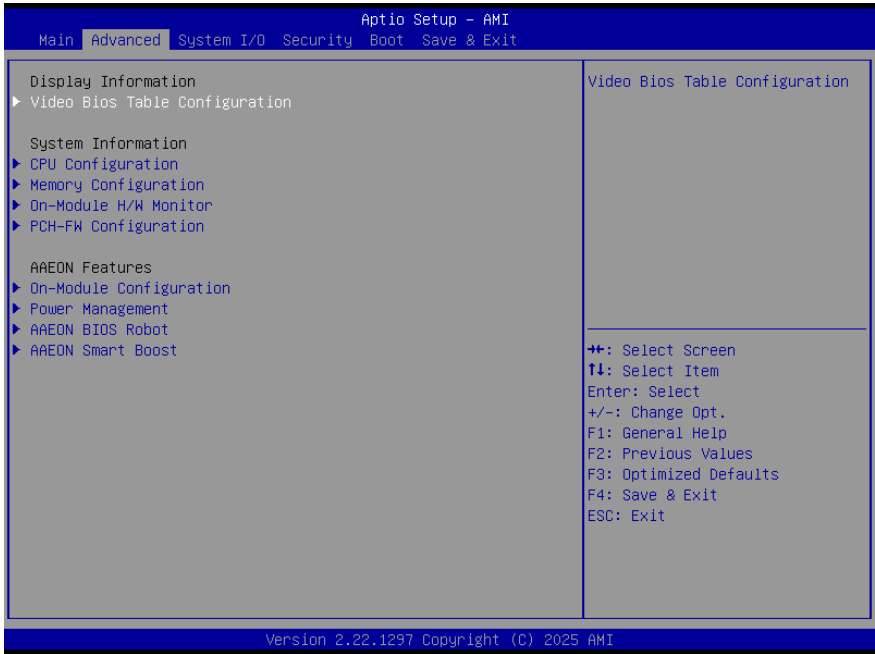

3.4.1 Video BIOS Table Configuration

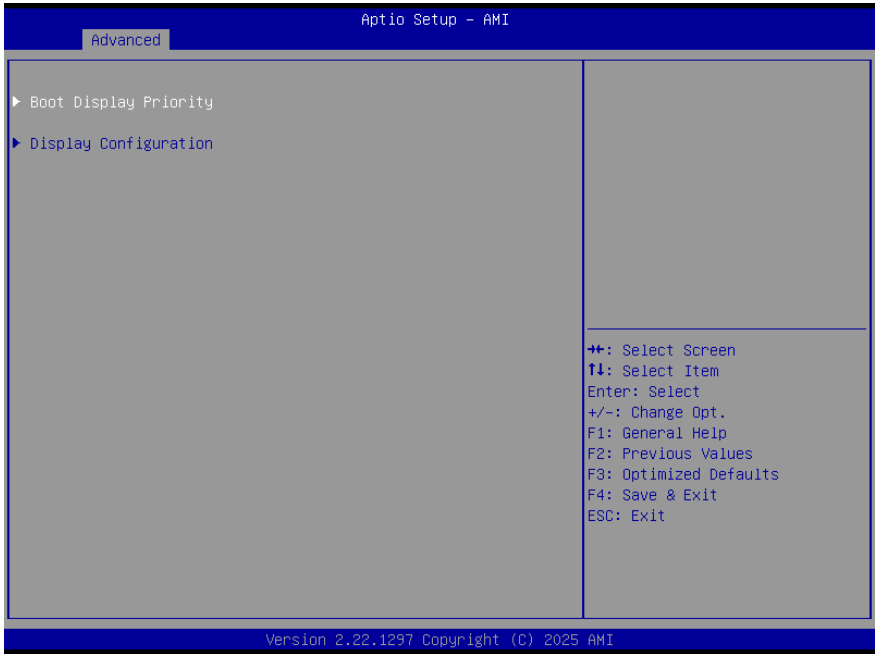

3.4.1.1 Boot Display Priority

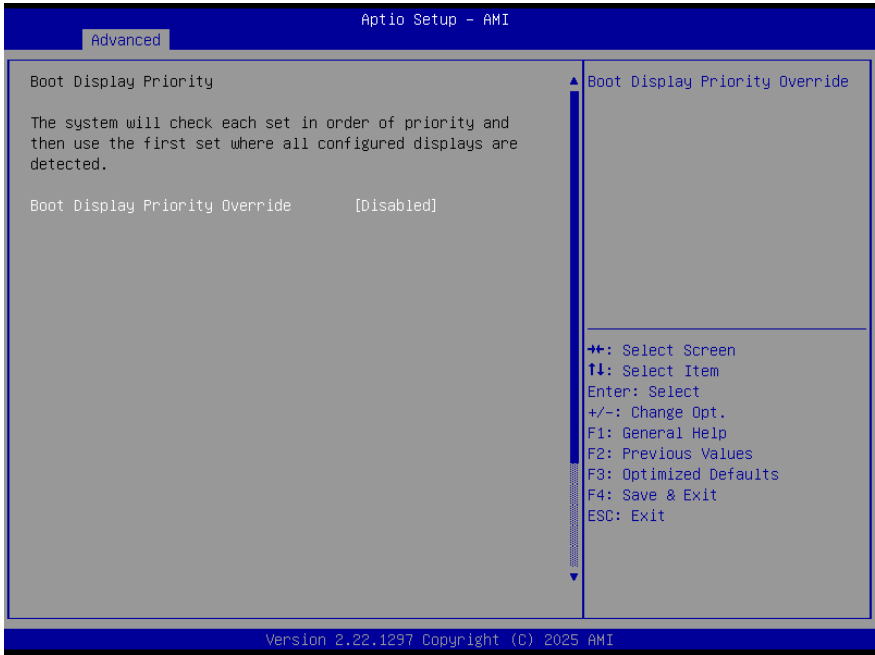

Options Summary		
Boot Display Priority	Disabled	Optimal Default, Failsafe Default
Override	Enabled	
Boot Display Priority Override.		

Set to Enabled

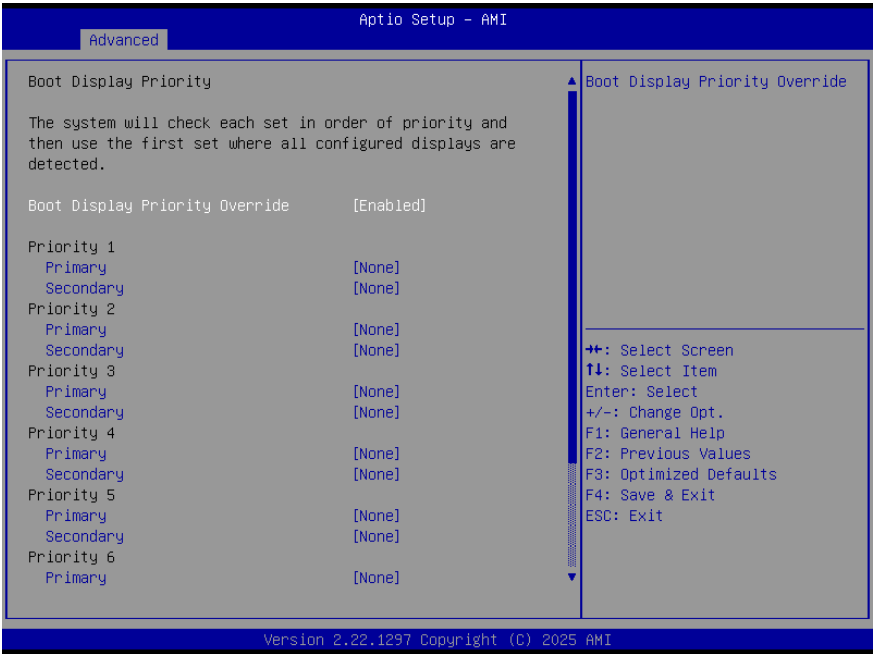

Options Summary		
Primary	None	Optimal Default, Failsafe Default
	eDP	
	SS01	
	SS23	
Primary Boot Display Priority		
Secondary	None	Optimal Default, Failsafe Default
Secondary Boot Display Priority		

3.4.1.2 Display Configuration

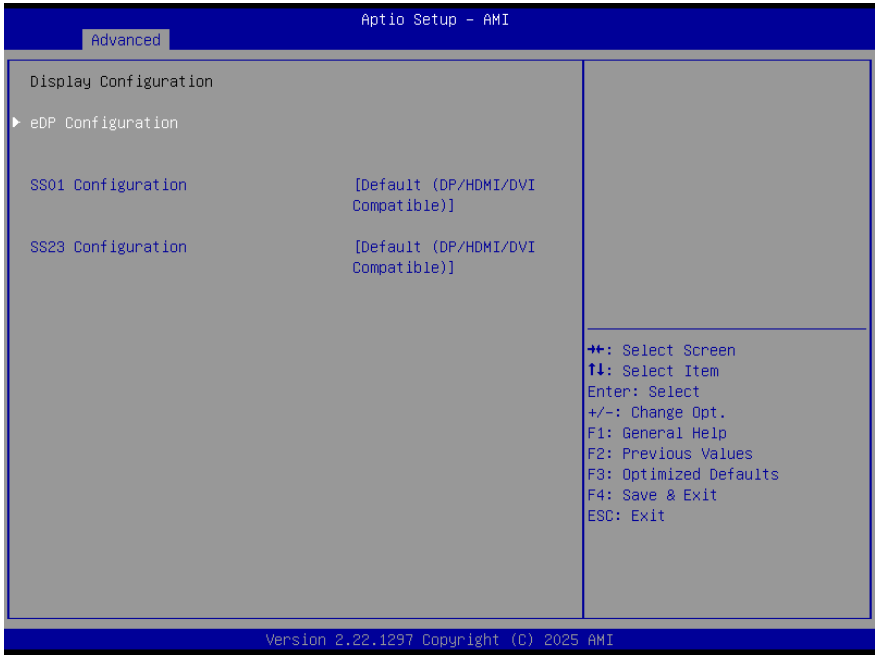

Options Summary		
SS01 Configuration	No Device	
	DP	
	DP/HDMI/DVI Compatible	
	HDMI/DVI	
	Default (DP/HDMI/DVI Compatible)	Optimal Default, Failsafe Default
Select output type for this device		
SS23 Configuration	No Device	
	DP	
	DP/HDMI/DVI Compatible	
	HDMI/DVI	
	Default (DP/HDMI/DVI Compatible)	Optimal Default, Failsafe Default
Select output type for this device		

3.4.1.3 eDP Configuration

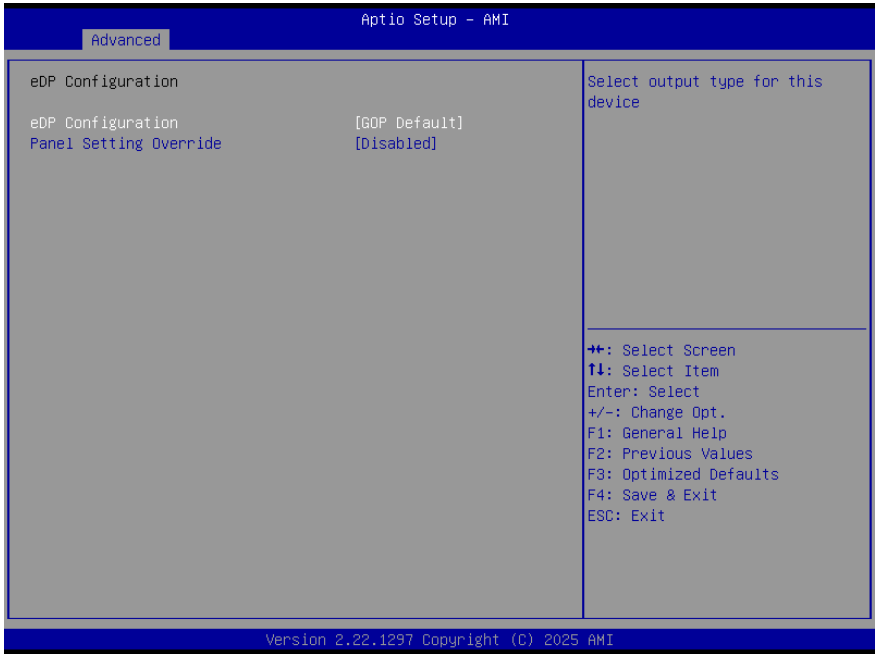

Options Summary		
eDP Configuration	No Device	
	eDP	
	GOP Default	Optimal Default, Failsafe Default
eDP Configuration		
Panel Setting Override	Enabled	
	Disabled	Optimal Default, Failsafe Default
Panel Setting Override		

Set to Enabled

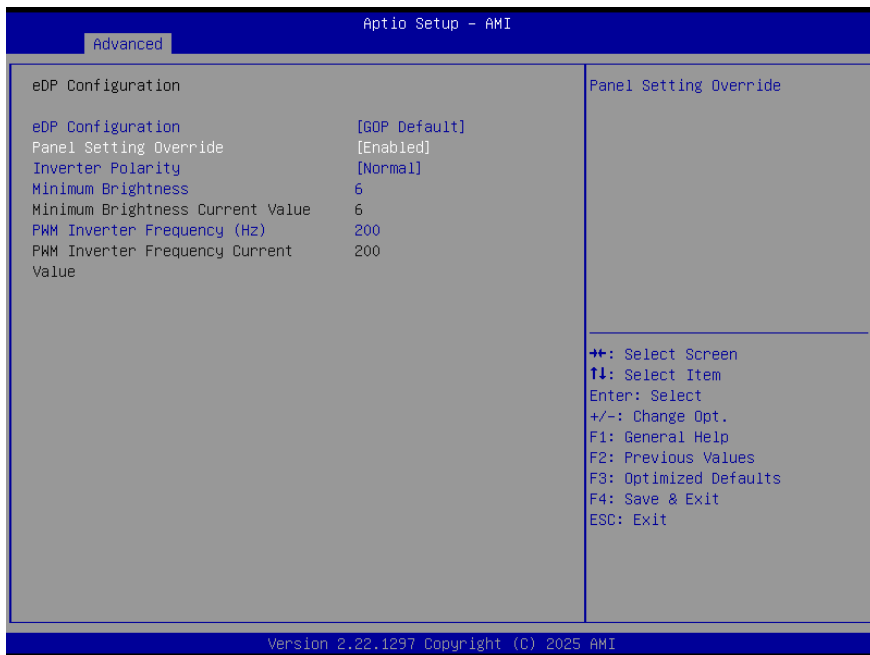

Options Summary		
Inverter Polarity	Normal	Optimal Default, Failsafe Default
	Inverted	
Set Polarity		
Minimum Brightness	6	Optimal Default, Failsafe Default
Minimum Brightness Value		
PWM Inverter Frequency	200	Optimal Default, Failsafe Default
PWM Inverter Frequency (Hz)		

3.4.2 CPU Configuration

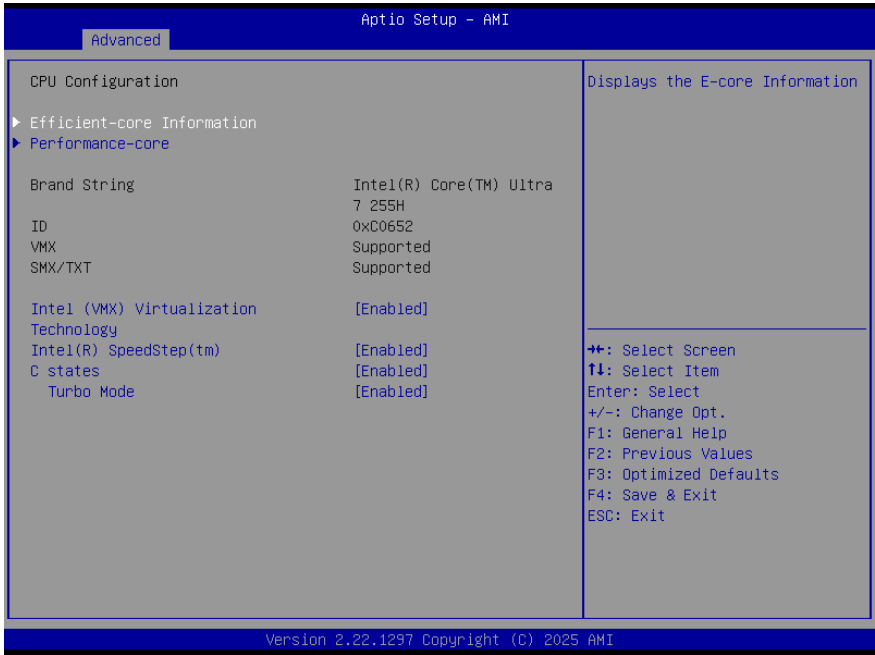

Options Summary		
Intel (VMX) Virtualization Technology	Disabled	
	Enabled	Optimal Default, Failsafe Default
When enabled, a VMM can utilize the additional hardware capabilities provided by Vanderpool Technology.		
Intel(R) SpeedStep(tm)	Disabled	
	Enabled	Optimal Default, Failsafe Default
Allows more than two frequency ranges to be supported.		
C states	Disabled	
	Enabled	Optimal Default, Failsafe Default
Enable/Disable CPU Power Management. Allows CPU to go to C states when it's not 100% utilized.		
Turbo Mode	Disabled	
	Enabled	Optimal Default, Failsafe Default
Enable/Disable processor Turbo Mode.		

3.4.2.1 Efficient-Core Information

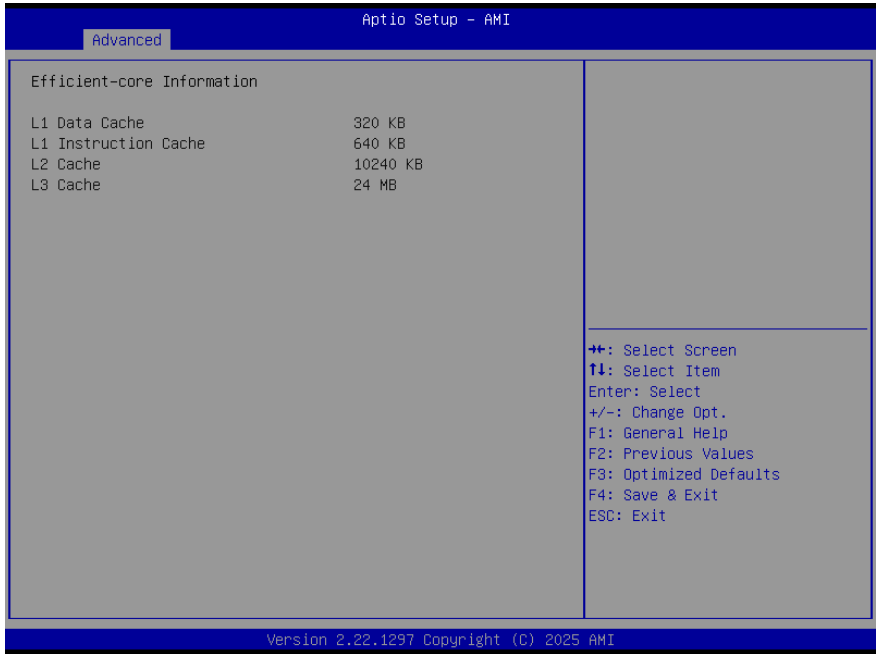

3.4.2.2 Performance-Core Information

The screenshot shows the 'Advanced' section of the Aptio Setup - AMI BIOS. The 'Performance-core' menu item is selected, displaying the following cache information:

Cache Type	Size
L1 Data Cache	288 KB
L1 Instruction Cache	384 KB
L2 Cache	18432 KB
L3 Cache	24 MB

Below the cache information, a list of navigation and function keys is provided:

- ++: Select Screen
- ↑↓: Select Item
- Enter: Select
- +/-: Change Opt.
- F1: General Help
- F2: Previous Values
- F3: Optimized Defaults
- F4: Save & Exit
- ESC: Exit

At the bottom of the screen, the version and copyright information are displayed: Version 2.22.1297 Copyright (C) 2025 AMI.

3.4.3 Memory Configuration

Aptio Setup - AMI

Advanced

Memory RC Version	1.5.4.0
Total Memory	32768 MB
Memory Frequency	6400 MHZ
tCL-tRCD-tRP-tRAS	17-15-15-34
MC 0 Ch 0 DIMM 0	Populated & Enabled
Size	4096 MB (LPDDR5)
Number of Ranks	2
Manufacturer	Samsung
MC 0 Ch 1 DIMM 0	Populated & Enabled
Size	4096 MB (LPDDR5)
Number of Ranks	2
Manufacturer	Samsung
MC 0 Ch 2 DIMM 0	Populated & Enabled
Size	4096 MB (LPDDR5)
Number of Ranks	2
Manufacturer	Samsung
MC 0 Ch 3 DIMM 0	Populated & Enabled
Size	4096 MB (LPDDR5)
Number of Ranks	2
Manufacturer	Samsung
MC 1 Ch 0 DIMM 0	Populated & Enabled
Size	4096 MB (LPDDR5)
Number of Ranks	2
Manufacturer	Samsung
MC 1 Ch 1 DIMM 0	Populated & Enabled

Legend:

- ++: Select Screen
- F1: Select Item
- Enter: Select
- +/-: Change Opt.
- F1: General Help
- F2: Previous Values
- F3: Optimized Defaults
- F4: Save & Exit
- ESC: Exit

Version 2.22.1297 Copyright (C) 2025 AMI

3.4.4 On-Module H/W Monitor

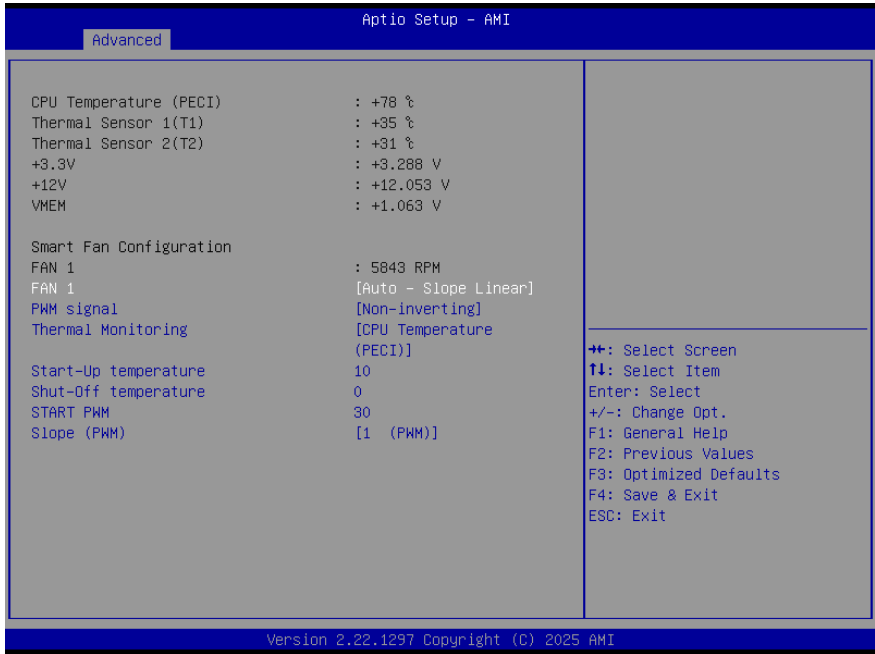

Options Summary		
FAN 1	Full Mode	
	Manual Mode	
	Auto – Slope Linear	Optimal Default, Failsafe Default
Smart Fan Mode Select.		
PWM signal	Non-inverting	Optimal Default, Failsafe Default
	Inverting	
Select output PWM of inverting or non-inverting signal.		
Thermal Monitoring	CPU Temperature (PECI)	Optimal Default, Failsafe Default
	Thermal Source 1 (T1)	
	Thermal Source 2 (T2)	
Monitoring thermal sensor select.		
Start-Up temperature	10	Optimal Default, Failsafe Default
Configures PWM output level triggered when the thermal sensor reading goes above the threshold. Range: 0–100.		

Options Summary		
Shut-Off temperature	0	Optimal Default, Failsafe Default
PWM output turns off when thermal sensor reading is less than or equal to the threshold. Range: 0–100.		
START PWM	30	Optimal Default, Failsafe Default
Initial PWM output value when Start-Up temperature is reached.		
Slope (PWM)	0 (PWM)	
	1 (PWM)	Optimal Default, Failsafe Default
	2 (PWM)	
	4 (PWM)	
	8 (PWM)	
	16 (PWM)	
	32 (PWM)	
	64 (PWM)	
When the temperature rises above the Start-Up point, the PWM output increases with each degree.		

3.4.5 PCH-FW Configuration

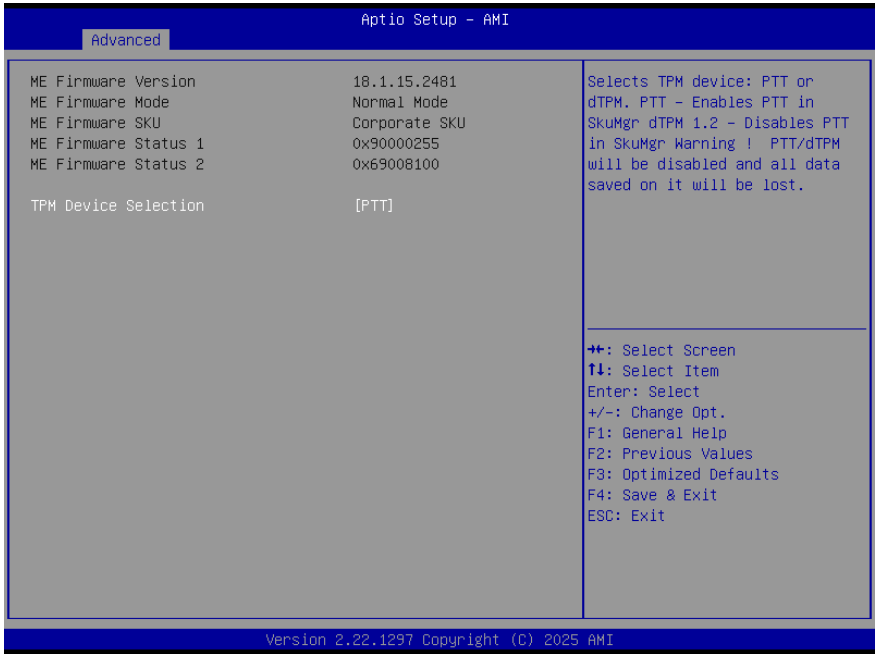

Options Summary		
TPM Device Selection	dTPM	
	PTT	Optimal Default, Failsafe Default
<p>Selects TPM Device – Choose between PTT or dTPM.</p> <p>PTT: Enables PTT in SkuMgr</p> <p>dTPM 1.2: Disables PTT in SkuMgr</p> <p>Warning: Switching between PTT and dTPM will disable the current TPM function, and all data stored in TPM will be lost.</p>		

3.4.6 On-Module Configuration

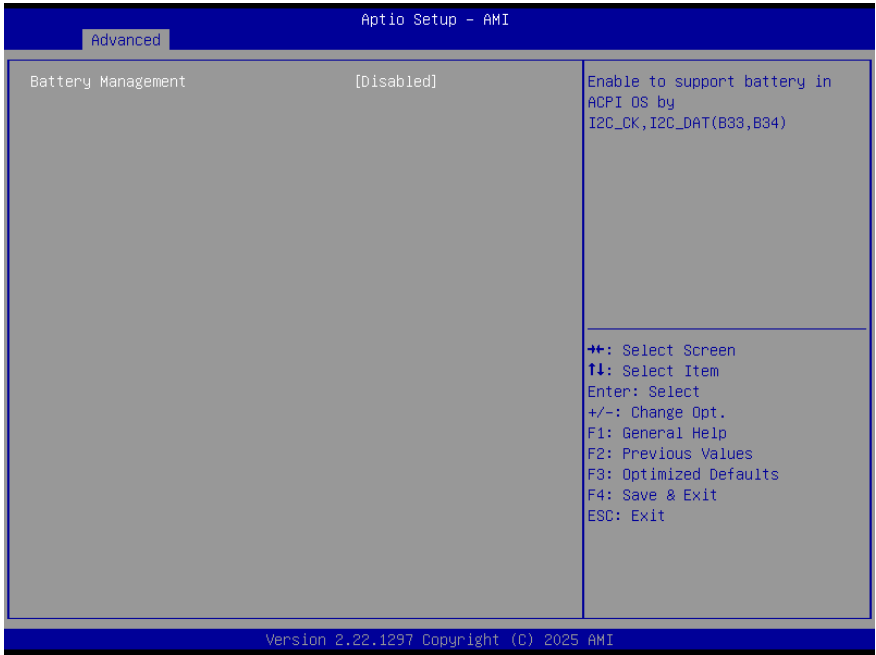

Options Summary		
Battery Management	Disabled	Optimal Default, Failsafe Default
	One Battery	
Enables battery support in ACPI OS via I2C_CK/I2C_DAT (pins B33, B34).		

3.4.7 Power Management

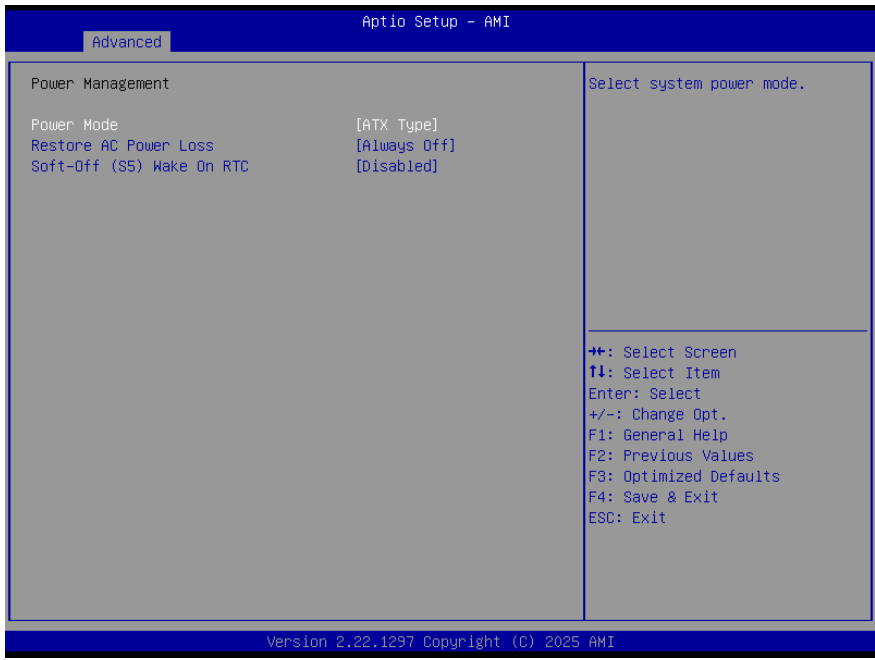

Options Summary		
Power Mode	ATX Type	Optimal Default, Failsafe Default
	AT Type	
Select system power mode.		
Restore AC Power Loss	Last State	
	Always On	
	Always Off	Optimal Default, Failsafe Default
IO Restore AC power Loss.		
Soft-Off (S5) Wake On RTC	Disable	Optimal Default, Failsafe Default
	By Date	
	By Weekday	
	Bypass	
By Date: System wakes at the exact date and time specified (hr:min:sec).		
By Weekday: System wakes on the chosen weekday at the set time (hr:min:sec).		
Bypass: RTC wake function not managed by BIOS.		

3.4.8 AAEON BIOS Robot

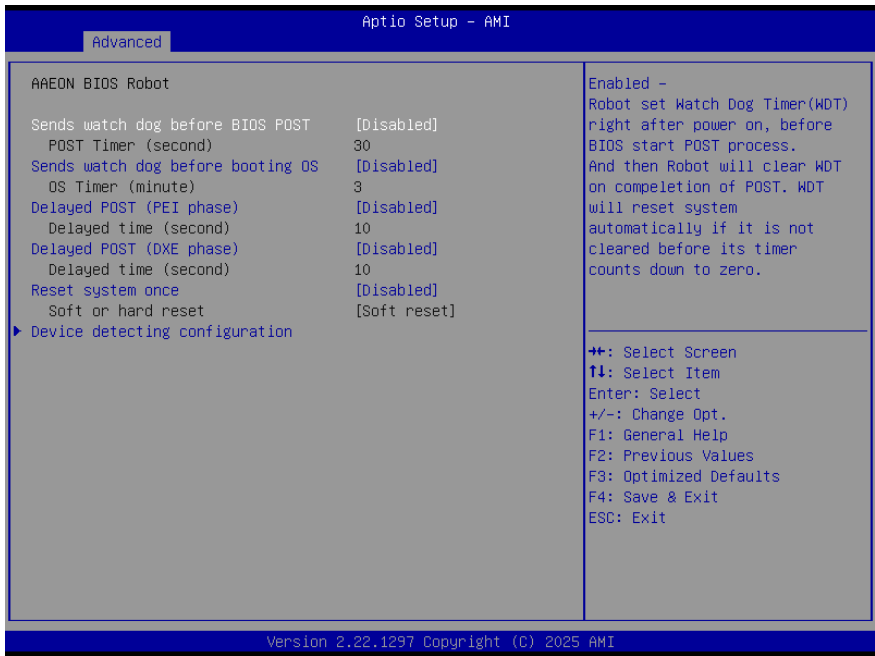

Options Summary		
Sends watch dog before BIOS POST	Disabled	Optimal Default, Failsafe Default
	Enabled	
Enabled – Robot sets the Watchdog Timer (WDT) immediately after power-on, before BIOS POST. The WDT is cleared once POST completes. If not cleared before timeout, the WDT will automatically reset the system.		
POST Timer (second)	30	Optimal Default, Failsafe Default
WDT Timer Count – Sets the Watchdog Timer duration for POST. ⚠ Warning: Do not set equal to or shorter than normal POST time, or the system may fail to complete POST unless BIOS settings are cleared. Recommended: more than 2× normal POST time.		
Sends watch dog before booting OS	Disabled	Optimal Default, Failsafe Default
	Enabled	
Enabled – Robot sets the Watchdog Timer (WDT) after POST, before BIOS transfers control to the OS.		
Warning: The OS must include a program to clear the WDT. Disable this function if the OS will perform updates.		

Options Summary		
OS Timer (minute)	3	Optimal Default, Failsafe Default
Sets the Watchdog Timer duration for OS boot/loading.		
Delayed POST (PEI phase)	Disabled	Optimal Default, Failsafe Default
	Enabled	
Enabled – Robot delays BIOS POST immediately after power-on, allowing POST to start with stable power or after the system warms up. Note: This occurs before “Send Watchdog.”		
Delayed time (second)	10	Optimal Default, Failsafe Default
Period of time for Robot to hold BIOS from POST.		
Delayed POST (DXE phase)	Disabled	Optimal Default, Failsafe Default
	Enabled	
Enabled – Robot delays BIOS until POST completes, ensuring POST runs with stable power or after system warm-up. Note: This occurs after “Send Watchdog before BIOS POST.”		
Delayed time (second)	10	Optimal Default, Failsafe Default
Period of time for Robot to hold BIOS from POST.		
Reset system once	Disabled	Optimal Default, Failsafe Default
	Enabled	
Enabled – Robot performs a single system reset on each boot, sending a soft or hard reset to onboard devices to ensure a more stable state.		
Soft or hard reset	Soft reset	Optimal Default, Failsafe Default
	Hard reset	
Select reset type robot should send on each boot.		

3.4.8.1 Device Detecting Configuration



Options Summary		
Action	Reset System	Optimal Default, Failsafe Default
	Hold System	
Select action that robot should do.		
Soft or hard reset	Soft	Optimal Default, Failsafe Default
	Hard	
Select reset type robot should send on each boot.		
Retry-Count	3	Optimal Default, Failsafe Default
Sets the maximum number of system resets the Robot will perform before allowing POST to continue.		
At time	After show logo	Optimal Default, Failsafe Default
	Before show logo	
Select Robot Action Time – Choose when the Robot performs its action: After Show Logo – Executes after the logo is displayed; most system devices are ready. Before Show Logo – Executes earlier, before logo display; some devices may not be ready.		

3.4.8.2 Device #1 Detecting Configuration

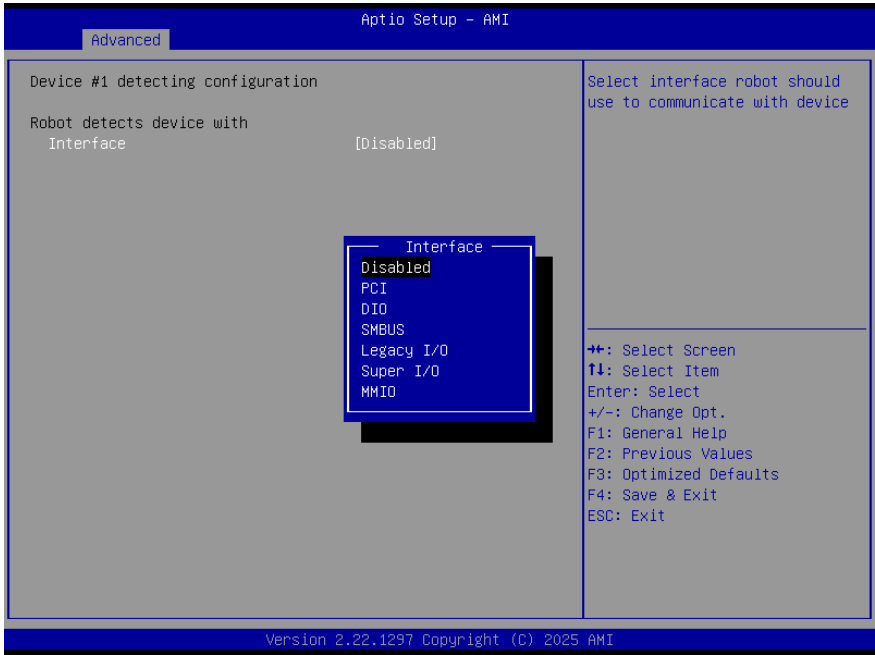

Options Summary		
Interface	Disabled	Optimal Default, Failsafe Default
	PCI	
	DIO	
	SMBUS	
	Legacy I/O	
	Super I/O	
	MMIO	
Select interface robot should use to communicate with device.		

Set to PCI

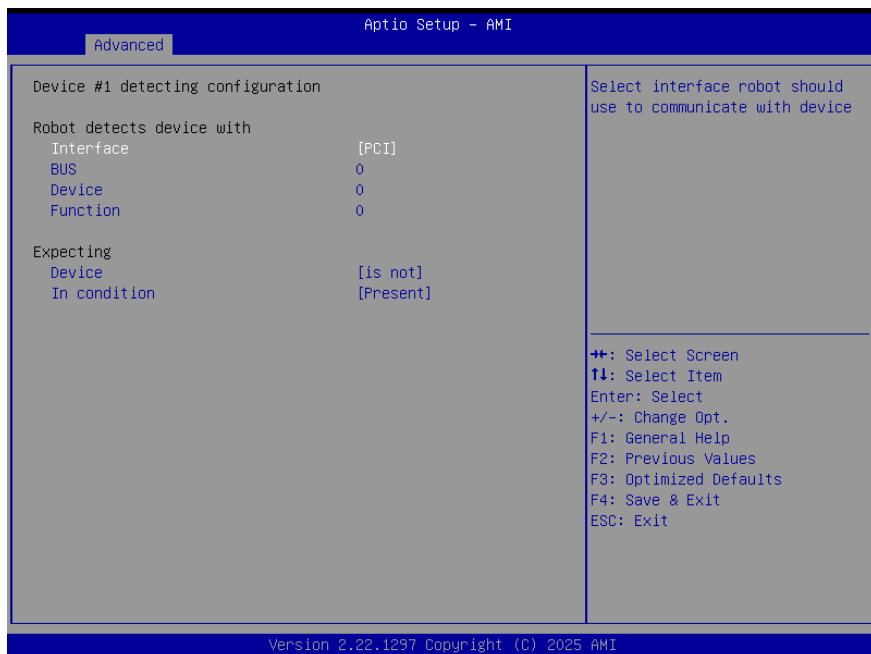

Options Summary		
When interface item set to "PCI" will show below items		
BUS	0	Optimal Default, Failsafe Default
Fill BUS number to a PCI device, in hexadecimal. Range: 0 – FF.		
Device	0	Optimal Default, Failsafe Default
Fill DEVICE number to a PCI device, in hexadecimal. Range: 0 – FF.		
Function	0	Optimal Default, Failsafe Default
Fill FUNCTION number to a PCI device, in hexadecimal. Range: 0 – FF.		
Device	is	
	Is not	Optimal Default, Failsafe Default
Select that robot should or should not do action if condition met.		
In condition	Present	Optimal Default, Failsafe Default
	Specified register data	
Device Check Condition – Select how the Robot verifies a device: Present – Device is detected. According to Register – Robot reads the device register based on configuration. Note: A device is considered Present if the data read is not 0xFF.		

Set to DIO

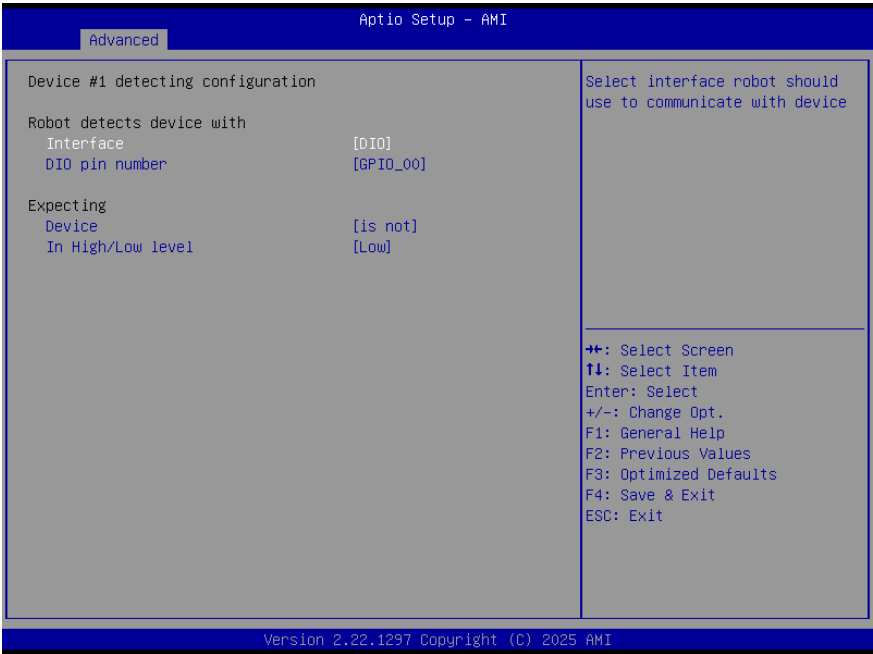

Options Summary

When interface item set to "DIO" will show below items

DIO pin number	GPIO_00	Optimal Default, Failsafe Default
	GPIO_01	
	GPIO_02	
	GPIO_03	
	GPIO_04	
	GPIO_05	
	GPIO_06	
	GPIO_07	

DIO Pin Number – Assign the DIO pin for Robot actions.

For COM Express products:

0 - 3 → GPIO - 3

4 - 7 → GPIO - 3

Device	is	
	Is not	Optimal Default, Failsafe Default

Select that robot should or should not do action if condition met.

Options Summary		
When interface item set to "DIO" will show below items		
In High/Low level	Low	Optimal Default, Failsafe Default
	High	
Select High/Low level of the DIO pin that robot should do action.		

Set to SMBus

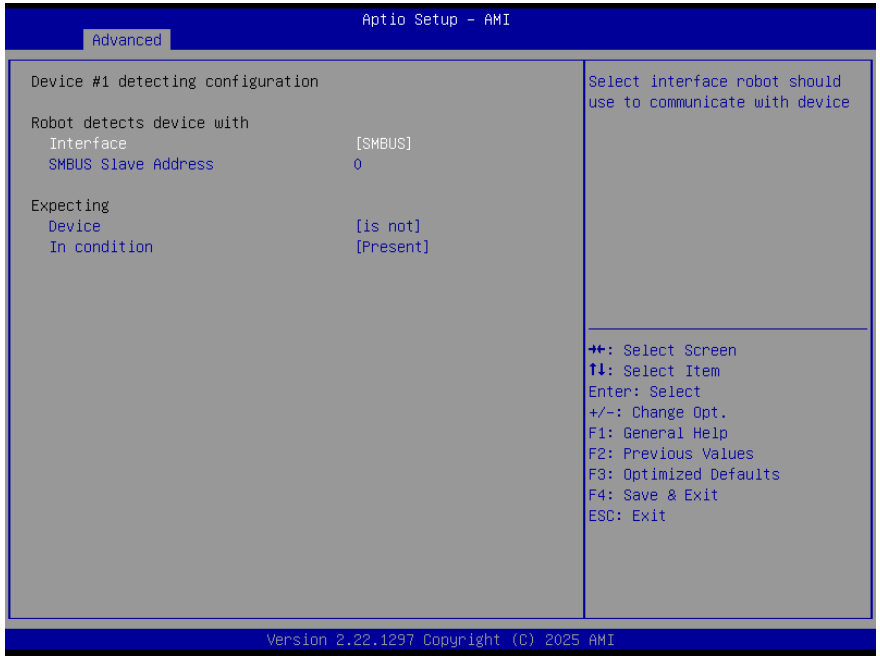

Options Summary		
When interface item set to "SMBUS" will show below items		
SMBUS Slave Address	0	Optimal Default, Failsafe Default
Fill slave address to a SMBUS device, in hexadecimal. Range: 0 - FF		
Device	is	
	Is not	Optimal Default, Failsafe Default
Select that robot should or should not do action if condition met.		
In condition	Present	Optimal Default, Failsafe Default
	Specified register data	
Device Check Condition – Select how the Robot verifies a device: Present – Device is detected.		

Options Summary

When interface item set to "SMBUS" will show below items

According to Register – Robot reads the device register based on configuration.
Note: A device is considered Present if the data read is not 0xFF.

Set to Legacy I/O

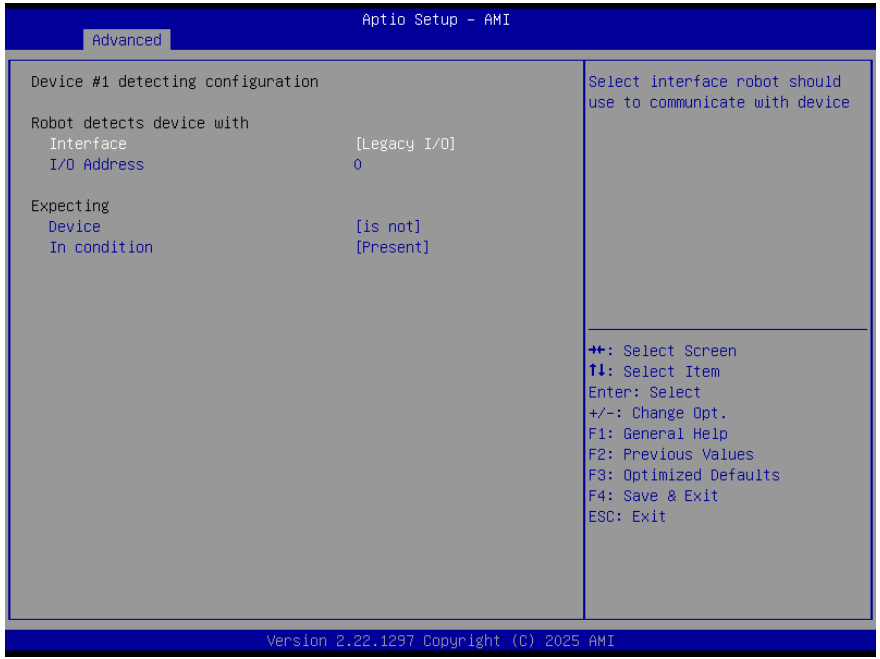

Options Summary

When interface item set to "Legacy I/O" will show below items

I/O Address	0	Optimal Default, Failsafe Default
-------------	---	-----------------------------------

Fill I/O address device is responding to. Range: 0~FFFF.

Device	is	
	Is not	Optimal Default, Failsafe Default

Select that robot should or should not do action if condition met.

In condition	Present	Optimal Default, Failsafe Default
	Specified register data	

Device Check Condition – Select how the Robot verifies a device:
 Present – Device is detected.
 According to Register – Robot reads the device register per configuration.

Options Summary

When interface item set to "Legacy I/O" will show below items

Note: A device is considered Present if the data read is not 0xFF.

Set to Super I/O

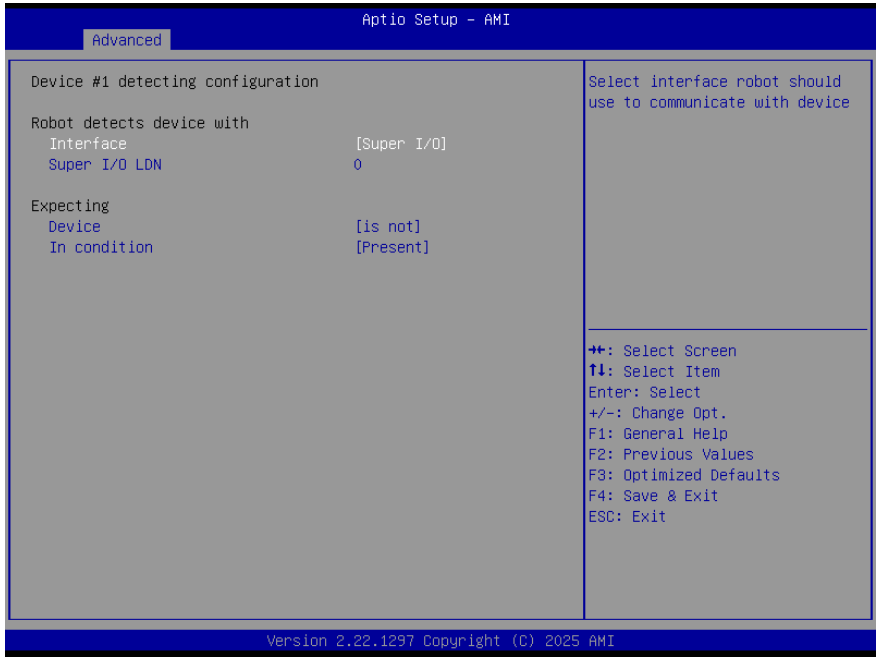

Options Summary

When interface item set to "Super I/O" will show below items

Super I/O LDN	0	Optimal Default, Failsafe Default
---------------	---	-----------------------------------

Fill LDN number to a Super I/O device. Range: 0~FF.

Device	Is	
--------	----	--

	Is not	Optimal Default, Failsafe Default
--	--------	-----------------------------------

Select that robot should or should not do action if condition met.

In condition	Present	Optimal Default, Failsafe Default
--------------	---------	-----------------------------------

	Specified register data	
--	-------------------------	--

Device Check Condition – Choose how the Robot verifies a device:

Present – Device is detected.

According to Register – Robot reads the device register per configuration.

Note: A device is considered Present if the data read is not 0xFF.

Set to MMIO

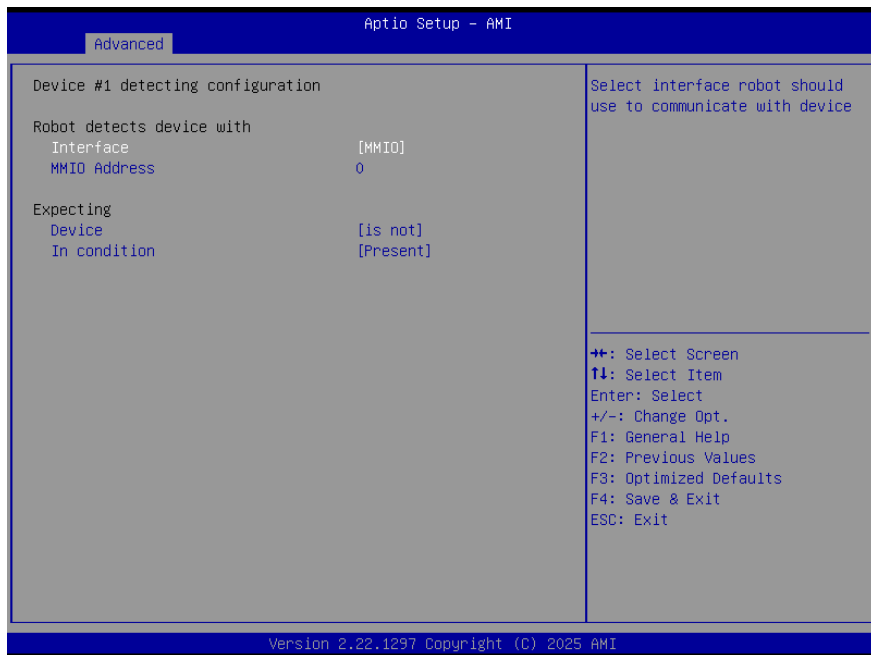

Options Summary

When interface item set to "MMIO" will show below items

MMIO Address	0	Optimal Default, Failsafe Default
Fill Memory Mapped I/O address device is responding to. Range: 0~FFFFFFFF.		
Device	is	
	Is not	Optimal Default, Failsafe Default
Select that robot should or should not do action if condition met.		
In condition	Present	Optimal Default, Failsafe Default
	Specified register data	
Device Check Condition – Select how the Robot verifies a device: Present – Device is detected. According to Register – Robot reads the device register per configuration. Note: The device is considered Present if the data read is not 0xFF.		

3.4.9 AAEON Smart Boost

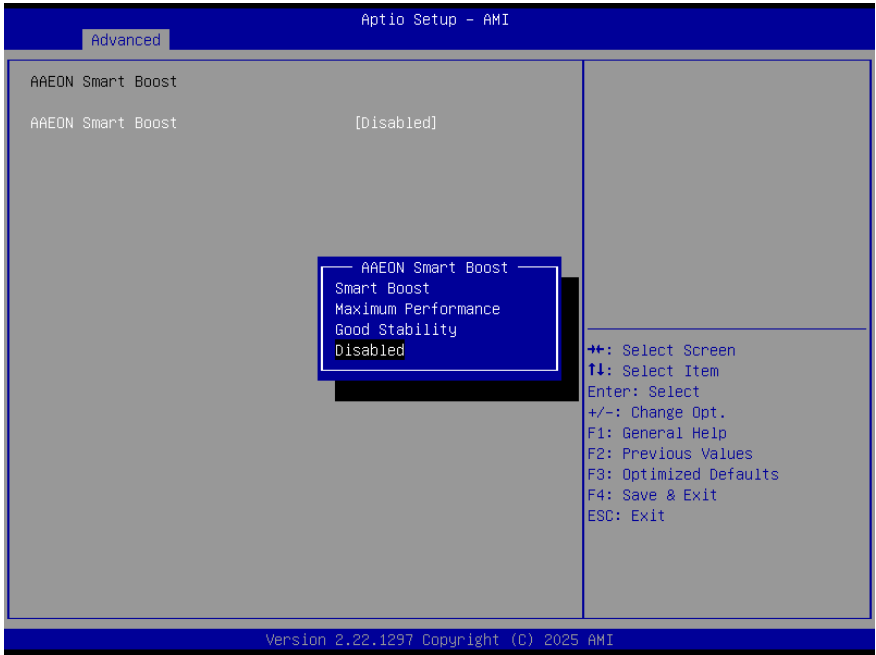

Options Summary		
AAEON Smart Boost	Smart Boost	
	Maximum Performance	
	Good Stability	
	Disable	Optimal Default, Failsafe Default
AAEON Smart Boost Mode Select.		

3.5 Setup Submenu: System I/O



3.5.1 PCI Express Configuration

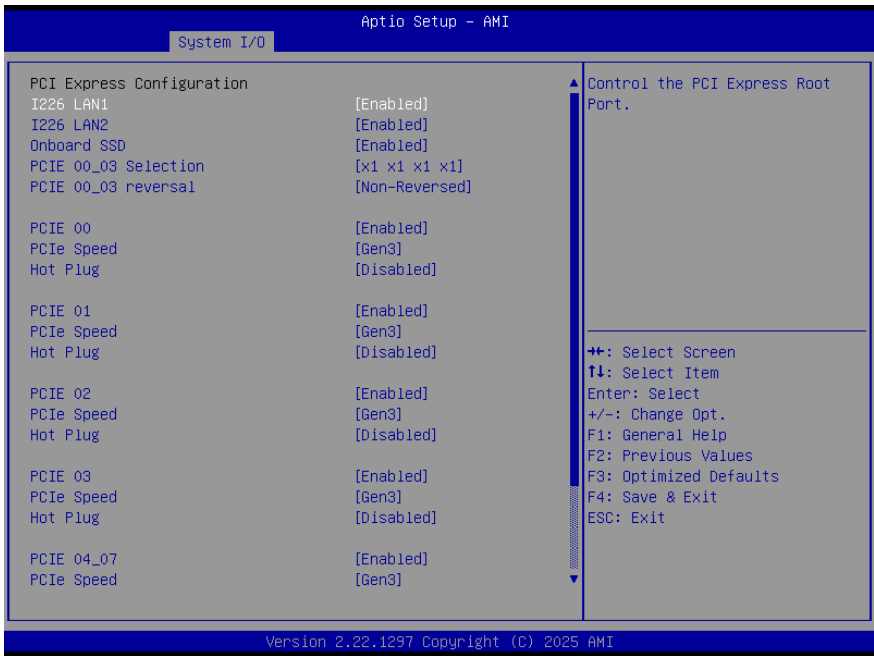

Options Summary		
I226 LAN1	Disabled	
	Enabled	Optimal Default, Failsafe Default
I226 LAN1 – Enable or disable the LAN1 interface.		
I226 LAN2	Disabled	
	Enabled	Optimal Default, Failsafe Default
I226 LAN2 – Enable or disable the LAN2 interface.		
Onboard SSD	Disabled	
	Enabled	Optimal Default, Failsafe Default
Enable/Disable the onboard SSD		
PCle 00_03 Selection	x1 x1 x1 x1	Optimal Default, Failsafe Default
	X2 x1 x1	
	x2 x2	
	x4	
PCIE Controller Setting		
PCle 00_03 reversal	Non-Reversed	Optimal Default, Failsafe Default
	Reversed	

Options Summary		
PCIe LANE REVERSAL		
PCIe 00	Disabled	
	Enabled	Optimal Default, Failsafe Default
Control the PCI Express Root Port.		
PCIe Speed	Auto	
	Gen1	
	Gen2	
	Gen3	Optimal Default, Failsafe Default
	Gen4	
Configure PCIe Speed.		
Hot Plug	Disabled	Optimal Default, Failsafe Default
	Enabled	
PCI Express Hot Plug Enable/Disable.		
PCIe 01	Disabled	
	Enabled	Optimal Default, Failsafe Default
Control the PCI Express Root Port.		
PCIe Speed	Auto	
	Gen1	
	Gen2	
	Gen3	Optimal Default, Failsafe Default
	Gen4	
Configure PCIe Speed.		
Hot Plug	Disabled	Optimal Default, Failsafe Default
	Enabled	
PCI Express Hot Plug Enable/Disable.		
PCIe 02	Disabled	
	Enabled	Optimal Default, Failsafe Default
Control the PCI Express Root Port.		
PCIe Speed	Auto	
	Gen1	
	Gen2	
	Gen3	Optimal Default, Failsafe Default
	Gen4	
Configure PCIe Speed.		
Hot Plug	Disabled	Optimal Default, Failsafe Default
	Enabled	
PCI Express Hot Plug Enable/Disable.		
PCIe 03	Disabled	
	Enabled	Optimal Default, Failsafe Default

Options Summary		
Control the PCI Express Root Port.		
PCIe Speed	Auto	
	Gen1	
	Gen2	
	Gen3	Optimal Default, Failsafe Default
	Gen4	
Configure PCIe Speed.		
Hot Plug	Disabled	Optimal Default, Failsafe Default
	Enabled	
PCI Express Hot Plug Enable/Disable.		
PCIe 04_07	Disabled	
	Enabled	Optimal Default, Failsafe Default
Control the PCI Express Root Port.		
PCIe Speed	Auto	
	Gen1	
	Gen2	
	Gen3	Optimal Default, Failsafe Default
	Gen4	
Configure PCIe Speed.		
Hot Plug	Disabled	Optimal Default, Failsafe Default
	Enabled	
PCI Express Hot Plug Enable/Disable.		
PCIe 08_15	Disabled	
	Enabled	Optimal Default, Failsafe Default
Control the PCI Express Root Port.		
PCIe Speed	Auto	
	Gen1	
	Gen2	
	Gen3	
	Gen4	Optimal Default, Failsafe Default
	Gen5	
Configure PCIe Speed.		
Hot Plug	Disabled	Optimal Default, Failsafe Default
	Enabled	
PCI Express Hot Plug Enable/Disable.		

3.5.2 Storage Configuration



3.5.3 NVMe Configuration

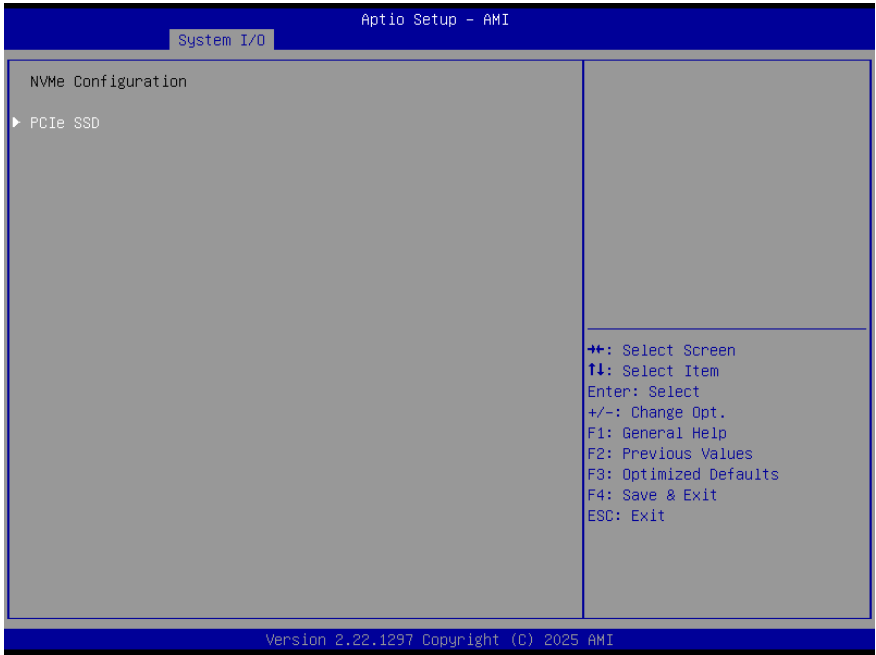

3.5.3.1 PCIe SSD



Options Summary		
Self Test Option	Short	Optimal Default, Failsafe Default
	Extended	
Set Option for Self Test		
Self Test Action	Controller Only Test	Optimal Default, Failsafe Default
	Controller and NameSpace Test	
Set Action for Self Test		

3.5.3.2 SATA Configuration

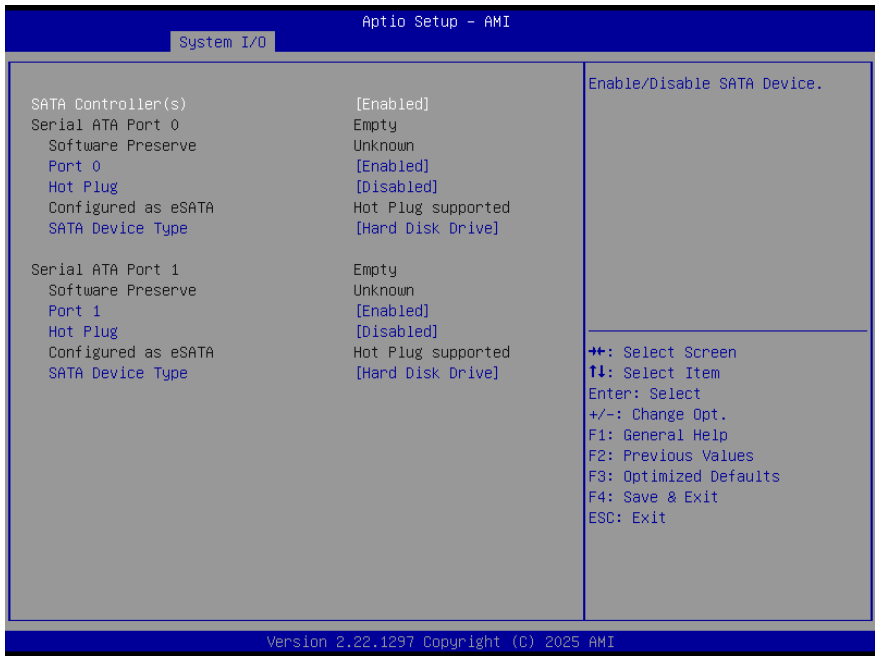

Options Summary		
SATA Controller(s)	Disabled	
	Enabled	Optimal Default, Failsafe Default
Enable/Disable SATA Device.		
Port 0~1	Disabled	
	Enabled	Optimal Default, Failsafe Default
Enable or Disable SATA Port.		
Hot Plug	Disabled	Optimal Default, Failsafe Default
	Enabled	
Designates this port as Hot Pluggable.		
SATA Device Type	Hard Disk Drive	Optimal Default, Failsafe Default
	Solid State Drive	
Detects whether the connected SATA port has a Solid-State Drive (SSD) or Hard Disk Drive (HDD).		

3.5.3.3 VMD Setup Menu

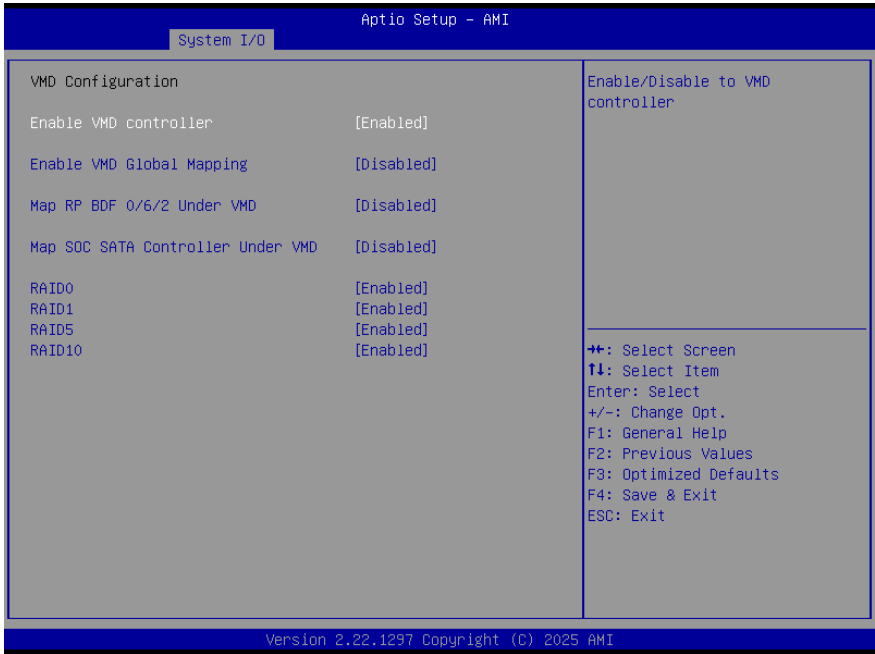

Options Summary		
Enable VMD controller	Disabled	
	Enabled	Optimal Default, Failsafe Default
Enable/Disable VMD controller		
Enable VMD Global Mapping	Disabled	Optimal Default, Failsafe Default
	Enabled	
Enable/Disable VMD Global Mapping		
Map RP BDF 0/6/2 Under VMD	Disabled	Optimal Default, Failsafe Default
	Enabled	
Enable/Disable Map RP BDF 0/6/2 Under VMD		
Map SOC SATA Controller Under VMD	Disabled	Optimal Default, Failsafe Default
	Enabled	
Enable/Disable Map SOC SATA Controller Under VMD		
RAID0	Disabled	
	Enabled	Optimal Default, Failsafe Default
Enable/Disable RAID0 Support		

Options Summary		
RAID1	Disabled	
	Enabled	Optimal Default, Failsafe Default
Enable/Disable RAID1 Support		
RAID5	Disabled	
	Enabled	Optimal Default, Failsafe Default
Enable/Disable RAID5 Support		
RAID10	Disabled	
	Enabled	Optimal Default, Failsafe Default
Enable/Disable RAID10 Support		

3.5.4 HD Audio Configuration



Options Summary		
HD Audio	Disabled	
	Enabled	Optimal Default, Failsafe Default
Enable or disable detection of the HD-Audio device. Disabled – HDA is unconditionally disabled. Enabled – HDA is unconditionally enabled.		

3.5.5 Digital IO Port Configuration



Options Summary		
GPIO_00~11	Input	
	Output	Optimal Default, Failsafe Default
Set DIO as Input or Output.		
Output Level	Low	
	High	Optimal Default, Failsafe Default
Set output level when DIO pin is output.		

3.5.6 Legacy Logical Devices Configuration



Options Summary		
HD Audio	Disabled	
	Enabled	Optimal Default, Failsafe Default
Control Detection of the HD-Audio device. Disabled = HDA will be unconditionally disabled. Enabled = HDA will be unconditionally enabled.		

3.5.6.1 Serial Port 1 Configuration

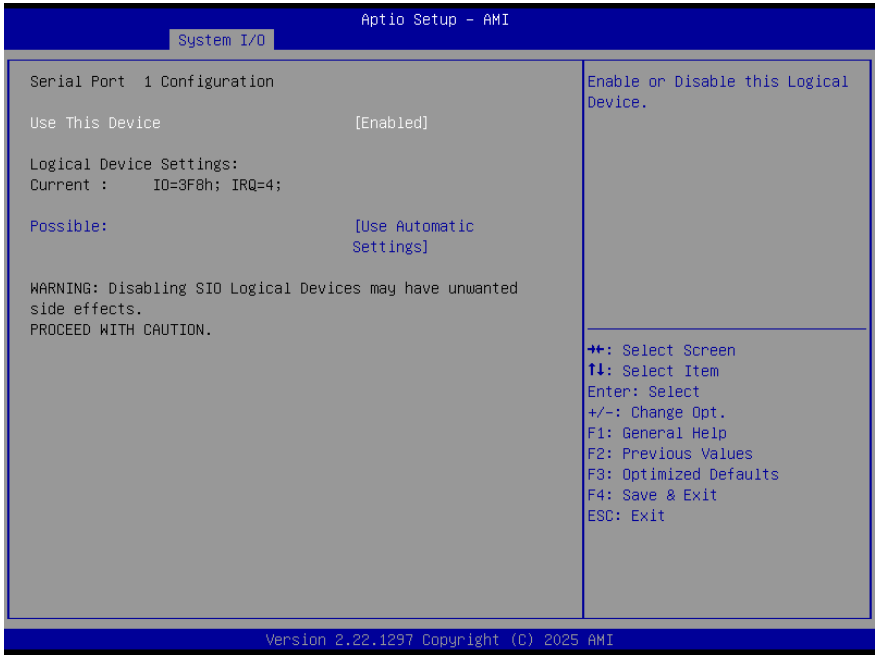

Options Summary		
Use This Device	Disabled	
	Enabled	Optimal Default, Failsafe Default
Enable or Disable this Logical Device.		
Possible:	Use Automatic Settings	Optimal Default, Failsafe Default
	IO=3F8h; IRQ=4; DMA;	
	IO=2C8h; IRQ=11; DMA;	
Allows the user to change the device resource settings. New settings will be reflected on this setup page after system restarts.		

3.5.6.2 Serial Port 2 Configuration

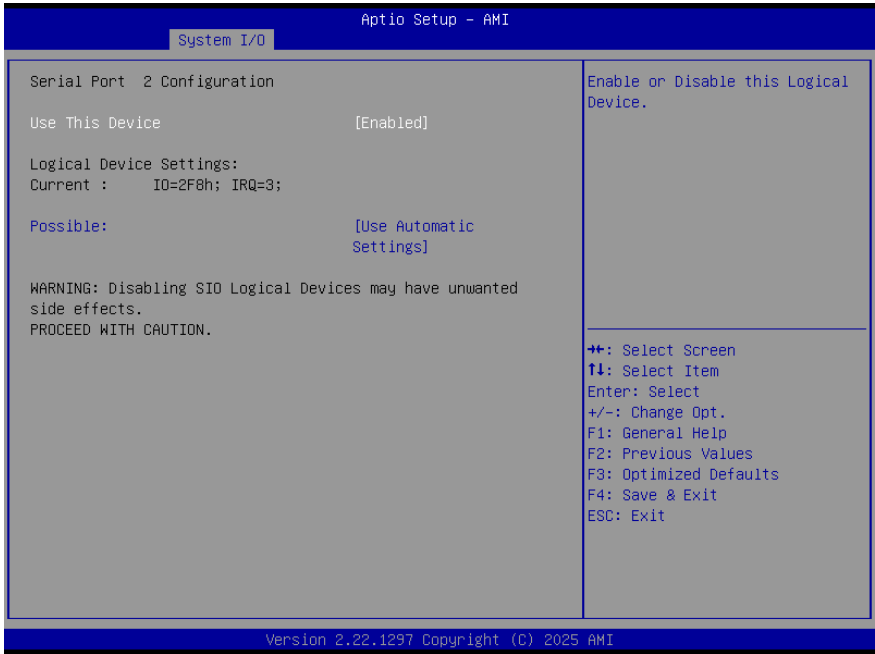

Options Summary		
Use This Device	Disabled	
	Enabled	Optimal Default, Failsafe Default
Enable or Disable this Logical Device.		
Possible:	Use Automatic Settings	Optimal Default, Failsafe Default
	IO=2F8h; IRQ=3; DMA;	
	IO=2D8h; IRQ=10; DMA;	
Allows user to change the device resource settings. New settings will be reflected on this setup page after system restarts.		

3.5.7 Serial Port Console Redirection

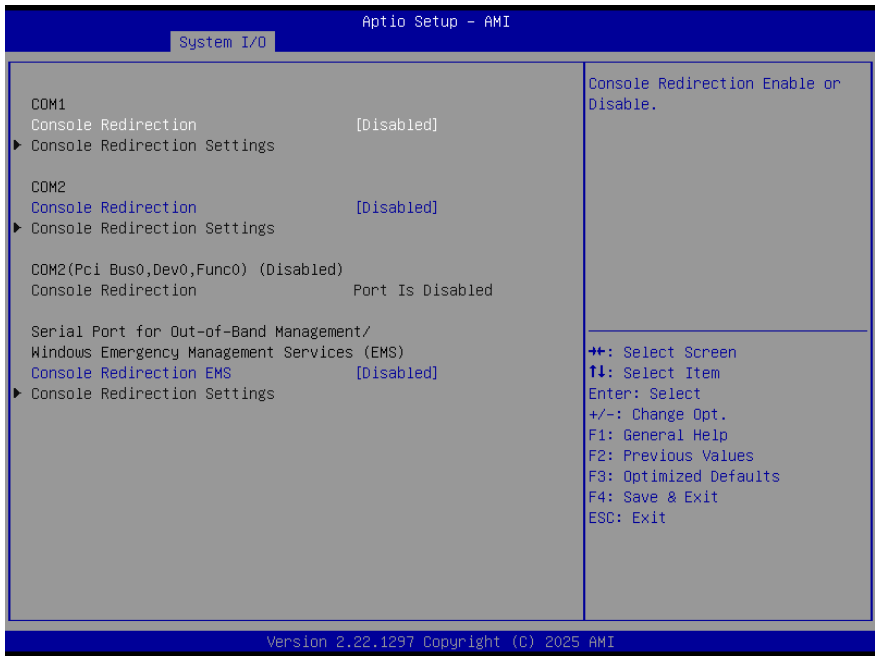

Options Summary		
Console Redirection (COM1)	Disabled	Optimal Default, Failsafe Default
	Enabled	
Console Redirection Enable or Disable.		
Console Redirection (COM2)	Disabled	Optimal Default, Failsafe Default
	Enabled	
Console Redirection Enable or Disable.		
Console Redirection EMS	Disabled	Optimal Default, Failsafe Default
	Enabled	
Console Redirection Enable or Disable.		

3.6 Setup Submenu: Security



Change Administrator/User Password

You can set an Administrator password. If you set an Administrator password, you can then set a User password. User passwords do not have access to many of the features in the Setup utility.

Select the password you want to set and press <Enter>. A dialog box will appear which lets you set the password. Passwords must be between 3 and 20 letters or numbers. Press <Enter> and re-enter the password into the next dialog box that appears. Press <Enter> after you have retyped it correctly. The password is required at boot time, or when the user enters the Setup utility.

Remove Password

Highlight this item and type in the current password. At the next dialog box press <Enter> to disable password protection.

Options Summary

BIOS Lock	Disabled	Optimal Default, Failsafe Default
	Enabled	

Enable or disable the PCH BIOS Lock feature. Must be enabled to ensure SMM protection of the flash.

3.6.1 Trusted Computing

Aptio Setup - AMI

Security		
TPM 2.0 Device Found Firmware Version: 700.19 Vendor: INTC Security Device Support [Enabled] Active PCR banks SHA256 Available PCR banks SHA256,SHA384,SM3 SHA256 PCR Bank [Enabled] SHA384 PCR Bank [Disabled] SM3_256 PCR Bank [Disabled] Pending operation [None] Platform Hierarchy [Enabled] Storage Hierarchy [Enabled] Endorsement Hierarchy [Enabled] Physical Presence Spec Version [1.3] TPM 2.0 InterfaceType [CRB] Device Select [Auto]	Enables or Disables BIOS support for security device. O.S. will not show Security Device. TCG EFI protocol and INT1A interface will not be available.	
		++: Select Screen ↑↓: Select Item Enter: Select +/-: Change Opt. F1: General Help F2: Previous Values F3: Optimized Defaults F4: Save & Exit ESC: Exit

Version 2.22.1297 Copyright (C) 2025 AMI

Options Summary

Security Device Support	Disabled	Optimal Default, Failsafe Default
	Enabled	

Enable or disable BIOS support for the security device.

If Disabled, the OS will not detect the Security Device, and TCG EFI protocol and INT1A interface will be unavailable.

SHA256 PCR Bank	Disabled	Optimal Default, Failsafe Default
	Enabled	

Enable or Disable SHA256 PCR Bank.

Options Summary		
SHA384 PCR Bank	Disabled	Optimal Default, Failsafe Default
	Enabled	
Enable or Disable SHA384 PCR Bank.		
SM3_256 PCR Bank	Disabled	Optimal Default, Failsafe Default
	Enabled	
Enable or Disable SM3_256 PCR Bank.		
Pending Operation	None	Optimal Default, Failsafe Default
	TPM Clear	
Set a scheduled operation for the Security Device. Note: The system will reboot to apply changes to the Security Device state.		
Platform Hierarchy	Disabled	
	Enabled	Optimal Default, Failsafe Default
Enable or disable Platform Hierarchy.		
Storage Hierarchy	Disabled	
	Enabled	Optimal Default, Failsafe Default
Enable or Disable Storage Hierarchy.		
Endorsement Hierarchy	Disabled	
	Enabled	Optimal Default, Failsafe Default
Enable or Disable Endorsement Hierarchy.		
Physical Presence Spec Version	1.2	
	1.3	Optimal Default, Failsafe Default
Select the PPI specification version for OS support: 1.2 or 1.3. Note: Some HCK tests may not support version 1.3.		
Device Select	TPM 1.2	
	TPM 2.0	
	Auto	Optimal Default, Failsafe Default

3.6.2 Secure Boot



Options Summary		
Secure Boot	Disabled	Optimal Default, Failsafe Default
	Enabled	
Secure Boot feature is Active if Secure Boot is Enabled, Platform Key (PK) is enrolled and the System is in User mode. The mode change requires platform reset.		
Secure Boot Mode	Standard	
	Custom	Optimal Default, Failsafe Default
Secure Boot mode options: Standard or Custom. In Custom mode, Secure Boot Policy variables can be configured by a physically present user without full authentication.		
Restore Factory Keys		
Force System to User Mode. Install factory default Secure Boot key databases.		

3.6.3 Key Management

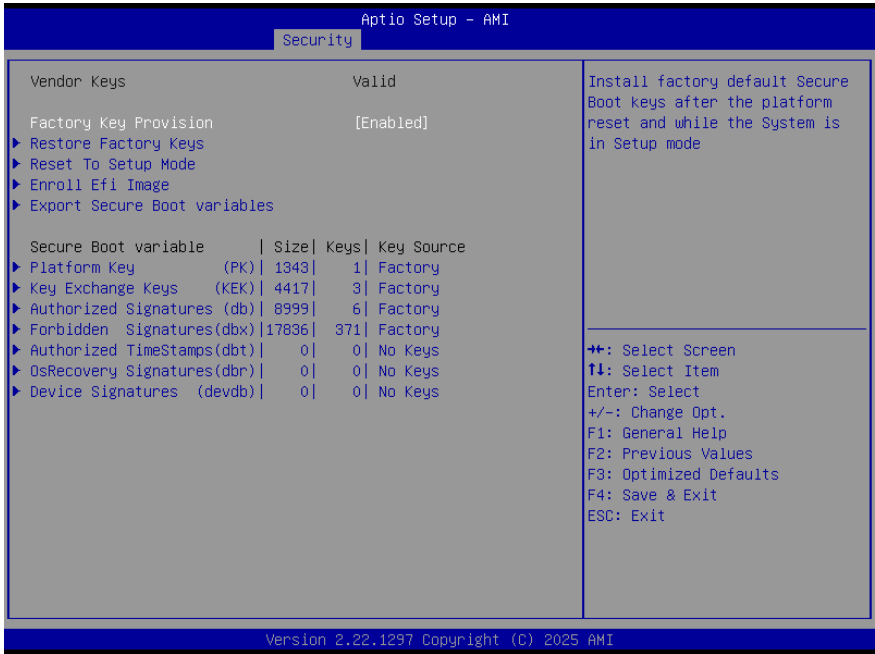

Options Summary		
Factory Key Provision	Disabled	
	Enabled	Optimal Default, Failsafe Default
Installs the factory default Secure Boot keys after platform reset while the system is in Setup mode.		
Restore Factory Keys		
Forces the system into User Mode and installs the factory default Secure Boot key databases.		
Reset to Setup Mode		
Deletes all Secure Boot key databases from NVRAM, placing the system in Setup Mode.		
Export Secure Boot variables		
Saves the NVRAM contents of Secure Boot variables to a file.		
Enroll Efi Image		
Allows the image to run in Secure Boot mode by enrolling its SHA256 hash certificate into the Authorized Signature Database (db).		

Options Summary	
Platform Key (PK)	Details
	Export
	Update
	Delete
Key Exchange Keys (KEK)	Details
	Export
	Update
	Append
	Delete
Authorized Signatures (db)	Details
	Export
	Update
	Append
	Delete
Forbidden Signatures (dbx)	Details
	Export
	Update
	Append
	Delete
Authorized TimeStamps (dbt)	Update
	Append
OsRecovery Signatures (dbr)	Update
	Append
Device Signatures (devdb)	Update
	Append
Enroll Factory Defaults or load certificates from a file: Public Key Certificate: <ul style="list-style-type: none"> a) EFI_SIGNATURE_LIST b) EFI_CERT_X509 (DER) c) EFI_CERT_RSA2048 (bin) d) EFI_CERT_SHAXXX Authenticated UEFI Variable EFI PE/COFF Image (SHA256) Key Source: Factory, Modified, Mixed	

3.7 Setup Submenu: Boot

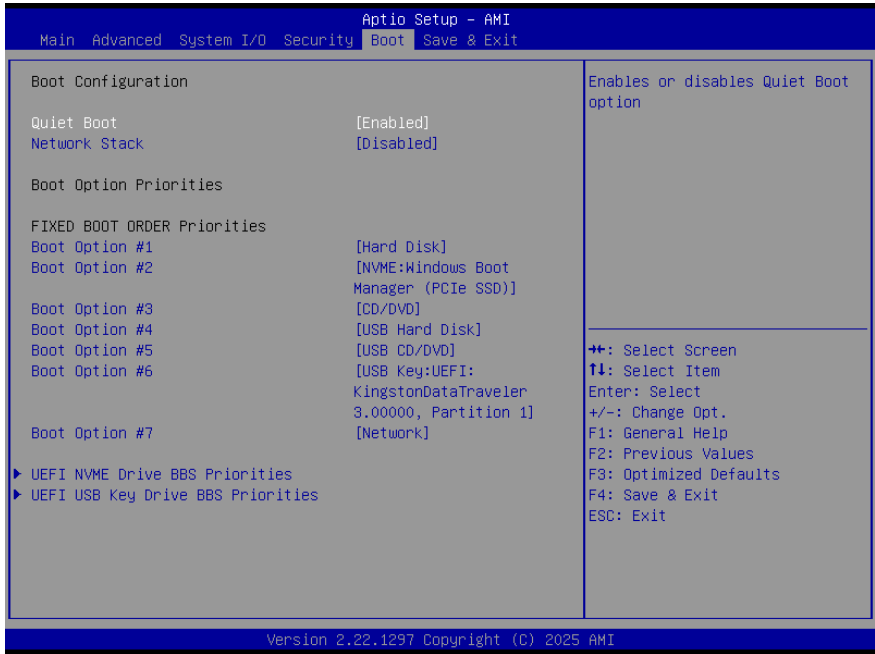

Options Summary		
Quiet Boot	Disabled	
	Enabled	Optimal Default, Failsafe Default
Enables or disables Quiet Boot option		
Network Stack	Disabled	Optimal Default, Failsafe Default
	Enabled	
Enable/Disable UEFI Network Stack.		

3.8 Setup Submenu: Save & Exit

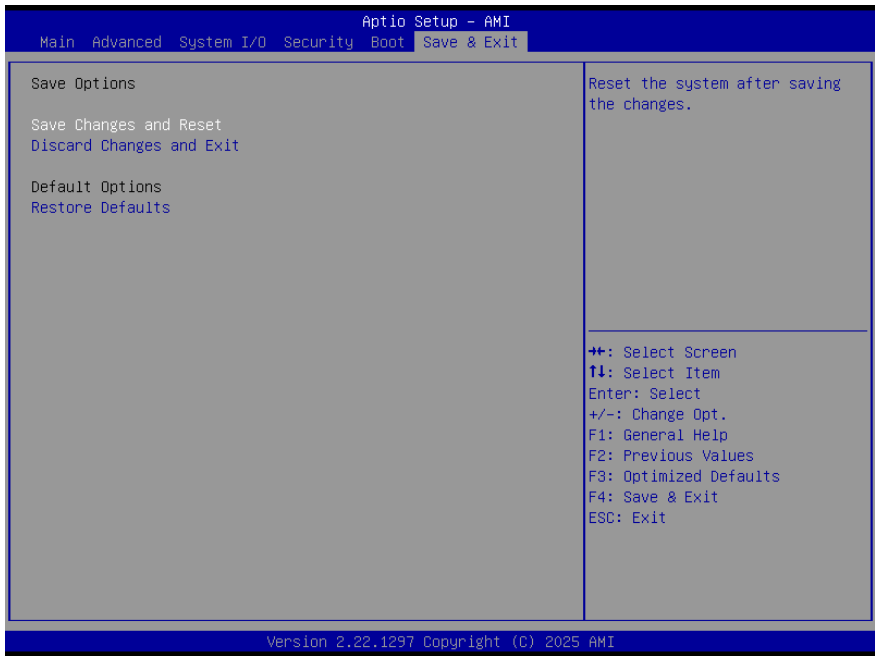

Chapter 4

Drivers Installation

4.1 Drivers Download and Installation

Drivers for the HPC-ARHm can be downloaded from the product page on the AAEON website by following this link:

https://www.aaeon.com/en/product/detail/computing_on_module_hpc-arhm/download

Download the driver(s) you need and follow the steps below to install them.

Chipset Driver

1. Open the folder where you unzipped the **Chipset Drivers**
2. Run the **SetupChipset.exe** file in the folder
3. Follow the instructions
4. Drivers will be installed automatically

Graphics Driver

1. Open the folder where you unzipped the **Graphics Drivers**
2. Run the **Installer.exe** file in the folder
3. Follow the instructions
4. Drivers will be installed automatically
5. Refer to the ReadMe.txt for any assistance.

LAN Drivers

1. Open the folder where you unzipped the **LAN Drivers**
2. Read the readme file before proceeding. Caution: Some drivers may require firmware updates first.
3. Identify the subfolder that matches your hardware: choose one of **PRO40GB, PRO1000, PRO2500, PROAVF, PROCGB, PROXGB, RDMA**.
4. Open the appropriate folder for your device, then run the executable file in that folder (e.g., setup.exe or [driver_name].exe).
5. Follow the instructions, drivers will be installed automatically.
6. If your device supports management or additional applications, optionally install software from the **APPS** folder.
7. To update firmware, open the **NVMUpdatePackage** folder and follow the instructions in its readme.

ME Driver

1. Open the folder where you unzipped the **ME & TXE Drivers**
2. Run the **SetupME.exe** file in the folder
3. Follow the instructions
4. Drivers will be installed automatically
5. Refer to the ReadMe.txt for any assistance.

Serial I/O Drivers

1. Open the folder where you unzipped the **Serial I/O Drivers**
2. Identify the drivers you need based on your system hardware:
 - i. **iaLPSS2_GPIO2_MTL**
 - ii. **iaLPSS2_I2C_MTL**
 - iii. **iaLPSS2_13C_MTL**
 - iv. **iaLPSS2_SPI_MTL**
 - v. **iaLPSS2_UART2_MTL**
3. Open the folder for the driver you want to install.
4. Run the corresponding setup file (e.g., iaLPSS2_GPIO2_MTL.sys or setup.exe if provided), then follow the on-screen instructions; the driver will be installed automatically.
5. Repeat steps 4–6 for each additional driver required by your system.
6. After all drivers are installed, restart to complete the installation.

Intel® NPU Drivers

1. Open the folder where you unzipped the **Peripheral Drivers**
2. Identify the drivers you need based on your system hardware:
 - i. **npu_driver_compiler.dll**
 - ii. **npu_extension.dll**
 - iii. **npu_level_zero_umd.dll**
 - iv. **tbb12.dll**
 - v. **tbbmalloc.dll**
 - vi. **ze_loader.dll**
 - vii. **ze_tracing_layer.dll**
 - viii. **ze_validation_layer.dll**
3. Run the setup program if provided, or manually install the .sys and .dll files according to the instructions in the readme.
4. Follow the on-screen instructions; drivers and supporting libraries will be installed automatically.

Intel® Platform Monitoring Technology Driver

1. Open the folder where you unzipped the **Peripheral Drivers**
2. Locate the **IntcPMT.sys** file.
3. Run the setup program if provided, or manually install the .sys file according to the instructions in the readme.
4. Follow the on-screen instructions; the driver will be installed automatically.

Intel® GNA Driver

1. Open the folder where you unzipped the **Peripheral Drivers**
2. Locate the **gna.sys** file (system driver) and **gna.pdb** file (debug information).
3. Run the setup program if provided, or manually install the .sys file according to the instructions in the readme.
4. Follow the on-screen instructions; the driver will be installed automatically.

Realtek Audio Driver

1. Open the folder where you unzipped the **Audio Driver**
2. Run the **Setup.exe** file in the folder
3. Follow the instructions
4. Drivers will be installed automatically
5. Refer to the ReadMe.txt for any assistance.













































RAID Driver

1. Open the folder where you unzipped the **RAID Driver**
2. Run the **SetupRST.exe** file in the folder
3. Follow the instructions
4. Drivers will be installed automatically
5. Refer to the ReadMe.txt for any assistance.

Appendix A

I/O Information



A.1 I/O Address Map

▼		Input/output (IO)	
		[0000000000000000 - 000000000000CF7]	PCI Express Root Complex
		[0000000000000020 - 0000000000000021]	Programmable interrupt controller
		[0000000000000024 - 0000000000000025]	Programmable interrupt controller
		[0000000000000028 - 0000000000000029]	Programmable interrupt controller
		[000000000000002C - 000000000000002D]	Programmable interrupt controller
		[000000000000002E - 000000000000002F]	Motherboard resources
		[0000000000000030 - 0000000000000031]	Programmable interrupt controller
		[0000000000000034 - 0000000000000035]	Programmable interrupt controller
		[0000000000000038 - 0000000000000039]	Programmable interrupt controller
		[000000000000003C - 000000000000003D]	Programmable interrupt controller
		[0000000000000040 - 0000000000000043]	System timer
		[000000000000004E - 000000000000004F]	Motherboard resources
		[0000000000000050 - 0000000000000053]	System timer
		[0000000000000061 - 0000000000000061]	Motherboard resources
		[0000000000000063 - 0000000000000063]	Motherboard resources
		[0000000000000065 - 0000000000000065]	Motherboard resources
		[0000000000000067 - 0000000000000067]	Motherboard resources
		[0000000000000068 - 0000000000000068]	Microsoft ACPI-Compliant Embedded Controller
		[000000000000006C - 000000000000006C]	Microsoft ACPI-Compliant Embedded Controller
		[0000000000000070 - 0000000000000070]	Motherboard resources
		[0000000000000080 - 0000000000000080]	Motherboard resources
		[0000000000000092 - 0000000000000092]	Motherboard resources
		[00000000000000A0 - 00000000000000A1]	Programmable interrupt controller
		[00000000000000A4 - 00000000000000A5]	Programmable interrupt controller
		[00000000000000A8 - 00000000000000A9]	Programmable interrupt controller
		[00000000000000AC - 00000000000000AD]	Programmable interrupt controller
		[00000000000000B0 - 00000000000000B1]	Programmable interrupt controller
		[00000000000000B2 - 00000000000000B3]	Motherboard resources
		[00000000000000B4 - 00000000000000B5]	Programmable interrupt controller
		[00000000000000B8 - 00000000000000B9]	Programmable interrupt controller
		[00000000000000BC - 00000000000000BD]	Programmable interrupt controller
		[0000000000002F8 - 0000000000002FF]	Communications Port (COM2)
		[0000000000003F8 - 0000000000003FF]	Communications Port (COM1)
		[0000000000004D0 - 0000000000004D1]	Programmable interrupt controller
		[000000000000680 - 00000000000069F]	Motherboard resources
		[000000000000D00 - 000000000000FFFF]	PCI Express Root Complex
		[00000000000164E - 00000000000164F]	Motherboard resources
		[000000000001854 - 000000000001857]	Motherboard resources
		[000000000002000 - 0000000000020FE]	Motherboard resources
		[000000000003020 - 00000000000303F]	Standard SATA AHCI Controller
		[000000000003040 - 000000000003043]	Standard SATA AHCI Controller
		[000000000003050 - 000000000003057]	Standard SATA AHCI Controller
		[00000000000EFA0 - 00000000000EFBF]	Intel (R) SMBus - 7722



















































A.2 Memory Address Map



















































Address Range	Device Name
[0000000000000000 - 0000000000000FFF]	Motherboard resources
[0000000000000000 - 0000000000000FFF]	Motherboard resources
[0000000000A00000 - 00000000000BFFFF]	PCI Express Root Complex
[0000000080000000 - 0000000080FFFFFF]	Intel RST VMD Controller 7D0B
[0000000080000000 - 00000000BFFFFFFF]	PCI Express Root Complex
[0000000081000000 - 00000000810FFFFFFF]	Intel(R) Ethernet Controller I226-IT #2
[0000000081000000 - 00000000811FFFFFFF]	PCI Express Root Port
[0000000081100000 - 0000000081103FFF]	Intel(R) Ethernet Controller I226-IT #2
[0000000081200000 - 00000000812FFFFFFF]	Intel(R) Ethernet Controller I226-IT
[0000000081200000 - 00000000813FFFFFFF]	PCI Express Root Port
[0000000081300000 - 0000000081303FFF]	Intel(R) Ethernet Controller I226-IT
[0000000081400000 - 0000000081403FFF]	Standard NVM Express Controller
[0000000081400000 - 00000000814FFFFFFF]	PCI Express Root Port
[0000000081500000 - 0000000081501FFF]	Standard SATA AHCI Controller
[0000000081502000 - 00000000815027FF]	Standard SATA AHCI Controller
[0000000081503000 - 00000000815030FF]	Standard SATA AHCI Controller
[00000000C0000000 - 00000000CFFFFFFF]	Motherboard resources
[00000000E0D10000 - 00000000E0D1FFFF]	Intel(R) Serial IO GPIO Host Controller - INTC105E
[00000000E0D20000 - 00000000E0D2FFFF]	Intel(R) Serial IO GPIO Host Controller - INTC105E
[00000000E0D30000 - 00000000E0D3FFFF]	Intel(R) Serial IO GPIO Host Controller - INTC105E
[00000000E0D40000 - 00000000E0D4FFFF]	Intel(R) Serial IO GPIO Host Controller - INTC105E
[00000000E0D50000 - 00000000E0D5FFFF]	Intel(R) Serial IO GPIO Host Controller - INTC105E
[00000000FC800000 - 00000000FC81FFFF]	Motherboard resources
[00000000FE010000 - 00000000FE010FFF]	Intel (R) SPI (flash) controller - 7723
[00000000FED00000 - 00000000FED003FF]	High precision event timer
[00000000FED20000 - 00000000FED7FFFF]	Motherboard resources
[00000000FED40000 - 00000000FED44FFF]	Trusted Platform Module 2.0
[00000000FED45000 - 00000000FED8FFFF]	Motherboard resources
[00000000FEDC0000 - 00000000FEDC7FFF]	Motherboard resources
[00000000FEE00000 - 00000000FEEFFFFFFF]	Motherboard resources
[0000004000000000 - 000000400FFFFFFF]	Intel(R) Arc(TM) 140T GPU (16GB)
[0000004017000000 - 0000004017FFFFFFF]	Intel(R) Arc(TM) 140T GPU (16GB)
[0000004020000000 - 0000004021FFFFFFF]	Intel RST VMD Controller 7D0B
[0000004022000000 - 0000004022FFFFFFF]	Intel RST VMD Controller 7D0B
[0000004023240000 - 000000402324FFFF]	Intel(R) USB 3.20 eXtensible Host Controller - 1.20 (Microsoft)
[0000004023250000 - 000000402325FFFF]	Intel(R) USB 3.20 eXtensible Host Controller - 1.20 (Microsoft)
[0000004023268000 - 00000040232680FF]	Intel (R) SMBus - 7722
[0000004023269000 - 00000040232690FF]	Intel(R) Management Engine Interface #1
[000003FFB0000000 - 000003FFB7FFFFFFF]	Intel(R) AI Boost
[000003FFBFC00000 - 000003FFBFDFFFFFFF]	High Definition Audio Controller
[000003FFBFB70000 - 000003FFBFB77FFF]	Intel(R) Serial IO I2C Host Controller - 7778
[000003FFBFB80000 - 000003FFBFB87FFF]	Intel(R) Serial IO I2C Host Controller - 777A
[000003FFBFB90000 - 000003FFBFB97FFF]	Intel(R) Serial IO I2C Host Controller - 777B
[000003FFBFBFA000 - 000003FFBFBFAFFF]	Intel(R) AI Boost
[000003FFBFBFB000 - 000003FFBFBFBFFF]	Intel(R) GNA Scoring Accelerator module
[000003FFBFBFC000 - 000003FFBFBFBFFF]	High Definition Audio Controller
[000003FFBFFC0000 - 000003FFBFFBFFFF]	Intel(R) Platform Monitoring Technology (PMT) Driver



















































A.3 Large Memory Address Map









































- ▼  Large Memory
 -  [0000004000000000 - 000003FFBFFFFFFF] PCI Express Root Complex



















































A.4 IRQ Mapping Chart













































▼		Interrupt request (IRQ)
		(ISA) 0x00000000 (00) System timer
		(ISA) 0x00000003 (03) Communications Port (COM2)
		(ISA) 0x00000004 (04) Communications Port (COM1)
		(ISA) 0x0000000E (14) Intel(R) Serial IO GPIO Host Controller - INTC105E
		(ISA) 0x00000037 (55) Microsoft ACPI-Compliant System
		(ISA) 0x00000038 (56) Microsoft ACPI-Compliant System
		(ISA) 0x00000039 (57) Microsoft ACPI-Compliant System
		(ISA) 0x0000003A (58) Microsoft ACPI-Compliant System
		(ISA) 0x0000003B (59) Microsoft ACPI-Compliant System
		(ISA) 0x0000003C (60) Microsoft ACPI-Compliant System
		(ISA) 0x0000003D (61) Microsoft ACPI-Compliant System
		(ISA) 0x0000003E (62) Microsoft ACPI-Compliant System
		(ISA) 0x0000003F (63) Microsoft ACPI-Compliant System
		(ISA) 0x00000040 (64) Microsoft ACPI-Compliant System
		(ISA) 0x00000041 (65) Microsoft ACPI-Compliant System
		(ISA) 0x00000042 (66) Microsoft ACPI-Compliant System
		(ISA) 0x00000043 (67) Microsoft ACPI-Compliant System
		(ISA) 0x00000044 (68) Microsoft ACPI-Compliant System
		(ISA) 0x00000045 (69) Microsoft ACPI-Compliant System
		(ISA) 0x00000046 (70) Microsoft ACPI-Compliant System
		(ISA) 0x00000047 (71) Microsoft ACPI-Compliant System
		(ISA) 0x00000048 (72) Microsoft ACPI-Compliant System
		(ISA) 0x00000049 (73) Microsoft ACPI-Compliant System
		(ISA) 0x0000004A (74) Microsoft ACPI-Compliant System
		(ISA) 0x0000004B (75) Microsoft ACPI-Compliant System
		(ISA) 0x0000004C (76) Microsoft ACPI-Compliant System
		(ISA) 0x0000004D (77) Microsoft ACPI-Compliant System
		(ISA) 0x0000004E (78) Microsoft ACPI-Compliant System
		(ISA) 0x0000004F (79) Microsoft ACPI-Compliant System
		(ISA) 0x00000050 (80) Microsoft ACPI-Compliant System
		(ISA) 0x00000051 (81) Microsoft ACPI-Compliant System
		(ISA) 0x00000052 (82) Microsoft ACPI-Compliant System
		(ISA) 0x00000053 (83) Microsoft ACPI-Compliant System
		(ISA) 0x00000054 (84) Microsoft ACPI-Compliant System
		(ISA) 0x00000055 (85) Microsoft ACPI-Compliant System
		(ISA) 0x00000056 (86) Microsoft ACPI-Compliant System
		(ISA) 0x00000057 (87) Microsoft ACPI-Compliant System
		(ISA) 0x00000058 (88) Microsoft ACPI-Compliant System
		(ISA) 0x00000059 (89) Microsoft ACPI-Compliant System
		(ISA) 0x0000005A (90) Microsoft ACPI-Compliant System
		(ISA) 0x0000005B (91) Microsoft ACPI-Compliant System
		(ISA) 0x0000005C (92) Microsoft ACPI-Compliant System
		(ISA) 0x0000005D (93) Microsoft ACPI-Compliant System
		(ISA) 0x0000005E (94) Microsoft ACPI-Compliant System
		(ISA) 0x0000005F (95) Microsoft ACPI-Compliant System
		(ISA) 0x00000060 (96) Microsoft ACPI-Compliant System
		(ISA) 0x00000061 (97) Microsoft ACPI-Compliant System
		(ISA) 0x00000062 (98) Microsoft ACPI-Compliant System
		(ISA) 0x00000063 (99) Microsoft ACPI-Compliant System
		(ISA) 0x00000064 (100) Microsoft ACPI-Compliant System



















































 (ISA) 0x0000065 (101)	Microsoft ACPI-Compliant System
 (ISA) 0x0000066 (102)	Microsoft ACPI-Compliant System
 (ISA) 0x0000067 (103)	Microsoft ACPI-Compliant System
 (ISA) 0x0000068 (104)	Microsoft ACPI-Compliant System
 (ISA) 0x0000069 (105)	Microsoft ACPI-Compliant System
 (ISA) 0x000006A (106)	Microsoft ACPI-Compliant System
 (ISA) 0x000006B (107)	Microsoft ACPI-Compliant System
 (ISA) 0x000006C (108)	Microsoft ACPI-Compliant System
 (ISA) 0x000006D (109)	Microsoft ACPI-Compliant System
 (ISA) 0x000006E (110)	Microsoft ACPI-Compliant System
 (ISA) 0x000006F (111)	Microsoft ACPI-Compliant System
 (ISA) 0x0000070 (112)	Microsoft ACPI-Compliant System
 (ISA) 0x0000071 (113)	Microsoft ACPI-Compliant System
 (ISA) 0x0000072 (114)	Microsoft ACPI-Compliant System
 (ISA) 0x0000073 (115)	Microsoft ACPI-Compliant System
 (ISA) 0x0000074 (116)	Microsoft ACPI-Compliant System
 (ISA) 0x0000075 (117)	Microsoft ACPI-Compliant System
 (ISA) 0x0000076 (118)	Microsoft ACPI-Compliant System
 (ISA) 0x0000077 (119)	Microsoft ACPI-Compliant System
 (ISA) 0x0000078 (120)	Microsoft ACPI-Compliant System
 (ISA) 0x0000079 (121)	Microsoft ACPI-Compliant System
 (ISA) 0x000007A (122)	Microsoft ACPI-Compliant System
 (ISA) 0x000007B (123)	Microsoft ACPI-Compliant System
 (ISA) 0x000007C (124)	Microsoft ACPI-Compliant System
 (ISA) 0x000007D (125)	Microsoft ACPI-Compliant System
 (ISA) 0x000007E (126)	Microsoft ACPI-Compliant System
 (ISA) 0x000007F (127)	Microsoft ACPI-Compliant System
 (ISA) 0x0000080 (128)	Microsoft ACPI-Compliant System
 (ISA) 0x0000081 (129)	Microsoft ACPI-Compliant System
 (ISA) 0x0000082 (130)	Microsoft ACPI-Compliant System
 (ISA) 0x0000083 (131)	Microsoft ACPI-Compliant System
 (ISA) 0x0000084 (132)	Microsoft ACPI-Compliant System
 (ISA) 0x0000085 (133)	Microsoft ACPI-Compliant System
 (ISA) 0x0000086 (134)	Microsoft ACPI-Compliant System
 (ISA) 0x0000087 (135)	Microsoft ACPI-Compliant System
 (ISA) 0x0000088 (136)	Microsoft ACPI-Compliant System
 (ISA) 0x0000089 (137)	Microsoft ACPI-Compliant System
 (ISA) 0x000008A (138)	Microsoft ACPI-Compliant System
 (ISA) 0x000008B (139)	Microsoft ACPI-Compliant System
 (ISA) 0x000008C (140)	Microsoft ACPI-Compliant System
 (ISA) 0x000008D (141)	Microsoft ACPI-Compliant System
 (ISA) 0x000008E (142)	Microsoft ACPI-Compliant System
 (ISA) 0x000008F (143)	Microsoft ACPI-Compliant System
 (ISA) 0x0000090 (144)	Microsoft ACPI-Compliant System
 (ISA) 0x0000091 (145)	Microsoft ACPI-Compliant System
 (ISA) 0x0000092 (146)	Microsoft ACPI-Compliant System
 (ISA) 0x0000093 (147)	Microsoft ACPI-Compliant System
 (ISA) 0x0000094 (148)	Microsoft ACPI-Compliant System
 (ISA) 0x0000095 (149)	Microsoft ACPI-Compliant System
 (ISA) 0x0000096 (150)	Microsoft ACPI-Compliant System
 (ISA) 0x0000097 (151)	Microsoft ACPI-Compliant System















































 (ISA) 0x00000098 (152)	Microsoft ACPI-Compliant System
 (ISA) 0x00000099 (153)	Microsoft ACPI-Compliant System
 (ISA) 0x0000009A (154)	Microsoft ACPI-Compliant System
 (ISA) 0x0000009B (155)	Microsoft ACPI-Compliant System
 (ISA) 0x0000009C (156)	Microsoft ACPI-Compliant System
 (ISA) 0x0000009D (157)	Microsoft ACPI-Compliant System
 (ISA) 0x0000009E (158)	Microsoft ACPI-Compliant System
 (ISA) 0x0000009F (159)	Microsoft ACPI-Compliant System
 (ISA) 0x000000A0 (160)	Microsoft ACPI-Compliant System
 (ISA) 0x000000A1 (161)	Microsoft ACPI-Compliant System
 (ISA) 0x000000A2 (162)	Microsoft ACPI-Compliant System
 (ISA) 0x000000A3 (163)	Microsoft ACPI-Compliant System
 (ISA) 0x000000A4 (164)	Microsoft ACPI-Compliant System
 (ISA) 0x000000A5 (165)	Microsoft ACPI-Compliant System
 (ISA) 0x000000A6 (166)	Microsoft ACPI-Compliant System
 (ISA) 0x000000A7 (167)	Microsoft ACPI-Compliant System
 (ISA) 0x000000A8 (168)	Microsoft ACPI-Compliant System
 (ISA) 0x000000A9 (169)	Microsoft ACPI-Compliant System
 (ISA) 0x000000AA (170)	Microsoft ACPI-Compliant System
 (ISA) 0x000000AB (171)	Microsoft ACPI-Compliant System
 (ISA) 0x000000AC (172)	Microsoft ACPI-Compliant System
 (ISA) 0x000000AD (173)	Microsoft ACPI-Compliant System
 (ISA) 0x000000AE (174)	Microsoft ACPI-Compliant System
 (ISA) 0x000000AF (175)	Microsoft ACPI-Compliant System
 (ISA) 0x000000B0 (176)	Microsoft ACPI-Compliant System
 (ISA) 0x000000B1 (177)	Microsoft ACPI-Compliant System
 (ISA) 0x000000B2 (178)	Microsoft ACPI-Compliant System
 (ISA) 0x000000B3 (179)	Microsoft ACPI-Compliant System
 (ISA) 0x000000B4 (180)	Microsoft ACPI-Compliant System
 (ISA) 0x000000B5 (181)	Microsoft ACPI-Compliant System
 (ISA) 0x000000B6 (182)	Microsoft ACPI-Compliant System
 (ISA) 0x000000B7 (183)	Microsoft ACPI-Compliant System
 (ISA) 0x000000B8 (184)	Microsoft ACPI-Compliant System
 (ISA) 0x000000B9 (185)	Microsoft ACPI-Compliant System
 (ISA) 0x000000BA (186)	Microsoft ACPI-Compliant System
 (ISA) 0x000000BB (187)	Microsoft ACPI-Compliant System
 (ISA) 0x000000BC (188)	Microsoft ACPI-Compliant System
 (ISA) 0x000000BD (189)	Microsoft ACPI-Compliant System
 (ISA) 0x000000BE (190)	Microsoft ACPI-Compliant System
 (ISA) 0x000000BF (191)	Microsoft ACPI-Compliant System
 (ISA) 0x000000C0 (192)	Microsoft ACPI-Compliant System
 (ISA) 0x000000C1 (193)	Microsoft ACPI-Compliant System
 (ISA) 0x000000C2 (194)	Microsoft ACPI-Compliant System
 (ISA) 0x000000C3 (195)	Microsoft ACPI-Compliant System
 (ISA) 0x000000C4 (196)	Microsoft ACPI-Compliant System
 (ISA) 0x000000C5 (197)	Microsoft ACPI-Compliant System
 (ISA) 0x000000C6 (198)	Microsoft ACPI-Compliant System
 (ISA) 0x000000C7 (199)	Microsoft ACPI-Compliant System
 (ISA) 0x000000C8 (200)	Microsoft ACPI-Compliant System
 (ISA) 0x000000C9 (201)	Microsoft ACPI-Compliant System
 (ISA) 0x000000CA (202)	Microsoft ACPI-Compliant System



















































 (ISA) 0x00000CB (203)	Microsoft ACPI-Compliant System
 (ISA) 0x00000CC (204)	Microsoft ACPI-Compliant System
 (ISA) 0x00000100 (256)	Microsoft ACPI-Compliant System
 (ISA) 0x00000101 (257)	Microsoft ACPI-Compliant System
 (ISA) 0x00000102 (258)	Microsoft ACPI-Compliant System
 (ISA) 0x00000103 (259)	Microsoft ACPI-Compliant System
 (ISA) 0x00000104 (260)	Microsoft ACPI-Compliant System
 (ISA) 0x00000105 (261)	Microsoft ACPI-Compliant System
 (ISA) 0x00000106 (262)	Microsoft ACPI-Compliant System
 (ISA) 0x00000107 (263)	Microsoft ACPI-Compliant System
 (ISA) 0x00000108 (264)	Microsoft ACPI-Compliant System
 (ISA) 0x00000109 (265)	Microsoft ACPI-Compliant System
 (ISA) 0x0000010A (266)	Microsoft ACPI-Compliant System
 (ISA) 0x0000010B (267)	Microsoft ACPI-Compliant System
 (ISA) 0x0000010C (268)	Microsoft ACPI-Compliant System
 (ISA) 0x0000010D (269)	Microsoft ACPI-Compliant System
 (ISA) 0x0000010E (270)	Microsoft ACPI-Compliant System
 (ISA) 0x0000010F (271)	Microsoft ACPI-Compliant System
 (ISA) 0x00000110 (272)	Microsoft ACPI-Compliant System
 (ISA) 0x00000111 (273)	Microsoft ACPI-Compliant System
 (ISA) 0x00000112 (274)	Microsoft ACPI-Compliant System
 (ISA) 0x00000113 (275)	Microsoft ACPI-Compliant System
 (ISA) 0x00000114 (276)	Microsoft ACPI-Compliant System
 (ISA) 0x00000115 (277)	Microsoft ACPI-Compliant System
 (ISA) 0x00000116 (278)	Microsoft ACPI-Compliant System
 (ISA) 0x00000117 (279)	Microsoft ACPI-Compliant System
 (ISA) 0x00000118 (280)	Microsoft ACPI-Compliant System
 (ISA) 0x00000119 (281)	Microsoft ACPI-Compliant System
 (ISA) 0x0000011A (282)	Microsoft ACPI-Compliant System
 (ISA) 0x0000011B (283)	Microsoft ACPI-Compliant System
 (ISA) 0x0000011C (284)	Microsoft ACPI-Compliant System
 (ISA) 0x0000011D (285)	Microsoft ACPI-Compliant System
 (ISA) 0x0000011E (286)	Microsoft ACPI-Compliant System
 (ISA) 0x0000011F (287)	Microsoft ACPI-Compliant System
 (ISA) 0x00000120 (288)	Microsoft ACPI-Compliant System
 (ISA) 0x00000121 (289)	Microsoft ACPI-Compliant System
 (ISA) 0x00000122 (290)	Microsoft ACPI-Compliant System
 (ISA) 0x00000123 (291)	Microsoft ACPI-Compliant System
 (ISA) 0x00000124 (292)	Microsoft ACPI-Compliant System
 (ISA) 0x00000125 (293)	Microsoft ACPI-Compliant System
 (ISA) 0x00000126 (294)	Microsoft ACPI-Compliant System
(ISA) 0x00000127 (295)	Microsoft ACPI-Compliant System
(ISA) 0x00000128 (296)	Microsoft ACPI-Compliant System
(ISA) 0x00000129 (297)	Microsoft ACPI-Compliant System
(ISA) 0x0000012A (298)	Microsoft ACPI-Compliant System
(ISA) 0x0000012B (299)	Microsoft ACPI-Compliant System
(ISA) 0x0000012C (300)	Microsoft ACPI-Compliant System
(ISA) 0x0000012D (301)	Microsoft ACPI-Compliant System
(ISA) 0x0000012E (302)	Microsoft ACPI-Compliant System
(ISA) 0x0000012F (303)	Microsoft ACPI-Compliant System
(ISA) 0x00000130 (304)	Microsoft ACPI-Compliant System





 (ISA) 0x00000131 (305)	Microsoft ACPI-Compliant System
 (ISA) 0x00000132 (306)	Microsoft ACPI-Compliant System
 (ISA) 0x00000133 (307)	Microsoft ACPI-Compliant System
 (ISA) 0x00000134 (308)	Microsoft ACPI-Compliant System
 (ISA) 0x00000135 (309)	Microsoft ACPI-Compliant System
 (ISA) 0x00000136 (310)	Microsoft ACPI-Compliant System
 (ISA) 0x00000137 (311)	Microsoft ACPI-Compliant System
 (ISA) 0x00000138 (312)	Microsoft ACPI-Compliant System
 (ISA) 0x00000139 (313)	Microsoft ACPI-Compliant System
 (ISA) 0x0000013A (314)	Microsoft ACPI-Compliant System
 (ISA) 0x0000013B (315)	Microsoft ACPI-Compliant System
 (ISA) 0x0000013C (316)	Microsoft ACPI-Compliant System
 (ISA) 0x0000013D (317)	Microsoft ACPI-Compliant System
 (ISA) 0x0000013E (318)	Microsoft ACPI-Compliant System
 (ISA) 0x0000013F (319)	Microsoft ACPI-Compliant System
 (ISA) 0x00000140 (320)	Microsoft ACPI-Compliant System
 (ISA) 0x00000141 (321)	Microsoft ACPI-Compliant System
 (ISA) 0x00000142 (322)	Microsoft ACPI-Compliant System
 (ISA) 0x00000143 (323)	Microsoft ACPI-Compliant System
 (ISA) 0x00000144 (324)	Microsoft ACPI-Compliant System
 (ISA) 0x00000145 (325)	Microsoft ACPI-Compliant System
 (ISA) 0x00000146 (326)	Microsoft ACPI-Compliant System
 (ISA) 0x00000147 (327)	Microsoft ACPI-Compliant System
 (ISA) 0x00000148 (328)	Microsoft ACPI-Compliant System
 (ISA) 0x00000149 (329)	Microsoft ACPI-Compliant System
 (ISA) 0x0000014A (330)	Microsoft ACPI-Compliant System
 (ISA) 0x0000014B (331)	Microsoft ACPI-Compliant System
 (ISA) 0x0000014C (332)	Microsoft ACPI-Compliant System
 (ISA) 0x0000014D (333)	Microsoft ACPI-Compliant System
 (ISA) 0x0000014E (334)	Microsoft ACPI-Compliant System
 (ISA) 0x0000014F (335)	Microsoft ACPI-Compliant System
 (ISA) 0x00000150 (336)	Microsoft ACPI-Compliant System
 (ISA) 0x00000151 (337)	Microsoft ACPI-Compliant System
 (ISA) 0x00000152 (338)	Microsoft ACPI-Compliant System
 (ISA) 0x00000153 (339)	Microsoft ACPI-Compliant System
 (ISA) 0x00000154 (340)	Microsoft ACPI-Compliant System
 (ISA) 0x00000155 (341)	Microsoft ACPI-Compliant System
 (ISA) 0x00000156 (342)	Microsoft ACPI-Compliant System
 (ISA) 0x00000157 (343)	Microsoft ACPI-Compliant System
 (ISA) 0x00000158 (344)	Microsoft ACPI-Compliant System
 (ISA) 0x00000159 (345)	Microsoft ACPI-Compliant System
 (ISA) 0x0000015A (346)	Microsoft ACPI-Compliant System
 (ISA) 0x0000015B (347)	Microsoft ACPI-Compliant System
 (ISA) 0x0000015C (348)	Microsoft ACPI-Compliant System
 (ISA) 0x0000015D (349)	Microsoft ACPI-Compliant System
 (ISA) 0x0000015E (350)	Microsoft ACPI-Compliant System
 (ISA) 0x0000015F (351)	Microsoft ACPI-Compliant System
 (ISA) 0x00000160 (352)	Microsoft ACPI-Compliant System
 (ISA) 0x00000161 (353)	Microsoft ACPI-Compliant System
 (ISA) 0x00000162 (354)	Microsoft ACPI-Compliant System
 (ISA) 0x00000163 (355)	Microsoft ACPI-Compliant System

 (ISA) 0x00000164 (356)	Microsoft ACPI-Compliant System
 (ISA) 0x00000165 (357)	Microsoft ACPI-Compliant System
 (ISA) 0x00000166 (358)	Microsoft ACPI-Compliant System
 (ISA) 0x00000167 (359)	Microsoft ACPI-Compliant System
 (ISA) 0x00000168 (360)	Microsoft ACPI-Compliant System
 (ISA) 0x00000169 (361)	Microsoft ACPI-Compliant System
 (ISA) 0x0000016A (362)	Microsoft ACPI-Compliant System
 (ISA) 0x0000016B (363)	Microsoft ACPI-Compliant System
 (ISA) 0x0000016C (364)	Microsoft ACPI-Compliant System
 (ISA) 0x0000016D (365)	Microsoft ACPI-Compliant System
 (ISA) 0x0000016E (366)	Microsoft ACPI-Compliant System
 (ISA) 0x0000016F (367)	Microsoft ACPI-Compliant System
 (ISA) 0x00000170 (368)	Microsoft ACPI-Compliant System
 (ISA) 0x00000171 (369)	Microsoft ACPI-Compliant System
 (ISA) 0x00000172 (370)	Microsoft ACPI-Compliant System
 (ISA) 0x00000173 (371)	Microsoft ACPI-Compliant System
 (ISA) 0x00000174 (372)	Microsoft ACPI-Compliant System
 (ISA) 0x00000175 (373)	Microsoft ACPI-Compliant System
 (ISA) 0x00000176 (374)	Microsoft ACPI-Compliant System
 (ISA) 0x00000177 (375)	Microsoft ACPI-Compliant System
 (ISA) 0x00000178 (376)	Microsoft ACPI-Compliant System
 (ISA) 0x00000179 (377)	Microsoft ACPI-Compliant System
 (ISA) 0x0000017A (378)	Microsoft ACPI-Compliant System
 (ISA) 0x0000017B (379)	Microsoft ACPI-Compliant System
 (ISA) 0x0000017C (380)	Microsoft ACPI-Compliant System
 (ISA) 0x0000017D (381)	Microsoft ACPI-Compliant System
 (ISA) 0x0000017E (382)	Microsoft ACPI-Compliant System
 (ISA) 0x0000017F (383)	Microsoft ACPI-Compliant System
 (ISA) 0x00000180 (384)	Microsoft ACPI-Compliant System
 (ISA) 0x00000181 (385)	Microsoft ACPI-Compliant System
 (ISA) 0x00000182 (386)	Microsoft ACPI-Compliant System
 (ISA) 0x00000183 (387)	Microsoft ACPI-Compliant System
 (ISA) 0x00000184 (388)	Microsoft ACPI-Compliant System
 (ISA) 0x00000185 (389)	Microsoft ACPI-Compliant System
 (ISA) 0x00000186 (390)	Microsoft ACPI-Compliant System
 (ISA) 0x00000187 (391)	Microsoft ACPI-Compliant System
 (ISA) 0x00000188 (392)	Microsoft ACPI-Compliant System
 (ISA) 0x00000189 (393)	Microsoft ACPI-Compliant System
 (ISA) 0x0000018A (394)	Microsoft ACPI-Compliant System
 (ISA) 0x0000018B (395)	Microsoft ACPI-Compliant System
 (ISA) 0x0000018C (396)	Microsoft ACPI-Compliant System
 (ISA) 0x0000018D (397)	Microsoft ACPI-Compliant System
 (ISA) 0x0000018E (398)	Microsoft ACPI-Compliant System
 (ISA) 0x0000018F (399)	Microsoft ACPI-Compliant System
 (ISA) 0x00000190 (400)	Microsoft ACPI-Compliant System
(ISA) 0x00000191 (401)	Microsoft ACPI-Compliant System
(ISA) 0x00000192 (402)	Microsoft ACPI-Compliant System
(ISA) 0x00000193 (403)	Microsoft ACPI-Compliant System
(ISA) 0x00000194 (404)	Microsoft ACPI-Compliant System
(ISA) 0x00000195 (405)	Microsoft ACPI-Compliant System
(ISA) 0x00000196 (406)	Microsoft ACPI-Compliant System

 (ISA) 0x00000197 (407)	Microsoft ACPI-Compliant System
 (ISA) 0x00000198 (408)	Microsoft ACPI-Compliant System
 (ISA) 0x00000199 (409)	Microsoft ACPI-Compliant System
 (ISA) 0x0000019A (410)	Microsoft ACPI-Compliant System
 (ISA) 0x0000019B (411)	Microsoft ACPI-Compliant System
 (ISA) 0x0000019C (412)	Microsoft ACPI-Compliant System
 (ISA) 0x0000019D (413)	Microsoft ACPI-Compliant System
 (ISA) 0x0000019E (414)	Microsoft ACPI-Compliant System
 (ISA) 0x0000019F (415)	Microsoft ACPI-Compliant System
 (ISA) 0x000001A0 (416)	Microsoft ACPI-Compliant System
 (ISA) 0x000001A1 (417)	Microsoft ACPI-Compliant System
 (ISA) 0x000001A2 (418)	Microsoft ACPI-Compliant System
 (ISA) 0x000001A3 (419)	Microsoft ACPI-Compliant System
 (ISA) 0x000001A4 (420)	Microsoft ACPI-Compliant System
 (ISA) 0x000001A5 (421)	Microsoft ACPI-Compliant System
 (ISA) 0x000001A6 (422)	Microsoft ACPI-Compliant System
 (ISA) 0x000001A7 (423)	Microsoft ACPI-Compliant System
 (ISA) 0x000001A8 (424)	Microsoft ACPI-Compliant System
 (ISA) 0x000001A9 (425)	Microsoft ACPI-Compliant System
 (ISA) 0x000001AA (426)	Microsoft ACPI-Compliant System
 (ISA) 0x000001AB (427)	Microsoft ACPI-Compliant System
 (ISA) 0x000001AC (428)	Microsoft ACPI-Compliant System
 (ISA) 0x000001AD (429)	Microsoft ACPI-Compliant System
 (ISA) 0x000001AE (430)	Microsoft ACPI-Compliant System
 (ISA) 0x000001AF (431)	Microsoft ACPI-Compliant System
 (ISA) 0x000001B0 (432)	Microsoft ACPI-Compliant System
 (ISA) 0x000001B1 (433)	Microsoft ACPI-Compliant System
 (ISA) 0x000001B2 (434)	Microsoft ACPI-Compliant System
 (ISA) 0x000001B3 (435)	Microsoft ACPI-Compliant System
 (ISA) 0x000001B4 (436)	Microsoft ACPI-Compliant System
 (ISA) 0x000001B5 (437)	Microsoft ACPI-Compliant System
 (ISA) 0x000001B6 (438)	Microsoft ACPI-Compliant System
 (ISA) 0x000001B7 (439)	Microsoft ACPI-Compliant System
 (ISA) 0x000001B8 (440)	Microsoft ACPI-Compliant System
 (ISA) 0x000001B9 (441)	Microsoft ACPI-Compliant System
 (ISA) 0x000001BA (442)	Microsoft ACPI-Compliant System
 (ISA) 0x000001BB (443)	Microsoft ACPI-Compliant System
 (ISA) 0x000001BC (444)	Microsoft ACPI-Compliant System
 (ISA) 0x000001BD (445)	Microsoft ACPI-Compliant System
 (ISA) 0x000001BE (446)	Microsoft ACPI-Compliant System
 (ISA) 0x000001BF (447)	Microsoft ACPI-Compliant System
 (ISA) 0x000001C0 (448)	Microsoft ACPI-Compliant System
 (ISA) 0x000001C1 (449)	Microsoft ACPI-Compliant System
 (ISA) 0x000001C2 (450)	Microsoft ACPI-Compliant System
 (ISA) 0x000001C3 (451)	Microsoft ACPI-Compliant System
 (ISA) 0x000001C4 (452)	Microsoft ACPI-Compliant System
 (ISA) 0x000001C5 (453)	Microsoft ACPI-Compliant System
 (ISA) 0x000001C6 (454)	Microsoft ACPI-Compliant System
 (ISA) 0x000001C7 (455)	Microsoft ACPI-Compliant System
 (ISA) 0x000001C8 (456)	Microsoft ACPI-Compliant System
 (ISA) 0x000001C9 (457)	Microsoft ACPI-Compliant System

 (ISA) 0x00001CA (458)	Microsoft ACPI-Compliant System
 (ISA) 0x00001CB (459)	Microsoft ACPI-Compliant System
 (ISA) 0x00001CC (460)	Microsoft ACPI-Compliant System
 (ISA) 0x00001CD (461)	Microsoft ACPI-Compliant System
 (ISA) 0x00001CE (462)	Microsoft ACPI-Compliant System
 (ISA) 0x00001CF (463)	Microsoft ACPI-Compliant System
 (ISA) 0x00001D0 (464)	Microsoft ACPI-Compliant System
 (ISA) 0x00001D1 (465)	Microsoft ACPI-Compliant System
 (ISA) 0x00001D2 (466)	Microsoft ACPI-Compliant System
 (ISA) 0x00001D3 (467)	Microsoft ACPI-Compliant System
 (ISA) 0x00001D4 (468)	Microsoft ACPI-Compliant System
 (ISA) 0x00001D5 (469)	Microsoft ACPI-Compliant System
 (ISA) 0x00001D6 (470)	Microsoft ACPI-Compliant System
 (ISA) 0x00001D7 (471)	Microsoft ACPI-Compliant System
 (ISA) 0x00001D8 (472)	Microsoft ACPI-Compliant System
 (ISA) 0x00001D9 (473)	Microsoft ACPI-Compliant System
 (ISA) 0x00001DA (474)	Microsoft ACPI-Compliant System
 (ISA) 0x00001DB (475)	Microsoft ACPI-Compliant System
 (ISA) 0x00001DC (476)	Microsoft ACPI-Compliant System
 (ISA) 0x00001DD (477)	Microsoft ACPI-Compliant System
 (ISA) 0x00001DE (478)	Microsoft ACPI-Compliant System
 (ISA) 0x00001DF (479)	Microsoft ACPI-Compliant System
 (ISA) 0x00001E0 (480)	Microsoft ACPI-Compliant System
 (ISA) 0x00001E1 (481)	Microsoft ACPI-Compliant System
 (ISA) 0x00001E2 (482)	Microsoft ACPI-Compliant System
 (ISA) 0x00001E3 (483)	Microsoft ACPI-Compliant System
 (ISA) 0x00001E4 (484)	Microsoft ACPI-Compliant System
 (ISA) 0x00001E5 (485)	Microsoft ACPI-Compliant System
 (ISA) 0x00001E6 (486)	Microsoft ACPI-Compliant System
 (ISA) 0x00001E7 (487)	Microsoft ACPI-Compliant System
 (ISA) 0x00001E8 (488)	Microsoft ACPI-Compliant System
 (ISA) 0x00001E9 (489)	Microsoft ACPI-Compliant System
 (ISA) 0x00001EA (490)	Microsoft ACPI-Compliant System
 (ISA) 0x00001EB (491)	Microsoft ACPI-Compliant System
 (ISA) 0x00001EC (492)	Microsoft ACPI-Compliant System
 (ISA) 0x00001ED (493)	Microsoft ACPI-Compliant System
 (ISA) 0x00001EE (494)	Microsoft ACPI-Compliant System
 (ISA) 0x00001EF (495)	Microsoft ACPI-Compliant System
 (ISA) 0x00001F0 (496)	Microsoft ACPI-Compliant System
 (ISA) 0x00001F1 (497)	Microsoft ACPI-Compliant System
 (ISA) 0x00001F2 (498)	Microsoft ACPI-Compliant System
 (ISA) 0x00001F3 (499)	Microsoft ACPI-Compliant System
 (ISA) 0x00001F4 (500)	Microsoft ACPI-Compliant System
 (ISA) 0x00001F5 (501)	Microsoft ACPI-Compliant System
 (ISA) 0x00001F6 (502)	Microsoft ACPI-Compliant System
 (ISA) 0x00001F7 (503)	Microsoft ACPI-Compliant System
 (ISA) 0x00001F8 (504)	Microsoft ACPI-Compliant System
(ISA) 0x00001F9 (505)	Microsoft ACPI-Compliant System
(ISA) 0x00001FA (506)	Microsoft ACPI-Compliant System
(ISA) 0x00001FB (507)	Microsoft ACPI-Compliant System
(ISA) 0x00001FC (508)	Microsoft ACPI-Compliant System

 (ISA) 0x00001FD (509)	Microsoft ACPI-Compliant System
 (ISA) 0x00001FE (510)	Microsoft ACPI-Compliant System
 (ISA) 0x00001FF (511)	Microsoft ACPI-Compliant System
 (PCI) 0x0000010 (16)	High Definition Audio Controller
 (PCI) 0x0000020 (32)	Intel(R) Serial IO I2C Host Controller - 7778
 (PCI) 0x0000022 (34)	Intel(R) Serial IO I2C Host Controller - 777A
 (PCI) 0x0000023 (35)	Intel(R) Serial IO I2C Host Controller - 777B
 (PCI) 0xFFFFFCF (-49)	Intel(R) GNA Scoring Accelerator module
 (PCI) 0xFFFFFD0 (-48)	Intel(R) AI Boost
 (PCI) 0xFFFFFD1 (-47)	Intel(R) Arc(TM) 140T GPU (16GB)
 (PCI) 0xFFFFFD2 (-46)	Intel(R) USB 3.20 eXtensible Host Controller - 1.20 (Microsoft)
 (PCI) 0xFFFFFD3 (-45)	Intel(R) USB 3.20 eXtensible Host Controller - 1.20 (Microsoft)
 (PCI) 0xFFFFFD4 (-44)	Intel(R) Management Engine Interface #1
 (PCI) 0xFFFFFD5 (-43)	Intel(R) Ethernet Controller I226-IT
 (PCI) 0xFFFFFD6 (-42)	Intel(R) Ethernet Controller I226-IT
 (PCI) 0xFFFFFD7 (-41)	Intel(R) Ethernet Controller I226-IT
 (PCI) 0xFFFFFD8 (-40)	Intel(R) Ethernet Controller I226-IT
 (PCI) 0xFFFFFD9 (-39)	Intel(R) Ethernet Controller I226-IT
 (PCI) 0xFFFFFDA (-38)	Intel(R) Ethernet Controller I226-IT #2
 (PCI) 0xFFFFFDB (-37)	Intel(R) Ethernet Controller I226-IT #2
 (PCI) 0xFFFFFDC (-36)	Intel(R) Ethernet Controller I226-IT #2
 (PCI) 0xFFFFFDD (-35)	Intel(R) Ethernet Controller I226-IT #2
 (PCI) 0xFFFFFDE (-34)	Intel(R) Ethernet Controller I226-IT #2
 (PCI) 0xFFFFFDF (-33)	Standard NVM Express Controller
 (PCI) 0xFFFFFE0 (-32)	Standard NVM Express Controller
 (PCI) 0xFFFFFE1 (-31)	Standard NVM Express Controller
 (PCI) 0xFFFFFE2 (-30)	Standard NVM Express Controller
 (PCI) 0xFFFFFE3 (-29)	Standard NVM Express Controller
 (PCI) 0xFFFFFE4 (-28)	Standard NVM Express Controller
 (PCI) 0xFFFFFE5 (-27)	Standard NVM Express Controller
 (PCI) 0xFFFFFE6 (-26)	Standard NVM Express Controller
 (PCI) 0xFFFFFE7 (-25)	Standard NVM Express Controller
 (PCI) 0xFFFFFE8 (-24)	Intel RST VMD Controller 7D0B
 (PCI) 0xFFFFFE9 (-23)	Intel RST VMD Controller 7D0B
 (PCI) 0xFFFFFEA (-22)	Intel RST VMD Controller 7D0B
 (PCI) 0xFFFFFEB (-21)	Intel RST VMD Controller 7D0B
 (PCI) 0xFFFFFEC (-20)	Intel RST VMD Controller 7D0B
 (PCI) 0xFFFFFED (-19)	Intel RST VMD Controller 7D0B
 (PCI) 0xFFFFFEE (-18)	Intel RST VMD Controller 7D0B
 (PCI) 0xFFFFFEF (-17)	Intel RST VMD Controller 7D0B
 (PCI) 0xFFFFFFF0 (-16)	Intel RST VMD Controller 7D0B
 (PCI) 0xFFFFFFF1 (-15)	Intel RST VMD Controller 7D0B
 (PCI) 0xFFFFFFF2 (-14)	Intel RST VMD Controller 7D0B
 (PCI) 0xFFFFFFF3 (-13)	Intel RST VMD Controller 7D0B
 (PCI) 0xFFFFFFF4 (-12)	Intel RST VMD Controller 7D0B
 (PCI) 0xFFFFFFF5 (-11)	Intel RST VMD Controller 7D0B
 (PCI) 0xFFFFFFF6 (-10)	Intel RST VMD Controller 7D0B
 (PCI) 0xFFFFFFF7 (-9)	Intel RST VMD Controller 7D0B
 (PCI) 0xFFFFFFF8 (-8)	Intel RST VMD Controller 7D0B
 (PCI) 0xFFFFFFF9 (-7)	Intel RST VMD Controller 7D0B
 (PCI) 0xFFFFFFFA (-6)	Intel RST VMD Controller 7D0B

-  (PCI) 0xFFFFF7B (-5) Standard SATA AHCI Controller
-  (PCI) 0xFFFFF7C (-4) PCI Express Root Port
-  (PCI) 0xFFFFF7D (-3) PCI Express Root Port
-  (PCI) 0xFFFFF7E (-2) PCI Express Root Port