



AAEON Technology INC.
ISO-9001/ISO-14001 Certified
Industrial Automation PCs

AMB-2021

Shock Test Report

Issued by:

Rex Chang
QE Engineer

/

06/24/2002

Date

Reviewed by:

Wen - Yuan Yang
QE Manager

/

06/24/2002

Date

1. Test Product : Modular System Industrial Panel PC
2. Model Name: AMB-2021
3. Test Date: 06-21-2002
4. Test Site: KING DESIGN VIBRATION LABORATORY
5. Test Equipment

Type	MFR	Model Number	Serial Number	Last CAL.
Shock Tester	KSON	KD-9363-600FK2-50N120	KDS11054783	
Controller	DACTRON	DSC System Version 0.922	635651	
Control Accelerometer	WILCOXON RESEARCH	WR-777	4207	

6. Test Specification:

Parameters	Targets
Wave Form	Half Sine wave
Acceleration	15g
Duration Time	11ms
No. of Shock	Each axis 3 times
Shock Direction	Bottom, Top, Left, Right, Front, Back axis

7. Test Condition

- Temperature: 20 ± 2
- Humidity: 70 ± 20%RH
- Sample: Unpacked; Operation
- Software: Windows 98 run Media Player (VCD viewing)

8. Axial Definition

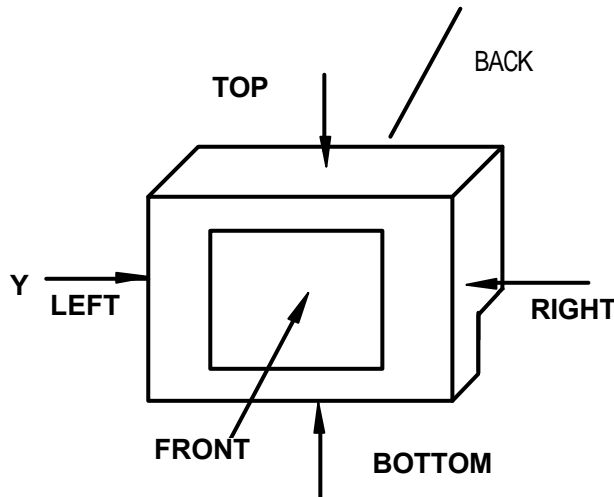

9. Test Result:

- a. The system structure doesn't deformation; Function is OK during system test.
- b. The system structure doesn't have any deformation; All functions are OK after shock test.

10. Testing Photos

TOP

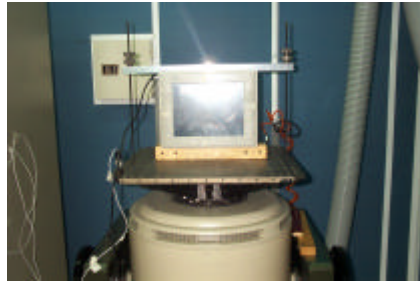

Bottom



Left



Right



Front

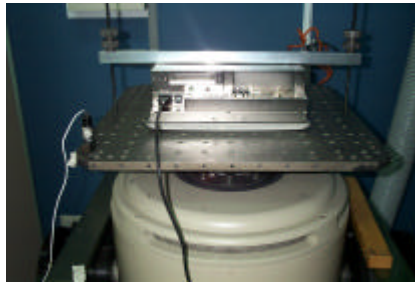

Back

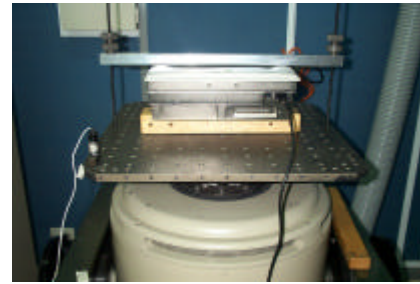

12. Test Curve

Axis top

Project File Name: Untitled

Profile Name: 15G 11mSec

Test Type: Classical Shock

Run Folder:

.Run Jun 21,2002 14-42-52

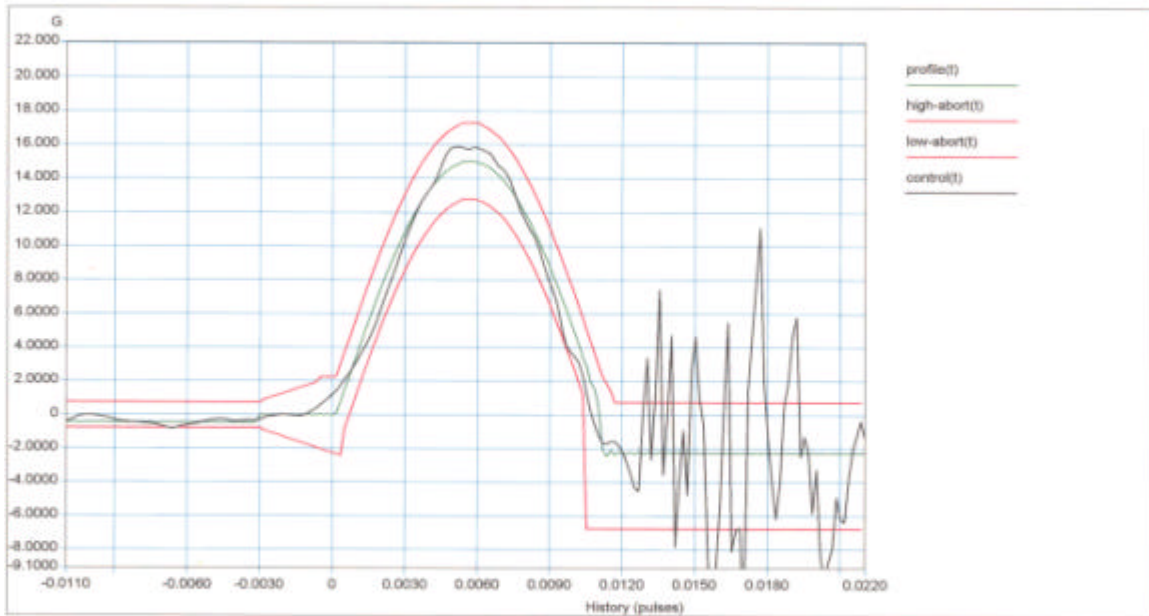

Level: 100 % Block Size: 4096 Elapsed Pulses: 11
 Frame Time: 0.682667 Seconds Control Peak: 15.823575 G Control RMS: 1.723898 GFull Level Elapsed Pulses: 3
 dT: 0.000167 Seconds Demand Peak: 14.999999 G Demand RMS: 1.494986 GRemaining Pulses: 0
 Pulse Type: Half Sine Amplitude: 14.999999 G Pulse Width: 11.000001 ms

Axis bottom

Project File Name: Untitled

Profile Name: 15G 11mSec

Test Type: Classical Shock

Run Folder:

.Run Jun 21,2002 14-45-50

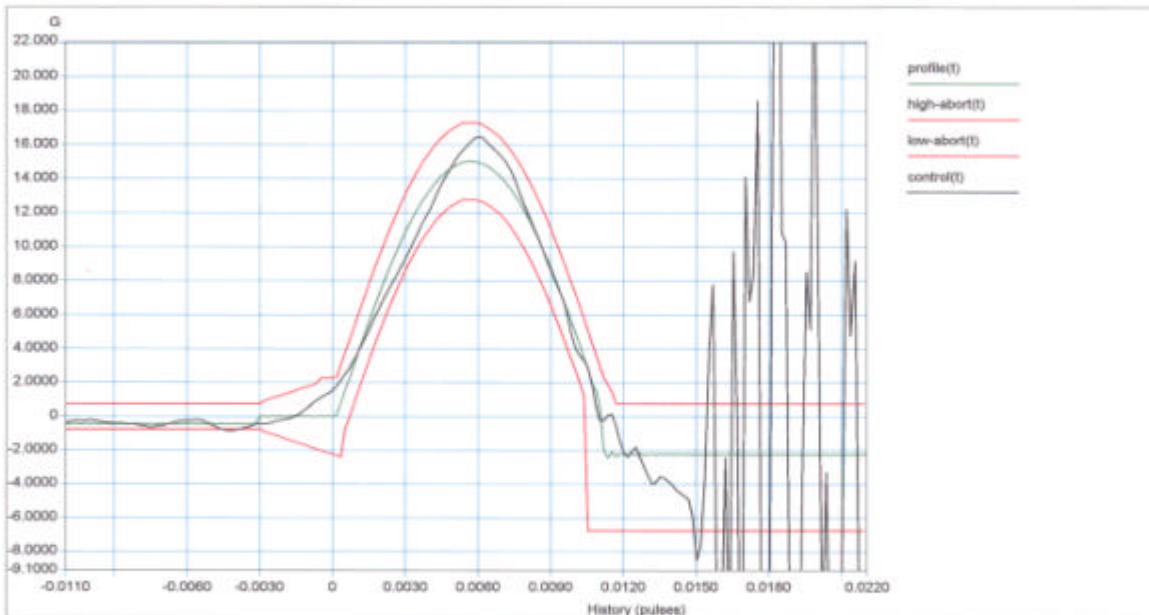

Level: 100 % Block Size: 4096 Elapsed Pulses: 11
 Frame Time: 0.682667 Seconds Control Peak: 41.093479 G Control RMS: 2.868050 GFull Level Elapsed Pulses: 3
 dT: 0.000167 Seconds Demand Peak: 14.999999 G Demand RMS: 1.494986 GRemaining Pulses: 0
 Pulse Type: Half Sine Amplitude: 14.999999 G Pulse Width: 11.000001 ms

Axis left

Project File Name: Untitled

Profile Name: 15G 11mSec

Test Type: Classical Shock

Run Folder:

.Run Jun 21,2002 14-48-35

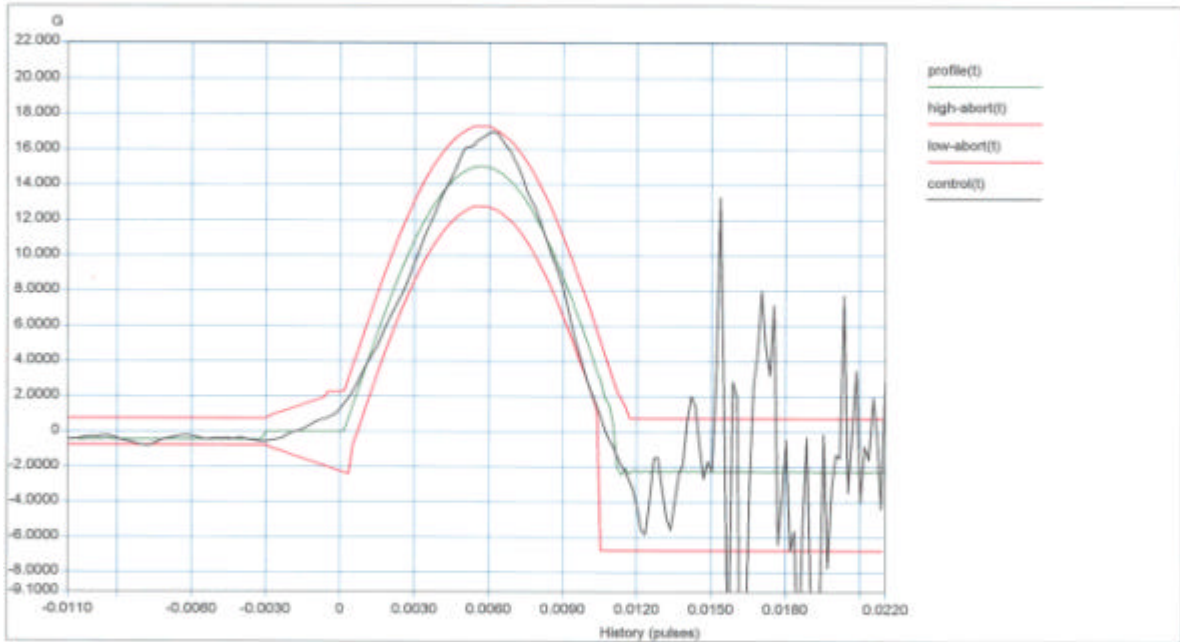

Level: 100 % Block Size: 4096 Elapsed Pulses: 11
Frame Time: 0.682667 Seconds Control Peak: 18.135201 G Control RMS: 1.890372 G Full Level Elapsed Pulses: 3
dT: 0.000167 Seconds Demand Peak: 14.999999 G Demand RMS: 1.494986 G Remaining Pulses: 0
Pulse Type: Half Sine Amplitude: 14.999999 G Pulse Width: 11.000001 ms

Axis right

Project File Name: Untitled

Profile Name: 15G 11mSec

Test Type: Classical Shock

Run Folder:

.Run Jun 21,2002 14-50-15

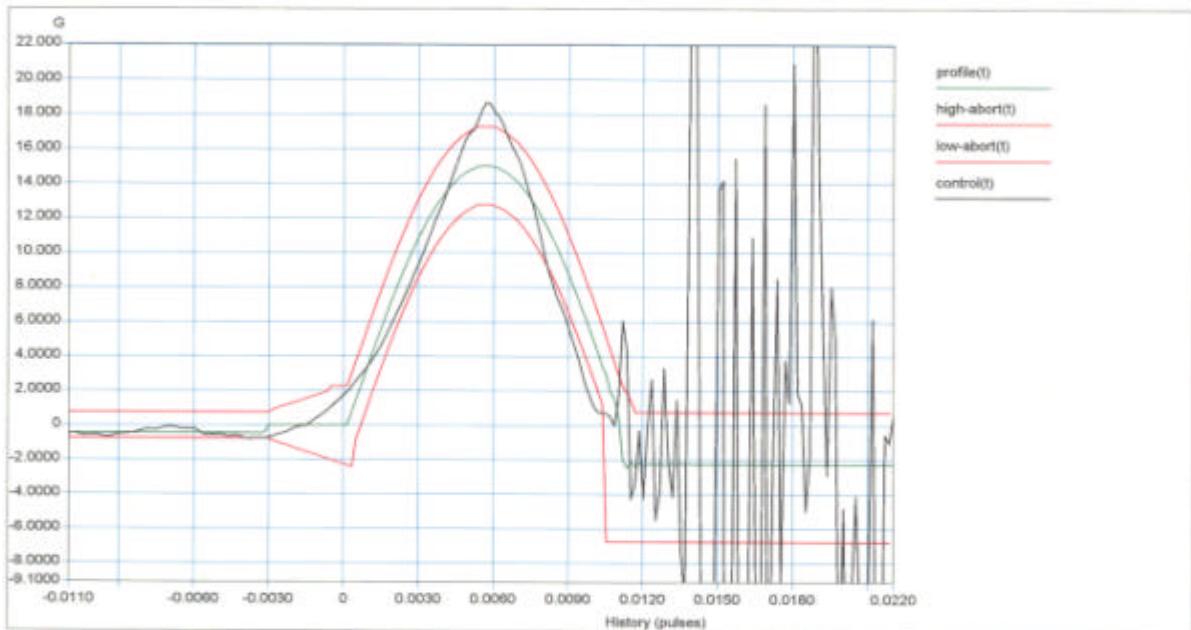

Level: 100 % Block Size: 4096 Elapsed Pulses: 12
Frame Time: 0.682667 Seconds Control Peak: 43.876564 G Control RMS: 2.500326 G Full Level Elapsed Pulses: 3
dT: 0.000167 Seconds Demand Peak: 14.999999 G Demand RMS: 1.494986 G Remaining Pulses: 0
Pulse Type: Half Sine Amplitude: 14.999999 G Pulse Width: 11.000001 ms

Axis front

Project File Name: Untitled

Profile Name: 15G 11mSec

Test Type: Classical Shock

Run Folder: .\Run Jun 21,2002 14-52-02

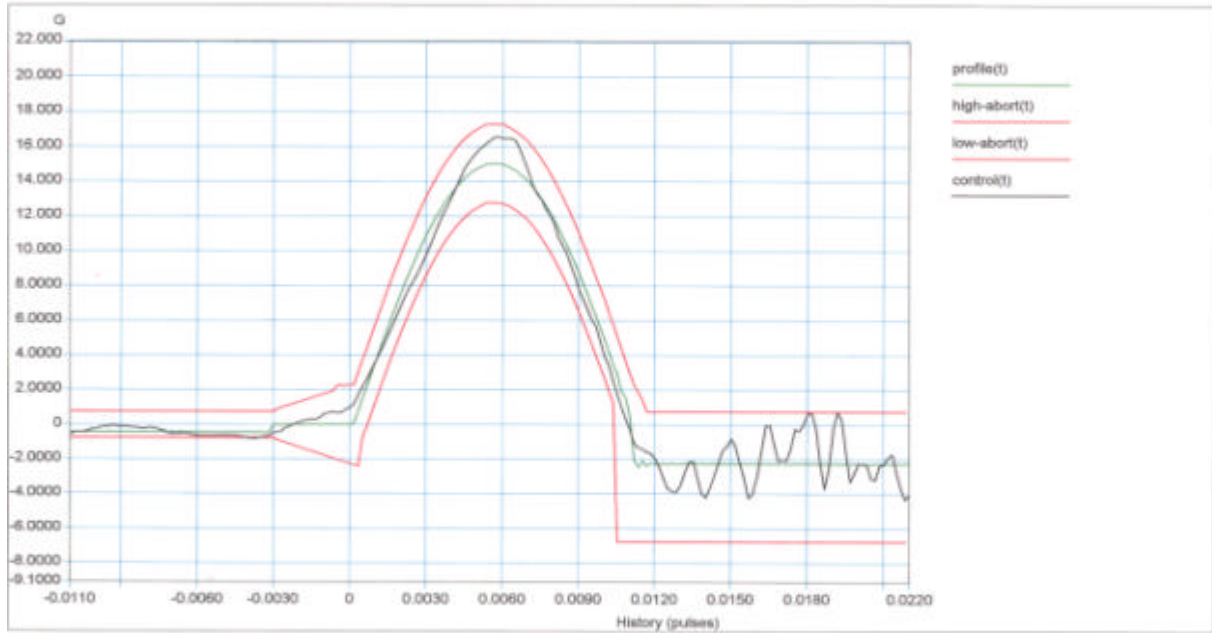

Level: 100 % Block Size: 4096 Elapsed Pulses: 11
Frame Time: 0.682667 Seconds Control Peak: 16.505220 G Control RMS: 1.555049 G Full Level Elapsed Pulses: 3
dT: 0.000167 Seconds Demand Peak: 14.999999 G Demand RMS: 1.494986 G Remaining Pulses: 0
Pulse Type: Half Sine Amplitude: 14.999999 G Pulse Width: 11.000001 ms
Axis back

Project File Name: Untitled

Profile Name: 15G 11mSec

Test Type: Classical Shock

Run Folder: .\Run Jun 21,2002 14-53-53

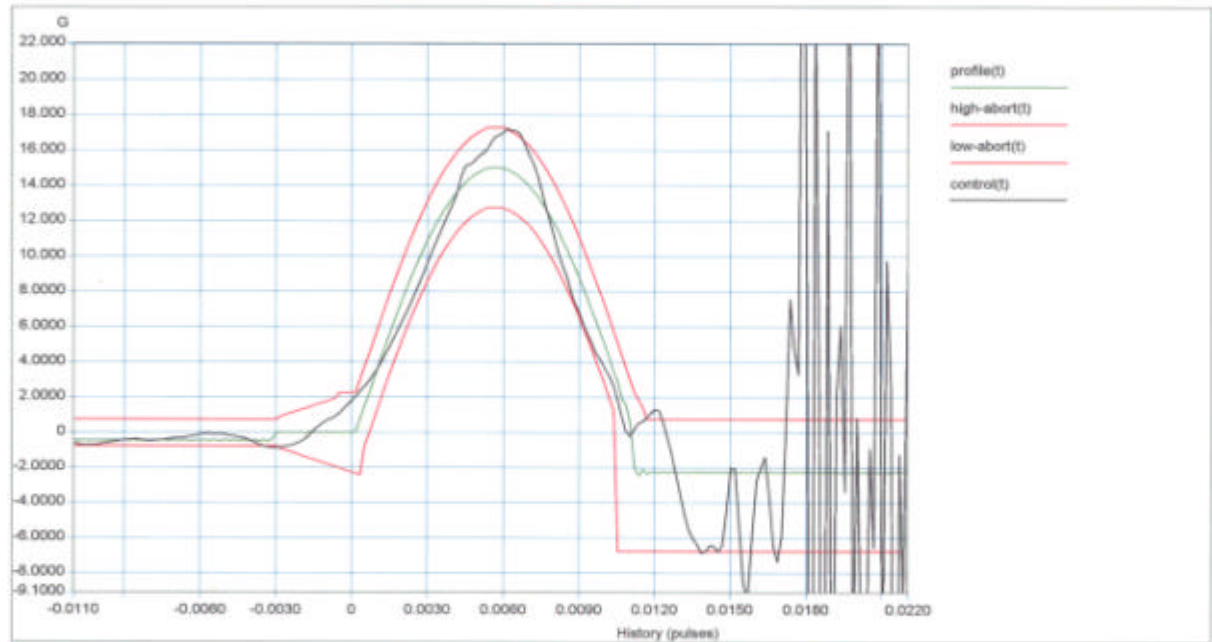

Level: 100 % Block Size: 4096 Elapsed Pulses: 11
Frame Time: 0.682667 Seconds Control Peak: 47.082130 G Control RMS: 2.613183 G Full Level Elapsed Pulses: 3
dT: 0.000167 Seconds Demand Peak: 14.999999 G Demand RMS: 1.494986 G Remaining Pulses: 0
Pulse Type: Half Sine Amplitude: 14.999999 G Pulse Width: 11.000001 ms