



SPORTON LAB.

Certificate No: C071101

CERTIFICATE

EQUIPMENT : Industrial Panel PCs
MODEL NO. : AMB-2000HT/AMB-2000HTT, ACS-2300, AMB-2212
APPLICANT : Astech Technology Co., Ltd.
6F-4, No. 351, Chung-Shan Rd., Sec. 2,
Chung-Ho City, Taipei, Taiwan, R.O.C.



I HEREBY CERTIFY THAT:

THE MEASUREMENTS SHOWN IN THIS TEST REPORT WERE MADE IN ACCORDANCE WITH THE PROCEDURES GIVEN IN EUROPEAN COUNCIL DIRECTIVE 89/336/EEC. THE EQUIPMENT WAS PASSED THE TEST PERFORMED ACCORDING TO EUROPEAN STANDARD EN55022:1994/A1:1995/A2:1997 Class A, EN61000-3-2:1995, EN61000-3-3:1995 and EN 55024:1998 (EN61000-4-2:1995, EN61000-4-3:1996, EN61000-4-4:1995, EN61000-4-5:1995, EN61000-4-6:1996, EN61000-4-8:1993, EN61000-4-11:1994). THE TEST WAS CARRIED OUT ON Jul. 27, 2000 AT SPORTON INTERNATIONAL INC. LAB.



Lenore Chang
President

CE TEST REPORT

according to

**European Standard EN 55022:1994/A1:1995/A2:1997 Class A
EN61000-3-2:1995, EN 61000-3-3:1995
and EN 55024:1998
(EN61000-4-2:1995, EN61000-4-3:1996, EN61000-4-4:1995,
EN61000-4-5:1995, EN61000-4-6:1996, EN61000-4-8:1993,
EN61000-4-11:1994)**

Equipment : Industrial Panel PCs

Model No. : AMB-2000HT/ AMB-2000HTT,
ACS-2300, AMB-2212

Applicant : **Astech Technology Co., Ltd.**
6F-4, No. 351, Chung-Shan Rd., Sec. 2,
Chung-Ho City, Taipei, Taiwan, R.O.C.

- The test result refers exclusively to the test presented test model / sample.
- Without the written authorization of the test lab., the Test Report may not be copied.
- This test report is only applicable to European Community.

SPORTON International Inc.

6F, No. 106, Sec. 1, Hsin Tai Wu Rd., Hsi Chih, Taipei Hsien, Taiwan, R.O.C.

SPORTON International Inc.

TEL : 886-2-2696-2468

FAX : 886-2-2696-2255

Page Number : 1 of 59

Issued Date : Aug. 1, 2000

Table of Contents

CERTIFICATE OF COMPLIANCE	4
1. General Description of Equipment under Test	5
1.1 Applicant.....	5
1.2 Manufacturer.....	5
1.3 Basic Description of Equipment under Test.....	5
1.4 Feature of Equipment under Test.....	5
2. Test Configuration of Equipment under Test.....	6
2.1 Test Manner.....	6
2.2 Description of Test System	6
3. Test Software	10
4. General Information of Test	11
4.1 Test Facility.....	11
4.2 Standard for Methods of Measurement	11
4.3 Test in Compliance with	11
4.4 Frequency Range Investigated.....	11
4.5 Test Distance	11
5. Test of Conducted Powerline.....	12
5.1 Description of Major Test Instruments	12
5.2 Test Procedures.....	13
5.3 Typical Test Setup Layout of Conducted Powerline.....	14
5.4 Test Result of AC Powerline Conducted Emission	15
5.5 Photographs of Conducted Powerline Test Configuration.....	16
6. Test of Radiated Emission	17
6.1 Description of Major Test Instruments	17
6.2 Test Procedures.....	18
6.3 Typical Test Setup Layout of Radiated Emission.....	19
6.4 Test Result of Radiated Emission	20
6.5 Photographs of Radiated Emission Test Configuration.....	21
7. Harmonics Test	22
7.1 Standard	22
7.2 Test Procedure	22
7.3 Test Equipment Settings	22
7.4 Test Setup	22
7.5 Current Harmonics Test	23
8. Voltage Fluctuations Test	25
8.1 Standard	25
8.2 Test Procedure	25
8.3 Test Equipment Settings	25
8.4 Test Setup	25
8.5 Test Result Of Voltage Fluctuation And Flicker Test.....	26
8.6 Photographs Of Harmonics Test, Voltage Fluctuation And Flicker Test.....	28
9. Electrostatic Discharge Immunity Test (ESD).....	29
9.1 Test setup	29
9.2 Test Setup for Tests Performed in Laboratory	30
9.3 ESD Test Procedure	31
9.4 Test Severity Levels.....	32

9.5 Test Points.....	33
9.6 Photographs of Electrostatic Discharge Immunity Test.....	35
10. Radio Frequency Electromagnetic Field Immunity Test (RS)	36
10.1 Test setup.....	36
10.2 Test Procedure	37
10.3 Test Severity Levels.....	37
10.4 Photographs of Radio Frequency Electromagnetic Field Immunity Test	38
11. Electrical Fast Transient/Burst Immunity Test (EFT/BURST).....	39
11.1 Test setup.....	39
11.2 Test on Power Line	40
11.3 Test on Communication Lines.....	40
11.4 Test Procedure	41
11.5 Test Severity Levels.....	42
11.6 Photographs of Electrical Fast Transient/BURST Immunity Test.....	43
12. SURGE IMMUNITY TEST	45
12.1 TEST RECORD	45
12.2 TEST LEVEL	46
12.3 TEST PROCEDURE.....	46
12.4 OPERATING CONDITION	47
12.5 Photographs of SURGE IMMUNITY TEST	48
13. CONDUCTED DISTURBANCES INDUCED BY RADIO-FREQUENCY FIELD IMMUNITY TEST (CS) ..	49
13.1 TEST LEVEL	49
13.2 OPERATING CONDITION	49
13.3 TEST PROCEDURE	50
14. Power Frequency Magnetic Field immunity tests.....	51
15. VOLTAGE DIPS AND VOLTAGE INTERRUPTIONS IMMUNITY TESTS	52
15.1 TEST RECORD OF VOLTAGE INTERRUPTION	52
15.2 TEST RECORD OF VOLTAGE DIPS.....	52
15.3 TESTING REQUIREMENT AND PROCEDURE	53
15.4 TEST CONDITIONS	53
15.5 OPERATING CONDITION	53
15.6 Photographs of VOLTAGE DIPS AND VOLTAGE INTERRUPTIONS IMMUNITY TESTS.....	54
16. Antenna Factor & Cable Loss	55
17. List of Measuring Equipment Used.....	56
18. Notice for Class A Product.....	58
19. Declaration of Conformity and the CE Mark.....	59
Appendix A. Photographs of EUT	A1 ~ A3



Declaration of Conformity

Date

The following designated product

EUT NAME
MODEL NO. of EUT

complies with the essential protection requirements of Council Directive 89/336/EEC on the approximation of the laws of the Member States relating to electromagnetic compatibility. To the judgment of the product with regard to EMC according following regulations :

EMI TEST STANDARD
EMS TEST STANDARD

This declaration is prepared for the manufacturer

Manufacturer Name
Address of Manufacturer

and declared by

Declarant Name
Address of Declarant

Signature

Printed Name and Title

Declaration No :

CERTIFICATE OF COMPLIANCE

according to

**European Standard EN 55022:1994/A1:1995/A2:1997 Class A
EN61000-3-2:1995, EN 61000-3-3:1995
and EN 55024:1998
(EN61000-4-2:1995, EN61000-4-3:1996, EN61000-4-4:1995,
EN61000-4-5:1995, EN61000-4-6:1996, EN61000-4-8:1993,
EN61000-4-11:1994)**

Equipment : Industrial Panel PCs

Model No. : AMB-2000HT/ AMB-2000HTT,
ACS-2300, AMB-2212

Applicant : **Astech Technology Co., Ltd.**
6F-4, No. 351, Chung-Shan Rd., Sec. 2,
Chung-Ho City, Taipei, Taiwan, R.O.C.

I HEREBY CERTIFY THAT :

The measurements shown in this test report were made in accordance with the procedures given in EUROPEAN COUNCIL DIRECTIVE 89/336/EEC. The equipment was *passed* the test performed according to European Standard EN 55022:1994/A1:1995/A2:1997 Class A , EN61000-3-2:1995, EN61000-3-3:1995 and EN 55024:1998 (EN61000-4-2:1995, EN61000-4-3:1996, EN61000-4-4:1995, EN61000-4-5:1995, EN61000-4-6:1996, EN61000-4-8:1993, EN61000-4-11:1994). The test was carried out on Jul. 27, 2000 at SPORTON International Inc. LAB. in Nei Hwu and Lin Kou.



Lenore Chang
President

SPORTON International Inc.

6F, No. 106, Sec. 1, Hsin Tai Wu Rd., Hsi Chih, Taipei Hsien, Taiwan, R.O.C.

SPORTON International Inc.
TEL : 886-2-2696-2468
FAX : 886-2-2696-2255

Page Number : 4 of 59
Issued Date : Aug. 1, 2000

6F, No. 106, Sec. 1, Hsin Tai Wu Rd., Hsi Chih, Taipei Hsien, Taiwan, R.O.C. TEL:886-2-26962468 FAX:886-2-26962255

Scope of NVLAP Accreditation: EICISPR 22, FCC Method -47 CFR Part 15-Digital Devices, AS-3548

1. General Description of Equipment under Test

1.1 Applicant

Astech Technology Co., Ltd.
6F-4, No. 351, Chung-Shan Rd., Sec. 2,
Chung-Ho City, Taipei, Taiwan, R.O.C.

1.2 Manufacturer

Same as 1.1.

1.3 Basic Description of Equipment under Test

Equipment : Industrial Panel PCs
Model No. : AMB-2000HT/ AMB-2000HTT, ACS-2300, AMB-2212
Trade Name : Astech
Data Cable : please see section 2.2 of this test report for details.
STP cable : Shielded, 10 m
Power Supply Type : Switching
AC Power Cord : Non-Shielded, 1.75m, 3 pin

1.4 Feature of Equipment under Test

- 10.4" VGA color TFT LCD display
- Heavy-duty steel chassis and NEMA 4/12 compliant plastic front panel
- All-in-one SBC, MediaGX 233MHz
- Four 16C550 RS-232C port, one RS-232C port can be set as RS-422/485 ALSO
- Disk Driver Space for CD-ROM, FDD and HDD
- DiskOnChip flash disk socket

2. Test Configuration of Equipment under Test

2.1 Test Manner

- a. During testing, the interface cables and equipment positions were varied according to european Standard EN 55022.
- b. The remote workstation, SONY Monitor, DELL PS/2 Keyboard, PRIMAX PS/2 Mouse, WINIC USB Mouse, HP Printer and ACEEX Modem were connected to the EUT for EMI test.
- c. The remote workstation, HP Monitor, SILITEK USB Keyboard, DELL PS/2 Keyboard, PRIMAX PS/2 Mouse, HP Printer and ACEEX Modem were connected to the EUT for EMS test.
- d. Using the twisted pair cable to connect the EUT and remote workstation.
- e. Frequency range investigated: conduction 150 KHz to 30 MHz, radiation 30 MHz to 1000MHz.

2.2 Description of Test System

< EMI >

Support Unit 1. -- Monitor (SONY)—for local and remote workstation

FCC ID	: AK8GDM17SE2T
Model No.	: GDM-17SE2T
Power Supply Type	: Switching
Power Cord	: Non-Shielded
Serial No.	: SP0013
Data Cable	: Shielded, 1.15m

Support Unit 2. -- PS/2 Keyboard (DELL) —for local and remote workstation

FCC ID	: GYUM90SK
Model No.	: AT101W
Power Supply Type	: From PC
Power Cord	: Shielded
Serial No.	: SP00188
Data Cable	: Shielded, 1.5m

Support Unit 3. -- PS/2 Mouse (PRIMAX) —for local and remote workstation

FCC ID	: EMJMUSJQ
Model No.	: MUS9J
Serial No.	: SP0045
Data Cable	: Non-shielded, 1.75m

Support Unit 4. -- USB Mouse (WINIC)

FCC ID : F4ZFDM-A50
Model No. : FDM-A50
Serial No. : SP0092
Data Cable : Non-shielded, 1.5m

Support Unit 5. -- Printer (HP)

FCC ID : DSI6XU2225
Model No. : 2225C
Power Supply Type : Linear
Power Cord : Non-Shielded
Serial No. : SP0014
Data Cable : Shielded, 1.2m

Support Unit 6. -- Modem (ACEEX)

FCC ID : IFAXDM1414
Model No. : DM1414
Power Supply Type : Linear
Power Cord : Non-Shielded
Serial No. : SP0015
Data Cable : Shielded, 1.15m

Support Unit 7. -- Personal Computer (FIC)—for remote workstation

FCC ID : N/A
Model No. : P2L97
Power Supply Type : Switching
Power Cord : Non-Shielded
Serial No. : SP0037
Data Cable : Shielded
Remark : This support device was tested to comply with FCC standards and authorized under a declaration of conformity.

< EMS >

Support Unit 1. -- Personal Computer (DELL) ---for remote workstation

FCC ID : N/A
Model No. : DCS
Power Supply Type : Switching
Power Cord : Non-Shielded
Serial No. : SP0038
Data Cable : Shielded
Remark : This support device was tested to comply with FCC standards and authorized under a declaration of conformity.

Support Unit 2. -- Monitor (HP)

FCC ID : ACJ93312116
Model No. : D2807A
Power Supply Type : Switching
Power Cord : Non-Shielded
Serial No. : SP0053
Data Cable : Shielded, 1.7m

Support Unit 3. -- USB Keyboard (SILITEK)

FCC ID : GYUR50SK
Model No. : SK-2000U
Serial No. : SP0066
Data Cable : Shielded, 1.7m

Support Unit 4. -- PS/2 Keyboard (DELL) ---for local and remote workstation

FCC ID : GYUM92SK
Model No. : AT101(DE8M)
Serial No. : SP0054
Data Cable : Shielded, 1.9m

Support Unit 5. -- PS/2 Mouse (PRIMAX)

FCC ID : EMJMUSJQ
Model No. : MUS9J
Serial No. : SP0045
Data Cable : Shielded, 1.7m

Support Unit 6. -- Printer (HP)

FCC ID : DSI6XU2225
Model No. : 2225C
Power Supply Type : Linear
Power Cord : Non-Shielded
Serial No. : SP0014
Data Cable : Shielded, 1.35m

Support Unit 7. -- Modem (ACEEX)

FCC ID : IFAXDM1414
Model No. : DM1414
Power Supply Type : Linear
Power Cord : Non-Shielded
Serial No. : SP0015
Data Cable : Shielded, 1.15m

Support Unit 8. -- Monitor (SYNCO) —for remote workstation

FCC ID : N/A
Model No. : GM-568
Power Supply Type : Switching
Power Cord : Non-Shielded
Serial No. : SP0022
Data Cable : Shielded, 1.7m
Remark : This support device was tested to comply with FCC standards and authorized under a declaration of conformity.

3. Test Software

< EMI >

Two executive programs, EMITEST.EXE & WINFCC.EXE under WIN 98, which generate a complete line of continuously repeating " H " pattern were used as the test software.

The programs were executed as follows :

- a. Turn on the power of all equipment.
- b. The PC reads the test program from the floppy disk drive and runs it.
- c. The PC sends " H " messages to the monitor, and the monitor displays " H " patterns on the screen.
- d. The PC sends " H " messages to the printer, then the printer prints them on the paper.
- e. The PC sends " H " messages to the modem.
- f. The PC sends " H " messages to the internal Hard Disk, and the Hard Disk reads and writes the message.
- g. Repeat the steps from b to f.

At the same time, "TP test" was executed to link with the remote workstation to receive and transmit data by TP cable.

< EMS >

An executive program, EMITEST.EXE under DOS, which generates a complete line of continuously repeating " H " pattern was used as the test software.

The program was executed as follows :

- a. Turn on the power of all equipment.
- b. The PC reads the test program from the floppy disk drive and runs it.
- c. The PC sends " H " messages to the monitor, and the monitor displays " H " patterns on the screen.
- d. The PC sends " H " messages to the printer, then the printer prints them on the paper.
- e. The PC sends " H " messages to the modem.
- f. The PC sends " H " messages to the internal Hard Disk, and the Hard Disk reads and writes the message.
- g. Repeat the steps from b to f.

4. General Information of Test

4.1 Test Facility

< EMI >

This test was carried out by SPORTON International Inc.

Test Site Location : No. 3, Lane 238, Kang Lo Street, Nei Hwu District,
Taipei 11424, Taiwan, R.O.C.
TEL : 886-2-2631-4739
FAX : 886-2-2631-9740

< EMS >

This test was carried out by SPORTON International Inc.

Test Site Location : No. 30-2, Lin 6, Diing-Fwu Tsuen, Lin-Kou-Hsiang,
Taipei Hsien, Taiwan, R.O.C.
TEL : 886-2-2601-1640
FAX : 886-2-2601-1695

4.2 Standard for Methods of Measurement

EMI Test (conduction and radiation) : European Standard EN 55022 Class A
Harmonics Test : European Standard EN 61000-3-2.
Voltage Fluctuations Test : European Standard EN 61000-3-3.
EMS Test : European Standard EN 55 024:1998.
(ESD: EN 61 000-4-2, RS: EN 61 000-4-3, EFT: EN 61 000-4-4, SURGE: EN 61 000-4-5,
CS: EN 61 000-4-6, Power Frequency Magnetic Field: EN 61 000-4-8, DIPS: EN 61 000-4-11)

4.3 Test in Compliance with

EMI Test (conduction and radiation) : European Standard EN 55022 Class A
Harmonics Test : European Standard EN 61000-3-2.
Voltage Fluctuations Test : European Standard EN 61000-3-3.
EMS Test : European Standard EN 55 024:1998.
(ESD: EN 61 000-4-2, RS: EN 61 000-4-3, EFT: EN 61 000-4-4, SURGE: EN 61 000-4-5,
CS: EN 61 000-4-6, Power Frequency Magnetic Field: EN 61 000-4-8, DIPS: EN 61 000-4-11)

4.4 Frequency Range Investigated

- a. Conducted emission test: from 150 kHz to 30 MHz
- b. Radiated emission test: from 30 MHz to 1,000 MHz
- c. Radio frequency electromagnetic field immunity test : 80-1000 MHz.

4.5 Test Distance

The test distance of radiated emission test from antenna to EUT is 10 M.

The test distance of radio frequency electromagnetic field immunity test from antenna to EUT is 3 M.

5. Test of Conducted Powerline

Conducted Emissions were measured from 150 kHz to 30 MHz with a bandwidth of 9 kHz on the 230V AC power and return leads of the EUT according to the methods defined in European Standard EN 55022 Clause 9. The EUT was placed on a nonmetallic stand in a shielded room 0.8 meters above the ground plane as shown in section 5.3. The interface cables and equipment positioning were varied within limits of reasonable applications to determine the position producing maximum conducted emissions.

5.1 Description of Major Test Instruments

Test Receiver	HP 8591EM
Attenuation	0 dB
Start Frequency	0.15 MHz
Stop Frequency	30 MHz
Step MHz	0.007 MHz
IF Bandwidth	9 kHz

5.2 Test Procedures

- a. The EUT was placed on a desk 0.8 meters height from the metal ground plane and 0.4 meter from the conducting wall of the shielding room and it was kept at least 0.8 meters from any other grounded conducting surface.
- b. Connect EUT to the power mains through a line impedance stabilization network (LISN).
- c. All the support units are connect to the other LISN.
- d. The LISN provides 50 ohm coupling impedance for the measuring instrument.
- e. The CISPR states that a 50 ohm , 50 microhenry LISN should be used.
- f. Both sides of AC line were checked for maximum conducted interference.
- g. The frequency range from 150 kHz to 30 MHz was searched.
- h. Set the test-receiver system to Peak Detect Function and Specified Bandwidth with Maximum Hold Mode.
- i. If the emission level of the EUT in peak mode was 6 dB lower than the limit specified, then testing will be stopped and peak values of EUT will be reported, otherwise, the emissions which do not have 6 dB margin will be retested one by one using the quasi-peak method and/or average methods and reported.

5.3 Typical Test Setup Layout of Conducted Powerline

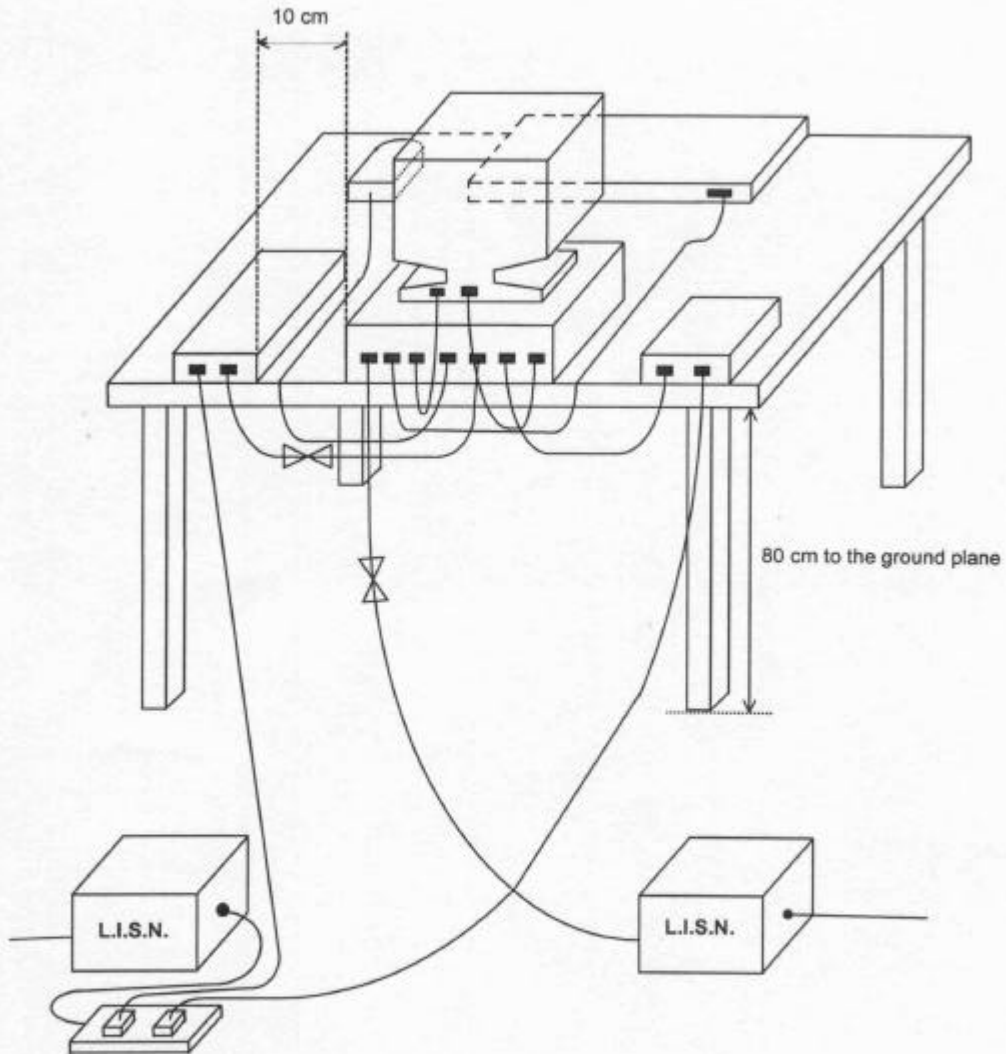

5.4 Test Result of AC Powerline Conducted Emission

- Equipment meets the technical specifications of EN 55022:1994/A1:1995/A2:1997
- Frequency Range of Test : from 150 kHz to 30 MHz
- Temperature : 28°C
- Relative Humidity : 48 %
- Test Date : Jul. 21, 2000

The Conducted Emission test was passed at minimum margin **NEUTRAL 7.281 MHz / 50.80 dBuV.**

Freq. (MHz)	Line or Neutral	Meter Reading				Limits				Margin	
		Q.P. (dBuV)	A.V. (dBuV)	Q.P. (uV)	A.V. (uV)	Q.P. (dBuV)	A.V. (dBuV)	Q.P. (uV)	A.V. (uV)	Q.P. (dB)	A.V. (dB)
0.179	L	49.10	40.20	285.10	102.33	79.00	66.00	8912.51	1995.26	-29.9	-25.8
0.215	L	43.00	35.90	141.25	62.37	79.00	66.00	8912.51	1995.26	-36.0	-30.1
0.251	L	40.50	36.30	105.93	65.31	79.00	66.00	8912.51	1995.26	-38.5	-29.7
0.179	N	48.20	39.50	257.04	94.41	79.00	66.00	8912.51	1995.26	-30.8	-26.5
6.116	N	33.00	31.70	44.67	38.46	73.00	60.00	4466.84	1000.00	-40.0	-28.3
7.281	N	52.90	50.80	441.57	346.74	73.00	60.00	4466.84	1000.00	-20.1	-9.2

Test Engineer : 
 Jackson Huang

5.5 Photographs of Conducted Powerline Test Configuration

- The photographs show the configuration that generates the maximum emission.

FRONT VIEW



REAR VIEW

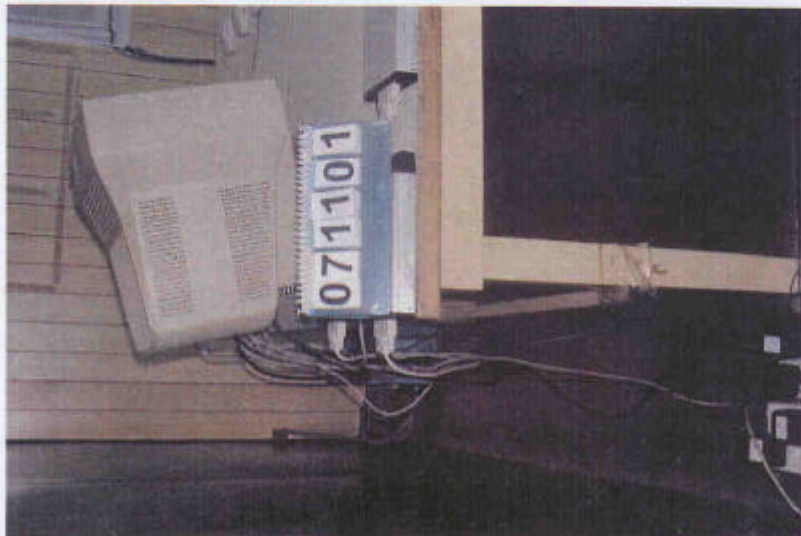

6. Test of Radiated Emission

Radiated emissions from 30 MHz to 1000 MHz were measured with a bandwidth of 120 kHz according to the methods defines in European Standard EN 55022, Clause 10. The EUT was placed on a nonmetallic stand in the open-field site, 0.8 meter above the ground plane, as shown in section 6.3. The interface cables and equipment positions were varied within limits of reasonable applications to determine the positions producing maximum radiated emissions.

6.1 Description of Major Test Instruments

- Amplifier (HP 8447D)
 - Attenuation 0 dB
 - RF Gain 25 dB
 - Signal Input 0.1 MHz to 1.3 GHz

- Spectrum Analyzer (ADVANTEST R3261C)
 - Attenuation 0 dB
 - Start Frequency 30 MHz
 - Stop Frequency 1000 MHz
 - Resolution Bandwidth 1 MHz
 - Video Bandwidth 1 MHz
 - Signal Input 9 KHz to 2.6 GHz

6.2 Test Procedures

- a. The EUT was placed on a rotatable table top 0.8 meter above ground.
- b. The EUT was set 10 meters from the interference-receiving antenna which was mounted on the top of a variable height antenna tower.
- c. The table was rotated 360 degrees to determine the position of the highest radiation.
- d. The antenna is a half wave dipole and its height is varied between one meter and four meters above ground to find the maximum value of the field strength both horizontal polarization and vertical polarization of the antenna are set to make the measurement.
- e. For each suspected emission the EUT was arranged to its worst case and then tune the antenna tower (from 1 M to 4 M) and turn table (from 0 degree to 360 degrees) to find the maximum reading.
- f. Set the test-receiver system to Peak Detect Function and specified bandwidth with Maximum Hold Mode.
- g. If the emission level of the EUT in peak mode was 6 dB lower than the limit specified, then testing will be stopped and peak values of EUT will be reported, otherwise, the emissions which do not have 6 dB margin will be repeated one by one using the quasi-peak method and reported.



6.3 Typical Test Setup Layout of Radiated Emission

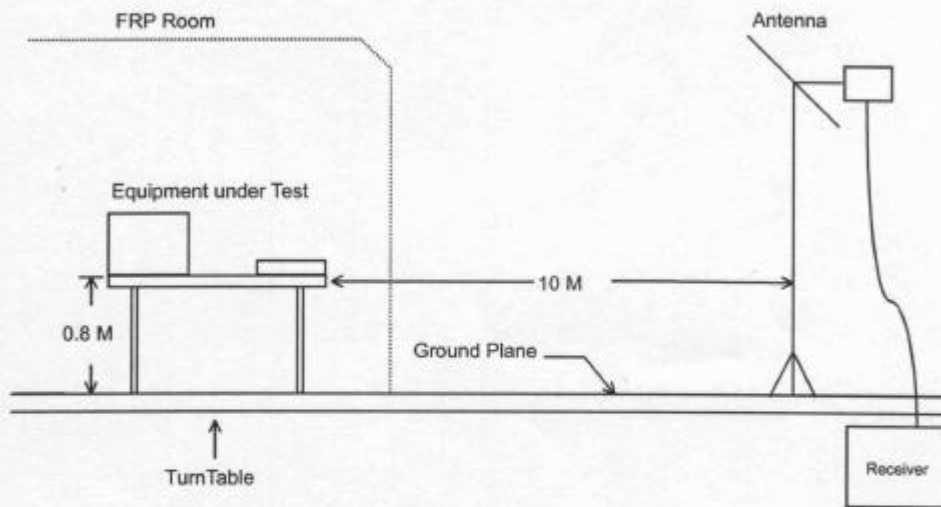

6.4 Test Result of Radiated Emission

- Equipment meets the technical specifications of EN 55022 :1994/A1:1995/A2:1997
- Frequency Range of Test : from 30 MHz to 1000 MHz
- Test Distance : 10 M
- Temperature : 29°C
- Relative Humidity : 47 %
- Test Date : Jul. 20, 2000
- Emission level (dBuV/m) = 20 log Emission level (uV/m)
- Corrected Reading : Antenna Factor + Cable Loss + Reading = Emission

The Radiated Emission test was passed at minimum margin:

HORIZONTAL 175.413 MHz / 38.56 dBuV Antenna Height 4 Meter , Turntable Degree 180 °.

Frequency (MHz)	Polarity	Antenna Factor (dB/m)	Cable Loss (dB)	Reading (dBuV)	Limits		Emission (dBuV/m)	Level (uV/m)	Margin (dB)
					(dBuV/m)	(uV/m)			
56.815	H	7.14	1.22	28.21	40.00	100.00	36.57	67.38	-3.43
81.434	H	7.50	1.49	28.73	40.00	100.00	37.72	76.91	-2.28
175.413	H	9.35	2.43	26.78	40.00	100.00	38.56	84.72	-1.44
735.047	H	17.69	5.66	20.50	47.00	223.87	43.85	155.78	-3.15
112.761	V	11.47	1.89	23.47	40.00	100.00	36.83	69.42	-3.17
240.362	V	11.49	3.02	29.06	47.00	223.87	43.57	150.83	-3.43

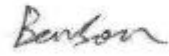
Test Engineer : 
 BENSON TSAI

6.5 Photographs of Radiated Emission Test Configuration

- The photographs show the configuration that generates the maximum emission.

FRONT VIEW



REAR VIEW



7. Harmonics Test

7.1 Standard

- Standard : EN 61000-3-2 (1995)

7.2 Test Procedure

The measured values of the harmonics components of the input current, including line current and neutral current, shall be compared with the limits given in Clause 7 of EN 61000-3-2.

7.3 Test Equipment Settings

- Line Voltage : 230 V
- Line Frequency : 50 Hz
- Device Class : A
- Current Measurement Range : High
- Measurement Delay : 10.0 seconds
- Test Duration : 2.00 minutes
- Class determination Pre-test Duration : 10.00 seconds

7.4 Test Setup

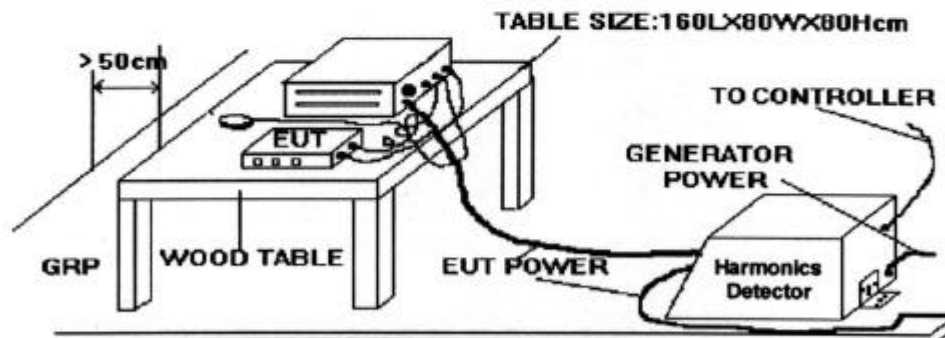

7.5 Current Harmonics Test

7.5.1 Test Data Of Current Harmonics

- FINAL TEST RESULT : **PASS**
- Fundamental Current : 0.120 A
- Real Power : 24.4 W
- Power Factor : 0.416
- Percent in Envelope : 100.0 %
- Temperature : 27 °C
- Relative Humidity : 45% RH
- Test Date : Jul. 27, 2000

Harmonic Number	Standard Limit (A rms)	Cursor Value (A rms)	Cursor Value (% Limit)	Mean Value (A rms)	Mean Value (% Limit)	Max. Span Value (A rms)
Fund.		0.1201		0.1202		0.1207
2	1.0800	0.0013	0.1	0.0012	0.1	0.0020
3	2.3000	0.0992	4.3	0.0993	4.3	0.0997
4	0.4300	0.0012	0.3	0.0013	0.3	0.0018
5	1.1400	0.0966	8.5	0.0967	8.5	0.0973
6	0.3000	0.0014	0.5	0.0015	0.5	0.0020
7	0.7700	0.0898	11.7	0.0898	11.7	0.0905
8	0.2300	0.0011	0.5	0.0012	0.5	0.0016
9	0.4000	0.0829	20.7	0.0828	20.7	0.0832
10	0.1840	0.0009	0.5	0.0010	0.5	0.0015
11	0.3300	0.0746	22.6	0.0747	22.6	0.0750
12	0.1933	0.0007	0.5	0.0007	0.5	0.0012
13	0.2100	0.0657	31.3	0.0656	31.2	0.0659
14	0.1314	0.0005	0.4	0.0005	0.4	0.0011
15	0.1800	0.0562	37.5	0.0561	37.4	0.0564
16	0.1150	0.0000	0.0	0.0002	0.2	0.0005
17	0.1324	0.0465	35.1	0.0463	35.0	0.0466
18	0.1022	0.0002	0.2	0.0002	0.2	0.0004
19	0.1184	0.0370	31.3	0.0368	31.1	0.0372
20	0.0920	0.0004	0.5	0.0003	0.3	0.0006
21	0.1071	0.0277	25.9	0.0277	25.9	0.0280
22	0.0836	0.0005	0.6	0.0004	0.4	0.0007
23	0.0678	0.0194	19.9	0.0193	19.8	0.0196
24	0.0767	0.0006	0.8	0.0005	0.6	0.0009
25	0.0900	0.0121	13.4	0.0120	13.4	0.0123
26	0.0708	0.0004	0.6	0.0004	0.6	0.0007
27	0.0835	0.0059	7.0	0.0059	7.1	0.0062
28	0.0657	0.0004	0.6	0.0004	0.6	0.0007
29	0.0776	0.0015	1.9	0.0015	1.9	0.0017
30	0.0613	0.0004	0.6	0.0004	0.6	0.0006
31	0.0726	0.0030	4.1	0.0030	4.2	0.0032
32	0.0575	0.0004	0.7	0.0004	0.6	0.0007
33	0.0682	0.0053	7.8	0.0054	7.9	0.0057
34	0.0541	0.0004	0.6	0.0003	0.6	0.0005
35	0.0643	0.0068	10.5	0.0068	10.5	0.0069
36	0.0511	0.0002	0.4	0.0002	0.4	0.0004
37	0.0606	0.0071	11.7	0.0072	11.8	0.0073
38	0.0484	0.0001	0.1	0.0001	0.2	0.0003
39	0.0577	0.0068	11.8	0.0068	11.8	0.0070
40	0.0460	0.0001	0.1	0.0001	0.2	0.0002

Test Engineer : *Bruce*
 BRUCE HUANG

7.5.2 Test Graph Of Harmonics

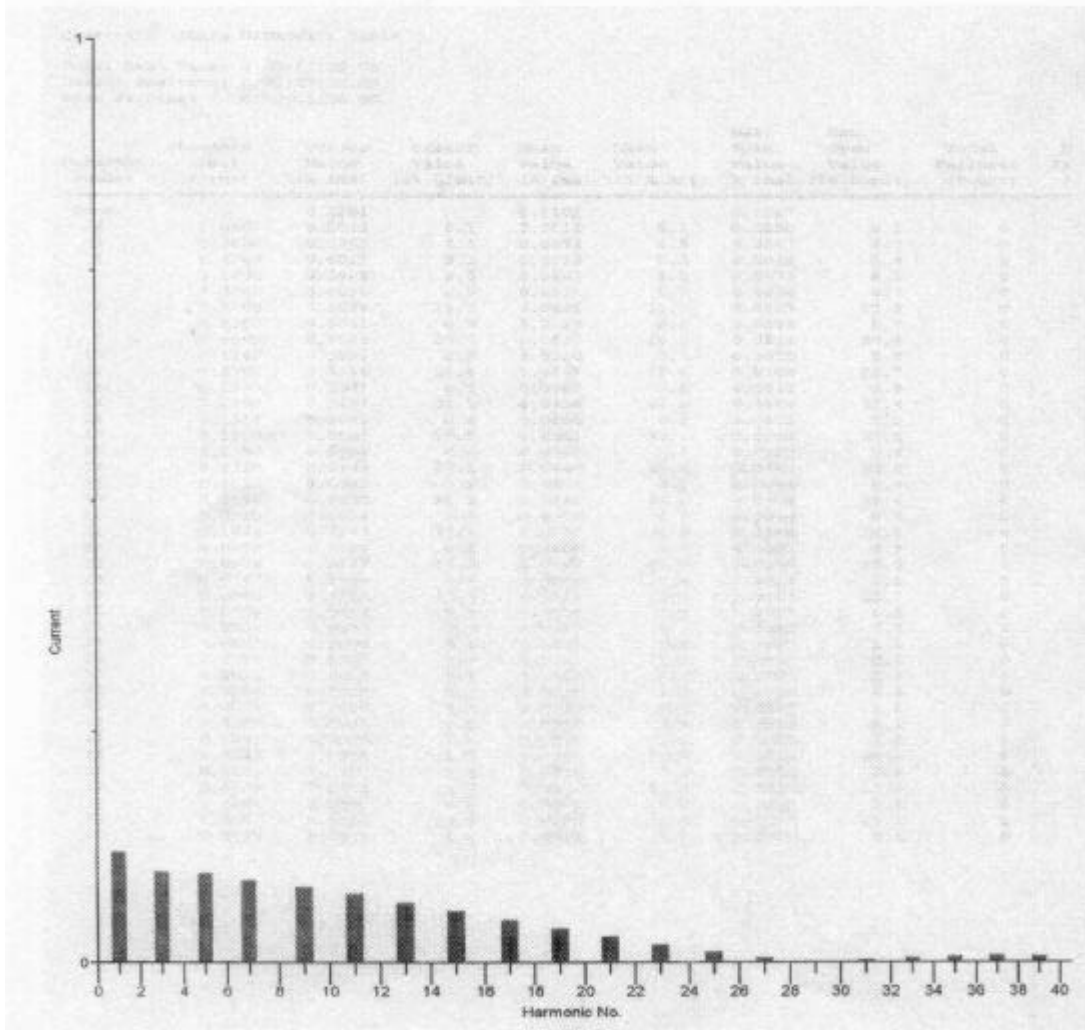

8. Voltage Fluctuations Test

8.1 Standard

- Standard : EN 61000-3-3 (1995)

8.2 Test Procedure

The equipment shall be tested under the conditions of **Clause 5**.

The total impedance of the test circuit, excluding the appliance under test, but including the internal impedance of the supply source, shall be equal to the reference impedance. The stability and tolerance of the reference impedance shall be adequate to ensure that the overall accuracy of $\pm 8\%$ is achieved during the whole assessment procedure.

8.3 Test Equipment Settings

- Line Voltage : 230 V
- Line Frequency : 50 Hz
- Measurement Delay : 10.0 seconds
- Pst Integration Time : 10 minutes
- Pst Integration Periods : 1
- Test Duration : 00:10:00 minutes



8.4 Test Setup

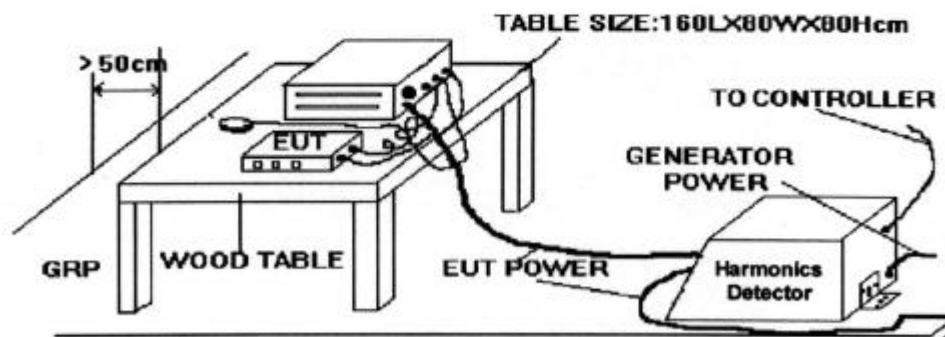

8.5 Test Result Of Voltage Fluctuation And Flicker Test

8.5.1 Test Data Of Voltage Fluctuation And Flicker

- FINAL TEST RESULT : **PASS**
- Temperature : 27 °C
- Relative Humidity : 45% RH
- Test Date : Jul. 27, 2000

	Pst	Plt	Dc (%)	Dmax (%)	Dt (%)
Reading	0.070	0.00	0.00	0.00	0.00
Limit	0.65	1.0	3.0	4.0	3.0

Test Engineer : *Bruce*
BRUCE HUANG

8.5.2 Test Graph Of Voltage Fluctuation And Flicker

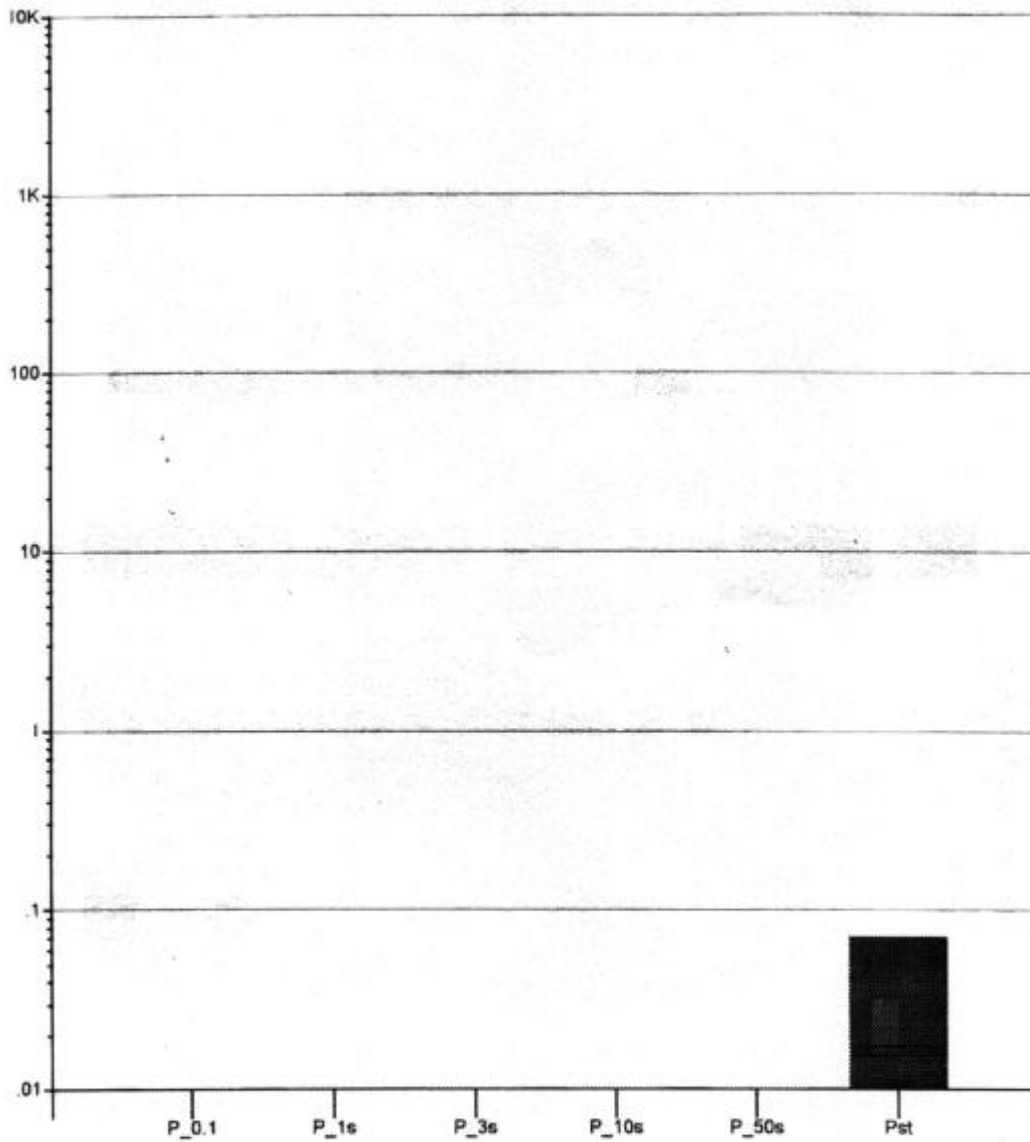

8.6 Photographs Of Harmonics Test, Voltage Fluctuation And Flicker Test

FRONT VIEW



REAR VIEW

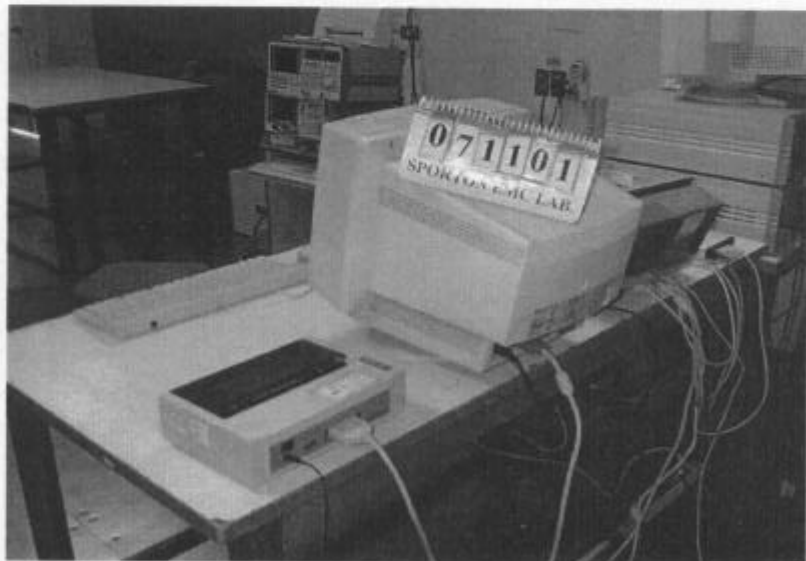

9. Electrostatic Discharge Immunity Test (ESD)

- Pass Performance Criteria : B
- Basic Standard : EN 61 000-4-2:1995
- Generic Standard : EN 55024:1998
- Level : 3 for air discharge,
: 2 for contact discharge
- Tested voltage : $\pm 2 / \pm 4 / \pm 8$ KV for air discharge,
: $\pm 2 / \pm 4$ KV for contact discharge
- Temperature : 22 °C
- Relative Humidity : 44 %
- Test Date : Jul. 27, 2000

9.1 Test setup

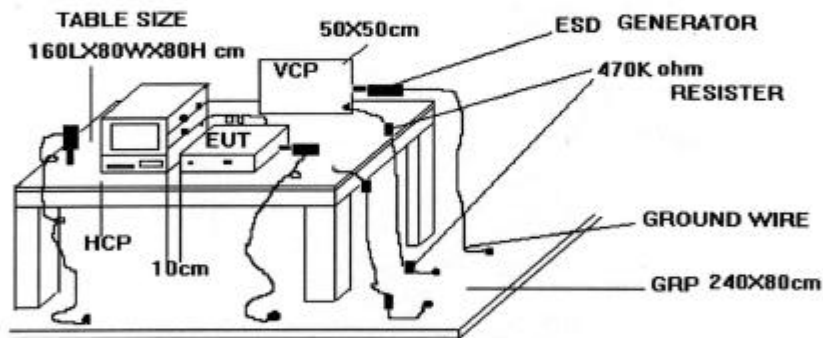

The test setup consists of the test generator, EUT and auxiliary instrumentation necessary to perform DIRECT and INDIRECT application of discharges to the EUT as applicable, in the follow manner :

- a. CONTACT DISCHARGE to the conductive surfaces and to coupling plane;
- b. AIR DISCHARGE at insulating surfaces.

The preferred test method is that of type tests performed in laboratories and the only accepted method of demonstrating conformance with this standard. The EUT was arranged as closely as possible to arrangement in final installed conditions.

9.2 Test Setup for Tests Performed in Laboratory

A ground reference plane was provided on the floor of the test site. It was a metallic sheet (copper or aluminum) of 0.25 mm, minimum thickness; other metallic may be used but they shall have at least 0.65 mm thickness. In the SPORTON EMC LAB., we provided 1 mm thickness aluminum ground reference plane or 1 mm thickness stainless steel ground reference plane. The minimum size of the ground reference plane is 1 m x 1 m, the exact size depending on the dimensions of the EUT. It was connected to the protective grounding system.

The EUT was arranged and connected according to its functional requirements. A distance of 1m minimum was provided between the EUT and the wall of the lab. and any other metallic structure. In cases where this length exceeds the length necessary to apply the discharges to the selected points, the excess length shall, where possible, be placed non-inductively off the ground reference plane and shall not come closer than 0.2m to other conductive parts in the test setup.

Where the EUT is installed on a metal table, the table was connected to the reference plane via a cable with a 470k ohm resistor located at each end, to prevent a build-up of charge. The test setup was consist a wooden table, 0.8m high, standing on the ground reference plane. A HCP, 1.6 m x 0.8 m, was placed on the table. The EUT and cables was isolated from the HCP by an insulating support 0.5 mm thick. The VCP size, 0.5 m x 0.5 m.

9.3 ESD Test Procedure

- a. In the case of air discharge testing the climatic conditions shall be within the following ranges:
 - ambient temperature: 15°C to 35°C;
 - relative humidity : 30% to 60%;
 - atmospheric pressure : 68 KPa (680 mbar) to 106 KPa (1060 mbar).
- b. Test programs and software shall be chosen so as to exercise all normal modes of operation of the EUT. The use of special exercising software is encouraged, but permitted only where it can be shown that the EUT is being comprehensively exercised.
- c. The test voltage shall be increased from the minimum to the selected test severity level, in order to determine any threshold of failure. The final severity level should not exceed the product specification value in order to avoid damage to the equipment.
- d. The test shall be performed with single discharges. On preselected points at least ten single discharges (in the most sensitive polarity) shall be applied.
- e. For the time interval between successive single discharges an initial value of one second is recommended. Longer intervals may be necessary to determine whether a system failure has occurred.
- f. In the case of contact discharges, the tip of the discharge electrode shall touch the EUT before the discharge switch is operated.
- g. In the case of painted surface covering a conducting substrate, the following procedure shall be adopted :
 - If the coating is not declared to be an insulating coating by the equipment manufacturer, then the pointed tip of the generator shall penetrate the coating so as to make contact with the conducting substrate.
 - Coating declared as insulating by the manufacturer shall only be submitted to the air discharge.
 - The contact discharge test shall not be applied to such surfaces.
- h. In the case of air discharges, the round discharge tip of the discharge electrode shall be approached as fast as possible (without causing mechanical damage) to touch the EUT . After each discharge, the ESD generator (discharge electrode) shall be removed from the EUT. The generator is then retriggered for a new single discharge. This procedure shall be repeated until the discharges are completed. In the case of an air discharge test, the discharge switch, which is used for contact discharge, shall be closed.

9.4 Test Severity Levels

9.4.1 Contact Discharge

Level	Test Voltage (KV) of Contact discharge
1	±2
2	±4
3	±6
4	±8
X	Specified

Remark : "X" is an open level.

9.4.2 Air Discharge

Level	Test Voltage (KV) of Air Discharge
1	±2
2	±4
3	±8
4	±15
X	Specified

Remark : "X" is an open level.

9.5 Test Points

9.5.1 Test Result of Air Discharge

Test Point	Voltage	Tested No.	Observation	Result
Case	$\pm 2 / \pm 4 / \pm 8$ KV	BY 10	NORMAL	PASS
Screw	$\pm 2 / \pm 4 / \pm 8$ KV	BY 10	NORMAL	PASS
FAN	$\pm 2 / \pm 4 / \pm 8$ KV	BY 10	NORMAL	PASS
Printer port	$\pm 2 / \pm 4 / \pm 8$ KV	BY 10	NORMAL	PASS
COM1 port	$\pm 2 / \pm 4 / \pm 8$ KV	BY 10	NORMAL	PASS
COM2 port	$\pm 2 / \pm 4 / \pm 8$ KV	BY 10	NORMAL	PASS
LED	$\pm 2 / \pm 4 / \pm 8$ KV	BY 10	NORMAL	PASS
Power Switch	$\pm 2 / \pm 4 / \pm 8$ KV	BY 10	NORMAL	PASS
PS/2 Port	$\pm 2 / \pm 4 / \pm 8$ KV	BY 10	NORMAL	PASS
LAN port	$\pm 2 / \pm 4 / \pm 8$ KV	BY 10	NORMAL	PASS
USB Port	$\pm 2 / \pm 4 / \pm 8$ KV	BY 10	NORMAL	PASS
LCD	$\pm 2 / \pm 4 / \pm 8$ KV	BY 10	NORMAL	PASS
AC SOCKET	$\pm 2 / \pm 4 / \pm 8$ KV	BY 10	NORMAL	PASS
VGA port	$\pm 2 / \pm 4 / \pm 8$ KV	BY 10	NORMAL	PASS
Com3 port	$\pm 2 / \pm 4 / \pm 8$ KV	BY 10	NORMAL	PASS

9.5.2 Test Result of Contact Discharge

Polarity	Voltage	Tested No.	Observation	Result
Horizontal (At Front)	$\pm 2 / \pm 4$ KV	BY 25	NORMAL	PASS
Horizontal (At Left)	$\pm 2 / \pm 4$ KV	BY 25	NORMAL	PASS
Horizontal (At Right)	$\pm 2 / \pm 4$ KV	BY 25	NORMAL	PASS
Horizontal (At Rear)	$\pm 2 / \pm 4$ KV	BY 25	NORMAL	PASS
Vertical (At Front)	$\pm 2 / \pm 4$ KV	BY 25	NORMAL	PASS
Vertical (At Left)	$\pm 2 / \pm 4$ KV	BY 25	NORMAL	PASS
Vertical (At Right)	$\pm 2 / \pm 4$ KV	BY 25	NORMAL	PASS
Vertical (At Rear)	$\pm 2 / \pm 4$ KV	BY 25	NORMAL	PASS
Case	$\pm 2 / \pm 4$ KV	BY 25	NORMAL	PASS
Screw	$\pm 2 / \pm 4$ KV	BY 25	NORMAL	PASS
Printer port	$\pm 2 / \pm 4$ KV	BY 25	NORMAL	PASS
COM1 port	$\pm 2 / \pm 4$ KV	BY 25	NORMAL	PASS
COM2 port	$\pm 2 / \pm 4$ KV	BY 25	NORMAL	PASS
PS/2 Port	$\pm 2 / \pm 4$ KV	BY 25	NORMAL	PASS
LAN port	$\pm 2 / \pm 4$ KV	BY 25	NORMAL	PASS
USB Port	$\pm 2 / \pm 4$ KV	BY 25	NORMAL	PASS
VGA port	$\pm 2 / \pm 4$ KV	BY 25	NORMAL	PASS
Com3 port	$\pm 2 / \pm 4$ KV	BY 25	NORMAL	PASS

Test Engineer : *Bruce*
BRUCE HUANG

9.6 Photographs of Electrostatic Discharge Immunity Test

FRONT VIEW



REAR VIEW

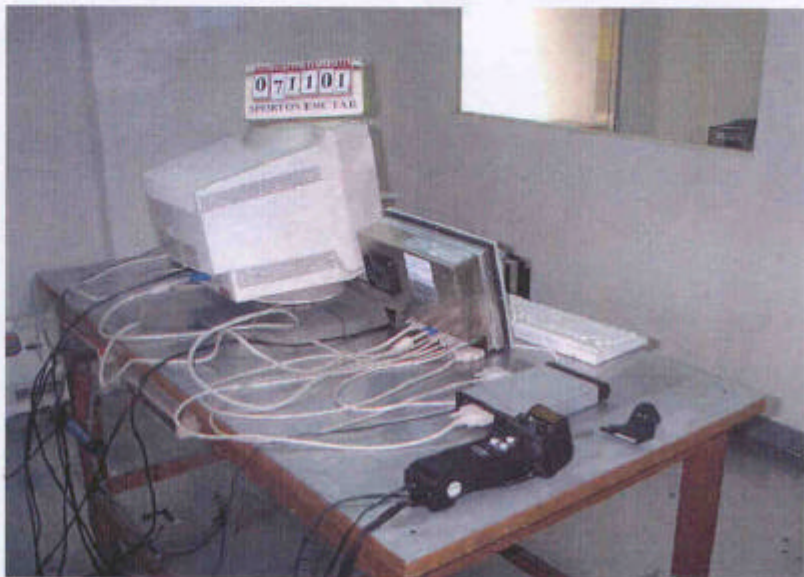

10. Radio Frequency Electromagnetic Field Immunity Test (RS)

- Pass Performance Criteria : A
- Basic Standard : EN 61 000-4-3:1996
- Generic Standard : EN 55024:1998
- Level : 2
- Frequency Range : 80-1000 MHz
- Field Strength : 3 V/m (Modulated 80% AM)
- Temperature : 26 °C
- Relative Humidity : 45 %
- Test Date : Jul. 27, 2000

10.1 Test setup

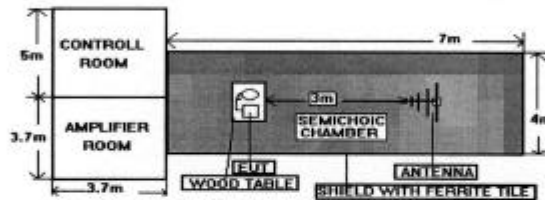

NOTE : The SPORTON 7m x 4m x 4m semichamber is compliance with the sixteen points uniform field requirement as stated in IEC 1000-4-3 Section 6.2.

The procedure defined in this part requires the generation of electromagnetic fields within which the test sample is placed and its operation observed. To generate fields that are useful for simulation of actual (field) conditions may require significant antenna drive power and the resultant high field strength levels. To comply with local regulations and to prevent biological hazards to the testing personnel, it is recommended that these tests be carried out in a shielded enclosure or semichamber.

10.2 Test Procedure

- a. The equipment to be tested is placed in the center of the enclosure on a wooden table. The equipment is then connected to power and signal leads according to pertinent installation instructions.
- b. The bilog antenna which is enabling the complete frequency range of 80-1000 MHz is placed 3m away from the equipment. The required field strength is determined by placing the field strength meter(s) on top of or directly alongside the equipment under test and monitoring the field strength meter via a remote field strength indicator outside the enclosure while adjusting the continuous-wave to the applicable antennae.
- c. The test is normally performed with the antenna facing the most sensitive side of the EUT. The polarization of the field generated by the biconical antenna necessitates testing each position twice, once with the antenna positioned vertically and again with the antenna positioned horizontally. The circular polarization of the field from the log-spiral antenna makes a change of position of the antenna unnecessary.
- d. At each of the above conditions, the frequency range is swept 80-1000 MHz, pausing to adjust the R.F. signal level or to switch oscillators and antenna. The rate of sweep is in the order of 1.5×10^{-3} decades/s. The sensitive frequencies or frequencies of dominant interest may be discretely analyzed.

10.3 Test Severity Levels

Frequency Band : 80-1000 MHz

Level	Test field strength (V/m)
1	1
2	3
3	10
X	Specified

Remark : "X" is an open class.

Test Engineer : *Bruce*
 BRUCE HUANG

10.4 Photographs of Radio Frequency Electromagnetic Field Immunity Test

FRONT VIEW



REAR VIEW

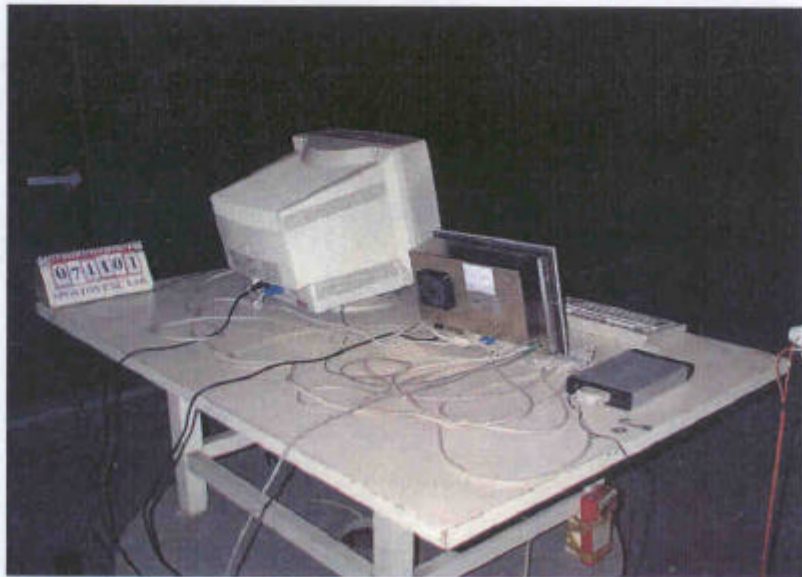

11. Electrical Fast Transient/Burst Immunity Test (EFT/BURST)

- Pass Performance Criteria : B
- Basic Standard : EN 61 000-4-4:1995
- Generic Standard : EN 55024:1998
- Level : on Power Supply -- 2
: on I/O signal, data and control line -- 2(TP cable)
- Tested voltage : on Power Supply -- 0.5/1.0 KV
: on I/O signal, data and control line -- 0.25/0.50 KV (TP cable)
- Temperature : 27°C
- Relative Humidity : 45%
- Test Date : Jul. 27, 2000

11.1 Test setup

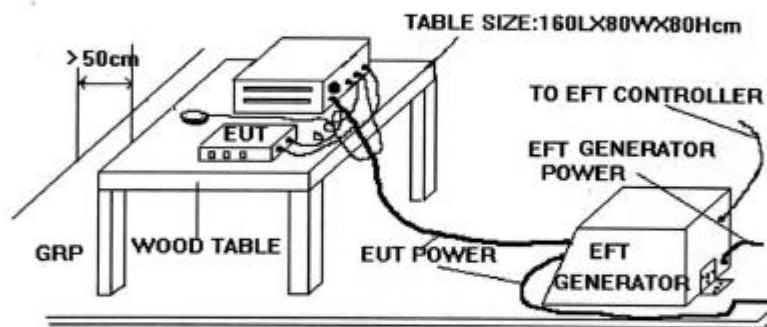

The EUT was placed on a ground reference plane and was insulated from it by an insulating support about 0.1m thick. If the EUT is table-top equipment, it was located approximately 0.8m above the GRP.. The GRP. was a metallic sheet (copper or aluminum) of 0.25 mm ,minimum thickness; other metallic may be used but they shall have at least 0.65 mm thickness. It shall project beyond the EUT by at least 0.1m on all sides and connected to the protective earth. In the SPORTON EMC LAB. we provided 1 mm thickness aluminum ground reference plane or 1 mm thickness stainless steel ground reference plane. The minimum size of the ground reference plane is 1 m x 1 m, the exact size depending on the dimensions of the EUT. It was connected to the protective grounding system. The EUT was arranged and connected according to its functional requirements. The minimum distance between the EUT and other conductive structures, except the GRP. beneath the EUT, was more than 0.5 m. Using the coupling clamp, the minimum distance between the coupling plates and all other conductive structures, except the GRP. beneath the EUT, was more than 0.5 m. The length of the signal and power lines between the coupling device and the EUT was 1m or less.

11.2 Test on Power Line

- a. The EFT/B-generator was located on the GRP.. The length from the EFT/B-generator to the EUT as not exceed 1 m.
- b. The EFT/B-generator provides the ability to apply the test voltage in a non-symmetrical condition to the power supply input terminals of the EUT.

11.3 Test on Communication Lines

- a. The coupling clamp is composed of a clamp unit for housing the cable (length more than 3 m), and was placed on the GRP..
- b. The coupling clamp provides the ability of coupling the fast transient/bursts to the cable under test.

11.4 Test Procedure

- a. In order to minimize the effect of environmental parameters on test results, the climatic conditions when test is carrying out shall comply with the following requirements:
 - ambient temperature: 15°C to 35°C;
 - relative humidity : 45% to 75%;
 - atmospheric pressure : 68 KPa (680 mbar) to 106 KPa (1060 mbar).
- b. In order to minimize the effect of environmental parameters on test results, the electromagnetic environment of the laboratory shall not influence the test results.
- c. The variety and diversity of equipment and systems to be tested make it difficult to establish general criteria for the evaluation of the effects of fast transients/bursts on equipment and systems.
- d. The test results may be classified on the basic of the operating conditions and the functional specification of the equipment under test, according to the following performance criteria :
 - Normal performance within the specification limits.
 - Temporary degradation or loss of function or performance which is self-recoverable.
 - Temporary degradation or loss of function or performance which requires operator intervention or system reset.
 - Degradation or loss of function which is not recoverable due to damage of equipment (components).

11.5 Test Severity Levels

The following test severity levels are recommended for the fast transient/burst test :

Open circuit output test voltage \pm 10%		
Level	On Power Supply	On I/O signal, data and control line
1	0.5 KV	0.25 KV
2	1.0 KV	0.50 KV
3	2.0 KV	1.00 KV
4	4.0 KV	2.00 KV
X	Specified	Specified

Remark : " X " is an open level. The level is subject to negotiation between the user and the manufacturer or is specified by the manufacturer.

Test Engineer : *Bruce*
 BRUCE HUANG

11.6 Photographs of Electrical Fast Transient/BURST Immunity Test

FRONT VIEW

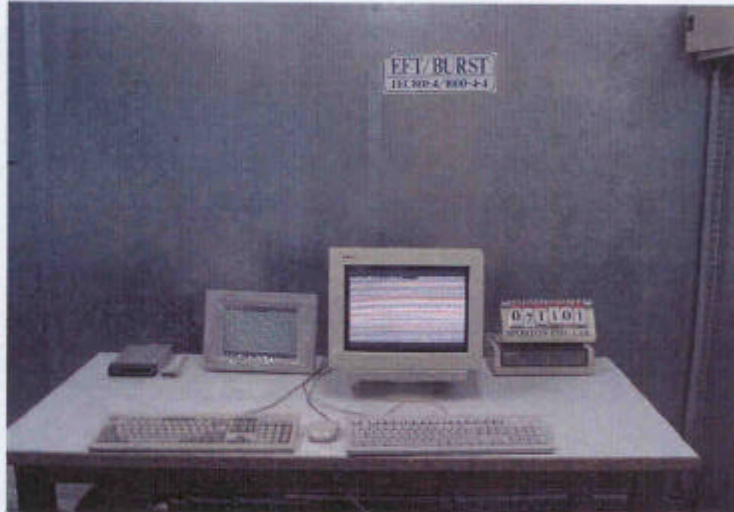

REAR VIEW



CLAMP TP

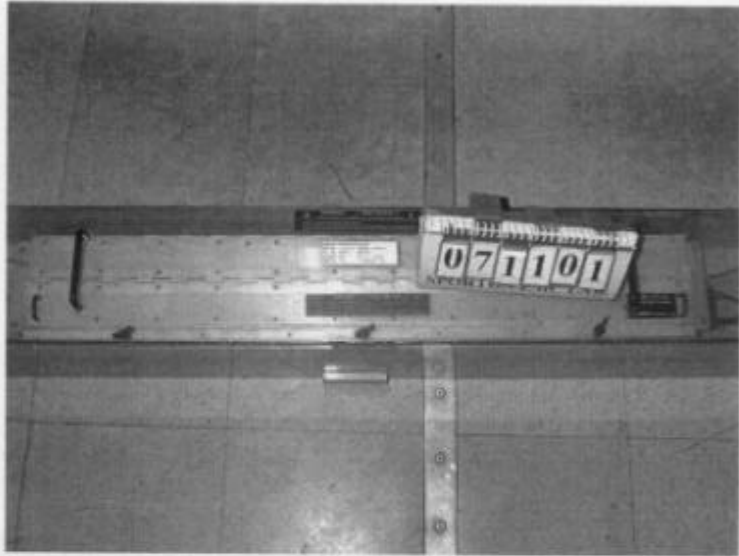

12. SURGE IMMUNITY TEST

- **Pass** performance Criteria : **A**
- Basic Standard : EN 61 000-4-5 (1995)
- Generic Standard : EN 55 024:1998
- Input Voltage, Frequency : 230Vac, 50Hz
- Level : 3
- Test Voltage : $\pm 1.0 / \pm 2.0$ KV
- Temperature : 27 °C
- Relative Humidity : 43 %
- Test Date : Jul. 27, 2000

12.1 TEST RECORD

Voltage (KV)	Test Location	Polarity	Phase Angle				Test Result
			0°	90°	180°	270°	
1 KV	L - N	+	A	A	A	A	<u>PASS</u>
		-	A	A	A	A	<u>PASS</u>
2 KV	L - PE	+	A	A	A	A	<u>PASS</u>
		-	A	A	A	A	<u>PASS</u>
	N - PE	+	A	A	A	A	<u>PASS</u>
		-	A	A	A	A	<u>PASS</u>

Remark : PE = DC output GND

12.2 TEST LEVEL

Level	Open-circuit test voltage, $\pm 10\%$, KV
1	0.5
2	1.0
3	2.0
4	4.0
x	Specified
NOTE - x is an open class. This level can be specified in the product specification.	

12.3 TEST PROCEDURE

- a. Climatic conditions
 - The climatic conditions shall comply with the following requirements :
 - ambient temperature : 15 °C to 35 °C
 - relative humidity : 10 % to 75 %
 - atmospheric pressure : 86 kPa to 106 kPa (860 mbar to 1060 mbar)
- b. Electromagnetic conditions
 - The electromagnetic environment of the laboratory shall not influence the test results.
- c. The test shall be performed according the test plan that shall specify the test set-up with
 - generator and other equipment utilized;
 - test level (voltage/current);
 - generator source impedance;
 - internal or external generator trigger;
 - number of tests : at least five positive and five negative at the selected points;
 - repetition rate : maximum 1/min.
 - inputs and outputs to be tested;
 - representative operating conditions of the EUT;
 - sequence of application of the surge to the circuit;

- phase angle in the case of a.c. power supply;
- actual installation conditions, for example :
 - AC : neutral earthed,
 - DC : (+) or (-) earthed to simulated the actual earthing conditions.

- d. If not otherwise specified the surges have to be applied synchronized to the voltage phase at the zero-crossing and the peak value of the a.c. voltage wave (positive and negative).

- e. The surges have to be applied line to line and line(s) and earth. When testing line to earth, the test voltage has to be applied successively between each of the lines and earth, if there is no other specification.

- f. The test procedure shall also consider the non-linear current-voltage characteristics of the equipment under test. Therefore the test voltage has to be increased by steps up to the test level specified in the product standard or test plan.

- g. All lower levels including the selected test level shall be satisfied. For testing the secondary protection, the output voltage of the generator shall be increased up to the worstcase voltage breakdown level (let-through level) of the primary protection.

- h. If the actual operating signal sources are not available, they may be simulated. Under no circumstances may the test level exceed the product specification. The test shall be carried out according to the test plan.

- i. To find all critical points of the duty cycle of the equipment, a sufficient number of positive and negative test pulses shall be applied. For acceptance test a previously unstressed equipment shall be used to the protection devices shall be replaced.

12.4 OPERATING CONDITION

Full system

12.5 Photographs of SURGE IMMUNITY TEST

FRONT VIEW



REAR VIEW



13. CONDUCTED DISTURBANCES INDUCED BY RADIO-FREQUENCY FIELD IMMUNITY TEST (CS)

- **Pass** performance Criteria : **A**
- Basic Standard : EN 61 000-4-6 (1996)
- Generic Standard : EN 55 024 :1998
- Input Voltage, Frequency : AC 230V, 50Hz
- Level : 2
- Test Voltage : 3 V/rms (Modulated, 1KHz, 80%, AM)
- Frequency Range : 0.15 MHz to 80 MHz
- Temperature : 26° C
- Relative Humidity : 46 %
- Test Date : Jul. 27, 2000

13.1 TEST LEVEL

Level	Voltage Level (EMF),
1	1 V
2	3 V
3	10 V
x	Specified
NOTE - x is an open class. This level can be specified in the product specification.	

13.2 OPERATING CONDITION

Full system

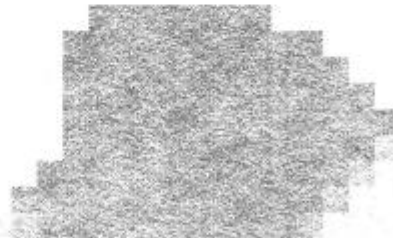

13.3 TEST PROCEDURE

- a. The EUT shall be operated within its intended climatic conditions. The temperature and relative humidity should be recorded.
- b. This test method test can be performed without using a sell shielded enclosure. This is because the disturbance levels applied and the geometry of the setups are not likely to radiated a high amount of energy, especially at the lower frequencies. If under certain circumstances the radiated energy is too high, a shielded enclosure has to be used.
- c. The test shall be performed with the test generator connected to each of the coupling and decoupling devices in turn while the other non-excited RF-input ports of the coupling devices are terminated by a 50 ohm load resistor.
- d. Filters shall be used to prevent (higher order or sub-) harmonics form disturbing the EUT. A High-Pass Filter. 100KHz, (HPF) may be required with the test generator. The band stop characteristics of the Low-Pass Filters (LPF) shall be sufficient to suppress the harmonics down to the immunity level required within that band. These filters shall be inserted with the test generator before setting the test level.
- e. The frequency range is swept from 150 KHz to 230 MHz, using the signal levels established during the setting process, and with the disturbance signal 80% amplitude modulated with a 1KHz sinewave, pausing to adjust the RF-signal level or to switch coupling devices as necessary. The rate of sweep shall no exceed 1.5×10^{-3} decades/s. Where the frequency is swept incrementally, the step size shall no exceed 1% of the start and thereafter 1% of the preceding frequency value.
- f. The dwell time at each frequency shall not be less than the time necessary for the EUT to be exercised, and able to respond. Sensitive frequencies e.g. clock frequency(ies) and harmonics or frequencies of dominant interest shall be analyzed separately.
- g. An alternative test procedure may be adopted, wherein the frequency range is swept incrementally, with a step size not exceeding 4% of the start ad thereafter 4% of the preceding frequency value. The test level should be at least twice the value of the specified test level.
- h. In cases of dispute, the test procedure using a step size not exceeding 1% of the start and thereafter 1% of preceding frequency value shall take precedence.
- i. Attempts should be made to fully exercise the EUT during testing, and to fully interrogate all exercise modes selected for susceptibility.
- j. The use of special exercising programs is recommended.
- k. Testing shall be performed according to a Test Plan, which shall be included in the test report.
- l. It may be necessary to carry out some investigatory testing in order to establish some aspects of the test plan.

14. Power Frequency Magnetic Field immunity tests

The EUT does not contain device susceptible to magnetic fields.

So the power frequency magnetic field test is not applicable to this equipment.

15. VOLTAGE DIPS AND VOLTAGE INTERRUPTIONS IMMUNITY TESTS

- **Pass** performance Criteria : C for voltage interruption, A for voltage dips
- Basic Standard : EN 61 000-4-11 (1994)
- Generic Standard : EN 55 024:1998
- Input Voltage, Frequency : AC 230V, 50Hz
- Temperature : 27 °C
- Relative Humidity : 43 %
- Test Date : Jul. 27, 2000

15.1 TEST RECORD OF VOLTAGE INTERRUPTION

Voltage (V)	Phase Angle								% Reduction	periods (s)
	0 °	45 °	90 °	135 °	180 °	225 °	270 °	315 °		
230	C	C	C	C	C	C	C	C	>95%	250

15.2 TEST RECORD OF VOLTAGE DIPS

Voltage (V)	Phase Angle								% Reduction	periods (s)
	0 °	45 °	90 °	135 °	180 °	225 °	270 °	315 °		
230	A	A	A	A	A	A	A	A	30	25
230	A	A	A	A	A	A	A	A	>95 %	0.5

15.3 TESTING REQUIREMENT AND PROCEDURE

The test was based on EN 61 000-4-11 (1994)

15.4 TEST CONDITIONS

1. Source voltage and frequency : 230V / 50Hz, Single phase.
2. Test of interval : 10 sec.
3. Level and duration : Sequency of 3 dips/interrupts.
4. Voltage rise (and fall) time : 1 ~ 5 μ s.
5. Test severity :

Voltage dip and Interrupt reduction (%)	Test Duration (ms)
30	500
60	100
100	10
100	80
100	5000

15.5 OPERATING CONDITION

Full system

15.6 Photographs of VOLTAGE DIPS AND VOLTAGE INTERRUPTIONS IMMUNITY TESTS

FRONT VIEW



REAR VIEW

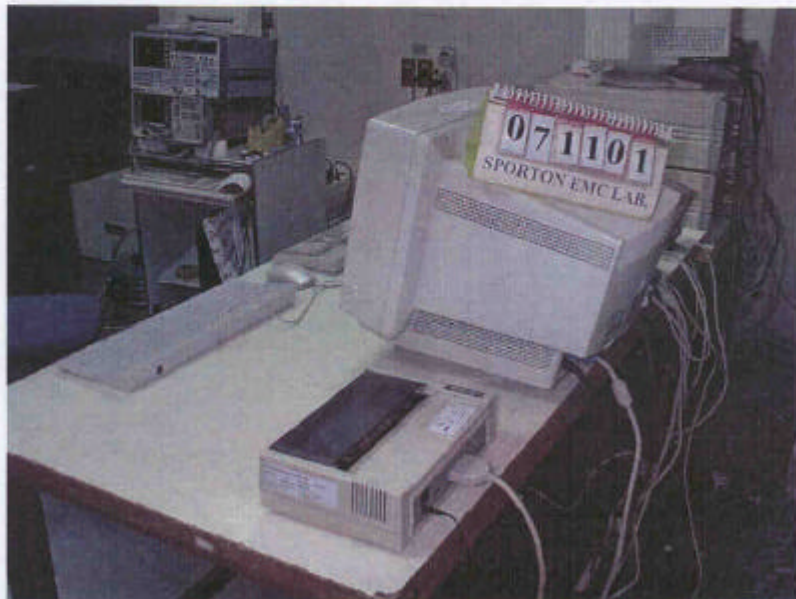

16. Antenna Factor & Cable Loss

Frequency (MHz)	Antenna Factor (dB)	Cable Loss (dB)
30	19.2	0.8
35	13.4	0.9
40	13.4	0.9
45	11.5	1.1
50	9.9	1.1
55	7.9	1.2
60	6.0	1.3
65	6.4	1.4
70	6.8	1.5
75	7.1	1.5
80	7.3	1.5
85	8.2	1.6
90	9.2	1.6
95	10.1	1.6
100	11.0	1.7
110	11.4	1.9
120	11.8	2.0
130	11.3	2.2
140	10.8	2.2
150	10.7	2.2
160	9.7	2.3
170	9.4	2.4
180	9.5	2.5
190	9.4	2.5
200	9.3	2.6
220	10.4	2.8
240	11.4	3.0
260	12.2	2.9
280	12.5	3.2
300	12.9	3.2
320	13.3	3.3
340	13.7	3.6
360	14.5	3.9
380	15.5	3.9
400	16.5	3.9
450	16.5	4.2
500	18.3	4.4
550	18.9	4.8
600	20.1	4.8
650	18.1	5.1
700	17.2	5.4
750	17.9	5.8
800	18.0	6.1
850	17.7	6.6
900	21.0	6.6
950	21.0	6.9
1000	20.3	7.0

NHOP3

17. List of Measuring Equipment Used

(EMI)

Instrument	Manufacturer	Model No.	Serial No.	Characteristics	Calibration Date	Remark
EMC Receiver	HP	8591EM	3710A01187	9 KHz - 1.8 GHz	Jul. 07, 2000	Conduction
LISN (for EUT)	EMCO	3810/2	9703-1838	50uH / 50 OHM	Aug. 30, 1999	Conduction
LISN (for support device)	Kyoritsu	KNW-407	8-1010-15	50uH / 50 OHM	Nov. 16, 1999	Conduction
EMI Filter	CORCOM	MRI-2030	N/A	480VAC / 30A	N/A	Conduction
Spectrum Analyzer (site 3)	Advantest	R3261C	71720471	9KHz - 2.6GHz	Dec. 12, 1999	Radiation
Amplifier (Site 3)	HP	8447D	2944A06292	0.1MHz - 1.3GHz	Feb. 19, 2000	Radiation
Bilog Antenna (Site 3)	CHASE	CBL6112A	2218	30MHz - 2GHz	Jan. 29, 2000	Radiation
Half-wave dipole antenna (Site 3)	EMCO	3121C	8912-1285	20MHz - 1GHz	May 17, 2000	Radiation
Turn Table	EMCO	1060-1.211	9508-1805	0 - 360 degree	N/A	Radiation
Antenna Mast	EMCO	1051-1.2	9502-1868	1 m - 4 m	N/A	Radiation

(EMS)

Instrument	Manufacturer	Model No.	Characteristics	Calibration Date	Remark
ESD Simulator	KEYTEK	MZ-15/EC	0 KV - 15 KV	Apr. 14, 2000	ESD
OMNI-Tip	KEYTEK	TPC-2	0 KV - 15 KV	Jul. 22, 2000	ESD
Amplifier	AR	100W 1000M3	80 MHz - 1 GHz	N/A	RS
Isotropic Field Probe	AR	FP3000A	10 KHz - 1 GHz	Jun. 19, 2000	RS
IEEE-488 Interface	AR	CP3000	N/A	N/A	RS
System Interface	EMC Automation	200	HP-IB INTERFACE	N/A	RS
Power Meter	EMC Automation	438A	100 KHz -4.2 GHz	N/A	RS
Video Camera controller	EMC Automation	VCC-01	N/A	N/A	RS
Signal Generator	HP	8648A	100 KHz - 1 GHz	Sep. 10, 1999	RS
Signal Generator	R&S	SMX	100 KHz - 1 GHz	Nov. 07, 1999	RS
Antenna	CHASE	CBL6121A	26 MHz - 1 GHz	Jun. 12, 2000	RS
Amplifier	AR	75W 75A220	25MHz - 300MHz	Jun. 14, 2000	RS
EFT Generator	KEYTEK	CE-40	0 KV - 4.4 KV	Jul. 09, 2000	EFT
Capacitive Clamp	KEYTEK	CE-40-CCL	0 KV - 2 KV	Jun. 22, 2000	EFT
Harmonic/Flicker Test System	HP	6843A	4800VA 90A / 48A PEAK	Nov. 15, 1999	Harmonics, Flicker
Combination Wave Generator	EMC PARTNER AG Switzerland	MIG0603IN2	6 KV, 3 KA	Feb. 05, 2000	SURGE
Conducted Immunity Test System	FRANKONIA	CIT-10/W	100KHz ~ 266MHz	Jan. 10, 2000	CS
Magnetic field Antenna	EMC PARTNER	MF-1000	0.5 up to 150A / m	Feb. 02, 2000	Magnetic
EMC Immunity Tester	EMC PARTNER AG Switzerland	TRANSIENT 1000	0 - 260 rms, 16A	Feb. 02, 2000	DIP

18. Notice for Class A Product

Class A ITE is a category of all other ITE which satisfies the class A ITE limits but not the class B ITE limits. Such equipment should not be restricted in its sale but the following warning shall be included in the instructions for use:

Warning

This is a class A product. In a domestic environment this product may cause radio interference in which case the user may be required to take adequate measures.

19. Declaration of Conformity and the CE Mark

There are three possible procedures pertaining to the declaration of conformity :

19.1 Conformity Testing and Declaration of Conformity by the Manufacturer or His Authorized Representative Established within the Community or by an Importer.

- Article 10 (1) of the EMC Directive,
- § 3 (1) no. 2a of the EMC Act.

19.2 Declaration of Conformity Issued by the Manufacturer or His Authorized Representative Established within the Community or by an Importer Following Testing of the Product and Issued of an EC certificate of conformity by a competent body.

- Article 10 (2) of the EMC Directive,
- § 3 (1) no. 2b of the EMC Act.

19.3 Declaration of Conformity Issued by the Manufacturer or His Authorized Representative Established within the Community or by an Importer Following Testing and Certification of the Product by a Notified Body.

- Article 10 (5) of the EMC Directive,
- § 3 (1) no. 2b of the EMC Act (radio transmitting installations).

19.4 Specimen For The CE Marking Of Electrical / Electronical Equipment

The components of the CE marking shall have substantially the same vertical dimension, which may not be less than 5 mm.



APPENDIX A. Photographs of EUT



071101-01.jpg

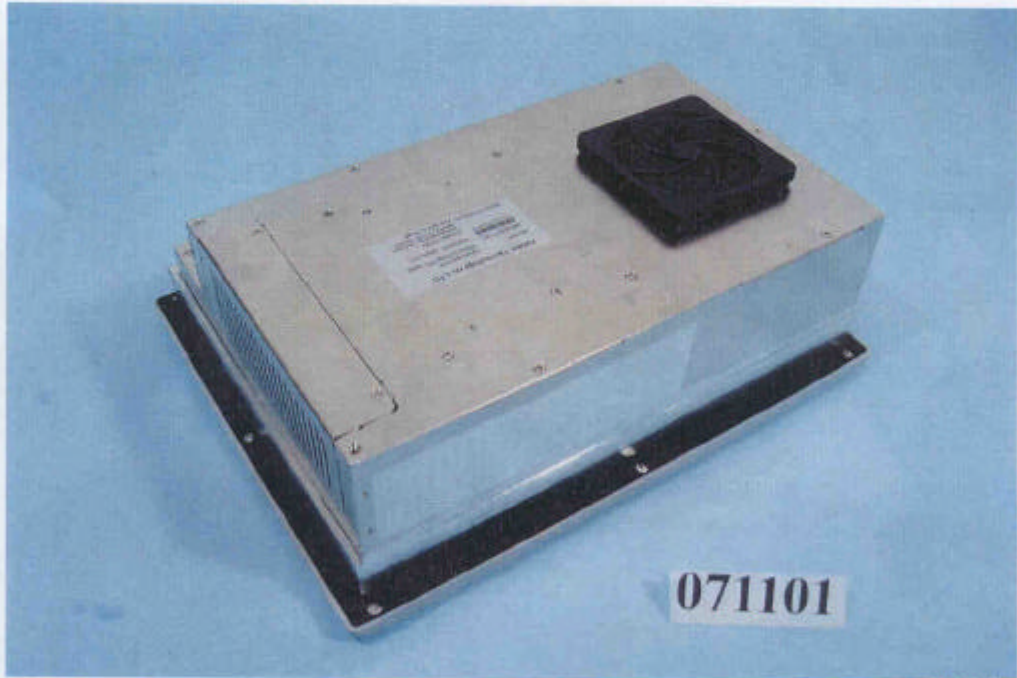

071101-02.jpg



071101-03.jpg