

TEST REPORT
IEC 60950-1
Information technology equipment – Safety –
Part 1: General requirements

Report Number..... : T171027D06B-LV

Date of issue..... : Jan. 15, 2018

Total number of pages : 44

Applicant's name : AAEON Technology Inc.

Address..... : 5F, No.135, Lane 235, Pao Chiao Rd, Hsin-Tien Dist., New Taipei City, Taiwan, R.O.C.

Test specification:

Standard..... : EN 60950-1:2006 + A11:2009 + A1:2010 + A12:2011 + A2:2013
IEC 60950-1:2005 (Second Edition) + Am 1:2009 + Am 2:2013

Test procedure : LVD of CE

Non-standard test method : N/A

Test Report Form No. : IEC60950_1F

Test Report Form(s) Originator : SGS Fimko Ltd

Master TRF : Dated 2014-02

Copyright © 2014 IEC System of Conformity Assessment Schemes for Electrotechnical Equipment and Components (IECEE System). All rights reserved.

This publication may be reproduced in whole or in part for non-commercial purposes as long as the IECEE is acknowledged as copyright owner and source of the material. IECEE takes no responsibility for and will not assume liability for damages resulting from the reader's interpretation of the reproduced material due to its placement and context.

If this Test Report Form is used by non-IECEE members, the IECEE/IEC logo and the reference to the CB Scheme procedure shall be removed.

This report is not valid as a CB Test Report unless signed by an approved CB Testing Laboratory and appended to a CB Test Certificate issued by an NCB in accordance with IECEE 02.

General disclaimer:

The test results presented in this report relate only to the object tested.

This report shall not be reproduced, except in full, without the written approval of the Issuing CB Testing Laboratory. The authenticity of this Test Report and its contents can be verified by contacting the NCB, responsible for this Test Report.



Test item description..... : UP-Core board

Trade Mark..... : 

Manufacturer : Same as applicant

Model/Type reference : xUPC-CHT01x (x-where x may be any combination of alphanumeric characters or "-" or blank)

Ratings : I/P : DC 5V; 4.0A (Option)

Testing procedure and testing location:		
<input checked="" type="checkbox"/>	Testing Laboratory:	Compliance Certification Services Inc.
Testing location/ address.....:		Address : No.8, Jiucengling, Xinhua Dist., Tainan City 712, Taiwan. Testing location : 6 F, No. 605, Zhongshan Rd., Xinhua Dist., Tainan City 712, Taiwan.
<input type="checkbox"/>	Associated Testing Laboratory:	
Testing location/ address.....:		
Tested by (name + signature).....:		Shin Chen 
Approved by (name + signature).....:		Eason Chiang 
<hr/>		
<input type="checkbox"/>	Testing procedure: TMP/CTF Stage 1:	
Testing location/ address.....:		
Tested by (name + signature).....:		
Approved by (name + signature).....:		
<hr/>		
<input type="checkbox"/>	Testing procedure: WMT/CTF Stage 2:	
Testing location/ address.....:		
Tested by (name + signature).....:		
Witnessed by (name + signature).....:		
Approved by (name + signature).....:		
<hr/>		
<input type="checkbox"/>	Testing procedure: SMT/CTF Stage 3 or 4:	
Testing location/ address.....:		
Tested by (name + signature).....:		
Witnessed by (name + signature).....:		
Approved by (name + signature).....:		
Supervised by (name + signature).....:		
<hr/>		

<p>List of Attachments (including a total number of pages in each attachment):</p> <p>ATTACHMENT 1 : Appended table (1 page)</p> <p>ATTACHMENT 2 : National differences (54 pages)</p> <p>ATTACHMENT 3 : Photographs (3 pages)</p>	
<p>Summary of testing:</p>	
<p>Tests performed (name of test and test clause):</p> <ul style="list-style-type: none"> - INPUT TEST: SINGLE-PHASE (1.6.2) - LIMITED POWER SOURCE MEASUREMENTS (2.5) - BATTERY TEST (4.3.8) - HEATING TEST (4.5.1, 1.4.12, 1.4.13) - Continuously operating with below described maximum normal load configuration: The unit operated under all connectors connected transmit data continuously and each USB 3.0 port connected with a dummy load of 4.5W to represent the USB load. 	<p>Testing location:</p> <p>Compliance Certification Services Inc — Tainan Laboratory.</p> <p>6F, No.605, Zhongshan Rd., Xinhua Dist., Tainan City 712, Taiwan.</p>
<p>Summary of compliance with National Differences:</p> <p>EU Group Differences, EU Special National Conditions, AT, AU, BE, CA**, CH, CN*, CZ, DE**, DK, ES, FI**, FR, GB, GR, HU, IL, IT, KR**, NL, NO, PL, SE, SG, SI, SK, US.</p> <p>Explanation of used codes: AT=Austria, AU=Australia, BE=Belgium, CA=Canada, CH=Switzerland, CN=China, CZ=Czech Republic, DE=Germany, DK=Denmark, ES=Spain, FI=Finland, FR=France, GB=United Kingdom, GR=Greece, HU=Hungary, IL=Israel, IT=Italy, KR=Korea, NL=The Netherlands, NO=Norway, PL=Poland, SE=Sweden, SG=Singapore, SI=Slovenia, SK=Slovakia, US=United States of America.</p> <p>For National Differences see end of this test report.</p> <p>* National differences to IEC 60950-1:2005 evaluated.</p> <p>** National differences to IEC 60950-1:2005+A1 evaluated.</p> <p><input checked="" type="checkbox"/> The product fulfils the requirements of <u>EN 60950-1:2006 + A11:2009 + A1:2010 + A12:2011 + A2:2013.</u></p> <p>For National Differences see corresponding Attachment.</p>	

Copy of marking plate:

The artwork below may be only a draft. The use of certification marks on a product must be authorized by the respective NCBs that own these marks.

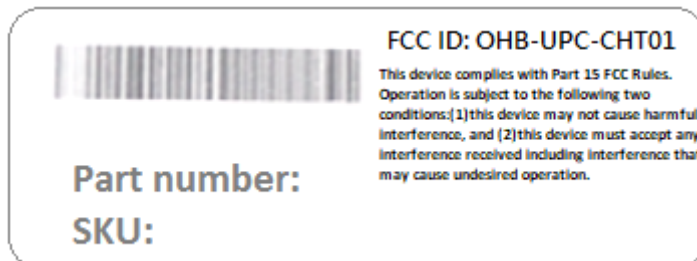

Trade mark printed on enclosure.

The label is used to represents other similar models

Test item particulars:	
Equipment mobility:	<input type="checkbox"/> movable <input type="checkbox"/> hand-held <input type="checkbox"/> transportable <input type="checkbox"/> stationary <input checked="" type="checkbox"/> for building-in <input type="checkbox"/> direct plug-in
Connection to the mains:	<input type="checkbox"/> pluggable equipment <input type="checkbox"/> type A <input type="checkbox"/> type B <input type="checkbox"/> permanent connection <input type="checkbox"/> detachable power supply cord <input type="checkbox"/> non-detachable power supply cord <input checked="" type="checkbox"/> not directly connected to the mains
Operating condition:	<input checked="" type="checkbox"/> continuous <input type="checkbox"/> rated operating / resting time:
Access location	<input checked="" type="checkbox"/> operator accessible <input type="checkbox"/> restricted access location
Over voltage category (OVC)	<input type="checkbox"/> OVC I <input type="checkbox"/> OVC II <input type="checkbox"/> OVC III <input type="checkbox"/> OVC IV <input checked="" type="checkbox"/> other: not directly connected to the mains
Mains supply tolerance (%) or absolute mains supply values	N/A
Tested for IT power systems	<input type="checkbox"/> Yes <input checked="" type="checkbox"/> No
IT testing, phase-phase voltage (V)	N/A
Class of equipment	<input type="checkbox"/> Class I <input type="checkbox"/> Class II <input checked="" type="checkbox"/> Class III <input type="checkbox"/> Not classified
Considered current rating of protective device as part of the building installation (A)	N/A
Pollution degree (PD)	<input type="checkbox"/> PD 1 <input checked="" type="checkbox"/> PD 2 <input type="checkbox"/> PD 3
IP protection class	IPX0
Altitude during operation (m)	Up to 2000
Altitude of test laboratory (m)	Up to 2000
Mass of equipment (kg)	0.05

Possible test case verdicts:	
- test case does not apply to the test object.....:	N/A
- test object does meet the requirement.....:	P (Pass)
- test object does not meet the requirement.....:	F (Fail)
Testing:	
Date of receipt of test item	2017-11-13
Date (s) of performance of tests:	2017-11-13 to 2017-12-12
General remarks:	
"(See Enclosure #)" refers to additional information appended to the report. "(See appended table)" refers to a table appended to the report.	
Throughout this report a <input type="checkbox"/> comma / <input checked="" type="checkbox"/> point is used as the decimal separator.	

Manufacturer's Declaration per sub-clause 4.2.5 of IECEE 02:	
The application for obtaining a CB Test Certificate includes more than one factory location and a declaration from the Manufacturer stating that the sample(s) submitted for evaluation is (are) representative of the products from each factory has been provided	<input type="checkbox"/> Yes <input checked="" type="checkbox"/> Not applicable
When differences exist; they shall be identified in the General product information section.	
Name and address of factory (ies) : AAEON Technology Inc. 5F, No.135, Lane 235, Pao Chiao Rd, Hsin-Tien Dist., New Taipei City, Taiwan, R.O.C.	
General product information:	
Report Summary	
1. All applicable tests according to the referenced standard(s) have been carried out.	
Product Description	
1. The equipment is an UP-Core board to use with information technology equipment.	
2. The external power adapter are CB scheme tested according to IEC 60950-1, see appended table 1.5.1 for detail information about the power adapter.	
Model Differences	
1. All models are identical except for model designation. For marketing purpose only, no safety impact.	
Technical Considerations	
1. The product was submitted and evaluated for use at the maximum ambient temperature (Tma) permitted by the manufacturer's specification of: 45°C.	
2. The product is in compliance with the requirement of IEC/EN 60950-1.	
Additional Information	
1. Some components are pre-certified and/or tested, which have been evaluated according to the relevant component requirements of IEC 60950-1, are employed in this product. Their suitability of use has been checked according to subclauses 1.5.1 and 1.5.2.	
2. The power supply unit used with the product is a certified product which was investigated according to the standard of same version. The suitability of use has been evaluated in this report.	
3. This report contains national differences as the class III equipment itself and is subject of this CB report. Destination countries should investigate this matter for external adapter while the equipment is submitted for national approval.	

Markings and Instructions

1. The following statement is marked in operating instructions. (See subclause 1.7.13)

CAUTION

RISK OF EXPLOSION IF BATTERY IS REPLACED BY AN INCORRECT TYPE DISPOSE OF USED BATTERIES ACCORDING TO THE INSTRUCTIONS

Abbreviations used in the report:

- normal conditions	N.C.	- single fault conditions	S.F.C
- functional insulation	FI	- basic insulation	BI
- double insulation	DI	- supplementary insulation	SI
- between parts of opposite polarity	BOP	- reinforced insulation	RI

Indicate used abbreviations (if any)

Report revise record:					
No.	Issue Date	Report Number	Rev.	Revisions	Effect Page
00	2018-01-15	T171027D06B-LV	00	Original report	N/A

IEC 60950-1			
Clause	Requirement + Test	Result - Remark	Verdict
1	GENERAL		P
1.5	Components		P
1.5.1	General	See below.	P
	Comply with IEC 60950-1 or relevant component standard	(see appended tables 1.5.1)	P
1.5.2	Evaluation and testing of components	Components certified to IEC harmonized standard and checked for correct application. Components not certified are used in accordance with their ratings and they comply with applicable parts of IEC 60950-1 and the relevant component Standard. Components, for which no relevant IEC-Standard exist, have been tested under the conditions occurring in the equipment, using applicable parts of IEC 60950-1.	P
1.5.3	Thermal controls		N/A
1.5.4	Transformers		N/A
1.5.5	Interconnecting cables	Not used.	N/A
1.5.6	Capacitors bridging insulation		N/A
1.5.7	Resistors bridging insulation		N/A
1.5.7.1	Resistors bridging functional, basic or supplementary insulation		N/A
1.5.7.2	Resistors bridging double or reinforced insulation between a.c. mains and other circuits		N/A
1.5.7.3	Resistors bridging double or reinforced insulation between a.c. mains and antenna or coaxial cable		N/A
1.5.8	Components in equipment for IT power systems		N/A
1.5.9	Surge suppressors		N/A
1.5.9.1	General		N/A
1.5.9.2	Protection of VDRs		N/A
1.5.9.3	Bridging of functional insulation by a VDR		N/A
1.5.9.4	Bridging of basic insulation by a VDR		N/A
1.5.9.5	Bridging of supplementary, double or reinforced insulation by a VDR		N/A

IEC 60950-1			
Clause	Requirement + Test	Result - Remark	Verdict
1.6	Power interface		P
1.6.1	AC power distribution systems	Class III equipment.	N/A
1.6.2	Input current	(see appended table 1.6.2)	P
1.6.3	Voltage limit of hand-held equipment		N/A
1.6.4	Neutral conductor		N/A
1.7	Marking and instructions		P
1.7.1	Power rating and identification markings	See below.	P
1.7.1.1	Power rating marking	Not directly connected to the mains.	N/A
	Multiple mains supply connections.....:		N/A
	Rated voltage(s) or voltage range(s) (V)		N/A
	Symbol for nature of supply, for d.c. only		N/A
	Rated frequency or rated frequency range (Hz)		N/A
	Rated current (mA or A)		N/A
1.7.1.2	Identification markings		P
	Manufacturer's name or trade-mark or identification mark	See copy of marking plate.	P
	Model identification or type reference	See copy of marking plate.	P
	Symbol for Class II equipment only	Class III equipment.	N/A
	Other markings and symbols	Other markings and symbols do not give rise to misunderstanding.	P
1.7.1.3	Use of graphical symbols	Not used.	N/A
1.7.2	Safety instructions and marking	See below.	P
1.7.2.1	General	The user's manual contains information for operation, installation and technical.	P
1.7.2.2	Disconnect devices		N/A
1.7.2.3	Overcurrent protective device		N/A
1.7.2.4	IT power distribution systems		N/A
1.7.2.5	Operator access with a tool		N/A
1.7.2.6	Ozone		N/A
1.7.3	Short duty cycles		N/A
1.7.4	Supply voltage adjustment		N/A
	Methods and means of adjustment; reference to installation instructions		N/A

IEC 60950-1			
Clause	Requirement + Test	Result - Remark	Verdict
1.7.5	Power outlets on the equipment		N/A
1.7.6	Fuse identification (marking, special fusing characteristics, cross-reference)		N/A
1.7.7	Wiring terminals		N/A
1.7.7.1	Protective earthing and bonding terminals		N/A
1.7.7.2	Terminals for a.c. mains supply conductors		N/A
1.7.7.3	Terminals for d.c. mains supply conductors		N/A
1.7.8	Controls and indicators	See below.	P
1.7.8.1	Identification, location and marking	The function of indicators and controls is clearly identified.	P
1.7.8.2	Colours	Colors are used and safety is not involved.	N/A
1.7.8.3	Symbols according to IEC 60417.....		N/A
1.7.8.4	Markings using figures		N/A
1.7.9	Isolation of multiple power sources		N/A
1.7.10	Thermostats and other regulating devices		N/A
1.7.11	Durability	Marking is durable and legible.	P
1.7.12	Removable parts		N/A
1.7.13	Replaceable batteries	The required warning is in both the operation and service manuals.	P
	Language(s)	Only English language reviewed. May be provided in other languages upon request from the manufacturer.	—
1.7.14	Equipment for restricted access locations.....		N/A

2	PROTECTION FROM HAZARDS		P
2.1	Protection from electric shock and energy hazards		P
2.1.1	Protection in operator access areas	See below.	P
2.1.1.1	Access to energized parts	The equipment is for building-in. Compliance shall be investigated for final system.	N/A
	Test by inspection		N/A
	Test with test finger (Figure 2A)		N/A
	Test with test pin (Figure 2B)		N/A
	Test with test probe (Figure 2C)		N/A
2.1.1.2	Battery compartments		N/A

IEC 60950-1			
Clause	Requirement + Test	Result - Remark	Verdict
2.1.1.3	Access to ELV wiring		N/A
	Working voltage (V _{peak} or V _{rms}); minimum distance through insulation (mm)		—
2.1.1.4	Access to hazardous voltage circuit wiring		N/A
2.1.1.5	Energy hazards	No energy hazards at all user accessible part.	P
2.1.1.6	Manual controls		N/A
2.1.1.7	Discharge of capacitors in equipment		N/A
	Measured voltage (V); time-constant (s)		—
2.1.1.8	Energy hazards – d.c. mains supply		N/A
	a) Capacitor connected to the d.c. mains supply ..		N/A
	b) Internal battery connected to the d.c. mains supply :		N/A
2.1.1.9	Audio amplifiers		N/A
2.1.2	Protection in service access areas		N/A
2.1.3	Protection in restricted access locations		N/A

2.2	SELV circuits		P
2.2.1	General requirements	See below.	P
2.2.2	Voltages under normal conditions (V)	The equipment is supplied by SELV only and there's no voltage generate circuit within.	P
2.2.3	Voltages under fault conditions (V)		N/A
2.2.4	Connection of SELV circuits to other circuits	No direct connection between SELV and any primary circuits.	P

2.3	TNV circuits		N/A
2.3.1	Limits	No TNV circuits.	N/A
	Type of TNV circuits		—
2.3.2	Separation from other circuits and from accessible parts		N/A
2.3.2.1	General requirements		N/A
2.3.2.2	Protection by basic insulation		N/A
2.3.2.3	Protection by earthing		N/A
2.3.2.4	Protection by other constructions		N/A
2.3.3	Separation from hazardous voltages		N/A
	Insulation employed.....		—

IEC 60950-1			
Clause	Requirement + Test	Result - Remark	Verdict
2.3.4	Connection of TNV circuits to other circuits		N/A
	Insulation employed..... :		—
2.3.5	Test for operating voltages generated externally		N/A

2.4	Limited current circuits		N/A
2.4.1	General requirements		N/A
2.4.2	Limit values		N/A
	Frequency (Hz)..... :		—
	Measured current (mA)..... :		—
	Measured voltage (V) :		—
	Measured circuit capacitance (nF or μ F)..... :		—
2.4.3	Connection of limited current circuits to other circuits		N/A

2.5	Limited power sources		P
	a) Inherently limited output	Complied with table 2B.	P
	b) Impedance limited output	Complied with table 2B.	P
	c) Regulating network or IC current limiter, limits output under normal operating and single fault condition	Complied with table 2B.	P
	Use of integrated circuit (IC) current limiters	Protective device IC used., see appended table Critical Component List.	P
	d) Overcurrent protective device limited output		N/A
	Max. output voltage (V), max. output current (A), max. apparent power (VA)..... :	(see appended table 2.5)	—
	Current rating of overcurrent protective device (A) .. :		—

2.6	Provisions for earthing and bonding		N/A
2.6.1	Protective earthing	Class III equipment.	N/A
2.6.2	Functional earthing		N/A
	Use of symbol for functional earthing :		N/A
2.6.3	Protective earthing and protective bonding conductors		N/A
2.6.3.1	General		N/A
2.6.3.2	Size of protective earthing conductors		N/A

IEC 60950-1			
Clause	Requirement + Test	Result - Remark	Verdict
	Rated current (A), cross-sectional area (mm ²), AWG		—
2.6.3.3	Size of protective bonding conductors		N/A
	Rated current (A), cross-sectional area (mm ²), AWG		—
	Protective current rating (A), cross-sectional area (mm ²), AWG		—
2.6.3.4	Resistance of earthing conductors and their terminations; resistance (Ω), voltage drop (V), test current (A), duration (min)		N/A
2.6.3.5	Colour of insulation		N/A
2.6.4	Terminals		N/A
2.6.4.1	General		N/A
2.6.4.2	Protective earthing and bonding terminals		N/A
	Rated current (A), type, nominal thread diameter (mm)		—
2.6.4.3	Separation of the protective earthing conductor from protective bonding conductors		N/A
2.6.5	Integrity of protective earthing		N/A
2.6.5.1	Interconnection of equipment		N/A
2.6.5.2	Components in protective earthing conductors and protective bonding conductors		N/A
2.6.5.3	Disconnection of protective earth		N/A
2.6.5.4	Parts that can be removed by an operator		N/A
2.6.5.5	Parts removed during servicing		N/A
2.6.5.6	Corrosion resistance		N/A
2.6.5.7	Screws for protective bonding		N/A
2.6.5.8	Reliance on telecommunication network or cable distribution system		N/A

2.7	Overcurrent and earth fault protection in primary circuits		N/A
2.7.1	Basic requirements		N/A
	Instructions when protection relies on building installation		N/A
2.7.2	Faults not simulated in 5.3.7		N/A
2.7.3	Short-circuit backup protection		N/A
2.7.4	Number and location of protective devices		N/A
2.7.5	Protection by several devices		N/A

IEC 60950-1			
Clause	Requirement + Test	Result - Remark	Verdict
2.7.6	Warning to service personnel..... :		N/A

2.8	Safety interlocks		N/A
2.8.1	General principles	No safety interlocks.	N/A
2.8.2	Protection requirements		N/A
2.8.3	Inadvertent reactivation		N/A
2.8.4	Fail-safe operation		N/A
	Protection against extreme hazard		N/A
2.8.5	Moving parts		N/A
2.8.6	Overriding		N/A
2.8.7	Switches, relays and their related circuits		N/A
2.8.7.1	Separation distances for contact gaps and their related circuits (mm)		N/A
2.8.7.2	Overload test		N/A
2.8.7.3	Endurance test		N/A
2.8.7.4	Electric strength test		N/A
2.8.8	Mechanical actuators		N/A

2.9	Electrical insulation		P
2.9.1	Properties of insulating materials	Natural rubber, asbestos or hygroscopic materials are not used.	P
2.9.2	Humidity conditioning		N/A
	Relative humidity (%), temperature (°C)		—
2.9.3	Grade of insulation	Functional insulation requirement.	P
2.9.4	Separation from hazardous voltages		N/A
	Method(s) used		—

2.10	Clearances, creepage distances and distances through insulation		N/A
2.10.1	General		N/A
2.10.1.1	Frequency		N/A
2.10.1.2	Pollution degrees		N/A
2.10.1.3	Reduced values for functional insulation		N/A
2.10.1.4	Intervening unconnected conductive parts		N/A

IEC 60950-1			
Clause	Requirement + Test	Result - Remark	Verdict
2.10.1.5	Insulation with varying dimensions		N/A
2.10.1.6	Special separation requirements		N/A
2.10.1.7	Insulation in circuits generating starting pulses		N/A
2.10.2	Determination of working voltage		N/A
2.10.2.1	General		N/A
2.10.2.2	RMS working voltage		N/A
2.10.2.3	Peak working voltage		N/A
2.10.3	Clearances		N/A
2.10.3.1	General		N/A
2.10.3.2	Mains transient voltages		N/A
	a) AC mains supply		N/A
	b) Earthed d.c. mains supplies		N/A
	c) Unearthed d.c. mains supplies		N/A
	d) Battery operation		N/A
2.10.3.3	Clearances in primary circuits		N/A
2.10.3.4	Clearances in secondary circuits		N/A
2.10.3.5	Clearances in circuits having starting pulses		N/A
2.10.3.6	Transients from a.c. mains supply		N/A
2.10.3.7	Transients from d.c. mains supply		N/A
2.10.3.8	Transients from telecommunication networks and cable distribution systems		N/A
2.10.3.9	Measurement of transient voltage levels		N/A
	a) Transients from a mains supply		N/A
	For an a.c. mains supply		N/A
	For a d.c. mains supply		N/A
	b) Transients from a telecommunication network :		N/A
2.10.4	Creepage distances		N/A
2.10.4.1	General		N/A
2.10.4.2	Material group and comparative tracking index		N/A
	CTI tests		—
2.10.4.3	Minimum creepage distances		N/A
2.10.5	Solid insulation		N/A
2.10.5.1	General		N/A
2.10.5.2	Distances through insulation		N/A
2.10.5.3	Insulating compound as solid insulation		N/A

IEC 60950-1			
Clause	Requirement + Test	Result - Remark	Verdict
2.10.5.4	Semiconductor devices		N/A
2.10.5.5.	Cemented joints		N/A
2.10.5.6	Thin sheet material – General		N/A
2.10.5.7	Separable thin sheet material		N/A
	Number of layers (pcs)		—
2.10.5.8	Non-separable thin sheet material		N/A
2.10.5.9	Thin sheet material – standard test procedure		N/A
	Electric strength test		—
2.10.5.10	Thin sheet material – alternative test procedure		N/A
	Electric strength test		—
2.10.5.11	Insulation in wound components		N/A
2.10.5.12	Wire in wound components		N/A
	Working voltage		N/A
	a) Basic insulation not under stress		N/A
	b) Basic, supplementary, reinforced insulation		N/A
	c) Compliance with Annex U		N/A
	Two wires in contact inside wound component; angle between 45° and 90°		N/A
2.10.5.13	Wire with solvent-based enamel in wound components		N/A
	Electric strength test		—
	Routine test		N/A
2.10.5.14	Additional insulation in wound components		N/A
	Working voltage		N/A
	- Basic insulation not under stress		N/A
	- Supplementary, reinforced insulation		N/A
2.10.6	Construction of printed boards		N/A
2.10.6.1	Uncoated printed boards		N/A
2.10.6.2	Coated printed boards		N/A
2.10.6.3	Insulation between conductors on the same inner surface of a printed board		N/A
2.10.6.4	Insulation between conductors on different layers of a printed board		N/A
	Distance through insulation		N/A
	Number of insulation layers (pcs).....		N/A

IEC 60950-1			
Clause	Requirement + Test	Result - Remark	Verdict
2.10.7	Component external terminations		N/A
2.10.8	Tests on coated printed boards and coated components		N/A
2.10.8.1	Sample preparation and preliminary inspection		N/A
2.10.8.2	Thermal conditioning		N/A
2.10.8.3	Electric strength test		N/A
2.10.8.4	Abrasion resistance test		N/A
2.10.9	Thermal cycling		N/A
2.10.10	Test for Pollution Degree 1 environment and insulating compound		N/A
2.10.11	Tests for semiconductor devices and cemented joints		N/A
2.10.12	Enclosed and sealed parts		N/A

3	WIRING, CONNECTIONS AND SUPPLY		N/A
3.1	General		N/A
3.1.1	Current rating and overcurrent protection		N/A
3.1.2	Protection against mechanical damage		N/A
3.1.3	Securing of internal wiring		N/A
3.1.4	Insulation of conductors		N/A
3.1.5	Beads and ceramic insulators		N/A
3.1.6	Screws for electrical contact pressure		N/A
3.1.7	Insulating materials in electrical connections		N/A
3.1.8	Self-tapping and spaced thread screws		N/A
3.1.9	Termination of conductors		N/A
	10 N pull test		N/A
3.1.10	Sleeving on wiring		N/A

3.2	Connection to a mains supply		N/A
3.2.1	Means of connection		N/A
3.2.1.1	Connection to an a.c. mains supply		N/A
3.2.1.2	Connection to a d.c. mains supply		N/A
3.2.2	Multiple supply connections		N/A
3.2.3	Permanently connected equipment		N/A
	Number of conductors, diameter of cable and conduits (mm) :		—

IEC 60950-1			
Clause	Requirement + Test	Result - Remark	Verdict
3.2.4	Appliance inlets		N/A
3.2.5	Power supply cords		N/A
3.2.5.1	AC power supply cords		N/A
	Type		—
	Rated current (A), cross-sectional area (mm ²), AWG		—
3.2.5.2	DC power supply cords		N/A
3.2.6	Cord anchorages and strain relief		N/A
	Mass of equipment (kg), pull (N)		—
	Longitudinal displacement (mm)		—
3.2.7	Protection against mechanical damage		N/A
3.2.8	Cord guards		N/A
	Diameter or minor dimension D (mm); test mass (g)		—
	Radius of curvature of cord (mm).....		—
3.2.9	Supply wiring space		N/A

3.3	Wiring terminals for connection of external conductors		N/A
3.3.1	Wiring terminals		N/A
3.3.2	Connection of non-detachable power supply cords		N/A
3.3.3	Screw terminals		N/A
3.3.4	Conductor sizes to be connected		N/A
	Rated current (A), cord/cable type, cross-sectional area (mm ²).....		—
3.3.5	Wiring terminal sizes		N/A
	Rated current (A), type, nominal thread diameter (mm)		—
3.3.6	Wiring terminal design		N/A
3.3.7	Grouping of wiring terminals		N/A
3.3.8	Stranded wire		N/A

3.4	Disconnection from the mains supply		N/A
3.4.1	General requirement		N/A
3.4.2	Disconnect devices		N/A
3.4.3	Permanently connected equipment		N/A
3.4.4	Parts which remain energized		N/A

IEC 60950-1			
Clause	Requirement + Test	Result - Remark	Verdict
3.4.5	Switches in flexible cords		N/A
3.4.6	Number of poles - single-phase and d.c. equipment		N/A
3.4.7	Number of poles - three-phase equipment		N/A
3.4.8	Switches as disconnect devices		N/A
3.4.9	Plugs as disconnect devices		N/A
3.4.10	Interconnected equipment		N/A
3.4.11	Multiple power sources		N/A

3.5	Interconnection of equipment		N/A
3.5.1	General requirements		N/A
3.5.2	Types of interconnection circuits		N/A
3.5.3	ELV circuits as interconnection circuits		N/A
3.5.4	Data ports for additional equipment		N/A

4	PHYSICAL REQUIREMENTS		P
4.1	Stability		N/A
	Angle of 10°	Unit weight less than 7 kg, not subject to the test.	N/A
	Test force (N)		N/A

4.2	Mechanical strength		N/A
4.2.1	General	This equipment is for building-in, in compliance with the requirement shall be evaluated in final system.	N/A
	Rack-mounted equipment.		N/A
4.2.2	Steady force test, 10 N		N/A
4.2.3	Steady force test, 30 N		N/A
4.2.4	Steady force test, 250 N		N/A
4.2.5	Impact test		N/A
	Fall test		N/A
	Swing test		N/A
4.2.6	Drop test; height (mm)		N/A
4.2.7	Stress relief test		N/A
4.2.8	Cathode ray tubes		N/A
	Picture tube separately certified		N/A

IEC 60950-1			
Clause	Requirement + Test	Result - Remark	Verdict
4.2.9	High pressure lamps		N/A
4.2.10	Wall or ceiling mounted equipment; force (N)		N/A

4.3	Design and construction		P
4.3.1	Edges and corners	All edges and corners judged to be sufficiently well rounded so as not to constitute a hazard.	P
4.3.2	Handles and manual controls; force (N)..... :		N/A
4.3.3	Adjustable controls		N/A
4.3.4	Securing of parts	Mechanical fixings in such a way designed that they will withstand mechanical stress occurring in normal use.	P
4.3.5	Connection by plugs and sockets	No mismatch of connectors, plugs or sockets possible.	N/A
4.3.6	Direct plug-in equipment		N/A
	Torque		—
	Compliance with the relevant mains plug standard		N/A
4.3.7	Heating elements in earthed equipment		N/A
4.3.8	Batteries		N/A
	- Overcharging of a rechargeable battery		N/A
	- Unintentional charging of a non-rechargeable battery		N/A
	- Reverse charging of a rechargeable battery		N/A
	- Excessive discharging rate for any battery		N/A
4.3.9	Oil and grease		N/A
4.3.10	Dust, powders, liquids and gases		N/A
4.3.11	Containers for liquids or gases		N/A
4.3.12	Flammable liquids		N/A
	Quantity of liquid (l)		N/A
	Flash point (°C)		N/A
4.3.13	Radiation		P
4.3.13.1	General	See below.	P
4.3.13.2	Ionizing radiation		N/A
	Measured radiation (pA/kg)		—

IEC 60950-1			
Clause	Requirement + Test	Result - Remark	Verdict
	Measured high-voltage (kV)		—
	Measured focus voltage (kV)		—
	CRT markings		—
4.3.13.3	Effect of ultraviolet (UV) radiation on materials		N/A
	Part, property, retention after test, flammability classification		N/A
4.3.13.4	Human exposure to ultraviolet (UV) radiation		N/A
4.3.13.5	Lasers (including laser diodes) and LEDs	See below.	P
4.3.13.5.1	Lasers (including laser diodes)		N/A
	Laser class		—
4.3.13.5.2	Light emitting diodes (LEDs)	This product contains only visible indicator LEDs. No IEC 62471 evaluation was deemed necessary.	P
4.3.13.6	Other types		N/A

4.4	Protection against hazardous moving parts		N/A
4.4.1	General	No such part.	N/A
4.4.2	Protection in operator access areas		N/A
	Household and home/office document/media shredders		N/A
4.4.3	Protection in restricted access locations		N/A
4.4.4	Protection in service access areas		N/A
4.4.5	Protection against moving fan blades		N/A
4.4.5.1	General		N/A
	Not considered to cause pain or injury. a).....		N/A
	Is considered to cause pain, not injury. b)		N/A
	Considered to cause injury. c)		N/A
4.4.5.2	Protection for users		N/A
	Use of symbol or warning		N/A
4.4.5.3	Protection for service persons		N/A
	Use of symbol or warning		N/A

4.5	Thermal requirements		P
4.5.1	General	No exceeding temperature.	P
4.5.2	Temperature tests	(see appended table 4.5)	P

IEC 60950-1			
Clause	Requirement + Test	Result - Remark	Verdict
	Normal load condition per Annex L	(See Annex L)	—
4.5.3	Temperature limits for materials	(see appended table 4.5)	P
4.5.4	Touch temperature limits	(see appended table 4.5)	P
4.5.5	Resistance to abnormal heat	No such part.	N/A

4.6	Openings in enclosures		N/A
4.6.1	Top and side openings	This equipment is for buildingin, in compliance with the requirement shall be evaluated in final system.	N/A
	Dimensions (mm)		—
4.6.2	Bottoms of fire enclosures	This equipment is for buildingin, in compliance with the requirement shall be evaluated in final system.	N/A
	Construction of the bottomm, dimensions (mm) .. :		—
4.6.3	Doors or covers in fire enclosures		N/A
4.6.4	Openings in transportable equipment		N/A
4.6.4.1	Constructional design measures		N/A
	Dimensions (mm)		—
4.6.4.2	Evaluation measures for larger openings		N/A
4.6.4.3	Use of metallized parts		N/A
4.6.5	Adhesives for constructional purposes		N/A
	Conditioning temperature (°C), time (weeks)		—

4.7	Resistance to fire		P
4.7.1	Reducing the risk of ignition and spread of flame	See below.	P
	Method 1, selection and application of components wiring and materials	(see appended table 4.7)	P
	Method 2, application of all of simulated fault condition tests		N/A
4.7.2	Conditions for a fire enclosure	See below.	P
4.7.2.1	Parts requiring a fire enclosure	See clause 4.7.2.2.	N/A

IEC 60950-1			
Clause	Requirement + Test	Result - Remark	Verdict
4.7.2.2	Parts not requiring a fire enclosure	With having the following parts : - The EUT is supplied by limited power sources and components are mounted on PWB of flammability Class V-1. The fire enclosure is not required.	P
4.7.3	Materials		P
4.7.3.1	General	PCB rated V-1 or better.	P
4.7.3.2	Materials for fire enclosures	See appended table 1.5.1.	N/A
4.7.3.3	Materials for components and other parts outside fire enclosures		N/A
4.7.3.4	Materials for components and other parts inside fire enclosures	Internal components except small parts are V-2 or better.	N/A
4.7.3.5	Materials for air filter assemblies		N/A
4.7.3.6	Materials used in high-voltage components		N/A

5	ELECTRICAL REQUIREMENTS AND SIMULATED ABNORMAL CONDITIONS		P
5.1	Touch current and protective conductor current		N/A
5.1.1	General		N/A
5.1.2	Configuration of equipment under test (EUT)		N/A
5.1.2.1	Single connection to an a.c. mains supply		N/A
5.1.2.2	Redundant multiple connections to an a.c. mains supply		N/A
5.1.2.3	Simultaneous multiple connections to an a.c. mains supply		N/A
5.1.3	Test circuit		N/A
5.1.4	Application of measuring instrument		N/A
5.1.5	Test procedure		N/A
5.1.6	Test measurements		N/A
	Supply voltage (V)		—
	Measured touch current (mA)		—
	Max. allowed touch current (mA)		—
	Measured protective conductor current (mA)		—
	Max. allowed protective conductor current (mA)....		—
5.1.7	Equipment with touch current exceeding 3,5 mA		N/A
5.1.7.1	General		N/A

IEC 60950-1			
Clause	Requirement + Test	Result - Remark	Verdict
5.1.7.2	Simultaneous multiple connections to the supply		N/A
5.1.8	Touch currents to telecommunication networks and cable distribution systems and from telecommunication networks		N/A
5.1.8.1	Limitation of the touch current to a telecommunication network or to a cable distribution system		N/A
	Supply voltage (V)		—
	Measured touch current (mA)		—
	Max. allowed touch current (mA)		—
5.1.8.2	Summation of touch currents from telecommunication networks		N/A
	a) EUT with earthed telecommunication ports		N/A
	b) EUT whose telecommunication ports have no reference to protective earth		N/A

5.2	Electric strength		N/A
5.2.1	General		N/A
5.2.2	Test procedure		N/A

5.3	Abnormal operating and fault conditions		P
5.3.1	Protection against overload and abnormal operation	No test had been performed due to no risk of electric shock and fire no fire hazards foreseeable for this Class III equipment.	N/A
5.3.2	Motors		N/A
5.3.3	Transformers		N/A
5.3.4	Functional insulation.....	Method c) considered. The test did not conduct due to there's no electric shock and components are mounted on PCB rated V-1 or better.	P
5.3.5	Electromechanical components		N/A
5.3.6	Audio amplifiers in ITE		N/A
5.3.7	Simulation of faults		N/A
5.3.8	Unattended equipment		N/A
5.3.9	Compliance criteria for abnormal operating and fault conditions		N/A

IEC 60950-1			
Clause	Requirement + Test	Result - Remark	Verdict
5.3.9.1	During the tests		N/A
5.3.9.2	After the tests		N/A

6	CONNECTION TO TELECOMMUNICATION NETWORKS		N/A
6.1	Protection of telecommunication network service persons, and users of other equipment connected to the network, from hazards in the equipment		N/A
6.1.1	Protection from hazardous voltages		N/A
6.1.2	Separation of the telecommunication network from earth		N/A
6.1.2.1	Requirements		N/A
	Supply voltage (V)		—
	Current in the test circuit (mA)		—
6.1.2.2	Exclusions		N/A

6.2	Protection of equipment users from overvoltages on telecommunication networks		N/A
6.2.1	Separation requirements		N/A
6.2.2	Electric strength test procedure		N/A
6.2.2.1	Impulse test		N/A
6.2.2.2	Steady-state test		N/A
6.2.2.3	Compliance criteria		N/A

6.3	Protection of the telecommunication wiring system from overheating		N/A
	Max. output current (A)		—
	Current limiting method		—

7	CONNECTION TO CABLE DISTRIBUTION SYSTEMS		N/A
7.1	General		N/A
7.2	Protection of cable distribution system service persons, and users of other equipment connected to the system, from hazardous voltages in the equipment		N/A
7.3	Protection of equipment users from overvoltages on the cable distribution system		N/A
7.4	Insulation between primary circuits and cable distribution systems		N/A
7.4.1	General		N/A
7.4.2	Voltage surge test		N/A

IEC 60950-1			
Clause	Requirement + Test	Result - Remark	Verdict
7.4.3	Impulse test		N/A
A	ANNEX A, TESTS FOR RESISTANCE TO HEAT AND FIRE		N/A
A.1	Flammability test for fire enclosures of movable equipment having a total mass exceeding 18 kg, and of stationary equipment (see 4.7.3.2)		N/A
A.1.1	Samples.....:		—
	Wall thickness (mm).....:		—
A.1.2	Conditioning of samples; temperature (°C).....:		N/A
A.1.3	Mounting of samples.....:		N/A
A.1.4	Test flame (see IEC 60695-11-3)		N/A
	Flame A, B, C or D.....:		—
A.1.5	Test procedure		N/A
A.1.6	Compliance criteria		N/A
	Sample 1 burning time (s).....:		—
	Sample 2 burning time (s).....:		—
	Sample 3 burning time (s).....:		—
A.2	Flammability test for fire enclosures of movable equipment having a total mass not exceeding 18 kg, and for material and components located inside fire enclosures (see 4.7.3.2 and 4.7.3.4)		N/A
A.2.1	Samples, material.....:		—
	Wall thickness (mm).....:		—
A.2.2	Conditioning of samples; temperature (°C).....:		N/A
A.2.3	Mounting of samples.....:		N/A
A.2.4	Test flame (see IEC 60695-11-4)		N/A
	Flame A, B or C.....:		—
A.2.5	Test procedure		N/A
A.2.6	Compliance criteria		N/A
	Sample 1 burning time (s).....:		—
	Sample 2 burning time (s).....:		—
	Sample 3 burning time (s).....:		—
A.2.7	Alternative test acc. to IEC 60695-11-5, cl. 5 and 9		N/A
	Sample 1 burning time (s).....:		—
	Sample 2 burning time (s).....:		—
	Sample 3 burning time (s).....:		—

IEC 60950-1			
Clause	Requirement + Test	Result - Remark	Verdict
A.3	Hot flaming oil test (see 4.6.2)		N/A
A.3.1	Mounting of samples		N/A
A.3.2	Test procedure		N/A
A.3.3	Compliance criterion		N/A

B	ANNEX B, MOTOR TESTS UNDER ABNORMAL CONDITIONS (see 4.7.2.2 and 5.3.2)		N/A
B.1	General requirements		N/A
	Position		—
	Manufacturer		—
	Type		—
	Rated values		—
B.2	Test conditions		N/A
B.3	Maximum temperatures		N/A
B.4	Running overload test		N/A
B.5	Locked-rotor overload test		N/A
	Test duration (days)		—
	Electric strength test: test voltage (V)		—
B.6	Running overload test for d.c. motors in secondary circuits		N/A
B.6.1	General		N/A
B.6.2	Test procedure		N/A
B.6.3	Alternative test procedure		N/A
B.6.4	Electric strength test; test voltage (V)		N/A
B.7	Locked-rotor overload test for d.c. motors in secondary circuits		N/A
B.7.1	General		N/A
B.7.2	Test procedure		N/A
B.7.3	Alternative test procedure		N/A
B.7.4	Electric strength test; test voltage (V)		N/A
B.8	Test for motors with capacitors		N/A
B.9	Test for three-phase motors		N/A
B.10	Test for series motors		N/A
	Operating voltage (V)		—

IEC 60950-1			
Clause	Requirement + Test	Result - Remark	Verdict
C	ANNEX C, TRANSFORMERS (see 1.5.4 and 5.3.3)		N/A
	Position		—
	Manufacturer		—
	Type		—
	Rated values		—
	Method of protection..... :		—
C.1	Overload test		N/A
C.2	Insulation		N/A
	Protection from displacement of windings..... :		N/A
D	ANNEX D, MEASURING INSTRUMENTS FOR TOUCH-CURRENT TESTS (see 5.1.4)		N/A
D.1	Measuring instrument		N/A
D.2	Alternative measuring instrument		N/A
E	ANNEX E, TEMPERATURE RISE OF A WINDING (see 1.4.13)		N/A
F	ANNEX F, MEASUREMENT OF CLEARANCES AND CREEPAGE DISTANCES (see 2.10 and Annex G)		N/A
G	ANNEX G, ALTERNATIVE METHOD FOR DETERMINING MINIMUM CLEARANCES		N/A
G.1	Clearances		N/A
G.1.1	General		N/A
G.1.2	Summary of the procedure for determining minimum clearances		N/A
G.2	Determination of mains transient voltage (V)		N/A
G.2.1	AC mains supply		N/A
G.2.2	Earthed d.c. mains supplies		N/A
G.2.3	Unearthed d.c. mains supplies		N/A
G.2.4	Battery operation		N/A
G.3	Determination of telecommunication network transient voltage (V) :		N/A
G.4	Determination of required withstand voltage (V)		N/A
G.4.1	Mains transients and internal repetitive peaks		N/A
G.4.2	Transients from telecommunication networks		N/A

IEC 60950-1			
Clause	Requirement + Test	Result - Remark	Verdict
G.4.3	Combination of transients		N/A
G.4.4	Transients from cable distribution systems		N/A
G.5	Measurement of transient voltages (V)		N/A
	a) Transients from a mains supply		N/A
	For an a.c. mains supply		N/A
	For a d.c. mains supply		N/A
	b) Transients from a telecommunication network		N/A
G.6	Determination of minimum clearances :		N/A
H	ANNEX H, IONIZING RADIATION (see 4.3.13)		N/A
J	ANNEX J, TABLE OF ELECTROCHEMICAL POTENTIALS (see 2.6.5.6)		N/A
	Metal(s) used		—
K	ANNEX K, THERMAL CONTROLS (see 1.5.3 and 5.3.8)		N/A
K.1	Making and breaking capacity		N/A
K.2	Thermostat reliability; operating voltage (V)		N/A
K.3	Thermostat endurance test; operating voltage (V)		N/A
K.4	Temperature limiter endurance; operating voltage (V)		N/A
K.5	Thermal cut-out reliability		N/A
K.6	Stability of operation		N/A
L	ANNEX L, NORMAL LOAD CONDITIONS FOR SOME TYPES OF ELECTRICAL BUSINESS EQUIPMENT (see 1.2.2.1 and 4.5.2)		P
L.1	Typewriters		N/A
L.2	Adding machines and cash registers		N/A
L.3	Erasers		N/A
L.4	Pencil sharpeners		N/A
L.5	Duplicators and copy machines		N/A
L.6	Motor-operated files		N/A
L.7	Other business equipment	See summary of testing.	P
M	ANNEX M, CRITERIA FOR TELEPHONE RINGING SIGNALS (see 2.3.1)		N/A

IEC 60950-1			
Clause	Requirement + Test	Result - Remark	Verdict
M.1	Introduction		N/A
M.2	Method A		N/A
M.3	Method B		N/A
M.3.1	Ringing signal		N/A
M.3.1.1	Frequency (Hz)		—
M.3.1.2	Voltage (V)		—
M.3.1.3	Cadence; time (s), voltage (V)		—
M.3.1.4	Single fault current (mA)		—
M.3.2	Tripping device and monitoring voltage		N/A
M.3.2.1	Conditions for use of a tripping device or a monitoring voltage		N/A
M.3.2.2	Tripping device		N/A
M.3.2.3	Monitoring voltage (V)		N/A
N	ANNEX N, IMPULSE TEST GENERATORS (see 1.5.7.2, 1.5.7.3, 2.10.3.9, 6.2.2.1, 7.3.2, 7.4.3 and Clause G.5)		N/A
N.1	ITU-T impulse test generators		N/A
N.2	IEC 60065 impulse test generator		N/A
P	ANNEX P, NORMATIVE REFERENCES		—
Q	ANNEX Q, Voltage dependent resistors (VDRs) (see 1.5.9.1)		N/A
	- Preferred climatic categories		N/A
	- Maximum continuous voltage		N/A
	- Combination pulse current		N/A
	Body of the VDR Test according to IEC60695-11-5.....		N/A
	Body of the VDR. Flammability class of material (min V-1).....		N/A
R	ANNEX R, EXAMPLES OF REQUIREMENTS FOR QUALITY CONTROL PROGRAMMES		N/A
R.1	Minimum separation distances for unpopulated coated printed boards (see 2.10.6.2)		N/A
R.2	Reduced clearances (see 2.10.3)		N/A

IEC 60950-1			
Clause	Requirement + Test	Result - Remark	Verdict
S	ANNEX S, PROCEDURE FOR IMPULSE TESTING (see 6.2.2.3)		N/A
S.1	Test equipment		N/A
S.2	Test procedure		N/A
S.3	Examples of waveforms during impulse testing		N/A
T	ANNEX T, GUIDANCE ON PROTECTION AGAINST INGRESS OF WATER (see 1.1.2)		N/A
			—
U	ANNEX U, INSULATED WINDING WIRES FOR USE WITHOUT INTERLEAVED INSULATION (see 2.10.5.4)		N/A
			—
V	ANNEX V, AC POWER DISTRIBUTION SYSTEMS (see 1.6.1)		N/A
V.1	Introduction		N/A
V.2	TN power distribution systems		N/A
W	ANNEX W, SUMMATION OF TOUCH CURRENTS		N/A
W.1	Touch current from electronic circuits		N/A
W.1.1	Floating circuits		N/A
W.1.2	Earthed circuits		N/A
W.2	Interconnection of several equipments		N/A
W.2.1	Isolation		N/A
W.2.2	Common return, isolated from earth		N/A
W.2.3	Common return, connected to protective earth		N/A
X	ANNEX X, MAXIMUM HEATING EFFECT IN TRANSFORMER TESTS (see clause C.1)		N/A
X.1	Determination of maximum input current		N/A
X.2	Overload test procedure		N/A
Y	ANNEX Y, ULTRAVIOLET LIGHT CONDITIONING TEST (see 4.3.13.3)		N/A
Y.1	Test apparatus		N/A
Y.2	Mounting of test samples		N/A
Y.3	Carbon-arc light-exposure apparatus		N/A

IEC 60950-1			
Clause	Requirement + Test	Result - Remark	Verdict
Y.4	Xenon-arc light exposure apparatus		N/A
Z	ANNEX Z, OVERVOLTAGE CATEGORIES (see 2.10.3.2 and Clause G.2)		N/A
AA	ANNEX AA, MANDREL TEST (see 2.10.5.8)		N/A
BB	ANNEX BB, CHANGES IN THE SECOND EDITION		—
CC	ANNEX CC, Evaluation of integrated circuit (IC) current limiters		P
CC.1	General	Protective device IC used, see appended table Critical Component List.	P
CC.2	Test program 1.....		N/A
CC.3	Test program 2.....	Applied.	P
CC.4	Test program 3.....		N/A
CC.5	Compliance.....	Considered.	P
DD	ANNEX DD, Requirements for the mounting means of rack-mounted equipment		N/A
DD.1	General		N/A
DD.2	Mechanical strength test, variable N.....		N/A
DD.3	Mechanical strength test, 250N, including end stops.....		N/A
DD.4	Compliance.....		N/A
EE	ANNEX EE, Household and home/office document/media shredders		N/A
EE.1	General		N/A
EE.2	Markings and instructions		N/A
	Use of markings or symbols.....		N/A
	Information of user instructions, maintenance and/or servicing instructions.....		N/A
EE.3	Inadvertent reactivation test.....		N/A
EE.4	Disconnection of power to hazardous moving parts:		N/A
	Use of markings or symbols.....		N/A
EE.5	Protection against hazardous moving parts		N/A
	Test with test finger (Figure 2A)		N/A
	Test with wedge probe (Figure EE1 and EE2)		N/A

IEC 60950-1					
Clause	Requirement + Test			Result - Remark	Verdict
1.5.1	TABLE: List of critical components				P
Object/part No.	Manufacturer/ trademark	Type/model	Technical data	Standard (Edition / year)	Mark(s) of conformity ¹
Power Adaptor	Powertron Electronics Corp.	PA1024- 050IB400	I/P: 100-240V~ 0.6A, 50-60Hz O/P: 5.0Vdc, 4.0A Class II, 40°C	EN 60950-1: 2006+A11+A1 +A12+A2, IEC 60950-1: 2005+A1, UL 60950-1	TÜV GS (S 50329206), CB (JPTUV- 068323-M1) UL (E248122)
PCB material	Interchangeable	Interchangeable	V-1 or better , 105°C min.	UL 796	UL
PTC (F1) (HDMI port protector)	Polytronics Technology Corp.	SMD0603P020 TF	PTC type, Vmax=6Vdc, Ih=0.5A, It=1.0A	IEC/EN 60730- 1: 2000 Tested to clauses 15, 17, J15 and J17, UL 1434	TÜV (R 50099121), UL (E)
Protection IC (U32) (USB 3.0 port protector)	Richtek Technology Corp.	RT9742CGJ5	Volts : 2.7- 6.0Vdc, Cont. Current: 1.5A, Prot. Current: 3.0A	IEC 60950-1: 2005+A1+A2, UL 2367	CB (NO87949), UL (E219878)
RTC battery (CN1)	Shun Wo New Power Battery Technology Ltd. (Newsun)	CR2032	Max. abnormal charging current 10mA	UL 1642	UL (MH25881)
	Panasonic Corporation,	CR2032	Max. abnormal charging current 10mA	UL 1642	UL (MH12210)
	Sony Energy Devices Corp.	CR2032	Max. abnormal charging current 10mA	UL 1642	UL (MH12566)
	Mitsubishi Electric Corp.	CR2032	Max. abnormal charging current 10mA	UL 1642	UL (MH15370)
	Mitsubishi Electric Home Appliance Co Ltd.	CR2032, CR2032E, CR2032E+, CR2032N	Max. abnormal charging current 10mA	UL 1642	UL (MH21249)
	VIC-DAWN Enterprise Co., Ltd. (KTS)	CR2032	Max. abnormal charging current 10mA	UL 1642	UL (MH20550)

IEC 60950-1					
Clause	Requirement + Test			Result - Remark	Verdict
	Hitachi Maxell Ltd.	CR2032, CR2032H, CR2032HA	Max. abnormal charging current 10mA	UL 1642	UL (MH12568)
	Toshiba Home Appliances Corp.	CR2032	Max. abnormal charging current 10mA	UL 1642	UL (MH12828)
	Double Best Co., Ltd.	CR2032	Max. abnormal charging current 10mA	UL 1642	UL (MH46388)
	Spectrum Brands Inc.	CR2032	Max. abnormal charging current 5mA	UL 1642	UL (MH12542)
	FDK Corp.	CR2032, CR2032s, CR2032T, CR2032U, CR-2032U, CR2032v	Max. abnormal charging current 5mA	UL 1642	UL (MH13421)
Supplementary information:					
1) Provided evidence ensures the agreed level of compliance. See OD-CB2039.					

1.5.1	TABLE: Opto Electronic Devices	N/A
Manufacturer : Type..... : Separately tested..... : Bridging insulation : External creepage distance : Internal creepage distance : Distance through insulation : Tested under the following conditions : Input..... : Output..... : supplementary information		

1.6.2	TABLE: Electrical data (in normal conditions)	P
--------------	--	---

IEC 60950-1							
Clause	Requirement + Test					Result - Remark	Verdict
U (V)	I (A)	I _{rated} (A)	P (W)	Fuse #	I _{fuse} (A)	Condition/status	
DC 5	1.70	4.0	8.5	--	--	Maximum normal load.	
Supplementary information:							

2.1.1.5 c) 1)	TABLE: max. V, A, VA test					N/A
Voltage (rated) (V)	Current (rated) (A)	Voltage (max.) (V)	Current (max.) (A)	VA (max.) (VA)		
supplementary information:						

2.1.1.5 c) 2)	TABLE: stored energy			N/A
Capacitance C (μF)	Voltage U (V)		Energy E (J)	
supplementary information:				

2.2	TABLE: evaluation of voltage limiting components in SELV circuits			N/A
Component (measured between)	max. voltage (V) (normal operation)		Voltage Limiting Components	
	V peak	V d.c.		
Fault test performed on voltage limiting components	Voltage measured (V) in SELV circuits (V peak or V d.c.)			
supplementary information:				

IEC 60950-1						
Clause	Requirement + Test	Result - Remark			Verdict	
2.5	TABLE: Limited power sources					P
Circuit output tested: See below.						
Note: Measured Uoc (V) with all load circuits disconnected: See below.						
Components	Test condition (Single fault)	Uoc (V)	I _{sc} (A)		VA	
			Meas.	Limit	Meas.	Limit
USB 3.0 port (CN35), pin 1 to GND. (Protection by U32)	Normal	5.038	2.64	8	10.91	100
USB port (CN35), other pins to GND.	Normal	0	0	8	0	100
HDMI port (CN11), pin 15 to GND.	Normal	4.896	0	8	0	100
HDMI port (CN11), pin 16 to GND.	Normal	4.893	0	8	0	100
HDMI port (CN11), pin 18 to GND. (Protection by F1)	Normal	4.991	2.00	8	7.14	100
HDMI port (CN11), other pins to GND.	Normal	0	0	8	0	100
RJ45 port (LAN1), all pins to GND.	Normal condition	0	0	≤8	0	≤100
RS232 port (COM2), all pins to GND.	Normal	0	0	8	0	100
supplementary information:						
Sc=Short circuit, Oc=Open circuit						

2.10.2	Table: working voltage measurement	N/A
---------------	---	-----

IEC 60950-1			
Clause	Requirement + Test	Result - Remark	Verdict
Location	RMS voltage (V)	Peak voltage (V)	Comments
supplementary information:			

2.10.3 and 2.10.4	TABLE: Clearance and creepage distance measurements						N/A
Clearance (cl) and creepage distance (cr) at/of/between:	U peak (V)	U r.m.s. (V)	Required cl (mm)	cl (mm)	Required cr (mm)	cr (mm)	
Functional:							
Reinforced:							
Supplementary information:							

2.10.5	TABLE: Distance through insulation measurements					N/A
Distance through insulation (DTI) at/of:	U peak (V)	U rms (V)	Test voltage (V)	Required DTI (mm)	DTI (mm)	
Supplementary information:						

4.3.8	TABLE: Batteries		P
The tests of 4.3.8 are applicable only when appropriate battery data is not available			P
Is it possible to install the battery in a reverse polarity position?	Not possible.		N/A
	Non-rechargeable batteries	Rechargeable batteries	

IEC 60950-1									
Clause	Requirement + Test						Result - Remark		Verdict
	Discharging		Un-intentional charging	Charging		Discharging		Reversed charging	
	Meas. current	Manuf. Specs.		Meas. current	Manuf. Specs.	Meas. current	Manuf. Specs.	Meas. current	Manuf. Specs.
Max. current during normal condition	--	--	1)	--	--	--	--	--	--
Max. current during fault condition	--	--	1)	--	--	--	--	--	--
Test results:									
- Chemical leaks									P
- Explosion of the battery									P
- Emission of flame or expulsion of molten metal									P
- Electric strength tests of equipment after completion of tests									N/A
Supplementary information:									

4.3.8	TABLE: Batteries	N/A
Battery category : Lithium		
Manufacturer : See appended table 1.5.1.		
Type / model..... : See appended table 1.5.1.		
Voltage : See appended table 1.5.1.		
Capacity..... : See appended table 1.5.1.		
Tested and Certified by (incl. Ref. No.) : See appended table 1.5.1.		
Circuit protection diagram:		

IEC 60950-1			
Clause	Requirement + Test	Result - Remark	Verdict

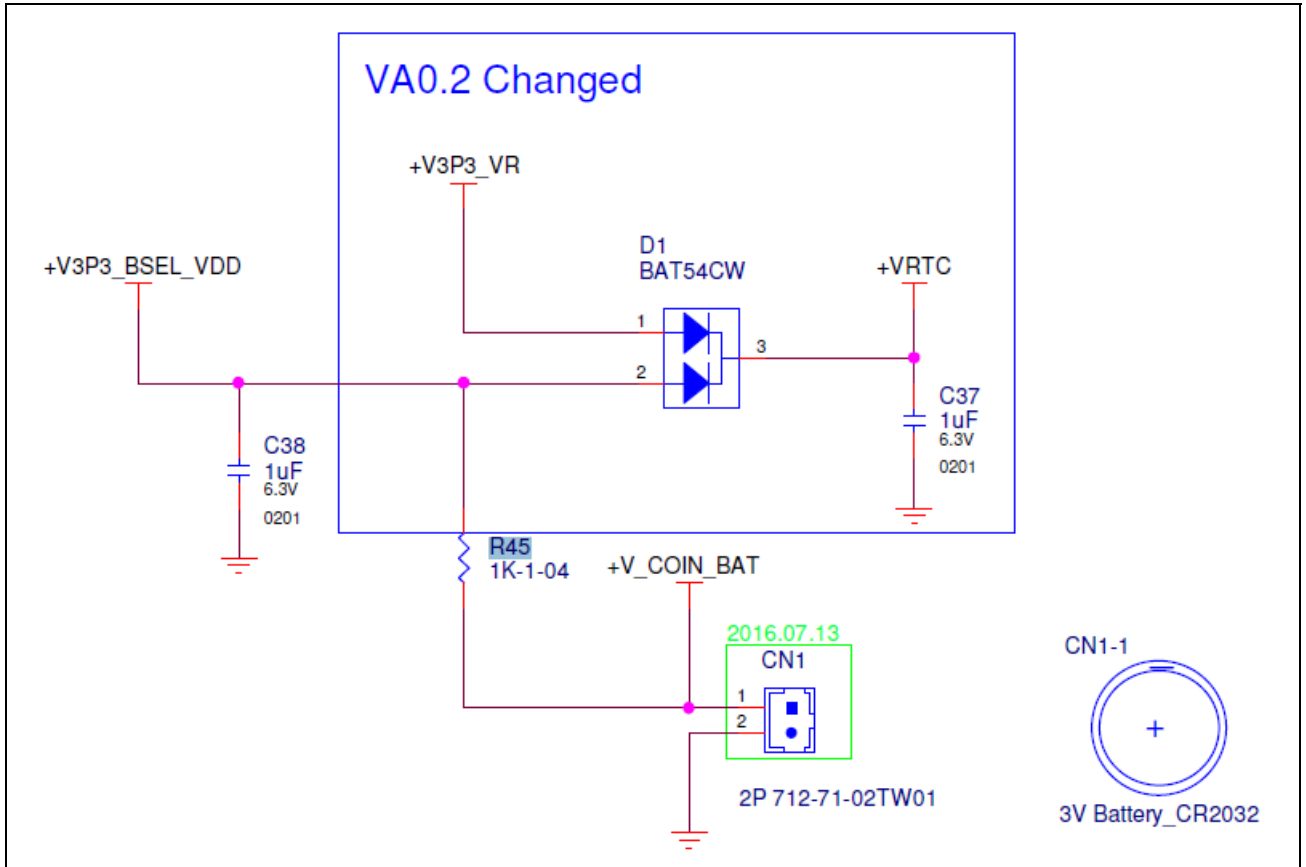

MARKINGS AND INSTRUCTIONS (1.7.13)	
Location of replaceable battery	CN1 (connected to main board through by cable.)
Language(s)	English.
Close to the battery	N/A
In the servicing instructions	Complied.
In the operating instructions	Complied.

4.5	TABLE: Thermal requirements	P
	Supply voltage (V)	DC 5
	Ambient T_{min} (°C)	--
	Ambient T_{max} (°C)	See below
	Maximum measured temperature T of part/at.....:	T (°C)
	Main board PCB near U1	69.2
		Allowed T_{max} (°C)
		105

IEC 60950-1			
Clause	Requirement + Test	Result - Remark	Verdict
	Main board PCB near U98	67.5	105
	Main board PCB near U19	71.4	105
	RTC battery	64.7	--
	Tma	45.0	--
	Tamb	21.5	--

Supplementary information:

- 1) The temperatures were measured under worst case normal mode defined in 1.2.2.1 and as described in sub-clause 1.6.2 and at voltages as described above.
- 2) With a maximum ambient temperature of +45°C as declared by the manufacturer.
- 3) All values for T (°C) are re-calculated from actual ambient.

Temperature T of winding:	t ₁ (°C)	R ₁ (Ω)	t ₂ (°C)	R ₂ (Ω)	T (°C)	Allowed T _{max} (°C)	Insulation class

Supplementary information:

4.5.5	TABLE: Ball pressure test of thermoplastic parts			N/A
	Allowed impression diameter (mm)	≤ 2 mm		—
Part	Test temperature (°C)		Impression diameter (mm)	

Supplementary information:

4.7	TABLE: Resistance to fire					P
Part	Manufacturer of material	Type of material	Thickness (mm)	Flammability class	Evidence	
PCB	--	--	--	V-1	--	

Supplementary information:
1) See appended table 1.5.1

5.1	TABLE: touch current measurement			N/A
Measured between:	Measured (mA)	Limit (mA)	Comments/conditions	

supplementary information:

IEC 60950-1			
Clause	Requirement + Test	Result - Remark	Verdict

5.2	TABLE: Electric strength tests, impulse tests and voltage surge tests			N/A
Test voltage applied between:	Voltage shape (AC, DC, impulse, surge)	Test voltage (V)	Breakdown Yes / No	
Supplementary information:				

5.3	TABLE: Fault condition tests					N/A
Ambient temperature (°C)	25, if not specified.					—
Power source for EUT: Manufacturer, model/type, output rating	(see appended table 1.5.1)					—
Component No.	Fault	Supply voltage (V)	Test time	Fuse #	Fuse current (A)	Observation
Supplementary information:						

C.2	TABLE: transformers							N/A
Loc.	Tested insulation	Working voltage peak / V (2.10.2)	Working voltage rms / V (2.10.2)	Required electric strength (5.2)	Required clearance / mm (2.10.3)	Required creepage distance / mm (2.10.4)	Required distance thr. insul. (2.10.5)	
Loc.	Tested insulation			Test voltage / V	Measured clearance / mm	Measured creepage dist. / mm	Measured distance thr. insul. / mm; number of layers	
supplementary information:								

C.2	TABLE: transformers							N/A
-----	---------------------	--	--	--	--	--	--	-----

IEC 60950-1			
Clause	Requirement + Test	Result - Remark	Verdict

IEC 60950-1			
Clause	Requirement + Test	Result - Remark	Verdict

List of test equipment used:

	ID Number	Manufacture	Description	Model No.	Specification
X	CR08	YOKOGAWA	Mobile Recorder	MV230-1-2-1-1D	K Type, -40 to 1000°C
X	CR13	Lascar	Temperature & Humidity Data Logger	EL-GFX-2	a) 10°C-40°C ; b) 30%-90% RH
X	VM02	FLUKE	Digital Multimeter	15B	a) 0-1000V, 0-10A ; b) 40MΩ
X	WT02	Strain Gauge	Electronic scale	HCK-17	0.2g-1200g

ATTACHMENT 1

IEC 60950-1			
Clause	Requirement + Test	Result - Remark	Verdict

2.1.1.7	TABLE : discharge test			N/A
Location	τ calculated (S)	τ measured (S)	$t_{u \rightarrow 0V}$ (S)	Comments
Supplementary information :				

2.4.2	TABLE : limited current circuit measurement				N/A
Location	Voltage (V)	Current (mA)	Freq. (Hz)	Limit (mA)	Comments
Supplementary information :					

2.6.3.4	TABLE : ground continue test			N/A
Location	Resistant measured (m Ω)	Voltage drop (V)	Comments	
Supplementary information :				

4.6.1 & 4.6.2	Ventilation opening		N/A
Location	Dimensions (mm)	Remark	
Supplementary information :			

ATTACHMENT 2

IEC60950_1F - ATTACHMENT			
Clause	Requirement + Test	Result - Remark	Verdict

<p>ATTACHMENT TO TEST REPORT IEC 60950-1 EUROPEAN GROUP DIFFERENCES AND NATIONAL DIFFERENCES Information technology equipment – Safety – Part 1: General requirements</p>	
Differences according to.....:	EN 60950-1:2006/A11:2009/A1:2010/A12:2011/A2:2013
Attachment Form No.....:	EU_GD_IEC60950_1F
Attachment Originator	SGS Fimko Ltd
Master Attachment	Date 2014-02
<p>Copyright © 2014 IEC System for Conformity Testing and Certification of Electrical Equipment (IECEE), Geneva, Switzerland. All rights reserved.</p>	

EN 60950-1:2006/A11:2009/A1:2010/A12:2011/A2:2013 – CENELEC COMMON MODIFICATIONS

IEC 60950-1, GROUP DIFFERENCES (CENELEC common modifications EN)			
Clause	Requirement + Test	Result - Remark	Verdict
	Clauses, subclauses, notes, tables and figures which are additional to those in IEC60950-1 and it's amendmets are prefixed "Z"		P
Contents (A2:2013)	Add the following annexes: Annex ZA (normative) Normative references to international publications with their corresponding European publications Annex ZB (normative) Special national conditions Annex ZD (informative) IEC and CENELEC code designations for flexible cords		P
General	Delete all the "country" notes in the reference document (IEC 60950-1:2005) according to the following list: 1.4.8 Note 2 1.5.1 Note 2 & 3 1.5.7.1 Note 1.5.8 Note 2 1.5.9.4 Note 1.7.2.1 Note 4, 5 & 6 2.2.3 Note 2.2.4 Note 2.3.2 Note 2.3.2.1 Note 2 2.3.4 Note 2 2.6.3.3 Note 2 & 3 2.7.1 Note 2.10.3.2 Note 2 2.10.5.13 Note 3 3.2.1.1 Note 3.2.4 Note 3 2.5.1 Note 2 4.3.6 Note 1 & 2 4.7 Note 4 4.7.2.2 Note 4.7.3.1 Note 2 5.1.7.1 Note 3 & 4 5.3.7 Note 1 6 Note 2 & 5 6.1.2.1 Note 2 6.1.2.2 Note 6.2.2 Note 6.2.2.1 Note 2 6.2.2.2 Note 7.1 Note 3 7.2 Note 7.3 Note 1 & 2 G.2.1 Note 2 Annex H Note 2		P

ATTACHMENT 2

IEC60950_1F - ATTACHMENT			
Clause	Requirement + Test	Result - Remark	Verdict

IEC 60950-1, GROUP DIFFERENCES (CENELEC common modifications EN)			
Clause	Requirement + Test	Result - Remark	Verdict
General (A1:2010)	Delete all the "country" notes in the reference document (IEC 60950-1:2005/A1:2010) according to the following list: 1.5.7.1 Note 6.1.2.1 Note 2 6.2.2.1 Note 2 EE.3 Note		P
General (A2:2013)	Delete all the "country" notes in the reference document (IEC 60950-1:2005/A2:2013) according to the following list: 2.7.1 Note * 2.10.3.1 Note 2 6.2.2. Note * Note of secretary: Text of Common Modification remains unchanged.		P
1.1.1 (A1:2010)	Replace the text of NOTE 3 by the following. NOTE 3 The requirements of EN 60065 may also be used to meet safety requirements for multimedia equipment. See IEC Guide 112, Guide on the safety of multimedia equipment. For television sets EN 60065 applies.		N/A
1.3.Z1	Add the following subclause: 1.3.Z1 Exposure to excessive sound pressure The apparatus shall be so designed and constructed as to present no danger when used for its intended purpose, either in normal operating conditions or under fault conditions, particularly providing protection against exposure to excessive sound pressures from headphones or earphones. NOTE Z1 A new method of measurement is described in EN 50332-1, Sound system equipment: Headphones and earphones associated with portable audio equipment - Maximum sound pressure level measurement methodology and limit considerations - Part 1: General method for "one package equipment", and in EN 50332-2, Sound system equipment: Headphones and earphones associated with portable audio equipment - Maximum sound pressure level measurement methodology and limit considerations - Part 2: Guidelines to associate sets with headphones coming from different manufacturers.	Not such equipment.	N/A
(A12:2011)	In EN 60950-1:2006/A12:2011 Delete the addition of 1.3.Z1 / EN 60950-1:2006 Delete the definition 1.2.3.Z1 / EN 60950-1:2006 /A1:2010	Deleted.	N/A
1.5.1 (Added info*)	Add the following NOTE: NOTE Z1 The use of certain substances in electrical and electronic equipment is restricted within the EU: see Directive 2002/95/EC. New Directive 2011/65/11 *	Added.	P

ATTACHMENT 2

IEC60950_1F - ATTACHMENT			
Clause	Requirement + Test	Result - Remark	Verdict

IEC 60950-1, GROUP DIFFERENCES (CENELEC common modifications EN)			
Clause	Requirement + Test	Result - Remark	Verdict
1.7.2.1 (A1:2010)	In addition, for a PORTABLE SOUND SYSTEM, the instructions shall include a warning that excessive sound pressure from earphones and headphones can cause hearing loss.	Added.	N/A
1.7.2.1 (A12:2011)	In EN 60950-1:2006/A12:2011 Delete NOTE Z1 and the addition for Portable Sound System. Add the following clause and annex to the existing standard and amendments.	Deleted.	N/A
	Zx Protection against excessive sound pressure from personal music players		N/A

ATTACHMENT 2

IEC60950_1F - ATTACHMENT			
Clause	Requirement + Test	Result - Remark	Verdict

IEC 60950-1, GROUP DIFFERENCES (CENELEC common modifications EN)			
Clause	Requirement + Test	Result - Remark	Verdict
	<p>Zx.1 General</p> <p>This sub-clause specifies requirements for protection against excessive sound pressure from personal music players that are closely coupled to the ear. It also specifies requirements for earphones and headphones intended for use with personal music players.</p> <p>A personal music player is a portable equipment for personal use, that:</p> <ul style="list-style-type: none"> – is designed to allow the user to listen to recorded or broadcast sound or video; and – primarily uses headphones or earphones that can be worn in or on or around the ears; and – allows the user to walk around while in use. <p>NOTE 1 Examples are hand-held or body-worn portable CD players, MP3 audio players, mobile phones with MP3 type features, PDA's or similar equipment.</p> <p>A personal music player and earphones or headphones intended to be used with personal music players shall comply with the requirements of this sub-clause.</p> <p>The requirements in this sub-clause are valid for music or video mode only.</p> <p>The requirements do not apply:</p> <ul style="list-style-type: none"> – while the personal music player is connected to an external amplifier; or – while the headphones or earphones are not used. <p>NOTE 2 An external amplifier is an amplifier which is not part of the personal music player or the listening device, but which is intended to play the music as a standalone music player.</p> <p>The requirements do not apply to:</p> <ul style="list-style-type: none"> – hearing aid equipment and professional equipment; <p>NOTE 3 Professional equipment is equipment sold through special sales channels. All products sold through normal electronics stores are considered not to be professional equipment.</p>		N/A

ATTACHMENT 2

IEC60950_1F - ATTACHMENT			
Clause	Requirement + Test	Result - Remark	Verdict

IEC 60950-1, GROUP DIFFERENCES (CENELEC common modifications EN)			
Clause	Requirement + Test	Result - Remark	Verdict
	<p>– analogue personal music players (personal music players without any kind of digital processing of the sound signal) that are brought to the market before the end of 2015.</p> <p>NOTE 4 This exemption has been allowed because this technology is falling out of use and it is expected that within a few years it will no longer exist. This exemption will not be extended to other technologies.</p> <p>For equipment which is clearly designed or intended for use by young children, the limits of EN 71-1 apply.</p>		N/A
	<p>Zx.2 Equipment requirements</p> <p>No safety provision is required for equipment that complies with the following:</p> <p>– equipment provided as a package (personal music player with its listening device), where the acoustic output $L_{Aeq,T}$ is ≤ 85 dBA measured while playing the fixed “programme simulation noise” as described in EN 50332-1; and</p> <p>– a personal music player provided with an analogue electrical output socket for a listening device, where the electrical output is ≤ 27 mV measured as described in EN 50332-2, while playing the fixed “programme simulation noise” as described in EN 50332-1.</p> <p>NOTE 1 Wherever the term acoustic output is used in this clause, the 30 s A-weighted equivalent sound pressure level $L_{Aeq,T}$ is meant. See also Zx.5 and Annex Zx.</p> <p>All other equipment shall:</p> <p>a) protect the user from unintentional acoustic outputs exceeding those mentioned above; and</p> <p>b) have a standard acoustic output level not exceeding those mentioned above, and automatically return to an output level not exceeding those mentioned above when the power is switched off; and</p>		N/A

ATTACHMENT 2

IEC60950_1F - ATTACHMENT			
Clause	Requirement + Test	Result - Remark	Verdict

IEC 60950-1, GROUP DIFFERENCES (CENELEC common modifications EN)			
Clause	Requirement + Test	Result - Remark	Verdict
	<p>c) provide a means to actively inform the user of the increased sound pressure when the equipment is operated with an acoustic output exceeding those mentioned above. Any means used shall be acknowledged by the user before activating a mode of operation which allows for an acoustic output exceeding those mentioned above. The acknowledgement does not need to be repeated more than once every 20 h of cumulative listening time; and</p> <p>NOTE 2 Examples of means include visual or audible signals. Action from the user is always required.</p> <p>NOTE 3 The 20 h listening time is the accumulative listening time, independent how often and how long the personal music player has been switched off.</p> <p>d) have a warning as specified in Zx.3; and</p> <p>e) not exceed the following:</p> <ol style="list-style-type: none"> 1) equipment provided as a package (player with its listening device), the acoustic output shall be ≤ 100 dBA measured while playing the fixed "programme simulation noise" described in EN 50332-1; and 2) a personal music player provided with an analogue electrical output socket for a listening device, the electrical output shall be ≤ 150 mV measured as described in EN 50332-2, while playing the fixed "programme simulation noise" described in EN 50332-1. <p>For music where the average sound pressure (long term $L_{Aeq,T}$) measured over the duration of the song is lower than the average produced by the programme simulation noise, the warning does not need to be given as long as the average sound pressure of the song is below the basic limit of 85 dBA. In this case T becomes the duration of the song.</p> <p>NOTE 4 Classical music typically has an average sound pressure (long term $L_{Aeq,T}$) which is much lower than the average programme simulation noise. Therefore, if the player is capable to analyse the song and compare it with the programme simulation noise, the warning does not need to be given as long as the average sound pressure of the song is below the basic limit of 85 dBA.</p> <p>For example, if the player is set with the programme simulation noise to 85 dBA, but the average music level of the song is only 65 dBA, there is no need to give a warning or ask an acknowledgement as long as the average sound level of the song is not above the basic limit of 85 dBA.</p>		N/A

ATTACHMENT 2

IEC60950_1F - ATTACHMENT			
Clause	Requirement + Test	Result - Remark	Verdict

IEC 60950-1, GROUP DIFFERENCES (CENELEC common modifications EN)			
Clause	Requirement + Test	Result - Remark	Verdict
	<p>Zx.3 Warning</p> <p>The warning shall be placed on the equipment, or on the packaging, or in the instruction manual and shall consist of the following:</p> <ul style="list-style-type: none"> – the symbol of Figure 1 with a minimum height of 5 mm; and – the following wording, or similar: <p>“To prevent possible hearing damage, do not listen at high volume levels for long periods.”</p> <div style="text-align: center;">  </div> <p>Figure 1 – Warning label (IEC 60417-6044)</p> <p>Alternatively, the entire warning may be given through the equipment display during use, when the user is asked to acknowledge activation of the higher level.</p>		N/A
	<p>Zx.4 Requirements for listening devices (headphones and earphones)</p>		N/A
	<p>Zx.4.1 Wired listening devices with analogue input</p> <p>With 94 dBA sound pressure output $L_{Aeq,T}$, the input voltage of the fixed “programme simulation noise” described in EN 50332-2 shall be ≥ 75 mV.</p> <p>This requirement is applicable in any mode where the headphones can operate (active or passive), including any available setting (for example built-in volume level control).</p> <p>NOTE The values of 94 dBA – 75 mV correspond with 85dBA – 27 mV and 100 dBA – 150 mV.</p>		N/A

ATTACHMENT 2

IEC60950_1F - ATTACHMENT			
Clause	Requirement + Test	Result - Remark	Verdict

IEC 60950-1, GROUP DIFFERENCES (CENELEC common modifications EN)			
Clause	Requirement + Test	Result - Remark	Verdict
	<p>Zx.4.2 Wired listening devices with digital input</p> <p>With any playing device playing the fixed “programme simulation noise” described in EN 50332-1 (and respecting the digital interface standards, where a digital interface standard exists that specifies the equivalent acoustic level), the acoustic output $L_{Aeq,T}$ of the listening device shall be ≤ 100 dBA.</p> <p>This requirement is applicable in any mode where the headphones can operate, including any available setting (for example built-in volume level control, additional sound feature like equalization, etc.).</p> <p>NOTE An example of a wired listening device with digital input is a USB headphone.</p>		N/A
	<p>Zx.4.3 Wireless listening devices</p> <p>In wireless mode:</p> <ul style="list-style-type: none"> – with any playing and transmitting device playing the fixed programme simulation noise described in EN 50332-1; and – respecting the wireless transmission standards, where an air interface standard exists that specifies the equivalent acoustic level; and – with volume and sound settings in the listening device (for example built-in volume level control, additional sound feature like equalization, etc.) set to the combination of positions that maximize the measured acoustic output for the abovementioned programme simulation noise, the acoustic output $L_{Aeq,T}$ of the listening device shall be ≤ 100 dBA. <p>NOTE An example of a wireless listening device is a Bluetooth headphone.</p>		N/A

ATTACHMENT 2

IEC60950_1F - ATTACHMENT			
Clause	Requirement + Test	Result - Remark	Verdict

IEC 60950-1, GROUP DIFFERENCES (CENELEC common modifications EN)			
Clause	Requirement + Test	Result - Remark	Verdict
	<p>Zx.5 Measurement methods Measurements shall be made in accordance with EN 50332-1 or EN 50332-2 as applicable. Unless stated otherwise, the time interval T shall be 30 s.</p> <p>NOTE Test method for wireless equipment provided without listening device should be defined.</p>		N/A
2.7.1	<p>Replace the subclause as follows: Basic requirements To protect against excessive current, short-circuits and earth faults in PRIMARY CIRCUITS, protective devices shall be included either as integral parts of the equipment or as parts of the building installation, subject to the following, a), b) and c): a) except as detailed in b) and c), protective devices necessary to comply with the requirements of 5.3 shall be included as parts of the equipment; b) for components in series with the mains input to the equipment such as the supply cord, appliance coupler, r.f.i. filter and switch, short-circuit and earth fault protection may be provided by protective devices in the building installation;</p>	Replaced.	P
	<p>c) it is permitted for PLUGGABLE EQUIPMENT TYPE B or PERMANENTLY CONNECTED EQUIPMENT, to rely on dedicated overcurrent and short-circuit protection in the building installation, provided that the means of protection, e.g. fuses or circuit breakers, is fully specified in the installation instructions. If reliance is placed on protection in the building installation, the installation instructions shall so state, except that for PLUGGABLE EQUIPMENT TYPE A the building installation shall be regarded as providing protection in accordance with the rating of the wall socket outlet.</p>		N/A
2.7.2	This subclause has been declared 'void'.		N/A
3.2.3	Delete the NOTE in Table 3A, and delete also in this table the conduit sizes in parentheses.	Deleted.	N/A

ATTACHMENT 2

IEC60950_1F - ATTACHMENT			
Clause	Requirement + Test	Result - Remark	Verdict

IEC 60950-1, GROUP DIFFERENCES (CENELEC common modifications EN)			
Clause	Requirement + Test	Result - Remark	Verdict
3.2.5.1	<p>Replace “60245 IEC 53” by “H05 RR-F”; “60227 IEC 52” by “H03 VV-F or H03 VVH2-F”; “60227 IEC 53” by “H05 VV-F or H05 VVH2-F2”.</p> <p>In Table 3B, replace the first four lines by the following:</p> <p>Up to and including 6 0,75^{a)} Over 6 up to and including 10 (0,75)^{b)} 1,0 Over 10 up to and including 16 (1,0)^{c)} 1,5 </p> <p>In the conditions applicable to Table 3B delete the words “in some countries” in condition^{a)}.</p> <p>In NOTE 1, applicable to Table 3B, delete the second sentence.</p>	Replaced.	N/A
3.2.5.1 (A2:2013)	NOTE Z1 The harmonised code designations corresponding to the IEC cord types are given in Annex ZD		N/A
3.3.4	<p>In Table 3D, delete the fourth line: conductor sizes for 10 to 13 A, and replace with the following:</p> <p>Over 10 up to and including 16 1,5 to 2,5 1,5 to 4 </p> <p>Delete the fifth line: conductor sizes for 13 to 16 A</p>	Deleted.	N/A
4.3.13.6 (A1:2010)	<p>Replace the existing NOTE by the following:</p> <p>NOTE Z1 Attention is drawn to:</p> <p>1999/519/EC: Council Recommendation on the limitation of exposure of the general public to electromagnetic fields 0 Hz to 300 GHz, and</p> <p>2006/25/EC: Directive on the minimum health and safety requirements regarding the exposure of workers to risks arising from physical agents (artificial optical radiation).</p>	Replaced.	N/A
	Standards taking into account mentioned Recommendation and Directive which demonstrate compliance with the applicable EU Directive are indicated in the OJEC.		N/A
Annex H	<p>Replace the last paragraph of this annex by:</p> <p>At any point 10 cm from the surface of the OPERATOR ACCESS AREA, the dose rate shall not exceed 1 µSv/h (0,1 mR/h) (see NOTE). Account is taken of the background level.</p> <p>Replace the notes as follows:</p> <p>NOTE These values appear in Directive 96/29/Euratom.</p> <p>Delete NOTE 2.</p>	Replaced.	N/A
Bibliography	Additional EN standards.	Added.	—

ATTACHMENT 2

IEC60950_1F - ATTACHMENT			
Clause	Requirement + Test	Result - Remark	Verdict

IEC 60950-1, GROUP DIFFERENCES (CENELEC common modifications EN)			
Clause	Requirement + Test	Result - Remark	Verdict

ZA	NORMATIVE REFERENCES TO INTERNATIONAL PUBLICATIONS WITH THEIR CORRESPONDING EUROPEAN PUBLICATIONS	—	
-----------	--	---	--

ZB ANNEX (normative) SPECIAL NATIONAL CONDITIONS (EN)			
Clause	Requirement + Test	Result - Remark	Verdict
1.2.4.1	In Denmark , certain types of Class I appliances (see 3.2.1.1) may be provided with a plug not establishing earthing conditions when inserted into Danish socket-outlets.		N/A
1.2.13.14 (A11:2009)	In Norway and Sweden , for requirements see 1.7.2.1 and 7.3 of this annex.		N/A
1.5.7.1 (A11:2009)	In Finland, Norway and Sweden , resistors bridging BASIC INSULATION in CLASS I PLUGGABLE EQUIPMENT TYPE A must comply with the requirements in 1.5.7.1. In addition when a single resistor is used, the resistor must withstand the resistor test in 1.5.7.2.		N/A
1.5.8	In Norway , due to the IT power system used (see annex V, Figure V.7), capacitors are required to be rated for the applicable line-to-line voltage (230 V).		P
1.5.9.4	In Finland, Norway and Sweden , the third dashed sentence is applicable only to equipment as defined in 6.1.2.2 of this annex.		N/A

ATTACHMENT 2

IEC60950_1F - ATTACHMENT			
Clause	Requirement + Test	Result - Remark	Verdict

ZB ANNEX (normative) SPECIAL NATIONAL CONDITIONS (EN)			
Clause	Requirement + Test	Result - Remark	Verdict
1.7.2.1	<p>In Finland, Norway and Sweden, CLASS I PLUGGABLE EQUIPMENT TYPE A intended for connection to other equipment or a network shall, if safety relies on connection to protective earth or if surge suppressors are connected between the network terminals and accessible parts, have a marking stating that the equipment must be connected to an earthed mains socket-outlet.</p> <p>The marking text in the applicable countries shall be as follows:</p> <p>In Finland: "Laite on liitettävä suojakoskettimilla varustettuun pistorasiaan"</p> <p>In Norway: "Apparatet må tilkoples jordet stikkontakt"</p> <p>In Sweden: "Apparaten skall anslutas till jordat uttag"</p>		N/A
1.7.2.1 (A11:2009)	<p>In Norway and Sweden, the screen of the cable distribution system is normally not earthed at the entrance of the building and there is normally no equipotential bonding system within the building. Therefore the protective earthing of the building installation need to be isolated from the screen of a cable distribution system.</p> <p>It is however accepted to provide the insulation external to the equipment by an adapter or an interconnection cable with galvanic isolator, which may be provided by e.g. a retailer.</p> <p>The user manual shall then have the following or similar information in Norwegian and Swedish language respectively, depending on in what country the equipment is intended to be used in:</p> <p>"Equipment connected to the protective earthing of the building installation through the mains connection or through other equipment with a connection to protective earthing – and to a cable distribution system using coaxial cable, may in some circumstances create a fire hazard. Connection to a cable distribution system has therefore to be provided through a device providing electrical isolation below a certain frequency range (galvanic isolator, see EN 60728-11)."</p>		

ATTACHMENT 2

IEC60950_1F - ATTACHMENT			
Clause	Requirement + Test	Result - Remark	Verdict

ZB ANNEX (normative) SPECIAL NATIONAL CONDITIONS (EN)			
Clause	Requirement + Test	Result - Remark	Verdict
	<p>NOTE In Norway, due to regulation for installations of cable distribution systems, and in Sweden, a galvanic isolator shall provide electrical insulation below 5 MHz. The insulation shall withstand a dielectric strength of 1,5 kV r.m.s., 50 Hz or 60 Hz, for 1 min.</p> <p>Translation to Norwegian (the Swedish text will also be accepted in Norway): "Utstyr som er koplet til beskyttelsesjord via nettplugg og/eller via annet jordtilkoplede utstyr – og er tilkoplede et kabel-TV nett, kan forårsake brannfare. For å unngå dette skal det ved tilkopling av utstyret til kabel-TV nettet installeres en galvanisk isolator mellom utstyret og kabel-TV nettet."</p> <p>Translation to Swedish: "Utrustning som är kopplad till skyddsjord via jordat vägguttag och/eller via annan utrustning och samtidigt är kopplad till kabel-TV nät kan i vissa fall medföra risk för brand. För att undvika detta skall vid anslutning av utrustningen till kabel-TV nät galvanisk isolator finnas mellan utrustningen och kabel-TV nätet."</p>		N/A
1.7.2.1 (A2:2013)	<p>In Denmark, CLASS I PLUGGABLE EQUIPMENT TYPE A intended for connection to other equipment or a network shall, if safety relies on connection to protective earth or if surge suppressors are connected between the network terminals and accessible parts, have a marking stating that the equipment must be connected to an earthed mains socket-outlet.</p> <p>The marking text in Denmark shall be as follows: In Denmark: "Apparatets stikprop skal tilsluttes en stikkontakt med jord, som giver forbindelse til stikproppens jord."</p>		N/A

ATTACHMENT 2

IEC60950_1F - ATTACHMENT			
Clause	Requirement + Test	Result - Remark	Verdict

ZB ANNEX (normative) SPECIAL NATIONAL CONDITIONS (EN)			
Clause	Requirement + Test	Result - Remark	Verdict
1.7.5 1.7.5 (A11:2009)	<p>In Denmark, socket-outlets for providing power to other equipment shall be in accordance with the Heavy Current Regulations, Section 107-2-D1, Standard Sheet DK 1-3a, DK 1-5a or DK 1-7a, when used on Class I equipment. For STATIONARY EQUIPMENT the socket-outlet shall be in accordance with Standard Sheet DK 1-1b or DK 1-5a.</p> <p>For CLASS II EQUIPMENT the socket outlet shall be in accordance with Standard Sheet DKA 1-4a.</p>		N/A
1.7.5 (A2:2013)	<p>In Denmark, socket-outlets for providing power to other equipment shall be in accordance with the DS 60884-2-D1:2011.</p> <p>For class I equipment the following Standard Sheets are applicable: DK 1-3a, DK 1-1c, DK 1-1d, DK 1-5a or DK 1-7a, with the exception for STATIONARY EQUIPMENT where the socket-outlets shall be in accordance with Standard Sheet DK 1-1b, DK 1-1c, DK 1-1d or DK 1-5a.</p> <p>Socket outlets intended for providing power to Class II apparatus with a rated current of 2,5 A shall be in accordance with DS 60884-2-D1 standard sheet DKA 1-4a. Other current rating socket outlets shall be in compliance with by DS 60884-2-D1 Standard Sheet DKA 1-3a or DKA 1-3b.</p> <p>Justification the Heavy Current Regulations, 6c</p>		N/A
2.2.4	In Norway , for requirements see 1.7.2.1, 6.1.2.1 and 6.1.2.2 of this annex.	No TNV circuits.	N/A
2.3.2	In Finland, Norway and Sweden there are additional requirements for the insulation. See 6.1.2.1 and 6.1.2.2 of this annex.	No TNV circuits.	N/A
2.3.4	In Norway , for requirements see 1.7.2.1, 6.1.2.1 and 6.1.2.2 of this annex.	No TNV circuits.	N/A
2.6.3.3	In the United Kingdom , the current rating of the circuit shall be taken as 13 A, not 16 A.		N/A

ATTACHMENT 2

IEC60950_1F - ATTACHMENT			
Clause	Requirement + Test	Result - Remark	Verdict

ZB ANNEX (normative) SPECIAL NATIONAL CONDITIONS (EN)			
Clause	Requirement + Test	Result - Remark	Verdict
2.7.1	In the United Kingdom , to protect against excessive currents and short-circuits in the PRIMARY CIRCUIT of DIRECT PLUG-IN EQUIPMENT, tests according to 5.3 shall be conducted, using an external protective device rated 30 A or 32 A. If these tests fail, suitable protective devices shall be included as integral parts of the DIRECT PLUG-IN EQUIPMENT, so that the requirements of 5.3 are met.	One build-in fuse provided.	P
2.10.5.13	In Finland, Norway and Sweden , there are additional requirements for the insulation, see 6.1.2.1 and 6.1.2.2 of this annex.	No TNV circuits.	N/A
3.2.1.1	In Switzerland , supply cords of equipment having a RATED CURRENT not exceeding 10 A shall be provided with a plug complying with SEV 1011 or IEC 60884-1 and one of the following dimension sheets: SEV 6532-2.1991 Plug Type 15 3P+N+PE 250/400 V, 10 A SEV 6533-2.1991 Plug Type 11 L+N 250 V, 10 A SEV 6534-2.1991 Plug Type 12 L+N+PE 250 V, 10 A In general, EN 60309 applies for plugs for currents exceeding 10 A. However, a 16 A plug and socket-outlet system is being introduced in Switzerland, the plugs of which are according to the following dimension sheets, published in February 1998: SEV 5932-2.1998: Plug Type 25 , 3L+N+PE 230/400 V, 16 A SEV 5933-2.1998: Plug Type 21, L+N, 250 V, 16A SEV 5934-2.1998: Plug Type 23, L+N+PE 250 V, 16 A		N/A

ATTACHMENT 2

IEC60950_1F - ATTACHMENT			
Clause	Requirement + Test	Result - Remark	Verdict

ZB ANNEX (normative) SPECIAL NATIONAL CONDITIONS (EN)			
Clause	Requirement + Test	Result - Remark	Verdict
3.2.1.1	<p>In Denmark, supply cords of single-phase equipment having a rated current not exceeding 13 A shall be provided with a plug according to the Heavy Current Regulations, Section 107-2-D1.</p> <p>CLASS I EQUIPMENT provided with socket-outlets with earth contacts or which are intended to be used in locations where protection against indirect contact is required according to the wiring rules shall be provided with a plug in accordance with standard sheet DK 2-1a or DK 2-5a.</p> <p>If poly-phase equipment and single-phase equipment having a RATED CURRENT exceeding 13 A is provided with a supply cord with a plug, this plug shall be in accordance with the Heavy Current Regulations, Section 107-2-D1 or EN 60309-2.</p>		N/A
3.2.1.1 (A2:2013)	<p>In Denmark, supply cords of single-phase equipment having a rated current not exceeding 13 A shall be provided with a plug according to DS 60884-2-D1.</p> <p>CLASS I EQUIPMENT provided with socket-outlets with earth contacts or which are intended to be used in locations where protection against indirect contact is required according to the wiring rules shall be provided with a plug in accordance with standard sheet DK 2-1a or DK 2-5a.</p> <p>If a single-phase equipment having a RATED CURRENT exceeding 13 A or if a poly-phase equipment is provided with a supply cord with a plug, this plug shall be in accordance with the standard sheets DK 6-1a in DS 60884-2-D1 or EN 60309-2.</p> <p>Justification the Heavy Current Regulations, 6c</p>		N/A

ATTACHMENT 2

IEC60950_1F - ATTACHMENT			
Clause	Requirement + Test	Result - Remark	Verdict

ZB ANNEX (normative) SPECIAL NATIONAL CONDITIONS (EN)			
Clause	Requirement + Test	Result - Remark	Verdict
3.2.1.1	<p>In Spain, supply cords of single-phase equipment having a rated current not exceeding 10 A shall be provided with a plug according to UNE 20315:1994.</p> <p>Supply cords of single-phase equipment having a rated current not exceeding 2,5 A shall be provided with a plug according to UNE-EN 50075:1993.</p> <p>CLASS I EQUIPMENT provided with socket-outlets with earth contacts or which are intended to be used in locations where protection against indirect contact is required according to the wiring rules, shall be provided with a plug in accordance with standard UNE 20315:1994.</p> <p>If poly-phase equipment is provided with a supply cord with a plug, this plug shall be in accordance with UNE-EN 60309-2.</p>		N/A
3.2.1.1	<p>In the United Kingdom, apparatus which is fitted with a flexible cable or cord and is designed to be connected to a mains socket conforming to BS 1363 by means of that flexible cable or cord and plug, shall be fitted with a 'standard plug' in accordance with Statutory Instrument 1768:1994 - The Plugs and Sockets etc. (Safety) Regulations 1994, unless exempted by those regulations.</p> <p>NOTE 'Standard plug' is defined in SI 1768:1994 and essentially means an approved plug conforming to BS 1363 or an approved conversion plug.</p>		N/A
3.2.1.1	<p>In Ireland, apparatus which is fitted with a flexible cable or cord and is designed to be connected to a mains socket conforming to I.S. 411 by means of that flexible cable or cord and plug, shall be fitted with a 13 A plug in accordance with Statutory Instrument 525:1997 - National Standards Authority of Ireland (section 28) (13 A Plugs and Conversion Adaptors for Domestic Use) Regulations 1997.</p>		N/A
3.2.4	<p>In Switzerland, for requirements see 3.2.1.1 of this annex.</p>		N/A
3.2.5.1	<p>In the United Kingdom, a power supply cord with conductor of 1,25 mm² is allowed for equipment with a rated current over 10 A and up to and including 13 A.</p>		N/A

ATTACHMENT 2

IEC60950_1F - ATTACHMENT			
Clause	Requirement + Test	Result - Remark	Verdict

ZB ANNEX (normative) SPECIAL NATIONAL CONDITIONS (EN)			
Clause	Requirement + Test	Result - Remark	Verdict
3.3.4	In the United Kingdom , the range of conductor sizes of flexible cords to be accepted by terminals for equipment with a RATED CURRENT of over 10 A up to and including 13 A is: • 1,25 mm ² to 1,5 mm ² nominal cross-sectional area.		N/A
4.3.6	In the United Kingdom , the torque test is performed using a socket outlet complying with BS 1363 part 1:1995, including Amendment 1:1997 and Amendment 2:2003 and the plug part of DIRECT PLUG-IN EQUIPMENT shall be assessed to BS 1363: Part 1, 12.1, 12.2, 12.3, 12.9, 12.11, 12.12, 12.13, 12.16 and 12.17, except that the test of 12.17 is performed at not less than 125 °C. Where the metal earth pin is replaced by an Insulated Shutter Opening Device (ISOD), the requirements of clauses 22.2 and 23 also apply.		N/A
4.3.6	In Ireland , DIRECT PLUG-IN EQUIPMENT is known as plug similar devices. Such devices shall comply with Statutory Instrument 526:1997 - National Standards Authority of Ireland (Section 28) (Electrical plugs, plug similar devices and sockets for domestic use) Regulations, 1997.		N/A
5.1.7.1	In Finland, Norway and Sweden TOUCH CURRENT measurement results exceeding 3,5 mA r.m.s. are permitted only for the following equipment: • STATIONARY PLUGGABLE EQUIPMENT TYPE A that is intended to be used in a RESTRICTED ACCESS LOCATION where equipotential bonding has been applied, for example, in a telecommunication centre; and has provision for a permanently connected PROTECTIVE EARTHING CONDUCTOR; and is provided with instructions for the installation of that conductor by a SERVICE PERSON; • STATIONARY PLUGGABLE EQUIPMENT TYPE B; • STATIONARY PERMANENTLY CONNECTED EQUIPMENT.		N/A

ATTACHMENT 2

IEC60950_1F - ATTACHMENT			
Clause	Requirement + Test	Result - Remark	Verdict

ZB ANNEX (normative) SPECIAL NATIONAL CONDITIONS (EN)			
Clause	Requirement + Test	Result - Remark	Verdict
6.1.2.1 (A1:2010)	<p>In Finland, Norway and Sweden, add the following text between the first and second paragraph of the compliance clause: If this insulation is solid, including insulation forming part of a component, it shall at least consist of either</p> <ul style="list-style-type: none"> - two layers of thin sheet material, each of which shall pass the electric strength test below, or - one layer having a distance through insulation of at least 0,4 mm, which shall pass the electric strength test below. <p>Alternatively for components, there is no distance through insulation requirements for the insulation consisting of an insulating compound completely filling the casing, so that CLEARANCES and CREEPAGE DISTANCES do not exist, if the component passes the electric strength test in accordance with the compliance clause below and in addition</p> <ul style="list-style-type: none"> - passes the tests and inspection criteria of 2.10.11 with an electric strength test of 1,5 kV multiplied by 1,6 (the electric strength test of 2.10.10 shall be performed using 1,5 kV), and - is subject to ROUTINE TESTING for electric strength during manufacturing, using a test voltage of 1,5 kV. 		N/A

ATTACHMENT 2

IEC60950_1F - ATTACHMENT			
Clause	Requirement + Test	Result - Remark	Verdict

ZB ANNEX (normative) SPECIAL NATIONAL CONDITIONS (EN)			
Clause	Requirement + Test	Result - Remark	Verdict
	<p>It is permitted to bridge this insulation with an optocoupler complying with 2.10.5.4 b).</p> <p>It is permitted to bridge this insulation with a capacitor complying with EN 60384-14:2005, subclass Y2.</p> <p>A capacitor classified Y3 according to EN 60384-14:2005, may bridge this insulation under the following conditions:</p> <ul style="list-style-type: none"> - the insulation requirements are satisfied by having a capacitor classified Y3 as defined by EN 60384-14, which in addition to the Y3 testing, is tested with an impulse test of 2,5 kV defined in EN 60950-1:2006, 6.2.2.1; - the additional testing shall be performed on all the test specimens as described in EN 60384-14: - the impulse test of 2,5 kV is to be performed before the endurance test in EN 60384-14, in the sequence of tests as described in EN 60384-14. 		N/A
6.1.2.2	In Finland, Norway and Sweden , the exclusions are applicable for PERMANENTLY CONNECTED EQUIPMENT, PLUGGABLE EQUIPMENT TYPE B and equipment intended to be used in a RESTRICTED ACCESS LOCATION where equipotential bonding has been applied, e.g. in a telecommunication centre, and which has provision for a permanently connected PROTECTIVE EARTHING CONDUCTOR and is provided with instructions for the installation of that conductor by a SERVICE PERSON.		N/A
7.2	In Finland, Norway and Sweden , for requirements see 6.1.2.1 and 6.1.2.2 of this annex. The term TELECOMMUNICATION NETWORK in 6.1.2 being replaced by the term CABLE DISTRIBUTION SYSTEM.		N/A
7.3 (A11:2009)	In Norway and Sweden , for requirements see 1.2.13.14 and 1.7.2.1 of this annex.		N/A

ATTACHMENT 2

IEC60950_1F - ATTACHMENT			
Clause	Requirement + Test	Result - Remark	Verdict

**Annex ZD
(informative)**

IEC and CENELEC code designations for flexible cords

Type of flexible cord	Code designations	
	IEC	CENELEC
PVC insulated cords		
Flat twin tinsel cord	60227 IEC 41	H03VH-Y
Light polyvinyl chloride sheathed flexible cord	60227 IEC 52	H03VV-F H03VVH2-F
Ordinary polyvinyl chloride sheathed flexible cord	60277 IEC 53	H05VV-F H05VVH2-F
Rubber insulated cords		
Braided cord	60245 IEC 51	H03RT-F
Ordinary tough rubber sheathed flexible cord	60245 IEC 53	H05RR-F
Ordinary polychloroprene sheathed flexible cord	60245 IEC 57	H05RN-F
Heavy polychloroprene sheathed flexible cord	60245 IEC 66	H07RN-F
Cords having high flexibility		
Rubber insulated and sheathed cord	60245 IEC 86	H03RR-H
Rubber insulated, crosslinked PVC sheathed cord	60245 IEC 87	H03RV4-H
Crosslinked PVC insulated and sheathed cord	60245 IEC 88	H03V4V4-H

ATTACHMENT 2

IEC60950_1F - ATTACHMENT			
Clause	Requirement + Test	Result - Remark	Verdict

**ATTACHMENT TO TEST REPORT IEC 60950-1
 AUSTRALIA NATIONAL DIFFERENCES**
 Information technology equipment – Safety –
 Part 1: General requirements

Differences according to.....: AS/NZS 60950.1 : 2015

Annex ZZ Variations

1.2.12.201	Addition: POTENTIAL IGNITION SOURCE Possible fault which can starts a fire if the open-circuit voltage measured across an interruption or faulty contact exceeds a value of 50 V (peak) a.c. or d.c. and the product of the peak value of this voltage and the measured r.m.s. current under normal operating conditions exceeds 15VA. Such a faulty contact or interruption in an electrical connection includes those which may occur in conductive patterns on printed boards. Note 201: An electronic protection circuit may be used to prevent such a fault from becoming a POTENTIAL IGNITION SOURCE. Note 202: This definition is from AS/NZS 60065:2012, Clause 2.8.11	Added.	P				
1.5.1	Add to the end of the first paragraph and in note 1 after the word "standard; "or the relevant Australian / New Zealand Standard". Delete from second paragraph 'without further evaluation'.	Added	P				
1.5.2	Add to the first line of the first paragraph and first paragraph second dashed item second line and last line after the word "standard:" or an Australian/New Zealand Standard ".	Added	P				
1.7.1.3	Replace existing text with Graphical symbols placed on the equipment as a requirement of this standard, shall be in accordance with IEC 60417 or ISO 3864-2 or ISO 7000, if available. In absence of suitable symbols, the manufacturer may design specific graphical symbols	Added	P				
2.9.2	Delete from second paragraph the word "designated".	Added.	N/A				
3.2.5.1	Replace the first four rows for Table 3B with the following: Sizes of Conductors <table border="1" data-bbox="375 1881 981 2009"> <tr> <td>Rated current of equipment A</td> <td>Nominal cross-sectional area mm²</td> </tr> <tr> <td>Over 0.2 up to and including 3</td> <td>0.5¹⁾</td> </tr> </table>	Rated current of equipment A	Nominal cross-sectional area mm ²	Over 0.2 up to and including 3	0.5 ¹⁾	No power supply cord provided.	N/A
Rated current of equipment A	Nominal cross-sectional area mm ²						
Over 0.2 up to and including 3	0.5 ¹⁾						

ATTACHMENT 2

IEC60950_1F - ATTACHMENT											
Clause	Requirement + Test	Result - Remark	Verdict								
	<table border="1"> <tr> <td></td> <td>0.75</td> </tr> <tr> <td>Over 3 up to and including 7.5</td> <td></td> </tr> <tr> <td>Over 7.5 up to and including 10</td> <td>(0.75)²⁾ 1.00</td> </tr> <tr> <td>Over 10 up to and including 16</td> <td>(1.0)³⁾ 1.5</td> </tr> </table> <p>Replace footnote a) with the following: This nominal cross-sectional area is only allowed for Class II appliances if the length of the power supply cord, measured between the point where the cord or cord guard, enters the appliance, and the entry to the plug, does not exceed 2 m (0.5 mm² three-core supply flexible cords are not permitted; see S/NZS 3191).</p> <p>Delete Note 1. And renumber existing Note 2 as Note</p>		0.75	Over 3 up to and including 7.5		Over 7.5 up to and including 10	(0.75) ²⁾ 1.00	Over 10 up to and including 16	(1.0) ³⁾ 1.5		
	0.75										
Over 3 up to and including 7.5											
Over 7.5 up to and including 10	(0.75) ²⁾ 1.00										
Over 10 up to and including 16	(1.0) ³⁾ 1.5										
4.1.201	<p>Addition: Display devices used for television purposes</p> <p>Display devices which may be used for television purposes, with a mass of 7 kg or more, shall comply with the requirements for stability and mechanical hazards, including the additional stability requirements for television received, specified in AS/NZS 60065.</p>	No such device.	N/A								
4.3.6	<p>Replace the third paragraph: Equipment with a plug portion, suitable for insertion into a 10 A 3-pin flat-pin socket-outlet complying with AS/NZS 3112, shall comply with the requirements in AS/NZS 3112 for equipment with integral pins for insertion into socket-outlets.</p>	The EUT is not a DIRECT PLUG-IN EQUIPMENT.	N/A								
4.3.8	<p>Add new note after the first dashed item of paragraph eight.</p> <p>Note 6.201 In cases where the voltage source is provided by power from an unassociated power source, consideration should be given to the effect of possible single fault conditions in the unassociated equipment. If the power source is unknown then it should be assumed that the maximum limit of SELV may be applied to the source input under assumed single fault conditions in the source when accessing the charging circuit in the equipment under test.</p>		N/A								
4.3.8.201	<p>Additional after Clause 4.3.8: Products containing coin/button cell batteries and batteries designated R1.</p> <p>The requirements of AS/NZS 60065:2012</p>	Equipment for locations where it is unlikely that children will be present	N/A								

ATTACHMENT 2

IEC60950_1F - ATTACHMENT			
Clause	Requirement + Test	Result - Remark	Verdict
	Amendment 1:2015, clause 14.10.201 apply for this Clause.		
4.3.13.5.1	Add the following after each reference to 'IEC 60825-1': 'or AS/NZS 60825.1' Add the following after 'IEC 60825-2' in line two of the first paragraph: 'or AS/NZS 60825.2'		N/A
4.7	Add after the clause: For alternative resistance to fire tests, refer to Clause 4.7.201	Alternative tests not performed.	N/A
4.7.201	Additional after the clause 4.7.3.6: Resistance to fire - Alternative tests		N/A
4.7.201.1	<p>Addition: General Parts of non-metallic material shall be resistant to ignition and spread of fire. This requirement does not apply to decorative trims, knobs and other parts unlikely to be ignited or to propagate flames originating from inside the apparatus, or the following:</p> <p>(a) Components that are contained in an enclosure having a flammability category of V-0 according to AS/NZS 60695.11.10 and having openings only for the connecting wires filling the openings completely, and for ventilation not exceeding 1 mm in width regardless of length.</p> <p>(b) The following parts which would contribute negligible fuel to a fire: - small mechanical parts, the mass of which does not exceed 4 g, such as mounting parts, gears, cams, belts and bearings; - small electrical components, such as capacitors with a volume not exceeding 1 750 mm³, integrated circuits, transistors and optocoupler packages, if these components are mounted on material of flammability category V-1, or better, according to AS/NZS 60695.11.10.</p> <p>NOTE In considering how to minimize propagation of fire and what 'small parts' are, account should be taken of the cumulative effect of small parts adjacent to each other for the possible effect of propagating fire from one part to another.</p> <p>Compliance shall be checked by the tests of 4.7.201.2, 4.7.201.3, 4.7.201.4 and 4.7.201.5. For the base material of printed boards,</p>		N/A

ATTACHMENT 2

IEC60950_1F - ATTACHMENT			
Clause	Requirement + Test	Result - Remark	Verdict
	<p>compliance shall be checked by the test of 4.7.201.5.</p> <p>The tests shall be carried out on parts of non-metallic material which have been removed from the apparatus. When the glow-wire test is carried out, the parts shall be placed in the same orientation as they would be in normal use.</p> <p>These tests are not carried out on internal wiring.</p>		
4.7.201.2	<p>Addition: Testing of non-metallic materials Parts of non-metallic material shall be subject to the glow-wire test of AS/NZS 60695.2.11 which shall be carried out at 550°C.</p> <p>Parts for which the glow-wire test cannot be carried out, such as those made of soft or foamy material, shall meet the requirements specified in ISO 9772 for category FH-3 material. The glow-wire test shall be not carried out on parts of material classified at least FH-3 according to ISO 9772 provided that the sample tested was not thicker than the relevant part.</p>		N/A
4.7.201.3	<p>Addition: Testing of insulating materials Parts of insulating material supporting POTENTIAL IGNITION SOURCES shall be subject to the glow-wire test of AS/NZS 60695.2.11 which shall be carried out at 750°C. The test shall be also carried out on other parts of insulating material which are within a distance of 3mm of the connection.</p> <p>NOTE Contacts in components such as switch contacts are considered to be connections.</p> <p>For parts which withstand the glow-wire test but produce a flame, other parts above the connection within the envelope of a vertical cylinder having a diameter of 20 mm and a height of 50 mm shall be subjected to the needle-flame test. However, parts shielded by a barrier which meets the needle-flame test shall not be tested. The needle-flame test shall be made in accordance with AS/NZS 60695.11.5 with the following modifications:</p> <p>Clause of AS/NZS 60695.11.5 Change</p> <p>9 Test procedure</p>		N/A

ATTACHMENT 2

IEC60950_1F - ATTACHMENT			
Clause	Requirement + Test	Result - Remark	Verdict
	<p>9.2 Replace the first paragraph with:</p> <p style="padding-left: 40px;">The specimen shall be arranged so that the flame can be applied to a vertical or horizontal edge as shown in the examples of figure 1. If possible the flame shall be applied at least 10mm from a corner.</p> <p style="padding-left: 40px;">Replace the second paragraph with: The duration of application of the test flame shall be 30s ± 1s.</p> <p>9.3 Replace with:</p> <p style="padding-left: 40px;">The test shall be made on one specimen. If the specimen does not withstand the test, the test may be repeated on two further specimens, both of which shall then withstand the test.</p> <p>11 Evaluation of test results Replace with:</p> <p style="padding-left: 40px;">The duration of burning (tb) shall not exceed 30 s. However, for printed circuit boards, it shall not exceed 15 s.</p> <p>The needle-flame test shall not be carried out on parts of material classified as V-0 or V-1 according to AS/NZS 60695.11.10, provided that the sample tested was not thicker than the relevant part.</p>		
4.7.201.4	<p>Addition: Testing in the event of non-extinguishing material</p> <p>If parts, other than enclosures, do not withstand the glow wire tests of 4.7.201.3, by failure to extinguish within 30 s after the removal of the glow-wire tip, the needle-flame test detailed in 4.7.201.3 shall be made on all parts of non-metallic material which are within a distance of 50 mm or which are likely to be impinged upon by flame during the tests of 4.7.201.3. Parts shielded by a separate barrier which meets the needle-flame test need not be tested.</p> <p>NOTE 1 - If the enclosure does not withstand the glow-wire test the equipment is considered to have failed to meet the requirements of Clause 4.7.201 without the need for consequential testing.</p> <p>NOTE 2 - If other parts do not withstand the glow-</p>		N/A

ATTACHMENT 2

IEC60950_1F - ATTACHMENT			
Clause	Requirement + Test	Result - Remark	Verdict
	<p>wire test due to ignition of the tissue paper and if this indicates that burning or glowing particles can fall onto an external surface underneath the equipment, the equipment is considered to have failed to meet the requirements of Clause 4.7.201 without the need for consequential testing.</p> <p>NOTE 3 - Parts likely to be impinged upon by the flame are considered to be those within the envelope of a vertical cylinder having a radius of 10 mm and a height equal to the height of the flame, positioned above the point of the material supporting, in contact with, or in close proximity to, connections.</p>		
4.7.201.5	<p>Addition: Testing of printed boards The base material of printed boards shall be subjected to the needle-flame test of Clause 4.7.201.3. The flame shall be applied to the edge of the board where the heat sink effect is lowest when the board is positioned as in normal use. The flame shall not be applied to an edge, consisting of broken perforations, unless the edge is less than 3 mm from a POTENTIAL IGNITION SOURCE.</p> <p>The test is not carried out if the</p> <ul style="list-style-type: none"> - Printed board does not carry any POTENTIAL IGNITION SOURCE; - Base material of printed boards, on which the available apparent power at a connection exceeds 15 VA operating at a voltage exceeding 50 V and equal or less than 400 V (peak) a.c. or d.c. under normal operating conditions, is of flammability category V-1 or better according to AS/NZS 60695.11.10, or the printed boards are protected by an enclosure meeting the flammability category V-0 according to AS/NZS 60695.11.10, or made of metal, having openings only for connecting wires which fill the openings completely; or - Base material of printed boards, on which the available apparatus power at a connection exceeds 15 VA operating at a voltage exceeding 400 V (peak) a.c. or d.c. under normal operating conditions, and base material of printed boards supporting spark gaps which provides protection against overvoltages, is of flammability category V-0 according to AS/NZS 60695.11.10 or the printed boards are contained in a metal enclosure, having openings only for connecting 		N/A

ATTACHMENT 2

IEC60950_1F - ATTACHMENT			
Clause	Requirement + Test	Result - Remark	Verdict
	NOTE 202 - The 3 kV and 1.5 kV values have been determined considering the low frequency induced voltages from the power supply distribution system.		
7.3	Add the following before the first paragraph: Equipment providing functions that fall only within the scope of AS/NZS 60065 and that incorporate a PSTN interface, are not required to comply with this Clause where the only ports provided on the equipment, in addition to a coaxial cable connection and a PSTN interface, are audio or video ports and analogue or data ports not intended to be used for telecommunication purposes.	Not connected to cable distribution system.	N/A
Annex P	Add the following Normative References: AS/NZS 3191, Electric flexible cords AS/NZS 3112, Approval and test specification—Plugs and socket-outlets		N/A
Index	replace the reference to AS/NZS 2211.1 with references to AS/NZS 60825.1 and AS/NZS 60825.2: AS/NZS 60825.1..... 4.3.13.5.1 AS/NZS 60825.2 4.3.13.5.1		N/A

ATTACHMENT 2

IEC60950_1F - ATTACHMENT			
Clause	Requirement + Test	Result - Remark	Verdict

<p>ATTACHMENT TO TEST REPORT IEC 60950-1 with A1:2009 and A2:2013 CANADA NATIONAL DIFFERENCES Information technology equipment – Safety – Part 1: General requirements</p>
<p>Differences according to.....: CAN/CSA-C22.2 No. 60950-1-07, Amd 1:2011, Amd 2:2014</p>
<p>Attachment Form No.....: CA_ND_IEC60950_1F</p>
<p>Attachment Originator.....: CSA</p>
<p>Master Attachment.....: Date (2015-05)</p>
<p>Copyright © 2015 IEC System for Conformity Testing and Certification of Electrical Equipment (IECEE), Geneva, Switzerland. All rights reserved.</p>

1.1.1	All equipment is to be designed to allow installation in accordance with the National Electrical Code (NEC), ANSI/NFPA 70, the Canadian Electrical Code (CEC), Part I, CAN/CSA C22.1, and when applicable, the National Electrical Safety Code, IEEE C2. Also, unless marked or otherwise identified, installation is allowed per the Standard for the Protection of Electronic Computer/Data-Processing Equipment, ANSI/NFPA 75.		P
1.1.2	Baby monitors are required to additionally comply with ASTM F2951, Consumer Safety Specification for Baby Monitors.		N/A
1.4.14	For Pluggable Equipment Type A, the protection in the installation is assumed to be 20A:	Equipment acceptable for connection to ____ A	N/A
1.5.5	For lengths exceeding 3.05 m, external interconnecting flexible cord and cable assemblies are required to be a suitable cable type (e.g., DP, CL2) specified in the CEC/NEC. For lengths 3.05 m or less, external interconnecting flexible cord and cable assemblies that are not types specified in the CEC/NEC are required to have special construction features and identification markings.	See component list ____ for Cable Type used.	N/A

ATTACHMENT 2

IEC60950_1F - ATTACHMENT			
Clause	Requirement + Test	Result - Remark	Verdict
1.7.1	Equipment for use on a.c. mains supply systems with a neutral and more than one phase conductor (e.g. 120/240 V, 3-wire) require a special marking format for electrical ratings. A voltage rating that exceeds an attachment plug cap rating is only permitted if it does not exceed the extreme operating conditions in Table 2 of CAN/CSA C22.2 No. 235, and if it is part of a range that extends into the Table 2 "Normal Operating Conditions." Likewise, a voltage rating shall not be lower than the specified "Normal Operating Conditions," unless it is part of a range that extends into the "Normal Operating Conditions."	See main TRF cl 1.7.1	N/A
1.7.7	Wiring terminals intended to supply Class 2 outputs in accordance with CEC Part 1 or NEC shall be marked with the voltage rating and "Class 2" or equivalent. Marking shall be located adjacent to the terminals and shall be visible during wiring.		N/A
2.5	Where a fuse is used to provide Class 2, Limited Power Source, or TNV current limiting, it shall not be operator-accessible unless it is not interchangeable.		N/A
2.6	Equipment with isolated ground (earthing) receptacles are required to comply with NEC 250.146(D) and CEC 10-112 and 10-906(8).		N/A
2.7.1	Suitable NEC/CEC branch circuit protection rated at the maximum circuit rating is required for all standard supply outlets and receptacles (such as supplied in power distribution units) if the supply branch circuit protection is not suitable. Power distribution transformers distributing power at 100 volts or more, and rated 10 kVA or more, require special transformer overcurrent protection.		N/A
3.2	Wiring methods (terminals, leads, etc.) used for the connection of the equipment to the mains shall be in accordance with the NEC/CEC.		N/A
3.2.1	Power supply cords are required to have attachment plugs rated not less than 125 percent of the rated current of the equipment.		N/A

ATTACHMENT 2

IEC60950_1F - ATTACHMENT			
Clause	Requirement + Test	Result - Remark	Verdict
3.2.1.2	Equipment connected to a centralized d.c. power system, and having one pole of the DC mains input terminal connected to the main protective earthing terminal in the equipment, is required to comply with special earthing, wiring, marking and installation instruction requirements.	See Fig/III ____ for marking. See Attachment ____ for installation instruction	N/A
3.2.3	Permanent connection of equipment to the mains supply by a power supply cord is not permitted, except for certain equipment, such as ATMs.		N/A
3.2.5	Power supply cords are required to be no longer than 4.5 m in length. Minimum cord length is required to be 1.5 m, with certain constructions such as external power supplies allowed to consider both input and output cord lengths into the requirement. Flexible power supply cords are required to be compatible with Article 400 of the NEC, and Tables 11 and 12 of the CEC.		N/A
3.2.9	Permanently connected equipment is required to have a suitable wiring compartment and wire bending space.	See Illustration ____ for wire bending space.	N/A
3.3	Wiring terminals and associated spacings for field wiring connections shall comply with CSA C22.2 No. 0		N/A
3.3.3	Wire binding screws are not permitted to attach conductors larger than 10 AWG (5.3 mm ²).	Wire binding screw ____ AWG.	N/A
3.3.4	Terminals for permanent wiring, including protective earthing terminals, are required to be suitable for US/Canadian wire gauge sizes, rated 125 percent of the equipment rating, and be specially marked when specified (1.7.7).		N/A
3.3.5	First column of Table 3E revised to require "Smaller of the RATED CURRENT of the equipment or the PROTECTIVE CURRENT RATING of the circuit under consideration."		N/A
3.4.2	Motor control devices are required for cord-connected equipment with a motor if the equipment is rated more than 12 A, or if the motor has a nominal voltage rating greater than 120 V, or is rated more than 1/3 hp (locked rotor current over 43 A).		N/A
3.4.8	Vertically-mounted disconnect switches and circuit breakers are required to have the "on" position indicated by the handle in the up position.		N/A

ATTACHMENT 2

IEC60950_1F - ATTACHMENT			
Clause	Requirement + Test	Result - Remark	Verdict
3.4.11	For computer room applications, equipment with battery systems capable of supplying 750 VA for five minutes are required to have a battery disconnect means that may be connected to the computer room remote power-off circuit.		N/A
4.3.12	The maximum quantity of flammable liquid stored in equipment is required to comply with NFPA 30.		N/A
4.3.13.5.1	Equipment with lasers is required to meet the U.S. Code of Federal Regulations 21 CFR 1040 (and the Canadian Radiation Emitting Devices Act, REDR C1370).		N/A
4.7	For computer room applications, automated information storage systems with combustible media greater than 0.76 m ³ (27 cu ft) are required to have a provision for connection of either automatic sprinklers or a gaseous agent extinguishing system with an extended discharge.		N/A
4.7.3.1	For computer room applications, enclosures with combustible material measuring greater than 0.9 m ² (10 sq ft) or a single dimension greater than 1.8 m (6 ft) are required to have a flame spread rating of 50 or less. For other applications, enclosures with the same dimensions require a flame spread rating of 200 or less.	Material: _____ Flame spread rating _____	N/A
	Non-metallic enclosures of equipment for use in spaces used for environmental air (plenums) are required to comply with UL 2043.		N/A
Annex H	Equipment that produces ionizing radiation is required to comply with the U.S. Code of Federal Regulations, 21 CFR 1020 (and the Canadian Radiation Emitting Devices Act, REDR C1370).		N/A
OTHER DIFFERENCES			
The following key national differences are based on requirements other than national regulatory requirements.			

ATTACHMENT 2

IEC60950_1F - ATTACHMENT			
Clause	Requirement + Test	Result - Remark	Verdict
1.5.1	Some components and materials associated with the risk of fire, electric shock, or personal injury are required to have component or material ratings in accordance with the applicable national (Canadian and/or U.S.) component or material standard requirements. These components include: attachment plugs, battery packs (rechargeable type, used with transportable equipment), cathode ray tubes, circuit breakers, communication circuit accessories, connectors (used for current interruption of non-LPS circuits), cord sets and power supply cords, direct plug-in equipment, enclosures (outdoor), flexible cords and cables, fuses (branch circuit), fuseholders, ground-fault current interrupters, industrial control equipment, insulating tape, interconnecting cables, lampholders, limit controls, printed wiring, protectors for communications circuits, receptacles, solid state controls, supplementary protectors, switches (including interlock switches), thermal cutoffs, thermostats, (multi-layer) transformer winding wire, transient voltage surge suppressors, tubing, wire connectors, and wire and cables.	See safety component list	P
1.6.1.2	A circuit for connection to the DC Mains Supply is classified as either a SELV Circuit, TNV-2 Circuit or Hazardous Voltage Circuit depending on the maximum operating voltage of the supply. This maximum operating voltage shall include consideration of the battery charging "float voltage" associated with the intended supply system, regardless of the marked power rating of the equipment.	Evaluated for Max operating voltage ____V. Classified as ____	—
2.3.1	For TNV-2 and TNV-3 circuits with other than ringing signals and with voltages exceeding 42.4 Vpeak or 60 Vd.c., the maximum acceptable current through a 2000 ohm resistor (or greater) connected across the voltage source with other loads disconnected is 7.1 mA peak or 30 mA d.c. under normal operating conditions.	Measured max current ____ mA	N/A
2.3.2.1	In the event of a single fault between TNV and SELV circuits, the limits of 2.2.3 apply to SELV Circuits and accessible conductive parts.		N/A
2.6.2	Equipment with functional earthing is required to be marked with the functional earthing symbol (IEC 60417-6092).		N/A
2.6.3.4	Protective bonding conductors of non-standard protective bonding constructions (e.g., printed circuit traces) may be subjected to the additional limited short circuit test conditions specified.	____A conducted between ____ and ____.	N/A

ATTACHMENT 2

IEC60950_1F - ATTACHMENT			
Clause	Requirement + Test	Result - Remark	Verdict
4.2.8.1	Enclosures around CRTs with a face diameter of 160 mm or more are required to reduce the risk of injury due to the implosion of the CRT.		N/A
4.3.2	Equipment with handles is required to comply with special loading tests.	Test load applied: ____KG.	N/A
4.3.8	Battery packs for both portable and stationary applications are required to comply with special component requirements.		N/A
5.1.8.3	Equipment intended to receive telecommunication ringing signals is required to comply with a special touch current measurement tests.		N/A
5.3.7	Internal (e.g., card cage) SELV circuit connectors and printed wiring board connectors that are accessible to the operator and that deliver power are to be overloaded. During abnormal operating testing, if a circuit is interrupted by the opening of a component, the test shall be repeated twice (three tests total) using new components as necessary.	See attached data	P
6.4	Equipment intended for connection to telecommunication network outside plant cable is required to be protected against overvoltage from power line crosses in accordance with 6.4 and Annex NAC.	See attached data	N/A
Annex EE	UL articulated accessibility probe (Fig EE.3) required for assessing accessibility to document/media shredders instead of the Figure 2A test finger.		N/A
M.2	Continuous ringing signals up to 16 mA only are permitted if the equipment is subjected to special installation and performance restrictions.		N/A
Annex NAD	Equipment connected to a telecommunication and cable distribution networks and supplied with an earphone intended to be held against, or in the ear is required to comply with special acoustic pressure requirements.	See attached data	N/A



ATTACHMENT 2

IEC60950_1F - ATTACHMENT			
Clause	Requirement + Test	Result - Remark	Verdict

<p>ATTACHMENT TO TEST REPORT IEC 60950-1 CHINA NATIONAL DIFFERENCES Information technology equipment – Safety – Part 1: General requirements</p>	
Differences according to.....:	GB 4943.1-2011
Attachment Form No.....:	CN_ND_IEC60950_1A
Attachment Originator	CQC-TIRT
Master Attachment	Date 2012-11
<p>Copyright © 2010 IEC System for Conformity Testing and Certification of Electrical Equipment (IECEE), Geneva, Switzerland. All rights reserved.</p>	

	China National Differences		
1.5. 2	Add a note behind the first dashed paragraph. Note: A component used shall comply with related requirements corresponding altitude of 5000m.	Added. Shall be provided accordingly during national approval.	N/A
1.7	Add a paragraph before the last paragraph: The required marking and instruction should be given in normative Chinese unless otherwise specified.	Added. Shall be provided accordingly during national approval.	N/A
1.7.1	Amend dashed paragraph at the fifth paragraph : The RATED VOLTAGE should be 220V (single phase) or 380V (three-phases) for single rated voltage, for RATED VOLTAGE RANGE, it should cover 220V or 380V (three-phases), for multiple RATED VOLTAGES, one of them should be 220V or 380V (three-phases) and set on 220V or 380V (three-phases) when manufactured. And the RATED FREQUENCY or RATED FREQUENCY RANGE should be 50Hz or include 50Hz.		N/A

ATTACHMENT 2

IEC60950_1F - ATTACHMENT			
Clause	Requirement + Test	Result - Remark	Verdict
1.7.2.1	<p>Add requirements of warning for equipment intended to be used at altitude not exceeding 2000m or at non-tropical climate regions:</p> <p>For equipment intended to be used at altitude not exceeding 2000m, a warning label containing the following or a similar appropriate wording, or a symbol as in annex DD shall fixed to the equipment at readily visible place.</p> <p>"Only used at altitude not exceeding 2000m."</p>  <p>For equipment intended to be used in not-tropical climate regions, a warning label containing the following or a similar appropriate wording, or a symbol as in annex DD shall fixed to the equipment at readily visible place.</p> <p>"Only used in not-tropical climate regions."</p>  <p>If only the symbol used, the explanation of the symbol shall be contained in the instruction manual.</p> <p>The above statements shall be given in a language acceptable to the regions where the apparatus is intended to be used.</p>	<p>Added.</p> <p>Shall be provided accordingly during national approval.</p>	N/A
2.7.1	<p>Amended the first paragraph as:</p> <p>Protection in PRIMARY CIRCUITS against overcurrent short-circuits and earth faults shall be provided as an integral part of the equipment except special provisions. And the protective device shall meet the requirement of Clause 5.3.</p> <p>Delete note of Clause 2.7.1.</p>		N/A



ATTACHMENT 2

IEC60950_1F - ATTACHMENT			
Clause	Requirement + Test	Result - Remark	Verdict
2.9.2	<p>First section of Clause 2.9.2 amended as two sections:</p> <p>Where required by 2.9.1, 2.10.8.3, 2.10.10 or 2.10.11, humidity conditioning is conducted for 120 h in a cabinet or room containing air with ambient temperature 40±2°C and a relative humidity of (93±3)%. During this conditioning the component or subassembly is not energized.</p> <p>For equipment not to be operated at tropical climatic conditions, Where required by 2.9.1, 2.10.8.3, 2.10.10 or 2.10.11, humidity conditioning is conducted for 48 h in a cabinet or room containing air with a relative humidity of (93±3) %.</p> <p>The temperature of the air, at all places where samples can be located, is maintained within 2 °C of any convenient value between 20 °C and 30 °C such that condensation does not occur.</p> <p>Due to pretreatment of equipment operated at high altitude area is humidity conditioning withstand hot shock, specific requirements are to be considered.</p> <p>Add note: For equipment to be operated at 2000 m - 5000m above sea level, assessment and requirement of humidity conditioning for Insulation material properties are considered.</p>	<p>Added.</p> <p>Shall be provided accordingly during national approval.</p>	N/A
2.10.3.1	<p>Amend the third paragraph of Clause 2.10.3.1 to be:</p> <p>These requirements apply for equipment to be operated up to 2000 m above sea level. For equipment to be operated at more than 2000 m above sea level and up to 5000m above sea level, the minimum CLEARANCE shall be multiplied by the factor 1.48 corresponding altitude of 5000m given in Table A.2 of IEC 60664-1. For equipment to be operated at more than 5000 m above sea level, the minimum CLEARANCE shall be multiplied by the factor given in Table A.2 of IEC 60664-1. Linear interpolation is permitted between the nearest two points in Table A.2. The calculated minimum CLEARANCE using this multiplication factor shall be rounded up to the next higher 0,1 mm increment.</p>	<p>Added.</p> <p>Shall be provided accordingly during national approval.</p>	N/A
2.10.3.3& 2.10.3.4	<p>Add "(applicable for altitude up to 2000m)" in header of Table 2K、2L and 2M.</p>		N/A

ATTACHMENT 2

IEC60950_1F - ATTACHMENT			
Clause	Requirement + Test	Result - Remark	Verdict
2.10.3.4	Add a new section above Table 2K and in Clause 2.10.3.4: Minimum CLEARANCES determined by above rules apply for equipment to be operated up to 2000m above sea level. For equipment operated at 2000 m - 5000m above sea level, the minimum CLEARANCE shall be multiplied by the factor 1.48 corresponding altitude of 5000m given in Table A.2 of GB/T16935.1 (IEC 60664-1) . For equipment to be operated at more than 5000 m above sea level, the minimum CLEARANCE shall be multiplied by the factor given in Table A.2 of GB/T16935.1.		N/A
3.2.1.1	Add a paragraph before the last paragraph: Plugs connected to AC mains supply shall comply with GB 1002 or GB 1003 or GB/T 11918 as applicable.		N/A
4.2.8	Clause 4.2.8 cathode ray tubes quoted Clause 18 of GB8898-2011. Delete note of Clause 4.2.8.	No CRT.	N/A
Annex E	Amend last section: For comparison of winding temperatures determined by the resistance method of this annex with the temperature limits of Table 4B, 35 °C shall be added to the calculated temperature rise. Add note: for equipment not to be operated at tropical climatic conditions, 25 °C shall be added to the calculated temperature rise to compare with the temperature of Table 4B.	Amended.	N/A
Annex G.6	Change the second section of Clause G.6 to be: For equipment to be operated at 2000 m - 5000m above sea level, the minimum CLEARANCE shall be multiplied by the factor 1.48 corresponding altitude of 5000m given in Table A.2 of GB/T16935.1. For equipment to be operated at more than 5000 m above sea level, the minimum CLEARANCE shall be multiplied by the factor given in Table A.2 of IEC 60664-1. Linear interpolation is permitted between the nearest two points in Table A.2. The calculated minimum CLEARANCE using this multiplication factor shall be rounded up to the next higher 0,1 mm increment.	Changed. The alternative method was not considered.	N/A

ATTACHMENT 2

IEC60950_1F - ATTACHMENT			
Clause	Requirement + Test	Result - Remark	Verdict
Annex DD (normative)	<p>Added annex DD: Instructions for the new safety warning labels.</p> <p>DD.1 Altitude warning label </p> <p>Meaning of the label: Evaluation for apparatus only based on altitude not exceeding 2000m, therefore it's the only operating condition applied for the equipment. There may be some potential safety hazard if the equipment is used at altitude above 2000m.</p> <p>DD.2 Climate warning label </p> <p>Meaning of the label: Evaluation for apparatus only based on temperate climate condition, therefore it's the only operating condition applied for the equipment. There may be some potential safety hazard if the equipment is used in tropical climate region.</p>	<p>Added.</p> <p>Shall be provided accordingly during national approval.</p>	N/A
Annex EE (informative)	<p>Added annex EE:</p> <p>Illustration relative to safety explanation in normative Chinese、Tibetan、Mongolian、Zhuang Language and Uighur.</p>	<p>Added.</p> <p>Shall be provided accordingly during national approval.</p>	N/A

Special national conditions			
1.1.2	<p>GB4943.1-2011 applies to equipment used at altitudes not exceeding 5000m above sea level, primarily in regions with moderate or tropical climates.</p> <p>Revise the third dashed paragraph of 1.1.2 as: ——equipment intended to be used in vehicles, on board ships or aircraft, at altitudes greater than 5000m;</p>		N/A
1.4.5	<p>Amend the second paragraph by the following: If the equipment is intended for direct connection to an AC mains supply, the tolerances on RATED VOLTAGE shall be taken as +10% and -10%.</p>		N/A

ATTACHMENT 2

IEC60950_1F - ATTACHMENT			
Clause	Requirement + Test	Result - Remark	Verdict
1.4.12.1	<p>Tma: The maximum ambient temperature permitted by the manufacturer's specification, or 35 °C, whichever is greater.</p> <p>Add note 1: For equipment not to be operated at tropical climatic conditions, Tma is the maximum ambient temperature permitted by the manufacturer's specification, or 25 °C, whichever is greater.</p> <p>Add note 2: For equipment to be operated at 2000m-5000m above sea level, its temperature test conditions and temperature limits are under consideration.</p>	<p>The manufacturer specified ambient temperature of the equipment is 45 °C.</p> <p>However, shall be provided accordingly during national approval.</p>	N/A

ATTACHMENT 2

IEC60950_1F - ATTACHMENT			
Clause	Requirement + Test	Result - Remark	Verdict

<p>ATTACHMENT TO TEST REPORT IEC 60950-1 FINLAND NATIONAL DIFFERENCES Information technology equipment – Safety – Part 1: General requirements</p>	
Differences according to:	EN 60950-1:2006/A11:2009/A1:2010
Attachment Form No:	FI_ND_IEC60950_1C
Attachment Originator:	SGS Fimko Ltd
Master Attachment:	Date (2010-04)
<p>Copyright © 2010 IEC System for Conformity Testing and Certification of Electrical Equipment (IECEE), Geneva, Switzerland. All rights reserved.</p>	

	National Differences	
General	See also Group Differences (EN 60950-1:2006/A11/A1)	P
1.5.7.1	In Finland resistors bridging BASIC INSULATION in CLASS I PLUGGABLE EQUIPMENT TYPE A must comply with the requirements in 1.5.7.1. In addition when a single resistor is used, the resistor must withstand the resistor test in 1.5.7.2.	N/A
1.5.9.4	In Finland , the third dashed sentence is applicable only to equipment as defined in 6.1.2.2 of this annex.	N/A
1.7.2.1	In Finland , CLASS I PLUGGABLE EQUIPMENT TYPE A intended for connection to other equipment or a network shall, if safety relies on connection to protective earth or if surge suppressors are connected between the network terminals and accessible parts, have a marking stating that the equipment must be connected to an earthed mains socket-outlet. The marking text in in Finland shall be as follows: "Laite on liitettävä suojakoskettimilla varustettuun pistorasiaan"	N/A
2.3.2	In Finland , there are additional requirements for the insulation. See 6.1.2.1 and 6.1.2.2 of this annex.	N/A
2.10.5.13	In Finland , there are additional requirements for the insulation, see 6.1.2.1 and 6.1.2.2 of this annex.	N/A

ATTACHMENT 2

IEC60950_1F - ATTACHMENT			
Clause	Requirement + Test	Result - Remark	Verdict
5.1.7.1	<p>In Finland, TOUCH CURRENT measurement results exceeding 3,5 mA r.m.s. are permitted only for the following equipment:</p> <ul style="list-style-type: none"> • STATIONARY PLUGGABLE EQUIPMENT TYPE A that <ul style="list-style-type: none"> - is intended to be used in a RESTRICTED ACCESS LOCATION where equipotential bonding has been applied, for example, in a telecommunication centre; and - has provision for a permanently connected PROTECTIVE EARTHING CONDUCTOR; and - is provided with instructions for the installation of that conductor by a SERVICE PERSON; • STATIONARY PLUGGABLE EQUIPMENT TYPE B; • STATIONARY PERMANENTLY CONNECTED EQUIPMENT. 		N/A
6.1.2.1 (A1:2010)	<p>In Finland, add the following text between the first and second paragraph of the compliance clause:</p> <p>If this insulation is solid, including insulation forming part of a component, it shall at least consist of either</p> <ul style="list-style-type: none"> - two layers of thin sheet material, each of which shall pass the electric strength test below, or - one layer having a distance through insulation of at least 0,4 mm, which shall pass the electric strength test below. <p>Alternatively for components, there is no distance through insulation requirement for the insulation consisting of an insulating compound completely filling the casing, so that CLEARANCES and CREEPAGE DISTANCES do not exist, if the component passes the electric strength test in accordance with the compliance clause below and in addition</p> <ul style="list-style-type: none"> - passes the tests and inspection criteria of 2.10.11 with an electric strength test of 1,5 kV multiplied by 1,6 (the electric strength test of 2.10.10 shall be performed using 1,5 kV), and - is subject to ROUTINE TESTING for electric strength during manufacturing, using a test voltage of 1,5 kV. 		N/A

ATTACHMENT 2

IEC60950_1F - ATTACHMENT			
Clause	Requirement + Test	Result - Remark	Verdict
	<p>It is permitted to bridge this insulation with an optocoupler complying with 2.10.5.4 b).</p> <p>It is permitted to bridge this insulation with a capacitor complying with EN 60384-14:2005, subclass Y2.</p> <p>A capacitor classified Y3 according to EN 60384-14:2005, may bridge this insulation under the following conditions:</p> <ul style="list-style-type: none"> - the insulation requirements are satisfied by having a capacitor classified Y3 as defined by EN 60384-14:2005 which in addition to the Y3 testing, is tested with an impulse test of 2,5 kV defined in EN 60950-1:2006, 6.2.2.1; - the additional testing shall be performed on all the test specimens as described in EN 60384-14:2005; - the impulse test of 2,5 kV is to be performed before the endurance test in EN 60384-14:2005, in the sequence of tests as described in EN 60384-14:2005. 		N/A
6.1.2.2	<p>In Finland, the exclusions are applicable for PERMANENTLY CONNECTED EQUIPMENT, PLUGGABLE EQUIPMENT TYPE B and equipment intended to be used in a RESTRICTED ACCESS LOCATION where equipotential bonding has been applied, e.g. in a telecommunication centre, and which has provision for a permanently connected PROTECTIVE EARTHING CONDUCTOR and is provided with instructions for the installation of that conductor by a SERVICE PERSON.</p>		N/A
7.2	<p>In Finland, for requirements see 6.1.2.1 and 6.1.2.2 of this annex.</p> <p>The term TELECOMMUNICATION NETWORK in 6.1.2 being replaced by the term CABLE DISTRIBUTION SYSTEM.</p>		N/A

ATTACHMENT 2

IEC60950_1F - ATTACHMENT			
Clause	Requirement + Test	Result - Remark	Verdict

<p>ATTACHMENT TO TEST REPORT IEC 60950-1 GERMANY NATIONAL DIFFERENCES Information technology equipment – Safety – Part 1: General requirements</p>

<p>Differences according to.....: VDE 0805-1:2011-01</p>

	National Differences		N/A
Annex ZC, 1.7.2.1	According to GPSG, section 2, clause 4: If certain rules on the use, supplementation or maintenance of an item of technical work equipment or ready-to-use commodity must be observed in order to guarantee safety and health, instructions for use in German must be supplied when it is brought into circulation.		N/A

ATTACHMENT 2

IEC60950_1F - ATTACHMENT			
Clause	Requirement + Test	Result - Remark	Verdict

<p>ATTACHMENT TO TEST REPORT IEC 60950-1 ISRAEL NATIONAL DIFFERENCES Information technology equipment – Safety – Part 1: General requirements</p>
--

Differences according to.....: SI 60950 Part 1

	Special national conditions		N/A
1.1.1	Replace the the text of Note 3 as follows: The requirements of Israel Standard SI 60065 may also be used to meet safety requirements for multimedia equipment. See IEC Guide 112, Guide on the safety of multimedia equipment.	Replaced.	N/A
1.6	The clause is applicable with the following addition:	Overall acceptance has to be evaluated during the national approval process.	N/A
1.6.1	Add following note: In Israel, this clause is applicable subject to the Electricity Law, 1954, its regulations and revisions.	Overall acceptance has to be evaluated during the national approval process.	N/A
1.7	The clause is applicable with the following additions: Subclause 1.7.201 shall be added at the beginning of the clause as follows:	Added.	P
1.7.201	Marking in the Hebrew language The marking in the Hebrew language shall be in accordance with the Consumer Protection Order (Marking of goods), 1983. In addition to the marking required by clause 1.7.1, the following details shall be marked in the Hebrew language. The details shall be marked on the apparatus or on its package, or on a label properly attached to the apparatus or on the package, by bonding or sewing, in a manner that the label cannot be easily removed. 1. Name of the apparatus and it commercial designation; 2. Manufacturer's name and address. If the apparatus is imported, the importer's name and address; 3. Manufacturer's registered trademark, if any; 4. Name of the model and serial number, if any; 5. Country of manufacture.	Overall acceptance has to be evaluated during the national approval process.	N/A
1.7.2.1	The following shall be added to the clause: All the instructions and warnings related to safety shall also be written in the Hebrew language.	Overall acceptance has to be evaluated during the national approval process.	N/A

ATTACHMENT 2

IEC60950_1F - ATTACHMENT			
Clause	Requirement + Test	Result - Remark	Verdict
2	The clause is applicable with the following additions:		P
2.9.4	The following shall be added at the beginning of the clause: In Israel, according to the Electricity Law, 1954, and the Electricity Regulations (Earthing and means of protection against electricity of voltages up to 1,000V) 1991, seven means of protection against electrocution are permitted, as follows: 1) TN-S - Network system earthing; TN-C-S - Network system earthing; 2) TT - Network system earthing; 3) IT - Network Insulation Terre; 4) Isolated transformer; 5) Safety extra low voltage (SELV or ELV); 6) Residual current circuit breaker (30 mA = I _R); 7) Reinforced insulation; Double insulation (class II)	Added.	P
2.201	Prevention of electromagnetic interference - Prior to carrying out the tests in accordance with the clauses of this Standard, the compliance of the apparatus with the relevant requirements specified in the appropriate part of the Standard series, SI 961, shall be checked. The apparatus shall meet the requirements in the appropriate part of the Standard series, SI 961. - If there are components in the apparatus for the prevention of electromagnetic interference, these components shall not reduce the safety level of the apparatus as required by this Standard.	Overall acceptance has to be evaluated during the national approval process.	N/A
3	The clause is applicable with the following additions:	Added.	N/A
3.2.1.1	Connection to an a.c. mains supply After the note, the following note shall be added: Note: In Israel, the feed plug shall comply with the requirements of Israel Standard SI 32 Part 1.1.	Overall acceptance has to be evaluated during the national approval process.	N/A
3.2.1.2	Connection to a d.c. mains supply At the end of the first paragraph, the following note shall be added: Note: At the time of issue of this Standard, there is no Israel Standard for connection accessories to d.c.		N/A
Annex P	Normative references (List of relevant Israel Standards that have been inserted in place of some of the International Standards)		P

ATTACHMENT 2

IEC60950_1F - ATTACHMENT			
Clause	Requirement + Test	Result - Remark	Verdict

<p>ATTACHMENT TO TEST REPORT IEC 60950-1 KOREA NATIONAL DIFFERENCES Information technology equipment – Safety – Part 1: General requirements</p>

<p>Differences according to.....: K 60950-1</p>

	Special national conditions		N/A
1.5.101	Plugs for the connection of the apparatus to the supply mains shall comply with the Korean requirement (KSC 8305).	No power cord provided.	N/A
8	EMC The apparatus shall comply with the relevant CISPR standards.	The CISPR requirements have to be considered during national approval.	N/A

ATTACHMENT 2

IEC60950_1F - ATTACHMENT			
Clause	Requirement + Test	Result - Remark	Verdict

<p>ATTACHMENT TO TEST REPORT IEC 60950-1 with A1: 2009 and A2:2013 U.S.A. NATIONAL DIFFERENCES Information technology equipment – Safety – Part 1: General requirements</p>			
Differences according to : UL 60950-1-07(Second Edition) + A1: 2011 + A2: 2014			
Attachment Form No..... : US_ND_IEC60950_1F			
Attachment Originator : UL			
Master Attachment : Date 2014-07			
Copyright © 2014 IEC System for Conformity Testing and Certification of Electrical Equipment (IECEE), Geneva, Switzerland. All rights reserved.			

	Special national conditions		P
1.1.1	All equipment is designed as to allow installation in accordance with the National Electrical Code (NEC), ANSI/NFPA 70, Canadian Electrical Code (CEC), Part I, CAN/CSA C22.1, and if applicable, the National Electrical Safety Code, IEEE C2	Unit was evaluated according to IEC 60950-1. The requirements have to be checked during national approval.	N/A
	Also, unless marked or otherwise identified, installation is allowed per the Standard for the Protection of Electronic Computer/Data-Processing Equipment, ANSI/NFPA 75		N/A
1.1.2	Baby monitors are required to additionally comply with ASTM F2951, Consumer Safety Specification for Baby Monitors		N/A
1.4.14	For Pluggable Equipment Type A, the protection in the installation is assumed to be 20A	Considered.	P
1.5.5	For lengths exceeding 3.05 m, external interconnecting flexible cord and cable assemblies are required to be a suitable cable type (e.g., DP, CL2) specified in the /NEC		N/A
	For lengths 3.05 m or less, external interconnecting flexible cord and cable assemblies that are not types specified in the NEC are required to have special construction features and identification markings		N/A
1.7.1	Equipment for use on a.c. mains supply systems with a neutral and more than one phase conductor (e.g. 120/240 V, 3-wire) require a special marking format for electrical ratings	Single-phase equipment.	N/A

ATTACHMENT 2

IEC60950_1F - ATTACHMENT			
Clause	Requirement + Test	Result - Remark	Verdict
	A voltage rating that exceeds an attachment plug cap rating is only permitted if it does not exceed the extreme operating conditions in Table 2 of CAN/CSA C22.2 No. 235, and		N/A
	- if it is part of a range that extends into the Table 2 "Normal Operating Conditions"		N/A
	Likewise, a voltage rating is not to be lower than the specified "Normal Operating Conditions," unless it is part of a range that extends into the "Normal Operating Conditions"		N/A
1.7.7	Wiring terminals intended to supply Class 2 outputs in accordance with NEC or CEC Part 1 or NEC are marked with the voltage rating and "Class 2" or equivalent		N/A
	- Marking is located adjacent to the terminals		N/A
	- Marking is visible during wiring		N/A
2.5	Fuse providing Class 2, Limited Power Source, or TNV current limiting is not operator-accessible unless it is not interchangeable		N/A
2.6	Equipment with isolated ground (earthing) receptacles is in compliance with NEC 250.146(D) and CEC 10-112 and 10-906(8)		N/A
2.7.1	Suitable NEC/CEC branch circuit protection rated at the maximum circuit rating is provided for all standard supply outlets and receptacles (such as supplied in power distribution units) if the supply branch circuit protection is not suitable.		N/A
	Power distribution transformers distributing power at 100 volts or more, and rated 10 kVA or more, provided with special transformer overcurrent protection		N/A
3.2	Wiring methods (terminals, leads, etc.) used for the connection of the equipment to the mains is in accordance with the NEC/CEC		N/A
3.2.1	Attachment plugs of power supply cords are rated not less than 125 percent of the rated current of the equipment		N/A
3.2.1.2	Equipment connected to a centralized d.c. power system, and having one pole of the DC mains input terminal connected to the main protective earthing terminal in the equipment comply with special earthing, wiring, marking and installation instruction requirements		N/A

ATTACHMENT 2

IEC60950_1F - ATTACHMENT			
Clause	Requirement + Test	Result - Remark	Verdict
3.2.3	Permanent connection of equipment to the mains supply by a power supply cord is not permitted, except for certain equipment, such as ATMs		N/A
3.2.5	Power supply cords are no longer than 4.5 m in length		N/A
	Minimum cord length is 1.5 m, with certain constructions such as external power supplies allowed to consider both input and output cord lengths into the requirement		N/A
	Flexible power supply cords are compatible with Article 400 of the NEC, and Tables 11 and 12 of the CEC		N/A
3.2.9	Permanently connected equipment has a suitable wiring compartment and wire bending space		N/A
3.3	Wiring terminals and associated spacings for field wiring connections comply with CSA C22.2 No. 0		N/A
3.3.3	Wire binding screws are not attached with conductors larger than 10 AWG (5.3 mm ²)		N/A
3.3.4	Terminals for permanent wiring, including protective earthing terminals, are suitable for Canadian/US wire gauge sizes, are	Overall acceptance has to be evaluated during the national approval process.	N/A
	- rated 125 per cent of the equipment rating, and		N/A
	- are specially marked when specified (1.7.7)		N/A
3.3.5	Revise first column of Table 3E to "Smaller of the RATED CURRENT of the equipment or the PROTECTIVE CURRENT RATING of the circuit under consideration"	See above.	N/A
3.4.2	Motor control devices are provided for cord-connected equipment with a motor if the equipment is rated more than 12 A,	Equipment is not such a device.	N/A
	- or if the motor has a nominal voltage rating greater than 120 V		N/A
	- or is rated more than 1/3 hp (locked rotor current over 43 A)		N/A
3.4.8	Vertically-mounted disconnect switches and circuit breakers have the "on" position indicated by the handle in the up position	No such device incorporated.	N/A
3.4.11	For computer room applications, equipment with battery systems capable of supplying 750 VA for five minutes have a battery disconnect means that may be connected to the computer room remote power-off circuit	Not such application.	N/A

ATTACHMENT 2

IEC60950_1F - ATTACHMENT			
Clause	Requirement + Test	Result - Remark	Verdict
4.3.12	The maximum quantity of flammable liquid stored in equipment complies with NFPA 30	No liquids provided.	N/A
4.3.13.5.1	Equipment with lasers meets the U.S. Code of Federal Regulations 21 CFR 1040 (and the Canadian Radiation Emitting Devices Act, REDR C1370).	No laser provided.	N/A
4.7	For computer room applications, automated information storage systems with combustible media greater than 0.76 m ³ (27 cu ft) have a provision for connection of either automatic sprinklers or a gaseous agent extinguishing system with an extended discharge	Not automated information storage systems.	N/A
4.7.3.1	For computer room applications, enclosures with combustible material measuring greater than 0.9m ² (10 sq ft) or a single dimension greater than 1.8 m (6 ft) have a flame spread rating of 50 or less	No such enclosure.	N/A
	For other applications, enclosures with the same dimensions require a flame spread rating of 200 or less		N/A
4.7.3.1	Non-metallic enclosures of equipment for use in spaces used for environmental air (plenums) are required to comply with UL 2043	No ionizing radiation.	N/A
Annex H	Equipment that produces ionizing radiation complies with U.S. Code of Federal Regulations, 21 CFR 1020 (and the Canadian Radiation Emitting Devices Act, REDR C1370)		N/A
	Other National Differences		P

ATTACHMENT 2

IEC60950_1F - ATTACHMENT			
Clause	Requirement + Test	Result - Remark	Verdict
1.5.1	<p>Some components and materials associated with the risk of fire, electric shock, or personal injury have component or material ratings in accordance with the applicable national (Canadian and/or U.S.) component or material standard requirements.</p> <p>These components include: attachment plugs, battery backup systems, battery packs, cathode ray tubes, circuit breakers, communication circuit accessories, connectors (used for current interruption of non-LPS circuits), cord sets and power supply cords, direct plug-in equipment, electrochemical capacitor modules (energy storage modules with ultracapacitors), enclosures (outdoor), flexible cords and cables, fuses (branch circuit), fuseholders, ground-fault current interrupters, industrial control equipment, insulating tape, interconnecting cables, lampholders, limit controls, printed wiring, protectors for communications circuits, receptacles, solid state controls, supplementary protectors, switches (including interlock switches), thermal cut-offs, thermostats, (multi-layer) transformer winding wire, surge protective devices, tubing, vehicle battery adapters, wire connectors, and wire and cables</p>	<p>UL approved components used. Refer to table 1.5.1 of IEC 60950-1 test report for details.</p>	P
1.6.1.2	<p>A circuit for connection to the DC Mains Supply is classified as a SELV Circuit, TNV-2 Circuit or Hazardous Voltage Circuit depending on the maximum operating voltage of the supply</p>		N/A
	<p>This maximum operating voltage includes consideration of the battery charging "float voltage" associated with the intended supply system, regardless of the marked power rating of the equipment</p>		N/A
2.3.1	<p>For TNV-2 and TNV-3 circuits with other than ringing signals and with voltages exceeding 42.4 V_{peak} or 60 Vd.c., the maximum acceptable current through a 2000 ohm resistor (or greater) connected across the voltage source with other loads disconnected is 7.1 mA peak or 30 mA d.c. under normal operating conditions</p>	<p>No TNV circuits.</p>	N/A
2.3.2.1	<p>In the event of a single fault between TNV and SELV circuits, the limits of 2.2.3 apply to SELV Circuits and accessible conductive parts</p>	<p>No TNV circuits.</p>	N/A
2.6.2	<p>Equipment with functional earthing marked with the functional earthing symbol (IEC 60417-6092)</p>		N/A

ATTACHMENT 2

IEC60950_1F - ATTACHMENT			
Clause	Requirement + Test	Result - Remark	Verdict
2.6.3.4	Protective bonding conductors of non-standard protective bonding constructions (e.g., printed circuit traces) may be subjected to the additional limited short circuit test conditions specified	No such construction.	N/A
4.2.8.1	Enclosures around CRTs with a face diameter of 160 mm or more reduce the risk of injury due to the implosion of the CRT	No CRT.	N/A
4.3.2	Equipment with handles complies with special loading tests		N/A
4.3.8	Battery packs for both portable and stationary applications comply with special component requirements		N/A
5.1.8.3	Equipment intended to receive telecommunication ringing signals comply with a special touch current measurement tests	No TNV circuits.	N/A
5.3.7	Internal (e.g., card cage) SELV circuit connectors and printed wiring board connectors that are accessible to the operator and that deliver power are overloaded	Complied. Refer to table 5.3 of IEC 60950-1 test report for details.	P
	During abnormal operating testing, if a circuit is interrupted by the opening of a component, the test is repeated twice (three tests total) using new components as necessary		N/A
6.4	Equipment intended for connection to telecommunication network outside plant cable is protected against overvoltage from power line crosses in accordance with 6.4 and Annex NAC	No TNV circuits.	N/A
Annex EE	Articulated accessibility probe (Fig EE.3) is used for assessing accessibility to document/media shredders instead of the Figure 2A test finger		N/A
Annex M.2	Continuous ringing signals up to 16 mA only are permitted if the equipment is subjected to special installation and performance restrictions	No TNV circuits.	N/A
Annex NAD	Equipment connected to a telecommunication and cable distribution networks and supplied with an earphone intended to be held against, or in the ear comply with special acoustic pressure requirements	No TNV circuits.	N/A

ATTACHMENT 3

Photographs

<u>Supplement Id</u>	<u>Description</u>
3-01	Overall view – 01
3-02	Overall view – 02
3-03	Overall view – 03
3-04	Overall view – 04

ATTACHMENT 3

Photographs

ID 3-01

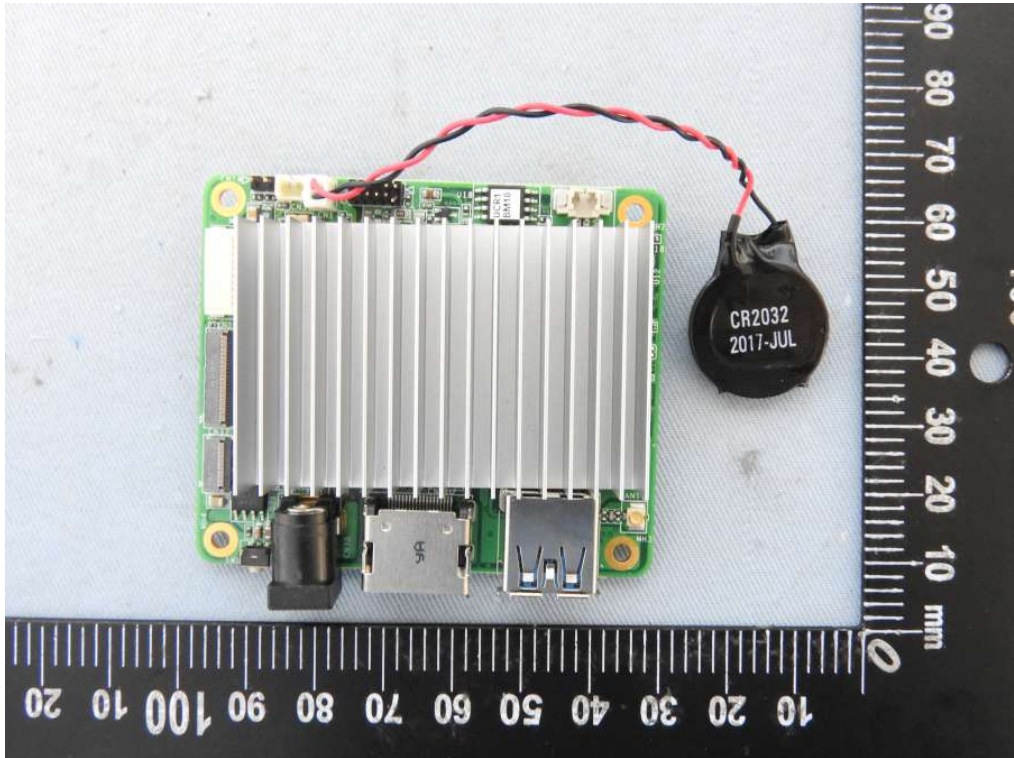

ID 3-02

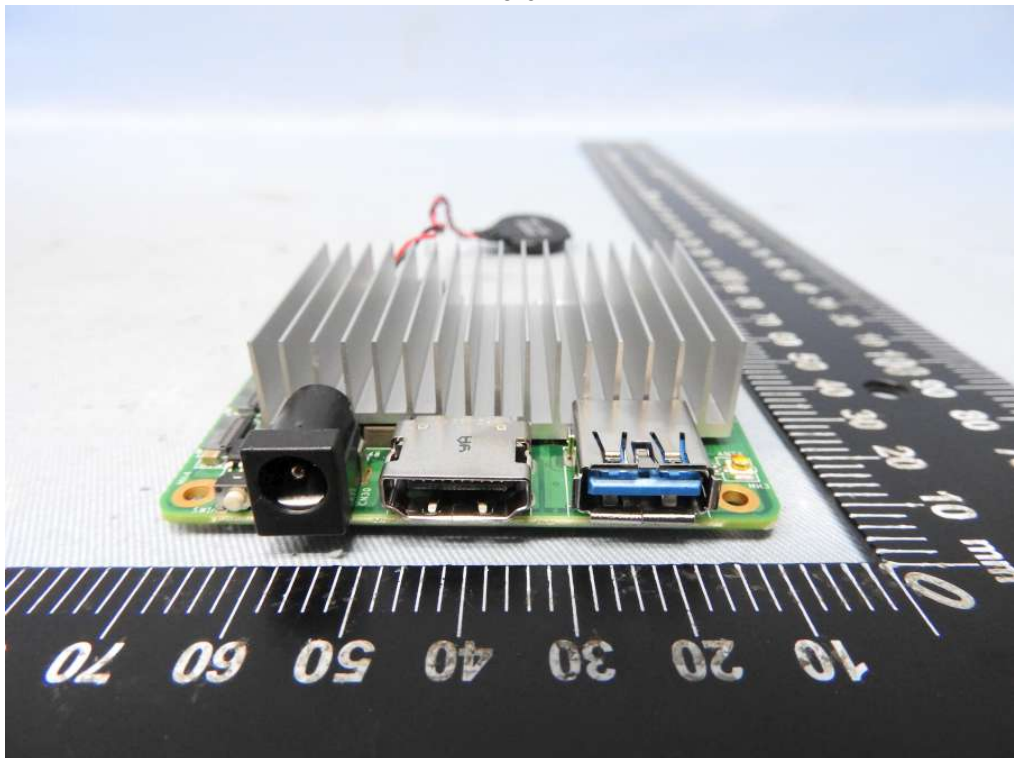

ATTACHMENT 3

Photographs

ID 3-03

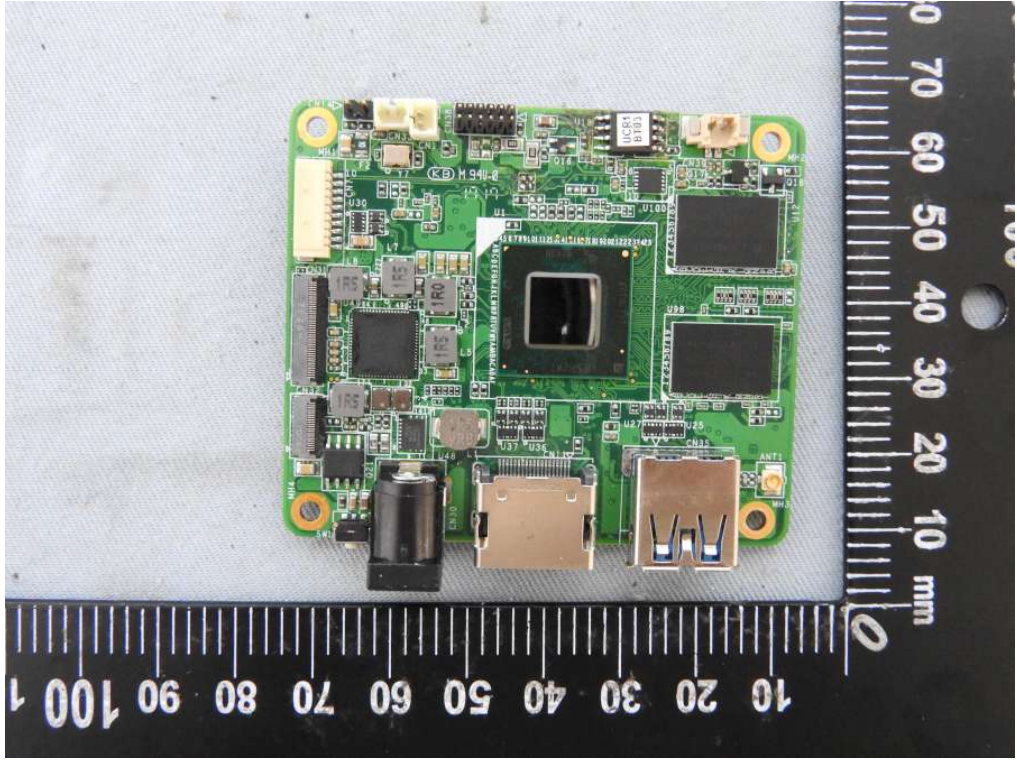

ID 3-04

