

CERTIFICATION OF CONFORMITY



Directive(s):	Low Voltage Directive (2006/95/EC and 2014/35/EU)
Verification No.:	T1601218-820
Applicant / Holder:	AAEON TECHNOLOGY INC
Trade Mark:	Siemens
Product / Test Item:	BOXER-6951
Model / Type Reference:	xBOXER-6951x (x Where x may be any combination of alphanumeric characters or "-" or blank)
Ratings:	Input: 24Vdc, 2.5A

The submitted sample(s) have been tested with the following standard(s) and found to be in compliance with the essential requirements of the Directive(s):

Standard(s)	Test report(s)	Issued by	Date
IEC 60950-1:2005 (Second Edition) + A1:2009 + A2:2013 and/or EN 60950-1:2006+A11:2009+A1:2010 +A12:2011+A2:2013	T1601218-820	Cerpass	2016-03-02

The referred test report(s) show that the product fulfills the essential requirements set out in the Directive(s). On this basis, together with the manufacturer's own documented production control, the manufacturer or his European authorized representative can in his EC Declaration of Conformity verify compliance with the Directive(s). The CE marking could be affixed only when all the relevant and effective EC Directives are complied with.



Miller Chang / Supervisor
2016-03-02

Cerpass Technology Corporation

- No.10, Ln. 2, Lianfu St., Luzhu Dist., Taoyuan City 33848, Taiwan
- No.66, Tangzhuang Rd., Suzhou Industrial Park, Jiangsu 215006, China
- 1F., No.10, Taida Rd., Changan Town, Dongguan City, Guangdong 523850, China



TEST REPORT IEC 60950-1 Information technology equipment – Safety – Part 1: General requirements	
Report Reference No.	T1601218-820
Tested by (printed name and signature)	Cash Peng <i>Cash Peng</i>
Approved by (printed name and signature)	Deborah Pan <i>Deborah Pan</i>
Date of issue	2016-03-02
Testing Laboratory Name	Cerpass Technology Corp.
Address	No.10, Lane 2, Lianfu Street, Luzhu Dist., Taoyuan City 33848, Taiwan
Applicant's name	AAEON TECHNOLOGY INC
Address	5F, NO 135, LANE 235 PAO CHIAO RD, HSIN-TIEN DIST NEW TAIPEI, 231 TAIWAN
Test specification:	
Standard	IEC 60950-1:2005 (Second Edition) + A1:2009 + A2:2013 and/or EN 60950-1:2006+A11:2009+A1:2010+A12:2011+A2:2013
Test procedure	Service of CE Marking in LVD
Non-standard test method	N/A
Test item description	BOXER-6951
Trade Mark	Siemens
Manufacturer	AAEON TECHNOLOGY INC / 5F, NO 135, LANE 235 PAO CHIAO RD, HSIN-TIEN DIST NEW TAIPEI, 231 TAIWAN
Model/Type reference	xBOXER-6951x (x Where x may be any combination of alphanumeric characters or "-" or blank)
Ratings	Input: 24Vdc, 2.5A



Particulars: test item vs. test requirements	
Equipment mobility.....	Movable
Connection to the mains	Not directly connected to the mains
Operating condition.....	Continuous
Access location	Operator accessible
Over voltage category (OVC)	Not directly connected to the mains
Mains supply tolerance (%) or absolute mains supply values	N/A
Tested for IT power systems	No
IT testing, phase-phase voltage (V)	N/A
Class of equipment	Class III
Considered current rating (A)	N/A
Pollution degree (PD)	PD 2
IP protection class	IPX0
Altitude during operation (m)	Up to 2000
Altitude of test laboratory (m)	Up to 2000
Mass of equipment (kg)	4.2 max.
Possible test case verdicts:	
- test case does not apply to the test object	N/A
- test object does meet the requirement.....	P (Pass)
- test object does not meet the requirement.....	F (Fail)
Testing	
Date of receipt of test item	2016-02-03
Date(s) of performance of tests	2016-02-03 to 2016-02-24



General remarks:

The test results presented in this report relate only to the object tested.

This report shall not be reproduced, except in full, without the written approval of the Issuing testing laboratory.

"(see Enclosure #)" refers to additional information appended to the report.

"(see appended table)" refers to a table appended to the report.

Throughout this report a point is used as the decimal separator.

The instructions specified by the standard have to be in official language of each country, however, only English is checked for this report. It is the applicant responsibility to provide instruction in each official language of the EU.

This report is submitted for the exclusive use of the client to whom it is addressed. Its significance is subject to the adequacy and representative character of the sample(s) and to the comprehensiveness of the tests, examinations or surveys made.

This report justified only the submitted samples exclusively and not necessarily implies that all other samples are also to be found in same result.

The CE marking may only be used if all relevant and effective EC directives are complied with.

Factor(ies):

AAEON Technology(Hsin-Tien) Inc
2F, No 2, Lane 235 Pao Chiao Rd , Hsin-Tien Dist New Taipei, 231 Taiwan

General product information:

This equipment, models xBOXER-6951x (x - Where x may be any combination of alphanumeric characters or "-" or blank), is a BOXER-6951 which is intended to use within information technology equipment.

DC 12V output terminal was loaded 0.52A during the test.

All models are identical except model designation for marketing purpose only, and no impact safety related constructions and critical components.

Other comments:

The product was submitted and evaluated for use at the maximum ambient temperature (Tma) permitted by the manufacturer's specification of: 40°C.

Definition of variable(s):

Variable:	Range of variable:	Content:
x	Any combination of alphanumeric characters or "-" or blank	For marketing purpose only, and no impact safety related constructions or critical components.

The artwork below may be only a draft. The use of certification marks on a product must be authorized by the respective NCBs that own these marks.



Copy of marking plate:

The artwork below may be only a draft. The use of certification marks on a product must be authorized by the respective NCBS that own these marks.

(Representative)

BOXER-6951-A01-1010



32. 1840. 921-00 Emb. Ctrl. 1020E. 4GRAM. 1TB. 4COM. 2USB3. 3USB2. 2LAN. 1VGA. 9~30V.

For Siemens

CPU: Celeron 1020E 2.20 GHz

Memory: DDR3 1600 4GB

Electrical rating: DC 24V 2.5A



P0842038



4 7 1 9 6 2 2 1 9 1 6 5 7

L/N: R0804318
MADE IN TAIWAN



IEC 60950-1			
Clause	Requirement + Test	Result - Remark	Verdict
1	GENERAL		P
1.5	Components		P
1.5.1	General	See below.	P
	Comply with IEC 60950-1 or relevant component standard	Components which were found to affect safety aspects comply with the requirements of this standard or within the safety aspects of the relevant IEC component standards. (see appended table 1.5.1)	P
1.5.2	Evaluation and testing of components	Components certified to IEC standards and/or their harmonized standards, are used within their ratings and are checked for correct application. Components, which no relevant IEC-Standard exists, are used within their ratings and are tested under the conditions occurring in the equipment.	P
1.5.3	Thermal controls	No such component provided.	N/A
1.5.4	Transformers	In approved switching power adaptor.	P
1.5.5	Interconnecting cables	Interconnecting cables comply with the relevant requirements of this standard.	P
1.5.6	Capacitors bridging insulation	No such component provided.	N/A
1.5.7	Resistors bridging insulation	No such resistor.	N/A
1.5.7.1	Resistors bridging functional, basic or supplementary insulation		N/A
1.5.7.2	Resistors bridging double or reinforced insulation between a.c. mains and other circuits		N/A
1.5.7.3	Resistors bridging double or reinforced insulation between a.c. mains and antenna or coaxial cable		N/A
1.5.8	Components in equipment for IT power systems	Class III equipment.	N/A
1.5.9	Surge suppressors	No such device within this equipmet.	N/A
1.5.9.1	General		N/A
1.5.9.2	Protection of VDRs		N/A



IEC 60950-1			
Clause	Requirement + Test	Result - Remark	Verdict

1.5.9.3	Bridging of functional insulation by a VDR		N/A
1.5.9.4	Bridging of basic insulation by a VDR		N/A
1.5.9.5	Bridging of supplementary, double or reinforced insulation by a VDR		N/A

1.6	Power interface		P
1.6.1	AC power distribution systems	The equipment is not directly connected to the AC mains supply.	N/A
1.6.2	Input current	Highest load according to 1.2.2.1 for this equipment is Reading/writing data with HDD, USB2.0 ports loaded 2.5W, USB3.0 ports loaded 4.5W, connect to a Monitor and LAN ports are transmitting data continuously. See appended table 1.6.2.	P
1.6.3	Voltage limit of hand-held equipment	This appliance is not a hand-held equipment.	N/A
1.6.4	Neutral conductor	Class III equipment.	N/A

1.7	Marking and instructions		P
1.7.1	Power rating and identification markings	See below.	P
1.7.1.1	Power rating marking	All relevant markings are provided on label except the electrical rating is allowed to not be provided if the equipment is not directly supplied from mains..	P
	Multiple mains supply connections.....:	Not directly supplied from mains.	N/A
	Rated voltage(s) or voltage range(s) (V)	DC 24V (Optional)	P
	Symbol for nature of supply, for d.c. only..... :	⎓ (Optional)	N/A
	Rated frequency or rated frequency range (Hz) ... :	Not directly supplied from AC mains supply.	N/A
	Rated current (mA or A)	2.5A (Optional)	P
1.7.1.2	Identification markings	See below.	P



IEC 60950-1			
Clause	Requirement + Test	Result - Remark	Verdict
	Manufacturer's name or trade-mark or identification mark	Siemens	P
	Model identification or type reference	xBOXER-6951x (x Where x may be any combination of alphanumeric characters or "-" or blank)	P
	Symbol for Class II equipment only	Class III equipment.	N/A
	Other markings and symbols	Additional symbols or marking do not give rise to misunderstanding.	P
1.7.1.3	Use of graphical symbols	Except specified in sub-clause 1.7.8.3, no other graphical symbol is used.	N/A
1.7.2	Safety instructions and marking	See below.	P
1.7.2.1	General	The user's manual contains information for operation, installation, servicing, transport, storage and technical data. The operation guide is provided to the user.	P
1.7.2.2	Disconnect devices	This equipment is not permanently connected equipment or pluggable equipment.	N/A
1.7.2.3	Overcurrent protective device	This equipment is not permanently connected equipment or pluggable equipment.	N/A
1.7.2.4	IT power distribution systems	Class III equipment.	N/A
1.7.2.5	Operator access with a tool	No tool is required to gain access to operator access area.	N/A
1.7.2.6	Ozone	No Ozone provided within the equipment.	N/A
1.7.3	Short duty cycles	Equipment is designed for continuous operation.	N/A
1.7.4	Supply voltage adjustment	No adjustment of supply voltage necessary.	N/A
	Methods and means of adjustment; reference to installation instructions	Same as above.	N/A
1.7.5	Power outlets on the equipment	No outlet provided.	N/A



IEC 60950-1			
Clause	Requirement + Test	Result - Remark	Verdict
1.7.6	Fuse identification (marking, special fusing characteristics, cross-reference)	In approved switching power adaptor.	P
1.7.7	Wiring terminals	No such terminal provided.	N/A
1.7.7.1	Protective earthing and bonding terminals	Class III equipment.	N/A
1.7.7.2	Terminals for a.c. mains supply conductors	Class III equipment.	N/A
1.7.7.3	Terminals for d.c. mains supply conductors	Class III equipment.	N/A
1.7.8	Controls and indicators	See below.	P
1.7.8.1	Identification, location and marking	The marking indication is located that indication of clearly.	P
1.7.8.2	Colours	Colours of the LED indicator are used for functional controls or indicators.	N/A
1.7.8.3	Symbols according to IEC 60417.....	No symbol used.	N/A
1.7.8.4	Markings using figures	No indicators for different positions of control.	N/A
1.7.9	Isolation of multiple power sources	No direct connection to AC mains supply.	N/A
1.7.10	Thermostats and other regulating devices	No such device provided.	N/A
1.7.11	Durability	The label was subjected to the permanence of marking test. The label was rubbed with cloth soaked with water for 15 s and then again for 15 s with the cloth soaked with petroleum spirit. After this test there was no damage to the label. The marking on the label did not fade. There was neither curling nor lifting of the label edge.	P
1.7.12	Removable parts	No removable part provided.	N/A
1.7.13	Replaceable batteries	The RTC battery is exchangeable for service. Warning text provided on servicing instruction.	P
	Language(s)	English	—
1.7.14	Equipment for restricted access locations	No restricted access location.	N/A
2	PROTECTION FROM HAZARDS		P



IEC 60950-1			
Clause	Requirement + Test	Result - Remark	Verdict
2.1	Protection from electric shock and energy hazards		P
2.1.1	Protection in operator access areas	See below.	P
2.1.1.1	Access to energized parts	No access with test finger and test pin to any energized parts. Any energized parts accessible are unlikely.	P
	Test by inspection	Same as above.	P
	Test with test finger (Figure 2A)	Same as above.	P
	Test with test pin (Figure 2B)	Same as above.	P
	Test with test probe (Figure 2C)	No TNV circuits.	N/A
2.1.1.2	Battery compartments	No TNV circuits.	N/A
2.1.1.3	Access to ELV wiring	No ELV wiring in operator accessible area.	N/A
	Working voltage (V_{peak} or V_{rms}); minimum distance through insulation (mm)		—
2.1.1.4	Access to hazardous voltage circuit wiring	No hazardous voltage circuit in operator access area.	N/A
2.1.1.5	Energy hazards	No energy hazard in operator access area.	P
2.1.1.6	Manual controls		N/A
2.1.1.7	Discharge of capacitors in equipment	No direct connection to mains supply.	N/A
	Measured voltage (V); time-constant (s)		—
2.1.1.8	Energy hazards – d.c. mains supply	Not supplied by d.c. mains supply.	N/A
	a) Capacitor connected to the d.c. mains supply ..		N/A
	b) Internal battery connected to the d.c. mains supply :		N/A
2.1.1.9	Audio amplifiers		N/A
2.1.2	Protection in service access areas	No maintenance work in operation mode necessary.	N/A
2.1.3	Protection in restricted access locations	The unit not intended to be used in restricted locations.	N/A
2.2	SELV circuits		P
2.2.1	General requirements	See below.	P



IEC 60950-1			
Clause	Requirement + Test	Result - Remark	Verdict

2.2.2	Voltages under normal conditions (V)	All accessible voltages are less than 42.4Vp or 60Vdc and are classified as SELV.	P
2.2.3	Voltages under fault conditions (V)	Evaluated in approved power adaptor.	P
2.2.4	Connection of SELV circuits to other circuits	See 2.2.2 and 2.2.3. No direct connection between SELV and any primary circuits.	P

2.3	TNV circuits <i>No TNV circuits within the equipment.</i>		N/A
2.3.1	Limits		N/A
	Type of TNV circuits		—
2.3.2	Separation from other circuits and from accessible parts		N/A
2.3.2.1	General requirements		N/A
2.3.2.2	Protection by basic insulation		N/A
2.3.2.3	Protection by earthing		N/A
2.3.2.4	Protection by other constructions		N/A
2.3.3	Separation from hazardous voltages		N/A
	Insulation employed.....		—
2.3.4	Connection of TNV circuits to other circuits		N/A
	Insulation employed.....		—
2.3.5	Test for operating voltages generated externally		N/A

2.4	Limited current circuits <i>No limited current circuits within the equipment.</i>		N/A
2.4.1	General requirements		N/A
2.4.2	Limit values		N/A
	Frequency (Hz).....		—
	Measured current (mA)		—
	Measured voltage (V)		—
	Measured circuit capacitance (nF or μF).....		—
2.4.3	Connection of limited current circuits to other circuits		N/A



IEC 60950-1			
Clause	Requirement + Test	Result - Remark	Verdict

2.5	Limited power sources		P
	a) Inherently limited output	See appended table 2.5	P
	b) Impedance limited output	See appended table 2.5	P
	c) Regulating network or IC current limiter, limits output under normal operating and single fault condition	See appended table 2.5	P
	Use of integrated circuit (IC) current limiters	See appended table 1.5.1	P
	d) Overcurrent protective device limited output		N/A
	Max. output voltage (V), max. output current (A), max. apparent power (VA)	See appended table 2.5	—
	Current rating of overcurrent protective device (A) ..		—

2.6	Provisions for earthing and bonding <i>Class III equipment.</i>		N/A
2.6.1	Protective earthing		N/A
2.6.2	Functional earthing		N/A
	Use of symbol for functional earthing		N/A
2.6.3	Protective earthing and protective bonding conductors		N/A
2.6.3.1	General		N/A
2.6.3.2	Size of protective earthing conductors		N/A
	Rated current (A), cross-sectional area (mm ²), AWG.....		—
2.6.3.3	Size of protective bonding conductors		N/A
	Rated current (A), cross-sectional area (mm ²), AWG.....		—
	Protective current rating (A), cross-sectional area (mm ²), AWG.....		—
2.6.3.4	Resistance of earthing conductors and their terminations; resistance (Ω), voltage drop (V), test current (A), duration (min)		N/A
2.6.3.5	Colour of insulation.....		N/A
2.6.4	Terminals		N/A
2.6.4.1	General		N/A
2.6.4.2	Protective earthing and bonding terminals		N/A



IEC 60950-1			
Clause	Requirement + Test	Result - Remark	Verdict

	Rated current (A), type, nominal thread diameter (mm)		—
2.6.4.3	Separation of the protective earthing conductor from protective bonding conductors		N/A
2.6.5	Integrity of protective earthing		N/A
2.6.5.1	Interconnection of equipment		N/A
2.6.5.2	Components in protective earthing conductors and protective bonding conductors		N/A
2.6.5.3	Disconnection of protective earth		N/A
2.6.5.4	Parts that can be removed by an operator		N/A
2.6.5.5	Parts removed during servicing		N/A
2.6.5.6	Corrosion resistance		N/A
2.6.5.7	Screws for protective bonding		N/A
2.6.5.8	Reliance on telecommunication network or cable distribution system		N/A

2.7	Overcurrent and earth fault protection in primary circuits <i>Class III equipment.</i>		N/A
2.7.1	Basic requirements		N/A
	Instructions when protection relies on building installation		N/A
2.7.2	Faults not simulated in 5.3.7		N/A
2.7.3	Short-circuit backup protection		N/A
2.7.4	Number and location of protective devices		N/A
2.7.5	Protection by several devices		N/A
2.7.6	Warning to service personnel.....		N/A

2.8	Safety interlocks <i>No such device within this equipment.</i>		N/A
2.8.1	General principles		N/A
2.8.2	Protection requirements		N/A
2.8.3	Inadvertent reactivation		N/A
2.8.4	Fail-safe operation		N/A
	Protection against extreme hazard		N/A
2.8.5	Moving parts		N/A



IEC 60950-1			
Clause	Requirement + Test	Result - Remark	Verdict
2.8.6	Overriding		N/A
2.8.7	Switches, relays and their related circuits		N/A
2.8.7.1	Separation distances for contact gaps and their related circuits (mm)		N/A
2.8.7.2	Overload test		N/A
2.8.7.3	Endurance test		N/A
2.8.7.4	Electric strength test		N/A
2.8.8	Mechanical actuators		N/A

2.9	Electrical insulation		P
2.9.1	Properties of insulating materials	Natural rubber, asbestos or hygroscopic materials are not used. Only SELV inside the unit. No electrical shock hazard.	P
2.9.2	Humidity conditioning		N/A
	Relative humidity (%), temperature (°C)		—
2.9.3	Grade of insulation	Functional insulation.	P
2.9.4	Separation from hazardous voltages	See below.	P
	Method(s) used	Class III equipment, which is separated from hazardous voltage by double/reinforced insulation through external power adaptor.	—

2.10	Clearances, creepage distances and distances through insulation		P
	<i>The unit is supplied from the external adaptor that provides SELV. Only SELV inside the unit. See also 5.3.4.</i>		
2.10.1	General	Functional insulation only.	P
2.10.1.1	Frequency		N/A
2.10.1.2	Pollution degrees		N/A
2.10.1.3	Reduced values for functional insulation		N/A
2.10.1.4	Intervening unconnected conductive parts		N/A
2.10.1.5	Insulation with varying dimensions		N/A
2.10.1.6	Special separation requirements		N/A
2.10.1.7	Insulation in circuits generating starting pulses		N/A
2.10.2	Determination of working voltage		N/A



IEC 60950-1			
Clause	Requirement + Test	Result - Remark	Verdict
2.10.2.1	General		N/A
2.10.2.2	RMS working voltage		N/A
2.10.2.3	Peak working voltage		N/A
2.10.3	Clearances		N/A
2.10.3.1	General		N/A
2.10.3.2	Mains transient voltages		N/A
	a) AC mains supply		N/A
	b) Earthed d.c. mains supplies		N/A
	c) Unearthed d.c. mains supplies		N/A
	d) Battery operation		N/A
2.10.3.3	Clearances in primary circuits		N/A
2.10.3.4	Clearances in secondary circuits		N/A
2.10.3.5	Clearances in circuits having starting pulses		N/A
2.10.3.6	Transients from a.c. mains supply		N/A
2.10.3.7	Transients from d.c. mains supply		N/A
2.10.3.8	Transients from telecommunication networks and cable distribution systems		N/A
2.10.3.9	Measurement of transient voltage levels		N/A
	a) Transients from a mains supply		N/A
	For an a.c. mains supply		N/A
	For a d.c. mains supply		N/A
	b) Transients from a telecommunication network :		N/A
2.10.4	Creepage distances		N/A
2.10.4.1	General		N/A
2.10.4.2	Material group and comparative tracking index		N/A
	CTI tests		—
2.10.4.3	Minimum creepage distances		N/A
2.10.5	Solid insulation		N/A
2.10.5.1	General		N/A
2.10.5.2	Distances through insulation		N/A
2.10.5.3	Insulating compound as solid insulation		N/A
2.10.5.4	Semiconductor devices		N/A
2.10.5.5.	Cemented joints		N/A



IEC 60950-1			
Clause	Requirement + Test	Result - Remark	Verdict
2.10.5.6	Thin sheet material – General		N/A
2.10.5.7	Separable thin sheet material		N/A
	Number of layers (pcs) :		—
2.10.5.8	Non-separable thin sheet material		N/A
2.10.5.9	Thin sheet material – standard test procedure		N/A
	Electric strength test		—
2.10.5.10	Thin sheet material – alternative test procedure		N/A
	Electric strength test		—
2.10.5.11	Insulation in wound components		N/A
2.10.5.12	Wire in wound components		N/A
	Working voltage :		N/A
	a) Basic insulation not under stress :		N/A
	b) Basic, supplementary, reinforced insulation :		N/A
	c) Compliance with Annex U :		N/A
	Two wires in contact inside wound component; angle between 45° and 90° :		N/A
2.10.5.13	Wire with solvent-based enamel in wound components		N/A
	Electric strength test		—
	Routine test		N/A
2.10.5.14	Additional insulation in wound components		N/A
	Working voltage :		N/A
	- Basic insulation not under stress :		N/A
	- Supplementary, reinforced insulation :		N/A
2.10.6	Construction of printed boards		N/A
2.10.6.1	Uncoated printed boards		N/A
2.10.6.2	Coated printed boards		N/A
2.10.6.3	Insulation between conductors on the same inner surface of a printed board		N/A
2.10.6.4	Insulation between conductors on different layers of a printed board		N/A
	Distance through insulation		N/A
	Number of insulation layers (pcs) :		N/A
2.10.7	Component external terminations		N/A



IEC 60950-1			
Clause	Requirement + Test	Result - Remark	Verdict
2.10.8	Tests on coated printed boards and coated components		N/A
2.10.8.1	Sample preparation and preliminary inspection		N/A
2.10.8.2	Thermal conditioning		N/A
2.10.8.3	Electric strength test		N/A
2.10.8.4	Abrasion resistance test		N/A
2.10.9	Thermal cycling		N/A
2.10.10	Test for Pollution Degree 1 environment and insulating compound		N/A
2.10.11	Tests for semiconductor devices and cemented joints		N/A
2.10.12	Enclosed and sealed parts		N/A
3	WIRING, CONNECTIONS AND SUPPLY		P
3.1	General		P
3.1.1	Current rating and overcurrent protection	All internal wires are UL recognized. Cross-sectional area of internal wiring is suitable for current intended to be carried.	P
3.1.2	Protection against mechanical damage	Wires do not touch sharp edges or heat sinks, which could damage insulation and cause hazard.	P
3.1.3	Securing of internal wiring	Internal wiring is secured reliable so that loosening of terminal connections is unlikely.	P
3.1.4	Insulation of conductors	Insulation of the conductor is suitable for the application. For insulation material see sub-clause 3.1.1.	P
3.1.5	Beads and ceramic insulators		N/A
3.1.6	Screws for electrical contact pressure	No such screws provided.	N/A
3.1.7	Insulating materials in electrical connections	All connections are metal to metal.	N/A
3.1.8	Self-tapping and spaced thread screws	No self-tapping screws are used.	N/A
3.1.9	Termination of conductors	See below.	P



IEC 60950-1			
Clause	Requirement + Test	Result - Remark	Verdict

	10 N pull test	Well secured and keep suitable spacing as the required value.	P
3.1.10	Sleeving on wiring	No sleeving on wiring used as supplementary insulation.	N/A

3.2	Connection to a mains supply <i>Class III equipment. No direct connection to mains supply.</i>		N/A
3.2.1	Means of connection		N/A
3.2.1.1	Connection to an a.c. mains supply		N/A
3.2.1.2	Connection to a d.c. mains supply		N/A
3.2.2	Multiple supply connections		N/A
3.2.3	Permanently connected equipment		N/A
	Number of conductors, diameter of cable and conduits (mm)		—
3.2.4	Appliance inlets		N/A
3.2.5	Power supply cords		N/A
3.2.5.1	AC power supply cords		N/A
	Type		—
	Rated current (A), cross-sectional area (mm ²), AWG		—
3.2.5.2	DC power supply cords		N/A
3.2.6	Cord anchorages and strain relief		N/A
	Mass of equipment (kg), pull (N)		—
	Longitudinal displacement (mm)		—
3.2.7	Protection against mechanical damage		N/A
3.2.8	Cord guards		N/A
	Diameter or minor dimension D (mm); test mass (g)		—
	Radius of curvature of cord (mm)		—
3.2.9	Supply wiring space		N/A

3.3	Wiring terminals for connection of external conductors <i>Class III equipment. No direct connection to mains supply.</i>		N/A
3.3.1	Wiring terminals		N/A
3.3.2	Connection of non-detachable power supply cords		N/A



IEC 60950-1			
Clause	Requirement + Test	Result - Remark	Verdict
3.3.3	Screw terminals		N/A
3.3.4	Conductor sizes to be connected		N/A
	Rated current (A), cord/cable type, cross-sectional area (mm ²)		—
3.3.5	Wiring terminal sizes		N/A
	Rated current (A), type, nominal thread diameter (mm)		—
3.3.6	Wiring terminal design		N/A
3.3.7	Grouping of wiring terminals		N/A
3.3.8	Stranded wire		N/A
3.4	Disconnection from the mains supply <i>Class III equipment. No direct connection to mains supply.</i>		N/A
3.4.1	General requirement		N/A
3.4.2	Disconnect devices		N/A
3.4.3	Permanently connected equipment		N/A
3.4.4	Parts which remain energized		N/A
3.4.5	Switches in flexible cords		N/A
3.4.6	Number of poles - single-phase and d.c. equipment		N/A
3.4.7	Number of poles - three-phase equipment		N/A
3.4.8	Switches as disconnect devices		N/A
3.4.9	Plugs as disconnect devices		N/A
3.4.10	Interconnected equipment		N/A
3.4.11	Multiple power sources		N/A
3.5	Interconnection of equipment		P
3.5.1	General requirements	See below.	P
3.5.2	Types of interconnection circuits	Interconnection circuits is SELV through sec connector.	P
3.5.3	ELV circuits as interconnection circuits	No ELV interconnection.	N/A
3.5.4	Data ports for additional equipment	Results see appended table 2.5.	P
4	PHYSICAL REQUIREMENTS		P



IEC 60950-1			
Clause	Requirement + Test	Result - Remark	Verdict
4.1	Stability		N/A
	Angle of 10°	The equipment has less mass than 7.0kg.	N/A
	Test force (N)	Equipment is not a floor-standing unit.	N/A
4.2	Mechanical strength		P
4.2.1	General	See below. After the tests, the equipment complies with the requirements of sub-clauses 2.1.1.	P
	Rack-mounted equipment.	Same as above.	P
4.2.2	Steady force test, 10 N	10 N applied to components other than parts serving as an enclosure.	P
4.2.3	Steady force test, 30 N	No internal enclosure.	N/A
4.2.4	Steady force test, 250 N	250 N applied to outer enclosure of metal enclosure at top, side, front and rear. No energy or other hazards.	P
4.2.5	Impact test	No hazard as result from steel sphere ball impact test applied for top/side/front/rear for metal enclosure.	P
	Fall test	Same as above	P
	Swing test	Same as above	P
4.2.6	Drop test; height (mm)		N/A
4.2.7	Stress relief test	Metal enclosure	N/A
4.2.8	Cathode ray tubes	No CRT in the unit.	N/A
	Picture tube separately certified	Same as above.	N/A
4.2.9	High pressure lamps	No high pressure lamp provided.	N/A
4.2.10	Wall or ceiling mounted equipment; force (N)	Weight of the equipment: 4.3Kg (three times the weight: 12.6Kg), Wall Force applied: 124N (12.6 x 9.8 = 123.48N)	P
4.3	Design and construction		P



IEC 60950-1			
Clause	Requirement + Test	Result - Remark	Verdict
4.3.1	Edges and corners	The outer surfaces of the equipment are smooth and rounded.	P
4.3.2	Handles and manual controls; force (N)..... :	No such handle or control.	N/A
4.3.3	Adjustable controls	No control device.	N/A
4.3.4	Securing of parts	Mechanical fixings are reliable designed to withstand mechanical stress occurring during normal use.	P
4.3.5	Connection by plugs and sockets	No misconnection of plugs, connections or sockets possible.	P
4.3.6	Direct plug-in equipment	Not direct plug-in equipment.	N/A
	Torque		—
	Compliance with the relevant mains plug standard		N/A
4.3.7	Heating elements in earthed equipment	No heating element.	N/A
4.3.8	Batteries	For R.T.C Battery: Prevent from force charging by series circuit of a diode (D2) and a 1Kohm resistor (R96). See appended table 4.3.8.	P
	- Overcharging of a rechargeable battery		N/A
	- Unintentional charging of a non-rechargeable battery	See appended table 4.3.8.	P
	- Reverse charging of a rechargeable battery		N/A
	- Excessive discharging rate for any battery		N/A
4.3.9	Oil and grease	Insulation in intended use not considered to be exposed to oil and grease.	N/A
4.3.10	Dust, powders, liquids and gases	EUT in intended use does not produce dust or use powders, liquids or gases.	N/A
4.3.11	Containers for liquids or gases	No such containers provided.	N/A
4.3.12	Flammable liquids	No flammable liquids used.	N/A
	Quantity of liquid (l)	Same as above.	N/A
	Flash point (°C)	Same as above.	N/A
4.3.13	Radiation	See below.	P



IEC 60950-1			
Clause	Requirement + Test	Result - Remark	Verdict
4.3.13.1	General	See below.	P
4.3.13.2	Ionizing radiation	No ionizing radiation or flammable liquids present.	N/A
	Measured radiation (pA/kg)		—
	Measured high-voltage (kV)		—
	Measured focus voltage (kV)		—
	CRT markings		—
4.3.13.3	Effect of ultraviolet (UV) radiation on materials	No UV radiation.	N/A
	Part, property, retention after test, flammability classification		N/A
4.3.13.4	Human exposure to ultraviolet (UV) radiation	No UV radiation.	N/A
4.3.13.5	Lasers (including laser diodes) and LEDs	See below.	P
4.3.13.5.1	Lasers (including laser diodes)	No Lasers.	N/A
	Laser class		—
4.3.13.5.2	Light emitting diodes (LEDs)	The LED indicator is considered as indicating light.	P
4.3.13.6	Other types		N/A
4.4	Protection against hazardous moving parts <i>No hazard moving parts are employed.</i>		N/A
4.4.1	General		N/A
4.4.2	Protection in operator access areas		N/A
	Household and home/office document/media shredders		N/A
4.4.3	Protection in restricted access locations		N/A
4.4.4	Protection in service access areas		N/A
4.4.5	Protection against moving fan blades		N/A
4.4.5.1	General		N/A
	Not considered to cause pain or injury. a).....:		N/A
	Is considered to cause pain, not injury. b)		N/A
	Considered to cause injury. c)		N/A
4.4.5.2	Protection for users		N/A
	Use of symbol or warning		N/A
4.4.5.3	Protection for service persons		N/A



IEC 60950-1			
Clause	Requirement + Test	Result - Remark	Verdict

	Use of symbol or warning		N/A
--	--------------------------------	--	-----

4.5	Thermal requirements		P
4.5.1	General	See below.	P
4.5.2	Temperature tests	See appended table 4.5.	P
	Normal load condition per Annex L	See appended table 1.6.2.	—
4.5.3	Temperature limits for materials	See appended table 4.5.	P
4.5.4	Touch temperature limits	See appended table 4.5.	P
4.5.5	Resistance to abnormal heat	No thermoplastic part at hazardous voltage.	N/A

4.6	Openings in enclosures		P
4.6.1	Top and side openings	No hazardous parts within 5° projection area. See below.	P
	Dimensions (mm)	See appended table 4.6.1 & 4.6.2.	—
4.6.2	Bottoms of fire enclosures	The power sources are complied with LPS, and fire enclosure is not required.	P
	Construction of the bottom, dimensions (mm) ...:	See appended table 4.6.1 & 4.6.2.	—
4.6.3	Doors or covers in fire enclosures	No doors or covers provided.	N/A
4.6.4	Openings in transportable equipment	Not such equipment.	N/A
4.6.4.1	Constructional design measures	Same as above.	N/A
	Dimensions (mm)	Same as above.	—
4.6.4.2	Evaluation measures for larger openings	Same as above.	N/A
4.6.4.3	Use of metallized parts	Same as above.	N/A
4.6.5	Adhesives for constructional purposes	No such consideration.	N/A
	Conditioning temperature (°C), time (weeks)		—

4.7	Resistance to fire		P
4.7.1	Reducing the risk of ignition and spread of flame	Method 1 used.	P
	Method 1, selection and application of components wiring and materials	Used of material with the required flammability classes.	P
	Method 2, application of all of simulated fault condition tests		N/A



IEC 60950-1			
Clause	Requirement + Test	Result - Remark	Verdict
4.7.2	Conditions for a fire enclosure	See below.	P
4.7.2.1	Parts requiring a fire enclosure	With having the following components: - Insulated wiring - Components in secondary (not supplied by LPS) The fire enclosure is required.	P
4.7.2.2	Parts not requiring a fire enclosure	See 4.7.2.1.	N/A
4.7.3	Materials		P
4.7.3.1	General	PCB rated of flammability class V-1 or better.	P
4.7.3.2	Materials for fire enclosures	See appended table 1.5.1.	P
4.7.3.3	Materials for components and other parts outside fire enclosures	Internal components except small parts are V-2 or better.	P
4.7.3.4	Materials for components and other parts inside fire enclosures	Internal components except small parts are V-2, HF-2 or better.	P
4.7.3.5	Materials for air filter assemblies	No air filter provided.	N/A
4.7.3.6	Materials used in high-voltage components	No high voltage components provided.	N/A
5	ELECTRICAL REQUIREMENTS AND SIMULATED ABNORMAL CONDITIONS		P
5.1	Touch current and protective conductor current <i>Class III equipment without TNV circuit.</i>		N/A
5.1.1	General		N/A
5.1.2	Configuration of equipment under test (EUT)		N/A
5.1.2.1	Single connection to an a.c. mains supply		N/A
5.1.2.2	Redundant multiple connections to an a.c. mains supply		N/A
5.1.2.3	Simultaneous multiple connections to an a.c. mains supply		N/A
5.1.3	Test circuit		N/A
5.1.4	Application of measuring instrument		N/A
5.1.5	Test procedure		N/A
5.1.6	Test measurements		N/A
	Supply voltage (V)		—



IEC 60950-1			
Clause	Requirement + Test	Result - Remark	Verdict
	Measured touch current (mA)		—
	Max. allowed touch current (mA)		—
	Measured protective conductor current (mA)		—
	Max. allowed protective conductor current (mA) ...		—
5.1.7	Equipment with touch current exceeding 3,5 mA		N/A
5.1.7.1	General		N/A
5.1.7.2	Simultaneous multiple connections to the supply		N/A
5.1.8	Touch currents to telecommunication networks and cable distribution systems and from telecommunication networks		N/A
5.1.8.1	Limitation of the touch current to a telecommunication network or to a cable distribution system		N/A
	Supply voltage (V)		—
	Measured touch current (mA)		—
	Max. allowed touch current (mA)		—
5.1.8.2	Summation of touch currents from telecommunication networks		N/A
	a) EUT with earthed telecommunication ports		N/A
	b) EUT whose telecommunication ports have no reference to protective earth		N/A
5.2	Electric strength		N/A
5.2.1	General		N/A
5.2.2	Test procedure		N/A
5.3	Abnormal operating and fault conditions		P
5.3.1	Protection against overload and abnormal operation	Abnormal operation test performed. See appended table 5.3.	P
5.3.2	Motors	No such components provided.	N/A
5.3.3	Transformers	No such components provided.	N/A
5.3.4	Functional insulation.....	Method c). Results see appended table 5.3.	P
5.3.5	Electromechanical components	No electromechanical component.	N/A



IEC 60950-1			
Clause	Requirement + Test	Result - Remark	Verdict
5.3.6	Audio amplifiers in ITE	No audio amplifier within this equipment.	N/A
5.3.7	Simulation of faults	See appended table 5.3.	P
5.3.8	Unattended equipment		N/A
5.3.9	Compliance criteria for abnormal operating and fault conditions	No fire occurred. No molten metal was emitted.	P
5.3.9.1	During the tests	Same as above.	P
5.3.9.2	After the tests		N/A
6	CONNECTION TO TELECOMMUNICATION NETWORKS		N/A
6.1	Protection of telecommunication network service persons, and users of other equipment connected to the network, from hazards in the equipment		N/A
6.1.1	Protection from hazardous voltages		N/A
6.1.2	Separation of the telecommunication network from earth		N/A
6.1.2.1	Requirements		N/A
	Supply voltage (V)		—
	Current in the test circuit (mA)		—
6.1.2.2	Exclusions		N/A
6.2	Protection of equipment users from overvoltages on telecommunication networks		N/A
6.2.1	Separation requirements		N/A
6.2.2	Electric strength test procedure		N/A
6.2.2.1	Impulse test		N/A
6.2.2.2	Steady-state test		N/A
6.2.2.3	Compliance criteria		N/A
6.3	Protection of the telecommunication wiring system from overheating		N/A
	Max. output current (A)		—
	Current limiting method		—
7	CONNECTION TO CABLE DISTRIBUTION SYSTEMS		N/A
7.1	General		N/A



IEC 60950-1			
Clause	Requirement + Test	Result - Remark	Verdict
7.2	Protection of cable distribution system service persons, and users of other equipment connected to the system, from hazardous voltages in the equipment		N/A
7.3	Protection of equipment users from overvoltages on the cable distribution system		N/A
7.4	Insulation between primary circuits and cable distribution systems		N/A
7.4.1	General		N/A
7.4.2	Voltage surge test		N/A
7.4.3	Impulse test		N/A

A	ANNEX A, TESTS FOR RESISTANCE TO HEAT AND FIRE		N/A
A.1	Flammability test for fire enclosures of movable equipment having a total mass exceeding 18 kg, and of stationary equipment (see 4.7.3.2)		N/A
A.1.1	Samples		—
	Wall thickness (mm).....		—
A.1.2	Conditioning of samples; temperature (°C)		N/A
A.1.3	Mounting of samples		N/A
A.1.4	Test flame (see IEC 60695-11-3)		N/A
	Flame A, B, C or D		—
A.1.5	Test procedure		N/A
A.1.6	Compliance criteria		N/A
	Sample 1 burning time (s)		—
	Sample 2 burning time (s)		—
	Sample 3 burning time (s)		—
A.2	Flammability test for fire enclosures of movable equipment having a total mass not exceeding 18 kg, and for material and components located inside fire enclosures (see 4.7.3.2 and 4.7.3.4)		N/A
A.2.1	Samples, material.....		—
	Wall thickness (mm).....		—
A.2.2	Conditioning of samples; temperature (°C)		N/A
A.2.3	Mounting of samples		N/A
A.2.4	Test flame (see IEC 60695-11-4)		N/A
	Flame A, B or C		—



IEC 60950-1			
Clause	Requirement + Test	Result - Remark	Verdict
A.2.5	Test procedure		N/A
A.2.6	Compliance criteria		N/A
	Sample 1 burning time (s)		—
	Sample 2 burning time (s)		—
	Sample 3 burning time (s)		—
A.2.7	Alternative test acc. to IEC 60695-11-5, cl. 5 and 9		N/A
	Sample 1 burning time (s)		—
	Sample 2 burning time (s)		—
	Sample 3 burning time (s)		—
A.3	Hot flaming oil test (see 4.6.2)		N/A
A.3.1	Mounting of samples		N/A
A.3.2	Test procedure		N/A
A.3.3	Compliance criterion		N/A
B	ANNEX B, MOTOR TESTS UNDER ABNORMAL CONDITIONS (see 4.7.2.2 and 5.3.2)		N/A
B.1	General requirements		N/A
	Position		—
	Manufacturer		—
	Type		—
	Rated values		—
B.2	Test conditions		N/A
B.3	Maximum temperatures		N/A
B.4	Running overload test		N/A
B.5	Locked-rotor overload test		N/A
	Test duration (days)		—
	Electric strength test: test voltage (V)		—
B.6	Running overload test for d.c. motors in secondary circuits		N/A
B.6.1	General		N/A
B.6.2	Test procedure		N/A
B.6.3	Alternative test procedure		N/A
B.6.4	Electric strength test; test voltage (V)		N/A



IEC 60950-1			
Clause	Requirement + Test	Result - Remark	Verdict
B.7	Locked-rotor overload test for d.c. motors in secondary circuits		N/A
B.7.1	General		N/A
B.7.2	Test procedure		N/A
B.7.3	Alternative test procedure		N/A
B.7.4	Electric strength test; test voltage (V)		N/A
B.8	Test for motors with capacitors		N/A
B.9	Test for three-phase motors		N/A
B.10	Test for series motors		N/A
	Operating voltage (V)		—
C	ANNEX C, TRANSFORMERS (see 1.5.4 and 5.3.3)		N/A
	Position		—
	Manufacturer		—
	Type		—
	Rated values		—
	Method of protection.....		—
C.1	Overload test		N/A
C.2	Insulation		N/A
	Protection from displacement of windings.....		N/A
D	ANNEX D, MEASURING INSTRUMENTS FOR TOUCH-CURRENT TESTS (see 5.1.4)		N/A
D.1	Measuring instrument		N/A
D.2	Alternative measuring instrument		N/A
E	ANNEX E, TEMPERATURE RISE OF A WINDING (see 1.4.13)		N/A
F	ANNEX F, MEASUREMENT OF CLEARANCES AND CREEPAGE DISTANCES (see 2.10 and Annex G)		N/A
G	ANNEX G, ALTERNATIVE METHOD FOR DETERMINING MINIMUM CLEARANCES		N/A
G.1	Clearances		N/A



IEC 60950-1			
Clause	Requirement + Test	Result - Remark	Verdict
G.1.1	General		N/A
G.1.2	Summary of the procedure for determining minimum clearances		N/A
G.2	Determination of mains transient voltage (V)		N/A
G.2.1	AC mains supply		N/A
G.2.2	Earthed d.c. mains supplies		N/A
G.2.3	Unearthed d.c. mains supplies		N/A
G.2.4	Battery operation		N/A
G.3	Determination of telecommunication network transient voltage (V)		N/A
G.4	Determination of required withstand voltage (V)		N/A
G.4.1	Mains transients and internal repetitive peaks		N/A
G.4.2	Transients from telecommunication networks		N/A
G.4.3	Combination of transients		N/A
G.4.4	Transients from cable distribution systems		N/A
G.5	Measurement of transient voltages (V)		N/A
	a) Transients from a mains supply		N/A
	For an a.c. mains supply		N/A
	For a d.c. mains supply		N/A
	b) Transients from a telecommunication network		N/A
G.6	Determination of minimum clearances		N/A
H	ANNEX H, IONIZING RADIATION (see 4.3.13)		N/A
J	ANNEX J, TABLE OF ELECTROCHEMICAL POTENTIALS (see 2.6.5.6)		N/A
	Metal(s) used		—
K	ANNEX K, THERMAL CONTROLS (see 1.5.3 and 5.3.8)		N/A
K.1	Making and breaking capacity		N/A
K.2	Thermostat reliability; operating voltage (V)		N/A
K.3	Thermostat endurance test; operating voltage (V)		N/A
K.4	Temperature limiter endurance; operating voltage (V)		N/A



IEC 60950-1			
Clause	Requirement + Test	Result - Remark	Verdict

K.5	Thermal cut-out reliability		N/A
K.6	Stability of operation		N/A

L	ANNEX L, NORMAL LOAD CONDITIONS FOR SOME TYPES OF ELECTRICAL BUSINESS EQUIPMENT (see 1.2.2.1 and 4.5.2)		P
L.1	Typewriters		N/A
L.2	Adding machines and cash registers		N/A
L.3	Erasers		N/A
L.4	Pencil sharpeners		N/A
L.5	Duplicators and copy machines		N/A
L.6	Motor-operated files		N/A
L.7	Other business equipment	See sub-clause 1.6.2.	P

M	ANNEX M, CRITERIA FOR TELEPHONE RINGING SIGNALS (see 2.3.1)		N/A
M.1	Introduction		N/A
M.2	Method A		N/A
M.3	Method B		N/A
M.3.1	Ringling signal		N/A
M.3.1.1	Frequency (Hz)		—
M.3.1.2	Voltage (V)		—
M.3.1.3	Cadence; time (s), voltage (V)		—
M.3.1.4	Single fault current (mA)		—
M.3.2	Tripping device and monitoring voltage		N/A
M.3.2.1	Conditions for use of a tripping device or a monitoring voltage		N/A
M.3.2.2	Tripping device		N/A
M.3.2.3	Monitoring voltage (V)		N/A

N	ANNEX N, IMPULSE TEST GENERATORS (see 1.5.7.2, 1.5.7.3, 2.10.3.9, 6.2.2.1, 7.3.2, 7.4.3 and Clause G.5)		N/A
N.1	ITU-T impulse test generators		N/A
N.2	IEC 60065 impulse test generator		N/A

P	ANNEX P, NORMATIVE REFERENCES		—
----------	--------------------------------------	--	---



IEC 60950-1			
Clause	Requirement + Test	Result - Remark	Verdict

Q	ANNEX Q, Voltage dependent resistors (VDRs) (see 1.5.9.1)		N/A
	- Preferred climatic categories		N/A
	- Maximum continuous voltage		N/A
	- Combination pulse current		N/A
	Body of the VDR Test according to IEC60695-11-5.....		N/A
	Body of the VDR. Flammability class of material (min V-1).....		N/A

R	ANNEX R, EXAMPLES OF REQUIREMENTS FOR QUALITY CONTROL PROGRAMMES		N/A
R.1	Minimum separation distances for unpopulated coated printed boards (see 2.10.6.2)		N/A
R.2	Reduced clearances (see 2.10.3)		N/A

S	ANNEX S, PROCEDURE FOR IMPULSE TESTING (see 6.2.2.3)		N/A
S.1	Test equipment		N/A
S.2	Test procedure		N/A
S.3	Examples of waveforms during impulse testing		N/A

T	ANNEX T, GUIDANCE ON PROTECTION AGAINST INGRESS OF WATER (see 1.1.2)		N/A
			—

U	ANNEX U, INSULATED WINDING WIRES FOR USE WITHOUT INTERLEAVED INSULATION (see 2.10.5.4)		N/A
			—

V	ANNEX V, AC POWER DISTRIBUTION SYSTEMS (see 1.6.1)		N/A
V.1	Introduction		N/A
V.2	TN power distribution systems		N/A

W	ANNEX W, SUMMATION OF TOUCH CURRENTS		N/A
----------	---	--	-----



IEC 60950-1			
Clause	Requirement + Test	Result - Remark	Verdict
W.1	Touch current from electronic circuits		N/A
W.1.1	Floating circuits		N/A
W.1.2	Earthed circuits		N/A
W.2	Interconnection of several equipments		N/A
W.2.1	Isolation		N/A
W.2.2	Common return, isolated from earth		N/A
W.2.3	Common return, connected to protective earth		N/A
X	ANNEX X, MAXIMUM HEATING EFFECT IN TRANSFORMER TESTS (see clause C.1)		N/A
X.1	Determination of maximum input current		N/A
X.2	Overload test procedure		N/A
Y	ANNEX Y, ULTRAVIOLET LIGHT CONDITIONING TEST (see 4.3.13.3)		N/A
Y.1	Test apparatus		N/A
Y.2	Mounting of test samples		N/A
Y.3	Carbon-arc light-exposure apparatus		N/A
Y.4	Xenon-arc light exposure apparatus		N/A
Z	ANNEX Z, OVERVOLTAGE CATEGORIES (see 2.10.3.2 and Clause G.2)		N/A
AA	ANNEX AA, MANDREL TEST (see 2.10.5.8)		N/A
BB	ANNEX BB, CHANGES IN THE SECOND EDITION		—
CC	ANNEX CC, Evaluation of integrated circuit (IC) current limiters		N/A
CC.1	General		N/A
CC.2	Test program 1.....		N/A
CC.3	Test program 2.....		N/A
CC.4	Test program 3.....		N/A
CC.5	Compliance.....		N/A
DD	ANNEX DD, Requirements for the mounting means of rack-mounted equipment		N/A
DD.1	General		N/A



IEC 60950-1			
Clause	Requirement + Test	Result - Remark	Verdict
DD.2	Mechanical strength test, variable N.....:		N/A
DD.3	Mechanical strength test, 250N, including end stops.....:		N/A
DD.4	Compliance..... :		N/A
EE	ANNEX EE, Household and home/office document/media shredders		N/A
EE.1	General		N/A
EE.2	Markings and instructions		N/A
	Use of markings or symbols.....:		N/A
	Information of user instructions, maintenance and/or servicing instructions.....:		N/A
EE.3	Inadvertent reactivation test.....:		N/A
EE.4	Disconnection of power to hazardous moving parts:		N/A
	Use of markings or symbols.....:		N/A
EE.5	Protection against hazardous moving parts		N/A
	Test with test finger (Figure 2A)		N/A
	Test with wedge probe (Figure EE1 and EE2)		N/A



IEC 60950-1			
Clause	Requirement + Test	Result - Remark	Verdict
EN 60950-1:2006/A11:2009/A1:2010/A12:2011/A2:2013 – CENELEC COMMON MODIFICATIONS			
Contents (A2:2013)	Add the following annexes: Annex ZA (normative) Normative references to international publications with their corresponding European publications Annex ZB (normative) Special national conditions Annex ZD (informative) IEC and CENELEC code designations for flexible cords		P
General	Delete all the “country” notes in the reference document (IEC 60950-1:2005) according to the following list: 1.4.8 Note 2 1.5.1 Note 2 & 3 1.5.7.1 Note 1.5.8 Note 2 1.5.9.4 Note 1.7.2.1 Note 4, 5 & 6 2.2.3 Note 2.2.4 Note 2.3.2 Note 2.3.2.1 Note 2 2.3.4 Note 2 2.6.3.3 Note 2 & 3 2.7.1 Note 2.10.3.2 Note 2 2.10.5.13 Note 3 3.2.1.1 Note 3.2.4 Note 3. 2.5.1 Note 2 4.3.6 Note 1 & 2 4.7 Note 4 4.7.2.2 Note 4.7.3.1 Note 2 5.1.7.1 Note 3 & 4 5.3.7 Note 1 6 Note 2 & 5 6.1.2.1 Note 2 6.1.2.2 Note 6.2.2 Note 6.2.2.1 Note 2 6.2.2.2 Note 7.1 Note 3 7.2 Note 7.3 Note 1 & 2 G.2.1 Note 2 Annex H Note 2		P
General (A1:2010)	Delete all the “country” notes in the reference document (IEC 60950-1:2005/A1:2010) according to the following list: 1.5.7.1 Note 6.1.2.1 Note 2 6.2.2.1 Note 2 EE.3 Note		P
General (A2:2013)	Delete all the “country” notes in the reference document (IEC 60950-1:2005/A2:2013) according to the following list: 2.7.1 Note * 2.10.3.1 Note 2 6.2.2. Note * Note of secretary: Text of Common Modification remains unchanged.		P
1.1.1 (A1:2010)	Replace the text of NOTE 3 by the following. NOTE 3 The requirements of EN 60065 may also be used to meet safety requirements for multimedia equipment. See IEC Guide 112, Guide on the safety of multimedia equipment. For television sets EN 60065 applies.		N/A



IEC 60950-1			
Clause	Requirement + Test	Result - Remark	Verdict
1.3.Z1	<p>Add the following subclause:</p> <p>1.3.Z1 Exposure to excessive sound pressure</p> <p>The apparatus shall be so designed and constructed as to present no danger when used for its intended purpose, either in normal operating conditions or under fault conditions, particularly providing protection against exposure to excessive sound pressures from headphones or earphones.</p> <p>NOTE Z1 A new method of measurement is described in EN 50332-1, Sound system equipment: Headphones and earphones associated with portable audio equipment - Maximum sound pressure level measurement methodology and limit considerations - Part 1: General method for "one package equipment", and in EN 50332-2, Sound system equipment: Headphones and earphones associated with portable audio equipment - Maximum sound pressure level measurement methodology and limit considerations - Part 2: Guidelines to associate sets with headphones coming from different manufacturers.</p>		N/A
(A12:2011)	<p>In EN 60950-1:2006/A12:2011</p> <p>Delete the addition of 1.3.Z1 / EN 60950-1:2006</p> <p>Delete the definition 1.2.3.Z1 / EN 60950-1:2006 /A1:2010</p>		N/A
1.5.1 (Added info*)	<p>Add the following NOTE:</p> <p>NOTE Z1 The use of certain substances in electrical and electronic equipment is restricted within the EU: see Directive 2002/95/EC. New Directive 2011/65/11 *</p>		N/A
1.7.2.1 (A1:2010)	<p>In addition, for a PORTABLE SOUND SYSTEM, the instructions shall include a warning that excessive sound pressure from earphones and headphones can cause hearing loss.</p>		N/A
1.7.2.1 (A12:2011)	<p>In EN 60950-1:2006/A12:2011</p> <p>Delete NOTE Z1 and the addition for Portable Sound System.</p> <p>Add the following clause and annex to the existing standard and amendments.</p>		N/A
	<p>Zx Protection against excessive sound pressure from personal music players</p>		N/A



IEC 60950-1			
Clause	Requirement + Test	Result - Remark	Verdict
	<p>Zx.1 General This sub-clause specifies requirements for protection against excessive sound pressure from personal music players that are closely coupled to the ear. It also specifies requirements for earphones and headphones intended for use with personal music players.</p> <p>A personal music player is a portable equipment for personal use, that:</p> <ul style="list-style-type: none"> – is designed to allow the user to listen to recorded or broadcast sound or video; and – primarily uses headphones or earphones that can be worn in or on or around the ears; and – allows the user to walk around while in use. <p>NOTE 1 Examples are hand-held or body-worn portable CD players, MP3 audio players, mobile phones with MP3 type features, PDA's or similar equipment.</p> <p>A personal music player and earphones or headphones intended to be used with personal music players shall comply with the requirements of this sub-clause.</p> <p>The requirements in this sub-clause are valid for music or video mode only.</p> <p>The requirements do not apply:</p> <ul style="list-style-type: none"> – while the personal music player is connected to an external amplifier; or – while the headphones or earphones are not used. <p>NOTE 2 An external amplifier is an amplifier which is not part of the personal music player or the listening device, but which is intended to play the music as a standalone music player.</p> <p>The requirements do not apply to:</p> <ul style="list-style-type: none"> – hearing aid equipment and professional equipment; <p>NOTE 3 Professional equipment is equipment sold through special sales channels. All products sold through normal electronics stores are considered not to be professional equipment.</p>		N/A



IEC 60950-1			
Clause	Requirement + Test	Result - Remark	Verdict
	<p>– analogue personal music players (personal music players without any kind of digital processing of the sound signal) that are brought to the market before the end of 2015.</p> <p>NOTE 4 This exemption has been allowed because this technology is falling out of use and it is expected that within a few years it will no longer exist. This exemption will not be extended to other technologies.</p> <p>For equipment which is clearly designed or intended for use by young children, the limits of EN 71-1 apply.</p>		N/A
	<p>Zx.2 Equipment requirements</p> <p>No safety provision is required for equipment that complies with the following:</p> <ul style="list-style-type: none"> – equipment provided as a package (personal music player with its listening device), where the acoustic output $L_{Aeq,T}$ is ≤ 85 dBA measured while playing the fixed “programme simulation noise” as described in EN 50332-1; and – a personal music player provided with an analogue electrical output socket for a listening device, where the electrical output is ≤ 27 mV measured as described in EN 50332-2, while playing the fixed “programme simulation noise” as described in EN 50332-1. <p>NOTE 1 Wherever the term acoustic output is used in this clause, the 30 s A-weighted equivalent sound pressure level $L_{Aeq,T}$ is meant. See also Zx.5 and Annex Zx.</p> <p>All other equipment shall:</p> <ul style="list-style-type: none"> a) protect the user from unintentional acoustic outputs exceeding those mentioned above; and b) have a standard acoustic output level not exceeding those mentioned above, and automatically return to an output level not exceeding those mentioned above when the power is switched off; and 		N/A



IEC 60950-1			
Clause	Requirement + Test	Result - Remark	Verdict
	<p>c) provide a means to actively inform the user of the increased sound pressure when the equipment is operated with an acoustic output exceeding those mentioned above. Any means used shall be acknowledged by the user before activating a mode of operation which allows for an acoustic output exceeding those mentioned above. The acknowledgement does not need to be repeated more than once every 20 h of cumulative listening time; and</p> <p>NOTE 2 Examples of means include visual or audible signals. Action from the user is always required.</p> <p>NOTE 3 The 20 h listening time is the accumulative listening time, independent how often and how long the personal music player has been switched off.</p> <p>d) have a warning as specified in Zx.3; and</p> <p>e) not exceed the following:</p> <ol style="list-style-type: none"> 1) equipment provided as a package (player with its listening device), the acoustic output shall be ≤ 100 dBA measured while playing the fixed "programme simulation noise" described in EN 50332-1; and 2) a personal music player provided with an analogue electrical output socket for a listening device, the electrical output shall be ≤ 150 mV measured as described in EN 50332-2, while playing the fixed "programme simulation noise" described in EN 50332-1. <p>For music where the average sound pressure (long term $L_{Aeq,T}$) measured over the duration of the song is lower than the average produced by the programme simulation noise, the warning does not need to be given as long as the average sound pressure of the song is below the basic limit of 85 dBA. In this case T becomes the duration of the song.</p> <p>NOTE 4 Classical music typically has an average sound pressure (long term $L_{Aeq,T}$) which is much lower than the average programme simulation noise. Therefore, if the player is capable to analyse the song and compare it with the programme simulation noise, the warning does not need to be given as long as the average sound pressure of the song is below the basic limit of 85 dBA.</p> <p>For example, if the player is set with the programme simulation noise to 85 dBA, but the average music level of the song is only 65 dBA, there is no need to give a warning or ask an acknowledgement as long as the average sound level of the song is not above the basic limit of 85 dBA.</p>		N/A



IEC 60950-1			
Clause	Requirement + Test	Result - Remark	Verdict
	<p>Zx.3 Warning The warning shall be placed on the equipment, or on the packaging, or in the instruction manual and shall consist of the following:</p> <ul style="list-style-type: none"> – the symbol of Figure 1 with a minimum height of 5 mm; and – the following wording, or similar: <p>“To prevent possible hearing damage, do not listen at high volume levels for long periods.”</p> <div style="text-align: center;">  </div> <p>Figure 1 – Warning label (IEC 60417-6044)</p> <p>Alternatively, the entire warning may be given through the equipment display during use, when the user is asked to acknowledge activation of the higher level.</p>		N/A
	Zx.4 Requirements for listening devices (headphones and earphones)		N/A
	<p>Zx.4.1 Wired listening devices with analogue input With 94 dBA sound pressure output $L_{Aeq,T}$, the input voltage of the fixed “programme simulation noise” described in EN 50332-2 shall be ≥ 75 mV.</p> <p>This requirement is applicable in any mode where the headphones can operate (active or passive), including any available setting (for example built-in volume level control).</p> <p>NOTE The values of 94 dBA – 75 mV correspond with 85dBA – 27 mV and 100 dBA – 150 mV.</p>		N/A



IEC 60950-1			
Clause	Requirement + Test	Result - Remark	Verdict
	<p>Zx.4.2 Wired listening devices with digital input With any playing device playing the fixed “programme simulation noise” described in EN 50332-1 (and respecting the digital interface standards, where a digital interface standard exists that specifies the equivalent acoustic level), the acoustic output $L_{Aeq,T}$ of the listening device shall be ≤ 100 dBA.</p> <p>This requirement is applicable in any mode where the headphones can operate, including any available setting (for example built-in volume level control, additional sound feature like equalization, etc.).</p> <p>NOTE An example of a wired listening device with digital input is a USB headphone.</p>		N/A
	<p>Zx.4.3 Wireless listening devices In wireless mode:</p> <ul style="list-style-type: none">– with any playing and transmitting device playing the fixed programme simulation noise described in EN 50332-1; and– respecting the wireless transmission standards, where an air interface standard exists that specifies the equivalent acoustic level; and– with volume and sound settings in the listening device (for example built-in volume level control, additional sound feature like equalization, etc.) set to the combination of positions that maximize the measured acoustic output for the abovementioned programme simulation noise, the acoustic output $L_{Aeq,T}$ of the listening device shall be ≤ 100 dBA. <p>NOTE An example of a wireless listening device is a Bluetooth headphone.</p>		N/A
	<p>Zx.5 Measurement methods Measurements shall be made in accordance with EN 50332-1 or EN 50332-2 as applicable. Unless stated otherwise, the time interval T shall be 30 s.</p> <p>NOTE Test method for wireless equipment provided without listening device should be defined.</p>		N/A



IEC 60950-1			
Clause	Requirement + Test	Result - Remark	Verdict
2.7.1	<p>Replace the subclause as follows:</p> <p>Basic requirements</p> <p>To protect against excessive current, short-circuits and earth faults in PRIMARY CIRCUITS, protective devices shall be included either as integral parts of the equipment or as parts of the building installation, subject to the following, a), b) and c):</p> <p>a) except as detailed in b) and c), protective devices necessary to comply with the requirements of 5.3 shall be included as parts of the equipment;</p> <p>b) for components in series with the mains input to the equipment such as the supply cord, appliance coupler, r.f.i. filter and switch, short-circuit and earth fault protection may be provided by protective devices in the building installation;</p>		N/A
	<p>c) it is permitted for PLUGGABLE EQUIPMENT TYPE B or PERMANENTLY CONNECTED EQUIPMENT, to rely on dedicated overcurrent and short-circuit protection in the building installation, provided that the means of protection, e.g. fuses or circuit breakers, is fully specified in the installation instructions.</p> <p>If reliance is placed on protection in the building installation, the installation instructions shall so state, except that for PLUGGABLE EQUIPMENT TYPE A the building installation shall be regarded as providing protection in accordance with the rating of the wall socket outlet.</p>		N/A
2.7.2	This subclause has been declared 'void'.		N/A
3.2.3	Delete the NOTE in Table 3A, and delete also in this table the conduit sizes in parentheses.		N/A



IEC 60950-1									
Clause	Requirement + Test	Result - Remark	Verdict						
3.2.5.1	<p>Replace “60245 IEC 53” by “H05 RR-F”; “60227 IEC 52” by “H03 VV-F or H03 VVH2-F”; “60227 IEC 53” by “H05 VV-F or H05 VVH2-F2”.</p> <p>In Table 3B, replace the first four lines by the following:</p> <table style="margin-left: 20px;"> <tr> <td>Up to and including 6 </td> <td>0,75^{a)} </td> </tr> <tr> <td>Over 6 up to and including 10 (0,75)^{b)}</td> <td>1,0 </td> </tr> <tr> <td>Over 10 up to and including 16 (1,0)^{c)}</td> <td>1,5 </td> </tr> </table> <p>In the conditions applicable to Table 3B delete the words “in some countries” in condition^{a)}.</p> <p>In NOTE 1, applicable to Table 3B, delete the second sentence.</p>	Up to and including 6	0,75 ^{a)}	Over 6 up to and including 10 (0,75) ^{b)}	1,0	Over 10 up to and including 16 (1,0) ^{c)}	1,5		N/A
Up to and including 6	0,75 ^{a)}								
Over 6 up to and including 10 (0,75) ^{b)}	1,0								
Over 10 up to and including 16 (1,0) ^{c)}	1,5								
3.2.5.1 (A2:2013)	NOTE Z1 The harmonised code designations corresponding to the IEC cord types are given in Annex ZD		N/A						
3.3.4	<p>In Table 3D, delete the fourth line: conductor sizes for 10 to 13 A, and replace with the following:</p> <table style="margin-left: 20px;"> <tr> <td>Over 10 up to and including 16 </td> <td>1,5 to 2,5 </td> <td>1,5 to 4</td> </tr> <tr> <td style="text-align: center;"> </td> <td></td> <td></td> </tr> </table> <p>Delete the fifth line: conductor sizes for 13 to 16 A</p>	Over 10 up to and including 16	1,5 to 2,5	1,5 to 4					N/A
Over 10 up to and including 16	1,5 to 2,5	1,5 to 4							
4.3.13.6 (A1:2010)	<p>Replace the existing NOTE by the following:</p> <p>NOTE Z1 Attention is drawn to:</p> <p>1999/519/EC: Council Recommendation on the limitation of exposure of the general public to electromagnetic fields 0 Hz to 300 GHz, and</p> <p>2006/25/EC: Directive on the minimum health and safety requirements regarding the exposure of workers to risks arising from physical agents (artificial optical radiation).</p>		N/A						
	Standards taking into account mentioned Recommendation and Directive which demonstrate compliance with the applicable EU Directive are indicated in the OJEC.		N/A						
Annex H	<p>Replace the last paragraph of this annex by:</p> <p>At any point 10 cm from the surface of the OPERATOR ACCESS AREA, the dose rate shall not exceed 1 µSv/h (0,1 mR/h) (see NOTE). Account is taken of the background level.</p> <p>Replace the notes as follows:</p> <p>NOTE These values appear in Directive 96/29/Euratom.</p> <p>Delete NOTE 2.</p>		N/A						
Bibliography	Additional EN standards.		—						



IEC 60950-1			
Clause	Requirement + Test	Result - Remark	Verdict

ZA	NORMATIVE REFERENCES TO INTERNATIONAL PUBLICATIONS WITH THEIR CORRESPONDING EUROPEAN PUBLICATIONS	—
-----------	--	---

ZB ANNEX (normative) SPECIAL NATIONAL CONDITIONS (EN)			
1.2.4.1	In Denmark , certain types of Class I appliances (see 3.2.1.1) may be provided with a plug not establishing earthing conditions when inserted into Danish socket-outlets.		N/A
1.2.13.14 (A11:2009)	In Norway and Sweden , for requirements see 1.7.2.1 and 7.3 of this annex.		N/A
1.5.7.1 (A11:2009)	In Finland, Norway and Sweden , resistors bridging BASIC INSULATION in CLASS I PLUGGABLE EQUIPMENT TYPE A must comply with the requirements in 1.5.7.1. In addition when a single resistor is used, the resistor must withstand the resistor test in 1.5.7.2.		N/A
1.5.8	In Norway , due to the IT power system used (see annex V, Figure V.7), capacitors are required to be rated for the applicable line-to-line voltage (230 V).		N/A
1.5.9.4	In Finland, Norway and Sweden , the third dashed sentence is applicable only to equipment as defined in 6.1.2.2 of this annex.		N/A



IEC 60950-1			
Clause	Requirement + Test	Result - Remark	Verdict
ZB ANNEX (normative)			
SPECIAL NATIONAL CONDITIONS (EN)			
1.7.2.1	<p>In Finland, Norway and Sweden, CLASS I PLUGGABLE EQUIPMENT TYPE A intended for connection to other equipment or a network shall, if safety relies on connection to protective earth or if surge suppressors are connected between the network terminals and accessible parts, have a marking stating that the equipment must be connected to an earthed mains socket-outlet.</p> <p>The marking text in the applicable countries shall be as follows:</p> <p>In Finland: "Laite on liitettävä suojakoskettimilla varustettuun pistorasiaan"</p> <p>In Norway: "Apparatet må tilkoples jordet stikkontakt"</p> <p>In Sweden: "Apparaten skall anslutas till jordat uttag"</p>		N/A
1.7.2.1 (A11:2009)	<p>In Norway and Sweden, the screen of the cable distribution system is normally not earthed at the entrance of the building and there is normally no equipotential bonding system within the building. Therefore the protective earthing of the building installation need to be isolated from the screen of a cable distribution system.</p> <p>It is however accepted to provide the insulation external to the equipment by an adapter or an interconnection cable with galvanic isolator, which may be provided by e.g. a retailer.</p> <p>The user manual shall then have the following or similar information in Norwegian and Swedish language respectively, depending on in what country the equipment is intended to be used in:</p> <p>"Equipment connected to the protective earthing of the building installation through the mains connection or through other equipment with a connection to protective earthing – and to a cable distribution system using coaxial cable, may in some circumstances create a fire hazard. Connection to a cable distribution system has therefore to be provided through a device providing electrical isolation below a certain frequency range (galvanic isolator, see EN 60728-11)."</p>		



IEC 60950-1			
Clause	Requirement + Test	Result - Remark	Verdict
ZB ANNEX (normative)			
SPECIAL NATIONAL CONDITIONS (EN)			
	<p>NOTE In Norway, due to regulation for installations of cable distribution systems, and in Sweden, a galvanic isolator shall provide electrical insulation below 5 MHz. The insulation shall withstand a dielectric strength of 1,5 kV r.m.s., 50 Hz or 60 Hz, for 1 min.</p> <p>Translation to Norwegian (the Swedish text will also be accepted in Norway):</p> <p>“Utstyr som er koplet til beskyttelsesjord via nettplugg og/eller via annet jordtilkoplet utstyr – og er tilkoplet et kabel-TV nett, kan forårsake brannfare. For å unngå dette skal det ved tilkopling av utstyret til kabel-TV nettet installeres en galvanisk isolator mellom utstyret og kabel-TV nettet.”</p> <p>Translation to Swedish:</p> <p>”Utrustning som är kopplad till skyddsjord via jordat vägguttag och/eller via annan utrustning och samtidigt är kopplad till kabel-TV nät kan i vissa fall medföra risk för brand. För att undvika detta skall vid anslutning av utrustningen till kabel-TV nät galvanisk isolator finnas mellan utrustningen och kabel-TV nätet.”</p>		N/A
1.7.2.1 (A2:2013)	<p>In Denmark, CLASS I PLUGGABLE EQUIPMENT TYPE A intended for connection to other equipment or a network shall, if safety relies on connection to protective earth or if surge suppressors are connected between the network terminals and accessible parts, have a marking stating that the equipment must be connected to an earthed mains socket-outlet.</p> <p>The marking text in Denmark shall be as follows: In Denmark: “Apparatets stikprop skal tilsluttes en stikkontakt med jord, som giver forbindelse til stikproppens jord.”</p>		N/A
1.7.5 1.7.5 (A11:2009)	<p>In Denmark, socket-outlets for providing power to other equipment shall be in accordance with the Heavy Current Regulations, Section 107-2-D1, Standard Sheet DK 1-3a, DK 1-5a or DK 1-7a, when used on Class I equipment. For STATIONARY EQUIPMENT the socket-outlet shall be in accordance with Standard Sheet DK 1-1b or DK 1-5a.</p> <p>For CLASS II EQUIPMENT the socket outlet shall be in accordance with Standard Sheet DKA 1-4a.</p>		N/A



IEC 60950-1			
Clause	Requirement + Test	Result - Remark	Verdict
ZB ANNEX (normative)			
SPECIAL NATIONAL CONDITIONS (EN)			
1.7.5 (A2:2013)	In Denmark , socket-outlets for providing power to other equipment shall be in accordance with the DS 60884-2-D1:2011. For class I equipment the following Standard Sheets are applicable: DK 1-3a, DK 1-1c, DK 1-1d, DK 1-5a or DK 1-7a, with the exception for STATIONARY EQUIPMENT where the socket-outlets shall be in accordance with Standard Sheet DK 1-1b, DK 1-1c, DK 1-1d or DK 1-5a. Socket outlets intended for providing power to Class II apparatus with a rated current of 2,5 A shall be in accordance with DS 60884-2-D1 standard sheet DKA 1-4a. Other current rating socket outlets shall be in compliance with by DS 60884-2-D1 Standard Sheet DKA 1-3a or DKA 1-3b. Justification the Heavy Current Regulations, 6c		N/A
2.2.4	In Norway , for requirements see 1.7.2.1, 6.1.2.1 and 6.1.2.2 of this annex.		N/A
2.3.2	In Finland, Norway and Sweden there are additional requirements for the insulation. See 6.1.2.1 and 6.1.2.2 of this annex.		N/A
2.3.4	In Norway , for requirements see 1.7.2.1, 6.1.2.1 and 6.1.2.2 of this annex.		N/A
2.6.3.3	In the United Kingdom , the current rating of the circuit shall be taken as 13 A, not 16 A.		N/A
2.7.1	In the United Kingdom , to protect against excessive currents and short-circuits in the PRIMARY CIRCUIT of DIRECT PLUG-IN EQUIPMENT, tests according to 5.3 shall be conducted, using an external protective device rated 30 A or 32 A. If these tests fail, suitable protective devices shall be included as integral parts of the DIRECT PLUG-IN EQUIPMENT, so that the requirements of 5.3 are met.		N/A
2.10.5.13	In Finland, Norway and Sweden , there are additional requirements for the insulation, see 6.1.2.1 and 6.1.2.2 of this annex.		N/A
3.2.1.1	In Switzerland , supply cords of equipment having a RATED CURRENT not exceeding 10 A shall be provided with a plug complying with SEV 1011 or IEC 60884-1 and one of the following dimension sheets: SEV 6532-2.1991 Plug Type 15 3P+N+PE 250/400 V, 10 A		N/A



IEC 60950-1			
Clause	Requirement + Test	Result - Remark	Verdict
ZB ANNEX (normative)			
SPECIAL NATIONAL CONDITIONS (EN)			
	<p>SEV 6533-2.1991 Plug Type 11 L+N 250 V, 10 A</p> <p>SEV 6534-2.1991 Plug Type 12 L+N+PE 250 V, 10 A</p> <p>In general, EN 60309 applies for plugs for currents exceeding 10 A. However, a 16 A plug and socket-outlet system is being introduced in Switzerland, the plugs of which are according to the following dimension sheets, published in February 1998: SEV 5932-2.1998: Plug Type 25 , 3L+N+PE 230/400 V, 16 A</p> <p>SEV 5933-2.1998: Plug Type 21, L+N, 250 V, 16A</p> <p>SEV 5934-2.1998: Plug Type 23, L+N+PE .250 V, 16 A</p>		N/A
3.2.1.1	<p>In Denmark, supply cords of single-phase equipment having a rated current not exceeding 13 A shall be provided with a plug according to the Heavy Current Regulations, Section 107-2-D1.</p> <p>CLASS I EQUIPMENT provided with socket-outlets with earth contacts or which are intended to be used in locations where protection against indirect contact is required according to the wiring rules shall be provided with a plug in accordance with standard sheet DK 2-1a or DK 2-5a.</p> <p>If poly-phase equipment and single-phase equipment having a RATED CURRENT exceeding 13 A is provided with a supply cord with a plug, this plug shall be in accordance with the Heavy Current Regulations, Section 107-2-D1 or EN 60309-2.</p>		N/A



IEC 60950-1			
Clause	Requirement + Test	Result - Remark	Verdict
ZB ANNEX (normative)			
SPECIAL NATIONAL CONDITIONS (EN)			
3.2.1.1 (A2:2013)	<p>In Denmark, supply cords of single-phase equipment having a rated current not exceeding 13 A shall be provided with a plug according to DS 60884-2-D1.</p> <p>CLASS I EQUIPMENT provided with socket-outlets with earth contacts or which are intended to be used in locations where protection against indirect contact is required according to the wiring rules shall be provided with a plug in accordance with standard sheet DK 2-1a or DK 2-5a.</p> <p>If a single-phase equipment having a RATED CURRENT exceeding 13 A or if a poly-phase equipment is provided with a supply cord with a plug, this plug shall be in accordance with the standard sheets DK 6-1a in DS 60884-2-D1 or EN 60309-2.</p> <p>Justification the Heavy Current Regulations, 6c</p>		N/A
3.2.1.1	<p>In Spain, supply cords of single-phase equipment having a rated current not exceeding 10 A shall be provided with a plug according to UNE 20315:1994.</p> <p>Supply cords of single-phase equipment having a rated current not exceeding 2,5 A shall be provided with a plug according to UNE-EN 50075:1993.</p> <p>CLASS I EQUIPMENT provided with socket-outlets with earth contacts or which are intended to be used in locations where protection against indirect contact is required according to the wiring rules, shall be provided with a plug in accordance with standard UNE 20315:1994.</p> <p>If poly-phase equipment is provided with a supply cord with a plug, this plug shall be in accordance with UNE-EN 60309-2.</p>		N/A
3.2.1.1	<p>In the United Kingdom, apparatus which is fitted with a flexible cable or cord and is designed to be connected to a mains socket conforming to BS 1363 by means of that flexible cable or cord and plug, shall be fitted with a 'standard plug' in accordance with Statutory Instrument 1768:1994 - The Plugs and Sockets etc. (Safety) Regulations 1994, unless exempted by those regulations.</p> <p>NOTE 'Standard plug' is defined in SI 1768:1994 and essentially means an approved plug conforming to BS 1363 or an approved conversion plug.</p>		N/A



IEC 60950-1			
Clause	Requirement + Test	Result - Remark	Verdict
ZB ANNEX (normative)			
SPECIAL NATIONAL CONDITIONS (EN)			
3.2.1.1	In Ireland , apparatus which is fitted with a flexible cable or cord and is designed to be connected to a mains socket conforming to I.S. 411 by means of that flexible cable or cord and plug, shall be fitted with a 13 A plug in accordance with Statutory Instrument 525:1997 - National Standards Authority of Ireland (section 28) (13 A Plugs and Conversion Adaptors for Domestic Use) Regulations 1997.		N/A
3.2.4	In Switzerland , for requirements see 3.2.1.1 of this annex.		N/A
3.2.5.1	In the United Kingdom , a power supply cord with conductor of 1,25 mm ² is allowed for equipment with a rated current over 10 A and up to and including 13 A.		N/A
3.3.4	In the United Kingdom , the range of conductor sizes of flexible cords to be accepted by terminals for equipment with a RATED CURRENT of over 10 A up to and including 13 A is: • 1,25 mm ² to 1,5 mm ² nominal cross-sectional area.		N/A
4.3.6	In the United Kingdom , the torque test is performed using a socket outlet complying with BS 1363 part 1:1995, including Amendment 1:1997 and Amendment 2:2003 and the plug part of DIRECT PLUG-IN EQUIPMENT shall be assessed to BS 1363: Part 1, 12.1, 12.2, 12.3, 12.9, 12.11, 12.12, 12.13, 12.16 and 12.17, except that the test of 12.17 is performed at not less than 125 °C. Where the metal earth pin is replaced by an Insulated Shutter Opening Device (ISOD), the requirements of clauses 22.2 and 23 also apply.		N/A
4.3.6	In Ireland , DIRECT PLUG-IN EQUIPMENT is known as plug similar devices. Such devices shall comply with Statutory Instrument 526:1997 - National Standards Authority of Ireland (Section 28) (Electrical plugs, plug similar devices and sockets for domestic use) Regulations, 1997.		N/A



IEC 60950-1			
Clause	Requirement + Test	Result - Remark	Verdict
ZB ANNEX (normative) SPECIAL NATIONAL CONDITIONS (EN)			
5.1.7.1	<p>In Finland, Norway and Sweden TOUCH CURRENT measurement results exceeding 3,5 mA r.m.s. are permitted only for the following equipment:</p> <ul style="list-style-type: none">• STATIONARY PLUGGABLE EQUIPMENT TYPE A that is intended to be used in a RESTRICTED ACCESS LOCATION where equipotential bonding has been applied, for example, in a telecommunication centre; and has provision for a permanently connected PROTECTIVE EARTHING CONDUCTOR; and is provided with instructions for the installation of that conductor by a SERVICE PERSON;• STATIONARY PLUGGABLE EQUIPMENT TYPE B;• STATIONARY PERMANENTLY CONNECTED EQUIPMENT.		N/A



IEC 60950-1			
Clause	Requirement + Test	Result - Remark	Verdict

ZB ANNEX (normative)			
SPECIAL NATIONAL CONDITIONS (EN)			
6.1.2.1 (A1:2010)	<p>In Finland, Norway and Sweden, add the following text between the first and second paragraph of the compliance clause:</p> <p>If this insulation is solid, including insulation forming part of a component, it shall at least consist of either</p> <ul style="list-style-type: none"> - two layers of thin sheet material, each of which shall pass the electric strength test below, or - one layer having a distance through insulation of at least 0,4 mm, which shall pass the electric strength test below. <p>Alternatively for components, there is no distance through insulation requirements for the insulation consisting of an insulating compound completely filling the casing, so that CLEARANCES and CREEPAGE DISTANCES do not exist, if the component passes the electric strength test in accordance with the compliance clause below and in addition</p> <ul style="list-style-type: none"> - passes the tests and inspection criteria of 2.10.11 with an electric strength test of 1,5 kV multiplied by 1,6 (the electric strength test of 2.10.10 shall be performed using 1,5 kV), and - is subject to ROUTINE TESTING for electric strength during manufacturing, using a test voltage of 1,5 kV. 		N/A



IEC 60950-1			
Clause	Requirement + Test	Result - Remark	Verdict
ZB ANNEX (normative)			
SPECIAL NATIONAL CONDITIONS (EN)			
	<p>It is permitted to bridge this insulation with an optocoupler complying with 2.10.5.4 b).</p> <p>It is permitted to bridge this insulation with a capacitor complying with EN 60384-14:2005, subclass Y2.</p> <p>A capacitor classified Y3 according to EN 60384-14:2005, may bridge this insulation under the following conditions:</p> <ul style="list-style-type: none"> - the insulation requirements are satisfied by having a capacitor classified Y3 as defined by EN 60384-14, which in addition to the Y3 testing, is tested with an impulse test of 2,5 kV defined in EN 60950-1:2006, 6.2.2.1; - the additional testing shall be performed on all the test specimens as described in EN 60384-14: - the impulse test of 2,5 kV is to be performed before the endurance test in EN 60384-14, in the sequence of tests as described in EN 60384-14. 		N/A
6.1.2.2	In Finland, Norway and Sweden , the exclusions are applicable for PERMANENTLY CONNECTED EQUIPMENT, PLUGGABLE EQUIPMENT TYPE B and equipment intended to be used in a RESTRICTED ACCESS LOCATION where equipotential bonding has been applied, e.g. in a telecommunication centre, and which has provision for a permanently connected PROTECTIVE EARTHING CONDUCTOR and is provided with instructions for the installation of that conductor by a SERVICE PERSON.		N/A
7.2	In Finland, Norway and Sweden , for requirements see 6.1.2.1 and 6.1.2.2 of this annex. The term TELECOMMUNICATION NETWORK in 6.1.2 being replaced by the term CABLE DISTRIBUTION SYSTEM.		N/A
7.3 (A11:2009)	In Norway and Sweden , for requirements see 1.2.13.14 and 1.7.2.1 of this annex.		N/A



IEC 60950-1			
Clause	Requirement + Test	Result - Remark	Verdict

**Annex ZD
(informative)**

IEC and CENELEC code designations for flexible cords

Type of flexible cord	Code designations	
	IEC	CENELEC
PVC insulated cords		
Flat twin tinsel cord	60227 IEC 41	H03VH-Y
Light polyvinyl chloride sheathed flexible cord	60227 IEC 52	H03VV-F H03VVH2-F
Ordinary polyvinyl chloride sheathed flexible cord	60277 IEC 53	H05VV-F H05VVH2-F
Rubber insulated cords		
Braided cord	60245 IEC 51	H03RT-F
Ordinary tough rubber sheathed flexible cord	60245 IEC 53	H05RR-F
Ordinary polychloroprene sheathed flexible cord	60245 IEC 57	H05RN-F
Heavy polychloroprene sheathed flexible cord	60245 IEC 66	H07RN-F
Cords having high flexibility		
Rubber insulated and sheathed cord	60245 IEC 86	H03RR-H
Rubber insulated, crosslinked PVC sheathed cord	60245 IEC 87	H03RV4-H
Crosslinked PVC insulated and sheathed cord	60245 IEC 88	H03V4V4-H



1.5.1	TABLE: List of critical components					P
Object/part No.	Manufacturer/ trademark	Type/model	Technical data	Standard (Edition / year)	Mark(s) of conformity ¹⁾	
Power Adaptor	Interchangeable	Interchangeable	O/P: 24Vdc, 2.5A min., Tma=40°C min., Class I or II	IEC 60950- 1:2005+A1+A2, EN 60950- 1:2006+A11:200 9+A1:2010+A12: 2011+A2:2013	TUV, Semko, Nemko, Fimko, CB or equivalent National certified body, UL	
Metallic Chassis	Interchangeable	Interchangeable	Min. 1.0mm thickness.	--	--	
PCB	Interchangeable	Interchangeable	V-1 or better, 105°C min.	UL 796	UL	
HDD (Optional)	Toshiba	HDD2yyyx (x=A-Z or blank; y=0-9 or A-Z)	5Vdc, 1.4A max.	IEC 60959- 1:2005, EN 60950- 1:2006+A11+A1 +A12, UL 60950-1	TUV, UL	
HDD (Optional) (Alternate)	Interchangeable	Interchangeable	5Vdc, 1.4A max.	IEC 60959- 1:2005, EN 60950- 1:2006+A11+A1 +A12, UL 60950-1	TUV, Semko, Nemko, Fimko, CB or equivalent National certified body, UL	
RTC Battery (BAT1)	Panasonic	CR2032	Max. abnormal charge current 10 mA	UL 1642	UL	
RTC Battery (BAT1) (Alternate)	Interchangeable	CR2032	Max. abnormal charge current 10 mA	UL 1642	UL	
Polyswitch (FS9) (for Power Out 24V used)	Littelfuse	1812L150/24	24Vdc, 3.0A	IEC 60730-1, EN 60730-1, UL 1434	TUV, UL	
Polyswitch (FS2) (for VGA used)	FUZETEC	FSMD110- 0805RZ	6Vdc, 1.8A	IEC 60730-1, EN 60730-1, UL 1434	TUV, UL	
Protective IC (U84, U43, U44 and U46) (for USB 2.0 and USB 3.0 used)	Richtek	RT9715... (The first dot "." can be A or B; the second dot can be P or G; the third dot can be B, BG or BR)	2.7-5.5Vdc, 2.0A	IEC 60950- 1:2005; Comply with Annex CC of IEC 60950-1: 2005/ A1, UL 2367	CB by Nemko, UL	
Supplementary information:						
¹⁾ An asterisk indicates a mark that assures the agreed level of surveillance.						



1.6.2	TABLE: Electrical data (in normal conditions)					P
U (V)	I (A)	I _{rated} (A)	P (W)	Fuse #	I _{fuse} (A)	Condition/status
DC 24	2.42	2.5	58.08	--	--	Maximum normal load.
Supplementary information:						

2.1.1.5 c) 1)	TABLE: max. V, A, VA test				N/A
Voltage (rated) (V)	Current (rated) (A)	Voltage (max.) (V)	Current (max.) (A)	VA (max.) (VA)	
--	--	--	--	--	
--	--	--	--	--	
supplementary information:					
The external power adaptor had been evaluated.					

2.1.1.5 c) 2)	TABLE: stored energy			N/A
Capacitance C (µF)	Voltage U (V)	Energy E (J)		
--	--	--		
--	--	--		
supplementary information: --				
The external power adaptor had been evaluated.				

2.1.1.7	TABLE: Discharge test				N/A
Condition	τ calculated (s)	τ measured (s)	t _{u→0V} (s)	Comments	
--	--	--	--	--	
--	--	--	--	--	
Supplementary information:--					

2.2	TABLE: evaluation of voltage limiting components in SELV circuits			P
Component (measured between)	max. voltage (V) (normal operation)		Voltage Limiting Components	
	V peak	V d.c.		
--	--	--	--	
Fault test performed on voltage limiting components		Voltage measured (V) in SELV circuits (V peak or V d.c.)		



--	--
supplementary information:--	
The external power adaptor had been evaluated.	

2.4.2	TABLE: Limited current circuit measurement					N/A
Location	Voltage (V)	Current (mA)	Freq. (kHz)	Limit (mA)	Comments	
--	--	--	--	--	--	
--	--	--	--	--	--	
Supplementary information:--						

2.5	TABLE: limited power sources					P
Circuit output tested: See below.						
Note: Measured Uoc (V) with all load circuits disconnected: See below.						
Components	Sample No.	Uoc (V)	I _{sc} (A)		VA	
			Meas.	Limit	Meas.	Limit
Normal: USB2.0 port (CN44), Pin1 to GND	--	5.18	2.5	8	12.95	100
Normal: USB2.0 port (CN44), Pin2, 3 to GND	--	0	0	8	0	100
Normal: USB3.0 port (CN35), Pin1 to GND	--	5.18	2.5	8	12.95	100
Normal: USB3.0 port (CN35), Pin2, 3, 5, 6, 8, 9 to GND	--	0	0	8	0	100
Normal: USB3.0 port (CN35), Pin10 to GND	--	5.18	2.5	8	12.95	100
Normal: USB3.0 port (CN35), Pin11, 12, 14, 15, 17, 18 to GND	--	0	0	8	0	100



Normal: USB3.0 port (CN36), Pin1 to GND	--	5.18	2.5	8	12.95	100
Normal: USB3.0 port (CN36), Pin2, 3, 5, 6, 8, 9 to GND	--	0	0	8	0	100
Normal: USB3.0 port (CN36), Pin10 to GND	--	5.18	2.5	8	12.95	100
Normal: USB3.0 port (CN36), Pin11, 12, 14, 15, 17, 18 to GND	--	0	0	8	0	100
Normal: VGA port (CN47), Pin9 to GND	--	5.02	1.0	8	4.04	100
Normal: VGA port (CN47), Pin12, 15 to GND	--	5.15	0	8	0	100
Normal: VGA port (CN47), Pin10 to GND	--	4.89	0	8	0	100
Normal: VGA port (CN47), Pin1, 2, 3, 4, 5, 7, 8, 11, 13, 14 to GND	--	0	0	8	0	100



Normal: LAN port (CN42) Pin 1- 8 to GND	--	0	0	8	0	100
Normal: LAN port (CN42) Pin 1- 8 to GND	--	0	0	8	0	100
Normal: RS232 port (CN34), Pin1- 4, 6-13, 15-18 to GND	--	0	0	8	0	100
Normal: RS232 port (CN48), Pin1- 4, 6-13, 15-18 to GND	--	0	0	8	0	100
Normal: Power Out 24V (CN39) Pin 1 to GND	--	23.95	3.5	8	80.255	100
supplementary information:						
Sc=Short circuit, Oc=Open circuit						

2.6.3.4	TABLE: Resistance of earthing measurement			N/A
Location		Resistance measured (mΩ)	Comments	
--		--	--	
--		--	--	
Supplementary information:--				

2.10.2	Table: working voltage measurement			N/A
Location		RMS voltage (V)	Peak voltage (V)	Comments
--		--	--	--
--		--	--	--
supplementary information:--				
--				



2.10.3 and 2.10.4	TABLE: Clearance and creepage distance measurements					N/A
Clearance (cl) and creepage distance (cr) at/of/between:	U peak (V)	U r.m.s. (V)	Required cl (mm)	cl (mm)	Required cr (mm)	cr (mm)
Supplementary information:						

2.10.5	TABLE: Distance through insulation measurements					N/A
Distance through insulation (DTI) at/of:	U peak (V)	U rms (V)	Test voltage (V)	Required DTI (mm)	DTI (mm)	
Supplementary information:						



4.3.8	TABLE: Batteries								P
The tests of 4.3.8 are applicable only when appropriate battery data is not available						Approved RTC battery used.		P	
Is it possible to install the battery in a reverse polarity position?						No		P	
	Non-rechargeable batteries			Rechargeable batteries					
	Discharging		Un-intentional charging	Charging		Discharging		Reversed charging	
	Meas. current	Manuf. Specs.		Meas. current	Manuf. Specs.	Meas. current	Manuf. Specs.	Meas. current	Manuf. Specs.
Max. current during normal condition	--	--	0mA	--	--	--	--	--	--
Max. current during fault condition	--	--	0mA (R96 Short)	--	--	--	--	--	--
Max. current during fault condition	--	--	3.17mA (D2 short)	--	--	--	--	--	--
Test results:									
- Chemical leaks						No.		P	
- Explosion of the battery						No.		P	
- Emission of flame or expulsion of molten metal						No.		P	
- Electric strength tests of equipment after completion of tests						N/A		N/A	
Supplementary information:									

4.3.8	TABLE: Batteries								P
Battery category: Lithium									
Manufacturer: See appended table 1.5.1.									
Type / model.....: See appended table 1.5.1.									
Voltage: DC 3V									
Capacity: --									
Tested and Certified by (incl. Ref. No.): See appended table 1.5.1.									
Circuit protection diagram: See below									

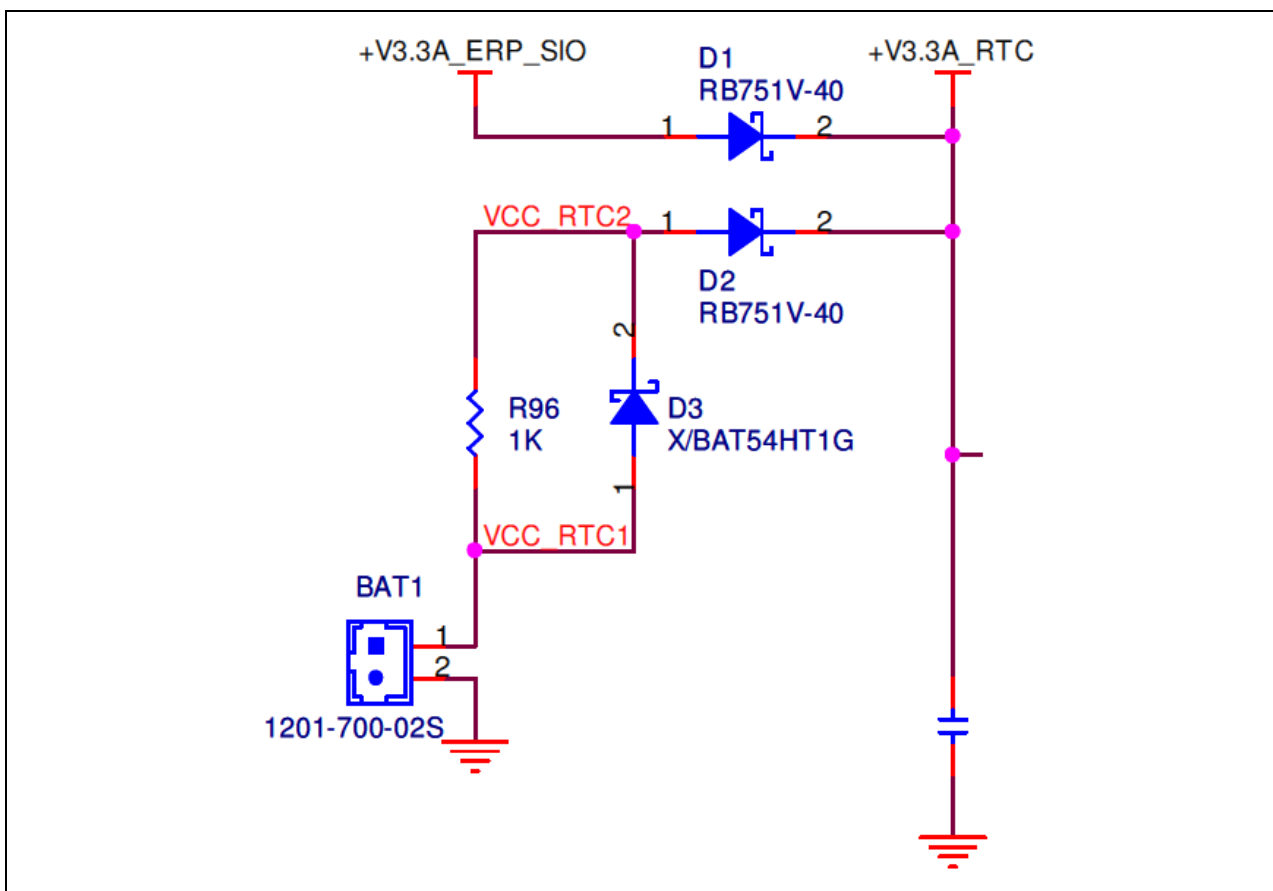

MARKINGS AND INSTRUCTIONS (1.7.13)	
Location of replaceable battery	Not located in OPERATOR ACCESS AREA
Language(s)	English
Close to the battery	N/A
In the servicing instructions	CAUTION: RISK OF EXPLOSION IF BATTERY IS REPLACED BY INCORRECT TYPE. DISPOSE OF USED BATTERIES ACCORDING TO INSTRUCTIONS
In the operating instructions	N/A

4.5	TABLE: Thermal requirements	P		
	Supply voltage (V)	DC 24V —		
	Ambient T _{min} (°C)	See below —		
	Ambient T _{max} (°C)	See below —		
	Maximum measured temperature T of part/at:	T (°C) Allowed T _{max} (°C)		
Test direction	a	b	c	--



PCB (near U1)	73.9	73.0	74.4	105
PCB (near U4)	68.1	67.3	69.1	105
L30 body	87.7	87.3	88.2	105
RTC Battery	76.1	75.0	77.0	--
HDD	66.7	67.9	69.7	--
Metal enclosure (top, near U1)	59.5	59.4	60.7	70
Metal enclosure (side, near U1)	57.5	58.4	63.5	70
T _{ma}	40.0	40.0	40.0	--
T _{amb}	21.3	20.8	20.2	--

Supplementary information:

Temperature T of winding:	t ₁ (°C)	R ₁ (Ω)	t ₂ (°C)	R ₂ (Ω)	T (°C)	Allowed T _{max} (°C)	Insulation class
--	--	--	--	--	--	--	--

Supplementary information:

1. The maximum ambient temperature permitted by the manufacturer's specification is 40°C.
2. The temperatures were measured under worst normal mode defined in 1.2.2.1 and as described in sub-clause 1.6.2 and at voltages as described above.
3. Test direction:
 - a. Desk-top
 - b. Output connector upward
 - c. Output connector downward

4.5.5	TABLE: Ball pressure test of thermoplastic parts			N/A
	Allowed impression diameter (mm)	≤ 2 mm		—
Part		Test temperature (°C)	Impression diameter (mm)	
--		--	--	
--		--	--	
Supplementary information:--				

4.6.1, 4.6.2	Table: enclosure openings		P
Location	Size (mm)	Comments	
Front / Rear / Top / Left / Right / Bottom	--	No openings	
Note(s):			



4.7	TABLE: Resistance to fire					P
Part	Manufacturer of material	Type of material	Thickness (mm)	Flammability class	Evidence	
Metallic chassis	--	--	1)	1)	1)	
PCB	--	--	--	1)	1)	
Supplementary information:						
1. See appended table 1.5.1.						

5.1	TABLE: touch current measurement			N/A
Measured between:	Measured (mA)	Limit (mA)	Comments/conditions	
--	--	--	--	
--	--	--	--	
supplementary information:--				
--				

5.2	TABLE: Electric strength tests, impulse tests and voltage surge tests			N/A
Test voltage applied between:	Voltage shape (AC, DC, impulse, surge)	Test voltage (V)	Breakdown Yes / No	
--	--	--	--	
--	--	--	--	
Supplementary information:--				

5.3	TABLE: Fault condition tests					P
Ambient temperature (°C)		25°C, if not specified			—	
Power source for EUT: Manufacturer, model/type, output rating		See appended table 1.5.1.			—	
Component No.	Fault	Supply voltage (V)	Test time	Fuse #	Fuse current (A)	Observation
D2	Short	DC 24V	10mins	--	--	Unit normal operation. No hazardous. No damaged. NC, NT.
Supplementary information:--						



C.2	TABLE: transformers						N/A
Loc.	Tested insulation	Working voltage peak / V (2.10.2)	Working voltage rms / V (2.10.2)	Required electric strength (5.2)	Required clearance / mm (2.10.3)	Required creepage distance / mm (2.10.4)	Required distance thr. insul. (2.10.5)
Loc.	Tested insulation			Test voltage/ V	Measured clearance / mm	Measured creepage dist./ mm	Measured distance thr. insul. / mm; number of layers
supplementary information:							

C.2	TABLE: transformers						N/A



Photo(s)

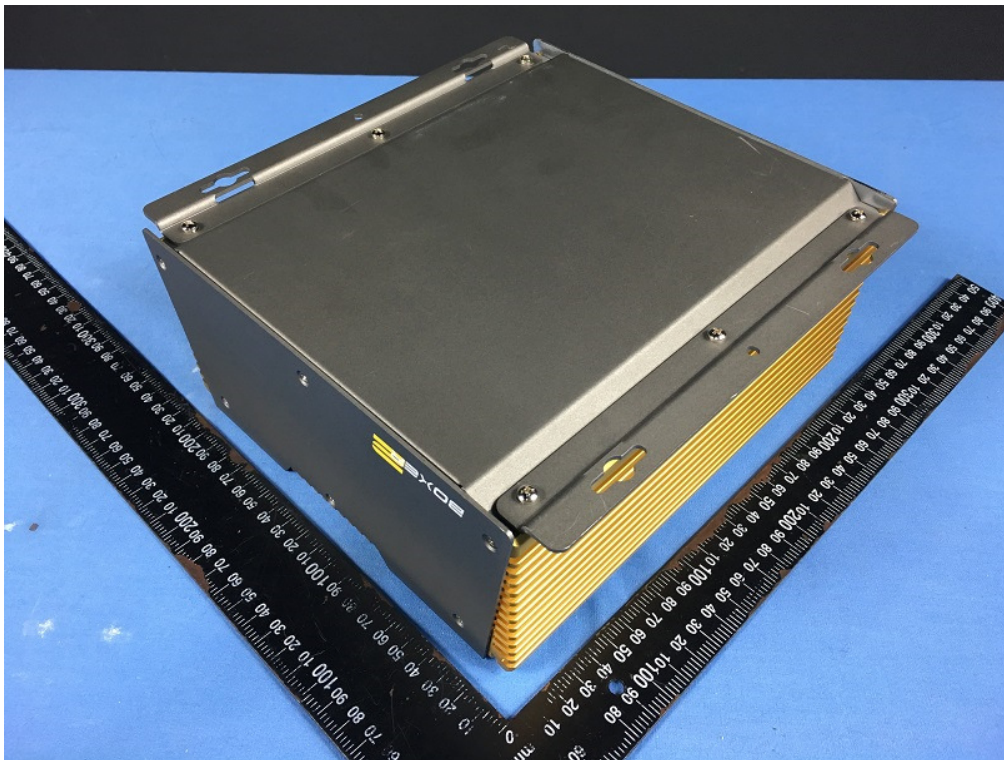
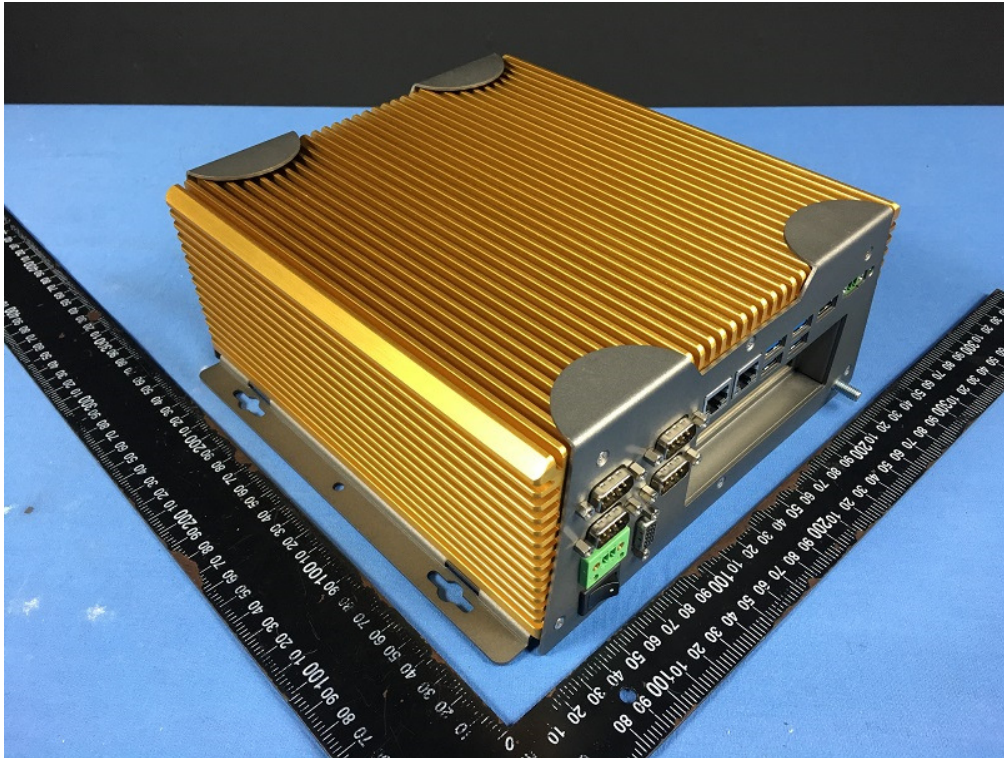



Photo(s)

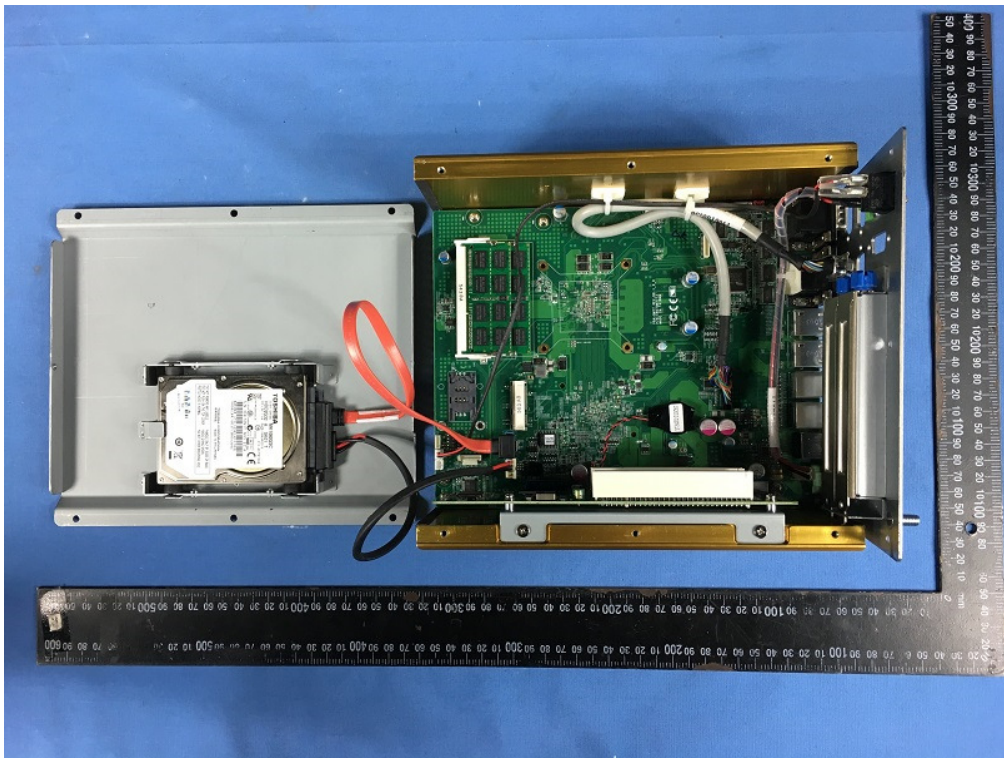



Photo(s)

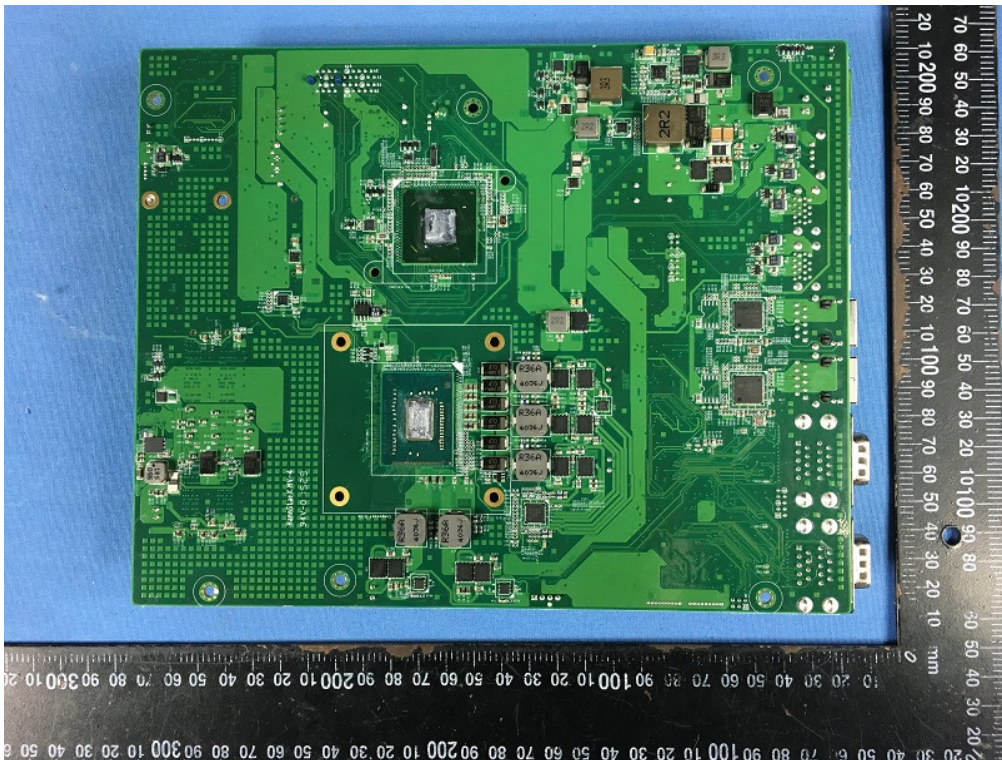
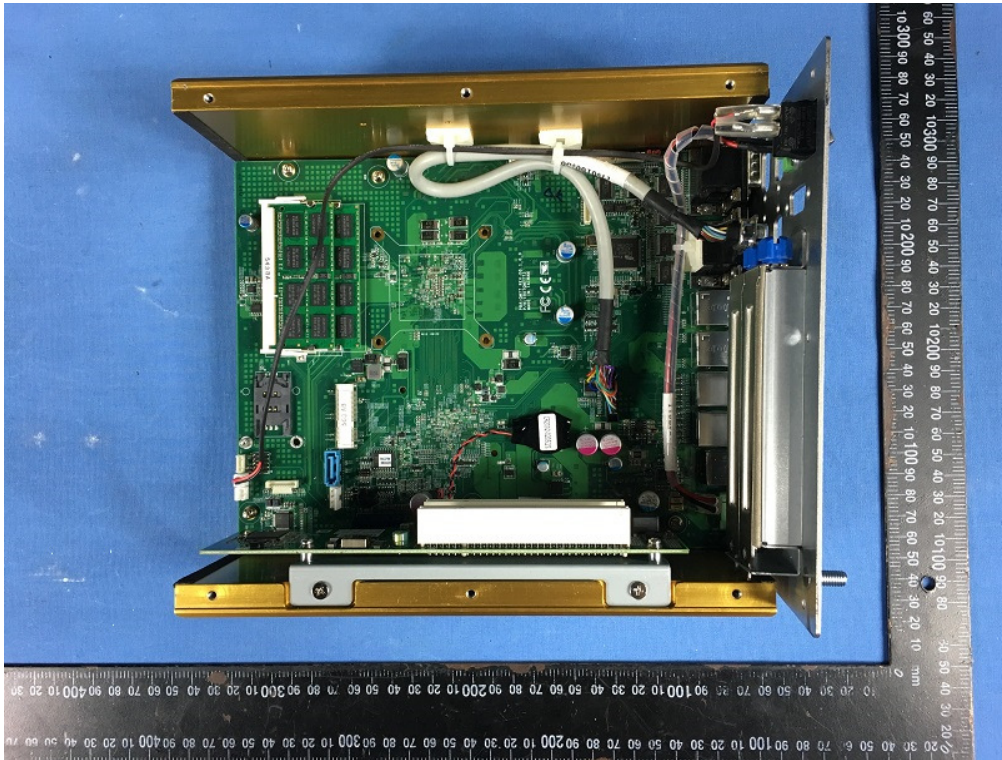



Photo(s)

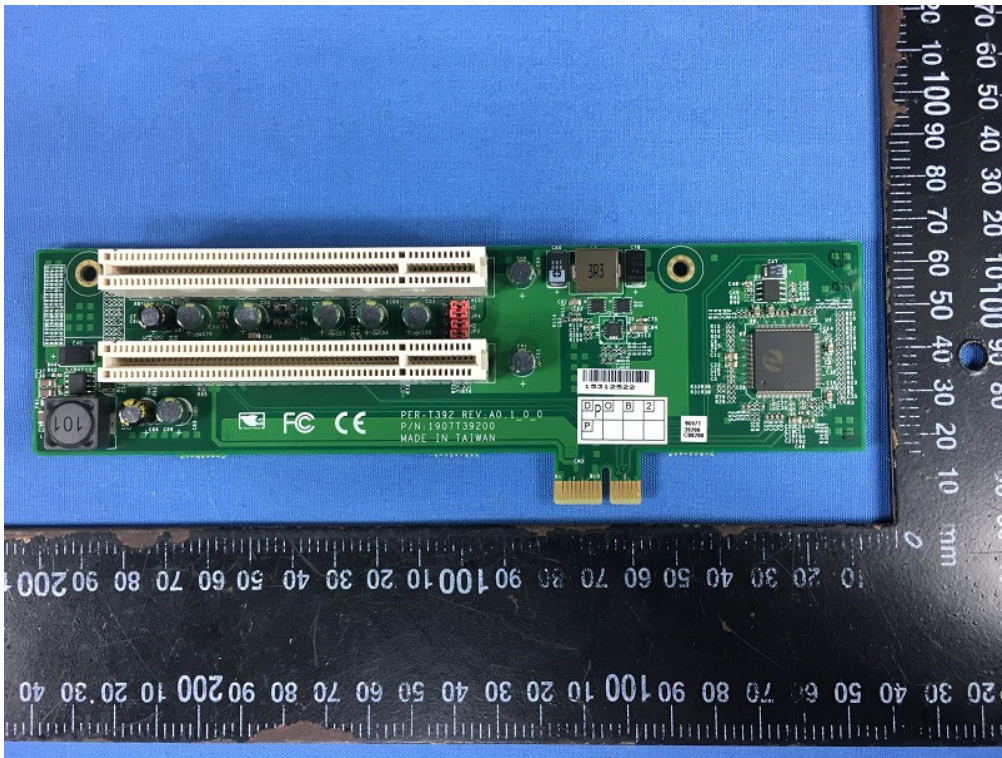
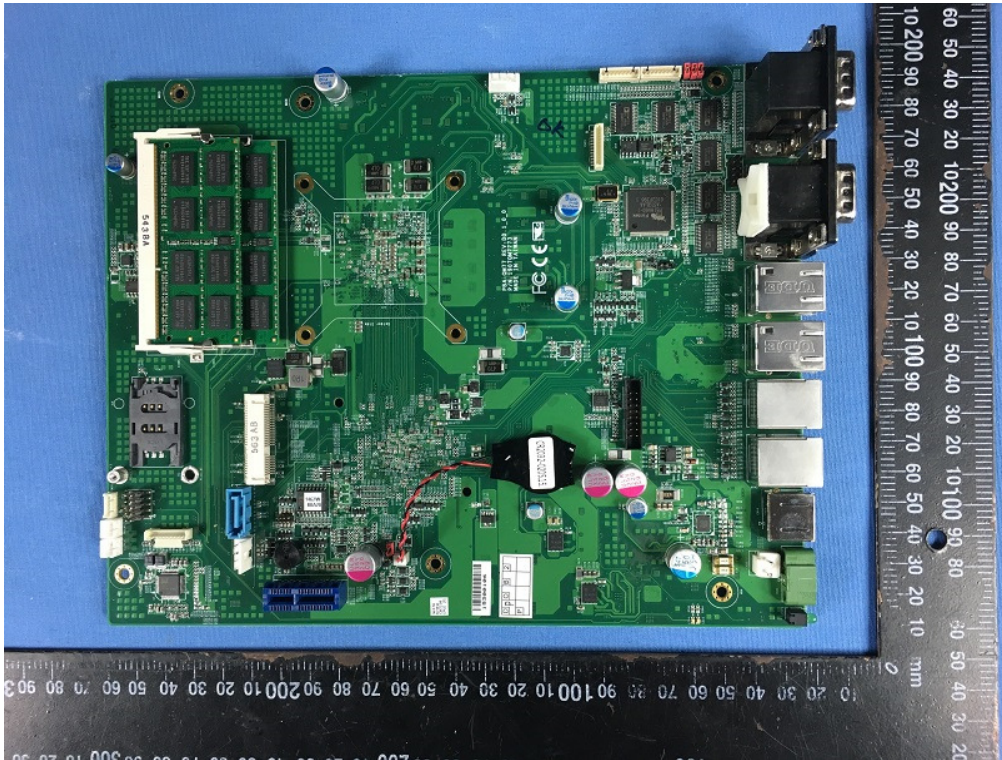



Photo(s)

