



**Spectrum Research
& Testing Lab., Inc.**

No. 101-10, Ling 8,
Shan-Tong Li, Chung-Li
City, Taoyuan, Taiwan,
R.O.C.

TEST REPORT

Reference No.:A03040208
Report No.:FCAA03040208
Page:1 of 18
Date:Apr. 17, 2003

Product Name: CPU board
Model No.: PCM-6892
Applicant: AAEON TECHNOLOGY INC.
5F, NO. 135, LANE 235, PAO CHIAO RD., HSIN-TIEN
CITY, TAIPEI, TAIWAN, R.O.C.
Date of Receipt: Apr. 02, 2003
Finished date of Test: Apr. 10, 2003
Applicable Standards: 47 CFR Part 15, Subpart B, Class A
ANSI C63.4:1992

We, **Spectrum Research & Testing Laboratory Inc.**, hereby certify that one sample of the above was tested in our laboratory with positive results according to the above-mentioned standards. The records in the report are an accurate account of the results. Details of the results are given in the subsequent pages of this report.

Checked By :

Sunyou Chen
(Sunyou Chen)

Date:

4/17/2003

Approved By :

J. Ho
(Johnson Ho, Director)

Date:

4/17/2003

NVLAP[®]

Lab Code: 200099-0



Table of Contents

1.	DOCUMENT POLICY AND TEST STATEMENT	3
1.1	DOCUMENT POLICY.....	3
1.2	TEST STATEMENT	3
2.	DESCRIPTION OF EUT AND TEST MODE.....	4
2.1	GENERAL DESCRIPTION OF EUT.....	4
2.2	DESCRIPTION OF EUT INTERNAL DEVICE.....	4
2.3	DESCRIPTION OF TEST MODE	4
2.4	DESCRIPTION OF SUPPORT UNIT.....	5
3.	DESCRIPTION OF APPLIED STANDARDS	5
4.	CONDUCTED EMISSION TEST	6
4.1	CONDUCTED EMISSION LIMIT	6
4.2	TEST EQUIPMENT	6
4.3	TEST SETUP	7
4.4	TEST PROCEDURE	7
4.5	EUT OPERATING CONDITION	7
4.6	TEST RESULT	8
5.	RADIATED EMISSION TEST	9
5.1	RADIATED EMISSION LIMIT	9
5.2	TEST EQUIPMENT.....	10
5.3	TEST SET-UP	11
5.4	TEST PROCEDURE	12
5.5	EUT OPERATING CONDITION	12
5.6	RADIATED EMISSION TEST RESULT	13
6.	PHOTOS OF TESTING	15
7.	TERMS OF ABRIVATION.....	18

 Spectrum Research & Testing Lab., Inc. No. 101-10, Ling 8, Shan-Tong Li, Chung-Li City, Taoyuan, Taiwan, R.O.C.	<h1>TEST REPORT</h1>	Reference No.:A03040208 Report No.:FCAA03040208 Page:4 of 18 Date:Apr. 17, 2003
--	----------------------	--

2. DESCRIPTION OF EUT AND TEST MODE

2.1 GENERAL DESCRIPTION OF EUT

PRODUCT	CPU board
MODEL NO.	PCM-6892
POWER SUPPLY	120V/60Hz
CABLE	N/A

NOTE:

For more detailed information, please refer to the EUT's specification or user's manual provided by manufacturer.

2.2 DESCRIPTION OF EUT INTERNAL DEVICE

DEVICE	BRAND / MAKER	MODEL #	FGC ID/DOC	REMARK
HDD	IBM	DJSA-210	N/A	

NOTE: The EUT was installed into a PC enclosure which contained the following devices and the CPU installed on EUT is Intel VIA Cyrix 667MHz, clock chip is 133MHz.
 The memory installed on EUT is 256MB.

2.3 DESCRIPTION OF TEST MODE

The EUT was pre-tested under the following video resolution:

640x480, 800x600 and 1600x1200

The worst emission was found under 1600x1200 and therefore the test data of only this mode is recorded.



**Spectrum Research
& Testing Lab., Inc.**
No. 101-10, Ling 8,
Shan-Tong Li, Chung-Li
City, Taoyuan, Taiwan,
R.O.C.

TEST REPORT

Reference No.:A03040208
Report No.:FCAA03040208
Page:3 of 18
Date:Apr. 17, 2003

1. DOCUMENT POLICY AND TEST STATEMENT

1.1 DOCUMENT POLICY

- The report shall not be reproduced except in full, without the written approval of SRT Lab, Inc.
- The report must not be used by the applicant to claim that the product is endorsed by NVLAP.
- The NVLAP logo applies only to the applicable standards specified in this report.

1.2 TEST STATEMENT

- The test results in the report apply only to the unit tested by SRT Lab.
- There was no deviation from the requirements of test standards during the test.
- AC power source, 120 Vac/60 Hz, was used during the test.



**Spectrum Research
& Testing Lab., Inc.**
No. 101-10, Ling 8,
Shan-Tong Li, Chung-Li
City, Taoyuan, Taiwan,
R.O.C.

TEST REPORT

Reference No.:A03040208
Report No.:FCAA03040208
Page:5 of 18
Date:Apr. 17, 2003

2.4 DESCRIPTION OF SUPPORT UNIT

The EUT was configured by the requirement of ANSI C63.4 and CISRP22. All interface ports were connected to the appropriate support units via specific cables. The support units and cables are listed below.

NO	DEVICE	BRAND	MODEL #	FCC ID / DOC	CABLE
1	MONITOR	SAMSUNG	PG17IS	DOC	1.5m unshielded power cord 1.2m shielded data cable
2	PRINTER	EPSON	STYLUS C20SX	DOC	1.5m unshielded power cord 1.2m shielded data cable
3	MODEM	ACEEX	DM-1414	DOC	1.5m unshielded DC power cable 1.2m shielded data cable
4	MODEM	ACEEX	DM-1414	DOC	1.5m unshielded DC power cable 1.2m shielded data cable
5	KEYBOARD	ACER	6311-TA	DOC	1.5m unshielded data cable
6	MOUSE	LOGITECH	M-S34	DZL211029	1.5m unshielded data cable
7	COM MOUSE	LOGITECH	M-M35	DOC	1.2m unshielded data cable
8	COM MOUSE	LOGITECH	M-M35	DOC	1.2m unshielded data cable
9	USB MOUSE	HP	M-S48A	JNZ2201213	1.2m unshielded data cable
10	USB MOUSE	HP	M-S48A	DOC	1.2m unshielded data cable
11	USB MOUSE	HP	M-S48A	DOC	1.2m unshielded data cable
12	USB MOUSE	HP	M-S48A	DOC	1.2m unshielded data cable
13	MICROPHONE	LABTEC	AXIS-301	N/A	2.4m unshielded data cable
14	MP3 PLAYER	CURSOR	GSR-A01C	N/A	1.5m unshielded data cable

NOTE: For the actual test configuration, please refer to the photos of testing.

3. DESCRIPTION OF APPLIED STANDARDS

The EUT is a kind of ITE and according to the specifications provided by the applicant, it must comply with the requirements of the following standards:
47 CFR Part 15 Subpart B, Class A

All tests have been performed and recorded as per the above standards.



Spectrum Research
& Testing Lab., Inc.
No. 101-10, Ling 8,
Shan-Tong Li, Chung-Li
City, Taoyuan, Taiwan,
R.O.C.

TEST REPORT

Reference No.:A03040208
Report No.:FCAA03040208
Page:6 of 18
Date:Apr. 17, 2003

4. CONDUCTED EMISSION TEST

4.1 CONDUCTED EMISSION LIMIT

FREQUENCY (MHz)	Class A (dB μ V)		Class B (dB μ V)	
	Quasi-peak	Average	Quasi-peak	Average
0.15 - 0.5	79	66	66 - 56	56 - 46
0.5 - 5.0	73	60	56	46
5.0 - 30.0	73	60	60	50

NOTE:

1. The lower limit shall apply at the transition frequencies.
2. The limit decreases in line with the logarithm of the frequency in the range of 0.15 to 0.50 MHz.

4.2 TEST EQUIPMENT

The following test equipment was used for the test :

EQUIPMENT/ FACILITIES	SPECIFICATIONS	MANUFACTURER	MODEL#/ SERIAL#	DUE DATE OF CAL. & CAL. CENTER
EMI TEST RECEIVER	9 kHz TO 30 MHz	ROHDE & SCHWARZ	ESHS30/ 826003/008	JUL. 2003 R&S
LISN	50 μ H, 50 ohm	SOLAR ELECTRONICS	8012-50-R-24-BNC / 924839	JUN. 2003 ETC
LISN	50 μ H, 50 ohm	SOLAR ELECTRONICS	9252-50-R-24-BNC / 951318	JUN. 2003 ETC

NOTE: The calibration interval of the above test equipment is one year and the calibrations are traceable to NML/ROC and NIST/USA.



4.3 TEST SETUP

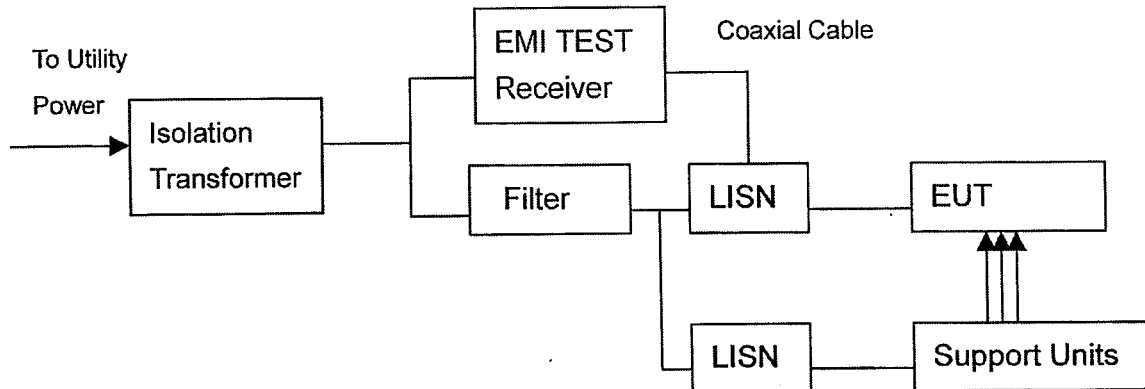

NOTE:

1. The EUT was put on a wooden table with 0.8m height above ground plane, and 0.4m away from reference ground plane (> 2m x 2m).
2. For the actual test configuration, please refer to the photos of testing.

4.4 TEST PROCEDURE

The EUT was tested according to the requirement of ANSI C63.4 and CISRP22. The frequency spectrum from 0.15 MHz to 30 MHz was investigated. The LISN used was 50 ohm/50µH as specified. All readings were quasi-peak and average values with 10 kHz resolution bandwidth of the test receiver. The EUT system was operated in all typical methods by users. Both lines of the power mains of EUT were measured and the cables connected to EUT and support units were moved to find the maximum emission levels for each frequency.

4.5 EUT OPERATING CONDITION

1. Under Windows 98 ran "EMI TEST", "WIN FCC" and "Media Player" programs.
2. PC sent "H" pattern or accessed the following peripherals directly or via EUT:
 - Color Monitor
 - RS232
 - Keyboard
 - Mouse
 - Printer
 - FDD
 - HDD
3. Accessed data from internet.



TEST REPORT

4.6 TEST RESULT

Temperature:	24 °C	Humidity:	59 %RH
Ferquency Range:	0.15 – 30 MHz	Test Mode	N/A
Receiver Detector:	Q.P. and AV.	Tested By:	Alen Chou

Power Line Measured : Line

Freq. (MHz)	Correct. Factor (dB)	Reading Value (dB μ V)		Emission Level (dB μ V)		Limit (dB μ V)		Margin (dB)	
		Q.P.	AV.	Q.P.	AV.	Q.P.	AV.	Q.P.	AV.
0.232	0.20	43.4	-	43.6	-	62.4	52.4	-18.8	N/A
0.298	0.20	40.8	-	41.0	-	60.3	50.3	-19.3	N/A
1.064	0.20	35.4	-	35.6	-	56.0	46.0	-20.4	N/A
1.369	0.20	32.5	-	32.7	-	56.0	46.0	-23.3	N/A
9.705	0.39	48.8	40.7	49.2	41.1	60.0	50.0	-10.8	-8.9
18.025	0.56	44.5	-	45.1	-	60.0	50.0	-14.9	N/A

Power Line Measured : Neutral

Freq. (MHz)	Correct. Factor (dB)	Reading Value (dB μ V)		Emission Level (dB μ V)		Limit (dB μ V)		Margin (dB)	
		Q.P.	AV.	Q.P.	AV.	Q.P.	AV.	Q.P.	AV.
0.232	0.20	42.2	-	42.4	-	62.4	52.4	-20.0	N/A
0.298	0.20	40.2	-	40.4	-	60.3	50.3	-19.9	N/A
0.982	0.20	35.5	-	35.7	-	56.0	46.0	-20.3	N/A
1.513	0.20	31.0	-	31.2	-	56.0	46.0	-24.8	N/A
9.705	0.39	48.8	-	49.2	-	60.0	50.0	-10.8	N/A
18.025	0.56	44.5	-	45.1	-	60.0	50.0	-14.9	N/A

NOTE :

1. Measurement uncertainty is 2dB
2. Emission level = Reading value + Correction factor
3. Correction Factor = Cable loss + Insertion loss of LISN
4. Margin value = Emission level - Limit
5. The emission of other frequencies were very low against the limit.
6. "-": The Quasi-peak reading value also meets average limit and measurement with the average detector is unnecessary.



Spectrum Research & Testing Lab., Inc.
 No. 101-10, Ling 8,
 Shan-Tong Li, Chung-Li
 City, Taoyuan, Taiwan,
 R.O.C.

TEST REPORT

Reference No.:A03040208
 Report No.:FCAA03040208
 Page:9 of 18
 Date:Apr. 17, 2003

5. RADIATED EMISSION TEST

5.1 RADIATED EMISSION LIMIT

CISPR 22 limits of radiated emission measurement for frequency below 1000 MHz

FREQUENCY (MHz)	Class A (at 10m)	Class B (at 10m)
	dB μ V/m	dB μ V/m
30 – 230	40	30
230 - 1000	47	37

NOTE:

1. The lower limit shall apply at the transition frequencies.
2. Emission level (dB μ V/m) = 20 log Emission level (μ V/m).

FCC Part 15, Subpart B limit of radiated emission for open case frequency above 1 GHz

FREQUENCY (MHz)	Class B (dB μ V/m) (at 3m)	
	PK	AV
Above 1000	80.0	60.0

FCC Part 15, Subpart B limit of radiated emission for open case frequency below 1GHz

FREQUENCY (MHz)	Class B (dB μ V/m) (at 3m)
	Q.P. or PK
30-88	46.0
88-216	49.5
216-960	52.0
Above 960	60.0

FCC Part 15, Subpart B limit of radiated emission for open case frequency above 1GHz

FREQUENCY (MHz)	Class B (dB μ V/m) (at 3m)	
	PK	AV
Above 1000	80.0	60.0



**Spectrum Research
& Testing Lab., Inc.**
No. 101-10, Ling 8,
Shan-Tong Li, Chung-Li
City, Taoyuan, Taiwan,
R.O.C.

TEST REPORT

Reference No.:A03040208
Report No.:FCAA03040208
Page:10 of 18
Date:Apr. 17, 2003

5.2 TEST EQUIPMENT

The following test equipment was used during the radiated emission test:

EQUIPMENT/ FACILITIES	SPECIFICATIONS	MANUFACTURER	MODEL#/ SERIAL#	DUE DATE OF CAL & CAL. CENTER
EMI TEST RECEIVER	9 kHz TO 2750 MHz	ROHDE & SCHWARZ	ESCS30/ 830245/012	AUG. 2003 R&S
BI-LOG ANTENNA	25 MHz TO 2 GHz	EMCO	3142/ 9701-1124	APR. 2004 SRT
SPECTRUM ANALYZER	9 KHz TO 26.5 GHz	HP	8593E/ 3710A03220	MAY 2003 ETC
PRE-AMPLIFIER	1 GHz TO 26.5 GHz	HP	8449B/ 3008A01019	JUN. 2003 ETC
HORN ANTENNA	1 GHz TO 18 GHz	EMCO	3115/ 9602-4681	DEC. 2003 ETC
OATS	3 – 10 M MEASUREMENT	SRT	SRT-1	MAY. 2003 SRT

NOTE:

1. The calibration interval of the above test equipment is one year and the calibrations are traceable to NML/ROC and NIST/USA.
2. The Open Area Test Site (SRT-1) is registered by FCC with No. 90957 and VCCI with No. R-1081.
3. The Open Area Test Site (SRT-2) is registered by FCC with No. 98458 and VCCI with No. R-1168.



5.3 TEST SET-UP

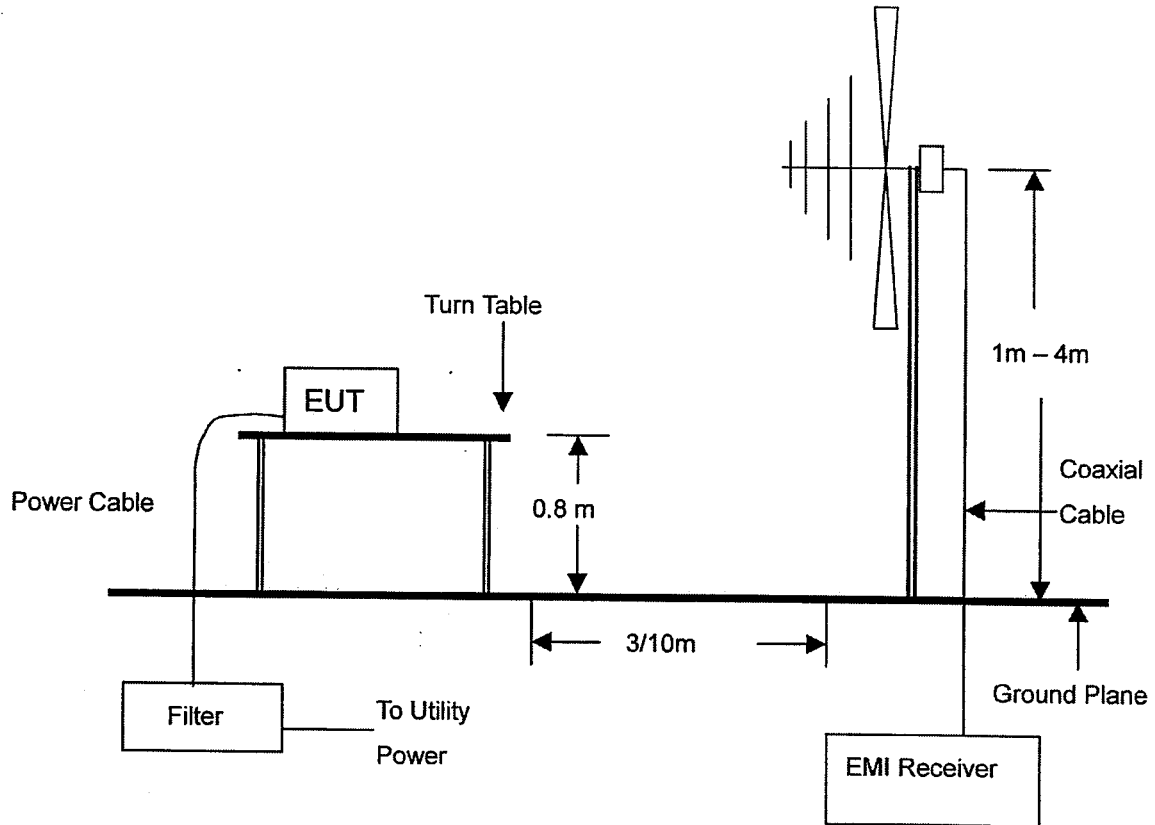

NOTE:

1. The EUT system was put on a wooden table with 0.8m heights above a ground plane.
2. For the actual test configuration, please refer to the photos of testing.



**Spectrum Research
& Testing Lab., Inc.**

No. 101-10, Ling 8,
Shan-Tong Li, Chung-Li
City, Taoyuan, Taiwan,
R.O.C.

TEST REPORT

Reference No.:A03040208
Report No.:FCAA03040208
Page:12 of 18
Date:Apr. 17, 2003

5.4 TEST PROCEDURE

The EUT was tested according to the requirement of ANSI C63.4 and CISPR 22. The measurements were made at an open area test site with 10 meter measurement distance under 1 GHz and with 3m distance above 1GHz. The frequency spectrum measured started from 30 MHz. Under 1 GHz, all readings were quasi-peak values with 120 kHz resolution bandwidth of the test receiver. Above 1 GHz, the measurements were made at an open area test site with 3 meter measurement distance and all readings were peak or average values with 1 MHz resolution bandwidth of the test receiver. The EUT system was operated in all typical methods by users. The cables connected to EUT and support units were moved to find the maximum emission levels for each frequency.

5.5 EUT OPERATING CONDITION

Same as section 4.5 of this report.



5.6 RADIATED EMISSION TEST RESULT

Temperature:	24 °C	Humidity:	62 %RH
Ferquency Range:	30 – 1000 MHz	Measured Distance:	10m
Receiver Detector:	Q.P.	Tested mode:	N/A
Tested by:	Alen Chou		

Antenna Polarization:Horizontal

Frequency (MHz)	Cable Loss (dB)	Antenna Factor (dB/m)	Reading Data (dBµV)	Emission Level (dBµV/m)	Limit (dBµV/m)	Margin (dB)	AZ(°)	EL(m)
121.4784	1.34	7.47	22.4	31.2	40.0	-8.8	128.3	4.00
133.1114	1.38	7.44	27.0	35.8	40.0	-4.2	360	4.00
202.4638	1.64	9.94	25.9	37.5	40.0	-2.5	328.4	4.00
665.5612	2.57	21.34	19.6	43.5	47.0	-3.5	20.9	1.32
798.6704	2.95	22.99	17.6	43.5	47.0	-3.5	90.4	1.36
931.7810	3.28	24.38	8.4	36.1	47.0	-10.9	133.7	1.20

Antenna Polarization:Vertical

Frequency (MHz)	Cable Loss (dB)	Antenna Factor (dB/m)	Reading Data (dBµV)	Emission Level (dBµV/m)	Limit (dBµV/m)	Margin (dB)	AZ(°)	EL(m)
121.4786	1.34	7.47	22.1	30.9	40.0	-9.1	346.9	1.00
133.1107	1.38	7.44	21.7	30.5	40.0	-9.5	349.4	1.00
399.3364	2.67	16.19	23.2	42.1	47.0	-4.9	157	1.00
665.5618	2.57	21.34	15.9	39.8	47.0	-7.2	190.1	1.00
798.6726	2.95	22.99	14.8	40.7	47.0	-6.3	191.6	1.15
931.7844	3.28	24.38	8.5	36.2	47.0	-10.8	29.2	3.31

NOTE:

1. Measurement uncertainty is 4dB.
2. "": Measurement does not apply for this frequency.
3. Emission Level = Reading Value + Ant. Factor + Cable Loss.
4. The field strength of other emission frequencies were very low against the limit.

Temperature:	24 °C	Humidity:	62 %RH
Ferquency Range:	1 – 5GHz	Measured Distance:	3m
Receiver Detector:	PK. or AV.	Tested mode:	N/A
Tested by:	Alen Chou		

Antenna Polarization : Horizontal

Frequency (MHz)	Correct Factor (dB)	Antenna Factor (dB/m)	Reading Data (dBμV)		Emission Level (dBμV/m)		Limit (dBμV/m)		Margin (dB)		AZ (°)	EL (m)
			PK.	AV.	PK.	AV.	PK.	AV.	PK.	AV.		
1336.3200	-33.07	25.18	60.1	50.3	52.2	42.4	80.0	60.0	-27.8	-17.6	237.0	1.0
1470.2500	-30.19	25.23	54.7	45.0	49.7	40.0	80.0	60.0	-30.3	-20.0	215.0	1.2
1512.1100	-31.44	25.35	56.5	46.9	50.4	40.8	80.0	60.0	-29.6	-19.2	115.0	1.3
1589.0900	-32.96	25.64	58.1	48.7	50.8	41.4	80.0	60.0	-29.2	-18.6	16.9	1.4
1604.7600	-32.91	25.70	59.3	49.6	52.1	42.4	80.0	60.0	-27.9	-17.6	306.0	1.9
1736.5700	-33.00	26.20	58.5	48.7	51.7	41.9	80.0	60.0	-28.3	-18.1	229.0	2.1

Antenna Polarization : Vertical

Frequency (MHz)	Correct Factor (dB)	Antenna Factor (dB/m)	Reading Data (dBμV)		Emission Level (dBμV/m)		Limit (dBμV/m)		Margin (dB)		AZ (°)	EL (m)
			PK.	AV.	PK.	AV.	PK.	AV.	PK.	AV.		
1336.3900	-33.07	24.94	64.3	54.7	56.2	46.6	80.0	60.0	-23.8	-13.4	46.9	1.0
1566.2100	-33.01	25.55	60.1	50.6	52.6	43.1	80.0	60.0	-27.4	-16.9	74.5	1.0
1604.6200	-32.91	25.70	60.5	50.8	53.3	43.6	80.0	60.0	-26.7	-16.4	106.0	1.5
1645.1700	-32.75	25.85	57.7	48.2	50.8	41.3	80.0	60.0	-29.2	-18.7	351.0	1.5
1670.2300	-32.81	25.95	58.2	48.5	51.3	41.6	80.0	60.0	-28.7	-18.4	127.0	1.8
1735.7400	-33.00	26.19	58.9	49.4	52.1	42.6	80.0	60.0	-27.9	-17.4	52.4	2.2

NOTE

1. Measurement uncertainty is 4dB.
2. "": Measurement does not apply for this frequency.
3. Emission Level = Reading Value + Ant. Factor + Cable Loss.
4. The field strength of other emission frequencies were very low against the limit.
5. "-": The Peak reading value also meets average limit and measurement with the average detector is unnecessary.



**Spectrum Research
& Testing Lab., Inc.**
No. 101-10, Ling 8,
Shan-Tong Li, Chung-Li
City, Taoyuan, Taiwan,
R.O.C.

TEST REPORT

Reference No.:A03040208
Report No.:FCAA03040208
Page:15 of 18
Date:Apr. 17, 2003

6. PHOTOS OF TESTING - Conducted test

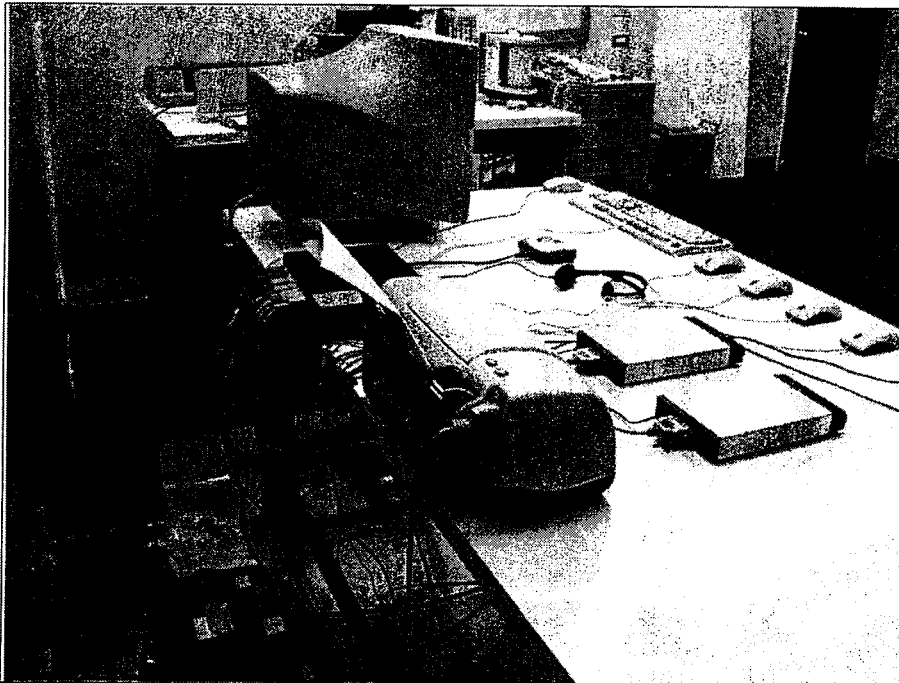
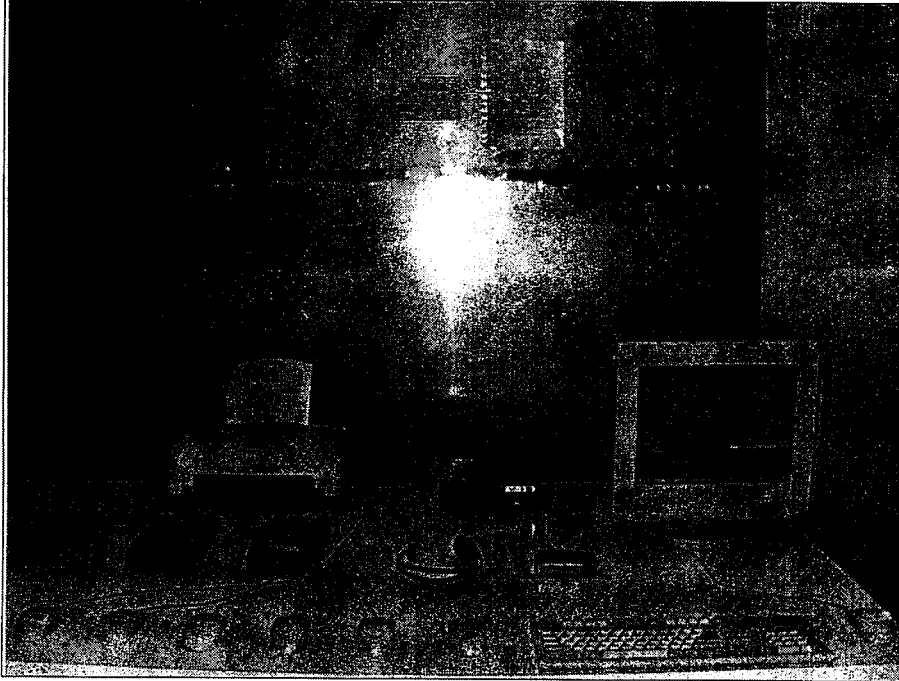



**Spectrum Research
& Testing Lab., Inc.**
No. 101-10, Ling 8,
Shan-Tong Li, Chung-Li
City, Taoyuan, Taiwan,
R.O.C.

TEST REPORT

Reference No.:A03040208
Report No.:FCAA03040208
Page:16 of 18
Date:Apr. 17, 2003

- Radiated test : below 1GHz

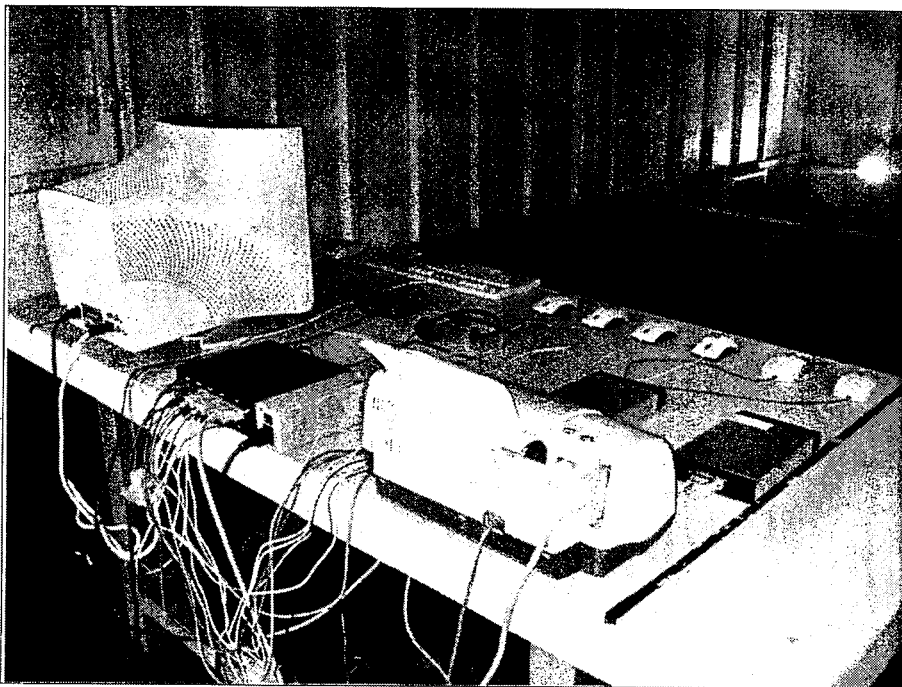
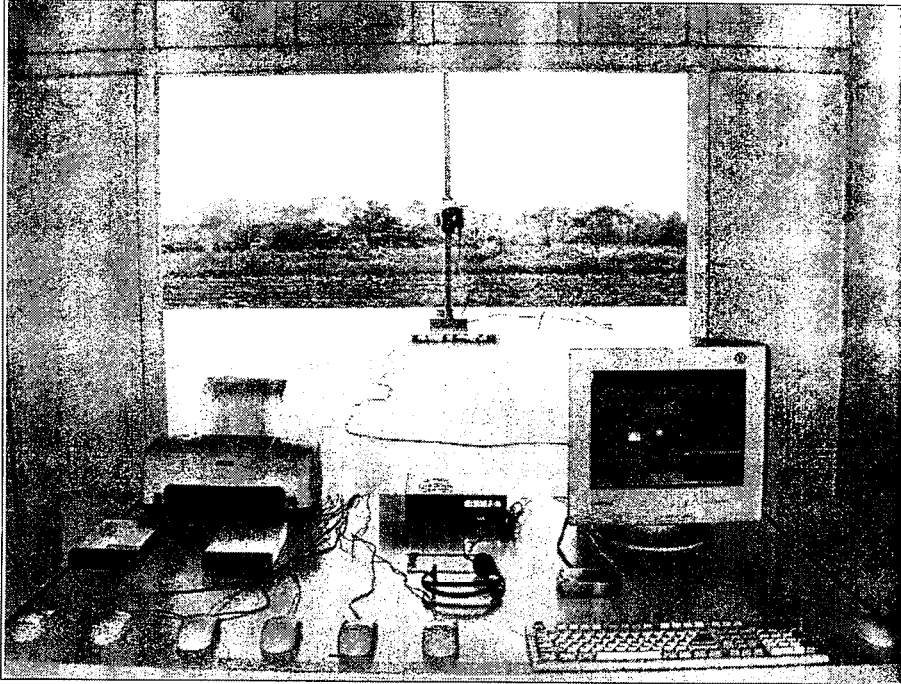



**Spectrum Research
& Testing Lab., Inc.**
No. 101-10, Ling 8,
Shan-Tong Li, Chung-Li
City, Taoyuan, Taiwan,
R.O.C.

TEST REPORT

Reference No.:A03040208
Report No.:FCAA03040208
Page:17 of 18
Date:Apr. 17, 2003

- Radiated test : Above 1GHz

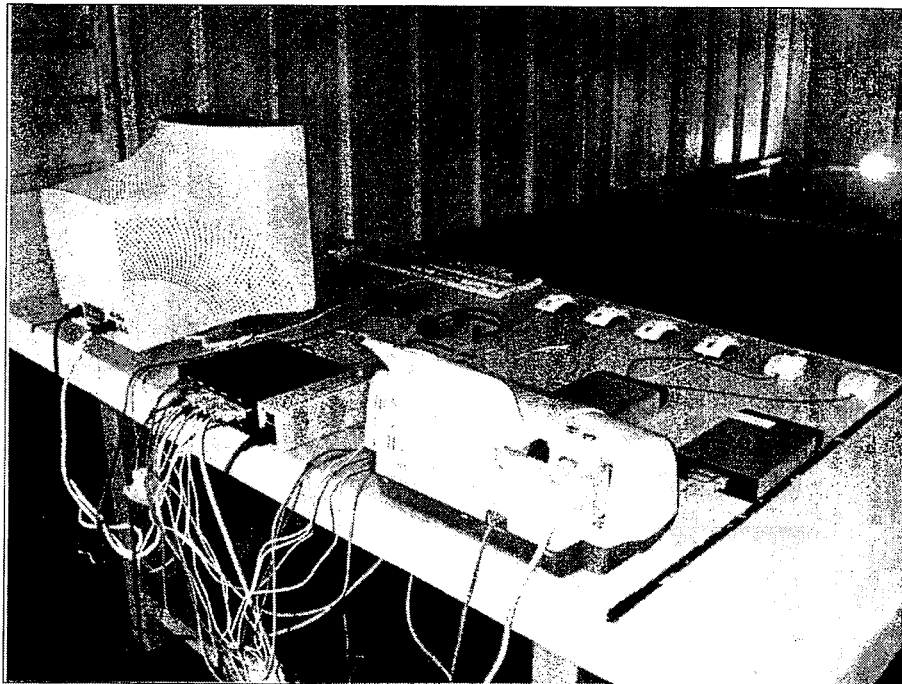
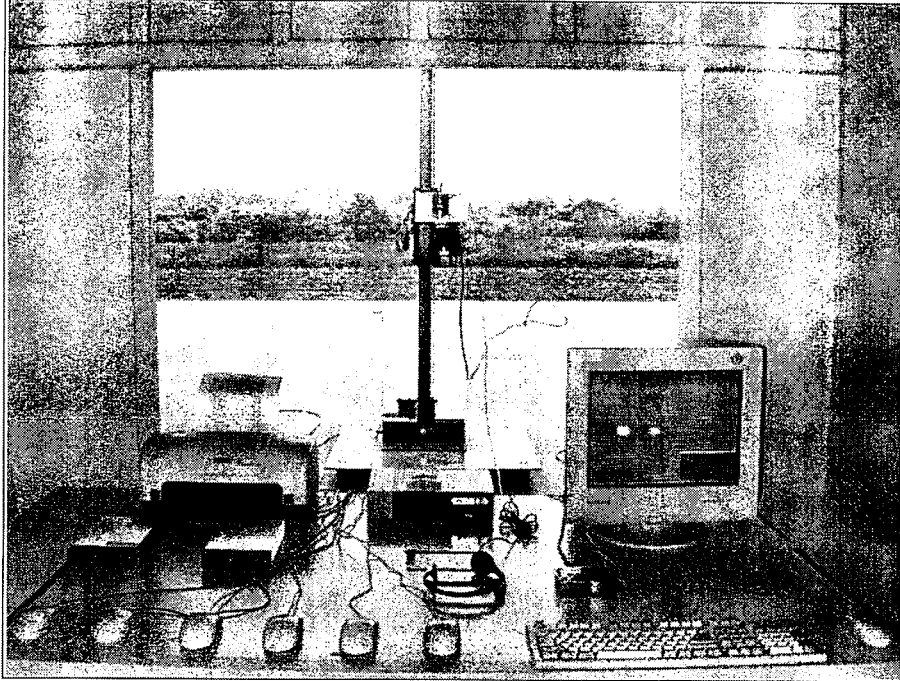



**Spectrum Research
& Testing Lab., Inc.**
No. 101-10, Ling 8.
Shan-Tong Li, Chung-Li
City, Taoyuan, Taiwan,
R.O.C.

TEST REPORT

Reference No.:A03040208
Report No.:FCAA03040208
Page:18 of 18
Date:Apr. 17, 2003

7. TERMS OF ABRIVATION

AV.	Average detection
AZ(°)	Turn table azimuth
Correct.	Correction
EL(m)	Antenna height (meter)
EUT	Equipment Under Test
Horiz.	Horizontal direction
LISN	Line Impedance Stabilization Network
NSA	Normalized Site Attenuation
Q.P.	Quasi-peak detection
SRT Lab	Spectrum Research & Testing Laboratory, Inc.
Vert.	Vertical direction