

# FCC CLASS A COMPLIANCE REPORT (Verification)

for

Electromagnetic Emissions

of

**CPU Board**

**Trade Name** : N/A  
**Model Number** : GENE-6320(N)  
**Serial Number** : N/A  
**Report Number** : 02E0265-D  
**Date** : June 26, 2002

Prepared for :  
**AAEON Technology Inc.**  
5F, No. 135, Lane 235, Pao Chiao Rd., Hsin-Tien City,  
Taipei, Taiwan, R. O. C.



Prepared by :  
**C&C LABORATORY, CO., L3TD.**  
#B1, 1<sup>st</sup> Fl., Universal Center,  
No. 183, Sec. 1, Tatung Rd., Hsi Chih,  
Taipei Hsien, Taiwan, R.O.C.  
TEL: (02)8642-2071~3  
FAX: (02)8642-2256

**This report shall not be reproduced, except in full, without the written approval of  
C&C Laboratory, Co., Ltd.**

## TABLE OF CONTENTS

DESCRIPTION	PAGE
VERIFICATION OF COMPLIANCE	3
SYSTEM DESCRIPTION	4
PRODUCT INFORMATION	5
SUPPORT EQUIPMENT	6
MEASUREMENT PROCEDURE & LIMIT (LINE CONDUCTED EMISSION TEST)	7
MEASUREMENT PROCEDURE & LIMIT (RADIATED EMISSION TEST)	9
SUMMARY DATA	11
TEST FACILITY	13
TEST EQUIPMENT	14
BLOCK DIAGRAM OF TEST SETUP	15
APPENDIX 1 PHOTOGRAPHS (TEST SETUP OF LINE CONDUCTED EMISSION TEST)	16
APPENDIX 2 PHOTOGRAPHS (TEST SETUP OF RADIATED EMISSION TEST)	18
APPENDIX 3 PHOTOGRAPHS OF EUT	20
APPENDIX 4 CONDUCTED EMISSION PLOT & RADIATED EMISSION DATA	25

## VERIFICATION OF COMPLIANCE

**Equipment Under Test:** CPU Board  
**Trade Name:** N/A  
**Model Number:** GENE-6320(N)  
**Serial Number:** N/A  
**Applicant:** **AAEON Technology Inc.**  
5F, No. 135, Lane 235, Pao Chiao Rd., Hsin-Tien City,  
Taipei, Taiwan, R. O. C.  
**Manufacturer:** **AAEON Technology Inc.**  
5F, No. 135, Lane 235, Pao Chiao Rd., Hsin-Tien City,  
Taipei, Taiwan, R. O. C.  
**Type of Test:** FCC Class A (Verification)  
**Measurement Procedure:** ANSI C63.4: 1992 / EN55022  
**File Number:** 02E0265-D  
**Date of test:** June 19, 2002  
**Deviation:** None  
**Condition of Test Sample:** Normal

The above equipment was tested by C&C Laboratory, Co., Ltd. for compliance with the requirements set forth in the FCC Rules and Regulations Part 15, Subpart B and the measurement procedure according to ANSI C63.4. This said equipment in the configuration described in this report shows the maximum emission levels emanating from equipment are within the compliance requirements.

The test results of this report relate only to the tested sample identified in this report.



\_\_\_\_\_  
**Authorized Signatory**

\_\_\_\_\_  
**Responsible Party**

\_\_\_\_\_  
**Officer of the Responsible Party**

## **SYSTEM DESCRIPTION**

### **EUT Test Procedure:**

1. Windows 98 Boots System.
2. Run EMITEST.EXE To activate all device.
3. Run EMCTEST.EXE to activate display “H” pattern on monitor screen.
4. Press the start menu, select exective and type ping 192.168.0.1 –t(EUT), ping  
192.168.0.2 –t(Server PC).

## PRODUCT INFORMATION

<b>Housing Type:</b>	Metal case
<b>EUT Power Rating:</b>	DC +12V from AC Adaptor
<b>AC power during Test:</b>	120VAC, 60Hz to AC Adaptor
<b>AC Adaptor Manufacturer:</b>	CHI
<b>AC Adaptor Model Number:</b>	CH-1205
<b>AC Power Cord Type:</b>	Unshielded, 1.8m (Detachable)
<b>DC Power Cable Type:</b>	Unshielded, 0.75m (Non-detachable, with a core)
<b>CPU Frequency:</b>	Intel Celeron-300MHz (3 x 100MHz)

### I/O Port of EUT:

I/O PORT TYPES	Q' TY	TESTED WITH
1). USB Port	2	2
2). PS/2 Port	1	1
3). RJ45 Port	1	1
4). Serial Port	2	2
5). D-SUB Port (VGA)	1	1
6). Parallel Port	1	1
7). Phone Jack	3	3
8). Video-out	1	1
9). S-Video-out	1	1
10).SCSI	1	0

**Note:** N/A

## SUPPORT EQUIPMENT

### EUT Device:

Equipment	Model#	Serial#	Trade Name
CPU(Intel Celeron-300MHz)	N/A	N/A	INTEL
Chassis	AEC-6000	N/A	N/A
Power Board	AEC-6000 Rev.A0.2	N/A	N/A
RAM(SDRAM 64MB PC100)	SIEMENS HYB39S64160AT-8	N/A	SODIM

### External Peripheral Devices:

No	Equipment	Model #	Serial #	FCC ID	Trade Name	Data Cable	Power Cord
1.	PLAYER	RQ-L309GT	N/A	N/A	PANASONIC	Unshielded, 1.2m	N/A
2.	EAR./MIC.	MSB-206	N/A	N/A	E.SENSE	Unshielded, 2.3 m	N/A
3.	USB MOUSE	M-BE58	LZE20302464	DoC BSMI3892A471	LOGITECH	Shielded, 1.9m	N/A
4.	USB MOUSE.	M-BE58	LZE20232357	DoC BSMI3892A471	LOGITECH	Shielded, 1.9m	N/A
5.	PS/2 MOUSE	M-S34	LZE12352345	DZL211029 BSMI4862A011	LOGITECH	Shielded, 1.9m	N/A
6.	PS/2 KEYBOARD	6311-TW4C/6	N/A	BSMI4862A064	ACER	Shielded, 1.7m	N/A
7.	LCD MONITOR	RB17NS	N/A	DoC BSMI3902B332	SAMSUNG	Shielded, 1.85m Shielded, 1.5m	Unshielded, 1.8m with a core
8.	PRINTER	EPSONSTYLUS C20SX	DW4E126674	BSMI3902E004	EPSON	Shielded, 1.7m	Unshielded, 1.8m
9.	MONITOR	PN21MS	N/A	DoC	SAMSUNG	Shielded, 1.8m with two cores	Unshielded, 1.8m
10	MODEM	2496CF	N/A	N/A	DATATRONICS	Shielded, 1.4 m	Unshielded, 1.8m
11	MODEM	1414	N/A	IFAXDM1414	ACEEX	Shielded, 1.5m	Unshielded, 1.8m
12	SERVER PC	EVOD300	6K1BKF83F0ZP	DoC	COMPAQ	Unshielded, 20m	Unshielded, 1.8m

**Note:** All the above equipment/cables were placed in worse case positions to maximize emission signals.

**Grounding:** Grounding was in accordance with the manufacturer's requirements and conditions for the intended use.

## **MEASUREMENT PROCEDURE (PRELIMINARY LINE CONDUCTED EMISSION TEST)**

- 1) The equipment was set up as per the test configuration to simulate typical actual usage per the user's manual. When the EUT is a tabletop system, a wooden table with a height of 0.8 meters is used and is placed on the ground plane as per ANSI C63.4 (see Test Facility for the dimensions of the ground plane used). When the EUT is a floor-standing equipment, it is placed on the ground plane which has a 3-12 mm non-conductive covering to insulate the EUT from the ground plane.
- 2) Support equipment, if needed, was placed as per ANSI C63.4.
- 3) All I/O cables were positioned to simulate typical actual usage as per ANSI C63.4.
- 4) The EUT received DC +12V power through AC Adaptor and Line Impedance Stabilization Network (LISN) which supplied power source of 120VAC/ 60Hz and was grounded to the ground plane.
- 5) All support equipment received power from a second LISN supplying power of 110VAC/60Hz, if any.
- 6) The EUT test program was started. Emissions were measured on each current carrying line of the EUT using a spectrum Analyzer / Receiver connected to the LISN powering the EUT. The LISN has two monitoring points: Line 1 (Hot Side) and Line 2 (Neutral Side). Two scans were taken: one with Line 1 connected to Analyzer / Receiver and Line 2 connected to a 50 ohm load; the second scan had Line 1 connected to a 50 ohm load and Line 2 connected to the Analyzer / Receiver.
- 7) Analyzer / Receiver scanned from 150kHz to 30MHz for emissions in each of the test modes.
- 8) During the above scans, the emissions were maximized by cable manipulation.
- 9) The following test mode(s) were scanned during the preliminary test:

**Mode(s):**

No.	Mode of operation	Date	Data Report/Plot No.
1	<b>S-Video Mode</b>	<b>06/19/2002</b>	<b>0265C#( 82, 84 )</b>
2	<b>S-Video Mode</b>	<b>06/19/2002</b>	<b>0261C#( 35, 36 )</b>
3	<b>Video Mode</b>	<b>06/19/2002</b>	<b>0261C#( 33, 34 )</b>
4	<b>1024 X 768</b>	<b>06/19/2002</b>	<b>0261C#( 31, 32 )</b>
5	<b>800 X 600</b>	<b>06/19/2002</b>	<b>0261C#( 29, 30 )</b>
6	<b>640 X 480</b>	<b>06/19/2002</b>	<b>0261C#( 27, 28 )</b>

- 10) After the preliminary scan, we found the following test mode(s) producing the highest emission level.

**Mode: 1.**

Then, the EUT configuration and cable configuration of the above highest emission level were recorded for reference of final testing.

## MEASUREMENT PROCEDURE (FINAL LINE CONDUCTED EMISSION TEST)

- 1) EUT and support equipment was set up on the test bench as per step 10 of the preliminary test.
- 2) A scan was taken on both power lines, Line 1 and Line 2, recording at least the six highest emissions. Emission frequency and amplitude were recorded into a computer in which correction factors were used to calculate the emission level and compare reading to the applicable limit. If EUT emission level was less -2dB to the A.V. limit in Q.P. mode, then the emission signal was re-checked using an Average detector.
- 3) The test data of the worst case condition(s) was reported on the Summary Data page.

### Data Sample:

Freq (MHz)	Meter Reading (dBuV)	C.F. (dB)	Corrected Reading (dBuV)	Limits (dBuV)	Margin (dB)	Reading Type (P/Q/A)	Line (L1/L2)
<b>x.xx</b>	<b>x.xx</b>	<b>x.xx</b>	<b>48.38</b>	<b>66.00</b>	<b>-17.62</b>	<b>A</b>	<b>L1</b>

C.F.(Correction Factor)=Insertion Loss + Cable Loss

Corrected Reading = Metering Reading + C.F.

Margin=Corrected Reading - Limits

P=Peak Reading

L1=Hot

Q=Quasi-peak

L2=Neutral

A=Average Reading

Comments: N/A

## LINE CONDUCTED EMISSION LIMIT

Frequency	Maximum RF Line Voltage	
	Q.P.	AVERAGE
150kHz-500kHz	79dBuV	66dBuV
500kHz-5MHz	73dBuV	60dBuV
5MHz-30MHz	73dBuV	60dBuV

**Note:** The lower limit shall apply at the transition frequency.



## **MEASUREMENT PROCEDURE (PRELIMINARY RADIATED EMISSION TEST)**

- 1) The equipment was set up as per the test configuration to simulate typical actual usage per the user's manual. When the EUT is a tabletop system, a wooden turntable with a height of 0.8 meters is used which is placed on the ground plane as per ANSI C63.4 (see Test Facility for the dimensions of the ground plane used). When the EUT is a floor-standing equipment, it is placed on the ground plane which has a 3-12 mm non-conductive covering to insulate the EUT from the ground plane.
- 2) Support equipment, if needed, was placed as per ANSI C63.4.
- 3) All I/O cables were positioned to simulate typical actual usage as per ANSI C63.4.
- 4) The EUT received DC +12V power source from AC Adaptor (120VAC/ 60Hz) and outlet socket under the turntable. All support equipment received 110VAC/60Hz to power from another socket under the turntable, if any.
- 5) The antenna was placed at 10 meter away from the EUT as stated in ANSI C63.4: 1992. The antenna connected to the Analyzer via a cable and at times a pre-amplifier would be used.
- 6) The Analyzer / Receiver quickly scanned from 30MHz to 2000MHz. The EUT test program was started. Emissions were scanned and measured rotating the EUT to 360 degrees and positioning the antenna 1 to 4 meters above the ground plane, in both the vertical and the horizontal polarization, to maximize the emission reading level.
- 7) The following test mode(s) were scanned during the preliminary test:

**Mode(s):**

No.	Mode of operation	Date	Data Report/Plot No.
1	<b>S-Video Mode</b>	<b>06/19/2002</b>	<b>9462E#( 19 )</b>
2	<b>Video Mode</b>	<b>06/19/2002</b>	<b>9462E#( 15 )</b>
3	<b>1024 X 768</b>	<b>06/19/2002</b>	<b>9462E#( 13, 14 )</b>
4	<b>800 X 600</b>	<b>06/19/2002</b>	<b>9462E#( 20 )</b>
5	<b>640 X 480</b>	<b>06/19/2002</b>	<b>9462E#( 22 )</b>
6	<b>1-2G</b>	<b>06/20/2002</b>	<b>0265B#( 04, 06 )</b>

- 8) After the preliminary scan, we found the following test mode(s) producing the highest emission level.

**Mode: 3.**

Then, the EUT and cable configuration, antenna position, polarization and turntable position of the above highest emission level were recorded for reference of final testing.

## MEASUREMENT PROCEDURE (FINAL RAIDATED EMISSION TEST)

- 1) EUT and support equipment were set up on the turntable as per step 8 of the preliminary test.
- 2) The Analyzer / Receiver scanned from 30MHz to 2000MHz. Emissions were scanned and measured rotating the EUT to 360 degrees, varying cable placement and positioning the antenna 1 to 4 meters above the ground plane, in both the vertical and the horizontal polarization, to maximize the emission reading level.
- 3) Recorded at least the six highest emissions. Emission frequency, amplitude, were recorded into a computer ( The antenna position, polarization and turntable position were kept in raw data file ) in which correction factors were used to calculate the emission level and compare reading to the applicable limit.
- 4) The test data of the worst case condition(s) was reported on the Summary Data page.

### Data Sample:

Freq (MHz)	Meter Reading (dBuV)	C.F. (dB/m)	Corrected Reading (dBuV/m)	Limits (dBuV/m)	Margin (dB)	Reading Type P/Q/A	Pol. H/V
x.xx	x.xx	x.xx	<b>40.82</b>	<b>47.00</b>	<b>-6.18</b>	<b>P</b>	<b>V</b>

C.F.(Correction Factor)=Antenna Factor + Cable Loss + Attenuator(3/6 dB) - Amplifier Gain

Corrected Reading = Metering Reading + C.F.

Margin=Corrected Reading – Limits

P=Peak Reading

H=Horizontal Polarization/Antenna

Q=Quasi-peak

V=Vertical Polarization/Antenna

A=Average Reading

Comments: N/A

## RADIATED EMISSION LIMIT

Frequency (MHz)	Distance (m)	Maximum Field Strength Limit (dBu V/m/ Q.P.)
30-230	10	40
230-1000	10	47

**Note:** The lower limit shall apply at the transition frequency.

## SUMMARY DATA (LINE CONDUCTED TEST)

**Model Number:** GENE-6320(N)

**Location:** Conducted Room

**Tested by:** BILL HUANG

**Test Model:** Mode 1

**Test Results:** Passed

**Temperature:** 31

**Humidity:** 62%RH

(The chart below shows the highest readings taken from the final data)

Frequency Range Investigated (150 kHz TO 30 MHz)							
Freq (MHz)	Meter Reading (dBuV)	C.F. (dB)	Corrected Reading (dBuV)	Limits (dBuV)	Margin (dB)	Reading Type (P/Q/A)	Line (L1/L2)
2.692	50.72	0.15	50.87	73.00	-22.13	P	L1
3.584	46.20	0.15	46.35	73.00	-26.65	P	L1
4.070	49.18	0.15	49.33	73.00	-23.67	P	L1
2.707	50.34	0.17	50.51	73.00	-22.49	P	L2
3.584	45.76	0.21	45.97	73.00	-27.03	P	L2
4.070	48.98	0.23	49.21	73.00	-23.79	P	L2

C.F.(Correction Factor)=Insertion Loss + Cable Loss

Corrected Reading = Metering Reading + C.F.

Margin=Corrected Reading - Limits

P=Peak Reading                      L1=Hot

Q=Quasi-peak                      L2=Neutral

A=Average Reading

Comments: N/A

## SUMMARY DATA

### (RADIATED EMISSION TEST)

**Model Number:** GENE-6320(N)

**Location:** Site # E

**Tested by:** BILL HUANG

**Polar:** Vertical / Horizontal- 10m

**Test Mode:** Mode 3

**Test Results:** Passed

**Temperature:** 31

**Humidity:** 62%RH

(The chart below shows the highest readings taken from the final data)

Frequency Range Investigated (30 MHz TO 2000 MHz)							
Freq (MHz)	Meter Reading (dBuV)	C.F. (dB/m)	Corrected Reading (dBuV/m)	Limits (dBuV/m)	Margin (dB)	Reading Type P/Q/A	Pol. H/V
66.255	52.50	-15.24	37.26	40.00	-2.74	P	V
77.910	47.60	-15.65	31.95	40.00	-8.05	P	V
166.590	48.10	-11.50	36.60	40.00	-3.40	P	V
231.725	49.00	-8.23	40.77	47.00	-6.23	P	V
165.586	49.30	-11.55	37.75	40.00	-2.25	P	H
233.160	48.10	-8.13	39.97	47.00	-7.03	P	H

C.F.(Correction Factor)=Antenna Factor + Cable Loss - Amplifier Gain (+ Attenuator 3dB)

Corrected Reading = Metering Reading + C.F.

Margin=Corrected Reading - Limits

P=Peak Reading

H=Horizontal Polarization/Antenna

Q=Quasi-peak

V=Vertical Polarization/Antenna

A=Average Reading

Comments: N/A

## TEST FACILITY

- Location:** No. 199, Chung Sheng Road, Hsin Tien City,  
Taipei, Taiwan, R. O. C.
- Description:** There are two 3/10m open area test sites and one line conducted lab for final test  
The Open Area Test Sites and the Line Conducted labs are constructed and calibrated to meet the FCC requirements in documents ANSI C63.4: 1992 and CISPR 22/EN 55022 requirements.
- Site Filing:** A site description is on file with the Federal Communications Commission, 7435 Oakland Mills Road, Columbia, MD 21046.  
  
Registration also was made with Voluntary Control Council for Interference (VCCI).
- Site Accreditation:** Accredited by A2LA (Certificate #: 824.01) for EMC.  
  
Also accredited by BSMI for the product category of Information Technology Equipment.
- Instrument Tolerance:** All measuring equipment is in accord with ANSI C63.4 and CISPR 22 requirements that meet industry regulatory agency and accreditation agency requirement.
- Ground Plane:** Two conductive reference ground planes were used during the Line Conducted Emission, one in vertical and the other in horizontal. The dimensions of these ground planes are as below. The vertical ground plane was placed distancing 40 cm to the rear of the wooden test table on where the EUT and the support equipment were placed during test. The horizontal ground plane projected 50 cm beyond the footprint of the EUT system and distanced 80 cm to the wooden test table. For Radiated Emission Test, one horizontal conductive ground plane extended at least 1m beyond the periphery of the EUT and the largest measuring antenna, and covered the entire area between the EUT and the antenna. It has no holes or gaps having longitudinal dimensions larger than one-tenth of a wavelength at the highest frequency of measurement up to 1GHz.

## TEST EQUIPMENT LIST

**Instrumentation:** The following list contains equipment used at C & C Laboratory, Co., Ltd. for testing. The equipment conforms to the CISPR 16-1 / ANSI C63.2-1988 Specifications for Electromagnetic Interference and Field Strength Instrumentation from 10kHz to 1.0GHz or above.

**Equipment used during the tests:**

**Open Area Test Site: #E**

EQUIPMENT TYPE	MFR	MODEL NUMBER	SERIAL NUMBER	LAST CAL.	CAL. DUE
SPECTRUM ANALYZER	H.P.	8566B	2937A06102	06/07/02	06/06/03
SPECTRUM DISPLAY	H.P.	85662A	2848A18276	06/07/02	06/06/03
QUASI-PEAK DETECTOR	H.P.	85650A	2811A01439	06/07/02	06/06/03
AMPLIFIER	H.P.	8447D A	2727A05764	05/06/02	05/05/03
ANTENNA	EMCO	3142	1310	06/30/01	06/29/03
CABLE	BELDEN	9913	N-TYPE07	01/02/02	01/01/03
ANTENNA (1-18GHz)	EMCO	3115	5761	02/22/02	02/21/03
AMPLIFIER (1-26.5GHz)	HP	8449B	3008A01266	01/30/02	01/29/03
CABLE (1-18GHz)	JYEBAO	N30-L142-1/9	N/A	05/01/02	04/30/03
CABLE (1-18GHz)	HUBER+SUHNE R	SUCOFLEX 104	N/A	05/01/02	04/30/03

**Conducted Emission Test Site: Conducted Room**

EQUIPMENT TYPE	MFR	MODEL NUMBER	SERIAL NUMBER	LAST CAL.	CAL. DUE
TEST RECEIVER	R&S	ESHS20	840455/006	03/16/02	03/15/03
LISN	SOLAR	8012-50-R-24-BNC	8305114	07/23/01	07/22/02
LISN(EUT)	EMCO	3825/2	1435	01/16/02	01/15/03

The calibrations of the measuring instruments, including any accessories that may effect such calibration, are checked frequently to assure their accuracy. Adjustments are made and correction factors applied in accordance with instructions contained in the manual for the measuring instrument.

## BLOCK DIAGRAM OF TEST SETUP

### System Diagram of Connections between EUT and Simulators

**EUT:** CPU Board  
**Trade Name:** N/A  
**Model Number:** GENE-6320(N)

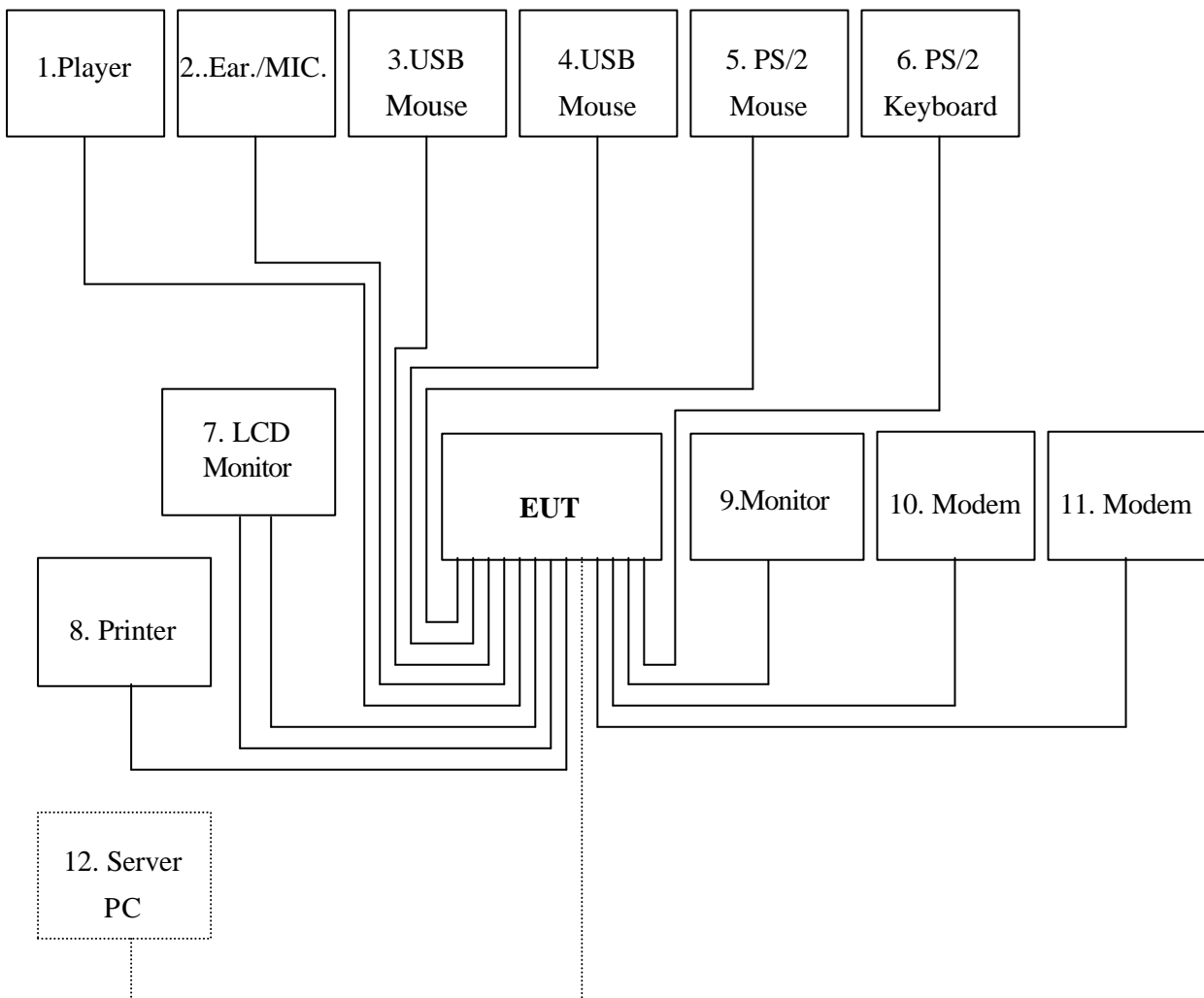

## **APPENDIX 1**

### **PHOTOGRAPHS OF TEST SETUP (TEST SETUP OF LINE CONDUCTED EMISSION )**



## LINE CONDUCTED EMISSION TEST



## **APPENDIX 2**

### **PHOTOGRAPHS OF TEST SETUP (TEST SETUP OF LINE RADIATED EMISSION )**

## RADIATED EMISSION TEST



## **APPENDIX 3**

### **PHOTOGRAPHS OF EUT**

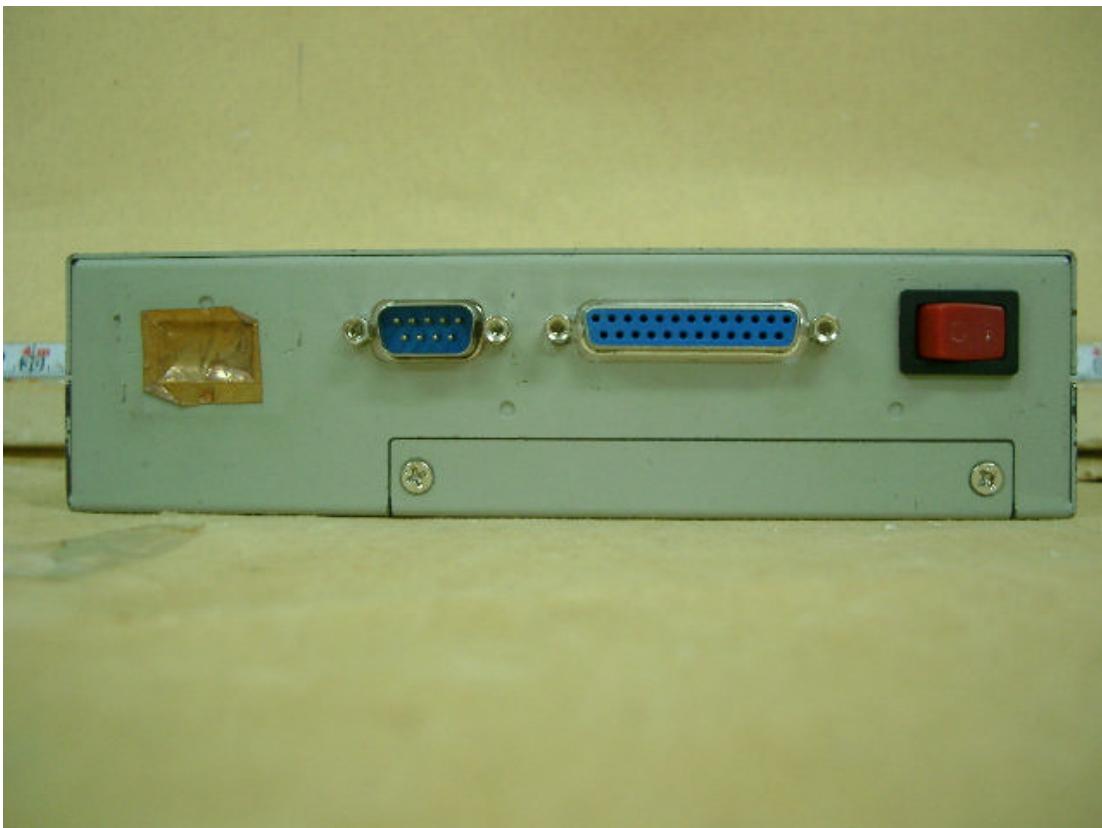



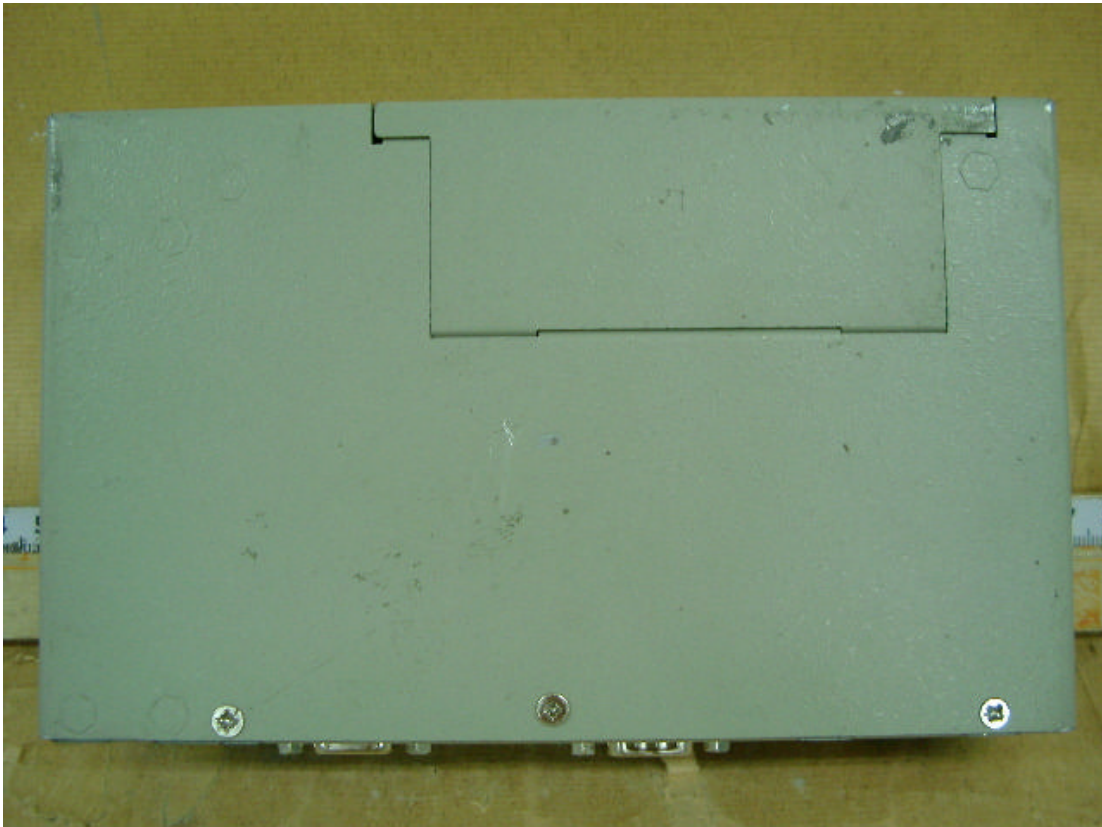





## **APPENDIX 4**

### **CONDUCTED EMISSION PLOT RADIATED EMISSION DATA**

Data#: 82 File#: 0265c.emi

Date: 2002-06-19 Time: 20:53:25

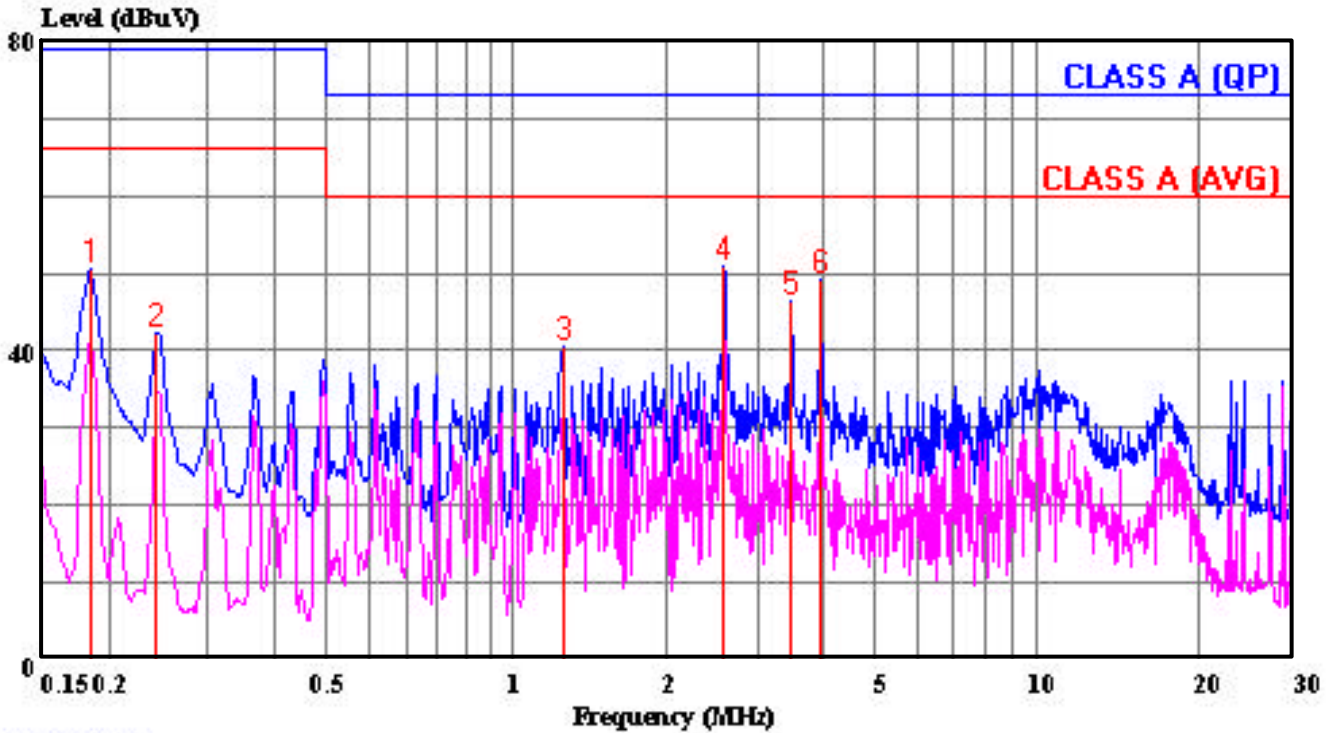

(Conducted)

Trace: 55 54

Ref Trace:

Condition: LINE  
 Report No. : 02E0265  
 Test Engr. : BILL HUANG  
 Company : AAEON TECHNOLOGY INC.  
 EUT : GENE-6320(N)  
 Test Config : EUT/ALL PERIPHERALS  
 Type of Test: FCC CLASS A W/ EN55022 CLASS A LIMIT  
 Mode of Op. : S-VIDEO MODE(WORST)

Page: 1

	Read	Limit	Over			
Freq	Level	Factor	Level	Line	Limit	Remark
MHz	dBuV	dB	dBuV	dBuV	dB	
1	0.183	50.58	0.03	50.61	79.00	-28.39 Peak
2	0.243	42.38	0.04	42.42	79.00	-36.58 Peak
3	1.359	40.52	0.14	40.66	73.00	-32.34 Peak
4	2.692	50.72	0.15	50.87	73.00	-22.13 Peak
5	3.584	46.20	0.15	46.35	73.00	-26.65 Peak
6	4.070	49.18	0.15	49.33	73.00	-23.67 Peak

Data#: 84 File#: 0265c.emi

Date: 2002-06-19 Time: 20:32:06

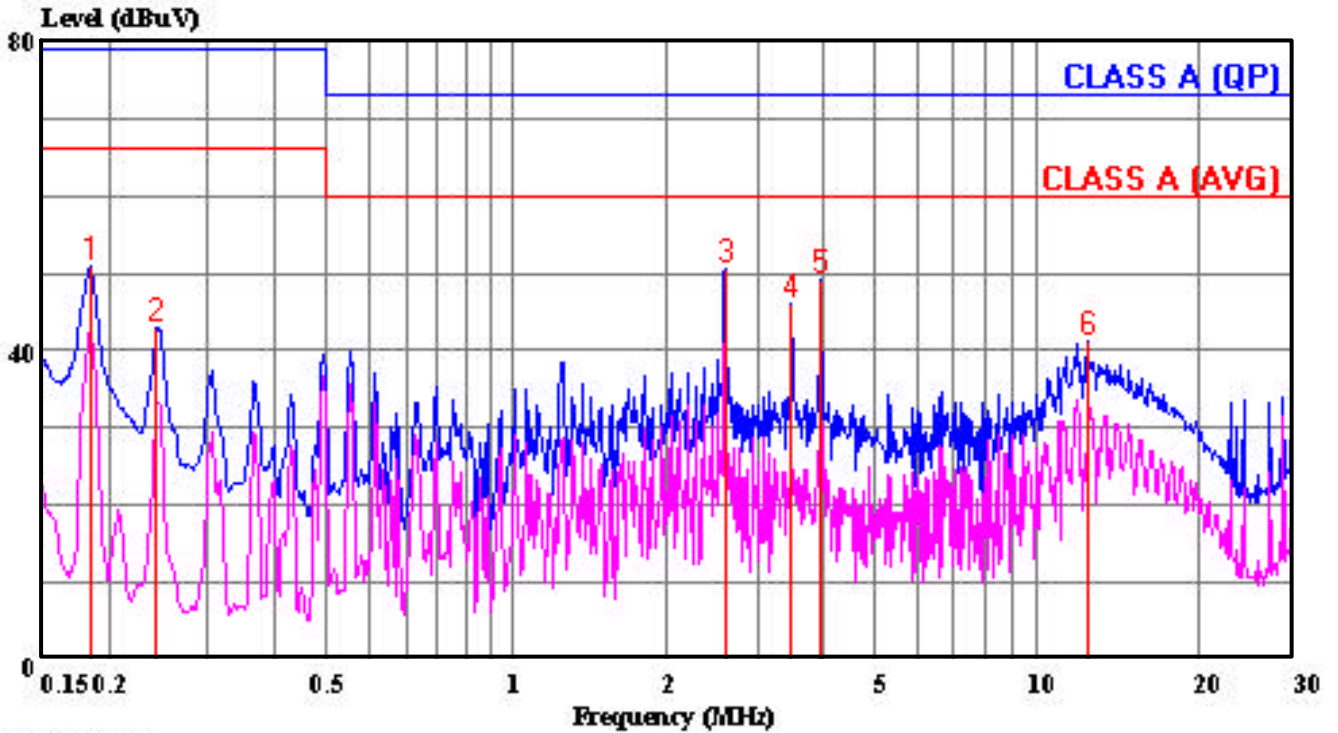

(Conducted)

Trace: 44 43

Ref Trace:

Condition: NEUTRAL  
Report No. : 02E0265  
Test Engr. : BILL HUANG  
Company : AAEON TECHNOLOGY INC.  
EUT : GENE-6320(N)  
Test Config : EUT/ALL PERIPHERALS  
Type of Test: FCC CLASS A W/ EN55022 CLASS A LIMIT  
Mode of Op. : S-VIDEO MODE(WORST)

Page: 1

	Read	Limit	Over	
Freq	Level	Factor	Level	Line
MHz	dBuV	dB	dBuV	dBuV
1	0.183	51.00	0.03	51.03
2	0.243	43.00	0.04	43.04
3	2.707	50.34	0.17	50.51
4	3.584	45.76	0.21	45.97
5	4.070	48.98	0.23	49.21
6	12.516	40.92	0.39	41.31

Limit	Over	Remark
Line	Limit	
dBuV	dB	
79.00	-27.97	Peak
79.00	-35.96	Peak
73.00	-22.49	Peak
73.00	-27.03	Peak
73.00	-23.79	Peak
73.00	-31.69	Peak



No. 199, Chung Sheng Road,  
Hsin Tien City, Taipei,  
Taiwan, R.O.C.  
Tel:02-2217-0894 Fax:02-2217-1254

Data#: 13 File#: 9462e.emi  
E-Site

Date: 2002-06-19 Time: 09:44:23

Condition: VERTICAL /10m  
Report No. : 02E0265  
Test Engr. : BILL HUANG  
Company : AAEON TECHNOLOGY INC.  
EUT : GENE-6320(N)  
Test Config : EUT/ALL PERIPHERALS  
Type of Test: FCC CLASS A W/ EN55022 CLASS A LIMIT  
Mode of Op. : 1024 X 768(WORST)

Page: 1

	Freq	Read Level	Factor	Level	Limit Line	Over Limit	Remark
	MHz	dBuV	dB	dBuV/m	dBuV/m	dB	
1	55.640	40.80	-13.59	27.21	40.00	-12.79	Peak
2	66.255	52.50	-15.24	37.26	40.00	-2.74	Peak
3	72.750	43.70	-15.64	28.06	40.00	-11.94	Peak
4	77.910	47.60	-15.65	31.95	40.00	-8.05	Peak
5	166.590	48.10	-11.50	36.60	40.00	-3.40	Peak
6	231.725	49.00	-8.23	40.77	47.00	-6.23	Peak
7	496.410	36.90	-2.50	34.40	47.00	-12.60	Peak



No. 199, Chung Sheng Road,  
 Hsin Tien City, Taipei,  
 Taiwan, R.O.C.  
 Tel:02-2217-0894 Fax:02-2217-1254

Data#: 14 File#: 9462e.emi  
 E-Site

Date: 2002-06-19 Time: 10:08:24

Condition: HORIZONTAL /10m  
 Report No. : 02E0265  
 Test Engr. : BILL HUANG  
 Company : AAEON TECHNOLOGY INC.  
 EUT : GENE-6320(N)  
 Test Config : EUT/ALL PERIPHERALS  
 Type of Test: FCC CLASS A W/ EN55022 CLASS A LIMIT  
 Mode of Op. : 1024 X 768(WORST)

Page: 1

	Freq	Read Level	Factor	Level	Limit Line	Over Limit	Remark
	MHz	dBuV	dB	dBuV/m	dBuV/m	dB	
1	66.250	40.50	-15.24	25.26	40.00	-14.74	Peak
2	132.452	36.60	-14.31	22.29	40.00	-17.71	Peak
3	165.586	49.30	-11.55	37.75	40.00	-2.25	Peak
4	233.160	48.10	-8.13	39.97	47.00	-7.03	Peak
5	499.910	35.90	-2.45	33.45	47.00	-13.55	Peak

Data#: 4 File#: 0265b.emi

Date: 2002-06-20 Time: 05:22:42

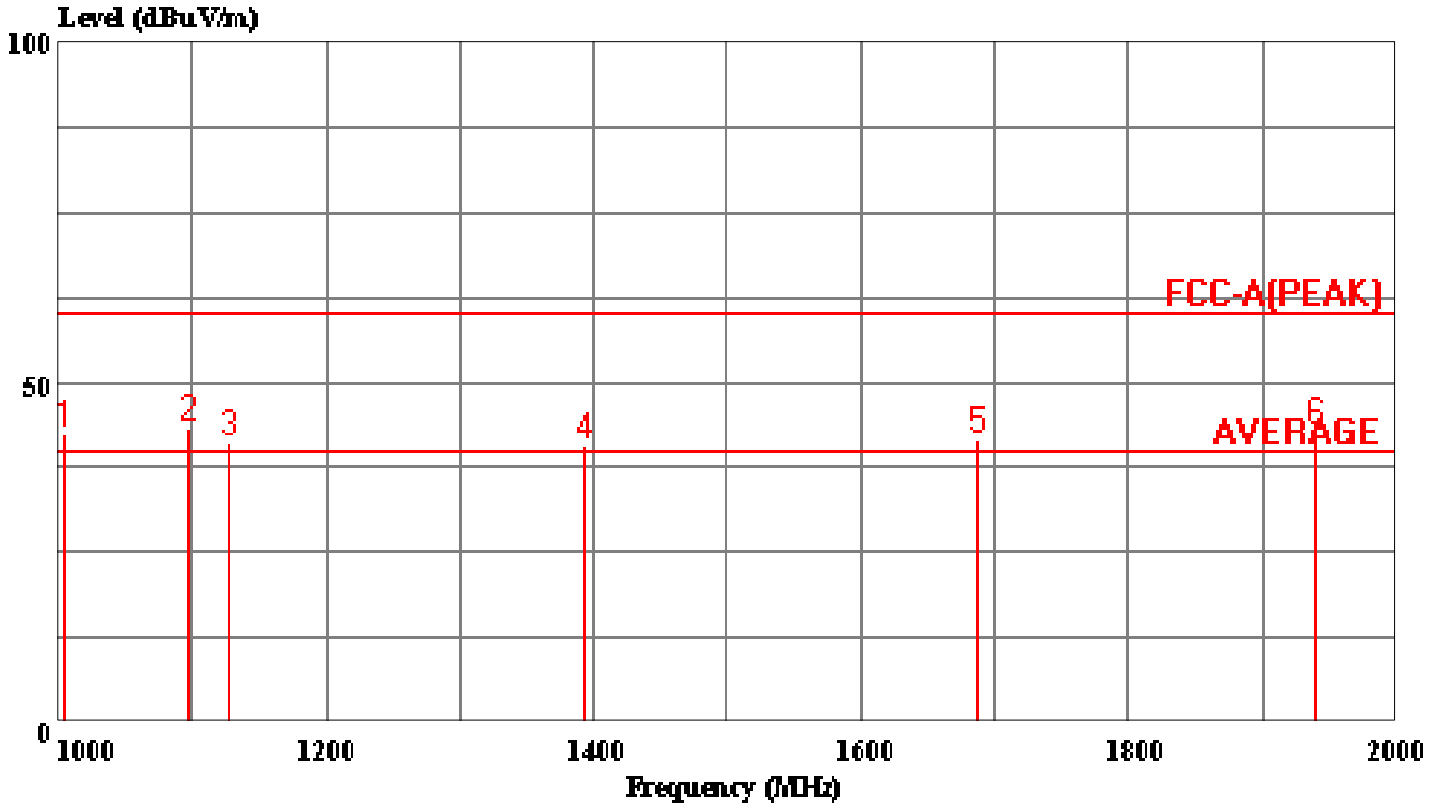

(Chamber)

Trace:

Ref Trace:

Condition: VERTICAL /3m  
Report No. : 02E0265  
Test Engr. : BILL HUANG  
Company : AAEON TECHNOLOGY INC.  
EUT : GENE-6320(N)  
Test Config : EUT/ALL PERIPHERALS  
Type of Test: FCC CLASS A  
Mode of Op. : 1-2GHz

Page: 1

	Read			Limit	Over	
Freq	Level	Factor	Level	Line	Limit	Remark
MHz	dBuV	dB	dBuV/m	dBuV/m	dB	
1	1004.000	52.20	-9.89	42.31	74.00	-31.69 Peak
2	1097.000	52.84	-9.76	43.08	74.00	-30.92 Peak
3	1127.000	50.58	-9.58	41.00	74.00	-33.00 Peak
4	1394.000	48.74	-8.23	40.51	74.00	-33.49 Peak
5	1687.000	47.44	-6.07	41.37	74.00	-32.63 Peak
6	1939.000	47.04	-4.25	42.79	74.00	-31.21 Peak

Data#: 6 File#: 0265b.emi

Date: 2002-06-20 Time: 05:25:05

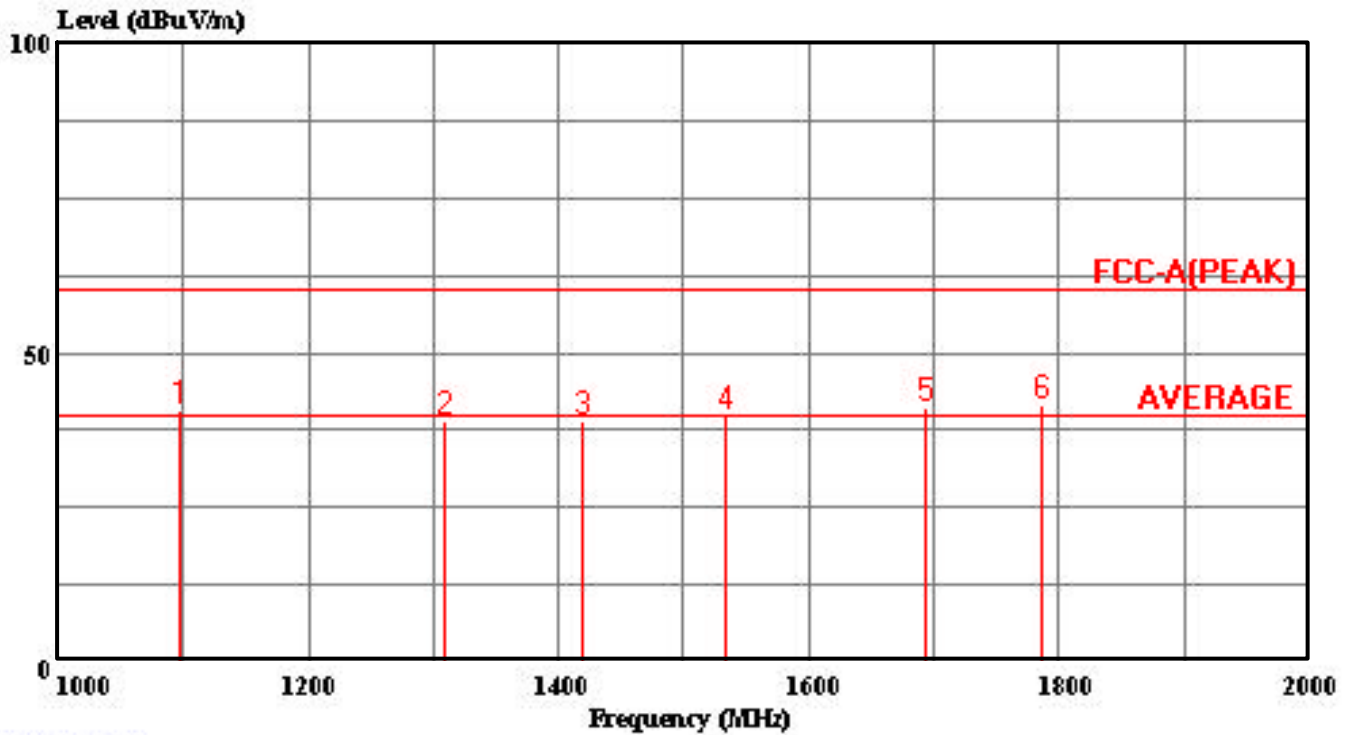

(Chamber)

Trace:

Ref Trace:

Condition: HORIZONTAL /3m  
 Report No. : 02E0265  
 Test Engr. : BILL HUANG  
 Company : AAEON TECHNOLOGY INC.  
 EUT : GENE-6320(N)  
 Test Config : EUT/ALL PERIPHERALS  
 Type of Test: FCC CLASS A  
 Mode of Op. : 1-2GHz

Page: 1

	Read		Limit	Over		
Freq	Level	Factor	Level	Line	Limit	Remark
MHz	dBuV	dB	dBuV/m	dBuV/m	dB	
1	1097.000	50.38	-9.76	40.62	74.00	-33.38 Peak
2	1309.000	47.69	-8.57	39.12	74.00	-34.88 Peak
3	1419.000	47.19	-8.07	39.12	74.00	-34.88 Peak
4	1534.000	47.50	-7.48	40.02	74.00	-33.98 Peak
5	1694.000	47.05	-6.00	41.05	74.00	-32.95 Peak
6	1787.000	46.65	-5.17	41.48	74.00	-32.52 Peak