



FCC 47 CFR PART 15 SUBPART B TEST REPORT

for

Green Communication Server

MODEL: xxxxGCS-1100lxx-xxx-xxxxxxx

(Where x is 0-9 , A-Z , -or blank) for marketing purpose

Test Report Number:

T100805201-F

Issued to:

AAEON Technology Inc.

**5F, No.135, Lane 235, Pao Chiao Rd., Hsin-Tien City,
Taipei, Taiwan, R.O.C.**

Issued by:

Compliance Certification Services Inc.

Sindian BU.

**No.163-1, Jhongsheng Rd., Sindian City,
Taipei County 23151, Taiwan**

TEL: 886-2-22170894

FAX: 886-2-22171029

Issued Date: August 19, 2010



Note: This report shall not be reproduced except in full, without the written approval of Compliance Certification Services Inc. This document may be altered or revised by Compliance Certification Services Inc. personnel only, and shall be noted in the revision section of the document. The client should not use it to claim product endorsement by TAF, A2LA, NIST or any government agencies. The test results in the report only apply to the tested sample.



Revision History

Rev.	Issue Date	Revisions	Effect Page	Revised By
00	August 19, 2010	Initial Issue	ALL	Stella Lin



TABLE OF CONTENTS

1 TEST RESULT CERTIFICATION 4

2 EUT DESCRIPTION..... 5

3 TEST METHODOLOGY..... 6

 3.1. DECISION OF FINAL TEST MODE..... 6

 3.2. EUT SYSTEM OPERATION 6

4 SETUP OF EQUIPMENT UNDER TEST 7

 4.1. DESCRIPTION OF SUPPORT UNITS 7

 4.2. CONFIGURATION OF SYSTEM UNDER TEST 8

5 FACILITIES AND ACCREDITATIONS 9

 5.1. FACILITIES 9

 5.2. ACCREDITATIONS..... 9

 5.3. MEASUREMENT UNCERTAINTY..... 9

6 CONDUCTED EMISSION MEASUREMENT 10

 6.1. LIMITS OF CONDUCTED EMISSION MEASUREMENT 10

 6.2. TEST INSTRUMENTS 10

 6.3. TEST PROCEDURES..... 11

 6.4. TEST SETUP 12

 6.5. DATA SAMPLE 12

 6.6. TEST RESULTS..... 13

7 RADIATED EMISSION MEASUREMENT 15

 7.1. LIMITS OF RADIATED EMISSION MEASUREMENT..... 15

 7.2. TEST INSTRUMENTS 17

 7.3. TEST PROCEDURES..... 18

 7.4. TEST SETUP 19

 7.5. DATA SAMPLE 20

 7.6. TEST RESULTS..... 21

8 PHOTOGRAPHS OF THE TEST CONFIGURATION..... 24

APPENDIX 1 - PHOTOGRAPHS OF EUT.....A1-1



1 TEST RESULT CERTIFICATION

Product:	Green Communication Server
Model:	xxxxGCS-1100lxx-xxx-xxxxxxx (Where x is 0-9 , A-Z , -or blank) for marketing purpose
Brand:	AAEON
Applicant:	AAEON Technology Inc. 5F, No.135, Lane 235, Pao Chiao Rd., Hsin-Tien City, Taipei, Taiwan, R.O.C.
Manufacturer:	AAEON Technology Inc. 5F, No.135, Lane 235, Pao Chiao Rd., Hsin-Tien City, Taipei, Taiwan, R.O.C.
Tested:	August 06, 2010 ~ August 19, 2010

EMISSION			
Standard	Item	Result	Remarks
FCC 47 CFR Part 15 Subpart B, ICES-003 Issue 4 ANSI C63.4-2003	Conducted (Power Port)	PASS	Meet Class A limit
	Radiated	PASS	Meet Class A limit

- Note:
1. The statements of test result on the above are decided by the request of test standard only; the measurement uncertainties are not factored into this compliance determination.
 2. The information of measurement uncertainty is available upon the customer's request.

Deviation from Applicable Standard
None

The above equipment has been tested by Compliance Certification Services Inc., and found compliance with the requirements set forth in the technical standards mentioned above. The results of testing in this report apply only to the product/system, which was tested. Other similar equipment will not necessarily produce the same results due to production tolerance and measurement uncertainties.

Approved by:

Reviewed by:



 Sam Hu
 Section Manager



 Vesta Hsu
 Supervisor of report document dept.



2 EUT DESCRIPTION

Product	Green Communication Server
Brand Name	AAEON
Model	xxxxGCS-1100lxx-xxx-xxxxxxx (Where x is 0-9 , A-Z , -or blank) for marketing purpose
Applicant	AAEON Technology Inc.
Housing material	Metal case
Identify Number	T100805201
Received Date	August 05, 2010
EUT Power Rating	12VDC from AC Adaptor
AC Power During Test	120VAC / 60Hz to AC Adaptor
AC Adaptor Manufacturer	FSP GROUP INC.
AC Adaptor Model	FSP084-DMAA1
AC Adaptor Power During	I/P: 100-240VAC, 50-60Hz, 1.3A; O/P: 12VDC, 7A
DC Power Cord Type	Unshielded, 1.8m (Non-detachable, with a core)
OSC/Clock Frequencies	25MHz; 14.31818MHz; 32.768kHz

Model Differences

Model Name	Difference	Tested (Checked)
GCS-1100I	Original	<input checked="" type="checkbox"/>
XxxxGCS-1100lxx-xxx-xxxxxxx	1. (Where x is 0-9 , A-Z , -or blank) 2. For marketing purpose only	<input type="checkbox"/>

I/O PORT

I/O PORT TYPES	Q'TY	TESTED WITH
1. SIO Port	8	8
2. PS/2 Keyboard Port	1	1
3. PS/2 Mouse Port	1	1
4. VGA Port	1	1
5. DVI Port	1	1
6. USB Port	4	4
7. LAN Port	4	4
8. DIO Port	2	1

Note: Client consigns only one model sample to test (Model Number: GCS-1100I).



3 TEST METHODOLOGY

3.1. DECISION OF FINAL TEST MODE

The EUT was tested together with the above additional components, and a configuration, which produced the worst emission levels, was selected and recorded in this report.

The test configuration mode is as the following:

Conduction Modes:

1	D-SUB + DVI Mode	1600X1200
---	------------------	-----------

Radiation Modes:

1	D-SUB + DVI Mode	1600X1200
	D-SUB + DVI Mode	1600X1200 / 1-8GHz

Conduction: Mode 1

Radiation: Mode 1

3.2. EUT SYSTEM OPERATION

1. Windows XP boots system.
2. Run Emctest.exe to activate all peripherals and display "H" pattern on monitor screen.
3. Run Winemc.exe then select (E:/ \ F:/ \ G:/ \ H:/) to test USB 2.0 port.
4. Press the start menu, select executive and type ping 192.168.0.2~5 -t (EUT), ping 192.168.0.1 -t (Server Notebook).

Note: Test program is self-repeating throughout the test.



4 SETUP OF EQUIPMENT UNDER TEST

4.1. DESCRIPTION OF SUPPORT UNITS

The EUT has been tested as an independent unit together with other necessary accessories or support units. The following support units or accessories were used to form a representative test configuration during the tests.

EUT Devices:

No.	Equipment	Model No.	Brand Name
1	CPU (1.6GHz)	Atom N270	Intel
2	Memory (DDR2-800 2GB)	SEC K4T1G08400	Transcend
3	SSD (32GB)	TS32GSSD25S-S	Transcend
4	AC Adapter	FSP084-DMAA1	FSP

Peripherals Devices:

No.	Equipment	Model No.	Serial No.	FCC ID / BSMI ID	Brand Name	Data Cable	Power Cord
1	PS/2 Mouse	M071KC	443029438	DOC BSMI: R41108	DELL	Shielded, 1.8m	N/A
2	PS/2 Keyboard	SK-8110	N/A	DOC BSMI: T3A002	DELL	Shielded, 1.8m	N/A
3-6	USB 2.0 HDD	F12-U	N/A	BSMI ID: 4912A002	TeraSys	Shielded, 1.8m	N/A
7	Modem	AL-56ERM	0MERM04A0212	DOC	GALILEO	Shielded, 1.0m	Unshielded, 1.8m
8	Modem	AL-56ERM	0MERM04A0213	DOC	GALILEO	Shielded, 1.0m	Unshielded, 1.8m
9	Modem	AL-56ERM	0MERM04A0214	DOC	GALILEO	Shielded, 1.0m	Unshielded, 1.8m
10	Modem	AL-56ERM	0MERM04A0215	DOC	GALILEO	Shielded, 1.0m	Unshielded, 1.8m
11	Modem	AL-56ERM	0MERM04A0222	DOC	GALILEO	Shielded, 1.0m	Unshielded, 1.8m
12	Modem	AL-56ERM	0MERM04A0223	DOC	GALILEO	Shielded, 1.0m	Unshielded, 1.8m
13	Modem	AL-56ERM	0MERM04A0224	DOC	GALILEO	Shielded, 1.0m	Unshielded, 1.8m
14	Modem	AL-56ERM	0MERM04A0225	DOC	GALILEO	Shielded, 1.0m	Unshielded, 1.8m
15-16	Monitor	2408WFP	N/A	N/A	DELL	Shielded, 1.8m with two cores	Unshielded, 1.8m
17	HUB	DGS-1008D	N/A	N/A	D-Link	Unshielded, 20m X4	Unshielded, 1.8m
18	Server Notebook	PP05L	2464936188	DoC BSMI: R33002	DELL	Unshielded, 1.0m	Unshielded, 1.8m
19	DIO switch PIO Cable	N/A	N/A	N/A	N/A	Unshielded, 1.8m	N/A

Note:

- 1) All the equipment/cables were placed in the worst-case configuration to maximize the emission during the test.
- 2) Grounding was established in accordance with the manufacturer's requirements and conditions for the intended use.



4.2. CONFIGURATION OF SYSTEM UNDER TEST

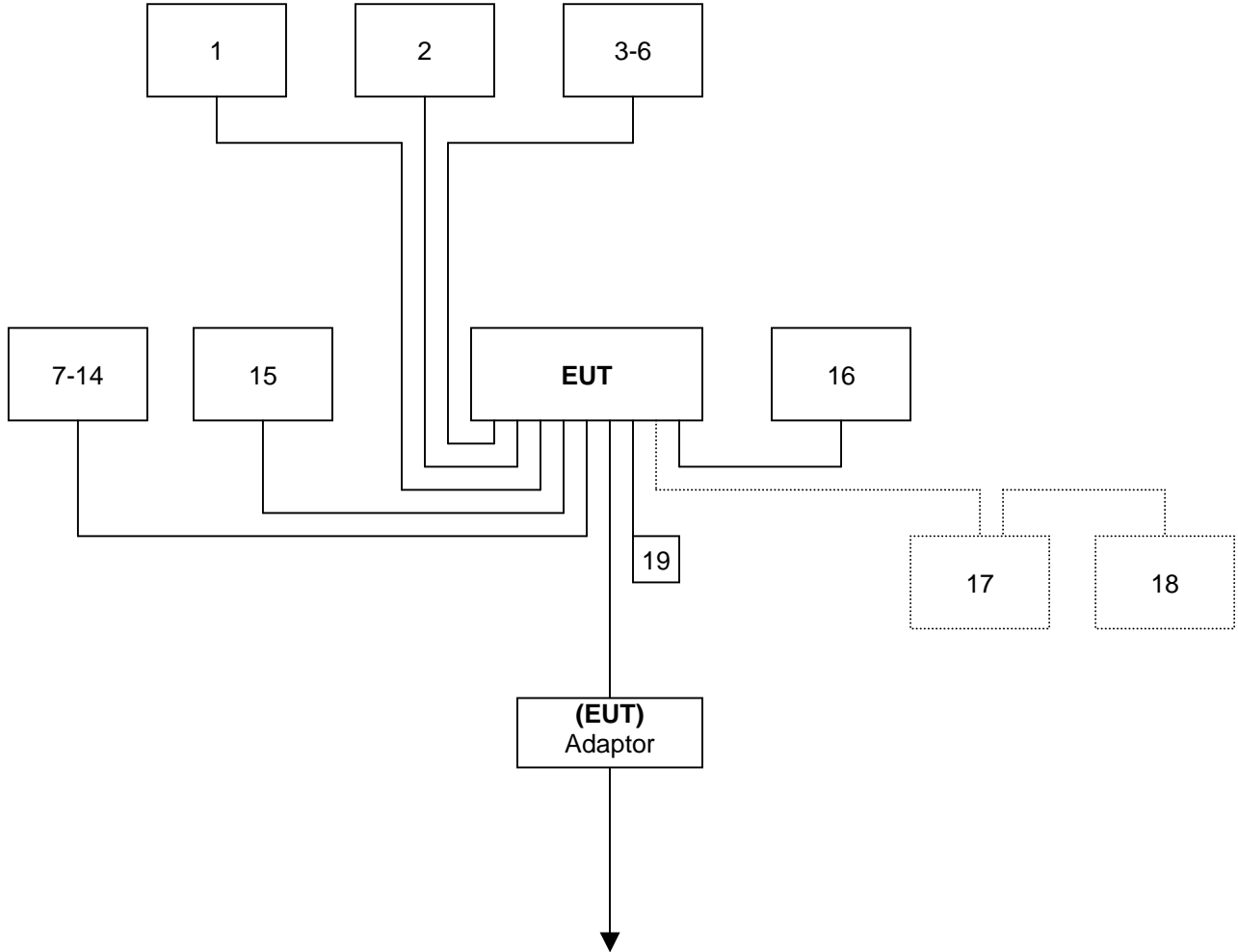



5 FACILITIES AND ACCREDITATIONS

5.1. FACILITIES

All measurement facilities used to collect the measurement data are located at CCS Taiwan Sindian BU. at No.163-1, Jhongsheng Rd., Sindian City, Taipei County 23151, Taiwan.

The sites are constructed in conformance with the requirements of ANSI C63.4 and CISPR Publication 22. All receiving equipment conforms to CISPR 16-1-1, CISPR 16-1-2, CISPR 16-1-3, CISPR 16-1-4 and CISPR 16-1-5.

5.2. ACCREDITATIONS

Our laboratories are accredited and approved by the following accreditation body according to ISO/IEC 17025.

Taiwan	TAF
USA	A2LA

The measuring facility of laboratories has been authorized or registered by the following approval agencies.

Canada	Industry Canada
Norway	Nemko
Japan	VCCI
Taiwan	BSMI
USA	FCC

Copies of granted accreditation certificates are available for downloading from our web site, <http://www.ccsrf.com>

5.3. MEASUREMENT UNCERTAINTY

Where relevant, the following measurement uncertainty levels have been estimated for tests performed on the EUT as specified in CISPR 16-4-2:

Measurement	Frequency	Uncertainty
Conducted emissions	0.15MHz ~ 30MHz	± 1.19
Radiated emissions	30MHz ~ 1000MHz	± 3.97
	1000MHz ~18000MHz	± 1.99
	18000MHz ~26000MHz	± 2.65
	26000MHz ~40000MHz	± 2.97

This uncertainty represents an expanded uncertainty expressed at approximately the 95% confidence level using a coverage factor of k=2.

Consistent with industry standard (e.g. CISPR 22: 2005, clause 11, Measurement Uncertainty) determining compliance with the limits shall be base on the results of the compliance measurement. Consequently the measure emissions being less than the maximum allowed emission result in this be a compliant test or passing test.

The acceptable measurement uncertainty value without requiring revision of the compliance statement is base on conducted and radiated emissions being less than U_{CISPR} which is 3.6dB and 5.2dB respectively. CCS values (called U_{Lab} in CISPR 16-4-2) is less than U_{CISPR} as shown in the table above. Therefore, MU need not be considered for compliance.



6 CONDUCTED EMISSION MEASUREMENT

6.1. LIMITS OF CONDUCTED EMISSION MEASUREMENT

FREQUENCY (MHz)	Class A (dBUV)		Class B (dBUV)	
	Quasi-peak	Average	Quasi-peak	Average
0.15 - 0.5	79	66	66 - 56	56 - 46
0.50 - 5.0	73	60	56	46
5.0 - 30.0	73	60	60	50

- Note:**
1. The lower limit shall apply at the transition frequencies.
 2. The limit decreases in line with the logarithm of the frequency in the range of 0.15 to 0.50 MHz.
 3. All emanations from a class A/B digital device or system, including any network of conductors and apparatus connected thereto, shall not exceed the level of field strengths specified above.

6.2. TEST INSTRUMENTS

Conducted Emission room # A				
Name of Equipment	Manufacturer	Model	Serial Number	Calibration Due
TEST RECEIVER	R&S	ESHS20	840455/006	02/28/2011
LISN (EUT)	SCHWARZBECK	NSLK 8127	8127527	12/16/2010
LISN	SCHWARZBECK	NSLK 8127	8127526	12/16/2010
BNC CABLE	MIYAZAKI	5D-FB	BNC A5	02/01/2011
THERMO-HYGRO METER	TECPEL	DTM-303	NO.3	11/23/2010
Test S/W	EZ-EMC			

- NOTE:**
1. The calibration interval of the above test instruments is 12 months and the calibrations are traceable to NML/ROC and NIST/USA.
 2. N.C.R = No Calibration Request.



6.3. TEST PROCEDURES (please refer to measurement standard or CCS SOP PA-031)

Procedure of Preliminary Test

- The EUT and support equipment, if needed, were set up as per the test configuration to simulate typical usage per the user's manual. When the EUT is a tabletop system, a wooden table with a height of 0.8 meters is used and is placed on the ground plane as per ANSI C63.4 (see Test Facility for the dimensions of the ground plane used). When the EUT is a floor standing equipment, it is placed on the ground plane, which has a 12 mm non-conductive covering to insulate the EUT from the ground plane.
- All I/O cables were positioned to simulate typical actual usage as per ANSI C63.4.
- The test equipment EUT installed by AC 120VAC/60Hz main power, through a Line Impedance Stabilization Network (LISN), which was supplied power source and was grounded to the ground plane.
- All support equipment power by from a second LISN.
- The test program of the EUT was started. Emissions were measured on each current carrying line of the EUT using an EMI Test Receiver connected to the LISN powering the EUT.
- The Receiver scanned from 150kHz to 30MHz for emissions in each of the test modes.
- During the above scans, the emissions were maximized by cable manipulation.
- The test mode(s) described in Item 3.1 were scanned during the preliminary test.
- After the preliminary scan, we found the test mode described in Item 3.1 producing the highest emission level.
- The worst configuration of EUT and cable of the above highest emission level were recorded for reference of the final test.

Procedure of Final Test

- EUT and support equipment were set up on the test bench as per the configuration with highest emission level in the preliminary test.
- A scan was taken on both power lines, Line 1 and Line 2, recording at least the six highest emissions. Emission frequency and amplitude were recorded into a computer in which correction factors were used to calculate the emission level and compare reading to the applicable limit.
- The test data of the worst-case condition(s) was recorded.



6.4. TEST SETUP

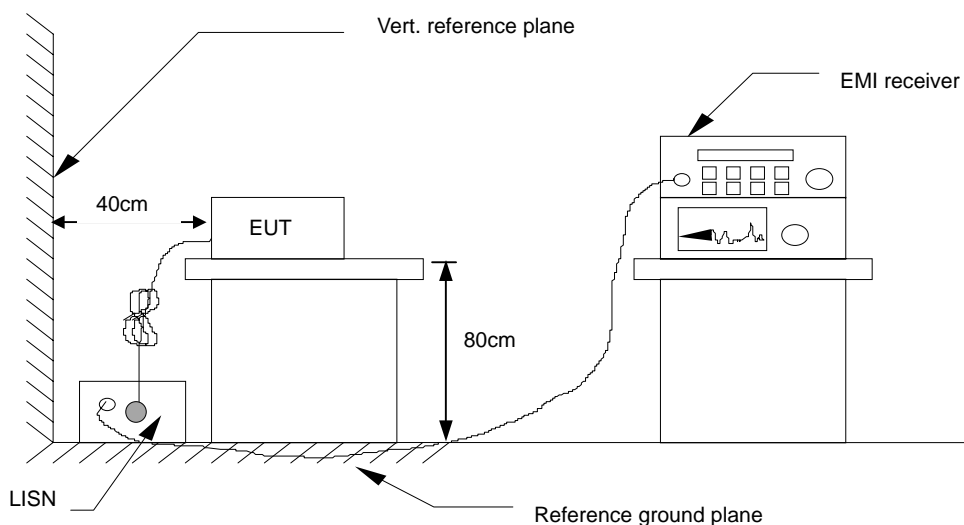

- For the actual test configuration, please refer to the related item – Photographs of the Test Configuration.

6.5. DATA SAMPLE

Freq. (MHz)	Reading (dBuV)	Factor (dB)	Result (dBuV)	Limit (dBuV)	Margin (dB)	Detector (P/Q/A)	Line (L1/L2)
x.xx	42.95	0.55	43.50	73	-29.50	Q	L1

- Freq. = Emission frequency in MHz
- Reading = Uncorrected Analyzer/Receiver reading
- Factor = Insertion loss of LISN + Cable Loss
- Result = Read Level + Factor
- Limit = Limit stated in standard
- Margin = Reading in reference to limit
- P = Peak Reading
- Q = Quasi-peak Reading
- A = Average Reading
- L1 = Hot side
- L2 = Neutral side

Calculation Formula

Margin (dB) = Result (dBuV) – Limit (dBuV)



6.6. TEST RESULTS

Model No.	GCS-1100I	6dB Bandwidth	10 kHz
Environmental Conditions	26deg.C, 60% RH, 1010hPa	Test Mode	Mode 1
Tested by	Jason Lee	Phase	L1
Standard	FCC CLASS A		

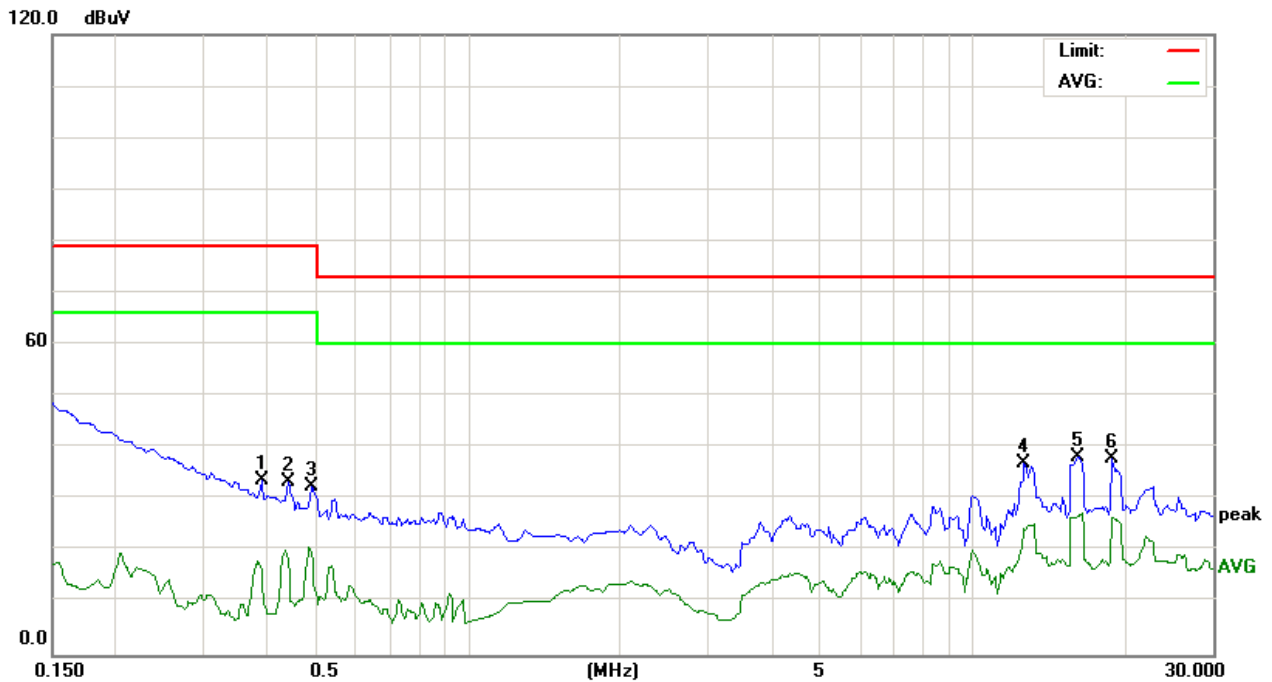

Conducted Emission Readings							
Frequency Range Investigated				150 kHz to 30 MHz			
Freq. (MHz)	Reading (dBuV)	Factor (dB)	Result (dBuV)	Limit (dBuV)	Margin (dB)	Detector (P/Q/A)	Line (L1/L2)
0.3899	33.67	0.09	33.76	79.00	-45.24	P	L1
0.4400	33.38	0.09	33.47	79.00	-45.53	P	L1
0.4900	32.35	0.09	32.44	79.00	-46.56	P	L1
12.7000	36.27	0.64	36.91	73.00	-36.09	P	L1
16.2000	37.43	0.79	38.22	73.00	-34.78	P	L1
18.9000	36.92	0.90	37.82	73.00	-35.18	P	L1

Note: 1. L1 = Line One (Live Line) / L2 = Line Two (Neutral Line).
 2. The emission level was or more than 2dB below the Average limit, so no re-check anymore.



Model No.	GCS-1100I	6dB Bandwidth	10 kHz
Environmental Conditions	26deg.C, 60% RH, 1010hPa	Test Mode	Mode 1
Tested by	Jason Lee	Phase	L2
Standard	FCC CLASS A		

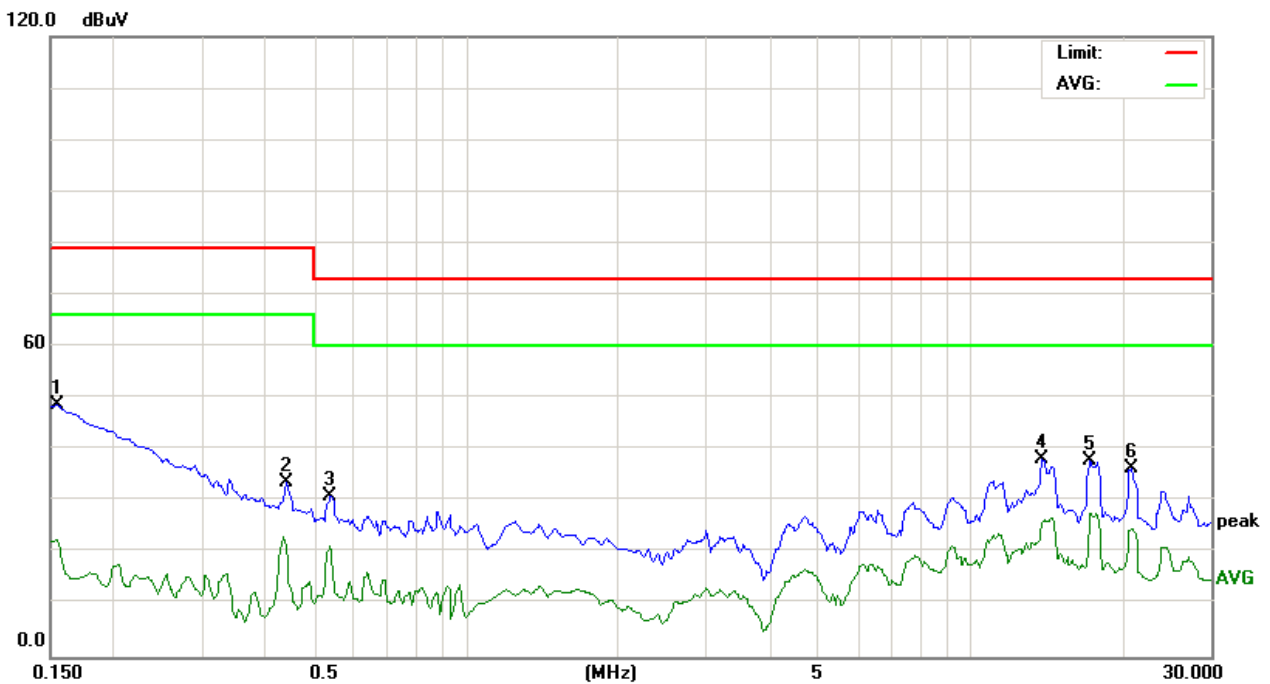

Conducted Emission Readings							
Frequency Range Investigated				150 kHz to 30 MHz			
Freq. (MHz)	Reading (dBuV)	Factor (dB)	Result (dBuV)	Limit (dBuV)	Margin (dB)	Detector (P/Q/A)	Line (L1/L2)
0.1550	48.63	0.08	48.71	79.00	-30.29	P	L2
0.4400	33.58	0.09	33.67	79.00	-45.33	P	L2
0.5400	30.86	0.09	30.95	73.00	-42.05	P	L2
13.9000	37.42	0.70	38.12	73.00	-34.88	P	L2
17.2000	37.25	0.83	38.08	73.00	-34.92	P	L2
20.9000	35.49	0.99	36.48	73.00	-36.52	P	L2

Note: 1. L1 = Line One (Live Line) / L2 = Line Two (Neutral Line).
 2. The emission level was or more than 2dB below the Average limit, so no re-check anymore.



7 RADIATED EMISSION MEASUREMENT

7.1. LIMITS OF RADIATED EMISSION MEASUREMENT

Below 1GHz (for digital device)

FREQUENCY (MHz)	dBuV/m (At 10m)	
	Class A	Class B
30 ~ 230	40	30
230 ~ 1000	47	37

Limit tables for non-digital device:

Class A Radiated Emission limit at 10m (for others)

Frequency (MHZ)	Field Strength Limit (uV/m)Q.P.	Field Strength Limit (dBuV/m)Q.P.
30 - 88	90	39
88 - 216	150	43.5
216 – 960	210	46.4
Above 960	300	49.5

Class B Radiated Emission limit at 3m (for others)

Frequency (MHZ)	Field Strength Limit (uV/m)Q.P.	Field Strength Limit (dBuV/m)Q.P.
30 - 88	100	40
88 - 216	150	43.5
216 – 960	200	46
Above 960	500	54

Above 1GHz(for all device)

Frequency (MHZ)	Class A (dBuV/m) (At 10m)		Class B (dBuV/m) (At 3m)	
	Average	Peak	Average	Peak
Above 1000	49.5	69.5	54	74

- NOTE:** (1) The lower limit shall apply at the transition frequencies.
 (2) Emission level (dBuV/m) = 20 log Emission level (uV/m).
 (3) The measurement above 1GHz is at close-in distances 3m, and determine the limit **L2** corresponding to the close-in distance **d2** by applying the following relation: **L2 = L1 (d1/d2)**, where **L1** is the specified limit in microvolts per metre (**uV/m**) at the distance **d1 (10m)**, **L2** is the new limit for distance **d2 (3m)**.
 So the new Class A limit above 1GHz at 3m is as following table:

Frequency (MHZ)	Class A (dBuV/m) (At 3m)	
	Average	Peak
Above 1000	60	80



According to FCC Part 15.33 (b), for an unintentional radiator, including a digital device, the spectrum shall be investigated from the lowest radio frequency signal generated or used in the device, without going below the lowest frequency for which a radiated emission limit is specified, up to the frequency shown in the following table:

Highest frequency generated or used in the device or on which the device operates or tunes (MHz)	Upper frequency of measurement range (MHz)
Below 1.75	30
1.75-108	1000
108-500	2000
500-1000	5000
Above 1000	5 th harmonic of the highest frequency or 40GHz, whichever is lower



7.2. TEST INSTRUMENTS

Open Area Test Site # I				
Name of Equipment	Manufacturer	Model	Serial Number	Calibration Due
MEASURE RECEIVER	SCHAFFNER	SCR3501	338	07/05/2011
SPECTRUM ANALYZER	ADVANTEST	R3132	120900008	No Calibration Required
ANTENNA	SCHAFFNER	CBL 6112B	2809	09/06/2010
AMPLIFIER	SCHAFFNER	CPA9231A	3626	10/11/2010
CABLE	BELDEN	9913	N-TYPE #12	02/21/2011
THERMO-HYGRO METER	TECPEL	DTM-303	090639	05/23/2011
Test S/W	EZ-EMC			
Above 1GHz Used				
MEASURE RECEIVER	SCHAFFNER	SCR3501	342	06/28/2011
SPECTRUM ANALYZER (9kHz-30GHz)	R&S	FSP 30	100112	10/19/2010
ANTENNA (30-1000MHz)	SUNOL	JB1	A022310	03/07/2011
ANTENNA (1-18GHz)	EMCO	3115	00022256	01/14/2011
PRE-AMPLIFIER	EMCI	EMC330	980022	02/04/2011
AMPLIFIER (1-18GHz)	HP	8449B	3008A01266	01/14/2011
RF SWITCH	EMEC	EMSW18	60432	01/21/2011
CABLE (30-1000MHz)	HUBER +SUHNER	SUCOFLEX 102	33105/2	01/21/2011
CABLE (1-40GHz)	HUBER +SUHNER	SUCOFLEX 102	33106/2	12/23/2010
CABLE (18-40GHz)	HUBER +SUHNER	SUCOFLEX 102	33633/2	12/23/2010
CABLE (1-26.5GHz)	HUBER +SUHNER	SUCOFLEX 104PEA	33959/4PEA	12/23/2010
CABLE (1-26.5GHz)	HUBER +SUHNER	SUCOFLEX 104PEA	33960/4PEA	01/21/2011
CABLE (30-1000MHz)	EMCI	EMCI-C-14	CH-D#13	04/05/2011
LOOP ANTENNA	EMCO	6502	8905-2356	06/10/2013
Test S/W	EZ-EMC			

NOTE: 1. The calibration interval of the above test instruments is 12 months and the calibrations are traceable to NML/ROC and NIST/USA.
 2. N.C.R = No Calibration Request.



7.3. TEST PROCEDURES (please refer to measurement standard or CCS SOP PA-031)

Procedure of Preliminary Test

- The equipment was set up as per the test configuration to simulate typical usage per the user's manual. When the EUT is a tabletop system, a wooden turntable with a height of 0.8 meters is used which is placed on the ground plane. When the EUT is a floor standing equipment, it is placed on the ground plane which has a 12 mm non-conductive covering to insulate the EUT from the ground plane.
- Support equipment, if needed, was placed as per ANSI C63.4.
- All I/O cables were positioned to simulate typical usage as per ANSI C63.4.
- The EUT received AC 120VAC/60Hz power source from the outlet socket under the turntable. All support equipment power received from another socket under the turntable.
- The antenna was placed at 3 or 10 meter away from the EUT as stated in ANSI C63.4. The antenna connected to the Spectrum Analyzer via a cable and at times a pre-amplifier would be used.
- The Analyzer / Receiver quickly scanned from 30MHz to 40GHz. The EUT test program was started. Emissions were scanned and measured rotating the EUT to 360 degrees and positioning the antenna 1 to 4 meters above the ground plane, in both the vertical and the horizontal polarization, to maximize the emission reading level.
- The test mode(s) described in Item 3.1 were scanned during the preliminary test:
- After the preliminary scan, we found the test mode described in Item 3.1 producing the highest emission level.
- The worst configuration of EUT and cable of the above highest emission level were recorded for reference of the final test.



Procedure of Final Test

- EUT and support equipment were set up on the turntable as per the configuration with highest emission level in the preliminary test.
- The Analyzer / Receiver scanned from 30MHz to 40GHz. Emissions were scanned and measured rotating the EUT to 360 degrees, varying cable placement and positioning the antenna 1 to 4 meters above the ground plane, in both the vertical and the horizontal polarization, to maximize the emission reading level.
- Recording at least the six highest emissions. Emission frequency, amplitude, antenna position, polarization and turntable position were recorded into a computer in which correction factors were used to calculate the emission level and compare reading to the applicable limit. Below 1GHz the Q.P. reading and above 1GHz the Peak and Average reading are presented.
- The test data of the worst-case condition(s) was recorded.

7.4. TEST SETUP

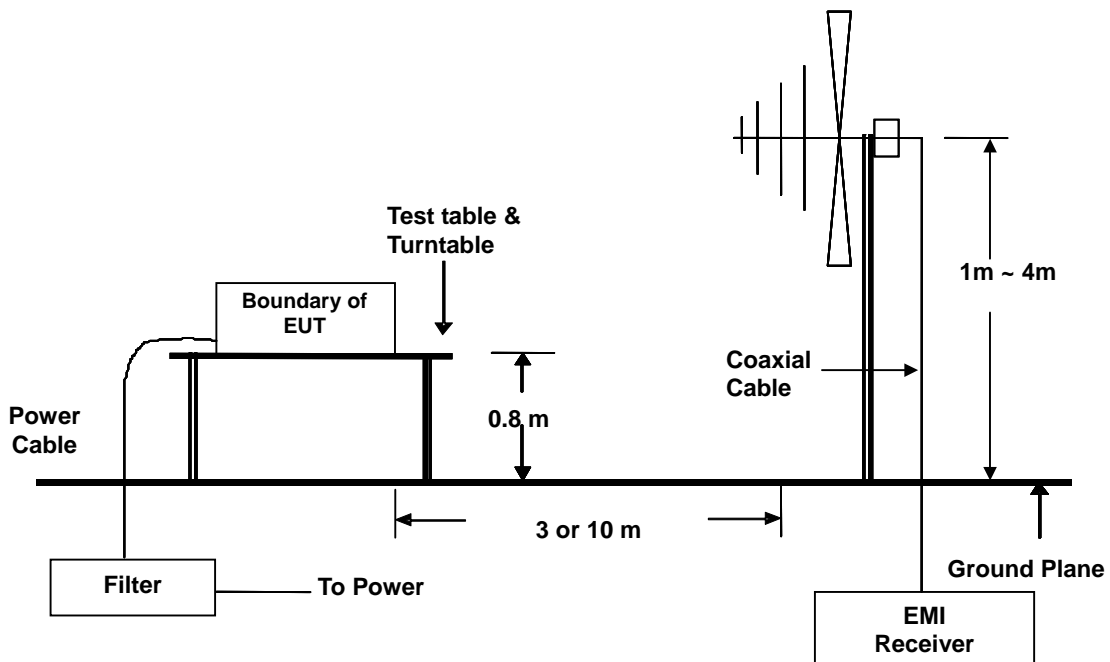

- For the actual test configuration, please refer to the related item – Photographs of the Test Configuration.



7.5. DATA SAMPLE

Below 1GHz

Freq. (MHz)	Reading (dBuV)	Factor (dB/m)	Result (dBuV/m)	Limit (dBuV/m)	Margin (dB)	Detector (P/Q)	Pol. (H/V)
x.xx	14.0	12.2	26.2	40	-13.8	Q	H

Above 1GHz

Freq. (MHz)	Reading (dBuV)	Factor (dB/m)	Result (dBuV/m)	Limit (dBuV/m)	Margin (dB)	Detector (P/A)	Pol. (H/V)
x.xx	42.95	0.55	43.50	60	-16.50	A	H

- Freq. = Emission frequency in MHz
- Reading = Uncorrected Analyzer/Receiver reading
- Factor = Antenna Factor + Cable Loss - Amplifier Gain
- Result = Reading + Factor
- Limit = Limit stated in standard
- Margin = Reading in reference to limit
- P = Peak Reading
- Q = Quasi-peak Reading
- A = Average Reading
- H = Antenna Polarization: Horizontal
- V = Antenna Polarization: Vertical

Calculation Formula

Margin (dB) = Result (dBuV/m) – Limit (dBuV/m)



7.6. TEST RESULTS

Below 1GHz

Model No.	GCS-1100I	Test Mode	Mode 1
Environmental Conditions	22deg.C, 85% RH, 1010hPa	6dB Bandwidth	120 kHz
Antenna Pole	Vertical	Antenna Distance	10m
Detector Function	Quasi-peak.	Tested by	Jason Lee
Standard	FCC CLASS A W/ EN 55022 CLASS A LIMIT		

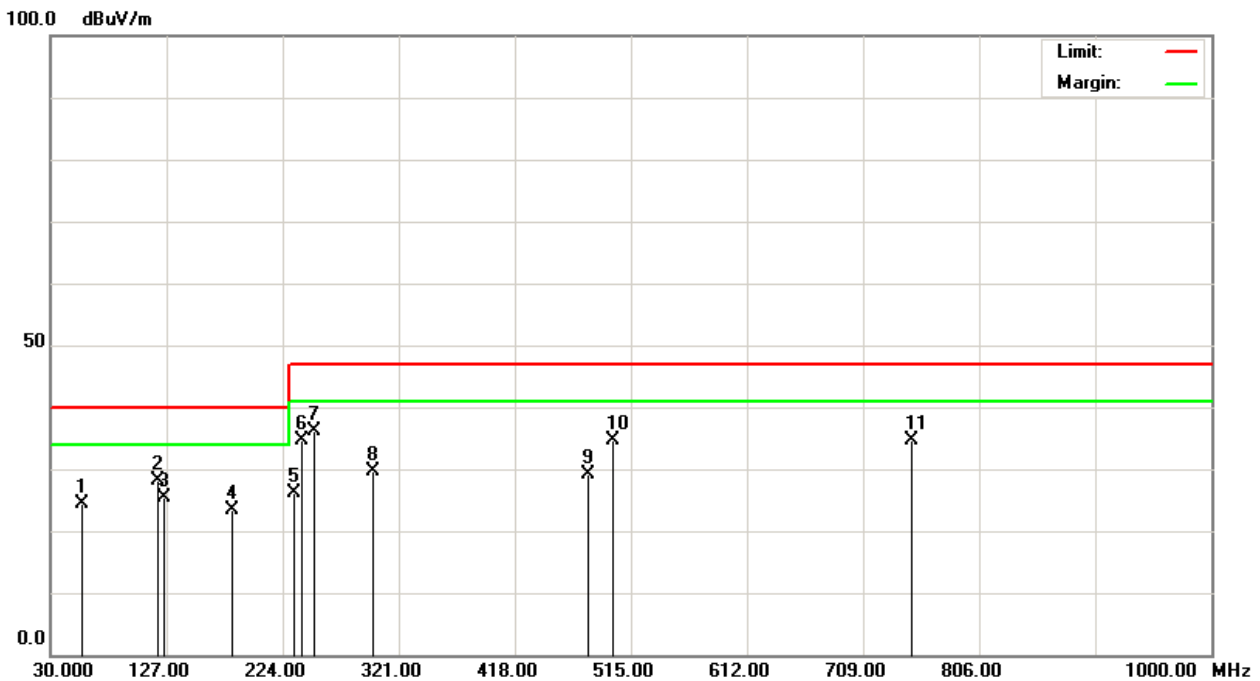

Radiated Emission Readings									
Frequency Range Investigated				30 MHz to 1000 MHz at 10m					
Freq. (MHz)	Reading (dBuV)	Factor (dB/m)	Result (dBuV/m)	Limit (dBuV/m)	Margin (dB)	Height (cm)	Degree (°)	Remark (P/Q)	Pol. (H/V)
56.0040	44.60	-20.31	24.29	40.00	-15.71	100	123	Q	V
119.9870	43.90	-15.81	28.09	40.00	-11.91	100	65	Q	V
125.0100	41.40	-16.05	25.35	40.00	-14.65	100	129	Q	V
181.3640	41.50	-18.09	23.41	40.00	-16.59	100	333	Q	V
233.3350	42.50	-16.39	26.11	47.00	-20.89	100	76	Q	V
239.9920	50.40	-15.70	34.70	47.00	-12.30	100	253	Q	V
250.0040	50.50	-14.32	36.18	47.00	-10.82	100	121	Q	V
300.0200	43.20	-13.45	29.75	47.00	-17.25	100	79	Q	V
480.0500	37.20	-8.19	29.01	47.00	-17.99	400	63	Q	V
499.9800	42.40	-7.70	34.70	47.00	-12.30	400	0	Q	V
749.9960	38.90	-4.19	34.71	47.00	-12.29	400	121	Q	V

- Note:**
1. 30MHz to 1000MHz test is Applicable CISPR 22 / EN 55022 standard.
 2. The other emission levels were very low against the limit.
 3. P= Peak Reading; Q= Quasi-peak Reading.



Model No.	GCS-1100I	Test Mode	Mode 1
Environmental Conditions	22deg.C, 85% RH, 1010hPa	6dB Bandwidth	120 kHz
Antenna Pole	Horizontal	Antenna Distance	10m
Detector Function	Quasi-peak.	Tested by	Jason Lee
Standard	FCC CLASS A W/ EN 55022 CLASS A LIMIT		

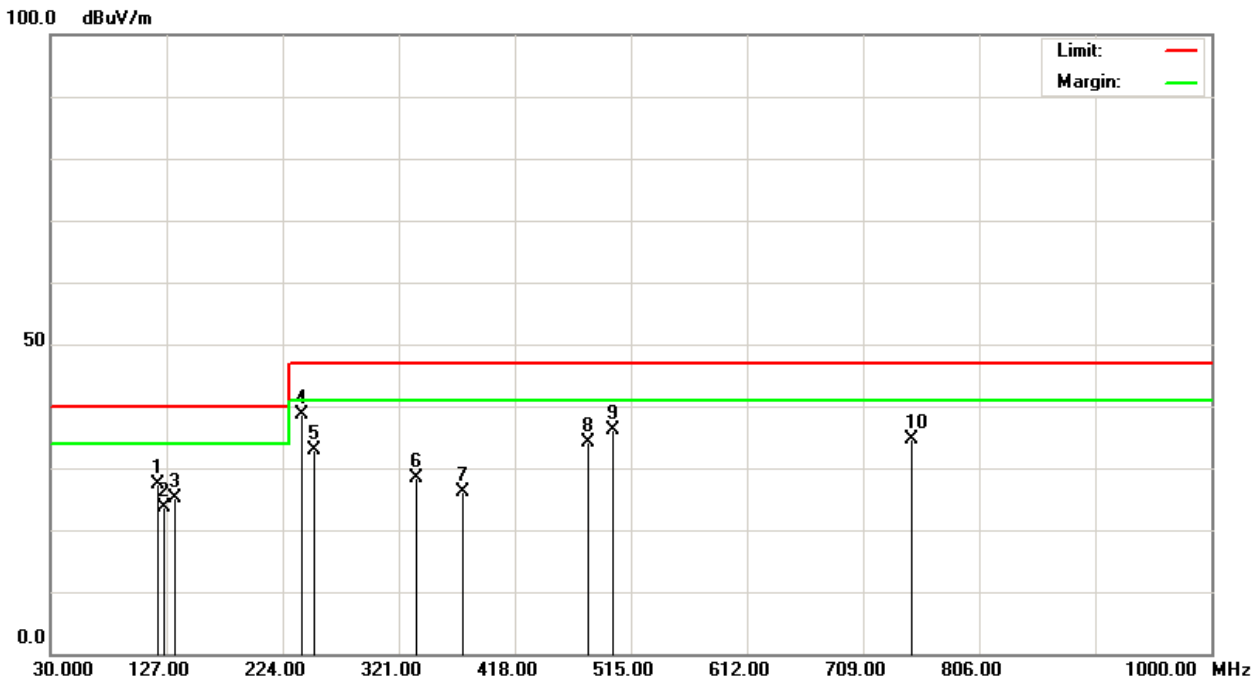

Radiated Emission Readings									
Frequency Range Investigated				30 MHz to 1000 MHz at 10m					
Freq. (MHz)	Reading (dBuV)	Factor (dB/m)	Result (dBuV/m)	Limit (dBuV/m)	Margin (dB)	Height (cm)	Degree (°)	Remark (P/Q)	Pol. (H/V)
120.0100	43.20	-15.81	27.39	40.00	-12.61	400	233	Q	H
124.9960	39.60	-16.05	23.55	40.00	-16.45	400	79	Q	H
133.6300	41.50	-16.47	25.03	40.00	-14.97	400	121	Q	H
239.9880	54.40	-15.70	38.70	47.00	-8.30	400	75	Q	H
250.0030	47.10	-14.32	32.78	47.00	-14.22	400	0	Q	H
335.6060	40.40	-12.14	28.26	47.00	-18.74	400	233	Q	H
375.0020	37.10	-10.96	26.14	47.00	-20.86	400	65	Q	H
480.0400	42.40	-8.20	34.20	47.00	-12.80	100	1	Q	H
500.0010	43.80	-7.70	36.10	47.00	-10.90	100	256	Q	H
749.9920	38.90	-4.19	34.71	47.00	-12.29	100	234	Q	H

- Note:**
1. 30MHz to 1000MHz test is Applicable CISPR 22 / EN 55022 standard.
 2. The other emission levels were very low against the limit.
 3. P= Peak Reading; Q= Quasi-peak Reading.



Above 1GHz

Model No.	GCS-1100I	Test Mode	Mode 1
Environmental Conditions	26deg.C, 60% RH, 1010hPa	6dB Bandwidth	1 MHz
Antenna Pole	Vertical / Horizontal	Antenna Distance	3m
Highest frequency generated or used	1600MHz	Upper frequency	8000MHz
Detector Function	Peak or average.	Tested by	Howard Pang
Standard	FCC CLASS A		

Radiated Emission Readings									
Frequency Range Investigated				30 MHz to 1000 MHz at 10m					
Freq. (MHz)	Reading (dBuV)	Factor (dB/m)	Result (dBuV/m)	Limit (dBuV/m)	Margin (dB)	Height (cm)	Degree (°)	Remark (P/Q)	Pol. (H/V)
1200.000	53.15	-8.72	44.43	80.00	-35.57	100	137	Q	V
1330.000	58.95	-7.89	51.06	80.00	-28.94	100	175	Q	V
1520.000	54.86	-6.69	48.17	80.00	-31.83	150	116	Q	V
1600.000	53.92	-6.20	47.72	80.00	-32.28	150	342	Q	V
1860.000	52.99	-4.64	48.35	80.00	-31.65	100	228	Q	V
2130.000	44.67	-3.36	41.31	80.00	-38.69	200	172	Q	V

Radiated Emission Readings									
Frequency Range Investigated				30 MHz to 1000 MHz at 10m					
Freq. (MHz)	Reading (dBuV)	Factor (dB/m)	Result (dBuV/m)	Limit (dBuV/m)	Margin (dB)	Height (cm)	Degree (°)	Remark (P/Q)	Pol. (H/V)
1200.000	53.00	-8.72	44.28	80.00	-35.72	100	296	Q	H
1330.000	54.42	-7.89	46.53	80.00	-33.47	150	355	Q	H
1360.000	50.32	-7.69	42.63	80.00	-37.37	100	241	Q	H
1420.000	49.51	-7.31	42.20	80.00	-37.80	100	173	Q	H
1600.000	48.29	-6.20	42.09	80.00	-37.91	200	157	Q	H
1860.000	55.36	-4.64	50.72	80.00	-29.28	150	142	Q	H

- Note:** 1. The other emission levels were very low against the limit.
 2. P= Peak Reading; A= Average Reading.



8 PHOTOGRAPHS OF THE TEST CONFIGURATION CONDUCTED EMISSION TEST





RADIATED EMISSION TEST

