



## VERIFICATION OF COMPLIANCE

**Equipment Under Test:** Panel PC (IPC)  
**Trade Name:** N/A  
**Model Number:** G3000  
**Serial Number:** N/A  
**Applicant:** **AASIC Computer Inc.**  
4F-1, No. 131, Lane 235, Pao Chiao Rd., Hsin Tien,  
Taipei Shian, Taiwan, R.O.C.  
**Manufacturer:** **AASIC Computer Inc.**  
4F-1, No. 131, Lane 235, Pao Chiao Rd., Hsin Tien,  
Taipei Shian, Taiwan, R.O.C.  
**Type of Test:** FCC Class A  
**Measurement Procedure:** ANSI C63.4: 1992  
**File Number:** 000560-F  
**Date of test:** August 3 ~ 9, 2000  
**Deviation:** According to applicant's declaration this EUT is a class A product,  
and to be market in industrial environment only.  
**Condition of Test Sample:** Normal

The above equipment was tested by C&C Laboratory, Co., Ltd. for compliance with the requirements set forth in the FCC Rules and Regulations Part 15, Subpart B and the measurement procedure according to ANSI C63.4. This said equipment in the configuration described in this report shows the maximum emission levels emanating from equipment are within the compliance requirements.

The test results of this report relate only to the tested sample identified in this report.

  
\_\_\_\_\_  
Authorized Signatory

Report Number: 000560-F  
August 16, 2000



## FCC CLASS A COMPLIANCE REPORT

for

Electromagnetic Emissions

of

Panel PC (IPC)

Trade Name : N/A  
Model Number : G3000  
Serial Number : N/A  
Report Number : 000560-F  
Date : August 16, 2000

Prepared for :

**AASIC Computer Inc.**  
4F-1, No. 131, Lane 235, Pao Chiao Rd., Hsin Tien,  
Taipei Shian, Taiwan, R.O.C.

Prepared by :



**C&C LABORATORY CO., LTD.**  
#B1, 1<sup>st</sup> Fl., Universal Center, No. 183, Sec. 1,  
Tatung Rd., Hsi Chih,  
Taipei Hsien, Taiwan, R.O.C.  
TEL: (02) 86422071  
FAX: (02) 86422256

**This report shall not be reproduced, except in full, without the written approval of  
C&C Laboratory, Co., Ltd.**



## TABLE OF CONTENTS

DESCRIPTION	PAGE
VERIFICATION OF COMPLIANCE	3
SYSTEM DESCRIPTION	4
PRODUCT INFORMATION	5
SUPPORT EQUIPMENT	6
MEASUREMENT PROCEDURE & LIMIT (LINE CONDUCTED EMISSION TEST)	7
MEASUREMENT PROCEDURE & LIMIT (RADIATED EMISSION TEST)	9
SUMMARY DATA	12
TEST FACILITY	17
TEST EQUIPMENT	18
BLOCK DIAGRAM OF TEST SETUP	21
APPENDIX 1 PHOTOGRAPHS (TEST SETUP OF LINE CONDUCTED EMISSION TEST)	22
APPENDIX 2 PHOTOGRAPHS (TEST SETUP OF RADIATED EMISSION TEST)	24
APPENDIX 3 PHOTOGRAPHS OF EUT	26



## SYSTEM DESCRIPTION

### **EUT Test Program:**

1. EMI test program was loaded and executed in Windows mode
2. A communication software was loaded and executed to drive LAN, then to communicate with remote side.
3. Data was sent to LCD Panel of EUT and CRT monitor, filling the screen with upper case of "H" patterns.
4. Test program sequentially exercised all related I/O's of EUT and send "H" patterns to all applicable ports of EUT.
5. Repeat 2 to 3. Test program is self-repeating throughout the test.



## PRODUCT INFORMATION

**Housing Type:** Metal case  
**EUT Power Rating:** 100-240VAC, 3.15A, 47-62Hz  
**AC Power during Test** 120VAC/60Hz  
**Power Supply Manufacturer:** POWER ADD, INC.  
**Power Supply Model Number:** PPS100-31  
**AC Power Cord Type:** Unshielded, 1.8m (Detachable) with a core  
**CPU Manufacture:** Intel      **Type:** Celeron 433MHz  
**OSC/Clock Frequencies:** 66MHz  
**Memory Capacity:**                      **Install:** 64MB  
**HDD Manufacturer:** Toshiba      **Model:** HDD2130  
**FDD Manufacturer:** NEC      **Model:** FD1238T  
**12.1" TFT LCD Panel Manufacturer:** Toshiba      **Model:** NRP28-8875-413  
**VGA Card Manufacturer:** On Board

### I/O Port of EUT

I/O PORT TYPES	Q'TY	TESTED WITH
1) Parallel Port	1	1
2) Serial Port	3	3
3) Video Port	1	1
4) PS/2 Keyboard Port	1	1
5) PS/2 Mouse Port	1	1
6) Microphone Port	1	1
7) Line-in Port	1	1
8) Line-out Port	1	1
9) LAN Port	1	1
10) USB Port	2	2



## SUPPORT EQUIPMENT

No.	Equipment	Model #	Serial #	FCC ID	Trade Name	Data Cable	Power Cord
1.	Monitor	GDM-17SE2T	7139819	AK8GDM17SE2T	SONY	Shielded, 1.8m	Unshielded, 1.8m
2.	Printer	2225C	3137S01428	DSI6XU2225	HP	Shielded, 1.8m	Unshielded, 1.8m
3.	Modem	103/212A	A038518	EF56A5103/212A	TEAM	Shielded, 1.8m	Unshielded, 1.8m
4.	Modem	2400	94-364-176276	DK467GSM24	Computer Peripherals	Shielded, 1.8m	Unshielded, 1.8m
5.	Modem	2400	94-364-176277	DK467GSM24	Computer Peripherals	Shielded, 1.8m	Unshielded, 1.8m
6.	PS/2 Keyboard	SK-2502C	M99043551	FCC DoC	HP	Shielded, 1.8m	N/A
7.	PS/2 Mouse	M-S34	LZC84445540	DZL211029	HP	Shielded, 1.8m	N/A
8.	USB Mouse	M-BB48	LZE1450642	FCC DoC	Logitech	Shielded, 1.8m	N/A
9.	USB Mouse	M-BB48	LZE1450904	FCC DoC	Logitech	Shielded, 1.8m	N/A
10.	Walkman	YX-328	W2	N/A	YING-KO	Unshielded, 1.8m	N/A
11.	Multimedia Headset	SX-M	A5-4	N/A	TOKYO	Unshielded, 1.8m	N/A
12.	Notebook PC (Remote)	365	TZ30518	FCC DoC	Acer	Shielded, 20m with a core	AC I/P: Unshielded, 0.9m DC O/P: Unshielded, 1.9m

**Note:** All the above equipment/cables were placed in worse case positions to maximize emission signals during emission test.

**Grounding:** Grounding was in accordance with the manufacturer's requirements and conditions for the intended use.



## MEASUREMENT PROCEDURE (PRELIMINARY LINE CONDUCTED EMISSION TEST)

- 1) The equipment was set up as per the test configuration to simulate typical actual usage per the user's manual. When the EUT is a tabletop system, a wooden table with a height of 0.8 meters is used and is placed on the ground plane as per ANSI C63.4 (see Test Facility for the dimensions of the ground plane used). When the EUT is a floor-standing equipment, it is placed on the ground plane which has a 3-12 mm non-conductive covering to insulate the EUT from the ground plane.
- 2) Support equipment, if needed, was placed as per ANSI C63.4.
- 3) All I/O cables were positioned to simulate typical actual usage as per ANSI C63.4.
- 4) The EUT received AC power through a Line Impedance Stabilization Network (LISN) which supplied power source of 120VAC/60Hz and was grounded to the ground plane.
- 5) All support equipment received power from a second LISN supplying power of 110VAC/60Hz, if any.
- 6) The EUT test program was started. Emissions were measured on each current carrying line of the EUT using a spectrum analyzer / Receiver connected to the LISN powering the EUT. The LISN has two monitoring points: Line 1 (Hot Side) and Line 2 (Neutral Side). Two scans were taken: one with Line 1 connected to Analyzer / Receiver and Line 2 connected to a 50 ohm load; the second scan had Line 1 connected to a 50 ohm load and Line 2 connected to the Analyzer / Receiver.
- 7) Analyzer / Receiver scanned from 150kHz to 30MHz for emissions in each of the test modes.
- 8) During the above scans, the emissions were maximized by cable manipulation.
- 9) The following test mode(s) were scanned during the preliminary test:

**Mode(s):**

- 1. 800 x 600 Resolution**
- 2. 640 x 480 Resolution**

- 10) After the preliminary scan, we found the following test mode producing the highest emission level.

**Mode: 1.**

Then, the EUT configuration and cable configuration of the above highest emission level were recorded for reference of final testing.



## MEASUREMENT PROCEDURE (FINAL LINE CONDUCTED EMISSION TEST)

- 1) EUT and support equipment was set up on the test bench as per step 10 of the preliminary test.
- 2) A scan was taken on both power lines, Line 1 and Line 2, recording at least the six highest emissions. Emission frequency and amplitude were recorded into a computer in which correction factors were used to calculate the emission level and compare reading to the applicable limit. If EUT emission level was less -2dB to the A.V. limit in Q.P. mode, then the emission signal was re-checked using an Average detector.
- 3) The test data of the worst case condition(s) was reported on the Summary Data page.

**Data Sample:**

Freq. MHz	Q.P. Raw dBuV	Average Raw dBuV	Q.P. Limit dBuV	Average Limit dBuV	Q.P. Margin dB	Average Margin dB	Note
x.xx	43.95	---	56	46	-12.05	---	L 1

Freq.	= Emission frequency in MHz
Raw dBuV	= Uncorrected Analyzer/Receiver reading
Limit dBuV	= Limit stated in standard
Margin dB	= Reading in reference to limit
Note	= Current carrying line of reading
“---“	= The emission level complied with the Average limits, with at least 2 dB margin, so no further recheck.

### LINE CONDUCTED EMISSION LIMIT

Frequency	Maximum RF Line Voltage	
	Q.P.	AVERAGE
150kHz-500kHz	79dBuV	66dBuV
500kHz-5MHz	73dBuV	60dBuV
5MHz-30MHz	73dBuV	60dBuV

Note: The lower limit shall apply at the transition frequency.





## MEASUREMENT PROCEDURE (PRELIMINARY RADIATED EMISSION TEST)

- 1) The equipment was set up as per the test configuration to simulate typical actual usage per the user's manual. When the EUT is a tabletop system, a wooden turntable with a height of 0.8 meters is used which is placed on the ground plane as per ANSI C63.4 (see Test Facility for the dimensions of the ground plane used). When the EUT is a floor-standing equipment, it is placed on the ground plane which has a 3-12 mm non-conductive covering to insulate the EUT from the ground plane.
- 2) Support equipment, if needed, was placed as per ANSI C63.4.
- 3) All I/O cables were positioned to simulate typical actual usage as per ANSI C63.4.
- 4) The EUT received 120VAC/60Hz power source from the outlet socket under the turntable. All support equipment received 110VAC/60Hz power from another socket under the turntable, if any.
- 5) The antenna was placed at 10 meter away from the EUT as stated in ANSI C63.4. The antenna connected to the analyzer via a cable and at times a pre-amplifier would be used.
- 6) The Analyzer quickly scanned from 30MHz to 5000MHz. The EUT test program was started. Emissions were scanned and measured rotating the EUT to 360 degrees and positioning the antenna 1 to 4 meters above the ground plane, in both the vertical and the horizontal polarization, to maximize the emission reading level.
- 7) The following test mode(s) were scanned during the preliminary test:

**Mode(s):**

1. 800 x 600 Resolution
2. 640 x 480 Resolution

- 8) After the preliminary scan, we found the following test mode producing the highest emission level.

**Mode: 1.**

Then, the EUT and cable configuration, antenna position, polarization and turntable position of the above highest emission level were recorded for reference of final testing.



## MEASUREMENT PROCEDURE (FINAL RAIDATED EMISSION TEST)

- 1) EUT and support equipment were set up on the turntable as per step 8 of the preliminary test.
- 2) The Analyzer / Receiver scanned from 30MHz to 5000MHz. Emissions were scanned and measured rotating the EUT to 360 degrees, varying cable placement and positioning the antenna 1 to 4 meters above the ground plane, in both the vertical and the horizontal polarization, to maximize the emission reading level.
- 3) Recorded at least the six highest emissions. Emission frequency, amplitude, were recorded into a computer ( The antenna position, polarization and turntable position were kept in raw data file ) in which correction factors were used to calculate the emission level and compare reading to the applicable limit.
- 4) The test data of the worst case condition(s) was reported on the Summary Data page.

**Data Sample:**

Freq. (MHz)	Raw Data (dBuV/m)	Corr. Factor (dB)	Emiss. Level ( dBuV/m )	Limits	Margin (dB)
xx.xx	14.0	11.2	26.2	30	-3.8

Freq.	= Emission frequency in MHz
Raw Data (dBuV/m)	= Uncorrected Analyzer / Receiver reading
Corr. Factor (dB)	= Correction factors of antenna factor and cable loss
Emiss. Level	= Raw reading converted to dBuV/m and CF added
Limit dBuV/m	= Limit stated in standard
Margin dB	= Reading in reference to limit



### RADIATED EMISSION LIMIT

Frequency (MHz)	Distance (m)	Maximum Field Strength Limit (dBuV/m)		
		Q.P.	AVERAGE	PEAK
30-230	10	40	/	/
230-1000	10	47	/	/
Above 1000	3	/	60	80

**\*\*Note:** “/” means the limit line is not applicable.



## SUMMARY DATA (LINE CONDUCTED TEST)

**Model Number:** G3000

**Location:** Site # 4

**Tested by:** Tony Tsai

**Test Mode:** Mode 1

**Test Results:** Passed

**Temperature:** 29°C

**Humidity:** 66%RH

(The chart below shows the highest readings taken from the final data)

FREQ MHz	Q.P. RAW dBuV	AVG RAW dBuV	Q.P. Limit dBuV	AVG Limit dBuV	Q.P. Margin dB	AVG Margin dB	NOTE
0.180	44.1	---	79.0	66.0	-34.9	---	L1
1.030	40.2	---	73.0	60.0	-32.8	---	L1
2.730	38.3	---	73.0	60.0	-34.7	---	L1
3.900	36.0	---	73.0	60.0	-37.0	---	L1
7.790	36.8	---	73.0	60.0	-36.2	---	L1
24.580	41.7	---	73.0	60.0	-31.3	---	L1
0.150	65.7	---	79.0	66.0	-13.3	---	L2
3.820	47.8	---	73.0	60.0	-25.2	---	L2
3.900	56.6	---	73.0	60.0	-16.4	---	L2
7.788	61.0	---	73.0	60.0	-12.0	---	L2
12.290	50.3	---	73.0	60.0	-22.7	---	L2
24.580	48.1	---	73.0	60.0	-24.9	---	L2

L1 = Line One (Hot side) / L2 = Line Two (Neutral side)

**\*\*NOTE:** "..." denotes the emission level was or more than 2dB below the Average limit, so no re-check anymore.

C&C Lab. Co. Shielded Room4  
 CISPR 22 - Class A QP/AU Limit

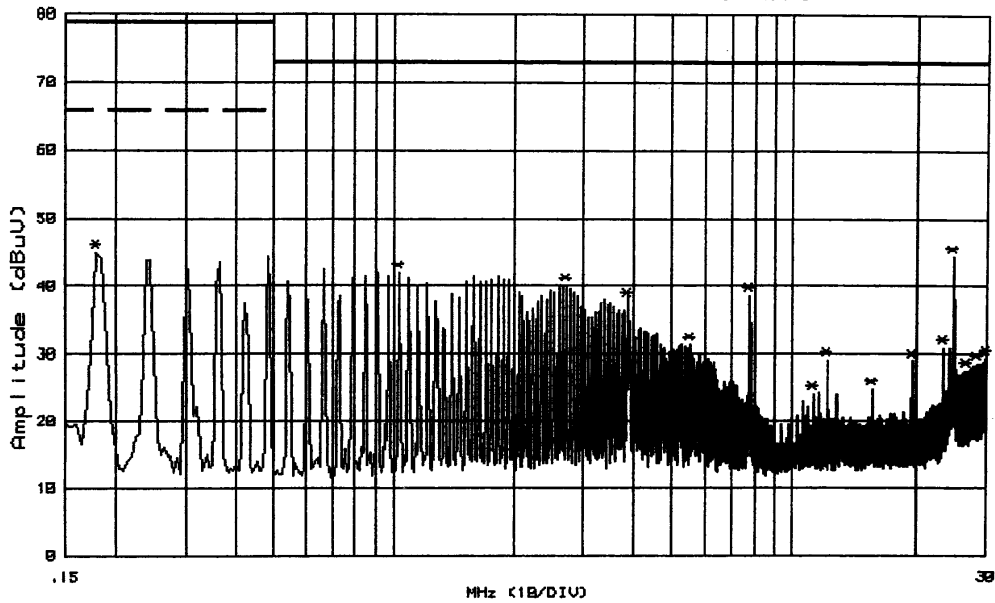

Customer: NA File#: 2613 Date : 9 Aug 2000 19:14:06  
 Model : G3000 Humd.: 66 (%) Temp. : 29 (C)  
 Mode : FULL SYSTEM Port : L1 Tester: TONY TSAI  
 Reading : Peak (R&S Receiver)  
 Remark : LEARNING AGE

No.	Freq. (MHz)	Reading (dBuV)	I_Loss (dB)	Total (dBuV)	QP.Lmt (dBuV)	Margin (dB)	Warning Mark
1	.180	44.9	.1	45.0	79.0	-34.0	
2	1.030	41.8	.2	42.0	73.0	-31.0	
3	2.730	39.7	.3	40.0	73.0	-33.0	
4	3.900	37.5	.3	37.8	73.0	-35.2	
5	5.520	30.9	.5	31.3	73.0	-41.7	
6	7.790	38.1	.5	38.6	73.0	-34.4	
7	11.350	23.3	.8	24.1	73.0	-48.9	
8	12.290	28.3	.8	29.1	73.0	-43.9	
9	15.610	23.8	1.0	24.8	73.0	-48.2	
10	19.510	27.9	1.0	28.9	73.0	-44.1	
11	23.400	29.8	1.1	30.9	73.0	-42.1	
12	24.580	43.2	1.1	44.3	73.0	-28.7	
13	26.720	26.2	1.3	27.5	73.0	-45.5	
14	28.350	27.3	1.3	28.6	73.0	-44.4	
15	29.940	28.1	1.3	29.4	73.0	-43.6	

C & C Lab. Co. Ltd.  
 File No. 000560-F  
 Page 12-1

C&C Lab. Co. Shielded Room4  
CISPR 22 - Class A QP/AU Limit

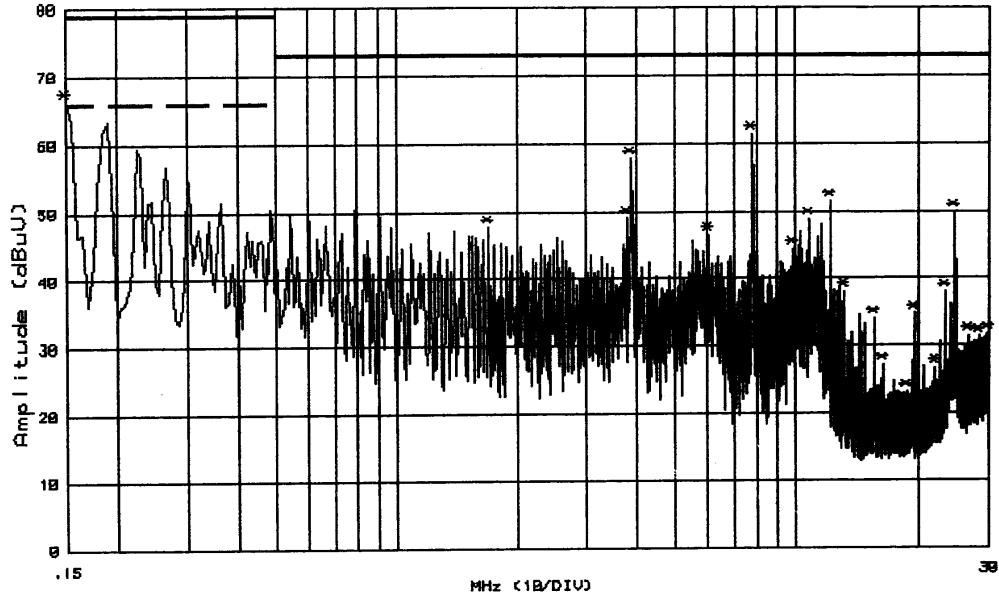

Customer:NA File#: 2614 Date : 9 Aug 2000 19:23:29  
 Model :G3000 Humd.:66 (%) Temp. :29 (C)  
 Mode :FULL SYSTEM Port :L2 Tester:TONY TSAI  
 Reading :Peak(R&S Receiver)  
 Remark :LEARNING AGE

No.	Freq. (MHz)	Reading (dBuV)	I_Loss (dB)	Total (dBuV)	QP.Lmt (dBuV)	Margin (dB)	Warning Mark
1	.150	66.3	.1	66.4	79.0	-12.6	
2	1.700	47.5	.2	47.7	73.0	-25.3	
3	3.820	48.9	.2	49.1	73.0	-23.9	
4	3.900	57.5	.2	57.7	73.0	-15.3	
5	6.050	46.3	.3	46.6	73.0	-26.4	
6	7.790	61.1	.3	61.4	73.0	-11.6	
7	9.910	44.1	.3	44.4	73.0	-28.6	
8	10.810	48.4	.4	48.8	73.0	-24.2	
9	12.290	51.1	.4	51.5	73.0	-21.5	
10	13.290	37.7	.4	38.1	73.0	-34.9	
1	15.610	33.5	.6	34.0	73.0	-39.0	
2	16.470	26.6	.6	27.2	73.0	-45.8	
13	18.770	22.5	.6	23.1	73.0	-49.9	
4	19.510	34.1	.6	34.7	73.0	-38.3	

C & C Lab. Co. Ltd.	
File No.	000560-F
Page	12-2



### SUMMARY DATA (RADIATED EMISSION TEST)

**Model Number:** G3000

**Location:** Site # 2

**Tested by:** Michael Chen

**Test Mode:** Mode 1

**Polar:** Vertical -- 10m

**Detector Function:** Quasi-Peak

**Test Results:** Passed

**Temperature:** 30°C

**Humidity:** 72%RH

(The chart below shows the highest readings taken from the final data)

Freq. (MHz)	Raw Data (dBuV/m)	Corr. Factor (dB)	Emiss. Level ( dBuV/m )	Limits	Margin (dB)
50.75	26.3	9.1	35.4	40.0	-4.6
66.32	26.8	7.4	34.2	40.0	-5.8
117.05	23.4	14.3	37.7	40.0	-2.3
167.01	23.6	12.4	36.0	40.0	-4.0
434.50	16.0	22.8	38.8	47.0	-8.2
507.42	16.4	24.5	40.9	47.0	-6.1



### SUMMARY DATA (RADIATED EMISSION TEST)

**Model Number:** G3000

**Location:** Site # 2

**Tested by:** Michael Chen

**Test Mode:** Mode 1

**Polar:** Horizontal -- 10m

**Detector Function:** Quasi-Peak

**Test Results:** Passed

**Temperature:** 30°C

**Humidity:** 72%RH

(The chart below shows the highest readings taken from the final data)

Freq. (MHz)	Raw Data (dBuV/m)	Corr. Factor (dB)	Emiss. Level ( dBuV/m )	Limits	Margin (dB)
66.42	26.1	7.4	33.5	40.0	-6.5
89.75	26.3	11.0	37.3	40.0	-2.7
117.04	23.3	14.3	37.6	40.0	-2.4
167.02	25.0	12.4	37.4	40.0	-2.6
434.50	21.5	22.8	44.3	47.0	-2.7
507.49	18.9	24.5	43.4	47.0	-3.6





## SUMMARY DATA

### (RADIATED EMISSION TEST)

**Model Number:** G3000 **Location:** 3 meter chamber  
**Tested by:** Michael Chen **Polar:** Vertical ---3 m  
**Test Mode:** Mode 1  
**Detector Function:** Pk / A.V. **Test Results:** Passed  
**Temperature:** 30°C **Humidity:** 70%RH

(The chart below shows the highest readings taken from the final data)

Freq. (MHz)	Raw Data (dBuV/m)	Corr. Factor (dB)	Emiss. Level ( dBuV/m )	Limits A.V. ( )	Margin (dB)
1069.00	17.2	27.2	44.4(Pk)	60.0	-15.6
1136.00	21.0	27.3	48.3(Pk)	60.0	-11.7
1403.00	14.9	28.1	43.0(Pk)	60.0	-17.0
1536.00	12.6	28.5	41.1(Pk)	60.0	-18.9

**Note:** In case of peak reading complied with the A.V. limit at least 2dB margin, no measurement with A.V. detector required.



### SUMMARY DATA (RADIATED EMISSION TEST)

**Model Number:** G3000 **Location:** 3 meter chamber  
**Tested by:** Michael Chen **Polar:** Horizontal ---3 m  
**Test Mode:** Mode 1  
**Detector Function:** Pk / A.V. **Test Results:** Passed  
**Temperature:** 30°C **Humidity:** 70%RH

(The chart below shows the highest readings taken from the final data)

Freq. (MHz)	Raw Data (dBuV/m)	Corr. Factor (dB)	Emiss. Level ( dBuV/m )	Limits A.V. ( )	Margin (dB)
1069.00	13.3	27.2	40.5(Pk)	60.0	-19.5
1269.00	13.3	27.7	41.0(Pk)	60.0	-19.0
1536.00	11.1	28.5	39.6(Pk)	60.0	-20.4
1813.00	10.3	29.9	40.2(Pk)	60.0	-19.8

**Note:** In case of peak reading complied with the A.V. limit at least 2dB margin, no measurement with A.V. detector required.



## TEST FACILITY

- Location:** No. 15, 14 Line, Chin Twu Chi, Lu Chu Hsiang, Taoyuan, Taiwan, R.O.C.
- Description:** There are four 3/10m open area test sites and three line conducted labs for final test.  
The Open Area Test Sites and the Line Conducted labs are constructed and calibrated to meet the FCC requirements in documents ANSI C63.4: 1992 and CISPR 22/EN 55022 requirements.
- Site Filing:** A site description is on file with the Federal Communications Commission, 7435 Oakland Mills Road, Columbia, MD 21046.  
  
Registration also was made with Voluntary Control Council for Interference (VCCI).
- Site Accreditation:** Accredited by NEMKO (Authorization #: ELA 124) for EMC & A2LA (Certificate #: 824.01) for Emission  
  
Also accredited by BSMI for the product category of Information Technology Equipment.
- Instrument Tolerance:** All measuring equipment is in accord with ANSI C63.4 and CISPR 22 requirements that meet industry regulatory agency and accreditation agency requirement.
- Ground Plane:** Two conductive reference ground planes were used during the Line Conducted Emission, one in vertical and the other in horizontal. The dimensions of these ground planes are as below. The vertical ground plane was placed distancing 40 cm to the rear of the wooden test table on where the EUT and the support equipment were placed during test. The horizontal ground plane projected 50 cm beyond the footprint of the EUT system and distanced 80 cm to the wooden test table. For Radiated Emission Test, one horizontal conductive ground plane extended at least 1m beyond the periphery of the EUT and the largest measuring antenna, and covered the entire area between the EUT and the antenna. It has no holes or gaps having longitudinal dimensions larger than one-tenth of a wavelength at the highest frequency of measurement up to 1GHz.
- Site # 1 & # 3 Line Conducted Test Site:** Vertical ground plane (2.2m x 2.2m)  
Horizontal ground plane (2.5m x 2.5m)
- Site # 4 Line Conducted Test Site:** At Shielding Room

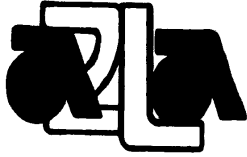

**THE AMERICAN  
ASSOCIATION  
FOR LABORATORY  
ACCREDITATION**

**ACCREDITED LABORATORY**

A2LA has accredited

**C & C LABORATORY CO., LTD**  
Taipei, Taiwan, R.O.C

for technical competence in the field of

**Electrical (EMC) Testing**

The accreditation covers the specific tests and types of tests listed on the agreed scope of accreditation. This laboratory meets the requirements of ISO/IEC Guide 25-1990 "General Requirements for the Competence of Calibration and Testing Laboratories" (equivalent to relevant requirements of the ISO 9000 series of standards) and any additional program requirements in the identified field of testing.

Presented this 28<sup>th</sup> day of April, 2000.



  
President  
For the Accreditation Council  
Certificate Number 824.01  
Valid to January 31, 2002

For tests or types of tests to which this accreditation applies, please refer to the laboratory's Electrical (EMC) Scope of Accreditation



## American Association for Laboratory Accreditation

### SCOPE OF ACCREDITATION TO ISO/IEC GUIDE 25-1990 and EN 45001-1989

C & C LABORATORY CO., LTD  
No. 15, 14 Lin, Chin Twu Chi  
Lu Chu Hsiang, Taoyuan, TAIWAN, R.O.C.  
Charles Wang Phone: 002 886 3 324 5966  
Fax: 002 886 3 324 5235

#### ELECTRICAL (EMC)

Valid to: January 31, 2002

Certificate Number: 0824-01

In recognition of the successful completion of the A2LA evaluation process, accreditation is granted to this laboratory to perform the following tests:

Electrical Emissions – Enclosure – 3 & 10 Meters; to 26.5 GHz (Sites 1, 2, 3 and 4)  
Electrical Emissions – AC Power – 0 - 300 V; 50 - 400 Hz (Sites 1, 2, 3 and 4)  
Electrical Immunity – Enclosure – 27 - 80 MHz / 3V/m; 80 MHz - 1 GHz / 10V/m  
Electrical Immunity – AC Power, DC Power, Signal & Control  
Electrical Fast Transient (EFT)  
Electrostatic Discharge (ESD) to 25 kV  
Electrical Power Surge  
Power Magnetic Field Immunity  
Voltage Dips, Shots, Variations

#### On the following products/equipment:

Computer Components and Peripherals; Networking Components; Wireless Communications Components; Electronic Components; Televisions; Home Appliances

#### Using the following test methods/specifications/standards:

Code of Federal Regulations (CFR) 47, FCC Part 15 using ANSI C63.4  
AS/NZS 3548  
BSMI CNS: 13438, 13439, 13783, 13803  
CISPR: 11, 14, 22  
EN: 50081-1, 50082-1, 55011, 55022, 55014, 61000-4-2, 61000-4-3, 61000-4-4, 61000-4-5, 61000-4-6, 61000-4-8, 61000-4-11  
VCCI V3 (1999)  
IEC: 801-2, 801-3, 801-4

*Peter Abney*



FEDERAL COMMUNICATIONS COMMISSION  
Equipment Authorization Division  
7435 Oakland Mills Road  
Columbia, MD. 21046

February 01, 1999

Registration Number: 93105

C & C Laboratory Co., Ltd.  
1st Fl., No. 344, Fu Ching Street  
Taipei  
Taiwan, R.O.C.

Attention: Charles Wang

Re: Measurement facility located at Taoyuan, Site No. 4  
3 & 10 meters  
Date of Listing: February 01, 1999

Gentlemen:

Your submission of the description of the subject measurement facility has been reviewed and found to be in compliance with the requirements of Section 2.948 of the FCC Rules. The description has, therefore, been placed on file and the name of your organization added to the Commission's list of facilities whose measurement data will be accepted in conjunction with applications for Certification under Parts 15 or 18 of the Commission's Rules. Please note that this filing must be updated for any changes made to the facility, and at least every three years from the date of listing the data on file must be certified as current.

If requested, the above mentioned facility has been added to our list of those who perform these measurement services for the public on a fee basis. An up-to-date list of such public test facilities is available on the Internet on the FCC Website at [WWW.FCC.GOV](http://WWW.FCC.GOV), Electronic Filing, OET Equipment Authorization Electronic Filing.

Sincerely,

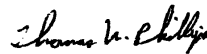

Thomas W Phillips  
Electronics Engineer

**FEDERAL COMMUNICATIONS COMMISSION**

7435 Oakland Mills Road  
Columbia, MD 21046  
Telephone: 301-725-1585 (ext-218)  
Facsimile: 301-344-2050

April 20, 1998

IN REPLY REFER TO  
31040/SIT  
1300F2

C&C Laboratory Co., Ltd.  
1st Fl., No. 344, Fu Ching Street  
Taipei, Taiwan

Attention: Charles Wang

Re: Measurement facility located at Taoyuan, Site No. 3  
(3 and 10 meter site)

Gentlemen:

Your submission of the description of the subject measurement facility has been reviewed and found to be in compliance with the requirements of Section 2.948 of the FCC Rules. The description has, therefore, been placed on file and the name of your organization added to the Commission's list of facilities whose measurement data will be accepted in conjunction with applications for certification or notification under Parts 15 or 18 of the Commission's Rules. Our list will also indicate that the facility complies with the radiated and AC line conducted test site criteria in ANSI C63.4-1992. Please note that this filing must be updated for any changes made to the facility, and at least every three years the data on file must be certified as current.

Per your request, the above mentioned facility has been also added to our list of those who perform these measurement services for the public on a fee basis. This list is updated monthly and is available on the Laboratory's Public Access Link (PAL) at 301-725-1072, and also on the Internet at the FCC Website [www.fcc.gov/oet/info/database/testsite/](http://www.fcc.gov/oet/info/database/testsite/).

Sincerely,



Thomas W. Phillips  
Electronics Engineer  
Customer Service Branch

**FEDERAL COMMUNICATIONS COMMISSION**

7435 Oakland Mills Road  
Columbia, MD 21046  
Telephone: 301-725-1585 (ext-218)  
Facsimile: 301-344-2050

March 13, 1998

IN REPLY REFER TO  
31040/SIT  
1300F2

C & C Laboratory Co., Ltd.  
1st Fl., No. 344, Fu Ching Street  
Taipei, Taiwan

Attention: Ceres Lin

Re: Measurement facility located at Taoyuan  
(3 and 10 meter site)

Gentlemen:

Your submission of the description of the subject measurement facility has been reviewed and found to be in compliance with the requirements of Section 2.948 of the FCC Rules. The description has, therefore, been placed on file and the name of your organization added to the Commission's list of facilities whose measurement data will be accepted in conjunction with applications for certification or notification under Parts 15 or 18 of the Commission's Rules. Our list will also indicate that the facility complies with the radiated and AC line conducted test site criteria in ANSI C63.4-1992. Please note that this filing must be updated for any changes made to the facility, and at least every three years the data on file must be certified as current.

Per your request, the above mentioned facility has been also added to our list of those who perform these measurement services for the public on a fee basis. This list is updated monthly and is available on the Laboratory's Public Access Link (PAL) at 301-725-1072, and also on the Internet at the FCC Website [www.fcc.gov/oet/info/database/testsite/](http://www.fcc.gov/oet/info/database/testsite/).

Sincerely,



Thomas W. Phillips  
Electronics Engineer  
Customer Service Branch



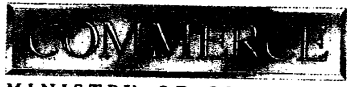

MINISTRY OF COMMERCE  
Te Manatū Tauhokohoko

ENG 3/9  
AJD

22 January 1998

C & C Laboratory Co Ltd  
1<sup>st</sup> Fl  
No. 344  
Fu Ching Street  
Taipei  
TAIWAN ROC

Attention: Mr Tony Houng

Dear Sir

**LABORATORY APPROVAL**

Thank you for your submission of 21 January regarding the approval of your testing laboratory to the Ministry of Commerce's laboratory approval criteria. Thank you for your interest in this matter.

I am pleased to advise that your submission has been successful and your laboratory has been added to the list of Ministry-approved laboratories. Your approved status is valid until 31 December 1998. At this time, the Approved Laboratory scheme will cease operation with the implementation of the new radiocommunications regulations. Test reports from your laboratory will be accepted under the new framework. Please find enclosed a copy of the Ministry's discussion paper, DP10, outlining the proposed compliance process from 1 January 1999.

If you have any further questions on this matter please do not hesitate to contact me.

Yours faithfully

---

Andrew Dyke  
Senior Technical Officer(Regulatory)



## World-wide Testing and Certification

ELA 4

### EMC Laboratory Authorisation

Aut. No. : ELA 160

EMC Laboratory: C & C Laboratory Co., Ltd.  
No. 15, 14 Lin, Chin Twu Chi, Lu Chu Hsiang,  
Taoyuan 338, Taiwan R.O.C.

Scope of Authorization: EN 60601-1-2 and IEC 60601-1-2, the Collateral Standards for electromedical products, with particular application to EMC requirements only.

This Authorisation Document confirms that the above mentioned EMC Laboratory has been validated against EN 45001 and found to be compliant. The laboratory also fulfils the conditions described in Nemko Document ELA 10. During Nemko's visit to the laboratory on 14 and 15 May, 1999, an assessment was made of the relevant parts of your organisation - i.e. facilities, personnel qualifications, test equipment, and testing practices. It was found that the EMC Laboratory is capable of performing tests within the Scope of Authorisation listed above. Accordingly, Nemko will accept your test reports as a basis for attesting conformity to these EMC Standards for the products in question under either the European Union Medical Device Directive [MDD], 93/42/EEC, or the European Union Active Implantable Medical Device Directive [AIMD], 90/385/EEC, (as applicable).

In case of applications for Product Certification(s) to be issued by Nemko, your EMC Laboratory's test report(s) will be accepted by Nemko if they are enclosed with the Application Form submitted by the manufacturer.

In order to maintain the Authorisation, the information given in the enclosed ELA-INFOs (if any) must be carefully followed. Nemko is to be promptly notified about any changes in the situation at your EMC Laboratory which may affect the basis for this Authorisation. The Authorisation may at any time be withdrawn if the conditions are no longer considered to be fulfilled.

The Authorisation is valid through 30 September, 2000.

Oslo, 29 September 1999

For Nemko AS:

Kjell Bergh, Nemko Group EMC Co-ordinator

Postal address:  
P.O. Box 73 Blindern

Telephone: +47 22 96 83 30  
Fax: +47 22 96 85 50



## World-wide Testing and Certification

ELA 4

### EMC Laboratory Authorisation

Aut. No. : ELA 124

**EMC Laboratory:** C & C Laboratory Co., Ltd.  
No. 15, 14 Lin, Chin Twu Chi, Lu Chu Hsiang,  
Taoyuan 338, Taiwan R.O.C.

**Scope of Authorization:** All CENELEC standards [ENs] for EMC that are listed on the accompanying page, and, all of the corresponding CISPR, IEC, and ISO EMC standards that are listed on the accompanying page.

This Authorisation Document confirms that the above mentioned EMC Laboratory has been validated against EN 45001 and found to be compliant. The laboratory also fulfils the conditions described in Nemko Document ELA 10. During Nemko's visit to the laboratory on 14 and 15 May, 1999, an assessment was made of the relevant parts of your organisation - i.e. facilities, personnel qualifications, test equipment, and testing practices. It was found that the EMC Laboratory is capable of performing tests within the Scope of Authorisation given on the accompanying page. Accordingly, Nemko will accept your test reports as a basis for attesting conformity to these EMC Standards for the products in question under the European Union EMC Directive [89/336/EEC as amended by 92/31/EEC and 98/13/EC].

In case of applications for Product Certification(s) to be issued by Nemko, your EMC Laboratory's test report(s) will be accepted by Nemko if they are enclosed with the Application Form submitted by the manufacturer.

In order to maintain this Authorization, the information given in the enclosed ELA-INFOs (if any) must be carefully followed. Nemko is to be promptly notified about any changes in the situation at your EMC Laboratory which may affect the basis for this Authorization. The Authorization may at any time be withdrawn if the conditions are no longer considered to be fulfilled.

The Authorisation is valid through 30 September, 2000.

Oslo, 29 September 1999

For Nemko AS:

  
Kjell Bergh, Nemko Group EMC Co-ordinator

Postal address:  
P.O.Box 73 Blindern  
N-0314 OSLO, NORWAY

Telephone: +47 22 96 03 36  
Fax: +47 22 96 05 50



**EMC Laboratory Authorisation**

Aut. No. : ELA 124

(Page 2 of 2)

**SCOPE OF AUTHORIZATION**

**GENERIC & PRODUCT-FAMILY STANDARDS**

EN 50081-1(1992)	EN 50081-2(1994)	EN 50082-1(1992), EN 50082-1(1997)
EN 50082-2(1995)	EN 50091-2(1995)	EN 50130-4(1995)
CISPR 11(1990), CISPR 11(1997), EN 55011(1991), EN 55011(1998)	CISPR 13(1975)+ A1(1983) EN55013(1990)+A12(1994) + A13(1996)	CISPR 14(1993) + A1(1993) + Corrigendum(1996) [Excluding Clause 4.2] EN 55014-1(1993) + A1(1997) [Excluding Clause 4.2]
CISPR 14-2(1997), EN 55014-2(1997) EN 55104(1995)	CISPR 15(1992), CISPR 15(1996) +A1(1997), EN 55015(1996) + A1(1997)	CISPR 24(1997), EN 55024(1998)
CISPR 22(1993) +A1(1995) +A2(1997), EN 55022(1994) + A1(195) + A2(1997) CISPR 22(1997) [Excluding Clause 9.5] EN 55022(1998) [Excluding Clause 9.5]	EN 60555-2(1987), EN 61000-3-2(1995)+A1(1998) + A2 (1998)	EN 60555-3(1987) + A1(1991), EN 61000-3-3(1995)
IEC 61326-1(1997), EN 61326-1(1997)		

**BASIC STANDARDS**

IEC 801-2(1984), IEC 61000-4-2(1991) IEC/EN 61000-4-2(1995)	IEC 801-3(1984), IEC/EN 61000-4-3(1995) ENV 50204(1995)	IEC 801.4(1988), IEC/EN 61000-4-4(1995)
IEC/EN 61000-4-5(1995) [Including Corrigendum]	IEC/EN 61000-4-6(1996)	IEC/EN 61000-4-8(1993/94)
IEC/EN 61000-4-11(1994)		

Oslo, 29 September 1999

Kjell Bergh, Nemko Group EMC Co-ordinator

Postal address:  
P.O.Box 73 Blindern  
N-0314 OSLO, NORWAY

Telephone: +47 22 96 83 30  
Fax: +47 22 96 85 50



Technischer Überwachungs-Verein Rheinland

# Certificate

of

# Appointment

No. I 9964142-9906

The applicant:

**C & C Laboratory Co., Ltd.**

**No. 15, 14 Lin, Chin twu Chi, Lu Chu Hsiang, Taoyuan, Taiwan, R.O.C.**

has been authorized to carry out EMC tests by order and under supervision of  
TÜV Rheinland according to

EN 55 011:1991, EN 55 014-1:1993/A1, EN 55 022:1994/A1, EN 55 014-2:1997,  
EN 60 555-2:1987, EN 61 000-3-2:1995, EN 61 000-3-3:1995  
EN 50 081-1:1992, EN 50 082-1:1992, EN 50 082-1:1997, EN 50 081-2:1993  
EN 50 082-2:1995, IEC 801-2:1984, IEC 801-2:1991, IEC 801-3:1984  
IEC 801-4:1988, IEC 801-5:1990, EN 61 000-4-2:1995, ENV 50 140:1993, ENV 50 141:1993  
ENV 50 204:1995, EN 61 000-4-3:1996, EN 61 000-4-4:1995, EN 61 000-4-5:1995  
EN 61 000-4-6:1995, EN 61 000-4-8:1993, EN 61 000-4-11:1994

An inspection of the facility was conducted according to the Document  
"Approval of Test Site" with reference to EN 45 001 by a TÜV Rheinland inspector.

Audit Report No. P 9964142E01, Rev.-

This certificate is valid until the next scheduled inspection or up to 15 month,  
at the discretion of TÜV Rheinland.

TÜV Rheinland Taiwan Ltd.  
Taipei, 24. June 1999

Dipl.-Ing. A. Klinker

Dipl.-Ing. R. Charton  
Auditor



中華民國經濟部標準檢驗局

臺北市濟南路一段四號

BUREAU OF STANDARDS, METROLOGY AND INSPECTION

MINISTRY OF ECONOMIC AFFAIRS, REPUBLIC OF CHINA

4, SEC. 1, CHINAN ROAD, TAIPEI, TAIWAN, R. O. C.

Tel: 886-2-23431700 FAX: 886-2-23932324

To: C&C Laboratory Co., Ltd

IN REPLY REFER TO  
87-2-01386

1 Fl.No.344,Fu Ching St., Taipei, Taiwan

This Designation Document confirms that your subject measurement facility has been validated according to the ISO/IEC Guide 25-1990 and found to be in compliance with the requirements of "Operation Guidelines of the Approval and Management of Designated EMC Laboratories."

The description of your facility has, therefore, been placed on file and the name of your organization added to the Bureau's list of facilities whose measurement data and test reports will be accepted as a basis for attesting conformity to CNS13438-1994 / CISPR22-1993, CNS13783-1-1996/ CISPR14 - 1993, CNS13439-1997 / CISPR13-1990 for Information Technology Equipment · household appliances/tools · broadcast receivers and related equipments.

It is located at: <http://www>

Please reference the file numbers below in the body of all reports containing measurements made on the corresponding facility.

For your EMI Testing Lab, use reference "SL2-IN-E-001, SL2-A1-E-0014, SL2-R1-E-0014, SL2-R2-E-0014"

Note that this filing must be updated for any changes in your documentation and / or facility and whenever major changes to your documentation or major construction or repairs to your facility are completed, re-submission of the related information or the site attenuation characteristics will be required within 2 weeks.

The Designation is valid through January 16, 2001.

Taipei, October 5, 1999  
For BSMI, MOEA

Chen Tso-Chen



# CERTIFICATE

**Company : C&C Laboratory Co., Ltd.**

**Facility : C&C Open Area Test Site No.1**

**( Conducted Interference Measurement )**

**Address : No.15, 14 Lin, Chin Twu Chi,**

**Lu Chu Hsiang Taoyuan Shien, Taiwan**

*This is to certify that the following measuring facility  
has been registered in accordance with the Regulations  
for Voluntary Control Measures*

**Registration No. : C-402**

**Date of Registration : July 1, 1999**

**This Certificate is valid until September 30, 2002**

*Voluntary Control Council for Interference by  
Information Technology Equipment*

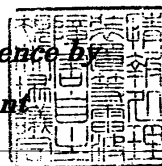



# CERTIFICATE

**Company : C&C Laboratory Co., Ltd.**

**Facility : C&C Open Area Test Site No.1  
( Radiation 3 and 10 meter site )**

**Address : No.15, 14 Lin, Chin Twu Chi,  
Lu Chu Hsiang Taoyuan Shien, Taiwan**

*This is to certify that the following measuring facility  
has been registered in accordance with the Regulations  
for Voluntary Control Measures*

**Registration No. : R-393**

**Date of Registration : July 1, 1999**

**This Certificate is valid until September 30, 2002**

*Voluntary Control Council for Interference by  
Information Technology Equipment*

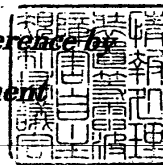





# CERTIFICATE

**Company : C&C Laboratory Co., Ltd.**

**Facility : C&C Open Area Test Site No.2**

**( Radiation 3 and 10 meter site )**

**Location of Facility : No.15, 14 Lin, Chin Twu Chi, Lu Chu**

**Hsiang Taoyuan Shien**

*This is to certify that the following measuring facility  
has been registered in accordance with the Regulations  
for Voluntary Control Measures*

**Registration No. : R-1066**

**Date of Registration : March 6, 2000**

**This Certificate is valid until March 31, 2003**

***Voluntary Control Council for Interference by  
Information Technology Equipment***

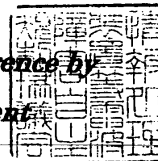



# CERTIFICATE

**Facility : C&C Conducted Interference Test Site No.3  
( Conducted Interference Measurement )**

**Company : C&C Laboratory Co., Ltd.**

**Address : No.15, 14Lin, Chin Twu Chi, La Chu Hsiang Taoyuan Shien**

*This is to certify that the following measuring facility  
has been registered in accordance with the Regulations  
for Voluntary Control Measures.*

**Registration No. : C-747**

**Date of Registration : May 1, 1998**

**This Certificate is valid until June 30, 2001**

***Voluntary Control Council for Interference  
Information Technology Equipment***

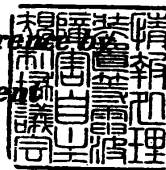



# CERTIFICATE

**Facility : C&C Open Area Test Site No.3**

**( Radiation 3 and 10 meter site )**

**Company : C&C Laboratory Co., Ltd.**

**Address : No.15, 14Lin, Chin Twu Chi, Lu Chu Hsiang Taoyuan Shien**

*This is to certify that the following measuring facility  
has been registered in accordance with the Regulations  
for Voluntary Control Measures.*

**Registration No. : R-725**

**Date of Registration : May 1, 1998**

**This Certificate is valid until June 30, 2001**

**Voluntary Control Council for Interference  
Information Technology Equipment**





# CERTIFICATE

**Company : C&C Laboratory Co., Ltd.**

**Facility : C&C Conducted Interference Test Site No.4  
( Conducted Interference Measurement )**

**Address : No.15, 14 Lin, Chin Twn Chi, Lu Chu Hsiang Taoyuan Shien, Taiwan**

*This is to certify that the following measuring facility  
has been registered in accordance with the Regulations  
for Voluntary Control Measures*

**Registration No. : C-912**

**Date of Registration : March 26, 1999**

**This Certificate is valid until March 31, 2002**

***Voluntary Control Council for Interference  
Information Technology Equipment***

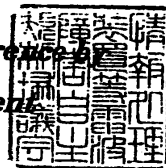



# CERTIFICATE

**Company : C&C Laboratory Co., Ltd.**

**Facility : C&C Open Area Test Site No.4**

**( Radiation 3 and 10 meter site )**

**Address : No.15, 14 Lin, Chin Twu Chi, Lu Chu Hsiang Taoyuan Shien, Taiwan**

*This is to certify that the following measuring facility  
has been registered in accordance with the Regulations  
for Voluntary Control Measures*

**Registration No. : R-879**

**Date of Registration : March 26, 1999**

**This Certificate is valid until March 31, 2002**

*Voluntary Control Council for Interference by  
Information Technology Equipment*

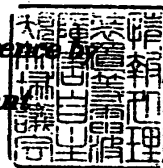



**中華民國實驗室認證體系認可證書**  
**Chinese National Laboratory Accreditation Certificate ROC**

No. CNLA-ZL98078

Page 1 of 4

茲以 程智科技股份有限公司程智科技電磁相容實驗室之電性測試領域經評鑑認可  
 十項發給本證書有效期至九十年十一月十四日 此證

This is to certify that C & C Laboratory Co., Ltd. has been recognized by the Council of Chinese National Laboratory Accreditation as an accredited laboratory. The laboratory has been registered for ten specific tests within the field of Electrical Testing. The details of the scope of accreditation is described in the following pages and this Certificate is valid until Nov. 14, 2001.

中華民國實驗室認證委員會  
 主任委員

Chen, Ming-Bang

The Chairman of Chinese National Laboratory Accreditation Council

中華民國 八十七年十一月十五日  
 (本證書共 4 頁分牌使用無效 This document is invalid unless accompanied by all 4 pages.)



機構名稱 : 程普科技股份有限公司  
 實驗室名稱 : 程普科技電磁相容實驗室  
 認可編號 : 0363  
 實驗室負責人 : 王曉濤  
 測試領域 : 電性測試  
 發證日期 : 1998.11.15

Organization : C & C Laboratory Co., Ltd.  
 Laboratory : C & C Laboratory Co., Ltd.  
 Registration : 0363  
 Laboratory Head : WANG, Xiaotao  
 Testing Field : Electrical Testing  
 Date of Registration: 1998.11.15

認可項目 Registration items	測試件 Test items	測試方法 Test methods	範圍 Range	認可之最佳測試能力 Best test capability recognized	備註 Remarks
E10102 諧波電流干擾 Harmonic current emissions	資訊類及其週邊產品 ITE and peripheral Products	IEC 1000-3-2(1995) EN 61000-3-2(1995)	測試件電壓: 100~270VAC(單相) 測試件電流: 0~16 測試件功率: 1~40		
E10103 電壓波動與閃爍干擾 Voltage fluctuations and flicker	資訊類及其週邊產品 ITE and peripheral Products	IEC 1000-3-3(1994) EN 61000-3-3(1995)	件電壓: 100~270VAC(單相) 電流: 16 A		
E10122 電磁及資訊技術系統及儀器 Systems and apparatus of the telecommunication and	資訊類及其週邊產品 ITE and peripheral Products	CISPR 22(1996) EN 55022(1995) CNS 13438(1997) AS/NZS 3548(1995) VCCI(1997) FCC Part 15(1996)	傳導干擾: 150 kHz~30 MHz 輻射干擾: 30 MHz~1.0 GHz		
			傳導干擾: 450 kHz~30 MHz 輻射干擾: 30 MHz~2.0 GHz		



認可項目 Registration items	測試件 Test items	測試方法 Test methods	範圍 Range	認可之最佳測試能力 Best test capability recognized	備註 Remarks
測試 Power frequency magnetic field immunity test E10211 電壓下降、瞬斷和電壓前受測試 Voltage dips, short interruptions and voltage variations immunity tests (以下空白)	Products 資訊類及其週邊產品 ITE and peripheral Products	IEC 1000-4-11(1984) EN 61000-4-11(1984)	電壓瞬斷: 100% 電壓下降: 0~100% 瞬斷: 標準瞬斷波形		







認可項目 Registration items	測試件 Test items	測試方法 Test methods	範圍 Range	認可之最佳測試能力 Best test capability recognized	備註 Remarks
information technology EJ0202 靜電放電測試 Electrostatic discharge tests	資訊類及其週邊產品 ITE and peripheral Products	IEC 1000-4-2(1995) BS 6898-4-2(1995) CNS 13022-1(1992)	空間放電: 0.2 kV~16.5 kV(+/-) 接觸放電:0.2 kV~9.0 kV(+/-)		
EJ0203 輻射耐受測試 Radiated susceptibility tests	資訊類及其週邊產品 ITE and peripheral Products	IEC 801-3(1984) IEC 1000-4-3(1995) EN 61000-4-3(1996) EN 50204(1995)	電磁場:26MHz~1.0 GHz 電場:10 V/m,AM(調變) 電流:900mA±5Hz 200 Hz脈波電流:100~200 A ZAC(脈波) 電壓:0~100V 電流:0~100A 電磁干擾:0.2~4.5 kV		
EJ0204 電性快速突波測試 Electrical fast transient/burst tests	資訊類及其週邊產品 ITE and peripheral Products	IEC 809-4(1998) IEC 1000-4-4(1995) EN 61000-4-4(1995) CNS 13022-2(1992)	電壓:100~270 V 電流:100V CC(脈波)/DC 100V 脈波電流:16 A(AC/DC) 脈波電壓:0~4.2 kV		
EJ0205 突波/雷擊測試 Surge/lightening tests	資訊類及其週邊產品 ITE and peripheral Products	IEC 1000-4-5(1995) EN 5014X(1994) CNS 13022-3(1992)	電壓:150 Hz~230 MHz (脈波:10 V,AM(調變))		
EJ0206 傳導耐受測試 Conducted susceptibility tests	資訊類及其週邊產品 ITE and peripheral Products	IEC 1000-4-6(1993) EN 61000-4-6(1996)	電磁場 1 A/m~100 A/m		
EJ0208 電源線雜訊耐受	資訊類及其週邊產品 ITE and peripheral Products	IEC 1000-4-7(1993) EN 61000-4-7(1993)			

14



## TEST EQUIPMENT LIST

**Instrumentation:** The following list contains equipment used at C & C Laboratory, Co., Ltd. for testing. The equipment conforms to the CISPR 16-1 / ANSI C63.2-1988 Specifications for Electromagnetic Interference and Field Strength Instrumentation from 10kHz to 1.0 / 5.0 GHz.

**Equipment used during the tests:**

Open Area Test Site:  # 1 ;  # 2 ;  # 3 ;  # 4

Open Area Test Site # 1					
EQUIPMENT TYPE	MFR	MODEL NUMBER	SERIAL NUMBER	LAST CAL.	CAL. DUE
Q.P Adaptor	HP	85650A	2811A01399	05/05/2000	05/04/2001
RF Pre-selector	HP	85685A	2947A01064	05/05/2000	05/04/2001
Spectrum Analyzer	HP	8568B	3001A05004	05/05/2000	05/04/2001
S.P.A Display	HP	8568B	3014A18846	05/05/2000	05/04/2001
Precision Dipole	R&S	HZ-12	846932/0004	07/14/2000	07/13/2001
Precision Dipole	R&S	HZ-13	846556/0008	07/14/2000	07/13/2001
Bilog Antenna	CHASE	CBL6112A	2309	02/13/2000	02/12/2001
Turn Table	EMCO	2081-1.21	N/A	N.C.R	N.C.R
Antenna Tower	EMCO	2075-2	9707-2604	N.C.R	N.C.R
Controller	EMCO	2090	N/A	N.C.R	N.C.R
RF Switch	ANRITSU	MP59B	M54367	N.C.R	N.C.R
Site NSA	C&C	N/A	N/A	11/10/1999	11/09/2000

Open Area Test Site # 2					
EQUIPMENT TYPE	MFR	MODEL NUMBER	SERIAL NUMBER	LAST CAL.	CAL. DUE
Spectrum Analyzer	ADVANTEST	R3261C	81720301	09/02/1999	09/01/2000
Pre-Amplifier	HP	8447D	2944A08432	11/16/1999	11/15/2000
EMI Test Receiver	R&S	ESVS10	834468/006	03/24/2000	03/23/2001
Precision Dipole	R&S	HZ-12	846932/0004	07/14/2000	07/13/2001
Precision Dipole	R&S	HZ-13	846556/0008	07/14/2000	07/13/2001
Bilog Antenna	CHASE	CBL 6112A	SITE2	12/10/1999	12/09/2000
Turn Table	Chance Most	CM-T003-1	T807-6	N.C.R	N.C.R
Antenna Tower	Chance Most	CM-A003-1	A807-6	N.C.R	N.C.R
Controller	Chance Most	N/A	N/A	N.C.R	N.C.R
RF Switch	ANRITSU	MP59B	M76890	N.C.R	N.C.R
Site NSA	C&C Lab.	N/A	N/A	11/13/1999	11/12/2000



Open Area Test Site # 3					
EQUIPMENT TYPE	MFR	MODEL NUMBER	SERIAL NUMBER	LAST CAL.	CAL. DUE
Spectrum Analyzer	ADVANTEST	R3261C	71720533	10/25/1999	10/24/2000
Pre-Amplifier	HP	8447D	2944A09173	02/01/2000	01/31/2001
EMI Test Receiver	R&S	ESVS20	838804/004	12/24/1999	12/23/2000
Precision Dipole	R&S	HZ-12	846932/0004	07/14/2000	07/13/2001
Precision Dipole	R&S	HZ-13	846556/0008	07/14/2000	07/13/2001
Bilog Antenna	CHASE	CBL6112A	2179	11/27/1999	11/26/2000
Turn Table	EMCO	2081-1.21	9709-1885	N.C.R	N.C.R
Antenna Tower	EMCO	2075-2	9707-2060	N.C.R	N.C.R
Controller	EMCO	2090	9709-1256	N.C.R	N.C.R
RF Switch	ANRITSU	MP59B	M53867	N.C.R	N.C.R
Site NSA	C&C	N/A	N/A	01/30/2000	01/29/2001

Open Area Test Site # 4					
EQUIPMENT TYPE	MFR	MODEL NUMBER	SERIAL NUMBER	LAST CAL.	CAL. DUE
Spectrum Analyzer	ADVANTEST	R3132	91700456	02/15/2000	02/14/2001
Pre-Amplifier	HP	8447F	2944A03748	10/22/1999	10/21/2000
EMI Test Receiver	R&S	ESCS30	845552/030	12/04/1999	12/03/2000
Precision Dipole	R&S	HZ-12	846932/0004	07/14/2000	07/13/2001
Precision Dipole	R&S	HZ-13	846556/0008	07/14/2000	07/13/2001
Bilog Antenna	CHASE	CBL 6112B	2462	01/13/2000	01/12/2001
Turn Table	Chance most	N/A	N/A	N.C.R	N.C.R
Antenna Tower	Chance most	N/A	N/A	N.C.R	N.C.R
Controller	Chance most	N/A	N/A	N.C.R	N.C.R
RF Switch	ANRITSU	MP59B	M51067	N.C.R	N.C.R
Site NSA	C&C Lab.	N/A	N/A	12/26/1999	12/25/2000

3 meter chamber					
EQUIPMENT TYPE	MFR	MODEL NUMBER	SERIAL NUMBER	LAST CAL.	CAL. DUE
Spectrum Analyzer	ADVANTEST	R3271A	85060321	01/12/2000	01/11/2001
Pre-Amplifier	HP	8449B	3008A00965	03/03/2000	03/02/2001
Horn Antenna	EMCO	3115	9602-4659	04/06/2000	04/05/2001
Coaxial Cable	ANOREW	LDF-2-50	79027	04/17/2000	04/16/2001
Turn Table	HD	DS 415	N/A	N.C.R	N.C.R
Antenna Tower	HD	MA 240	N/A	N.C.R	N.C.R
Controller	HD	HD 100	N/A	N.C.R	N.C.R



Conducted Emission Test Site: # 4

Conducted Emission Test Site # 4					
EQUIPMENT TYPE	MFR	MODEL NUMBER	SERIAL NUMBER	LAST CAL.	CAL. DUE
EMI Test Receiver	R&S	ESHS10	843743/015	12/10/1999	12/09/2000
LISN	EMCO	3825/2	9003/1382	01/10/2000	01/09/2001
LISN	R&S	ESH2-Z5	843250/010	12/06/1999	12/05/2000

The calibrations of the measuring instruments, including any accessories that may effect such calibration, are checked frequently to assure their accuracy. Adjustments are made and correction factors applied in accordance with instructions contained in the manual for the measuring instrument.



### BLOCK DIAGRAM OF TEST SETUP SYSTEM DIAGRAM OF CONNECTIONS BETWEEN EUT AND SIMULATORS

**EUT:** Panel PC (IPC)  
**Trade Name:** N/A  
**Model Number:** G3000  
**Power Cord:** Unshielded, 1.8m

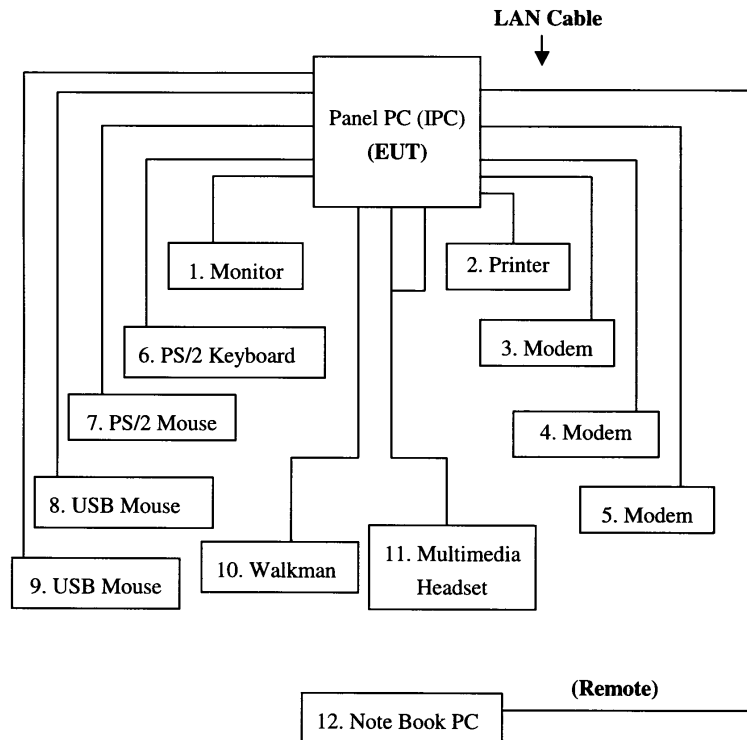

*Report Number: 000560-F*  
*August 16, 2000*



## **APPENDIX 1**

### **PHOTOGRAPHS (TEST SETUP OF LINE CONDUCTED EMISSION TEST)**

Accredited Lab. of NEMKO, A2LA, BSMI  
Listed Lab. of FCC, VCCI, MOC

A2LA Certificate #: 824.01 (for Emission)  
NEMKO Authorization #: ELA 124 (for EMC)

Page22

Rev. 00



## LINE CONDUCTED EMISSION TEST

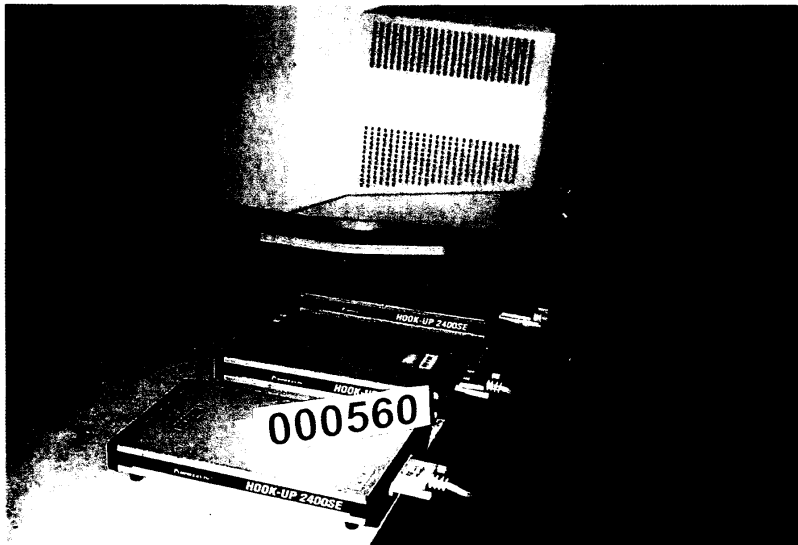
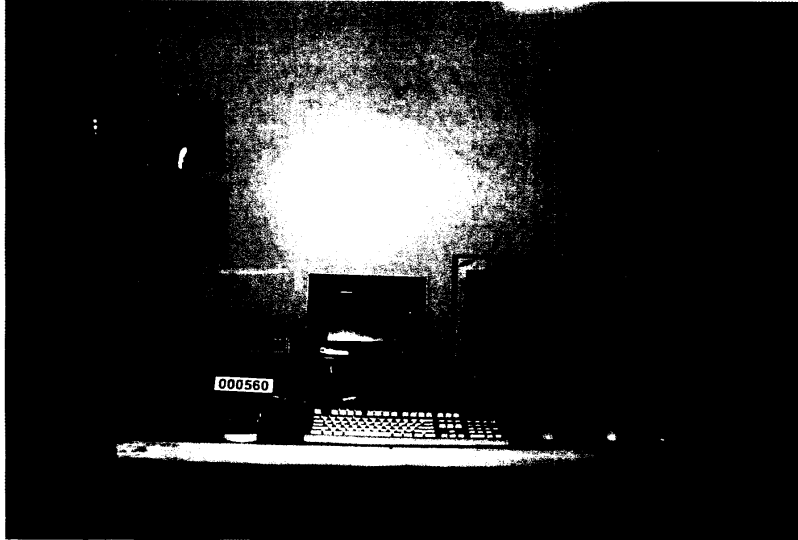

*Report Number: 000560-F*  
*August 16, 2000*



## **APPENDIX 2**

### **PHOTOGRAPHS (TEST SETUP OF RADIATED EMISSION TEST)**





### TEST SETUP OF RADIATED EMISSION TEST

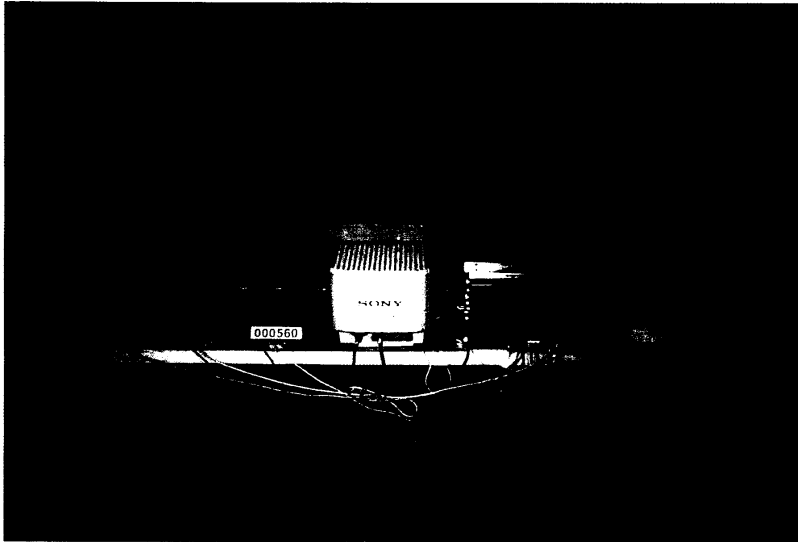
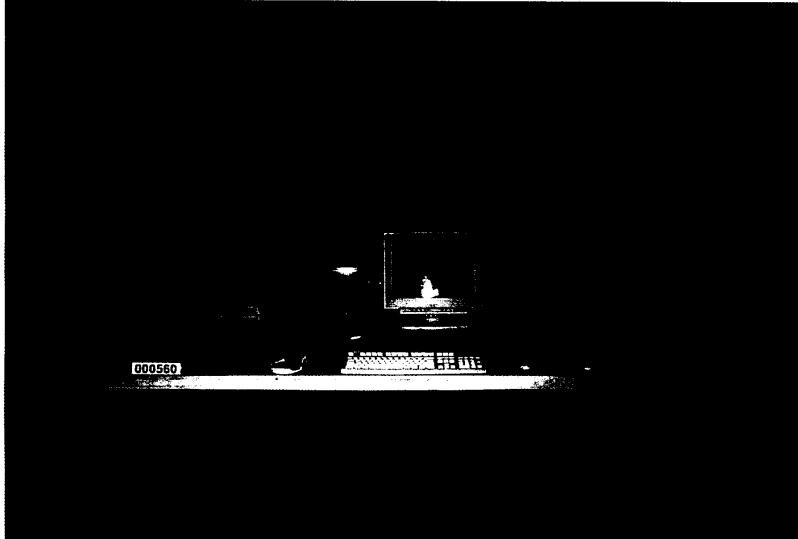

*Report Number: 000560-F*  
*August 16, 2000*



## **APPENDIX 3**

### **PHOTOGRAPHS OF EUT**

Accredited Lab. of NEMKO, A2LA, BSMI  
Listed Lab. of FCC, VCCI, MOC

A2LA Certificate #: 824.01 (for Emission)  
NEMKO Authorization #: ELA 124 (for EMC)

Page26

Rev. 00

