



# FCC 47 CFR PART 15 SUBPART B TEST REPORT

for

**COM Express CPU Module**

**MODEL: xxxxx-COM-TC-xxxxxx (Where x is 0-9, A-Z, -or blank) for marketing purpose**

Test Report Number:  
T11111202-F

Issued to:

**AAEON Technology Inc.**

**5F, No.135, Lane 235, Pao Chiao Rd, Hsin-Tien Dist.,  
New Taipei City, Taiwan, R.O.C.**

Issued by:

**Compliance Certification Services Inc.**

**Sindian Lab.**

**No.163-1, Jhongsheng Rd, Sindian City,  
Taipei County 23151, Taiwan (R.O.C.)**

**TEL: 886-2-22170894**

**FAX: 886-2-22171029**

**Issued Date: November 21, 2011**



**Note:** This report shall not be reproduced except in full, without the written approval of Compliance Certification Services Inc. This document may be altered or revised by Compliance Certification Services Inc. personnel only, and shall be noted in the revision section of the document. The client should not use it to claim product endorsement by TAF, A2LA, NIST or any government agencies. The test results in the report only apply to the tested sample.



**Revision History**

Rev.	Issue Date	Revisions	Effect Page	Revised By
00	November 21, 2011	Initial Issue	ALL	Wendy Wang



**TABLE OF CONTENTS**

**1 TEST RESULT CERTIFICATION ..... 4**

**2 EUT DESCRIPTION..... 5**

**3 TEST METHODOLOGY..... 6**

    3.1. DECISION OF FINAL TEST MODE ..... 6

    3.2. EUT SYSTEM OPERATION ..... 6

**4 SETUP OF EQUIPMENT UNDER TEST ..... 7**

    4.1. DESCRIPTION OF SUPPORT UNITS..... 7

    4.2. CONFIGURATION OF SYSTEM UNDER TEST..... 8

**5 FACILITIES AND ACCREDITATIONS ..... 9**

    5.1. FACILITIES..... 9

    5.2. ACCREDITATIONS..... 9

    5.3. MEASUREMENT UNCERTAINTY ..... 9

**6 CONDUCTED EMISSION MEASUREMENT ..... 10**

    6.1. LIMITS OF CONDUCTED EMISSION MEASUREMENT..... 10

    6.2. TEST INSTRUMENTS ..... 10

    6.3. TEST PROCEDURES..... 11

    6.4. TEST SETUP ..... 12

    6.5. DATA SAMPLE ..... 12

    6.6. TEST RESULTS ..... 13

**7 RADIATED EMISSION MEASUREMENT ..... 15**

    7.1. LIMITS OF RADIATED EMISSION MEASUREMENT ..... 15

    7.2. TEST INSTRUMENTS ..... 17

    7.3. TEST PROCEDURES..... 18

    7.4. TEST SETUP ..... 19

    7.5. DATA SAMPLE ..... 20

    7.6. TEST RESULTS ..... 21

**8 PHOTOGRAPHS OF THE TEST CONFIGURATION..... 26**

**APPENDIX 1 - PHOTOGRAPHS OF EUT ..... A1-1**



# 1 TEST RESULT CERTIFICATION

**Product:** COM Express CPU Module

**Model:** xxxxx-COM-TC-xxxxxx (Where x is 0-9, A-Z, -or blank) for marketing purpose

**Brand:** AAEON

**Applicant:** **AAEON Technology Inc.**  
5F, No.135, Lane 235, Pao Chiao Rd, Hsin-Tien Dist.,  
New Taipei City, Taiwan, R.O.C.

**Manufacturer:** **AAEON Technology Inc.**  
5F, No.135, Lane 235, Pao Chiao Rd, Hsin-Tien Dist.,  
New Taipei City, Taiwan, R.O.C.

**Tested:** November 11, 2011 ~ November 18, 2011

EMISSION			
Standard	Item	Result	Remarks
FCC 47 CFR Part 15 Subpart B, ICES-003 Issue 4 ANSI C63.4-2009	Conducted (Power Port)	PASS	Meet Class A limit
	Radiated	PASS	Meet Class A limit

- Note:**
1. The statements of test result on the above are decided by the request of test standard only; the measurement uncertainties are not factored into this compliance determination.
  2. The information of measurement uncertainty is available upon the customer's request.

Deviation from Applicable Standard
None

The above equipment has been tested by Compliance Certification Services Inc., and found compliance with the requirements set forth in the technical standards mentioned above. The results of testing in this report apply only to the product/system, which was tested. Other similar equipment will not necessarily produce the same results due to production tolerance and measurement uncertainties.

Approved by:

Reviewed by:

  
 \_\_\_\_\_  
 Sam Hu  
 Section Manager

  
 \_\_\_\_\_  
 Vesta Hsu  
 Supervisor of report document dept.



## 2 EUT DESCRIPTION

<b>Product</b>	COM Express CPU Module
<b>Brand Name</b>	AAEON
<b>Model</b>	xxxxx-COM-TC-xxxxxx (Where x is 0-9, A-Z, -or blank) for marketing purpose
<b>Applicant</b>	AAEON Technology Inc.
<b>Housing material</b>	N/A
<b>Identify Number</b>	T111111202
<b>Received Date</b>	November 11, 2011
<b>EUT Power Rating</b>	12VDC From Carrier Board
<b>AC Power During Test</b>	120VAC / 60Hz to Carrier Board
<b>OSC/Clock Frequencies</b>	14.31818MHz; 25MHz; 32.768kHz

### Model Differences

Model Name	Differences	Tested (Checked)
TF-COM-TC-A10-03	Original	<input checked="" type="checkbox"/>
xxxxx-COM-TC-xxxxxx	1. Where x is 0-9, A-Z, -or blank 2. For marketing purpose	<input type="checkbox"/>

### I/O PORT

I/O PORT TYPES	Q'TY	TESTED WITH
1. SIO Port	2	2
2. PS/2 Keyboard Port	1	1
3. PS/2 Mouse Port	1	1
4. VGA Port	1	1
5. Audio In Port	1	1
6. Microphone Port	1	1
7. Earphone Port	4	4
8. USB Port	4	4
9. LAN Port	2	2

**Note:** Client consigns only one model sample to test (Model Number: TF-COM-TC-A10-03).



### 3 TEST METHODOLOGY

#### 3.1. DECISION OF FINAL TEST MODE

The EUT was tested together with the above additional components, and a configuration, which produced the worst emission levels, was selected and recorded in this report.

The test configuration/ mode is as the following:

**Conduction Mode:**

1	Normal Mode
---	-------------

**Radiation Modes:**

1	Normal Mode
	Normal Mode / Open Chassis
	Normal Mode / 1-8GHz

**Conduction:** Mode 1

**Radiation:** Mode 1

#### 3.2. EUT SYSTEM OPERATION

1. Windows XP boots system.
2. Run Emctest.exe to activate all peripherals and display "H" pattern on monitor screen.
3. Run Winemc.exe and choose media player to play music.
4. Run Winemc.exe then choose "E:/ & F:/ & G:/ & H:/" to test USB 2.0 ports.
5. Run Winemc.exe then choose "com3 " to test EUT.
6. Press the start menu, select executive and type ping 192.168.1.100&200 -t (EUT), ping 192.168.1.111 -t (Server PC).

**Note:** Test program is self-repeating throughout the test.



## 4 SETUP OF EQUIPMENT UNDER TEST

### 4.1. DESCRIPTION OF SUPPORT UNITS

The EUT has been tested as an independent unit together with other necessary accessories or support units. The following support units or accessories were used to form a representative test configuration during the tests.

#### EUT Devices:

No.	Equipment	Model No.	Brand Name
1	CPU (1.6GHz)	ATOM Tunnel Creek E680	Intel
2	Carrier Board	xxxxx-ECB-916M- xxxxxx(Where x is 0-9 , A-Z , - or blank) for marketing purpose	AAEON
3	HDD (160GB)	ST3160815AS	Seagate
4	OnBoard Memory (DDR2 1GB)	N/A	N/A
5	VGA PCI Card	100-0000-164 REV.0.9	Chrontel
6	Power Supply (400W)	ST-400EAG-05F	Seventeam

Note: Client consigns only one model sample to test (Carrier Board Model Number: ECB-916M REV.B0.2).

#### Peripherals Devices:

No.	Equipment	Model No.	Serial No.	FCC ID / BSMI ID	Brand Name	Data Cable	Power Cord
1	PS/2 Mouse	M-SBF96	FATSQ0C5BYJQKZ	DOC BSMI: R41126	hp	Shielded, 1.8m	N/A
2	PS/2 Keyboard	SK-2880	BAUEL0HCPY76G7	DOC BSMI: T3A002	hp	Shielded, 1.8m	N/A
3	Player	RQ-L317	N/A	N/A	PANASONIC	Unshielded, 1.2m	N/A
4	Earphone / Microphone	SBZ-4	N/A	N/A	KRONE	Unshielded, 2.0m	N/A
5-7	Earphone	SBZ-4	N/A	N/A	KRONE	Unshielded, 2.0m	N/A
8-9	Modem	AL-56ERM	N/A	DOC	GALILEO	Shielded, 0.8m	Unshielded, 1.8m
10	Monitor	933SN+	N/A	DOC BSMI: R33475	SAMSUNG	Shielded, 1.8m with two cores	Unshielded, 1.8m
11-14	USB 2.0 HDD	F12-U	N/A	BSMI ID: 4912A002	TeraSys	Shielded, 1.8m	N/A
15	HUB	DGS-1008 D	042829	DOC	D-Link	Unshielded, 20m X2	Unshielded, 1.8m
16	Server PC	HD075AV	SGH948QGVW	DOC BSMI: R33001	HP	Unshielded, 1.0m	Unshielded, 1.8m

#### Note:

- 1) All the equipment/cables were placed in the worst-case configuration to maximize the emission during the test.
- 2) Grounding was established in accordance with the manufacturer's requirements and conditions for the intended use.



## 4.2. CONFIGURATION OF SYSTEM UNDER TEST

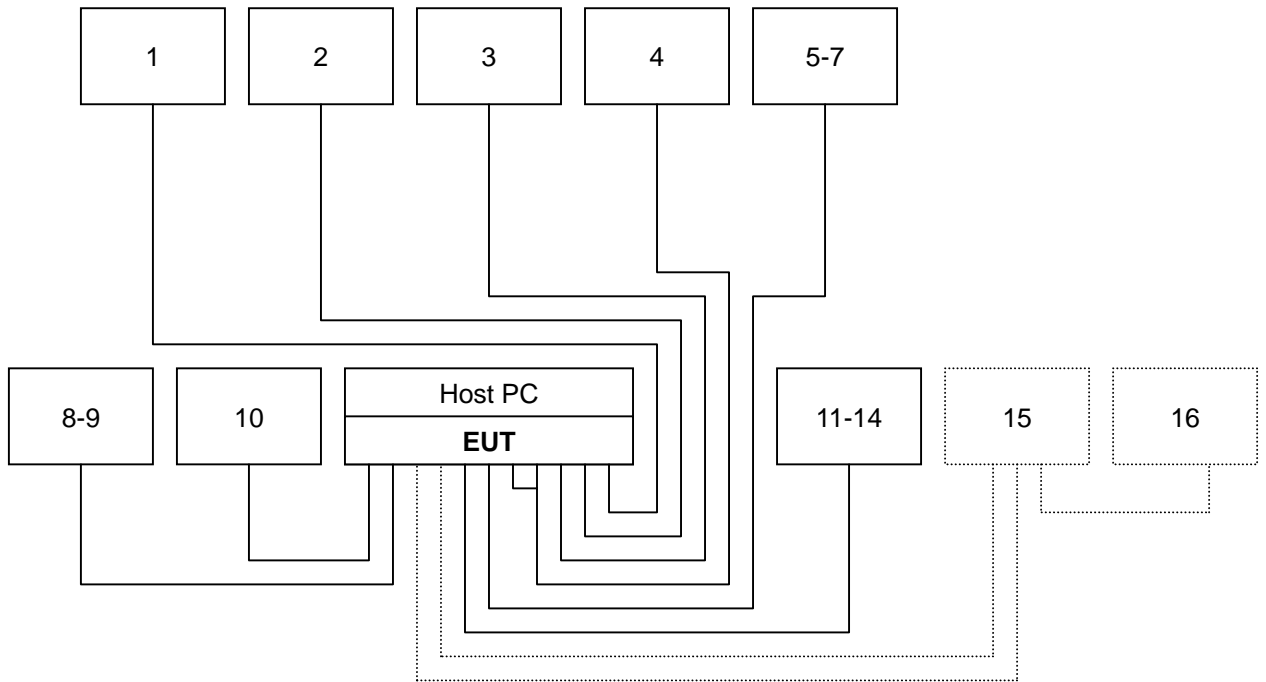





## 5 FACILITIES AND ACCREDITATIONS

### 5.1. FACILITIES

All measurement facilities used to collect the measurement data are located at CCSrf Taiwan Sindian Lab. at No.163-1, Jhongsheng Rd, Sindian City, Taipei County 23151, Taiwan (R.O.C.).

The sites are constructed in conformance with the requirements of ANSI C63.4 and CISPR Publication 22. All receiving equipment conforms to CISPR 16-1-1, CISPR 16-1-2, CISPR 16-1-3, CISPR 16-1-4 and CISPR 16-1-5.

### 5.2. ACCREDITATIONS

Our laboratories are accredited and approved by the following accreditation body according to ISO/IEC 17025.

Taiwan	TAF
USA	A2LA

The measuring facility of laboratories has been authorized or registered by the following approval agencies.

Canada	Industry Canada
Norway	Nemko
Japan	VCCI
Taiwan	BSMI
USA	FCC

Copies of granted accreditation certificates are available for downloading from our web site, <http://www.ccsrf.com>

### 5.3. MEASUREMENT UNCERTAINTY

Where relevant, the following measurement uncertainty levels have been estimated for tests performed on the EUT as specified in CISPR 16-4-2:

Measurement	Frequency	Uncertainty
Conducted emissions	0.15MHz ~ 30MHz	± 1.29
Radiated emissions	30MHz ~ 1000MHz	± 3.83
	1000MHz ~ 18000MHz	± 1.99
	18000MHz ~ 26000MHz	± 2.65
	26000MHz ~ 40000MHz	± 2.97

This uncertainty represents an expanded uncertainty expressed at approximately the 95% confidence level using a coverage factor of k=2.

Consistent with industry standard (e.g. CISPR 22: 2005, clause 11, Measurement Uncertainty) determining compliance with the limits shall be base on the results of the compliance measurement. Consequently the measure emissions being less than the maximum allowed emission result in this be a compliant test or passing test.

The acceptable measurement uncertainty value without requiring revision of the compliance statement is base on conducted and radiated emissions being less than  $U_{CISPR}$  which is 3.6dB and 5.2dB respectively. CCS values (called  $U_{Lab}$  in CISPR 16-4-2) is less than  $U_{CISPR}$  as shown in the table above. Therefore, MU need not be considered for compliance.



## 6 CONDUCTED EMISSION MEASUREMENT

### 6.1. LIMITS OF CONDUCTED EMISSION MEASUREMENT

FREQUENCY (MHz)	Class A (dBuV)		Class B (dBuV)	
	Quasi-peak	Average	Quasi-peak	Average
0.15 - 0.5	79	66	66 - 56	56 - 46
0.50 - 5.0	73	60	56	46
5.0 - 30.0	73	60	60	50

- NOTE:** 1. The lower limit shall apply at the transition frequencies.  
 2. The limit decreases in line with the logarithm of the frequency in the range 0.15 to 0.50 MHz.  
 3. All emanations from a class A/B digital device or system, including any network of conductors and apparatus connected thereto, shall not exceed the level of field strengths specified above.

### 6.2. TEST INSTRUMENTS

Conducted Emission room # B				
Name of Equipment	Manufacturer	Model	Serial Number	Calibration Due
TEST RECEIVER	R&S	ESCI	100234	06/13/2012
LISN (EUT)	FCC	FCC-LISN-50-32-2	08009	03/27/2012
LISN	SCHWARZBECK	NSLK 8127	8127382	01/02/2012
BNC CABLE	MIYAZAKI	5D-FB	BNC B3	08/07/2012
Pulse Limiter	R&S	ESH3-Z2	100374	01/09/2012
THERMO-HYGRO METER	WISEWIND	201A	1006	05/23/2012
Test S/W	EZ-EMC			

- NOTE:** 1. The calibration interval of the above test instruments is 12 months and the calibrations are traceable to NML/ROC and NIST/USA.  
 2. N.C.R = No Calibration Request.



### **6.3. TEST PROCEDURES** (please refer to measurement standard or CCS SOP PA-031)

#### **Procedure of Preliminary Test**

- The EUT and support equipment, if needed, were set up as per the test configuration to simulate typical usage per the user's manual. When the EUT is a tabletop system, a wooden table with a height of 0.8 meters is used and is placed on the ground plane as per ANSI C63.4 (see Test Facility for the dimensions of the ground plane used). When the EUT is a floor standing equipment, it is placed on the ground plane, which has a 12 mm non-conductive covering to insulate the EUT from the ground plane.
- All I/O cables were positioned to simulate typical actual usage as per ANSI C63.4.
- The test equipment EUT installed by AC 120VAC/60Hz main power, through a Line Impedance Stabilization Network (LISN), which was supplied power source and was grounded to the ground plane.
- All support equipment power by from a second LISN.
- The test program of the EUT was started. Emissions were measured on each current carrying line of the EUT using an EMI Test Receiver connected to the LISN powering the EUT.
- The Receiver scanned from 150kHz to 30MHz for emissions in each of the test modes.
- During the above scans, the emissions were maximized by cable manipulation.
- The test mode(s) described in Item 3.1 were scanned during the preliminary test.
- After the preliminary scan, we found the test mode described in Item 3.1 producing the highest emission level.
- The worst configuration of EUT and cable of the above highest emission level were recorded for reference of the final test.

#### **Procedure of Final Test**

- EUT and support equipment were set up on the test bench as per the configuration with highest emission level in the preliminary test.
- A scan was taken on both power lines, Line 1 and Line 2, recording at least the six highest emissions. Emission frequency and amplitude were recorded into a computer in which correction factors were used to calculate the emission level and compare reading to the applicable limit.
- The test data of the worst-case condition(s) was recorded.

**6.4. TEST SETUP**



- For the actual test configuration, please refer to the related item - Photographs of the Test Configuration.

**6.5. DATA SAMPLE**

Freq. (MHz)	Reading (dBuV)	Factor (dB)	Result (dBuV)	Limit (dBuV)	Margin (dB)	Detector (P/Q/A)	Line (L1/L2)
x.xx	42.95	0.55	43.50	73	-29.50	Q	L1

- Freq. = Emission frequency in MHz
- Reading = Uncorrected Analyzer/Receiver reading
- Factor = Insertion loss of LISN + Cable Loss
- Result = Reading + Factor
- Limit = Limit stated in standard
- Margin = Reading in reference to limit
- P = Peak Reading
- Q = Quasi-peak Reading
- A = Average Reading
- L1 = Hot side
- L2 = Neutral side

**Calculation Formula**

Margin (dB) = Result (dBuV) – Limit (dBuV)



6.6. TEST RESULTS

<b>Model No.</b>	TF-COM-TC-A10-03	<b>6dB Bandwidth</b>	10 kHz
<b>Environmental Conditions</b>	24°C, 60% RH, 1010mbar	<b>Test Mode</b>	Mode 1
<b>Tested by</b>	Julon Liu	<b>Phase</b>	L1
<b>Standard</b>	FCC CLASS A		

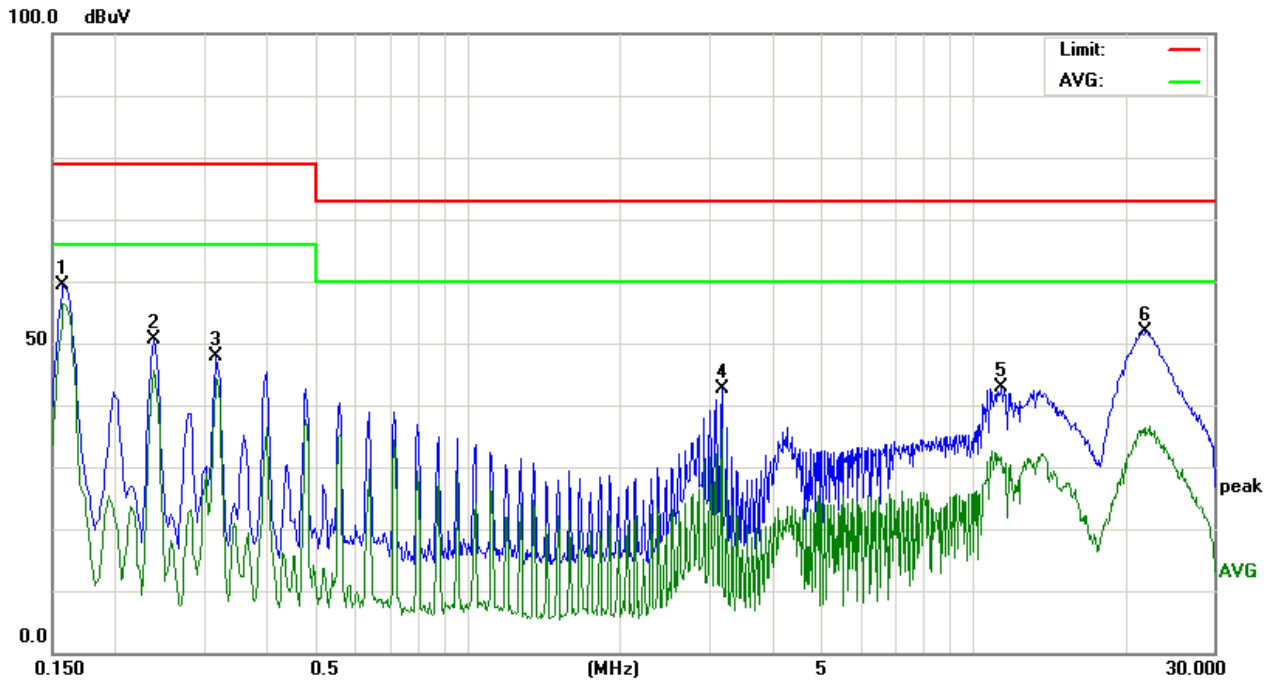

Conducted Emission Readings							
Frequency Range Investigated				150 kHz to 30 MHz			
Freq. (MHz)	Reading (dBuV)	Factor (dB)	Result (dBuV)	Limit (dBuV)	Margin (dB)	Detector (P/Q/A)	Line (L1/L2)
0.1580	49.08	10.24	59.32	79.00	-19.68	P	L1
0.2380	40.51	10.12	50.63	79.00	-28.37	P	L1
0.3180	37.70	10.07	47.77	79.00	-31.23	P	L1
3.1780	32.51	10.04	42.55	73.00	-30.45	P	L1
11.4340	32.79	10.19	42.98	73.00	-30.02	P	L1
22.0300	41.52	10.46	51.98	73.00	-21.02	P	L1

**Note:** 1. L1 = Line One (Live Line) / L2 = Line Two (Neutral Line).  
 2. The emission level was or more than 2dB below the Average limit, so no re-check anymore.



<b>Model No.</b>	TF-COM-TC-A10-03	<b>6dB Bandwidth</b>	10 kHz
<b>Environmental Conditions</b>	24°C, 60% RH, 1010mbar	<b>Test Mode</b>	Mode 1
<b>Tested by</b>	Julon Liu	<b>Phase</b>	L2
<b>Standard</b>	FCC CLASS A		

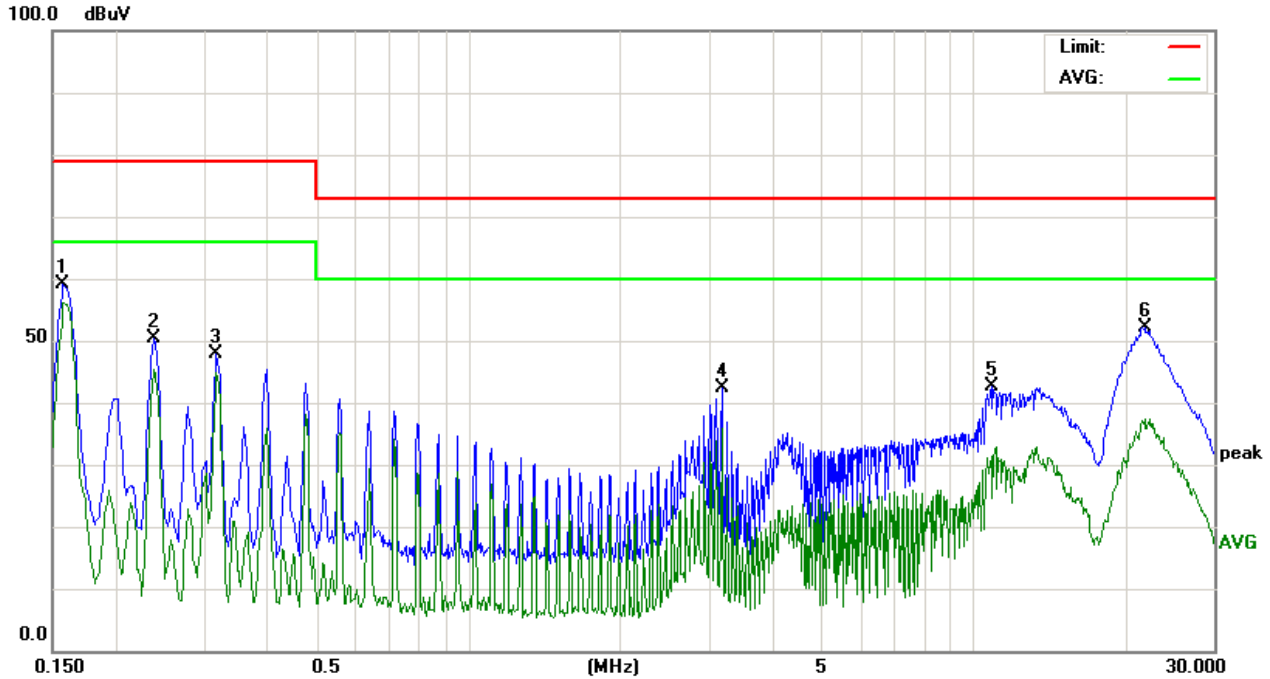

Conducted Emission Readings							
Frequency Range Investigated				150 kHz to 30 MHz			
Freq. (MHz)	Reading (dBuV)	Factor (dB)	Result (dBuV)	Limit (dBuV)	Margin (dB)	Detector (P/Q/A)	Line (L1/L2)
0.1580	49.01	10.07	59.08	79.00	-19.92	P	L2
0.2380	40.47	9.98	50.45	79.00	-28.55	P	L2
0.3180	37.85	9.94	47.79	79.00	-31.21	P	L2
3.1820	32.49	9.96	42.45	73.00	-30.55	P	L2
10.8900	32.62	10.09	42.71	73.00	-30.29	P	L2
21.8940	41.78	10.39	52.17	73.00	-20.83	P	L2

**Note:** 1. L1 = Line One (Live Line) / L2 = Line Two (Neutral Line).  
 2. The emission level was or more than 2dB below the Average limit, so no re-check anymore.



## 7 RADIATED EMISSION MEASUREMENT

### 7.1. LIMITS OF RADIATED EMISSION MEASUREMENT

Below 1GHz (for digital device)

FREQUENCY (MHz)	dBuV/m (At 10m)	
	Class A	Class B
30 ~ 230	40	30
230 ~ 1000	47	37

Limit tables for non-digital device:

Class A Radiated Emission limit at 10m (for others)

Frequency (MHZ)	Field Strength Limit (uV/m)Q.P.	Field Strength Limit (dBuV/m)Q.P.
30 - 88	90	39
88 - 216	150	43.5
216 – 960	210	46.4
Above 960	300	49.5

Class B Radiated Emission limit at 3m (for others)

Frequency (MHZ)	Field Strength Limit (uV/m)Q.P.	Field Strength Limit (dBuV/m)Q.P.
30 - 88	100	40
88 - 216	150	43.5
216 – 960	200	46
Above 960	500	54

Above 1GHz(for all device)

Frequency (MHZ)	Class A (dBuV/m) (At 10m)		Class B (dBuV/m) (At 3m)	
	Average	Peak	Average	Peak
Above 1000	49.5	69.5	54	74

NOTE: 1. The lower limit shall apply at the transition frequencies.

2. Emission level (dBuV/m) = 20 log Emission level (uV/m).

3. The measurement above 1GHz is at close-in distances 3m, and determine the limit  $L_2$  corresponding to the close-in distance  $d_2$  by applying the following relation:  $L_2 = L_1 (d_1/d_2)$ , where  $L_1$  is the specified limit in microvolts per metre (uV/m) at the distance  $d_1$  (10m),  $L_2$  is the new limit for distance  $d_2$  (3m).

So the new Class A limit above 1GHz at 3m is as following table:

Frequency (MHZ)	Class A (dBuV/m) (At 3m)	
	Average	Peak
Above 1000	60	80



According to FCC Part 15.33 (b), for an unintentional radiator, including a digital device, the spectrum shall be investigated from the lowest radio frequency signal generated or used in the device, without going below the lowest frequency for which a radiated emission limit is specified, up to the frequency shown in the following table:

Highest frequency generated or used in the device or on which the device operates or tunes (MHz)	Upper frequency of measurement range (MHz)
Below 1.75	30
1.75-108	1000
108-500	2000
500-1000	5000
Above 1000	5 <sup>th</sup> harmonic of the highest frequency or 40GHz, whichever is lower





**7.2. TEST INSTRUMENTS**

Open Area Test Site # I				
Name of Equipment	Manufacturer	Model	Serial Number	Calibration Due
MEASURE RECEIVER	SCHAFFNER	SCR3501	338	07/05/2012
SPECTRUM ANALYZER	ADVANTEST	R3132	120900008	No Calibration Required
ANTENNA	SUNOL	JB1	A100209-3	10/03/2012
AMPLIFIER	SCHAFFNER	CPA9231A	3626	10/06/2012
CABLE	PACIFIC	8D-FB	N-TYPE #14	01/17/2012
THERMO-HYGRO METER	TECPEL	DTM-303	090639	05/16/2012
Test S/W	EZ-EMC			
Above 1GHz Used				
MEASURE RECEIVER	R&S	ESCI	101202	09/05/2012
ANTENNA (30-1000MHz)	SUNOL	JB1	A022310	10/05/2012
PRE-AMPLIFIER	EMCI	EMC330	980022	01/20/2012
CABLE (30-1000MHz)	HUBER +SUHNER	SUCOFLEX 102	33105/2	01/20/2012
CABLE (30-1000MHz)	EMCI	EMCI-C-14	CH-D#13	01/20/2012
ATTENUATOR	MCL	BW-S6W5	CH-D#14	01/20/2012
LOOP ANTENNA	EMCO	6502	8905-2356	06/10/2013
SPECTRUM ANALYZER (9kHz-30GHz)	R&S	FSP 30	100112	12/07/2011
SPECTRUM ANALYZER (9kHz-40GHz)	Agilent	E4446A	MY48250064	12/29/2011
ANTENNA (1-18GHz)	EMCO	3115	00022256	01/09/2012
AMPLIFIER (1-18GHz)	HP	8449B	3008A01266	12/19/2011
CABLE (1-40GHz)	HUBER +SUHNER	SUCOFLEX 102	33106/2	12/19/2011
CABLE (18-40GHz)	HUBER +SUHNER	SUCOFLEX 102	33633/2	12/19/2011
CABLE (1-26.5GHz)	HUBER +SUHNER	SUCOFLEX 104PEA	33959/4PEA	12/19/2011
CABLE (1-26.5GHz)	HUBER +SUHNER	SUCOFLEX 104PEA	33960/4PEA	12/19/2011
THERMO-HYGRO METER	TECPEL	DTM-303	NO.3	11/18/2011
Test S/W	EZ-EMC			

**NOTE:** 1. The calibration interval of the above test instruments is 12 months and the calibrations are traceable to NML/ROC and NIST/USA.  
 2. N.C.R = No Calibration Request.



**7.3. TEST PROCEDURES** (please refer to measurement standard or CCS SOP PA-031)

**Procedure of Preliminary Test**

- The equipment was set up as per the test configuration to simulate typical usage per the user's manual. When the EUT is a tabletop system, a wooden turntable with a height of 0.8 meters is used which is placed on the ground plane. When the EUT is a floor standing equipment, it is placed on the ground plane which has a 12 mm non-conductive covering to insulate the EUT from the ground plane.
- Support equipment, if needed, was placed as per ANSI C63.4.
- All I/O cables were positioned to simulate typical usage as per ANSI C63.4.
- The EUT received AC 120VAC/60Hz power source from the outlet socket under the turntable. All support equipment power received from another socket under the turntable.
- The antenna was placed at 3 or 10 meter away from the EUT as stated in ANSI C63.4. The antenna connected to the Spectrum Analyzer via a cable and at times a pre-amplifier would be used.
- The Analyzer / Receiver quickly scanned from 30MHz to 40GHz. The EUT test program was started. Emissions were scanned and measured rotating the EUT to 360 degrees and positioning the antenna 1 to 4 meters above the ground plane, in both the vertical and the horizontal polarization, to maximize the emission reading level.
- The test mode(s) described in Item 3.1 were scanned during the preliminary test:
- After the preliminary scan, we found the test mode described in Item 3.1 producing the highest emission level.
- The worst configuration of EUT and cable of the above highest emission level were recorded for reference of the final test.



### Procedure of Final Test

- EUT and support equipment were set up on the turntable as per the configuration with highest emission level in the preliminary test.
- The Analyzer / Receiver scanned from 30MHz to 40GHz. Emissions were scanned and measured rotating the EUT to 360 degrees, varying cable placement and positioning the antenna 1 to 4 meters above the ground plane, in both the vertical and the horizontal polarization, to maximize the emission reading level.
- Recording at least the six highest emissions. Emission frequency, amplitude, antenna position, polarization and turntable position were recorded into a computer in which correction factors were used to calculate the emission level and compare reading to the applicable limit. Below 1GHz the Q.P. reading and above 1GHz the Peak and Average reading are presented.
- The test data of the worst-case condition(s) was recorded.

### 7.4. TEST SETUP

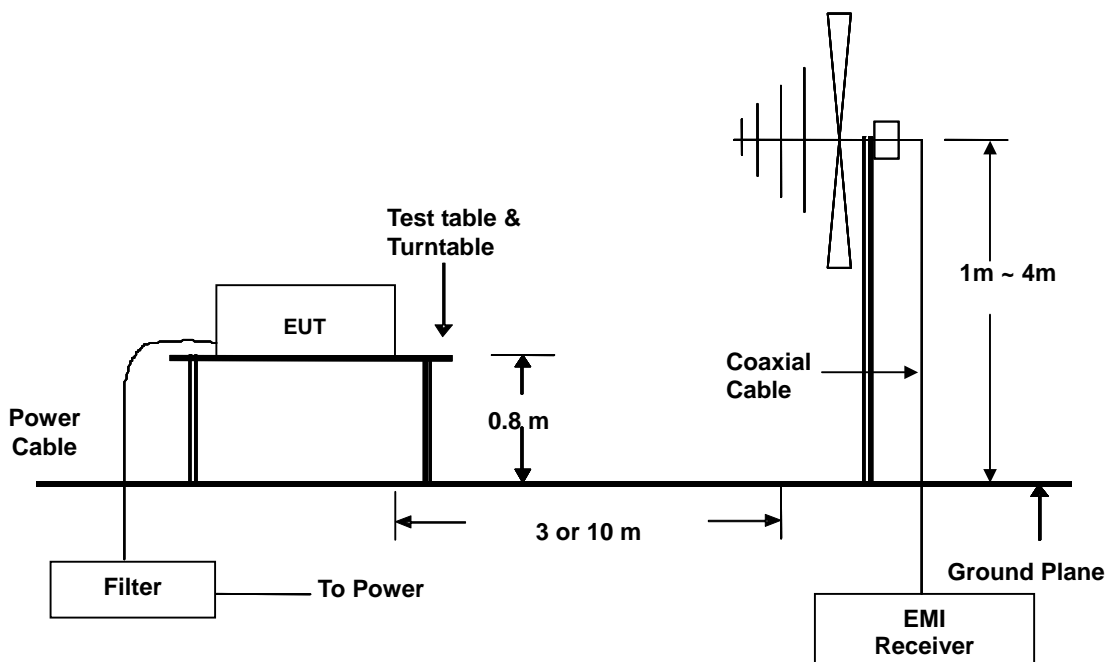

- For the actual test configuration, please refer to the related item – Photographs of the Test Configuration.



### 7.5. DATA SAMPLE

#### Below 1GHz

Freq. (MHz)	Reading (dBuV)	Factor (dB/m)	Result (dBuV/m)	Limit (dBuV/m)	Margin (dB)	Detector (P/Q)	Pol. (H/V)
x.xx	14.0	12.2	26.2	40	-13.8	Q	H

#### Above 1GHz

Freq. (MHz)	Reading (dBuV)	Factor (dB/m)	Result (dBuV/m)	Limit (dBuV/m)	Margin (dB)	Detector (P/A)	Pol. (H/V)
x.xx	42.95	0.55	43.50	60	-16.50	A	H

- Freq. = Emission frequency in MHz
- Reading = Uncorrected Analyzer/Receiver reading
- Factor = Antenna Factor + Cable Loss - Amplifier Gain
- Result = Reading + Factor
- Limit = Limit stated in standard
- Margin = Reading in reference to limit
- P = Peak Reading
- Q = Quasi-peak Reading
- A = Average Reading
- H = Antenna Polarization: Horizontal
- V = Antenna Polarization: Vertical

#### Calculation Formula

Margin (dB) = Result (dBuV/m) – Limit (dBuV/m)



### 7.6. TEST RESULTS

#### Below 1GHz

<b>Model No.</b>	TF-COM-TC-A10-03	<b>Test Mode</b>	Mode 1
<b>Environmental Conditions</b>	23°C, 71% RH, 1010mbar	<b>6dB Bandwidth</b>	120 kHz
<b>Antenna Pole</b>	Vertical	<b>Antenna Distance</b>	10m
<b>Detector Function</b>	Quasi-peak.	<b>Tested by</b>	Kevin Chang
<b>Standard</b>	FCC CLASS A W/ EN 55022 CLASS A LIMIT		

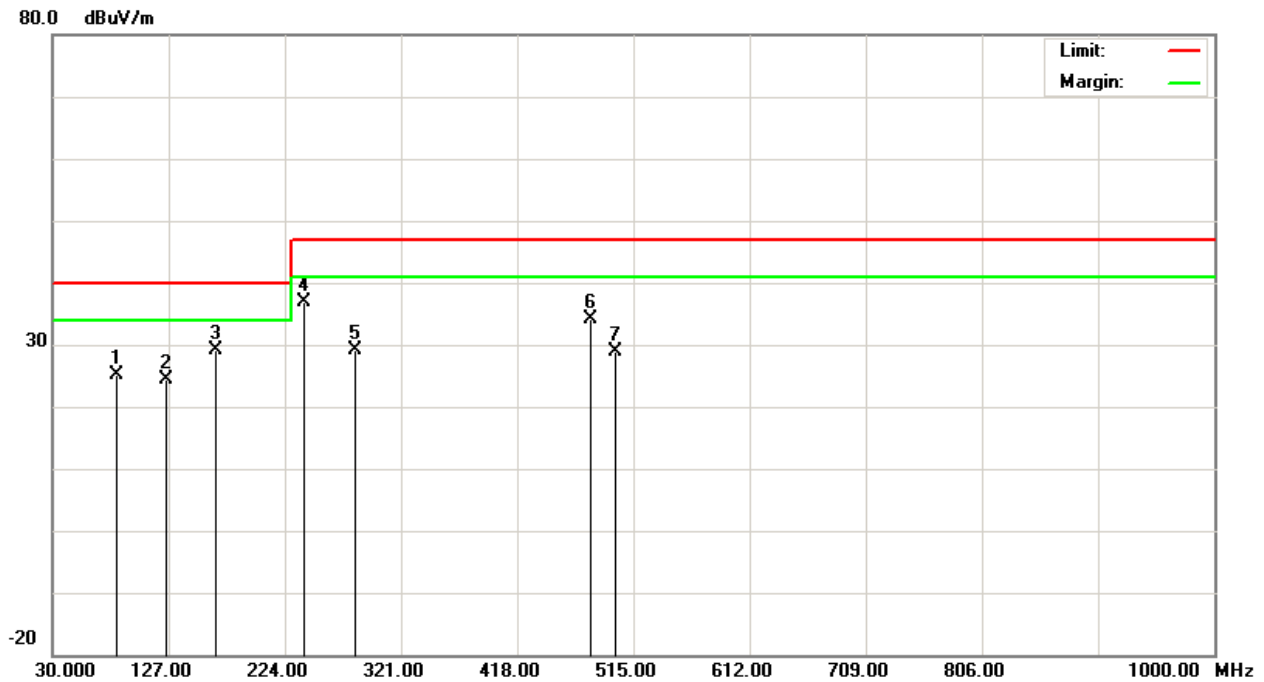

Radiated Emission Readings									
Frequency Range Investigated				30 MHz to 1000 MHz at 10m					
Freq. (MHz)	Reading (dBuV)	Factor (dB/m)	Result (dBuV/m)	Limit (dBuV/m)	Margin (dB)	Height (cm)	Degree (°)	Detector (P/Q)	Pol. (H/V)
83.2600	46.50	-21.25	25.25	40.00	-14.75	100	8	Q	V
125.1200	39.20	-14.89	24.31	40.00	-15.69	100	45	Q	V
165.9200	45.70	-16.62	29.08	40.00	-10.92	100	323	Q	V
240.0200	53.20	-16.34	36.86	47.00	-10.14	100	26	Q	V
282.6600	43.50	-14.38	29.12	47.00	-17.88	100	125	Q	V
480.0200	43.50	-9.48	34.02	47.00	-12.98	400	147	Q	V
500.0100	37.90	-8.93	28.97	47.00	-18.03	400	100	Q	V

- Note:**
1. 30MHz to 1000MHz test is Applicable CISPR 22 / EN 55022 standard.
  2. The other emission levels were very low against the limit.
  3. P= Peak Reading; Q= Quasi-peak Reading.



<b>Model No.</b>	TF-COM-TC-A10-03	<b>Test Mode</b>	Mode 1
<b>Environmental Conditions</b>	23°C, 71% RH, 1010mbar	<b>6dB Bandwidth</b>	120 kHz
<b>Antenna Pole</b>	Horizontal	<b>Antenna Distance</b>	10m
<b>Detector Function</b>	Quasi-peak.	<b>Tested by</b>	Kevin Chang
<b>Standard</b>	FCC CLASS A W/ EN 55022 CLASS A LIMIT		

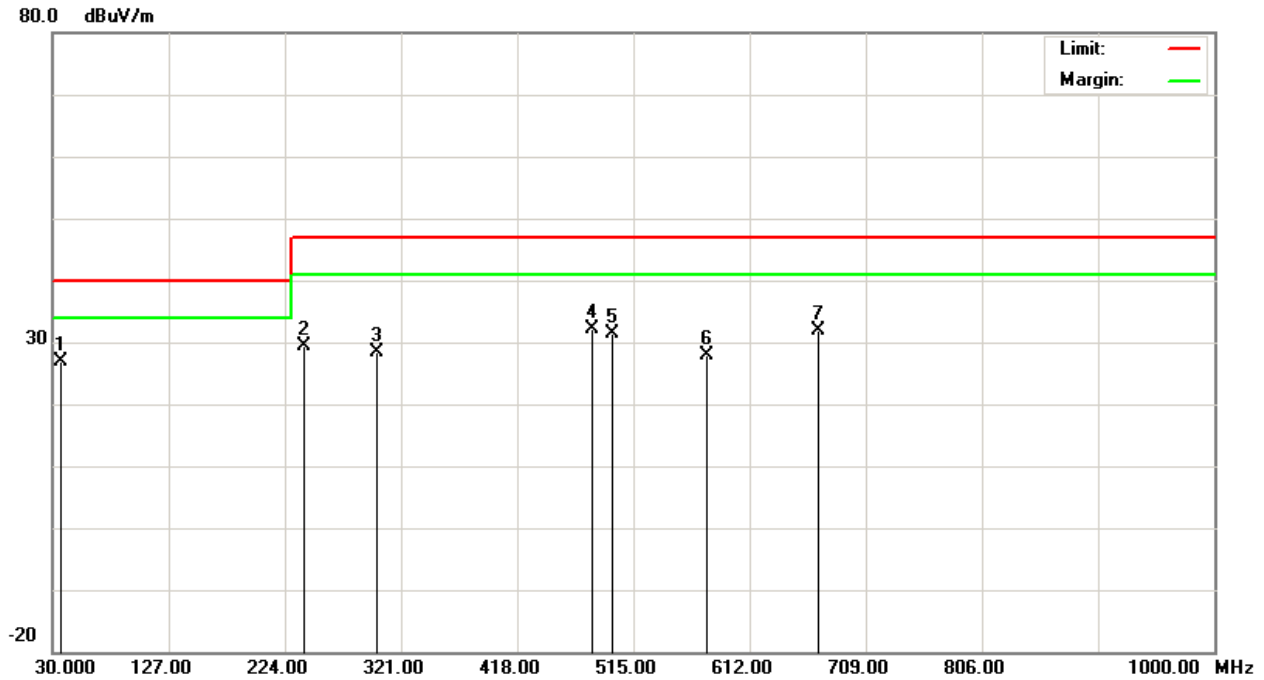

Radiated Emission Readings									
Frequency Range Investigated				30 MHz to 1000 MHz at 10m					
Freq. (MHz)	Reading (dBuV)	Factor (dB/m)	Result (dBuV/m)	Limit (dBuV/m)	Margin (dB)	Height (cm)	Degree (°)	Detector (P/Q)	Pol. (H/V)
36.8000	40.20	-13.32	26.88	40.00	-13.12	400	102	Q	H
240.0200	45.60	-16.34	29.26	47.00	-17.74	400	300	Q	H
300.4100	42.50	-14.14	28.36	47.00	-18.64	400	47	Q	H
480.4500	41.70	-9.47	32.23	47.00	-14.77	100	28	Q	H
497.2400	40.40	-9.01	31.39	47.00	-15.61	100	227	Q	H
576.2300	35.70	-7.90	27.80	47.00	-19.20	100	163	Q	H
669.3200	37.90	-6.06	31.84	47.00	-15.16	100	22	Q	H

- Note:**
1. 30MHz to 1000MHz test is Applicable CISPR 22 / EN 55022 standard.
  2. The other emission levels were very low against the limit.
  3. P= Peak Reading; Q= Quasi-peak Reading.



<b>Model No.</b>	TF-COM-TC-A10-03	<b>Test Mode</b>	Mode 1
<b>Environmental Conditions</b>	23°C, 71% RH, 1010mbar	<b>6dB Bandwidth</b>	120 kHz
<b>Antenna Pole</b>	Vertical	<b>Antenna Distance</b>	10m
<b>Detector Function</b>	Quasi-peak.	<b>Tested by</b>	Kevin Chang
<b>Standard</b>	FCC CLASS A W/ EN 55022 CLASS A LIMIT + 6dB		

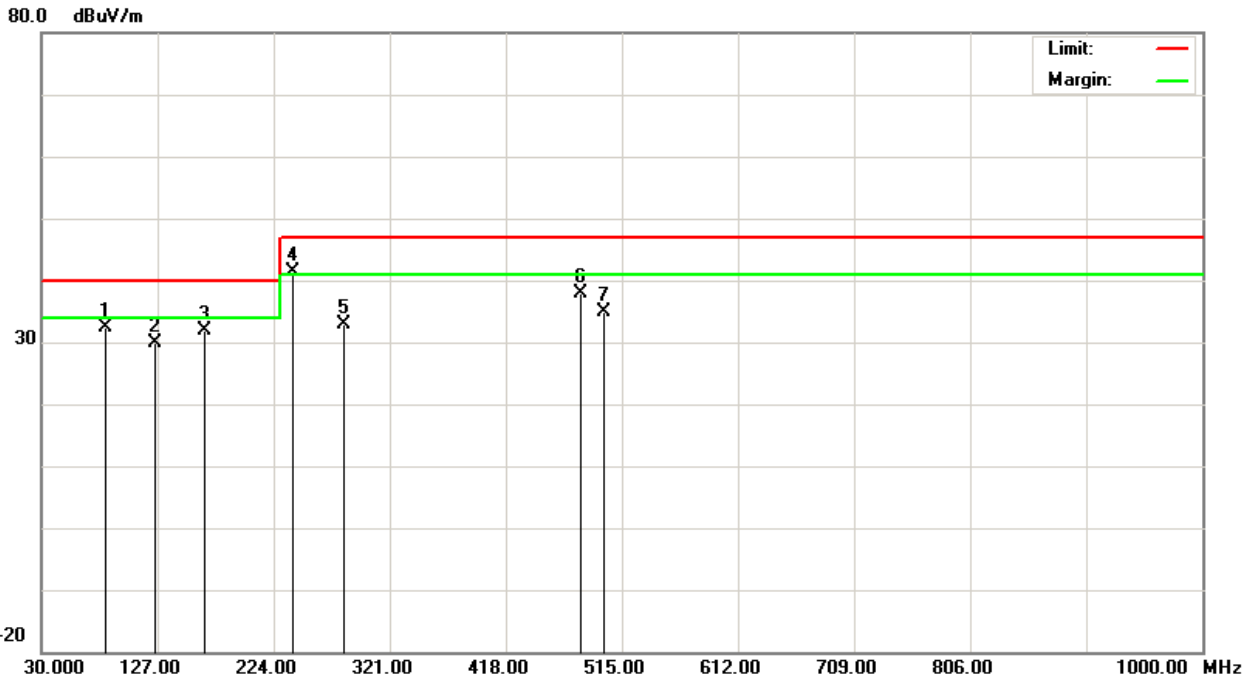

Radiated Emission Readings									
Frequency Range Investigated				30 MHz to 1000 MHz at 10m					
Freq. (MHz)	Reading (dBuV)	Factor (dB/m)	Result (dBuV/m)	Limit (dBuV/m)	Margin (dB)	Height (cm)	Degree (°)	Detector (P/Q)	Pol. (H/V)
83.3100	53.70	-21.24	32.46	46.00	-13.54	100	14	Q	V
125.2000	44.80	-14.89	29.91	46.00	-16.09	100	172	Q	V
166.0300	48.60	-16.62	31.98	46.00	-14.02	100	256	Q	V
240.1000	57.60	-16.34	41.26	53.00	-11.74	100	124	Q	V
282.7600	47.30	-14.38	32.92	53.00	-20.08	100	226	Q	V
480.1200	47.30	-9.47	37.83	53.00	-15.17	400	45	Q	V
500.2100	43.80	-8.93	34.87	53.00	-18.13	400	2	Q	V

**Note:** 1. 30MHz to 1000MHz test is Applicable CISPR 22 / EN 55022 standard.  
 2. The other emission levels were very low against the limit.  
 3. P= Peak Reading; Q= Quasi-peak Reading.



<b>Model No.</b>	TF-COM-TC-A10-03	<b>Test Mode</b>	Mode 1
<b>Environmental Conditions</b>	23°C, 71% RH, 1010mbar	<b>6dB Bandwidth</b>	120 kHz
<b>Antenna Pole</b>	Horizontal	<b>Antenna Distance</b>	10m
<b>Detector Function</b>	Quasi-peak.	<b>Tested by</b>	Kevin Chang
<b>Standard</b>	FCC CLASS A W/ EN 55022 CLASS A LIMIT + 6dB		

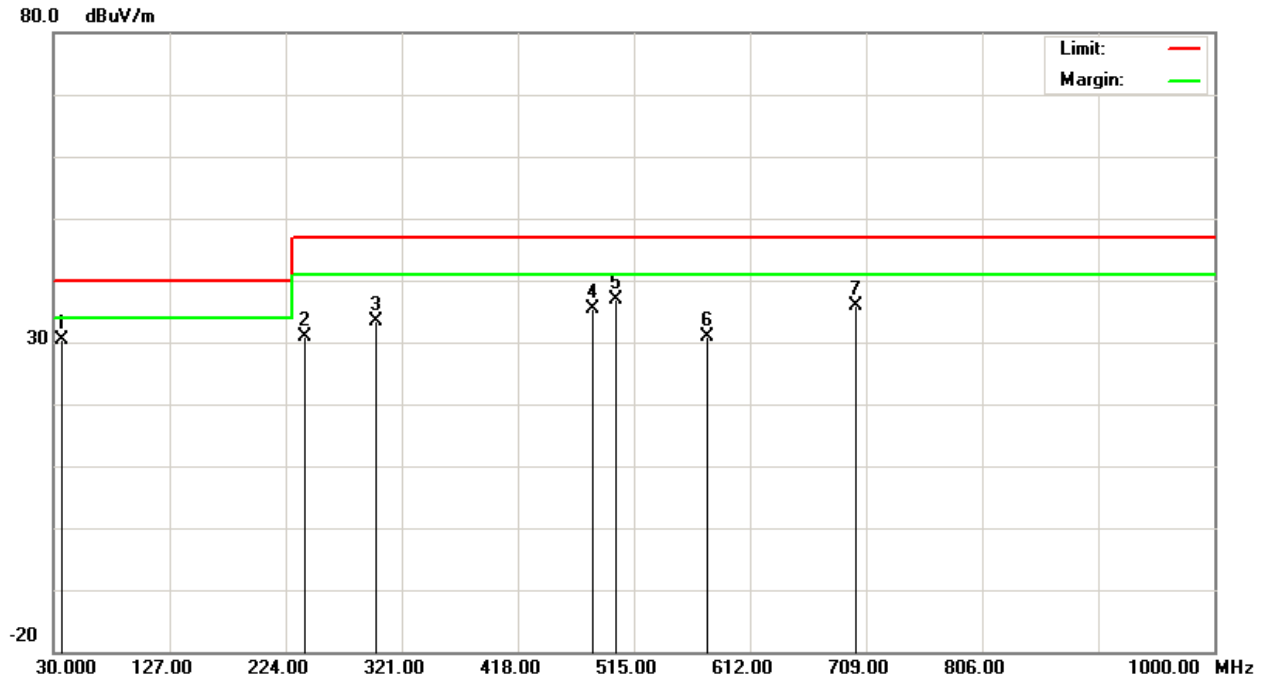

Radiated Emission Readings									
Frequency Range Investigated				30 MHz to 1000 MHz at 10m					
Freq. (MHz)	Reading (dBuV)	Factor (dB/m)	Result (dBuV/m)	Limit (dBuV/m)	Margin (dB)	Height (cm)	Degree (°)	Detector (P/Q)	Pol. (H/V)
36.8200	43.70	-13.33	30.37	46.00	-15.63	400	23	Q	H
240.1100	47.30	-16.34	30.96	53.00	-22.04	400	107	Q	H
300.1800	47.60	-14.15	33.45	53.00	-19.55	400	247	Q	H
480.3300	44.90	-9.47	35.43	53.00	-17.57	100	12	Q	H
500.0200	45.80	-8.93	36.87	53.00	-16.13	100	0	Q	H
576.1300	38.90	-7.90	31.00	53.00	-22.00	100	334	Q	H
700.2000	41.50	-5.65	35.85	53.00	-17.15	100	68	Q	H

- Note:**
1. 30MHz to 1000MHz test is Applicable CISPR 22 / EN 55022 standard.
  2. The other emission levels were very low against the limit.
  3. P= Peak Reading; Q= Quasi-peak Reading.





**Above 1GHz**

<b>Model No.</b>	TF-COM-TC-A10-03	<b>Test Mode</b>	Mode 1
<b>Environmental Conditions</b>	26°C, 60% RH, 1010mbar	<b>6dB Bandwidth</b>	1 MHz
<b>Antenna Pole</b>	Vertical / Horizontal	<b>Antenna Distance</b>	3m
<b>Highest frequency generated or used</b>	1600MHz	<b>Upper frequency</b>	8000MHz
<b>Detector Function</b>	Peak or average.	<b>Tested by</b>	Kevin Chang
<b>Standard</b>	FCC CLASS A		

Radiated Emission Readings							
Frequency Range Investigated				Above 1GHz at 3m			
Freq. (MHz)	Reading (dBuV)	Factor (dB/m)	Result (dBuV/m)	Limit (dBuV/m)	Margin (dB)	Detector (P/A)	Pol. (H/V)
1020.000	53.52	-11.67	41.85	80.00	-38.15	P	V
1335.000	56.60	-10.23	46.37	80.00	-33.63	P	V
1630.000	56.18	-8.75	47.43	80.00	-32.57	P	V
2225.000	51.43	-6.03	45.40	80.00	-34.60	P	V
3040.000	50.16	-3.02	47.14	80.00	-32.86	P	V
5640.000	47.52	2.50	50.02	80.00	-29.98	P	V

Radiated Emission Readings							
Frequency Range Investigated				Above 1GHz at 3m			
Freq. (MHz)	Reading (dBuV)	Factor (dB/m)	Result (dBuV/m)	Limit (dBuV/m)	Margin (dB)	Detector (P/A)	Pol. (H/V)
1330.000	59.49	-10.24	49.25	80.00	-30.75	P	H
1635.000	53.72	-8.71	45.01	80.00	-34.99	P	H
2225.000	53.28	-6.03	47.25	80.00	-32.75	P	H
3030.000	50.09	-3.04	47.05	80.00	-32.95	P	H
4415.000	46.55	-0.01	46.54	80.00	-33.46	P	H
5635.000	46.79	2.48	49.27	80.00	-30.73	P	H

- Note:** 1. The other emission levels were very low against the limit.  
 2. P= Peak Reading; A= Average Reading.



## 8 PHOTOGRAPHS OF THE TEST CONFIGURATION CONDUCTED EMISSION TEST





## RADIATED EMISSION TEST





**RADIATED EMISSION TEST (Open Chassis)**

