

FCC 47 CFR PART 15 SUBPART B TEST REPORT

for

COM Express CPU Module

MODEL: xx-COM-QM77-xxx-xxxxxxx (Where x is 0-9 , A-Z , -or blank)

Test Report Number:
T160811D10-F

Issued to:

AAEON Technology Inc.

**5F, No.135, Lane 235, Pao Chiao Rd, Hsin-Tien Dist.,
New Taipei City, Taiwan, R.O.C.**

Issued by:

Compliance Certification Services Inc.

Xindian Lab.

**No.163-1, Jhongsheng Rd., Xindian Dist.,
New Taipei City, 23151 Taiwan.**

TEL: 886-2-22170894

FAX: 886-2-22171029

Issued Date: August 16, 2016



Note: This report shall not be reproduced except in full, without the written approval of Compliance Certification Services Inc. This document may be altered or revised by Compliance Certification Services Inc. personnel only, and shall be noted in the revision section of the document. The client should not use it to claim product endorsement by TAF, A2LA, NIST or any government agencies. The test results in the report only apply to the tested sample.

Revision History

Rev.	Issue Date	Revisions	Effect Page	Revised By
00	August 08, 2012	Initial Issue	ALL	Joy Hsiao
01	August 16, 2016	Add a EUT	ALL	Joy Hsiao

TABLE OF CONTENTS

1 TEST RESULT CERTIFICATION.....4

2 EUT DESCRIPTION.....5

3 TEST METHODOLOGY.....6

 3.1. DECISION OF FINAL TEST MODE6

 3.2. EUT SYSTEM OPERATION6

4 SETUP OF EQUIPMENT UNDER TEST7

 4.1. DESCRIPTION OF SUPPORT UNITS.....7

 4.2. CONFIGURATION OF SYSTEM UNDER TEST.....8

5 FACILITIES AND ACCREDITATIONS9

 5.1. FACILITIES.....9

 5.2. ACCREDITATIONS.....9

 5.3. MEASUREMENT UNCERTAINTY9

6 CONDUCTED EMISSION MEASUREMENT11

 6.1. LIMITS OF CONDUCTED EMISSION MEASUREMENT.....11

 6.2. TEST INSTRUMENTS11

 6.3. TEST PROCEDURES.....12

 6.4. TEST SETUP13

 6.5. DATA SAMPLE13

 6.6. TEST RESULTS14

7 RADIATED EMISSION MEASUREMENT16

 7.1. LIMITS OF RADIATED EMISSION MEASUREMENT16

 7.2. TEST INSTRUMENTS18

 7.3. TEST PROCEDURES.....20

 7.4. TEST SETUP21

 7.5. DATA SAMPLE22

 7.6. TEST RESULTS23

8 PHOTOGRAPHS OF THE TEST CONFIGURATION26

APPENDIX 1 - PHOTOGRAPHS OF EUT A1-1

1 TEST RESULT CERTIFICATION

Product:	COM Express CPU Module
Model:	xx-COM-QM77-xxx-xxxxxxx (Where x is 0-9 , A-Z , -or blank)
Brand:	AAEON
Applicant:	AAEON Technology Inc. 5F, No.135, Lane 235, Pao Chiao Rd, Hsin-Tien Dist., New Taipei City, Taiwan, R.O.C.
Manufacturer:	AAEON Technology Inc. 5F, No.135, Lane 235, Pao Chiao Rd, Hsin-Tien Dist., New Taipei City, Taiwan, R.O.C.
Tested:	July 31, 2012 ~ August 13, 2016

EMISSION			
Standard	Item	Result	Remarks
FCC 47 CFR Part 15 Subpart B, ICES-003 Issue 6-2016 ANSI C63.4-2014	Conducted (Power Port)	PASS	Meet Class A limit
	Radiated	PASS	Meet Class A limit

- Note:**
1. The statements of test result on the above are decided by the request of test standard only; the measurement uncertainties are not factored into this compliance determination.
 2. The information of measurement uncertainty is available upon the customer’s request.

Deviation from Applicable Standard
None

The above equipment has been tested by Compliance Certification Services Inc., and found compliance with the requirements set forth in the technical standards mentioned above. The results of testing in this report apply only to the product/system, which was tested. Other similar equipment will not necessarily produce the same results due to production tolerance and measurement uncertainties.

Approved by:

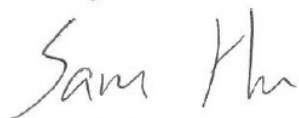

Sam Hu
Assistant Manager

Reviewed by:



Eva Fan
Supervisor of report document dept.

2 EUT DESCRIPTION

Product	COM Express CPU Module
Brand Name	AAEON
Model	xx-COM-QM77-xxx-xxxxxxx (Where x is 0-9 , A-Z , -or blank)
Applicant	AAEON Technology Inc.
Housing material	N/A
Identify Number	T120731D03
Received Date	July 31, 2012
EUT Power Rating	5VDC/ 12VDC from Host PC Power Supply
AC Power During Test	120VAC / 60Hz to Host PC Power Supply
OSC/Clock Frequencies	25MHz; 32.768kHz

Model Differences

Model Name	Difference	Tested (Checked)
COM-QM77-B10	Original	<input checked="" type="checkbox"/>
COM-QM77-B20	Change CPU	<input checked="" type="checkbox"/>
xx-COM-QM77-xxx-xxxxxxx	1. For marketing purpose only 2. Where x is 0-9 , A-Z , -or blank	<input type="checkbox"/>

I/O PORT

I/O PORT TYPES	Q'TY	TESTED WITH
1. SIO Port	4	4
2. VGA Port	1	1
3. DVI Port	1	1
4. Audio In Port	1	1
5. Earphone Port	1	1
6. Microphone Port	1	1
7. USB 2.0 Port	2	2
8. USB 3.0 Port	4	4
9. LAN Port	2	2
10. PS/2 one to two adaptor	1	1
11. HDMI Port	1	1
12. DIO Port	1	1

Note: None.

3 TEST METHODOLOGY

3.1. DECISION OF FINAL TEST MODE

The EUT was tested together with the above additional components, and a configuration, which produced the worst emission levels, was selected and recorded in this report.

The test configuration/ modes are as the following:

Conduction Modes:

No.	Model	CPU	Operate State
1	COM-QM77-B10	Intel / Core i7-3555LE (2.5GHz)	1920X1200 / VGA + DVI MODE
2			1920X1200 / VGA + HDMI MODE

Radiation Modes:

No.	Model	CPU	Operate State
1	COM-QM77-B10	Intel / Core i7-3555LE (2.5GHz)	1920X1200 / VGA + DVI MODE
2			1920X1200 / VGA + HDMI MODE
			1920X1200 / VGA + HDMI MODE / 1-12.5GHz
3	COM-QM77-B20	Intel / Intel(R) Core i7-3517UE (1.7GHz)	1920X1200 / VGA + HDMI MODE

Worst:

Conduction: Mode 2

Radiation: Mode 2

3.2. EUT SYSTEM OPERATION

1. Windows 7 boots system.
2. Run Emctest.exe to activate all peripherals and display "H" pattern on monitor screen.
3. Run Winemc.exe then choose "E:/ & F:/ & G:/ & H:/" to test USB 3.0 port.
4. Run Winemc.exe then choose "I:/ & J:/" to test USB 2.0 port.
5. Run Winemc.exe and choose media player to play music.
6. Press the start menu, select executive and type ping 192.168.0.1&2 -t (EUT), ping 192.168.0.11 -t (Server Notebook).

Note: Test program is self-repeating throughout the test.

4 SETUP OF EQUIPMENT UNDER TEST

4.1. DESCRIPTION OF SUPPORT UNITS

The EUT has been tested as an independent unit together with other necessary accessories or support units. The following support units or accessories were used to form a representative test configuration during the tests.

Host PC Devices:

No.	Equipment	Model No.	Brand Name
1	CPU (2.5GHz)	Core i7-3555LE	Intel
	CPU (1.7GHz)	Intel(R) Core i7-3517UE	Intel
2	Memory (8GB)	J4208BASE-DJ-F	ELPIDA
3	Power Supply	FSP300-701UJ	FSP
4	HDD (160GB)	ST9160412AS	Seagate
5	Carrier Board	ECB-917T-xxxxxx(Where x is 0-9 , A-Z , -or blank)	AAEON

Note: Client consigns only one model sample to test (Carrier Board Model Number: ECB-917T-A10).

Peripherals Devices:

No.	Equipment	Model No.	Serial No.	FCC ID / BSMI ID	Brand Name	Data Cable	Power Cord
1	PS/2 Mouse	M-SBF96	FATSQ0C5BYJQ KZ	DOC BSMI: R41126	hp	Shielded, 1.8m	N/A
2	PS/2 Keyboard	SK-2880	BAUEL0HCPY76 G7	DOC BSMI: T3A002	hp	Shielded, 1.8m	N/A
3-4	USB 2.0 HDD	H566	N/A	DOC BSMI: D33311	pqi	Shielded, 1.8m with a core	N/A
5	Player	RQ-L12LT	N/A	BSMI ID: 3912A162	Panasonic	Unshielded, 1.8m	N/A
6	Earphone & Microphone	SEP912	N/A	N/A	Atayal	Unshielded, 1.8m	N/A
7-8	Modem	AL-56ERM	N/A	DOC	GALILEO	Shielded, 1.2m	Unshielded, 1.8m with a core
9-12	USB 3.0 HDD	NU6020	N/A	N/A	GOOD WAY	Shielded, 1.0m	N/A
13-14	Modem	AL-56ERM	N/A	DOC	GALILEO	Shielded, 1.2m	Unshielded, 1.8m with a core
15	Monitor	2408WFPb	N/A	DOC BSMI: R33002	DELL	DVI: Shielded, 1.8m with two cores HDMI: Shielded, 1.2m	Unshielded, 1.8m
16	Monitor	202P40	BZ000405640006	FCC ID: A3KM107 BSMI: R33048	PHILIPS	Shielded, 1.8m with two cores	Unshielded, 1.8m
17	Hub	DGS-1008D	042829	DOC	D-Link	Unshielded, 20m X2	Unshielded, 1.8m
18	Server Notebook	E5420	6YRVLQ1	DOC BSMI: R33002	DELL	Unshielded, 1.0m	Unshielded, 1.8m
19	DIO Cable	N/A	N/A	N/A	N/A	Unshielded, 1.5m	N/A

Note:

- 1) All the equipment/cables were placed in the worst-case configuration to maximize the emission during the test.
- 2) Grounding was established in accordance with the manufacturer's requirements and conditions for the intended use.

4.2. CONFIGURATION OF SYSTEM UNDER TEST

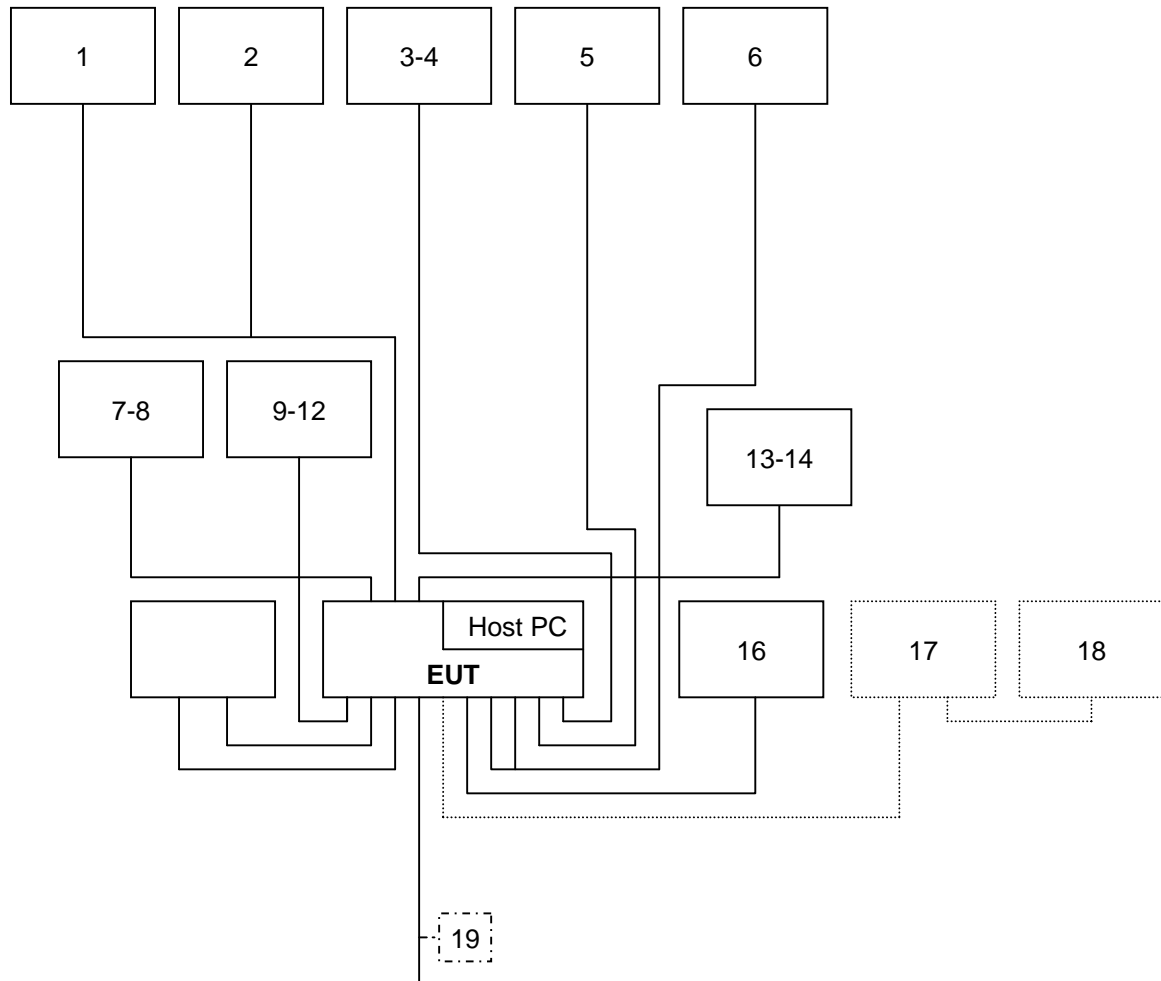

5 FACILITIES AND ACCREDITATIONS

5.1. FACILITIES

All measurement facilities used to collect the measurement data are located at CCSrf Taiwan Xindian Lab. at No.163-1, Jhongsheng Rd., Xindian Dist., New Taipei City, 23151 Taiwan.

The sites are constructed in conformance with the requirements of ANSI C63.4 and CISPR Publication 22. All receiving equipment conforms to CISPR 16-1-1, CISPR 16-1-2, CISPR 16-1-3, CISPR 16-1-4 and CISPR 16-1-5.

5.2. ACCREDITATIONS

Our laboratories are accredited and approved by the following accreditation body according to ISO/IEC 17025.

Taiwan	TAF
USA	A2LA

The measuring facility of laboratories has been authorized or registered by the following approval agencies.

Canada	Industry Canada
Norway	Nemko
Japan	VCCI
Taiwan	BSMI
USA	FCC

Copies of granted accreditation certificates are available for downloading from our web site, <http://www.ccsrf.com>

5.3. MEASUREMENT UNCERTAINTY

Where relevant, the following measurement uncertainty levels have been estimated for tests performed on the EUT as specified in CISPR 16-4-2:

Report No.: T120731D03

Measurement	Frequency	Uncertainty
Conducted emissions	0.15MHz ~ 30MHz	± 1.19
Radiated emissions	30MHz ~ 1000MHz	± 3.83
	1000MHz ~ 18000MHz	± 1.99
	18000MHz ~ 26000MHz	± 2.65
	26000MHz ~ 40000MHz	± 2.97

Report No.: T160811D10

Measurement	Frequency	Uncertainty
Radiated emissions	30MHz ~ 1000MHz	± 4.84

This uncertainty represents an expanded uncertainty expressed at approximately the 95% confidence level using a coverage factor of k=2.

Consistent with industry standard (e.g. CISPR 22: 2005, clause 11, Measurement Uncertainty) determining compliance with the limits shall be base on the results of the compliance measurement. Consequently the measure emissions being less than the maximum allowed emission result in this be a compliant test or passing test.

The acceptable measurement uncertainty value without requiring revision of the compliance statement is base on conducted and radiated emissions being less than U_{CISPR} which is 3.6dB and 5.2dB respectively. CCS values (called U_{Lab} in CISPR 16-4-2) is less than U_{CISPR} as shown in the table above. Therefore, MU need not be considered for compliance.

6 CONDUCTED EMISSION MEASUREMENT

6.1. LIMITS OF CONDUCTED EMISSION MEASUREMENT

FREQUENCY (MHz)	Class A (dBuV)		Class B (dBuV)	
	Quasi-peak	Average	Quasi-peak	Average
0.15 - 0.5	79	66	66 - 56	56 - 46
0.50 - 5.0	73	60	56	46
5.0 - 30.0	73	60	60	50

NOTE:

- (1) The lower limit shall apply at the transition frequencies.
- (2) The limit decreases in line with the logarithm of the frequency in the range 0.15 to 0.50 MHz.
- (3) All emanations from a class A/B digital device or system, including any network of conductors and apparatus connected thereto, shall not exceed the level of field strengths specified above.

6.2. TEST INSTRUMENTS

Conducted Emission room # A				
Name of Equipment	Manufacturer	Model	Serial Number	Calibration Due
TEST RECEIVER	R&S	ESCI	101201	09/05/2012
LISN (EUT)	SCHWARZBECK	NSLK 8127	8127527	12/13/2012
LISN	SCHWARZBECK	NSLK 8127	8127526	12/13/2012
BNC CABLE	EMCI	5Dr	BNC A6	12/07/2012
Pulse Limiter	R&S	ESH3-Z2	C3010026-2	09/07/2012
THERMO-HYGRO METER	WISEWIND	201A	No. 02	05/14/2013
Test S/W	EZ-EMC			

- NOTE:**
1. The calibration interval of the above test instruments is 12 months and the calibrations are traceable to NML/ROC and NIST/USA.
 2. N.C.R = No Calibration Request.

6.3. TEST PROCEDURES (please refer to measurement standard or CCS SOP PA-031)

Procedure of Preliminary Test

- The EUT and support equipment, if needed, were set up as per the test configuration to simulate typical usage per the user's manual. When the EUT is a tabletop system, a wooden table with a height of 0.8 meters is used and is placed on the ground plane as per ANSI C63.4 (see Test Facility for the dimensions of the ground plane used). When the EUT is a floor standing equipment, it is placed on the ground plane, which has a 12 mm non-conductive covering to insulate the EUT from the ground plane.
- All I/O cables were positioned to simulate typical actual usage as per ANSI C63.4.
- The test equipment EUT installed by AC 120VAC/60Hz main power, through a Line Impedance Stabilization Network (LISN), which was supplied power source and was grounded to the ground plane.
- All support equipment power by from a second LISN.
- The test program of the EUT was started. Emissions were measured on each current carrying line of the EUT using an EMI Test Receiver connected to the LISN powering the EUT.
- The Receiver scanned from 150kHz to 30MHz for emissions in each of the test modes.
- During the above scans, the emissions were maximized by cable manipulation.
- The test mode(s) described in Item 3.1 were scanned during the preliminary test.
- After the preliminary scan, we found the test mode described in Item 3.1 producing the highest emission level.
- The worst configuration of EUT and cable of the above highest emission level were recorded for reference of the final test.

Procedure of Final Test

- EUT and support equipment were set up on the test bench as per the configuration with highest emission level in the preliminary test.
- A scan was taken on both power lines, Line 1 and Line 2, recording at least the six highest emissions. Emission frequency and amplitude were recorded into a computer in which correction factors were used to calculate the emission level and compare reading to the applicable limit.
- The test data of the worst-case condition(s) was recorded.

6.4. TEST SETUP

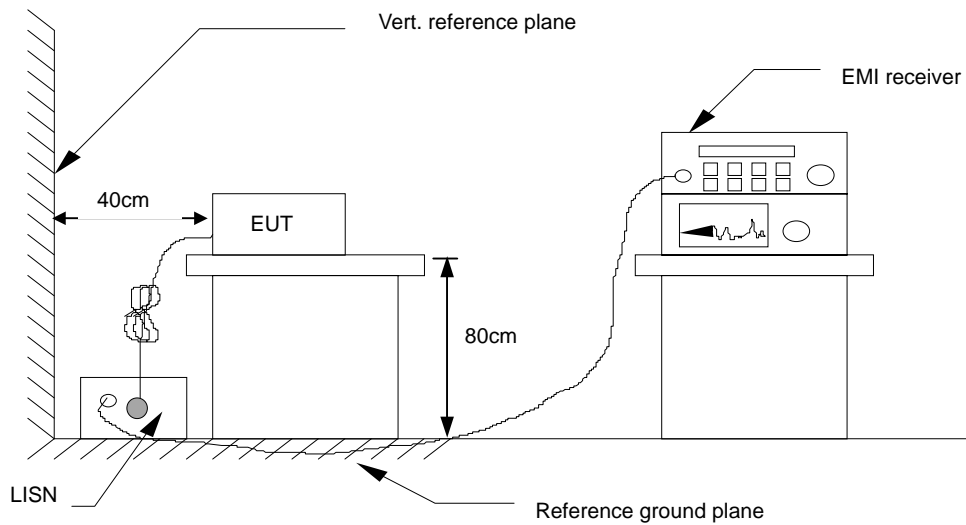

- For the actual test configuration, please refer to the related item – Photographs of the Test Configuration.

6.5. DATA SAMPLE

Freq. (MHz)	Reading (dBuV)	Factor (dB)	Result (dBuV)	Limit (dBuV)	Margin (dB)	Detector (P/Q/A)	Line (L1/L2)
x.xx	42.95	0.55	43.50	73	-29.50	Q	L1

- Freq. = Emission frequency in MHz
- Reading = Uncorrected Analyzer/Receiver reading
- Factor = Insertion loss of LISN + Cable Loss + Pulse Limit
- Result = Reading + Factor
- Limit = Limit stated in standard
- Margin = Reading in reference to limit
- P = Peak Reading
- Q = Quasi-peak Reading
- A = Average Reading
- L1 = Hot side
- L2 = Neutral side

Calculation Formula

Margin (dB) = Result (dBuV) – Limit (dBuV)

6.6. TEST RESULTS

Model No.	COM-QM77-B10	6dB Bandwidth	9 kHz
Environmental Conditions	26°C, 60% RH	Test Mode	Mode 2
Tested by	Alee Shen	Phase	L1
Standard	FCC CLASS A		

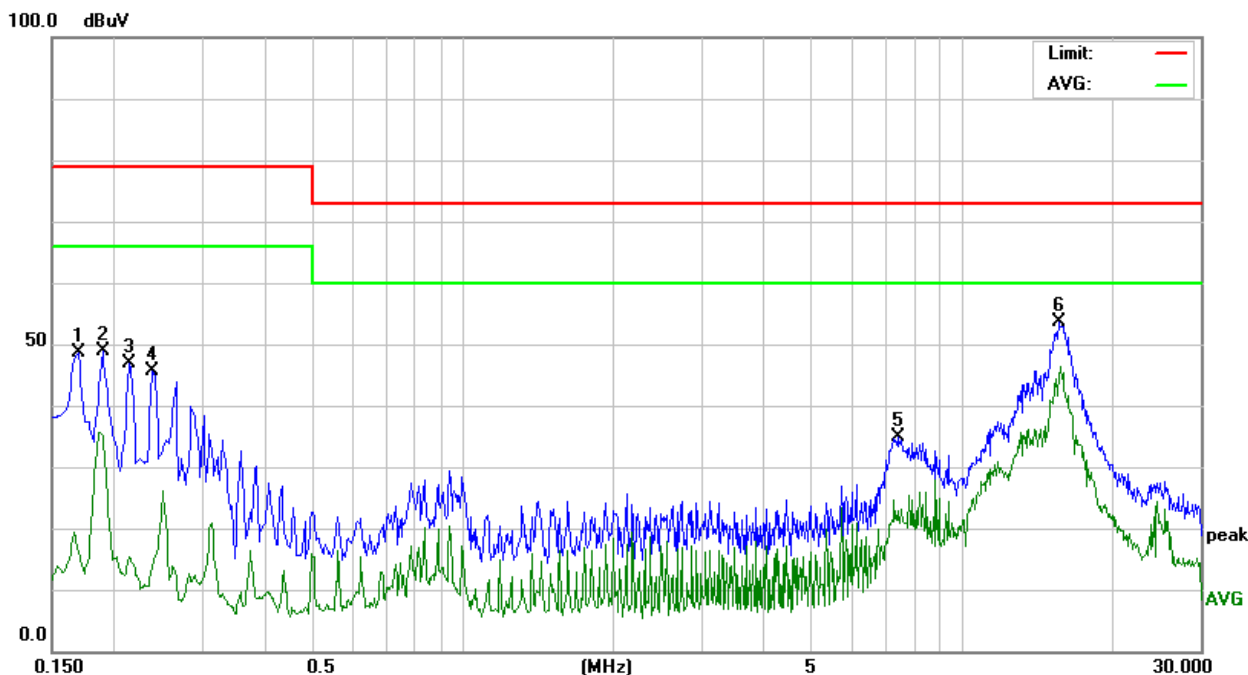

Conducted Emission Readings							
Frequency Range Investigated				150 kHz to 30 MHz			
Freq. (MHz)	Reading (dBuV)	Factor (dB)	Result (dBuV)	Limit (dBuV)	Margin (dB)	Detector (P/Q/A)	Line (L1/L2)
0.1700	38.58	10.05	48.63	79.00	-30.37	P	L1
0.1900	38.78	10.02	48.80	79.00	-30.20	P	L1
0.2140	36.89	10.01	46.90	79.00	-32.10	P	L1
0.2380	35.51	10.01	45.52	79.00	-33.48	P	L1
7.4299	24.33	10.43	34.76	73.00	-38.24	P	L1
15.6179	42.80	10.71	53.51	73.00	-19.49	P	L1

Note: 1. L1 = Line One (Live Line) / L2 = Line Two (Neutral Line).

Model No.	COM-QM77-B10	6dB Bandwidth	9 kHz
Environmental Conditions	26°C, 60% RH	Test Mode	Mode 2
Tested by	Alee Shen	Phase	L2
Standard	FCC CLASS A		

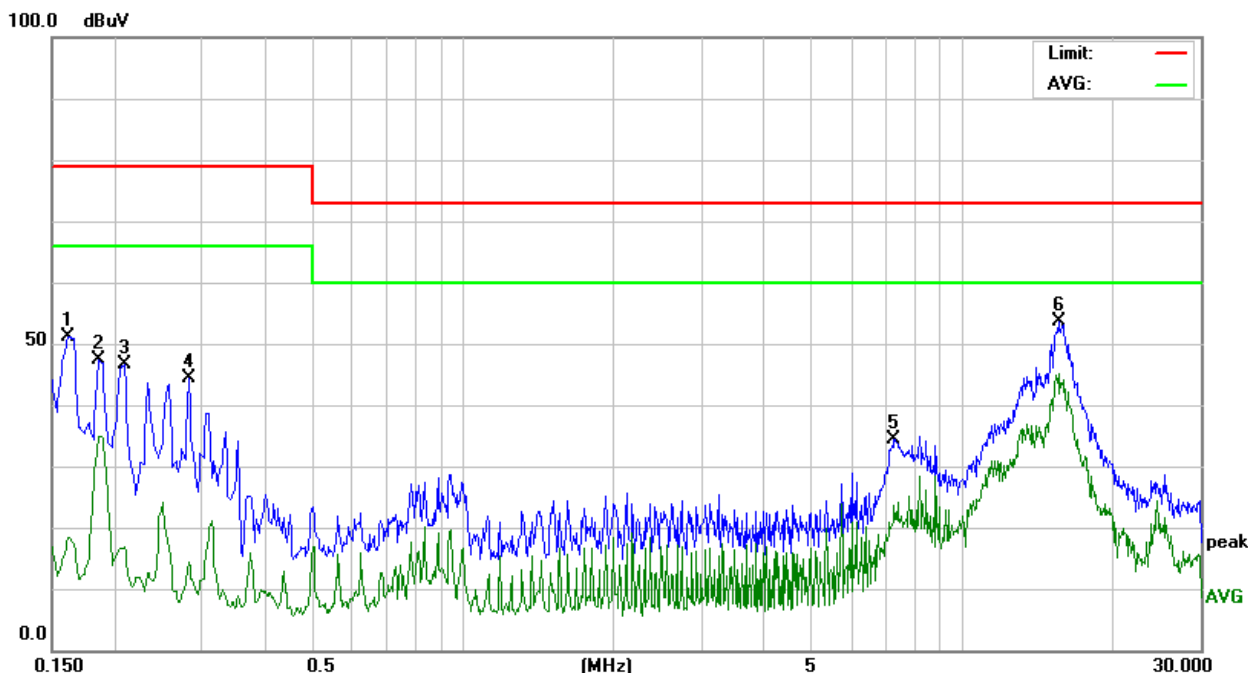

Conducted Emission Readings							
Frequency Range Investigated				150 kHz to 30 MHz			
Freq. (MHz)	Reading (dBuV)	Factor (dB)	Result (dBuV)	Limit (dBuV)	Margin (dB)	Detector (P/Q/A)	Line (L1/L2)
0.1620	41.07	10.06	51.13	79.00	-27.87	P	L2
0.1860	37.27	10.03	47.30	79.00	-31.70	P	L2
0.2100	36.58	10.01	46.59	79.00	-32.41	P	L2
0.2820	34.43	10.02	44.45	79.00	-34.55	P	L2
7.3020	24.09	10.40	34.49	73.00	-38.51	P	L2
15.5540	42.85	10.68	53.53	73.00	-19.47	P	L2

Note: 1. L1 = Line One (Live Line) / L2 = Line Two (Neutral Line).

7 RADIATED EMISSION MEASUREMENT

7.1. LIMITS OF RADIATED EMISSION MEASUREMENT

Below 1GHz (for digital device)

FREQUENCY (MHz)	dBuV/m (At 10m)	
	Class A	Class B
30 ~ 230	40	30
230 ~ 1000	47	37

Limit tables for non-digital device:

Class A Radiated Emission limit at 10m (for others)

Frequency (MHZ)	Field Strength Limit (uV/m)Q.P.	Field Strength Limit (dBuV/m)Q.P.
30 - 88	90	39
88 - 216	150	43.5
216 – 960	210	46.4
Above 960	300	49.5

Class B Radiated Emission limit at 3m (for others)

Frequency (MHZ)	Field Strength Limit (uV/m)Q.P.	Field Strength Limit (dBuV/m)Q.P.
30 - 88	100	40
88 - 216	150	43.5
216 – 960	200	46
Above 960	500	54

Above 1GHz(for all device)

Frequency (MHZ)	Class A (dBuV/m) (At 10m)		Class B (dBuV/m) (At 3m)	
	Average	Peak	Average	Peak
Above 1000	49.5	69.5	54	74

- NOTE:** (1) The lower limit shall apply at the transition frequencies.
 (2) Emission level (dBuV/m) = 20 log Emission level (uV/m).
 (3) The measurement above 1GHz is at close-in distances 3m, and determine the limit **L2** corresponding to the close-in distance **d2** by applying the following relation: **L2 = L1 (d1/d2)**, where **L1** is the specified limit in microvolts per metre (**uV/m**) at the distance **d1 (10m)**, **L2** is the new limit for distance **d2 (3m)**.
 So the new Class A limit above 1GHz at 3m is as following table:

Frequency (MHZ)	Class A (dBuV/m) (At 3m)	
	Average	Peak
Above 1000	60	80

According to FCC Part 15.33 (b), for an unintentional radiator, including a digital device, the spectrum shall be investigated from the lowest radio frequency signal generated or used in the device, without going below the lowest frequency for which a radiated emission limit is specified, up to the frequency shown in the following table:

Highest frequency generated or used in the device or on which the device operates or tunes (MHz)	Upper frequency of measurement range (MHz)
Below 1.75	30
1.75-108	1000
108-500	2000
500-1000	5000
Above 1000	5 th harmonic of the highest frequency or 40GHz, whichever is lower

7.2. TEST INSTRUMENTS

Report No.: T120731D03

Open Area Test Site # I				
Name of Equipment	Manufacturer	Model	Serial Number	Calibration Due
MEASURE RECEIVER	SCHAFFNER	SCR3501	461	02/20/2013
SPECTRUM ANALYZER	ADVANTEST	R3132	120900008	No Calibration Required
ANTENNA	SUNOL	JB1	A100209-3	10/03/2012
AMPLIFIER	SCHAFFNER	CPA9231A	3626	10/06/2012
CABLE	EMCI	8Dr	N-TYPE #I5, I6	01/31/2013
THERMO-HYGRO METER	WISEWIND	201A	No. 03	06/12/2013
Test S/W	EZ-EMC			
Above 1GHz Used				
SPECTRUM ANALYZER (9kHz-30GHz)	R&S	FSP 30	100112	10/25/2012
SPECTRUM ANALYZER (9kHz-40GHz)	Agilent	E4446A	MY48250064	01/03/2013
ANTENNA (1-18GHz)	ETS	3117	00139062	10/23/2012
AMPLIFIER (1-26.5GHz)	HP	8449B	3008A01266	12/18/2012
CABLE (1-40GHz)	HUBER +SUHNER	SUCOFLEX 102	33106/2	12/18/2012
CABLE (1-40GHz)	HUBER +SUHNER	SUCOFLEX 102	33633/2	12/18/2012
CABLE (1-26.5GHz)	HUBER +SUHNER	SUCOFLEX 104PEA	33960/4PEA	12/18/2012
THERMO-HYGRO METER	WISEWIND	201A	No. 02	05/14/2013
Test S/W	EZ-EMC			

- NOTE:** 1. The calibration interval of the above test instruments is 12 months and the calibrations are traceable to NML/ROC and NIST/USA.
2. N.C.R = No Calibration Request.

Report No.: T160811D10

Open Area Test Site # J				
Name of Equipment	Manufacturer	Model	Serial Number	Calibration Due
Bilog Antenna	Sunol	JB1	A100209-2	05/22/2017
Cable	EMEC	CFD400NL-LW	N-Type#J9&JA	04/07/2017
EMI Test Receiver	R&S	ESCI	101054	03/24/2017
Pre-Amplifier	Schaffner	CPA9231A	3626	10/01/2016
Thermo-Hygro Meter	Wisewind	201A	No. 04	05/31/2017
Test S/W	EZ-EMC			

- NOTE:** 1. The calibration interval of the above test instruments is 12 months and the calibrations are traceable to NML/ROC and NIST/USA.
 2. N.C.R = No Calibration Request.

7.3. TEST PROCEDURES (please refer to measurement standard or CCS SOP PA-031)

Procedure of Preliminary Test

- The equipment was set up as per the test configuration to simulate typical usage per the user's manual. When the EUT is a tabletop system, a wooden turntable with a height of 0.8 meters is used which is placed on the ground plane. When the EUT is a floor standing equipment, it is placed on the ground plane which has a 12 mm non-conductive covering to insulate the EUT from the ground plane.
- Support equipment, if needed, was placed as per ANSI C63.4.
- All I/O cables were positioned to simulate typical usage as per ANSI C63.4.
- The EUT received AC 120VAC/60Hz power source from the outlet socket under the turntable. All support equipment power received from another socket under the turntable.
- The antenna was placed at 3 or 10 meter away from the EUT as stated in ANSI C63.4. The antenna connected to the Spectrum Analyzer via a cable and at times a pre-amplifier would be used.
- The Analyzer / Receiver quickly scanned from 30MHz to 40GHz. The EUT test program was started. Emissions were scanned and measured rotating the EUT to 360 degrees and positioning the antenna 1 to 4 meters above the ground plane, in both the vertical and the horizontal polarization, to maximize the emission reading level.
- The test mode(s) described in Item 3.1 were scanned during the preliminary test:
- After the preliminary scan, we found the test mode described in Item 3.1 producing the highest emission level.
- The worst configuration of EUT and cable of the above highest emission level were recorded for reference of the final test.

Procedure of Final Test

- EUT and support equipment were set up on the turntable as per the configuration with highest emission level in the preliminary test.
- The Analyzer / Receiver scanned from 30MHz to 40GHz. Emissions were scanned and measured rotating the EUT to 360 degrees, varying cable placement and positioning the antenna 1 or 1 to 4 meters above the ground plane, in both the vertical and the horizontal polarization, to maximize the emission reading level.
- Recording at least the six highest emissions. Emission frequency, amplitude, antenna position, polarization and turntable position were recorded into a computer in which correction factors were used to calculate the emission level and compare reading to the applicable limit. Below 1GHz the Q.P. reading and above 1GHz the Peak and Average reading are presented.
- The test data of the worst-case condition(s) was recorded.

7.4. TEST SETUP

Below 1GHz

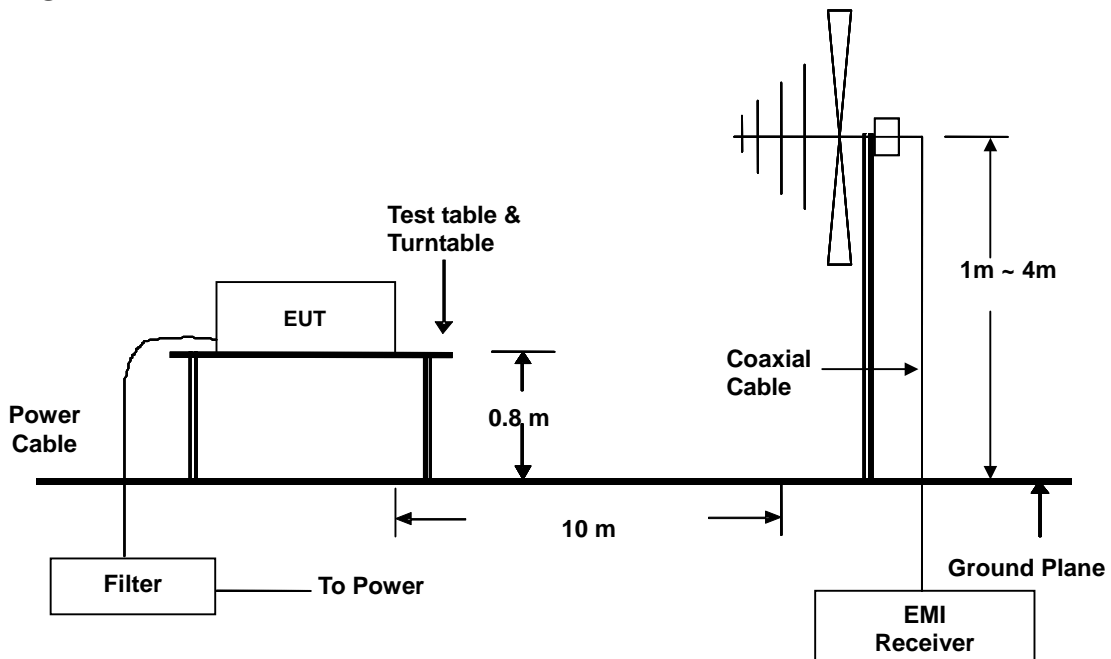

Above 1GHz

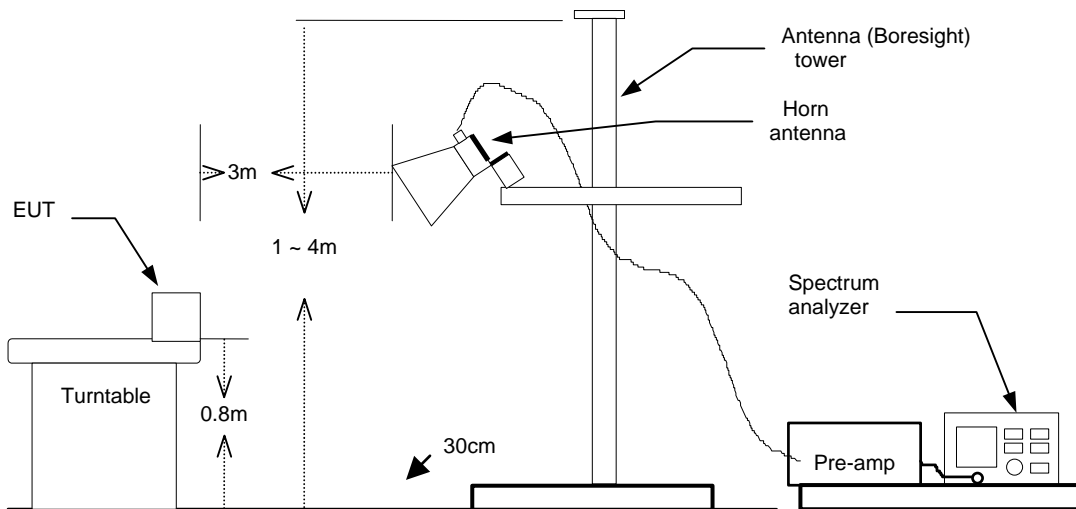

- For the actual test configuration, please refer to the related item – Photographs of the Test Configuration.

7.5. DATA SAMPLE

Below 1GHz

Freq. (MHz)	Reading (dBuV)	Factor (dB/m)	Result (dBuV/m)	Limit (dBuV/m)	Margin (dB)	Detector (P/Q)	Pol. (H/V)
x.xx	14.0	12.2	26.2	40	-13.8	Q	H

Above 1GHz

Freq. (MHz)	Reading (dBuV)	Factor (dB/m)	Result (dBuV/m)	Limit (dBuV/m)	Margin (dB)	Detector (P/A)	Pol. (H/V)
x.xx	42.95	0.55	43.50	60	-16.50	A	H

- Freq. = Emission frequency in MHz
- Reading = Uncorrected Analyzer/Receiver reading
- Factor = Antenna Factor + Cable Loss - Amplifier Gain
- Result = Reading + Factor
- Limit = Limit stated in standard
- Margin = Reading in reference to limit
- P = Peak Reading
- Q = Quasi-peak Reading
- A = Average Reading
- H = Antenna Polarization: Horizontal
- V = Antenna Polarization: Vertical

Calculation Formula

Margin (dB) = Result (dBuV/m) – Limit (dBuV/m)

7.6. TEST RESULTS

Below 1GHz

Model No.	COM-QM77-B10	Test Mode	Mode 2
Environmental Conditions	26°C, 60% RH	6dB Bandwidth	120 kHz
Antenna Pole	Vertical	Antenna Distance	10m
Detector Function	Quasi-peak.	Tested by	Kevin Wang
Standard	FCC CLASS A W/ EN 55022 CLASS A LIMIT		

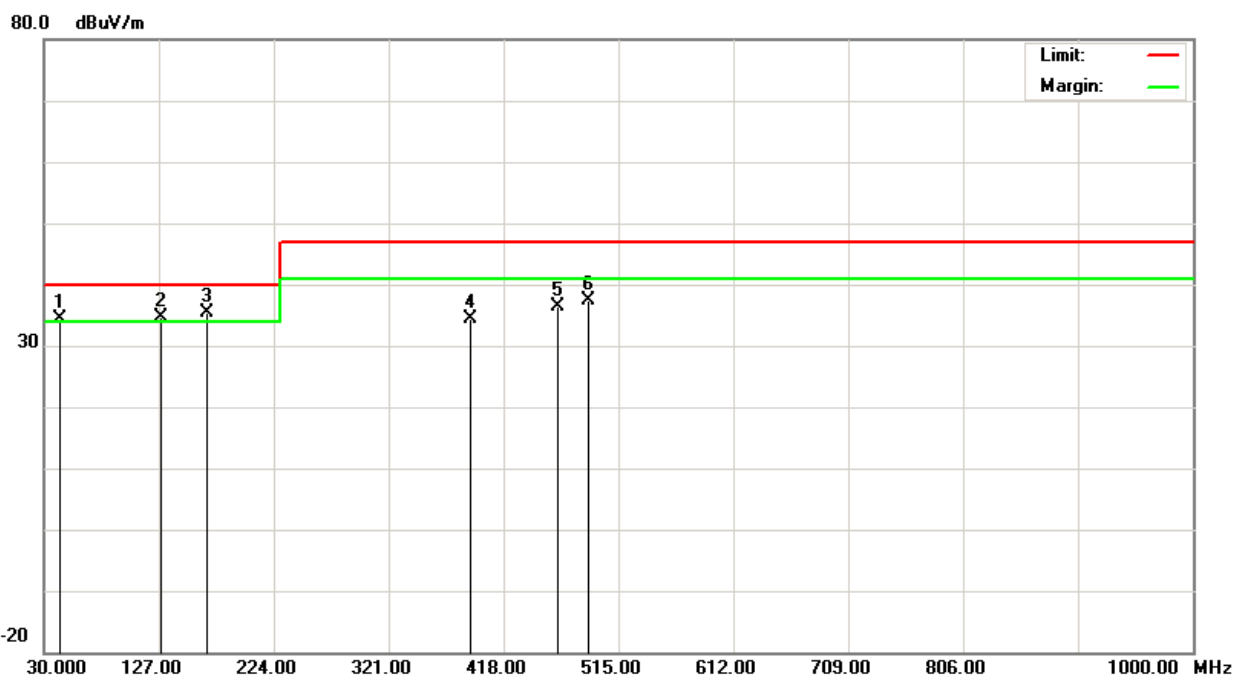

Radiated Emission Readings									
Frequency Range Investigated				30 MHz to 1000 MHz at 10m					
Freq. (MHz)	Reading (dBuV)	Factor (dB/m)	Result (dBuV/m)	Limit (dBuV/m)	Margin (dB)	Height (cm)	Degree (°)	Detector (P/Q)	Pol. (H/V)
43.1300	51.90	-17.64	34.26	40.00	-5.74	100	133	Q	V
129.3200	49.60	-15.00	34.60	40.00	-5.40	100	249	Q	V
168.0000	52.00	-16.61	35.39	40.00	-4.61	100	156	Q	V
390.0200	46.50	-12.01	34.49	47.00	-12.51	100	111	Q	V
463.5400	46.20	-9.93	36.27	47.00	-10.73	400	72	Q	V
489.4400	46.70	-9.23	37.47	47.00	-9.53	400	105	Q	V

Note: 1. 30MHz to 1000MHz test is Applicable CISPR 22 / EN 55022 standard.
2. P= Peak Reading; Q= Quasi-peak Reading.

Model No.	COM-QM77-B10	Test Mode	Mode 2
Environmental Conditions	26°C, 60% RH	6dB Bandwidth	120 kHz
Antenna Pole	Horizontal	Antenna Distance	10m
Detector Function	Quasi-peak.	Tested by	Kevin Wang
Standard	FCC CLASS A W/ EN 55022 CLASS A LIMIT		

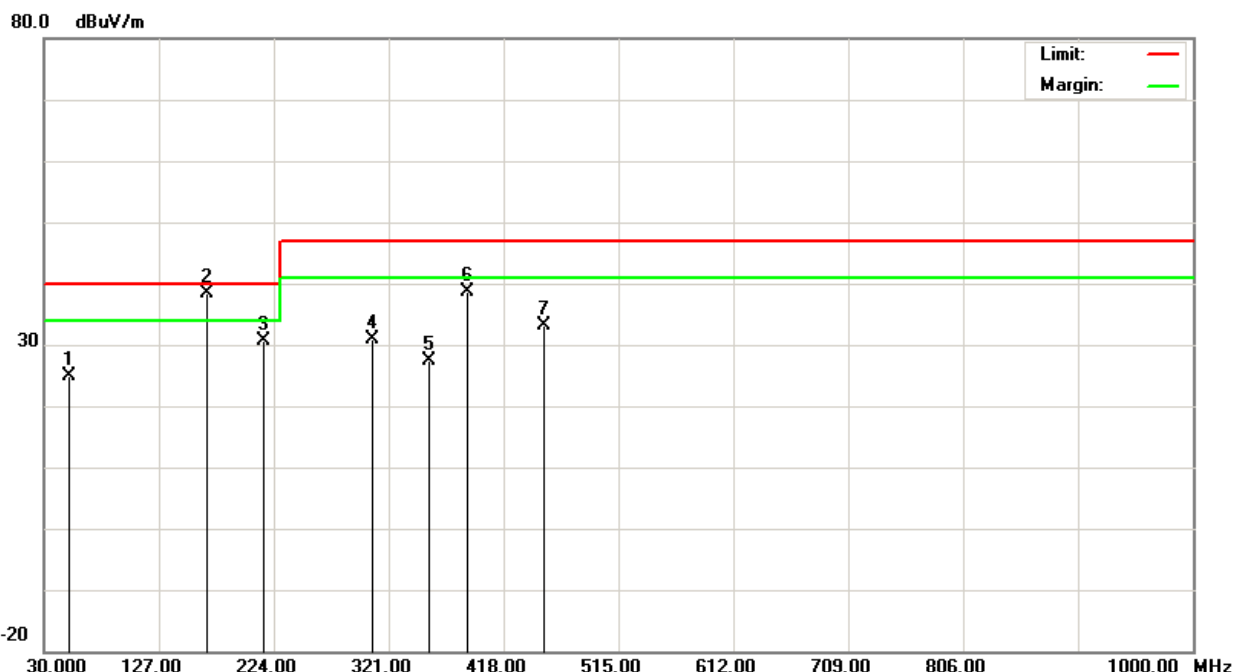

Radiated Emission Readings									
Frequency Range Investigated				30 MHz to 1000 MHz at 10m					
Freq. (MHz)	Reading (dBuV)	Factor (dB/m)	Result (dBuV/m)	Limit (dBuV/m)	Margin (dB)	Height (cm)	Degree (°)	Detector (P/Q)	Pol. (H/V)
51.7500	46.50	-21.60	24.90	40.00	-15.10	400	55	Q	H
168.0000	55.10	-16.61	38.49	40.00	-1.51	400	163	Q	H
215.9800	47.50	-16.84	30.66	40.00	-9.34	400	221	Q	H
307.2600	44.90	-13.99	30.91	47.00	-16.09	400	72	Q	H
355.4400	40.50	-13.18	27.32	47.00	-19.68	400	111	Q	H
387.5900	50.70	-12.09	38.61	47.00	-8.39	400	32	Q	H
452.6300	43.40	-10.23	33.17	47.00	-13.83	100	302	Q	H

Note: 1. 30MHz to 1000MHz test is Applicable CISPR 22 / EN 55022 standard.
2. P= Peak Reading; Q= Quasi-peak Reading.

Above 1GHz

Model No.	COM-QM77-B10	Test Mode	Mode 2
Environmental Conditions	26°C, 60% RH	6dB Bandwidth	1 MHz
Antenna Pole	Vertical / Horizontal	Antenna Distance	3m
Highest frequency generated or used	2500MHz	Upper frequency	12500MHz
Detector Function	Peak or average.	Tested by	Kirin Ho
Standard	FCC CLASS A		

Radiated Emission Readings							
Frequency Range Investigated				Above 1GHz at 3m			
Freq. (MHz)	Reading (dBuV)	Factor (dB/m)	Result (dBuV/m)	Limit (dBuV/m)	Margin (dB)	Detector (P/A)	Pol. (H/V)
1045.000	59.01	-6.79	52.22	80.00	-27.78	P	V
1295.000	57.05	-6.13	50.92	80.00	-29.08	P	V
1720.000	53.39	-3.59	49.80	80.00	-30.20	P	V
1995.000	52.59	-1.08	51.51	80.00	-28.49	P	V
2120.000	54.96	-0.85	54.11	80.00	-25.89	P	V
2455.000	54.70	-0.34	54.36	80.00	-25.64	P	V

Radiated Emission Readings							
Frequency Range Investigated				Above 1GHz at 3m			
Freq. (MHz)	Reading (dBuV)	Factor (dB/m)	Result (dBuV/m)	Limit (dBuV/m)	Margin (dB)	Detector (P/A)	Pol. (H/V)
1320.000	52.92	-6.06	46.86	80.00	-33.14	P	H
1515.000	52.50	-5.45	47.05	80.00	-32.95	P	H
1840.000	53.35	-2.50	50.85	80.00	-29.15	P	H
1995.000	52.68	-1.08	51.60	80.00	-28.40	P	H
2120.000	53.34	-0.85	52.49	80.00	-27.51	P	H
2315.000	54.37	-0.55	53.82	80.00	-26.18	P	H

Note: 1. P= Peak Reading; A= Average Reading.

8 PHOTOGRAPHS OF THE TEST CONFIGURATION CONDUCTED EMISSION TEST



RADIATED EMISSION TEST

