

FCC CLASS A COMPLIANCE REPORT (Verification)

for

Electromagnetic Emissions

of

Industrial PC

Trade Name : N/A
Model Number : AMB-551
Serial Number : N/A
Report Number : 02E0207-D
Date : Jun 06, 2002

Prepared for :
AAEON Technology Inc.
5F, No. 135, Lane 235, Pao Chiao Rd., Hsin-Tien City,
Taipei, Taiwan, R. O. C.



Prepared by :
C&C LABORATORY, CO., L3TD.
#B1, 1st Fl., Universal Center,
No. 183, Sec. 1, Tatung Rd., Hsi Chih,
Taipei Hsien, Taiwan, R.O.C.
TEL: (02)8642-2071~3
FAX: (02)8642-2256

**This report shall not be reproduced, except in full, without the written approval of
C&C Laboratory, Co., Ltd.**

TABLE OF CONTENTS

DESCRIPTION	PAGE
VERIFICATION OF COMPLIANCE	3
SYSTEM DESCRIPTION	4
PRODUCT INFORMATION	5
SUPPORT EQUIPMENT	6
MEASUREMENT PROCEDURE & LIMIT (LINE CONDUCTED EMISSION TEST)	7
MEASUREMENT PROCEDURE & LIMIT (RADIATED EMISSION TEST)	9
SUMMARY DATA	11
TEST FACILITY	13
TEST EQUIPMENT	14
BLOCK DIAGRAM OF TEST SETUP	15
APPENDIX 1 PHOTOGRAPHS (TEST SETUP OF LINE CONDUCTED EMISSION TEST)	16
APPENDIX 2 PHOTOGRAPHS (TEST SETUP OF RADIATED EMISSION TEST)	18
APPENDIX 3 PHOTOGRAPHS OF EUT	20
APPENDIX 4 CONDUCTED EMISSION PLOT & RADIATED EMISSION DATA	25

VERIFICATION OF COMPLIANCE

Equipment Under Test: Industrial PC
Trade Name: N/A
Model Number: AMB-551
Serial Number: N/A
Applicant: **AAEON Technology Inc.**
5F, No. 135, Lane 235, Pao Chiao Rd., Hsin-Tien City,
Taipei, Taiwan, R. O. C.
Manufacturer: **AAEON Technology Inc.**
5F, No. 135, Lane 235, Pao Chiao Rd., Hsin-Tien City,
Taipei, Taiwan, R. O. C.
Type of Test: FCC Class A (Verification)
Measurement Procedure: ANSI C63.4: 1992 / EN55022
File Number: 02E0207-D
Date of test: Jun 04, 2002
Deviation: None
Condition of Test Sample: Normal

The above equipment was tested by C&C Laboratory, Co., Ltd. for compliance with the requirements set forth in the FCC Rules and Regulations Part 15, Subpart B and the measurement procedure according to ANSI C63.4. This said equipment in the configuration described in this report shows the maximum emission levels emanating from equipment are within the compliance requirements.

The test results of this report relate only to the tested sample identified in this report.

Responsible Party

Vince Chiang For.

Authorized Signatory

Officer of the Responsible Party

SYSTEM DESCRIPTION

EUT Test Procedure:

1. Windows 98 Boots System.
2. Run Winemc.Exe To Activate All Peripherals And Display “H” Pattern On Monitor Screen.
3. Run Readwrite.exe To Link EUT and Server PC. Data Through the EUT and Transmit Between PC Systems and server PC RJ45 Cable.

PRODUCT INFORMATION

Housing Type:	Plastic w/ metal plate
EUT Power Rating:	DC +3.3V/±5V/±12V from Host Computer
AC power during Test:	120VAC, 60Hz to Host PC Power Supply
Power Supply Manufacturer:	PRT
Power Supply Model Number:	PRM400
AC Power Cord Type:	Unshielded, 1.8m (Detachable)
EUT I/O Cable:	Shielded, 0.2m (Detachable)
CPU Frequencies:	Pentium 850MHz (8.5 x 100MHz)

I/O Port of EUT:

I/O PORT TYPES	Q'TY	TESTED WITH
1). USB Port	2	2
2). PS/2 Port	1	1
3). RJ45 Port	2	1
4). Serial Port	1	1
5). DB15 Port (VGA)	1	1
6). Parallel Port	1	1
7). Phone Jack	1	1

Note: N/A

SUPPORT EQUIPMENT

EUT Device:

Equipment	Model#	Serial#	Trade Name
CPU(Pentium - 850MHz)	N/A	N/A	INTEL
MAIN BOARD	SBC-676 Ver: A1.0	N/A	N/A
BACKPLANE	PCI-5S Ver: G1	N/A	N/A
LCD (TFT 15")	FLC38XGC6V-06	N/A	FUJITSU
CD-ROM(52X)	N/A	N/A	AFREEY
HDD	4D040K2	N/A	Maxtor
RAM(128MB; PC-100)	D456484165-A80-9JF	N/A	NEC

External Peripheral Devices:

No	Equipment	Model #	Serial #	FCC ID	Trade Name	Data Cable	Power Cord
1.	USB MOUSE	M-BE58	LZE20232357	DoC BSMI3892A471	LOGITECH	Shielded, 1.9m	N/A
2.	USB MOUSE.	M-BE58	LZE20302460	DoC BSMI3892A471	LOGITECH	Shielded, 1.9m	N/A
3.	PS/2 MOUSE	M-S34	LZA13454288	DZL211029 BSMI4862A011	LOGITECH	Shielded, 1.9m	N/A
4.	PS/2 KEYBOARD	6311-TW4C/6	N/A	BSMI4862A064	ACER	Shielded, 1.7m	N/A
5.	LCD MONITOR	RB17NS	N/A	DoC BSMI3902B332	SAMSUNG	Shielded, 1.8m with two cores	Unshielded, 1.8m with a core
6.	PRINTER	EPSONSTYLUS C20SX	DW4E126671	BSMI3902E004	EPSON	Shielded, 1.8 m	Unshielded, 1.8m
7.	MODEM	2496CF	N/A	N/A	DATATRONIC S	Shielded, 1.4 m	Unshielded, 1.8m
8.	EAR.	MSB-206	N/A	N/A	E.SENSE	Unshielded, 2.3 m	N/A
9.	SERVER PC	EVOD300	6K1BKF83F0ZP	N/A	COMPAQ	N/A	N/A
10.	LAN CABLE LOAD	N/A	N/A	N/A	N/A	N/A	N/A

Note: All the above equipment/cables were placed in worse case positions to maximize emission signals.

Grounding: Grounding was in accordance with the manufacturer's requirements and conditions for the intended use.

MEASUREMENT PROCEDURE (PRELIMINARY LINE CONDUCTED EMISSION TEST)

- 1) The equipment was set up as per the test configuration to simulate typical actual usage per the user's manual. When the EUT is a tabletop system, a wooden table with a height of 0.8 meters is used and is placed on the ground plane as per ANSI C63.4 (see Test Facility for the dimensions of the ground plane used). When the EUT is a floor-standing equipment, it is placed on the ground plane which has a 3-12 mm non-conductive covering to insulate the EUT from the ground plane.
- 2) Support equipment, if needed, was placed as per ANSI C63.4.
- 3) All I/O cables were positioned to simulate typical actual usage as per ANSI C63.4.
- 4) The EUT received DC +3.3V/±5V/±12V power through HOST PC and Line Impedance Stabilization Network (LISN) which supplied power source of 120VAC/ 60Hz and was grounded to the ground plane.
- 5) All support equipment received power from a second LISN supplying power of 110VAC/60Hz, if any.
- 6) The EUT test program was started. Emissions were measured on each current carrying line of the EUT using a spectrum Analyzer / Receiver connected to the LISN powering the EUT. The LISN has two monitoring points: Line 1 (Hot Side) and Line 2 (Neutral Side). Two scans were taken: one with Line 1 connected to Analyzer / Receiver and Line 2 connected to a 50 ohm load; the second scan had Line 1 connected to a 50 ohm load and Line 2 connected to the Analyzer / Receiver.
- 7) Analyzer / Receiver scanned from 150kHz to 30MHz for emissions in each of the test modes.
- 8) During the above scans, the emissions were maximized by cable manipulation.
- 9) The following test mode(s) were scanned during the preliminary test:

Mode(s):

No.	Mode of operation	Date	Data Report/Plot No.
1	800 X 600	06/04/2002	0207C#(08)
2	1024 X 768	06/04/2002	0207C#(16)
3	1600 X 1200	06/04/2002	0207C#(35, 38)

- 10) After the preliminary scan, we found the following test mode(s) producing the highest emission level.

Mode: 3

Then, the EUT configuration and cable configuration of the above highest emission level were recorded for reference of final testing.

MEASUREMENT PROCEDURE (FINAL LINE CONDUCTED EMISSION TEST)

- 1) EUT and support equipment was set up on the test bench as per step 10 of the preliminary test.
- 2) A scan was taken on both power lines, Line 1 and Line 2, recording at least the six highest emissions. Emission frequency and amplitude were recorded into a computer in which correction factors were used to calculate the emission level and compare reading to the applicable limit. If EUT emission level was less -2dB to the A.V. limit in Q.P. mode, then the emission signal was re-checked using an Average detector.
- 3) The test data of the worst case condition(s) was reported on the Summary Data page.

Data Sample:

Freq (MHz)	Meter Reading (dBuV)	C.F. (dB)	Corrected Reading (dBuV)	Limits (dBuV)	Margin (dB)	Reading Type (P/Q/A)	Line (L1/L2)
x.xx	x.xx	x.xx	48.38	66.00	-17.62	A	L1

C.F.(Correction Factor)=Insertion Loss + Cable Loss

Corrected Reading = Metering Reading + C.F.

Margin=Corrected Reading - Limits

P=Peak Reading

L1=Hot

Q=Quasi-peak

L2=Neutral

A=Average Reading

Comments: N/A

LINE CONDUCTED EMISSION LIMIT

Frequency	Maximum RF Line Voltage	
	Q.P.	AVERAGE
150kHz-500kHz	79dBuV	66dBuV
500kHz-5MHz	73dBuV	60dBuV
5MHz-30MHz	73dBuV	60dBuV

Note: The lower limit shall apply at the transition frequency.

MEASUREMENT PROCEDURE (PRELIMINARY RADIATED EMISSION TEST)

- 1) The equipment was set up as per the test configuration to simulate typical actual usage per the user's manual. When the EUT is a tabletop system, a wooden turntable with a height of 0.8 meters is used which is placed on the ground plane as per ANSI C63.4 (see Test Facility for the dimensions of the ground plane used). When the EUT is a floor-standing equipment, it is placed on the ground plane which has a 3-12 mm non-conductive covering to insulate the EUT from the ground plane.
- 2) Support equipment, if needed, was placed as per ANSI C63.4.
- 3) All I/O cables were positioned to simulate typical actual usage as per ANSI C63.4.
- 4) The EUT received DC +3.3V/±5V/±12V power source from HOST PC (120VAC/ 60Hz) and outlet socket under the turntable. All support equipment received 110VAC/60Hz to power from another socket under the turntable, if any.
- 5) The antenna was placed at 10 meter away from the EUT as stated in ANSI C63.4: 1992. The antenna connected to the Analyzer via a cable and at times a pre-amplifier would be used.
- 6) The Analyzer / Receiver quickly scanned from 30MHz to 5000MHz. The EUT test program was started. Emissions were scanned and measured rotating the EUT to 360 degrees and positioning the antenna 1 to 4 meters above the ground plane, in both the vertical and the horizontal polarization, to maximize the emission reading level.
- 7) The following test mode(s) were scanned during the preliminary test:

Mode(s):

No.	Mode of operation	Date	Data Report/Plot No.
1	800 X 600	06/04/2002	0207D#(04)
2	1024 X 768	06/04/2002	0207D#(03)
3	1600 X 1200	06/04/2002	0207D#(05, 06)
4	1-5GHz	06/04/2002	0207B#(19, 22)

- 8) After the preliminary scan, we found the following test mode(s) producing the highest emission level.

Mode: 3.

Then, the EUT and cable configuration, antenna position, polarization and turntable position of the above highest emission level were recorded for reference of final testing.

MEASUREMENT PROCEDURE (FINAL RAIDATED EMISSION TEST)

- 1) EUT and support equipment were set up on the turntable as per step 8 of the preliminary test.
- 2) The Analyzer / Receiver scanned from 30MHz to 1000MHz. Emissions were scanned and measured rotating the EUT to 360 degrees, varying cable placement and positioning the antenna 1 to 4 meters above the ground plane, in both the vertical and the horizontal polarization, to maximize the emission reading level.
- 3) Recorded at least the six highest emissions. Emission frequency, amplitude, were recorded into a computer (The antenna position, polarization and turntable position were kept in raw data file) in which correction factors were used to calculate the emission level and compare reading to the applicable limit.
- 4) The test data of the worst case condition(s) was reported on the Summary Data page.

Data Sample:

Freq (MHz)	Meter Reading (dBuV)	C.F. (dB/m)	Corrected Reading (dBuV/m)	Limits (dBuV/m)	Margin (dB)	Reading Type P/Q/A	Pol. H/V
x.xx	x.xx	x.xx	40.82	47.00	-6.18	P	V

C.F.(Correction Factor)=Antenna Factor + Cable Loss + Attenuator(3/6 dB) - Amplifier Gain

Corrected Reading = Metering Reading + C.F.

Margin=Corrected Reading – Limits

P=Peak Reading

H=Horizontal Polarization/Antenna

Q=Quasi-peak

V=Vertical Polarization/Antenna

A=Average Reading

Comments: N/A

RADIATED EMISSION LIMIT

Frequency (MHz)	Distance (m)	Maximum Field Strength Limit (dBu V/m/ Q.P.)
30-230	10	40
230-1000	10	47

Note: The lower limit shall apply at the transition frequency.

SUMMARY DATA (LINE CONDUCTED TEST)

Model Number: AMB-551

Location: Conducted Room

Tested by: STANLEY HUANG

Test Model: Mode 3

Test Results: Passed

Temperature: 25

Humidity: 71%RH

(The chart below shows the highest readings taken from the final data)

Frequency Range Investigated (150 kHz TO 30 MHz)							
Freq (MHz)	Meter Reading (dBuV)	C.F. (dB)	Corrected Reading (dBuV)	Limits (dBuV)	Margin (dB)	Reading Type (P/Q/A)	Line (L1/L2)
0.158	54.97	0.03	55.00	79.00	-24.00	P	L1
0.178	55.37	0.03	55.40	79.00	-23.60	P	L1
0.233	49.31	0.04	49.35	79.00	-29.65	P	L1
0.158	54.75	0.03	54.78	79.00	-24.22	P	L2
0.178	55.85	0.03	55.88	79.00	-23.12	P	L2
0.233	48.91	0.04	48.95	79.00	-30.05	P	L2

C.F.(Correction Factor)=Insertion Loss + Cable Loss

Corrected Reading = Metering Reading + C.F.

Margin=Corrected Reading - Limits

P=Peak Reading L1=Hot

Q=Quasi-peak L2=Neutral

A=Average Reading

Comments: N/A

SUMMARY DATA (RADIATED EMISSION TEST)

Model Number: AMB-551

Location: Site # D

Tested by: STANLEY HUANG

Polar: Vertical / Horizontal- 10m

Test Mode: Mode 3

Test Results: Passed

Temperature: 26

Humidity: 73%RH

(The chart below shows the highest readings taken from the final data)

Frequency Range Investigated (30 MHz TO 5000 MHz)							
Freq (MHz)	Meter Reading (dBuV)	C.F. (dB/m)	Corrected Reading (dBuV/m)	Limits (dBuV/m)	Margin (dB)	Reading Type P/Q/A	Pol. H/V
33.406	45.88	-9.84	36.04	40.00	-3.96	P	V
144.333	42.32	-5.38	36.94	40.00	-3.06	Q	V
492.839	38.69	4.20	42.89	47.00	-4.11	P	V
501.209	38.05	4.31	42.36	47.00	-4.64	P	V
143.981	41.48	-5.38	36.10	40.00	-3.90	Q	H
175.890	41.48	-5.79	35.69	40.00	-4.31	P	H

C.F.(Correction Factor)=Antenna Factor + Cable Loss - Amplifier Gain (+ Attenuator 6dB)

Corrected Reading = Metering Reading + C.F.

Margin=Corrected Reading - Limits

P=Peak Reading

H=Horizontal Polarization/Antenna

Q=Quasi-peak

V=Vertical Polarization/Antenna

A=Average Reading

Comments: N/A

TEST FACILITY

- Location:** No. 199, Chung Sheng Road, Hsin Tien City,
Taipei, Taiwan, R. O. C.
- Description:** There are two 3/10m open area test sites and one line conducted lab for final test
The Open Area Test Sites and the Line Conducted labs are constructed and calibrated to meet the FCC requirements in documents ANSI C63.4: 1992 and CISPR 22/EN 55022 requirements.
- Site Filing:** A site description is on file with the Federal Communications Commission, 7435 Oakland Mills Road, Columbia, MD 21046.

Registration also was made with Voluntary Control Council for Interference (VCCI).
- Site Accreditation:** Accredited by A2LA (Certificate #: 824.01) for EMC.

Also accredited by BSMI for the product category of Information Technology Equipment.
- Instrument Tolerance:** All measuring equipment is in accord with ANSI C63.4 and CISPR 22 requirements that meet industry regulatory agency and accreditation agency requirement.
- Ground Plane:** Two conductive reference ground planes were used during the Line Conducted Emission, one in vertical and the other in horizontal. The dimensions of these ground planes are as below. The vertical ground plane was placed distancing 40 cm to the rear of the wooden test table on where the EUT and the support equipment were placed during test. The horizontal ground plane projected 50 cm beyond the footprint of the EUT system and distanced 80 cm to the wooden test table. For Radiated Emission Test, one horizontal conductive ground plane extended at least 1m beyond the periphery of the EUT and the largest measuring antenna, and covered the entire area between the EUT and the antenna. It has no holes or gaps having longitudinal dimensions larger than one-tenth of a wavelength at the highest frequency of measurement up to 1GHz.

TEST EQUIPMENT LIST

Instrumentation: The following list contains equipment used at C & C Laboratory, Co., Ltd. for testing. The equipment conforms to the CISPR 16-1 / ANSI C63.2-1988 Specifications for Electromagnetic Interference and Field Strength Instrumentation from 10kHz to 1.0GHz or above.

Equipment used during the tests:

Open Area Test Site: #D

EQUIPMENT TYPE	MFR	MODEL NUMBER	SERIAL NUMBER	LAST CAL.	CAL. DUE
EMI TEST DISPLAY	R&S	DSAI-D 804.8932.52	827832/001	10/29/01	10/28/02
EMI TEST RF UNIT	R&S	ESBI-RF/1005.4300.52	827832/003	10/29/01	10/28/02
AMPLIFIER	HP	8447DB	1644A02328	05/05/02	05/04/03
ANTENNA	SCHWARZBECK	VULB 9160	3104	05/12/02	05/11/03
CABLE	TIME MICROWAVE	LMR-400	N-TYPE02	07/09/01	07/08/02
ANTENNA (1-18GHz)	EMCO	3115	5761	02/22/02	02/21/03
AMPLIFIER (1-26.5GHz)	HP	8449B	3008A01266	01/30/02	01/29/03
CABLE (1-18GHz)	JYEBAO	N30-L142-1/9	N/A	05/01/02	04/30/03
CABLE (1-18GHz)	HUBER+SUHNE R	SUCOFLEX 104	N/A	05/01/02	04/30/03

Conducted Emission Test Site: Conducted Room

EQUIPMENT TYPE	MFR	MODEL NUMBER	SERIAL NUMBER	LAST CAL.	CAL. DUE
TEST RECEIVER	R&S	ESHS20	840455/006	03/16/02	03/15/03
LISN	SOLAR	8012-50-R-24-BNC	8305114	07/23/01	07/22/02
LISN(EUT)	EMCO	3825/2	1435	01/16/02	01/15/03

The calibrations of the measuring instruments, including any accessories that may effect such calibration, are checked frequently to assure their accuracy. Adjustments are made and correction factors applied in accordance with instructions contained in the manual for the measuring instrument.

BLOCK DIAGRAM OF TEST SETUP

System Diagram of Connections between EUT and Simulators

EUT: Industrial PC
Trade Name: N/A
Model Number: AMB-551

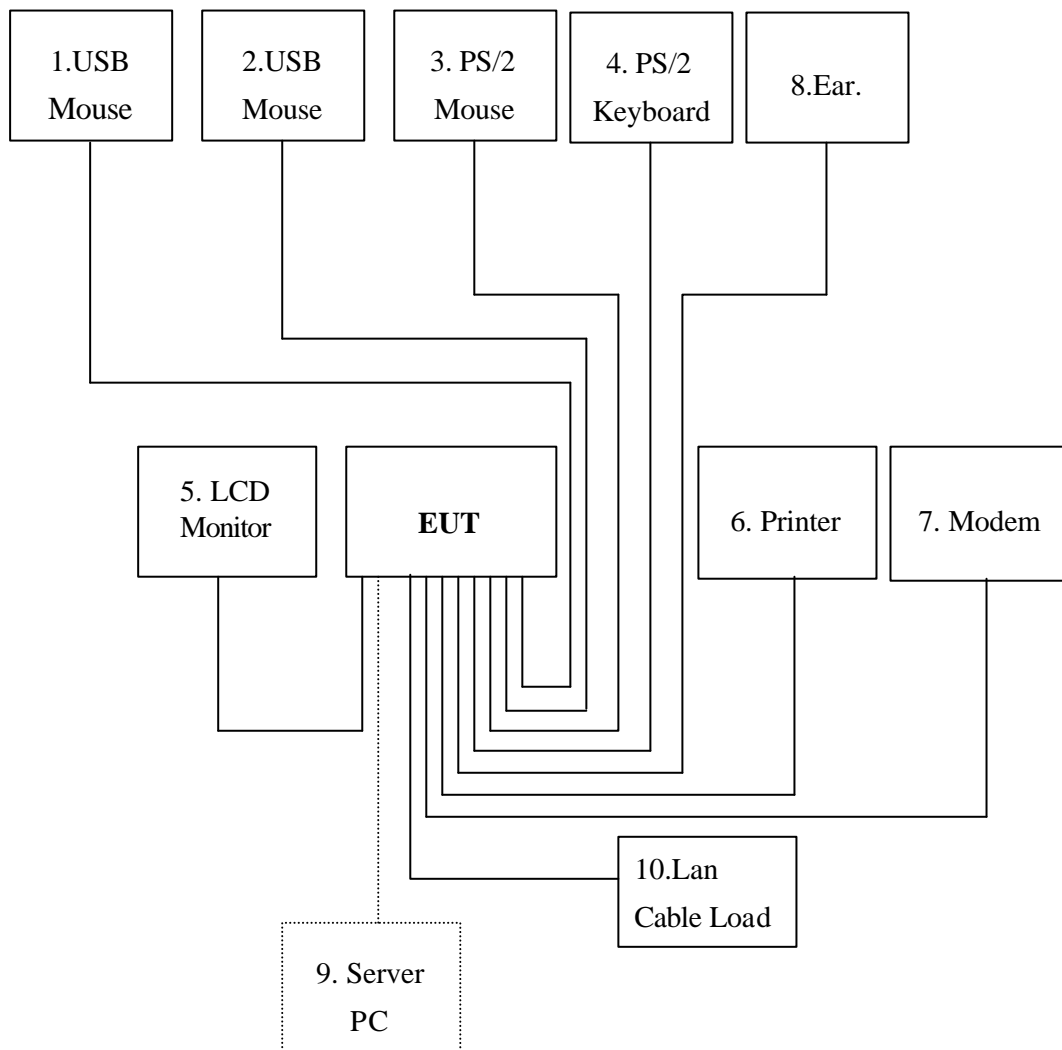

APPENDIX 1

PHOTOGRAPHS OF TEST SETUP (TEST SETUP OF LINE CONDUCTED EMISSION)

LINE CONDUCTED EMISSION TEST



APPENDIX 2

PHOTOGRAPHS OF TEST SETUP (TEST SETUP OF LINE RADIATED EMISSION)

RADIATED EMISSION TEST

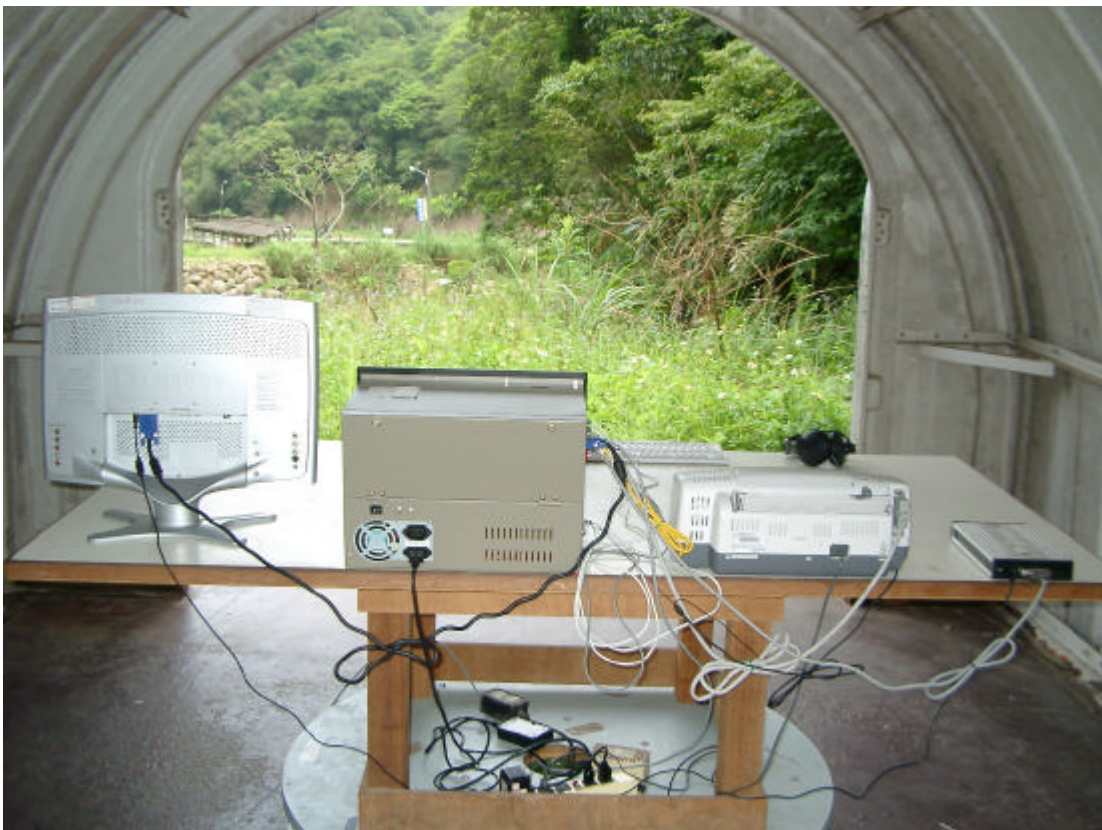

APPENDIX 3

PHOTOGRAPHS OF EUT







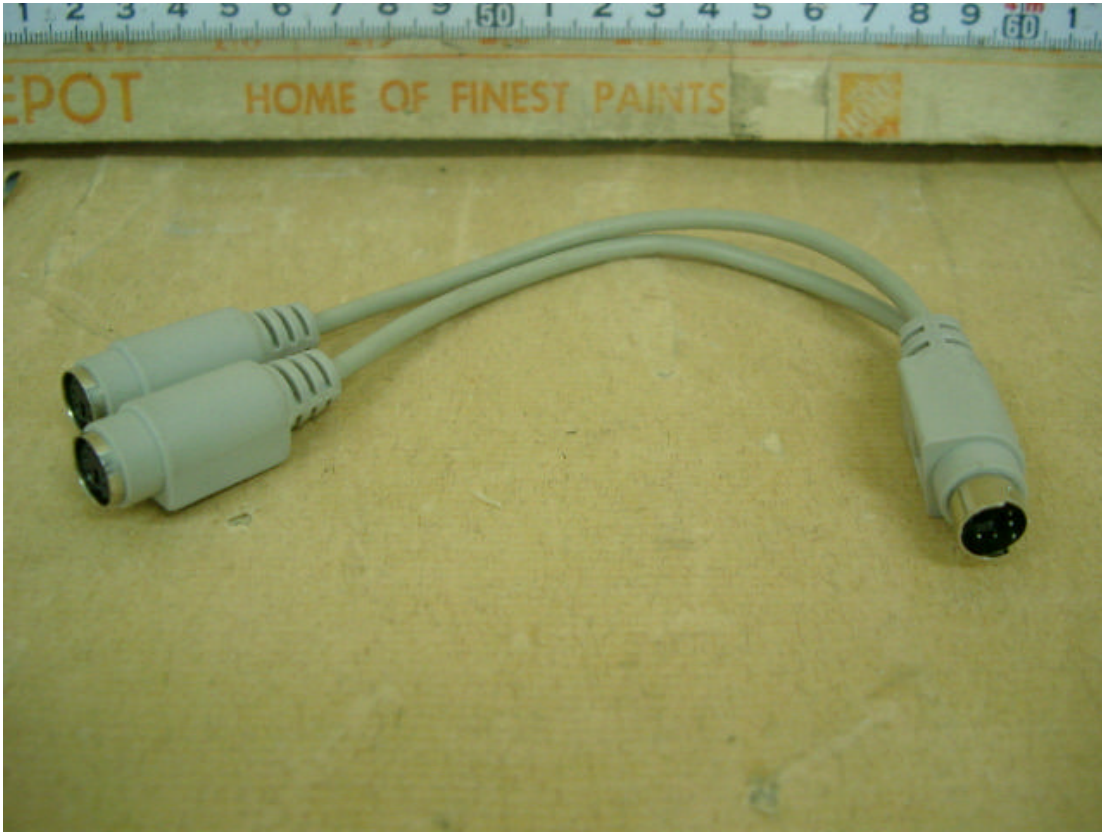

APPENDIX 4

CONDUCTED EMISSION PLOT RADIATED EMISSION DATA

Data#: 35 File#: 0207c.emi

Date: 2002-06-04 Time: 18:20:37

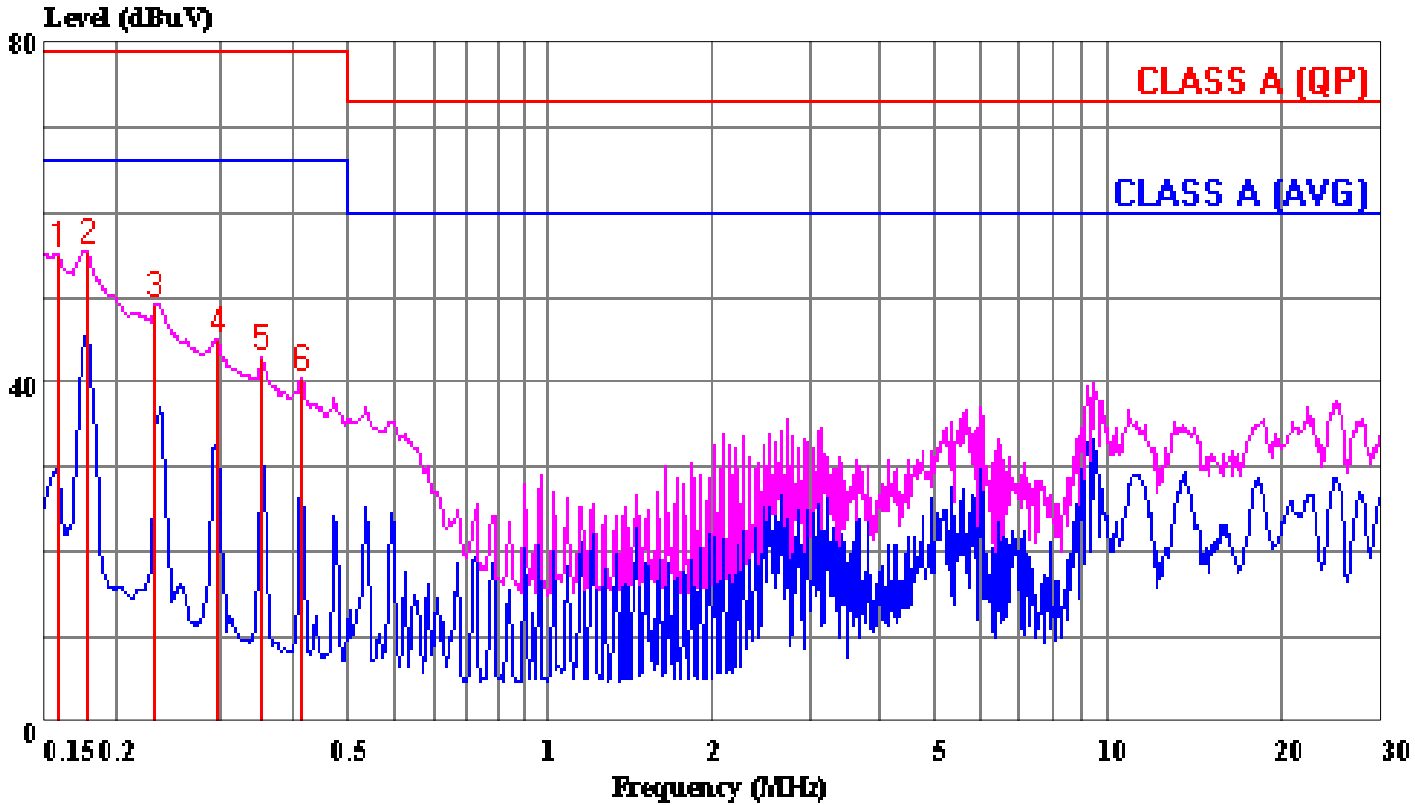

(Conducted)

Trace: 23 24

Ref Trace:

Condition: LINE
Report No. : 02E0207
Test Engr. : STANLEY HUANG
Company : AAEON TECHNOLOGY INC.
EUT : AMB-551
Test Config : EUT/ALL PERIPHERALS
Type of Test: FCC CLASS A W/ EN 55022 CLASS A LIMIT
Mode of Op. : 1600 X 1200(WORST)

Page: 1

	Read Freq	Read Level	Factor	Level	Limit Line	Over Limit	Remark
	MHz	dBuV	dB	dBuV	dBuV	dB	
1	0.158	54.97	0.03	55.00	79.00	-24.00	Peak
2	0.178	55.37	0.03	55.40	79.00	-23.60	Peak
3	0.233	49.31	0.04	49.35	79.00	-29.65	Peak
4	0.299	45.11	0.05	45.16	79.00	-33.84	Peak
5	0.354	42.79	0.05	42.84	79.00	-36.16	Peak
6	0.415	40.41	0.06	40.47	79.00	-38.53	Peak

Data#: 38 File#: 0207c.emi

Date: 2002-06-04 Time: 18:21:58

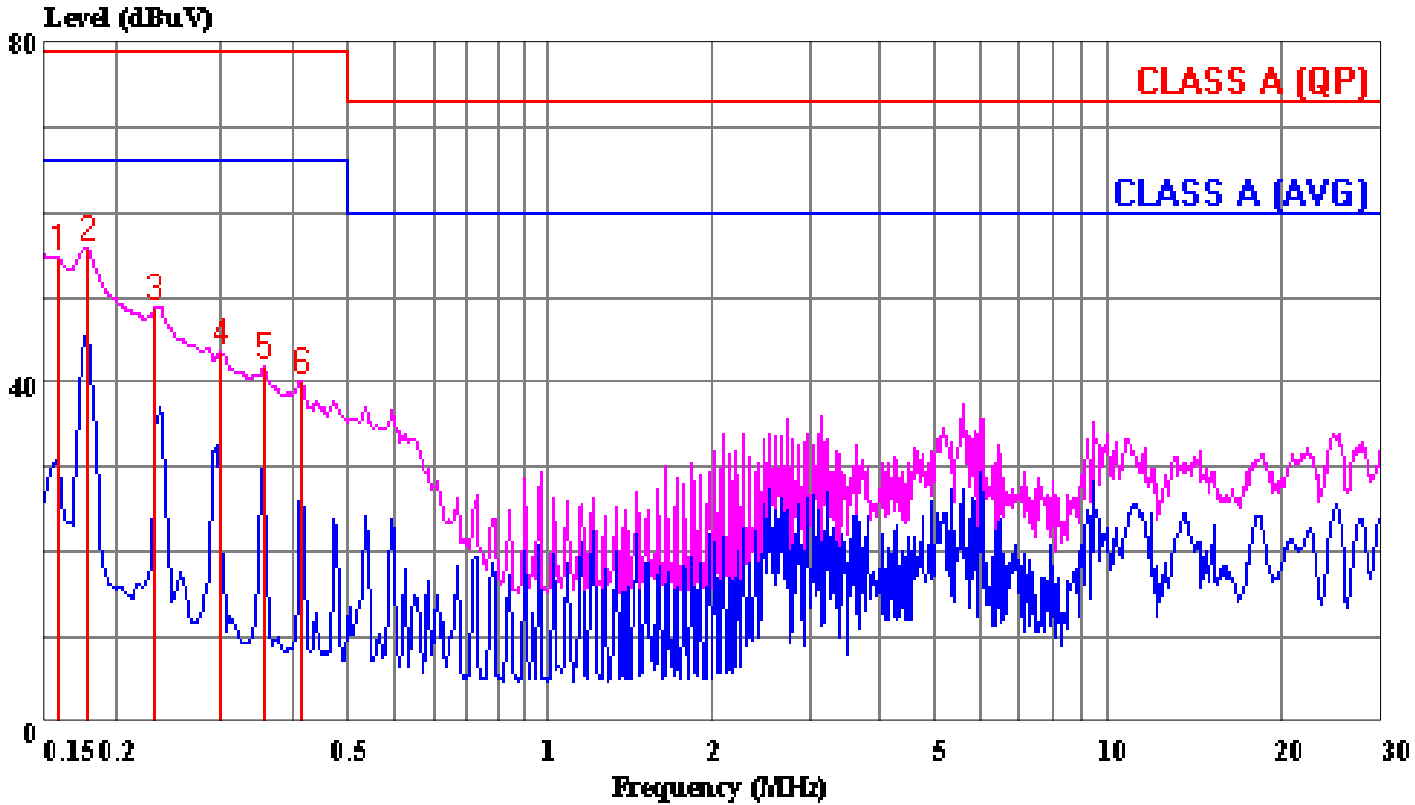

(Conducted)

Trace: 31 32

Ref Trace:

Condition: NEUTRAL
Report No. : 02E0207
Test Engr. : STANLEY HUANG
Company : AAEON Technology Inc.
EUT : AMB-551
Test Config : EUT/ALL PERIPHERALS
Type of Test: FCC CLASS A W/ EN 55022 CLASS A LIMIT
Mode of Op. : 1600 X 1200(WORST)

Page: 1

	Read Freq	Read Level	Factor	Level	Limit Line	Over Limit	Remark
	MHz	dBuV	dB	dBuV	dBuV	dB	
1	0.158	54.75	0.03	54.78	79.00	-24.22	Peak
2	0.178	55.85	0.03	55.88	79.00	-23.12	Peak
3	0.233	48.91	0.04	48.95	79.00	-30.05	Peak
4	0.302	43.43	0.05	43.48	79.00	-35.52	Peak
5	0.358	41.89	0.05	41.94	79.00	-37.06	Peak
6	0.415	40.00	0.06	40.06	79.00	-38.94	Peak

Data#: 5 File#: 0207d.emi
D-Site

Date: 2002-06-04 Time: 11:23:37

Condition: VERTICAL /10m
Report No. : 02E0207
Test Engr. : STANLEY HUANG
Company : AAEON Technology Inc.
EUT : AMB-551
Test Config : EUT/ALL PERIPHERALS
Type of Test: FCC CLASS A W/ EN 55022 CLASS A LIMIT
Mode of Op. : 1600 X 1200(WORST)

Page: 1

	Freq	Read Level	Factor	Level	Limit Line	Over Limit	Remark
	MHz	dBuV	dB	dBuV/m	dBuV/m	dB	
1	33.406	45.88	-9.84	36.04	40.00	-3.96	Peak
2	133.644	39.98	-6.06	33.92	40.00	-6.08	Peak
3	144.333	42.32	-5.38	36.94	40.00	-3.06	QP
4	175.922	36.73	-5.79	30.94	40.00	-9.06	Peak
5	195.411	42.22	-7.72	34.50	40.00	-5.50	Peak
6	217.111	38.61	-7.00	31.61	40.00	-8.39	Peak
7	300.778	43.46	-2.02	41.44	47.00	-5.56	Peak
8	492.839	38.69	4.20	42.89	47.00	-4.11	Peak
9	501.209	38.05	4.31	42.36	47.00	-4.64	Peak

Data#: 6 File#: 0207d.emi
D-Site

Date: 2002-06-04 Time: 13:57:53

Condition: HORIZONTAL /10m
Report No. : 02E0207
Test Engr. : STANLEY HUANG
Company : AAEON Technology Inc.
EUT : AMB-551
Test Config : EUT/ALL PERIPHERALS
Type of Test: FCC CLASS A W/ EN 55022 CLASS A LIMIT
Mode of Op. : 1600 X 1200(WORST)

Page: 1

	Freq	Read Level	Factor	Level	Limit Line	Over Limit	Remark
	MHz	dBuV	dB	dBuV/m	dBuV/m	dB	
1	33.412	35.62	-9.84	25.78	40.00	-14.22	Peak
2	133.644	36.12	-6.06	30.06	40.00	-9.94	Peak
3	143.981	41.48	-5.38	36.10	40.00	-3.90	QP
4	175.890	41.48	-5.79	35.69	40.00	-4.31	Peak
5	195.428	38.84	-7.72	31.12	40.00	-8.88	Peak
6	217.589	35.90	-6.93	28.97	40.00	-11.03	Peak
7	300.722	41.48	-2.02	39.46	47.00	-7.54	Peak
8	492.822	32.87	4.20	37.07	47.00	-9.93	Peak
9	501.202	31.53	4.31	35.84	47.00	-11.16	Peak

Data#: 19 File#: 0207b.emi

Date: 2002-06-04 Time: 07:40:03

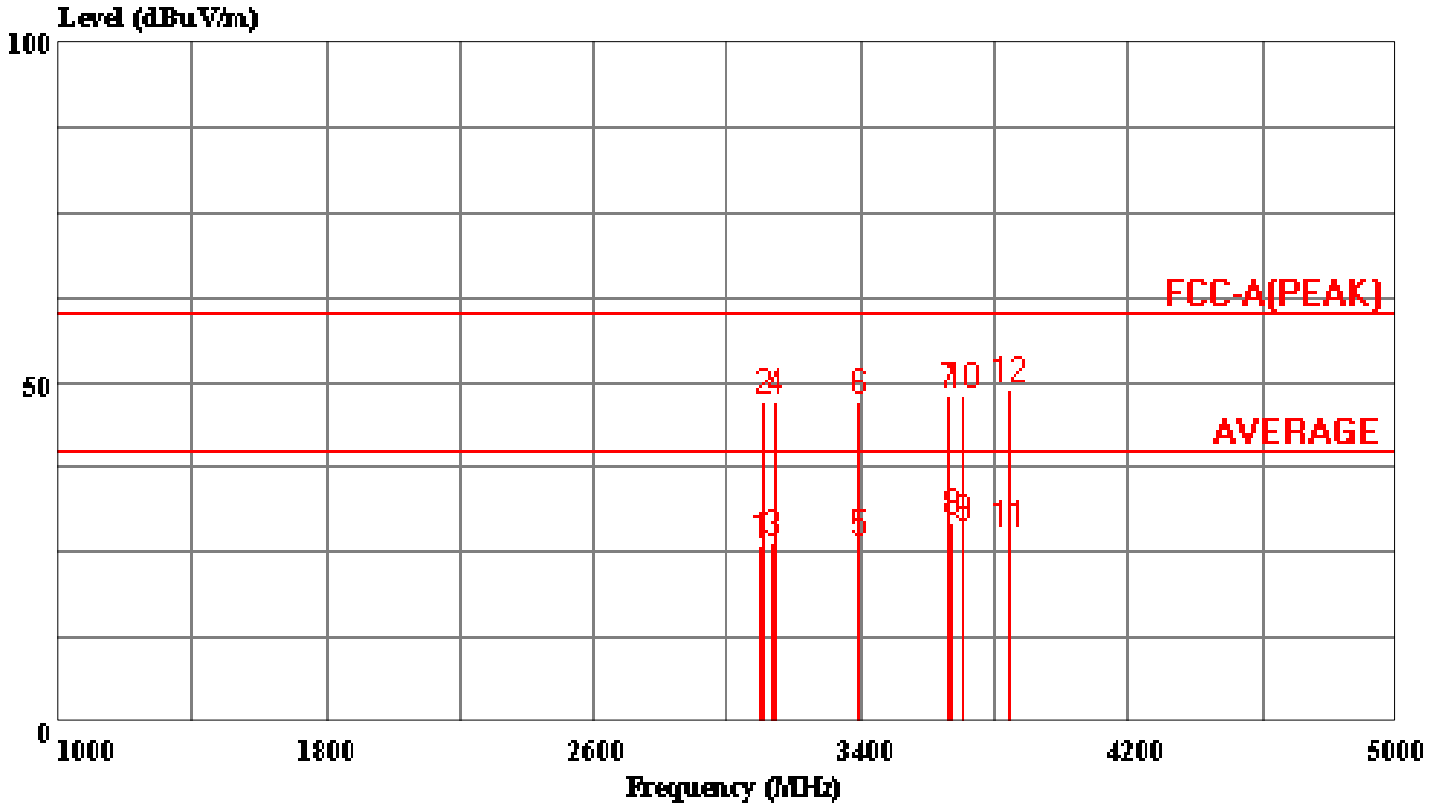

(Chamber)

Trace:

Ref Trace:

Condition: VERTICAL /3m
Report No. : 02E0207
Test Engr. : STANLEY HUANG
Company : AAEON TECHNOLOGY INC.
EUT : AMB-551
Test Config : EUT /ALL PERIPHERALS
Type of Test: FCC CLASS A
Mode of Op. : 1G~5G

Page: 1

	Read		Limit	Over		
Freq	Level	Factor	Level	Line	Limit	Remark
MHz	dBuV	dB	dBuV/m	dBuV/m	dB	
1 !	3101.550	25.77	0.36	26.13	40.00	-13.87 Average
2 !	3103.700	46.73	0.36	47.10	60.00	-12.90 Peak
3 !	3135.690	25.97	0.48	26.45	40.00	-13.55 Average
4 !	3139.400	46.83	0.49	47.32	60.00	-12.68 Peak
5 !	3389.250	25.10	1.44	26.54	40.00	-13.46 Average
6 !	3391.400	45.89	1.44	47.33	60.00	-12.67 Peak
7 !	3664.400	45.44	2.63	48.07	60.00	-11.93 Peak
8 !	3666.410	26.82	2.63	29.45	40.00	-10.55 Average
9 !	3701.890	25.60	2.81	28.41	40.00	-11.59 Average
10 !	3702.200	45.43	2.81	48.24	60.00	-11.76 Peak
11 !	3840.850	24.42	3.47	27.89	40.00	-12.11 Average
12 !	3842.900	45.33	3.47	48.80	60.00	-11.20 Peak

Data#: 22 File#: 0207b.emi

Date: 2002-06-04 Time: 07:35:01

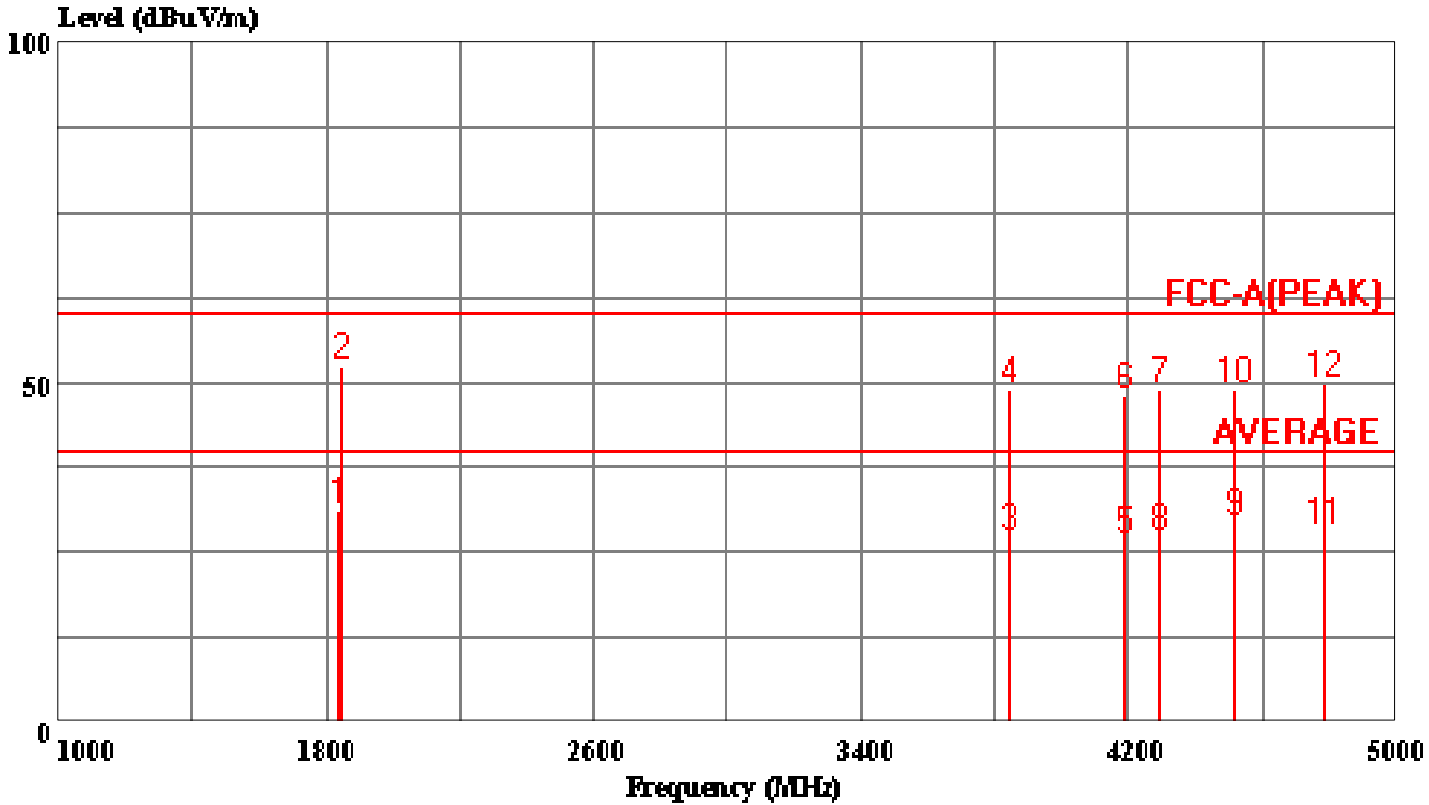

(Chamber)

Trace:

Ref Trace:

Condition: HORIZONTAL /3m
Report No. : 02E0207
Test Engr. : STANLEY HUANG
Company : AAEON TECHNOLOGY INC.
EUT : AMB-551
Test Config : EUT /ALL PERIPHERALS
Type of Test: FCC CLASS A
Mode of Op. : 1G~5G

Page: 1

	Read		Limit	Over		
Freq	Level	Factor	Level	Line	Limit	Remark
MHz	dBuV	dB	dBuV/m	dBuV/m	dB	
1 ! 1841.800	36.18	-4.97	31.21	40.00	-8.79	Average
2 ! 1843.600	57.26	-4.97	52.29	60.00	-7.71	Peak
3 ! 3840.500	23.93	3.47	27.40	40.00	-12.60	Average
4 ! 3842.900	45.52	3.47	48.99	60.00	-11.01	Peak
5 ! 4185.360	22.65	4.26	26.91	40.00	-13.09	Average
6 ! 4187.300	43.75	4.26	48.01	60.00	-11.99	Peak
7 ! 4292.300	44.58	4.31	48.89	60.00	-11.11	Peak
8 ! 4294.440	23.10	4.31	27.41	40.00	-12.59	Average
9 ! 4514.450	25.07	4.47	29.54	40.00	-10.46	Average
10 ! 4514.900	44.30	4.47	48.78	60.00	-11.22	Peak
11 ! 4785.310	22.81	5.33	28.14	40.00	-11.86	Average
12 ! 4787.900	44.43	5.33	49.76	60.00	-10.24	Peak