



FCC Test Report

Issued Date : Nov. 08, 2010
Project No. : E1010026
Equipment : Fanless embedded controller
Model Name : xxxxxAEC-6612-xxxxxxx (Where x is 0-9, A-Z, - or blank) for marketing purpose; xxxxxAEC-6612-xyyxxxxx (Where y is M or blank, x is 0-9, A-Z, - or blank) for marketing purpose

Applicant : AAEON Technology Inc.
Address : 5F, No. 135, Lane 235, Pao Chiao Rd.,
Hsin-Tien City, Taipei, Taiwan, R.O.C.

Tested by: Neutron Engineering Inc. EMC Laboratory
Date of Receipt: Oct. 12, 2010
Date of Test: Oct. 12, 2010 ~ Nov. 06, 2010

Testing Engineer: Peter Li
(Peter Li)

Technical Manager: Jeff Yang
(Jeff Yang)

Authorized Signatory: Andy Chiu
(Andy Chiu)

Neutron Engineering Inc.
B1, No. 37, Lane 365, YangGuang St.,
NeiHu District 114, Taipei, Taiwan.
TEL: +886-2-2657-3299
FAX: +886-2-2657-3331





Declaration

Neutron represents to the client that testing is done in accordance with standard procedures as applicable and that test instruments used has been calibrated with the standards traceable to National Measurement Laboratory (**NML**) of **R.O.C.**, or National Institute of Standards and Technology (**NIST**) of **U.S.A.**

Neutron's reports apply only to the specific samples tested under conditions. It is manufacture's responsibility to ensure that additional production units of this model are manufactured with the identical electrical and mechanical components. **Neutron** shall have no liability for any declarations, inferences or generalizations drawn by the client or others from **Neutron** issued reports.

Neutron's reports must not be used by the client to claim product endorsement by the authorities or any agency of the Government.

This report is the confidential property of the client. As a mutual protection to the clients, the public and **Neutron-self**, extracts from the test report shall not be reproduced except in full with **Neutron's** authorized written approval.

Neutron's laboratory quality assurance procedures are in compliance with the **ISO Guide 17025** requirements, and accredited by the conformity assessment authorities listed in this test report.

Limitation

For the use of the authority's logo is limited unless the Test Standard(s)/Scope(s)/Item(s) mentioned in this test report is (are) included in the conformity assessment authorities acceptance respective.



Table of Contents	Page
1 . CERTIFICATION	4
2 . SUMMARY OF TEST RESULTS	5
2.1 TEST FACILITY	6
2.2 MEASUREMENT UNCERTAINTY	6
3 . GENERAL INFORMATION	7
3.1 GENERAL DESCRIPTION OF EUT	7
3.2 DESCRIPTION OF TEST MODES	8
3.3 BLOCK DIAGRAM SHOWING THE CONFIGURATION OF SYSTEM TESTED	9
3.4 DESCRIPTION OF SUPPORT UNITS	10
4 . EMC EMISSION TEST	11
4.1 CONDUCTED EMISSION MEASUREMENT	11
4.1.1 POWER LINE CONDUCTED EMISSION	11
4.1.2 MEASUREMENT INSTRUMENTS LIST	11
4.1.3 TEST PROCEDURE	12
4.1.4 DEVIATION FROM TEST STANDARD	12
4.1.5 TEST SETUP	12
4.1.6 EUT OPERATING CONDITIONS	13
4.1.7 TEST RESULTS	14
4.2 RADIATED EMISSION MEASUREMENT	18
4.2.1 LIMITS OF RADIATED EMISSION MEASUREMENT	18
4.2.2 MEASUREMENT INSTRUMENTS LIST	19
4.2.3 TEST PROCEDURE	19
4.2.4 DEVIATION FROM TEST STANDARD	19
4.2.5 TEST SETUP	20
4.2.6 EUT OPERATING CONDITIONS	20
4.2.7 TEST RESULTS-BETWEEN 30MHZ AND 1000MHZ	21
4.2.8 TEST RESULTS-ABOVE 1000MHZ	25
5 . EUT TEST PHOTO	29



1. CERTIFICATION

Equipment : Fanless embedded controller

Brand Name : AAEON

Model Name : xxxxxAEC-6612-xxxxxxx (Where x is 0-9, A-Z, - or blank) for marketing purpose; xxxxxAEC-6612-xyxxxxx (Where y is M or blank, x is 0-9, A-Z, - or blank) for marketing purpose

Applicant : AAEON Technology Inc.

Date of Test : Oct. 12, 2010 ~ Nov. 06, 2010

Standards : FCC Part 15, Subpart B Class A

CISPR 22: 2005 +A1: 2005 Class A

ICES-003: 2004 Class A

ANSI C63.4 (2003)

The above equipment has been tested and found compliance with the requirement of the relative standards by Neutron Engineering Inc. EMC Laboratory.

The test data, data evaluation, and equipment configuration contained in our test report (Ref No. NEI-FCCE-1-E1010026) were obtained utilizing the test procedures, test instruments, test sites that has been accredited by the Authority of NVLAP and TAF according to the ISO-17025 quality assessment standard and technical standard(s).



2. SUMMARY OF TEST RESULTS

Test procedures according to the technical standards:

Emission				
Standard	Test Item	Limit	Judgment	Remark
FCC Part 15, Subpart B CISPR 22: 2005 +A1: 2005 ICES-003: 2004	Conducted Emission	Class A	PASS	
	Radiated Emission	Class A	PASS	

NOTE:

(1) " N/A" denotes test is not applicable in this Test Report.



2.1 TEST FACILITY

The test facilities used to collect the test data in this report:

- C01:** (VCCI RN: C-2918; T-1666)
No.132-1, Lane 329, Sec. 2, Palian Road, Shijr City, Taipei, Taiwan.
- CB08:** (VCCI RN: G-91; FCC RN: 614388; IC Assigned Code: 4428C)
1F., No. 61, Ln. 77, Sing-ai Rd., Neihs Dist., Taipei City 114, Taiwan (R.O.C.)
- OS02:** (VCCI RN: R-2669)
No.132-1, Lane 329, Sec. 2, Palian Road, Shijr City, Taipei, Taiwan.

2.2 MEASUREMENT UNCERTAINTY

The reported uncertainty of measurement $y \pm U$, where expanded uncertainty U is based on a standard uncertainty multiplied by a coverage factor of $k=2$, providing a level of confidence of approximately **95%**.

The measurement instrumentation uncertainty considerations contained in CISPR 16-4-2.

A. Conducted Measurement :

Test Site	Method	Measurement Frequency Range	U , (dB)	NOTE
C01	ANSI	150 kHz ~ 30 MHz	1.94	

B. Radiated Measurement :

Test Site	Method	Measurement Frequency Range	Ant. H / V	U , (dB)	NOTE
OS-02	ANSI	30 MHz ~ 200 MHz	V	2.48	
		30 MHz ~ 200 MHz	H	2.16	
		200 MHz ~ 1, 000 MHz	V	2.50	
		200 MHz ~ 1, 000 MHz	H	2.66	

Our calculated Measurement Instrumentation Uncertainty is shown in the tables above. These are our U_{lab} values in CISPR 16-4-2 terminology.

Since Table 1 of CISPR 16-4-2 has values of measurement instrumentation uncertainty, called U_{CISPR} , as follows:

Conducted Disturbance (mains port) – 150 kHz – 30 MHz : 3.6 dB

Radiated Disturbance (electric field strength on an open area test site or alternative test site) – 30 MHz – 1000 MHz : 5.2 dB

It can be seen that our U_{lab} values are smaller than U_{CISPR} .



3. GENERAL INFORMATION

3.1 GENERAL DESCRIPTION OF EUT

Equipment	Fanless embedded controller
Brand Name	AAEON
Model Name	xxxxxAEC-6612-xxxxxxx (Where x is 0-9, A-Z, - or blank) for marketing purpose; xxxxAEC-6612-xyxxxxx (Where y is M or blank, x is 0-9, A-Z, - or blank) for marketing purpose
OEM Brand/Model Name	N/A
Model Difference	Please refer to Note 2.
Product Description	The EUT is a Fanless embedded controller. Based on the application, features, or specification exhibited in User's Manual, the EUT is considered as an ITE/Computing Device. More details of EUT technical specification, please refer to the User's Manual.
Power Source	DC Voltage supplied from AC/DC Adapter.
Power Rating	Please refer to Note 2.
Connecting I/O Port(s)	Please refer to the User's Manual
Products Covered	Please refer to Note 2.
EUT Modification(s)	N/A

Note:

1. For a more detailed features description, please refer to the manufacturer's specifications or the User's Manual.
2. All models are based on similar electrical circuit except the difference of list below:

Model Name	xxxxxAEC-6612-xxxxxxx	xxxxxAEC-6612-xyxxxxx
Main Board	GENE-LN05-xxxxxx (Where x is 0-9, A-Z, - or blank) for marketing purpose	
CPU	Intel ATOM D510 1.6GHZ	
Memory	APACER DDR2 667 2GB	DSL DDR2 667 1GB
HDD	Fujitsu MHZ2160BH 160GB	None
CFD	None	Transcend 4GB
DC-DC Power Board	None	LITEMAX PW06012VA01 I/P: DC 9-30V / O/P: DC 12V/5A 60Watt
AC/DC Adapter	FSP FSP060-DBAB1 I/P: AC 100-240V 1.5A 50-60Hz / O/P: DC 12.0V 5.0A MAX (60W MAX)	
AC/DC Adapter Connector Type	DC Jack	Terminal Block
Port: COM3	Yes	None
Port: COM4	Yes	None

All the above models were tested and used for final testing and collecting test data included in this report.



3.2 DESCRIPTION OF TEST MODES

To investigate the maximum EMI emission characteristics generates from EUT, the test system was pre-scanning tested base on the consideration of following EUT operation mode or test configuration mode which possible have effect on EMI emission level. Each of these EUT operation mode(s) or test configuration mode(s) mentioned above was evaluated respectively.

Pretest Test Mode	Description
Mode 1	FULL SYSTEM D-SUB 1920*1080/60Hz (xxxxxAEC-6612-xxxxxxx)
Mode 2	FULL SYSTEM D-SUB 1920*1080/60Hz (xxxxxAEC-6612-xyxxxxx)

For Conducted Test	
Final Test Mode	Description
Mode 1	FULL SYSTEM D-SUB 1920*1080/60Hz (xxxxxAEC-6612-xxxxxxx)
Mode 2	FULL SYSTEM D-SUB 1920*1080/60Hz (xxxxxAEC-6612-xyxxxxx)

For Radiated Test	
Final Test Mode	Description
Mode 1	FULL SYSTEM D-SUB 1920*1080/60Hz (xxxxxAEC-6612-xxxxxxx)
Mode 2	FULL SYSTEM D-SUB 1920*1080/60Hz (xxxxxAEC-6612-xyxxxxx)



3.3 BLOCK DIAGRAM SHOWING THE CONFIGURATION OF SYSTEM TESTED

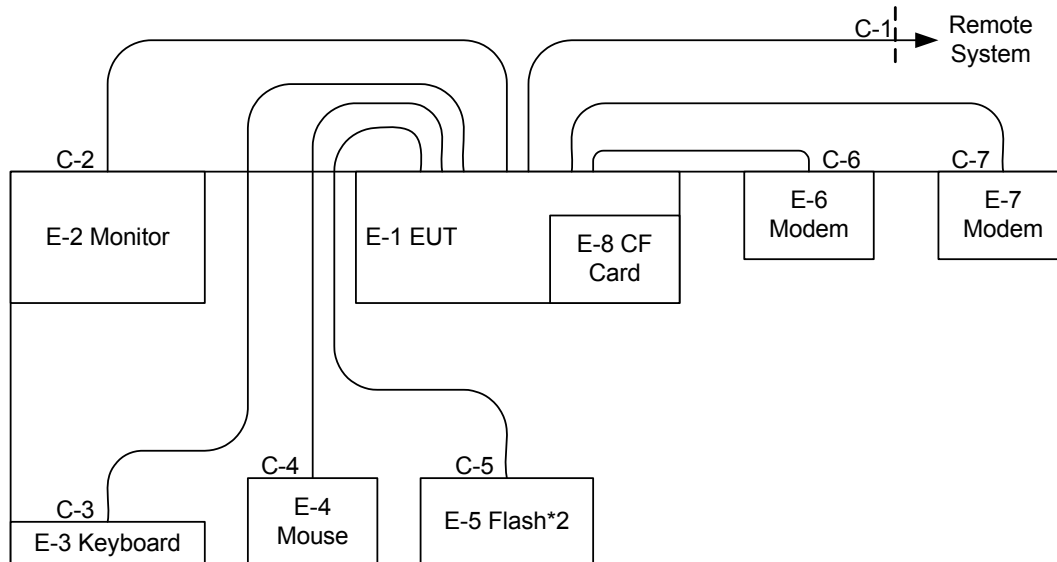

- C-1 RJ-45 Cable*2
- C-2 D-Sub Cable
- C-3 USB Cable
- C-4 USB Cable
- C-5 USB Cable*2
- C-6 RS232 Cable
- C-7 RS232 Cable



3.4 DESCRIPTION OF SUPPORT UNITS

The EUT has been tested as an independent unit together with other necessary accessories or support units. The following support units or accessories were used to form a representative test configuration during the tests.

Item	Equipment	Mfr/Brand	Model/Type No.	FCC ID	Series No.	Note
E-1	Fanless embedded controller	AAEON	xxxxxAEC-6612-xxxxxxx; xxxxxAEC-6612-xyxxxxx	N/A	N/A	EUT
E-2	24" LCD Monitor	DELL	2408WFPb	DOC	071863-11	
E-3	USB K/B	Microsoft	1366	DOC	0065801864873	
E-4	USB Mouse	Logitech	M-BT83	DOC	810-000361	
E-5	USB Flash Drives	Silicon Power	SP004GBUF2M01V1K	DOC	N/A	
E-6	Modem	Intel	PCFM6501	EJMPCFM6501	306925-002	
E-7	Modem	ACEEX	DM-1414V	DOC	8041708	
E-8	CompactFlash Card	PQI	FC064	DOC	5Q63D	

Item	Shielded Type	Ferrite Core	Length	Note
C-1	NO	NO	10.0M	
C-2	YES	YES	1.8M	
C-3	YES	NO	1.7M	
C-4	YES	NO	1.8M	
C-5	YES	NO	1.7M	
C-6	YES	NO	1.7M	
C-7	YES	NO	1.7M	

Note:

- (1) The support equipment was authorized by Declaration of Conformity.
- (2) For detachable type I/O cable should be specified the length in cm in 『Length』 column.



4. EMC EMISSION TEST

4.1 CONDUCTED EMISSION MEASUREMENT

4.1.1 POWER LINE CONDUCTED EMISSION (FREQUENCY RANGE 150 KHZ-30MHZ)

FREQUENCY (MHz)	Class A (dBuV)		Class B (dBuV)	
	Quasi-peak	Average	Quasi-peak	Average
0.15 -0.5	79.00	66.00	66 - 56 *	56 - 46 *
0.50 -5.0	73.00	60.00	56.00	46.00
5.0 -30.0	73.00	60.00	60.00	50.00

Note:

- (1) The tighter limit applies at the band edges.
- (2) The limit of " * " marked band means the limitation decreases linearly with the logarithm of the frequency in the range.
- (3) The test result calculated as following:
 Measurement Value = Reading Level + Correct Factor
 Correct Factor = Insertion Loss + Cable Loss + Attenuator Factor(if use)
 Margin Level = Measurement Value – Limit Value

4.1.2 MEASUREMENT INSTRUMENTS LIST

Item	Kind of Equipment	Manufacturer	Type No.	Serial No.	Calibrated until
1	LISN	EMCO	3816/2	00042991	Feb. 07, 2011
2	Test Cable	TIMES	LMR-400	SR03_C_01& 02	Aug. 20, 2011
3	Pulse Limiter	Electro-Metrics	EM-7600	112644	Dec. 27, 2010
4	EMI Test Receiver	R&S	ESCI	100082	Mar. 16, 2011
5	50Ω BNC TYPE Terminator	N/A	N/A	01	May 25, 2011
6	50Ω BNC TYPE Terminator	N/A	N/A	03	May 25, 2011
7	LISN	EMCO	4825/2	00028234	Jul. 22, 2011

Remark: " N/A" denotes No Model Name , Serial No. or No Calibration specified.

4.1.3 TEST PROCEDURE

- a. The EUT was placed 0.8 meters from the horizontal ground plane with EUT being connected to the power mains through a line impedance stabilization network (LISN). All other support equipments powered from additional LISN(s). The LISN provide 50 Ohm/ 50uH of coupling impedance for the measuring instrument.
- b. Interconnecting cables that hang closer than 40 cm to the ground plane shall be folded back and forth in the center forming a bundle 30 to 40 cm long.
- c. I/O cables that are not connected to a peripheral shall be bundled in the center. The end of the cable may be terminated, if required, using the correct terminating impedance. The overall length shall not exceed 1 m.
- d. LISN at least 80 cm from nearest part of EUT chassis.
- e. For the actual test configuration, please refer to the related Item –EUT Test Photos.

4.1.4 DEVIATION FROM TEST STANDARD

No deviation

4.1.5 TEST SETUP

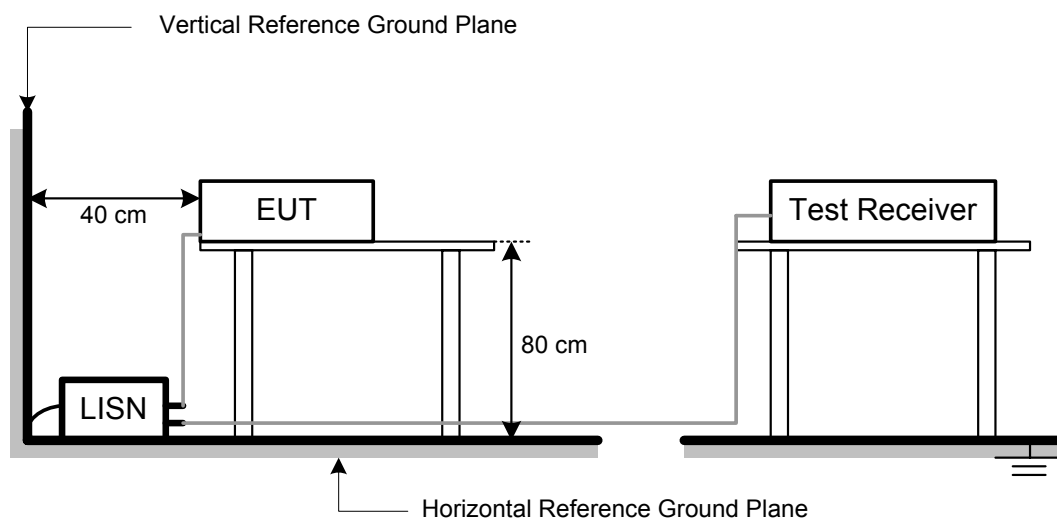



4.1.6 EUT OPERATING CONDITIONS

The EUT exercise program (EMC.exe) used during radiated and/or conducted emission measurement was designed to exercise the various system components in a manner similar to a typical use. The program contained on a PC hard disk and is auto-starting on power-up. Once loaded, the program sequentially exercises each system component in turn. The sequence used is:

1. Read (write) from (to) mass storage device (HDD - Flash).
2. Send "H" pattern to video port device (Monitor).
3. Send/Receive data to/from remote system (RJ 45 Port).
4. Send " H " pattern to serial port device (Modem).
5. Repeated from 2 to 4 continuously.

As the keyboard and mouse are strictly input devices, no data is transmitted to (from) them during test. They are, however, continuously scanned for data input activity.



4.1.7 TEST RESULTS

E.U.T :	Fanless embedded controller	Model Name :	xxxxxAEC-6612-xxxxxxx
Temperature :	25 °C	Relative Humidity :	42%
Test Voltage :	AC 120V/60Hz		
Test Mode :	FULL SYSTEM D-SUB 1920*1080/60Hz (xxxxAEC-6612-xxxxxxx)		

Freq. (MHz)	Terminal L/N	Reading Level(dBuV)		Correct Factor(dB)	Measurement(dBuV)		Limit(dBuV)		Margin (dB)	Note
		QP-Mode	AV-Mode		QP-Mode	AV-Mode	QP-Mode	AV-Mode		
0.1507	Line	42.05	*	9.72	51.77	*	79.00	66.00	-27.23	(QP)
0.1878	Line	40.20	*	9.71	49.91	*	79.00	66.00	-29.09	(QP)
0.2571	Line	34.76	*	9.70	44.46	*	79.00	66.00	-34.54	(QP)
0.3075	Line	30.45	*	9.69	40.14	*	79.00	66.00	-38.86	(QP)
13.6500	Line	24.29	*	10.01	34.30	*	73.00	60.00	-38.70	(QP)
19.4500	Line	23.53	*	10.13	33.66	*	73.00	60.00	-39.34	(QP)

Remark:

- (1) Reading in which marked as QP means measurements by using are Quasi-Peak Mode with Detector BW=9 kHz; SPA setting in RBW=10 kHz, VBW =10 kHz, Swp. Time = 0.2 sec./ MHz. Reading in which marked as AV means measurements by using are Average Mode with instrument setting in RBW=10 kHz, VBW=10 kHz, Swp. Time =0.2 sec./ MHz.
- (2) All readings are QP Mode value unless otherwise stated AVG in column of Note. If the QP Mode Measured value compliance with the QP Limits and lower than AVG Limits, the EUT shall be deemed to meet both QP & AVG Limits and then only QP Mode was measured, but AVG Mode didn't perform. In this case, a " * " marked in AVG Mode column of Interference Voltage Measured.
- (3) In the "Note" column, QP means the margin value of QP is higher than Average and the "Margin" column shows the margin value of QP; AV means the margin value of Average is higher than QP and the "Margin" column shows the margin value of Average.

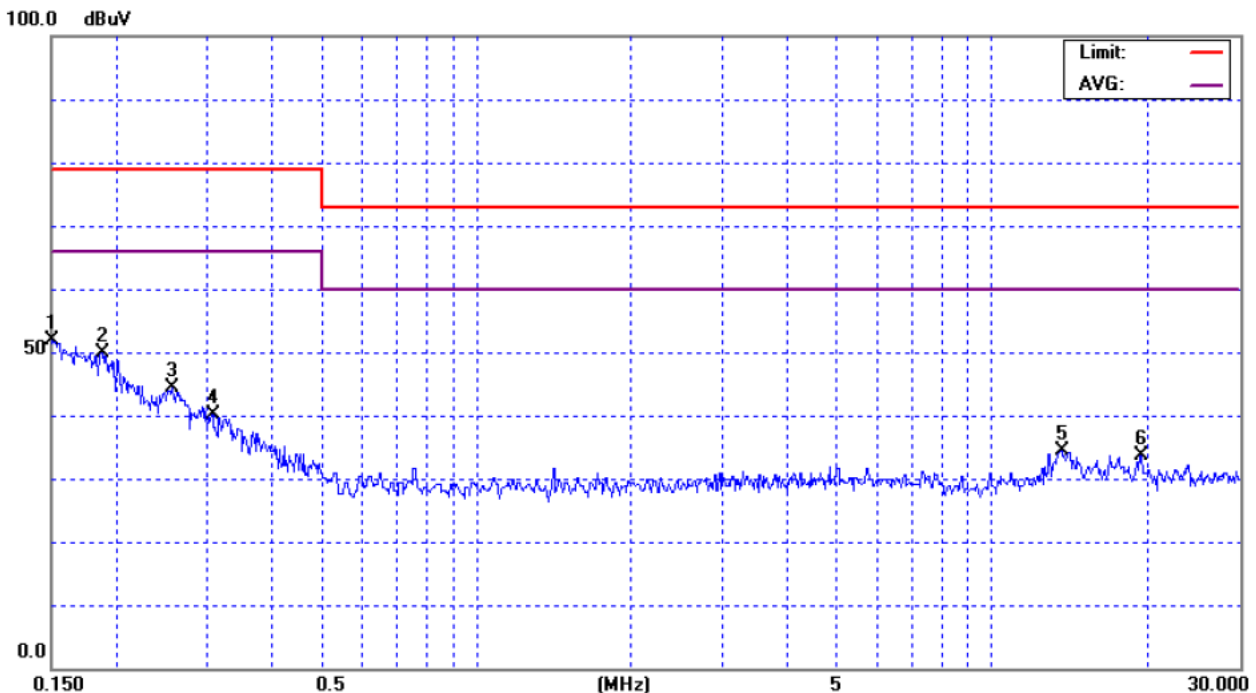



E.U.T :	Fanless embedded controller	Model Name :	xxxxxAEC-6612-xxxxxxx
Temperature :	25 °C	Relative Humidity :	42%
Test Voltage :	AC 120V/60Hz		
Test Mode :	FULL SYSTEM D-SUB 1920*1080/60Hz (xxxxxAEC-6612-xxxxxxx)		

Freq. (MHz)	Terminal L/N	Reading Level(dBuV)		Correct Factor(dB)	Measurement(dBuV)		Limit(dBuV)		Margin (dB)	Note
		QP-Mode	AV-Mode		QP-Mode	AV-Mode	QP-Mode	AV-Mode		
0.1507	Neutral	42.24	*	9.74	51.98	*	79.00	66.00	-27.02	(QP)
0.1661	Neutral	41.66	*	9.74	51.40	*	79.00	66.00	-27.60	(QP)
0.1906	Neutral	39.51	*	9.75	49.26	*	79.00	66.00	-29.74	(QP)
0.2585	Neutral	33.59	*	9.74	43.33	*	79.00	66.00	-35.67	(QP)
0.3691	Neutral	30.71	*	9.72	40.43	*	79.00	66.00	-38.57	(QP)
13.8500	Neutral	29.97	*	10.13	40.10	*	73.00	60.00	-32.90	(QP)

Remark:

- (1) Reading in which marked as QP means measurements by using are Quasi-Peak Mode with Detector BW=9 kHz; SPA setting in RBW=10 kHz, VBW =10 kHz, Swp. Time = 0.2 sec./ MHz. Reading in which marked as AV means measurements by using are Average Mode with instrument setting in RBW=10 kHz, VBW=10 kHz, Swp. Time =0.2 sec./ MHz.
- (2) All readings are QP Mode value unless otherwise stated AVG in column of Note. If the QP Mode Measured value compliance with the QP Limits and lower than AVG Limits, the EUT shall be deemed to meet both QP & AVG Limits and then only QP Mode was measured, but AVG Mode didn't perform. In this case, a " * " marked in AVG Mode column of Interference Voltage Measured.
- (3) In the "Note" column, QP means the margin value of QP is higher than Average and the "Margin" column shows the margin value of QP; AV means the margin value of Average is higher than QP and the "Margin" column shows the margin value of Average.

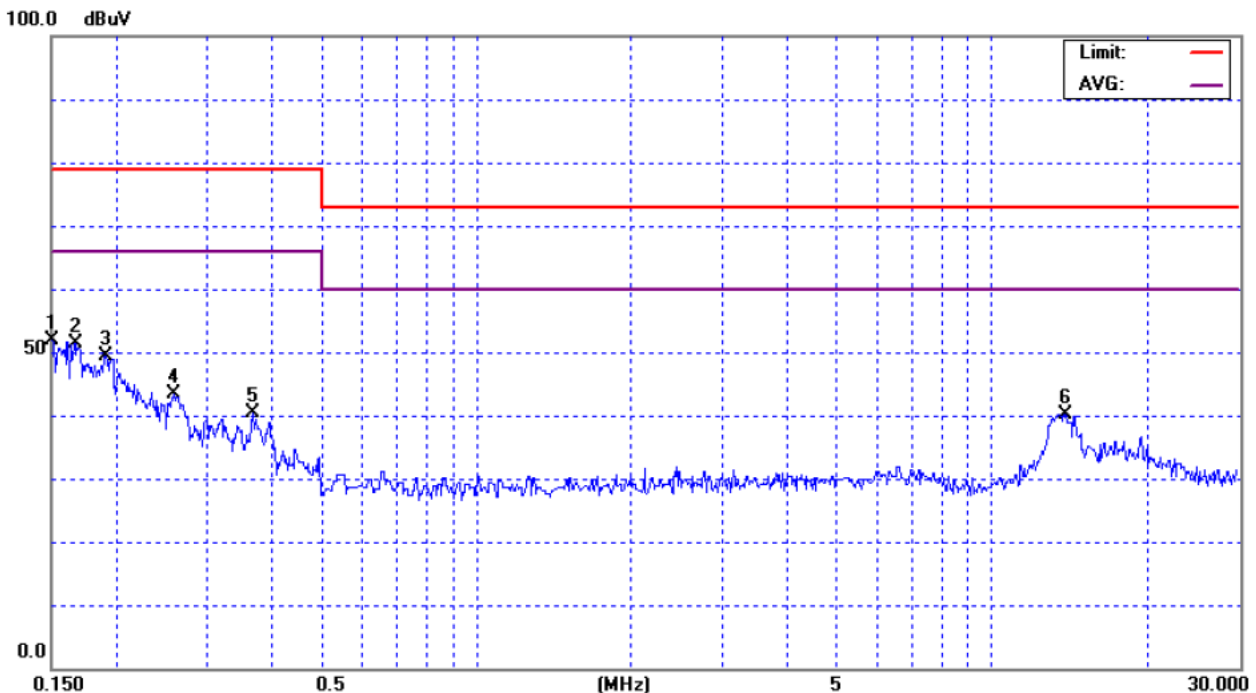



E.U.T :	Fanless embedded controller	Model Name :	xxxxxAEC-6612-xyyxxxxx
Temperature :	24 °C	Relative Humidity :	42%
Test Voltage :	AC 120V/60Hz		
Test Mode :	FULL SYSTEM D-SUB 1920*1080/60Hz (xxxxxAEC-6612-xyyxxxxx)		

Freq. (MHz)	Terminal L/N	Reading Level(dBuV)		Correct Factor(dB)	Measurement(dBuV)		Limit(dBuV)		Margin (dB)	Note
		QP-Mode	AV-Mode		QP-Mode	AV-Mode	QP-Mode	AV-Mode		
0.1521	Line	47.18	*	9.72	56.90	*	79.00	66.00	-22.10	(QP)
0.1822	Line	44.68	*	9.71	54.39	*	79.00	66.00	-24.61	(QP)
0.2410	Line	37.45	*	9.70	47.15	*	79.00	66.00	-31.85	(QP)
0.3635	Line	32.54	*	9.69	42.23	*	79.00	66.00	-36.77	(QP)
17.7000	Line	29.49	*	10.09	39.58	*	73.00	60.00	-33.42	(QP)
24.1500	Line	29.01	*	10.26	39.27	*	73.00	60.00	-33.73	(QP)

Remark:

- (1) Reading in which marked as QP means measurements by using are Quasi-Peak Mode with Detector BW=9 kHz; SPA setting in RBW=10 kHz, VBW =10 kHz, Swp. Time = 0.2 sec./ MHz. Reading in which marked as AV means measurements by using are Average Mode with instrument setting in RBW=10 kHz, VBW=10 kHz, Swp. Time =0.2 sec./ MHz.
- (2) All readings are QP Mode value unless otherwise stated AVG in column of Note. If the QP Mode Measured value compliance with the QP Limits and lower than AVG Limits, the EUT shall be deemed to meet both QP & AVG Limits and then only QP Mode was measured, but AVG Mode didn't perform. In this case, a " * " marked in AVG Mode column of Interference Voltage Measured.
- (3) In the "Note" column, QP means the margin value of QP is higher than Average and the "Margin" column shows the margin value of QP; AV means the margin value of Average is higher than QP and the "Margin" column shows the margin value of Average.

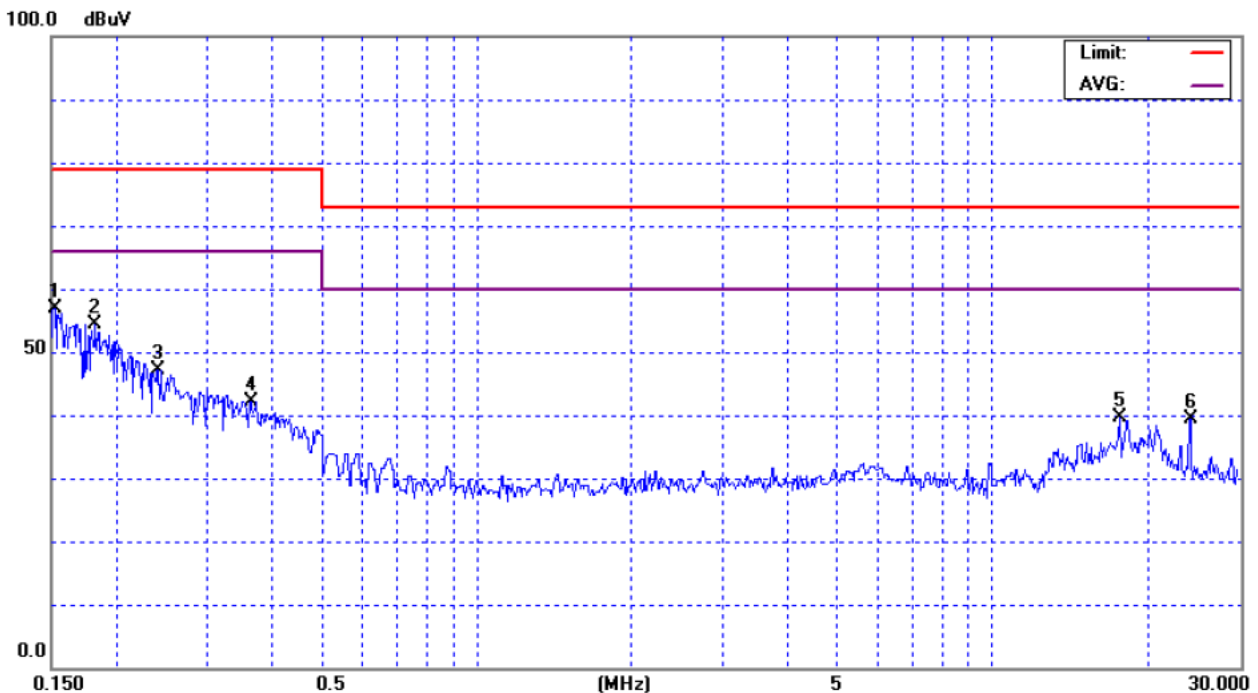



E.U.T :	Fanless embedded controller	Model Name :	xxxxxAEC-6612-xyyxxxxx
Temperature :	24 °C	Relative Humidity :	42%
Test Voltage :	AC 120V/60Hz		
Test Mode :	FULL SYSTEM D-SUB 1920*1080/60Hz (xxxxAEC-6612-xyyxxxxx)		

Freq. (MHz)	Terminal L/N	Reading Level(dBuV)		Correct Factor(dB)	Measurement(dBuV)		Limit(dBuV)		Margin (dB)	Note
		QP-Mode	AV-Mode		QP-Mode	AV-Mode	QP-Mode	AV-Mode		
0.1535	Neutral	47.62	*	9.74	57.36	*	79.00	66.00	-21.64	(QP)
0.1703	Neutral	45.87	*	9.74	55.61	*	79.00	66.00	-23.39	(QP)
0.2900	Neutral	35.97	*	9.74	45.71	*	79.00	66.00	-33.29	(QP)
0.5450	Neutral	26.04	*	9.70	35.74	*	73.00	60.00	-37.26	(QP)
12.7000	Neutral	29.04	*	10.11	39.15	*	73.00	60.00	-33.85	(QP)
24.1500	Neutral	29.21	*	10.50	39.71	*	73.00	60.00	-33.29	(QP)

Remark:

- (1) Reading in which marked as QP means measurements by using are Quasi-Peak Mode with Detector BW=9 kHz; SPA setting in RBW=10 kHz, VBW =10 kHz, Swp. Time = 0.2 sec./ MHz. Reading in which marked as AV means measurements by using are Average Mode with instrument setting in RBW=10 kHz, VBW=10 kHz, Swp. Time =0.2 sec./ MHz.
- (2) All readings are QP Mode value unless otherwise stated AVG in column of Note. If the QP Mode Measured value compliance with the QP Limits and lower than AVG Limits, the EUT shall be deemed to meet both QP & AVG Limits and then only QP Mode was measured, but AVG Mode didn't perform. In this case, a " * " marked in AVG Mode column of Interference Voltage Measured.
- (3) In the "Note" column, QP means the margin value of QP is higher than Average and the "Margin" column shows the margin value of QP; AV means the margin value of Average is higher than QP and the "Margin" column shows the margin value of Average.

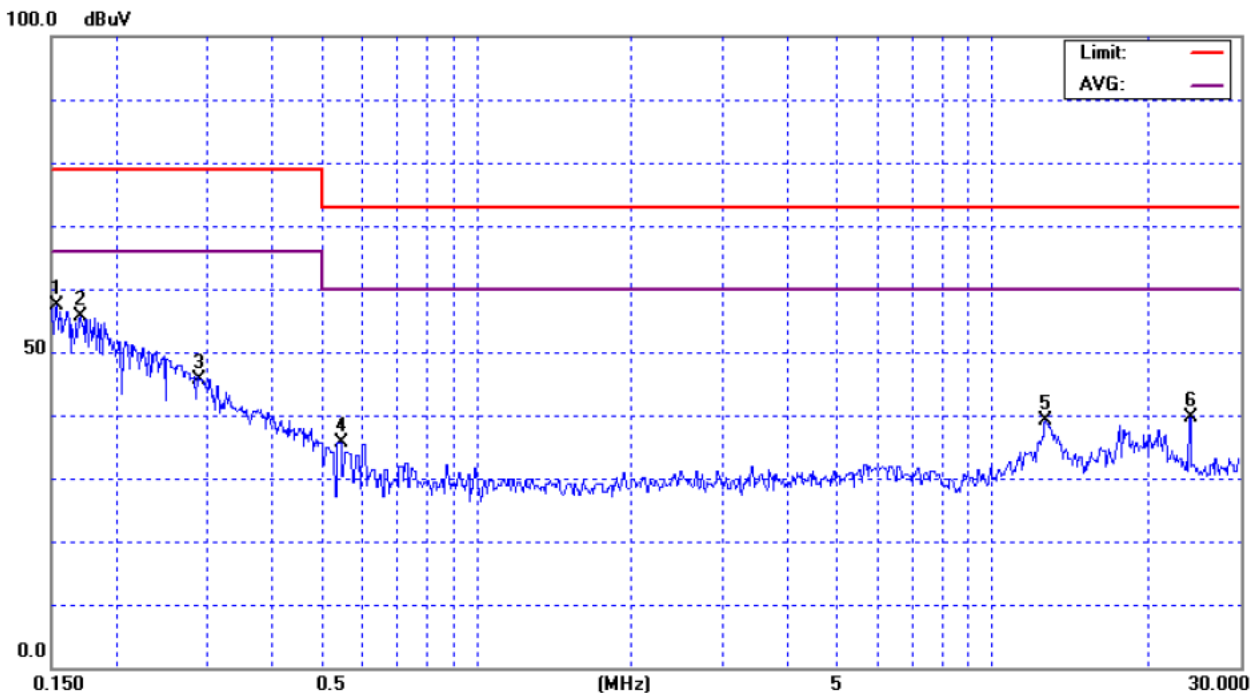



4.2 RADIATED EMISSION MEASUREMENT

4.2.1 LIMITS OF RADIATED EMISSION MEASUREMENT (BELOW 1000 MHZ)

FREQUENCY (MHz)	Class A (at 10m)	Class B (at 10m)
	dBuV/m	dBuV/m
30 – 230	40	30
230 – 1000	47	37

Notes:

- (1) The limit for radiated test was performed according to as following:
CISPR 22/ FCC PART 15B /ICES-003.
- (2) The tighter limit applies at the band edges.
- (3) Emission level (dBuV/m)=20log Emission level (uV/m).
- (4) The test result calculated as following:
 Measurement Value = Reading Level + Correct Factor
 Correct Factor = Antenna Factor + Cable Loss – Amplifier Gain(if use)
 Margin Level = Measurement Value – Limit Value

LIMITS OF RADIATED EMISSION MEASUREMENT (ABOVE 1000MHZ)

FREQUENCY (MHz)	Class A (dBuV/m) (at 3m)		Class B (dBuV/m) (at 3m)	
	PEAK	AVERAGE	PEAK	AVERAGE
Above 1000	80	60	74	54

Notes:

- (1) The limit for radiated test was performed according to FCC PART 15B.
- (2) The tighter limit applies at the band edges.
- (3) Emission level (dBuV/m)=20log Emission level (uV/m).
- (4) The test result calculated as following:
 Measurement Value = Reading Level + Correct Factor
 Correct Factor = Antenna Factor + Cable Loss – Amplifier Gain(if use)
 Margin Level = Measurement Value – Limit Value

FREQUENCY RANGE OF RADIATED MEASUREMENT (FOR UNINTENTIONAL RADIATORS)

Highest frequency generated or Upper frequency of measurement used in the device or on which the device operates or tunes (MHz)	Range (MHz)
Below 1.705	30
1.705 – 108	1000
108 – 500	2000
500 – 1000	5000
Above 1000	5 th harmonic of the highest frequency or 40 GHz, whichever is lower



4.2.2 MEASUREMENT INSTRUMENTS LIST

Item	Kind of Equipment	Manufacturer	Type No.	Serial No.	Calibrated until
1	Pre-Amplifier	Anritsu	MH648A	M98457	Jan. 18, 2011
2	Test Cable	TIMES	LMR-400	10M-OS01	Jun. 17, 2011
3	Test Cable	TIMES	LMR-400	OS02	Jun. 17, 2011
4	EMI Test Receiver	R&S	ESCI	100082	Mar. 16, 2011
5	System Controller (OS02)	CT	SC100	N/A	N/A
6	Turn Table	Chance Most	CMTB-1.5	N/A	N/A
7	Microwave Pre amplifier	Agilent	8449B	3008A01714	Apr. 19, 2011
8	Microflex Cable	HARBOUR INDUSTRIES	27478 LL142	1m	May. 19, 2011
9	Microflex Cable	AISI	S104-SMAP-1	10m	Aug. 22, 2011
10	Microflex Cable	HARBOUR INDUSTRIES	27478 LL142	3m	Aug. 22, 2011
11	Spectrum Analyzer	R&S	FSP-40	100129	Aug. 31, 2011
12	Horn Antenna (1G)	Schwarzbeck	BBHA 9120 D	9120D-325	Dec. 15, 2010
13	Log-Bicon Antenna	Schwarzbeck	VULB 9160	3058	Mar. 18, 2011

Remark: " N/A" denotes No Model Name / Serial No. and No Calibration specified.

4.2.3 TEST PROCEDURE

- a. The measuring distance of at 10 m shall be used for measurements at frequency up to 1GHz. For frequencies above 1GHz, any suitable measuring distance may be used.
- b. The EUT was placed on the top of a rotating table 0.8 meters above the ground at a 3m or 10 meter open area test site. The table was rotated 360 degrees to determine the position of the highest radiation.
- c. The height of the equipment or of the substitution antenna shall be 0.8 m; the height of the test antenna shall vary between 1 m to 4 m. Both horizontal and vertical polarizations of the antenna are set to make the measurement.
- d. The initial step in collecting radiated emission data is a spectrum analyzer peak detector mode pre-scanning the measurement frequency range. Significant peaks are then marked and then Quasi Peak detector mode re-measured.
- e. If the Peak Mode measured value compliance with and lower than Quasi Peak Mode Limit, the EUT shall be deemed to meet QP Limits and then no additional QP Mode measurement performed.
- f. For the actual test configuration, please refer to the related Item –EUT Test Photos.

4.2.4 DEVIATION FROM TEST STANDARD

No deviation

4.2.5 TEST SETUP

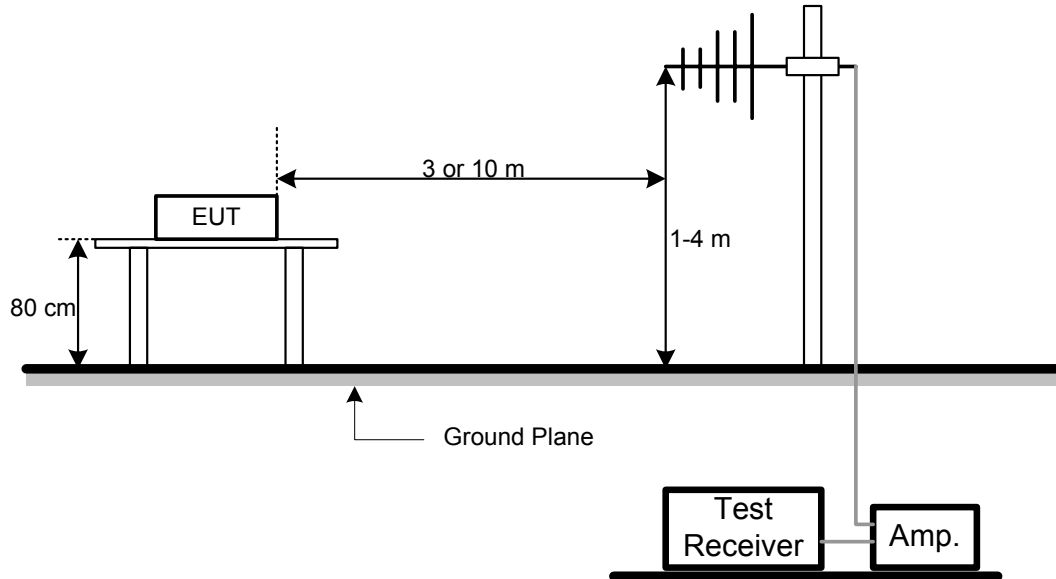

4.2.6 EUT OPERATING CONDITIONS

The EUT tested system was configured as the statements of 4.1.6 Unless otherwise a special operating condition is specified in the follows during the testing.



4.2.7 TEST RESULTS-BETWEEN 30MHZ AND 1000MHZ

E.U.T :	Fanless embedded controller	Model Name :	xxxxxAEC-6612-xxxxxxx
Temperature :	35 °C	Relative Humidity :	40%
Test Voltage :	AC 120V/60Hz		
Test Mode :	FULL SYSTEM D-SUB 1920*1080/60Hz (xxxxxAEC-6612-xxxxxxx)		

Freq. (MHz)	Polarization H/V	Reading Level (dBuV)	Correct Factor(dB)	Measurement (dBuV/m)	Limit(Quasi-Peak) (dBuV/m)	Margin (dB)	Note
31.0440	V	38.73	-7.26	31.47	40.00	- 8.53	
99.2200	V	37.34	-9.24	28.10	40.00	- 11.90	
150.3200	V	33.61	-4.72	28.89	40.00	- 11.11	
169.0400	V	32.95	-4.93	28.02	40.00	- 11.98	
239.9600	V	48.55	-5.88	42.67	47.00	- 4.33	
500.0180	V	38.29	0.99	39.28	47.00	- 7.72	

Remark :

- (1) Reading in which marked as QP or Peak means measurements by using are Quasi-Peak Mode or Peak Mode with Detector BW=120 kHz; SPA setting in RBW=120 kHz, VBW =120 kHz, Swp. Time = 0.3 sec./ MHz.
- (2) All readings are Peak unless otherwise stated QP in column of Note. Peak denotes that the Peak reading compliance with the QP Limits and then QP Mode measurement didn't perform.
- (3) Measuring frequency range from 30 MHz to 1000 MHz.
- (4) If the peak scan value is under the limit for more than 20dB, the signal will not show in table.

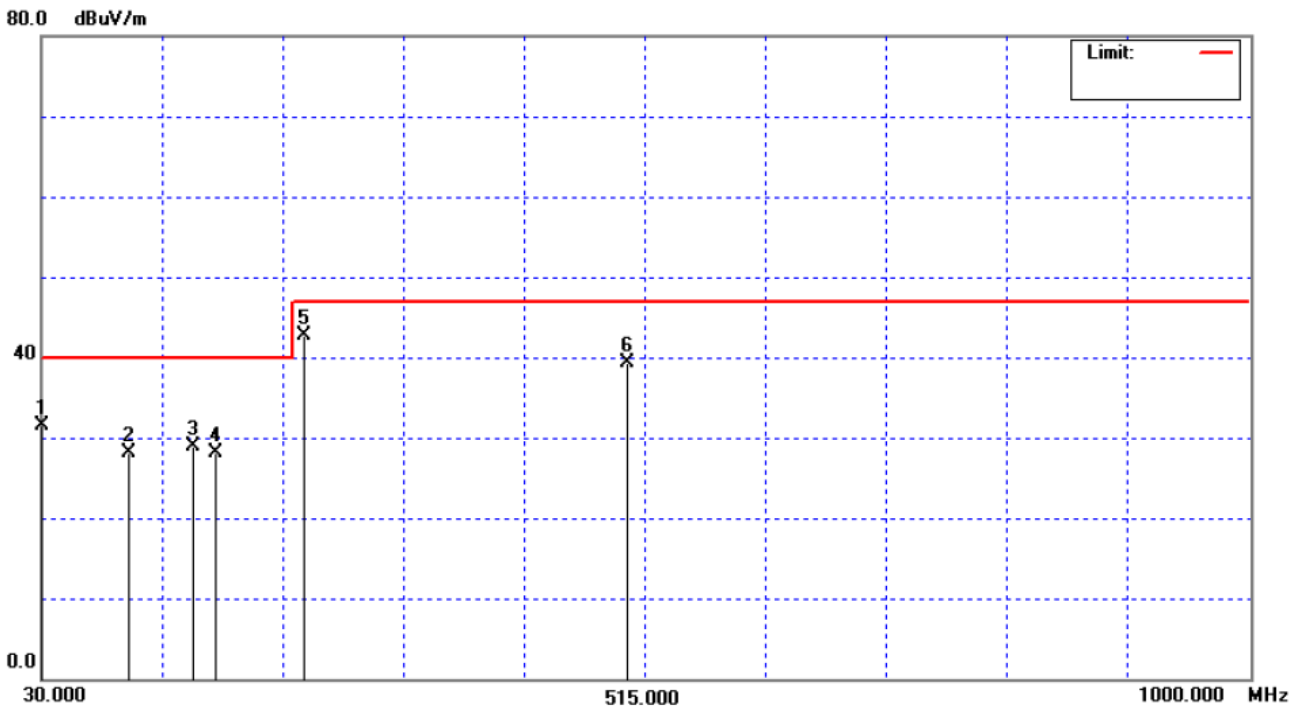



E.U.T :	Fanless embedded controller	Model Name :	xxxxxAEC-6612-xxxxxxx
Temperature :	35 °C	Relative Humidity :	40%
Test Voltage :	AC 120V/60Hz		
Test Mode :	FULL SYSTEM D-SUB 1920*1080/60Hz (xxxxxAEC-6612-xxxxxxx)		

Freq. (MHz)	Polarization H/V	Reading Level (dBuV)	Correct Factor(dB)	Measurement (dBuV/m)	Limit(Quasi-Peak) (dBuV/m)	Margin (dB)	Note
192.0100	H	34.04	-7.15	26.89	40.00	- 13.11	
239.9700	H	48.00	-5.88	42.12	47.00	- 4.88	
250.0100	H	41.59	-5.58	36.01	47.00	- 10.99	
500.0240	H	34.08	0.99	35.07	47.00	- 11.93	
720.0080	H	38.92	4.73	43.65	47.00	- 3.35	
934.5240	H	23.85	8.92	32.77	47.00	- 14.23	

Remark :

- (1) Reading in which marked as QP or Peak means measurements by using are Quasi-Peak Mode or Peak Mode with Detector BW=120 kHz; SPA setting in RBW=120 kHz, VBW =120 kHz, Swp. Time = 0.3 sec./ MHz.
- (2) All readings are Peak unless otherwise stated QP in column of Note. Peak denotes that the Peak reading compliance with the QP Limits and then QP Mode measurement didn't perform.
- (3) Measuring frequency range from 30 MHz to 1000 MHz.
- (4) If the peak scan value is under the limit for more than 20dB, the signal will not show in table.

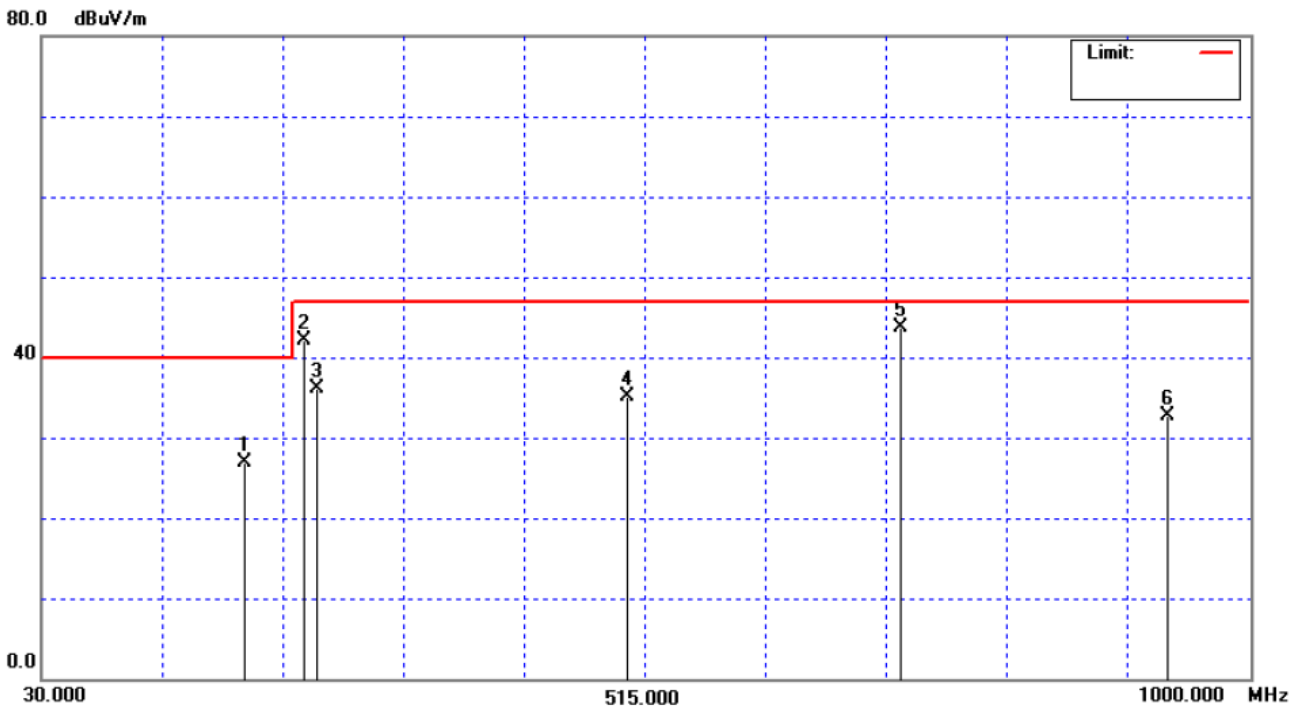



E.U.T :	Fanless embedded controller	Model Name :	xxxxxAEC-6612-xyxxxxx
Temperature :	22 °C	Relative Humidity :	83%
Test Voltage :	AC 120V/60Hz		
Test Mode :	FULL SYSTEM D-SUB 1920*1080/60Hz (xxxxAEC-6612-xyxxxxx)		

Freq. (MHz)	Polarization H/V	Reading Level (dBuV)	Correct Factor(dB)	Measurement (dBuV/m)	Limit(Quasi-Peak) (dBuV/m)	Margin (dB)	Note
57.1440	V	36.19	-5.96	30.23	40.00	- 9.77	
120.9700	V	36.47	-5.52	30.95	40.00	- 9.05	
160.5800	V	34.35	-4.03	30.32	40.00	- 9.68	
240.0120	V	46.10	-5.78	40.32	47.00	- 6.68	(QP)
264.3200	V	39.40	-5.03	34.37	47.00	- 12.63	
520.3600	V	27.47	1.10	28.57	47.00	- 18.43	

Remark :

- (1) Reading in which marked as QP or Peak means measurements by using are Quasi-Peak Mode or Peak Mode with Detector BW=120 kHz; SPA setting in RBW=120 kHz, VBW =120 kHz, Swp. Time = 0.3 sec./ MHz.
- (2) All readings are Peak unless otherwise stated QP in column of Note. Peak denotes that the Peak reading compliance with the QP Limits and then QP Mode measurement didn't perform.
- (3) Measuring frequency range from 30 MHz to 1000 MHz.
- (4) If the peak scan value is under the limit for more than 20dB, the signal will not show in table.

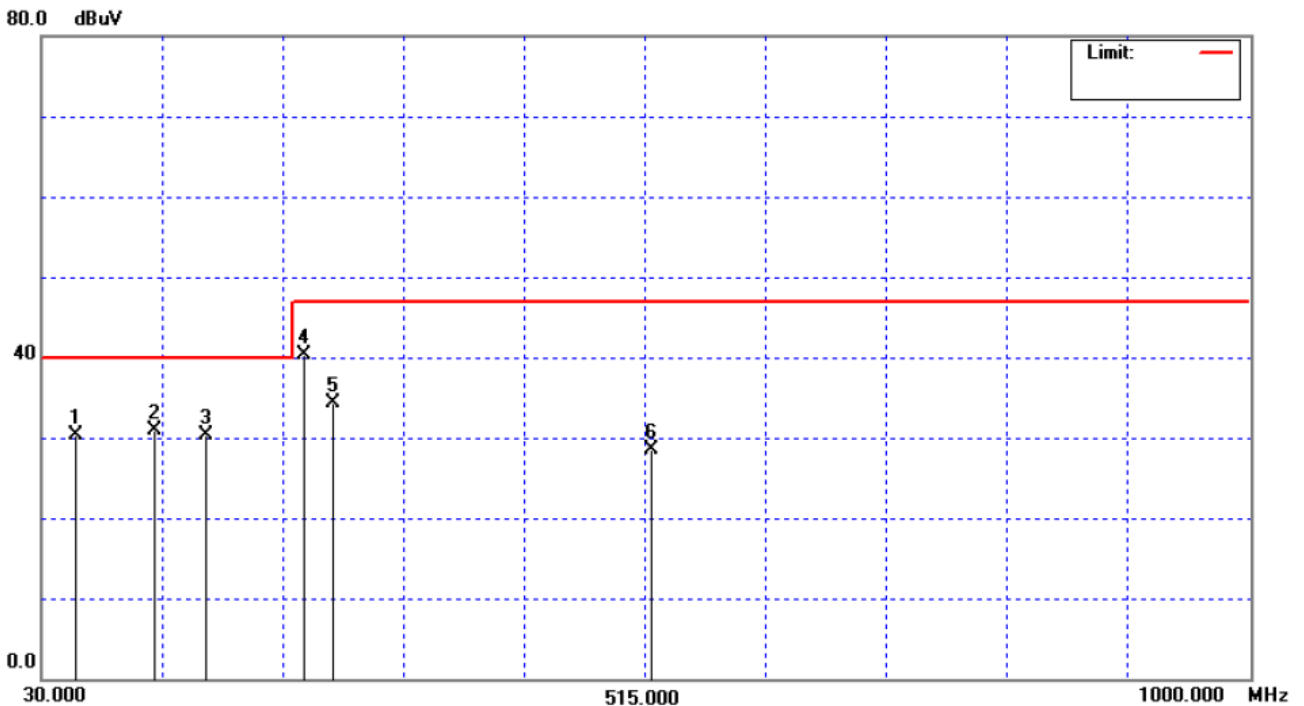



E.U.T :	Fanless embedded controller	Model Name :	xxxxxAEC-6612-xyyxxxxx
Temperature :	22 °C	Relative Humidity :	83%
Test Voltage :	AC 120V/60Hz		
Test Mode :	FULL SYSTEM D-SUB 1920*1080/60Hz (xxxxxAEC-6612-xyyxxxxx)		

Freq. (MHz)	Polarization H/V	Reading Level (dBuV)	Correct Factor(dB)	Measurement (dBuV/m)	Limit(Quasi-Peak) (dBuV/m)	Margin (dB)	Note
239.9800	H	45.30	-5.78	39.52	47.00	- 7.48	(QP)
400.0700	H	36.46	-1.94	34.52	47.00	- 12.48	
500.0110	H	37.65	0.79	38.44	47.00	- 8.56	
720.0000	H	36.55	4.87	41.42	47.00	- 5.58	
932.7800	H	26.95	8.18	35.13	47.00	- 11.87	
1000.0000	H	28.11	9.43	37.54	47.00	- 9.46	

Remark :

- (1) Reading in which marked as QP or Peak means measurements by using are Quasi-Peak Mode or Peak Mode with Detector BW=120 kHz; SPA setting in RBW=120 kHz, VBW =120 kHz, Swp. Time = 0.3 sec./ MHz.
- (2) All readings are Peak unless otherwise stated QP in column of Note. Peak denotes that the Peak reading compliance with the QP Limits and then QP Mode measurement didn't perform.
- (3) Measuring frequency range from 30 MHz to 1000 MHz.
- (4) If the peak scan value is under the limit for more than 20dB, the signal will not show in table.

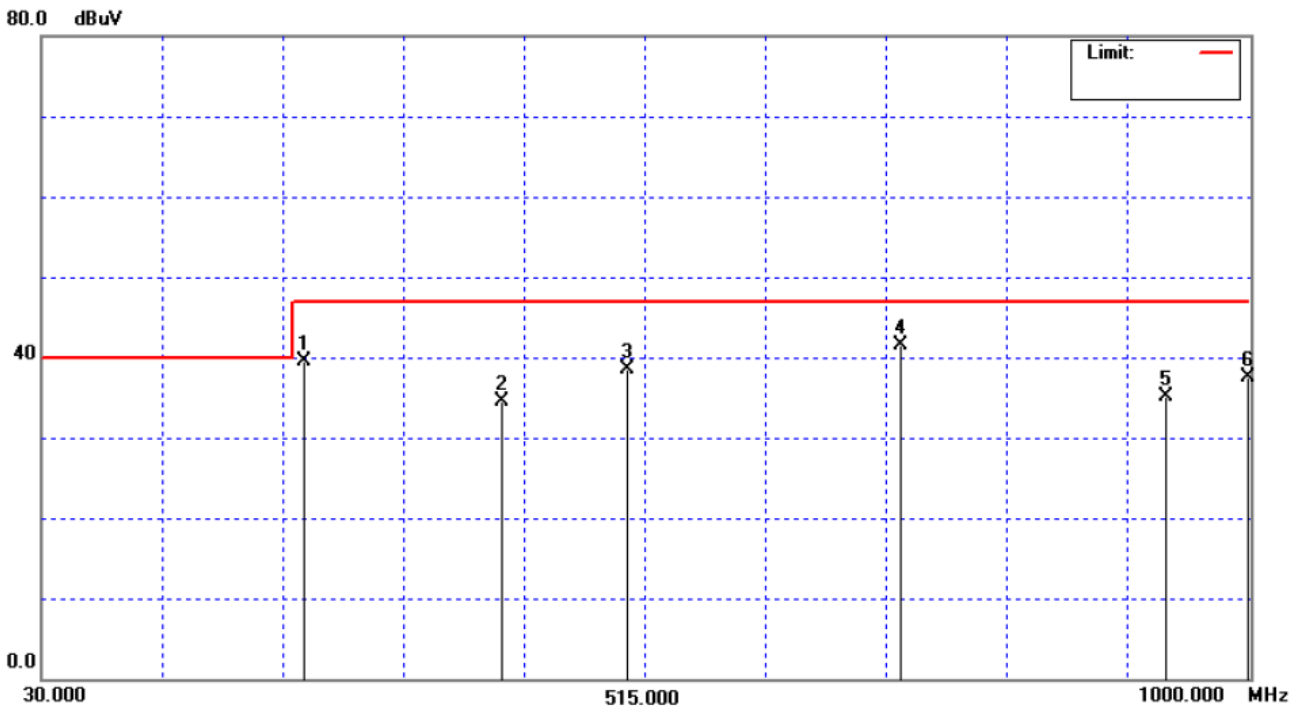



4.2.8 TEST RESULTS-ABOVE 1000MHZ

E.U.T :	Fanless embedded controller	Model Name :	xxxxxAEC-6612-xxxxxxx
Temperature :	24 °C	Relative Humidity :	51%
Test Voltage :	AC 120V/60Hz		
Test Mode :	FULL SYSTEM D-SUB 1920*1080/60Hz (xxxxAEC-6612-xxxxxxx)		

Freq. (MHz)	Polarization H/V	Reading Level(dBuV)		Correct Factor(dB)	Measurement(dBuV/m)		Limit(dBuV/m)		Margin (dB)	Note
		Peak	AV		Peak	AV	Peak	AV		
1064.000	V	54.58	*	-7.67	46.91	*	80.00	60.00	- 33.09	Peak
1192.000	V	54.31	*	-7.14	47.17	*	80.00	60.00	- 32.83	Peak
1592.000	V	55.86	*	-5.65	50.21	*	80.00	60.00	- 29.79	Peak
1720.000	V	57.14	*	-5.36	51.78	*	80.00	60.00	- 28.22	Peak
3000.000	V	49.49	*	-2.78	46.71	*	80.00	60.00	- 33.29	Peak
3816.000	V	49.14	*	-0.37	48.77	*	80.00	60.00	- 31.23	Peak

Remark :

- (1) Reading in which marked as PK means measurements by using are Peak Mode with instrument setting in RBW= 1 MHz, VBW= 1 MHz, Swp. Time = Auto.
Reading in which marked as AV means measurements by using are Average Mode with instrument setting in RBW= 1 MHz, VBW= 10 Hz, Swp. Time = Auto.
- (2) All readings are PK Mode value unless otherwise stated AVG in column of Note. If the PK Mode Measured value compliance with the PK Limits and lower than AVG Limits, the EUT shall be deemed to meet both PK & AVG Limits and then only PK Mode was measured, but AVG Mode didn't perform. In this case, a " * " marked in AVG Mode column of Interference Voltage Measured.
- (3) In the "Note" column, Peak means the margin value of Peak is higher than Average and the "Margin" column shows the margin value of Peak; AV means the margin value of Average is higher than Peak and the "Margin" column shows the margin value of Average.

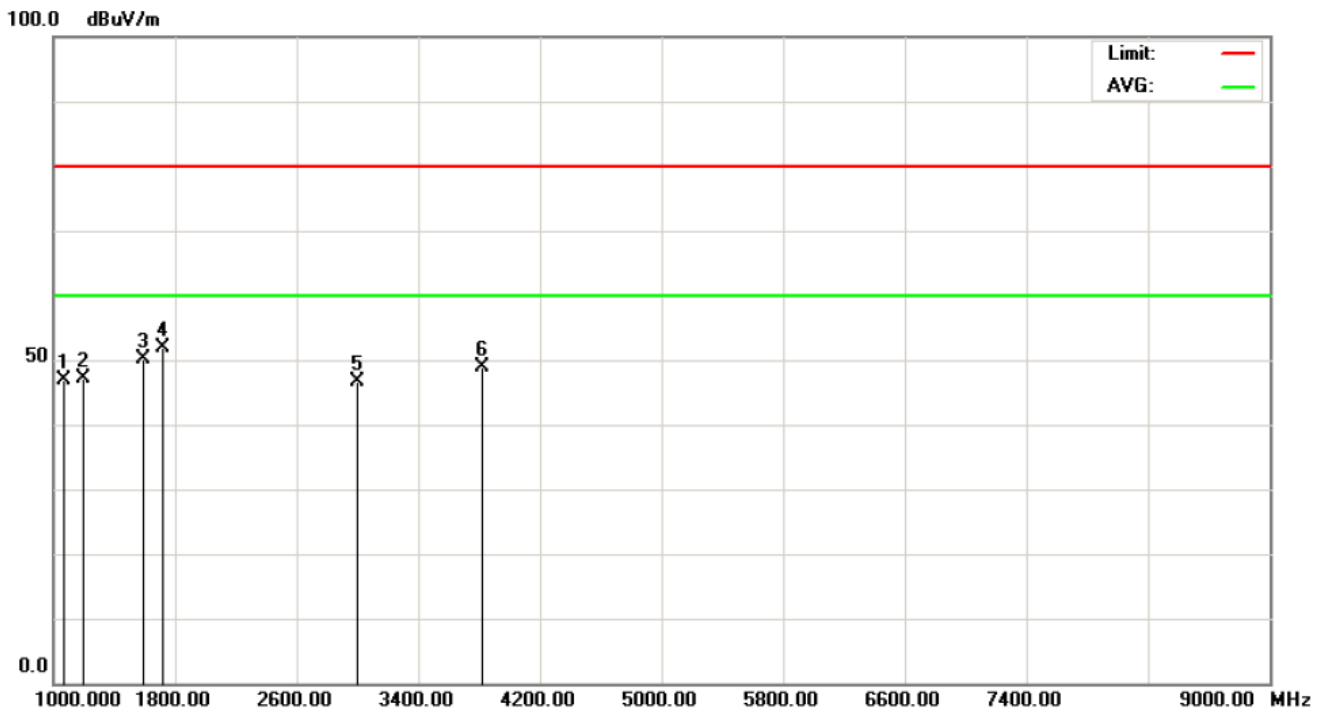



E.U.T :	Fanless embedded controller	Model Name :	xxxxxAEC-6612-xxxxxxx
Temperature :	24 °C	Relative Humidity :	51%
Test Voltage :	AC 120V/60Hz		
Test Mode :	FULL SYSTEM D-SUB 1920*1080/60Hz (xxxxAEC-6612-xxxxxxx)		

Freq. (MHz)	Polarization H/V	Reading Level(dBuV)		Correct Factor(dB)	Measurement(dBuV/m)		Limit(dBuV/m)		Margin (dB)	Note
		Peak	AV		Peak	AV	Peak	AV		
1064.000	H	52.84	*	-7.67	45.17	*	80.00	60.00	- 34.83	Peak
1432.000	H	51.74	*	-6.14	45.60	*	80.00	60.00	- 34.40	Peak
1592.000	H	52.66	*	-5.65	47.01	*	80.00	60.00	- 32.99	Peak
1736.000	H	54.25	*	-5.33	48.92	*	80.00	60.00	- 31.08	Peak
3000.000	H	46.45	*	-2.78	43.67	*	80.00	60.00	- 36.33	Peak
3832.000	H	48.53	*	-0.33	48.20	*	80.00	60.00	- 31.80	Peak

Remark :

- (1) Reading in which marked as PK means measurements by using are Peak Mode with instrument setting in RBW= 1 MHz, VBW= 1 MHz, Swp. Time = Auto.
Reading in which marked as AV means measurements by using are Average Mode with instrument setting in RBW= 1 MHz, VBW= 10 Hz, Swp. Time = Auto.
- (2) All readings are PK Mode value unless otherwise stated AVG in column of Note. If the PK Mode Measured value compliance with the PK Limits and lower than AVG Limits, the EUT shall be deemed to meet both PK & AVG Limits and then only PK Mode was measured, but AVG Mode didn't perform. In this case, a " * " marked in AVG Mode column of Interference Voltage Measured.
- (3) In the "Note" column, Peak means the margin value of Peak is higher than Average and the "Margin" column shows the margin value of Peak; AV means the margin value of Average is higher than Peak and the "Margin" column shows the margin value of Average.

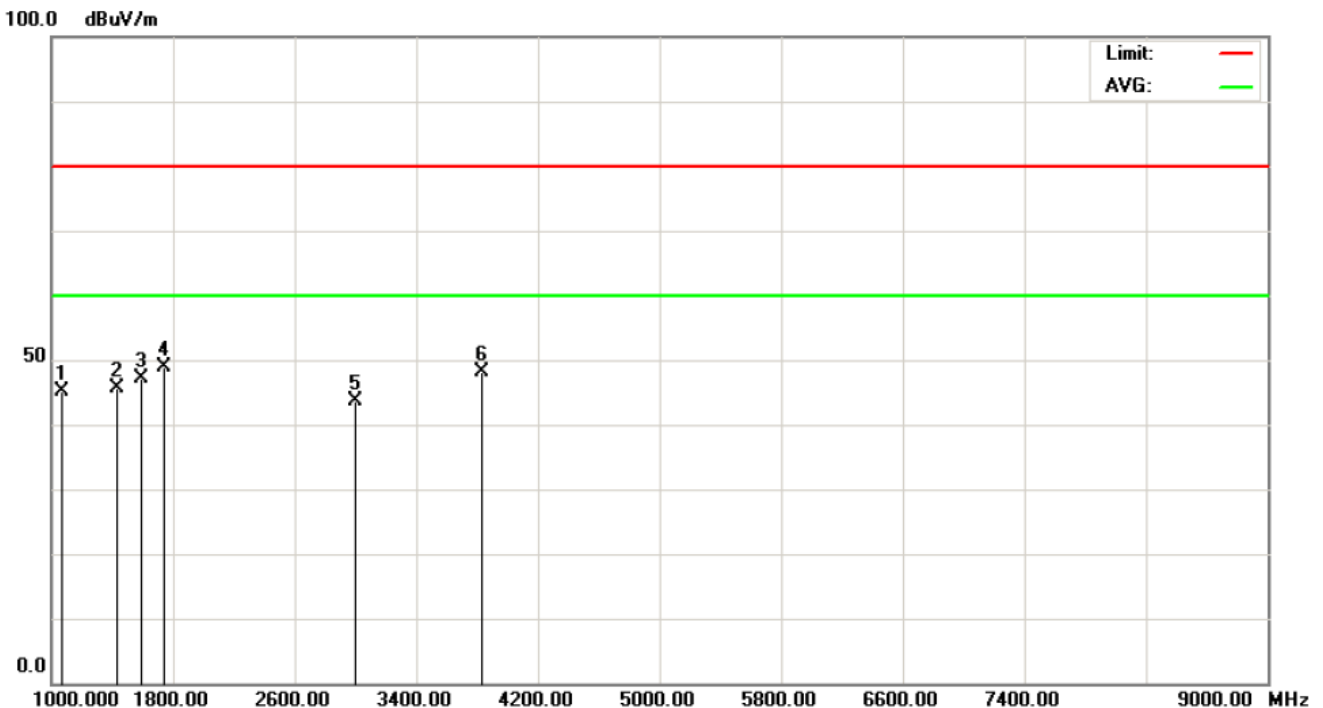



E.U.T :	Fanless embedded controller	Model Name :	xxxxxAEC-6612-xyxxxxx
Temperature :	24 °C	Relative Humidity :	51%
Test Voltage :	AC 120V/60Hz		
Test Mode :	FULL SYSTEM D-SUB 1920*1080/60Hz (xxxxAEC-6612-xyxxxxx)		

Freq. (MHz)	Polarization H/V	Reading Level(dBuV)		Correct Factor(dB)	Measurement(dBuV/m)		Limit(dBuV/m)		Margin (dB)	Note
		Peak	AV		Peak	AV	Peak	AV		
1064.000	V	62.00	*	-7.67	54.33	*	80.00	60.00	- 25.67	Peak
1192.000	V	58.11	*	-7.14	50.97	*	80.00	60.00	- 29.03	Peak
1592.000	V	57.08	*	-5.65	51.43	*	80.00	60.00	- 28.57	Peak
1736.000	V	64.30	43.24	-5.33	58.97	37.91	80.00	60.00	- 21.03	Peak
2264.000	V	49.57	*	-3.42	46.15	*	80.00	60.00	- 33.85	Peak
3864.000	V	49.74	*	-0.26	49.48	*	80.00	60.00	- 30.52	Peak

Remark :

- (1) Reading in which marked as PK means measurements by using are Peak Mode with instrument setting in RBW= 1 MHz, VBW= 1 MHz, Swp. Time = Auto.
Reading in which marked as AV means measurements by using are Average Mode with instrument setting in RBW= 1 MHz, VBW= 10 Hz, Swp. Time = Auto.
- (2) All readings are PK Mode value unless otherwise stated AVG in column of Note. If the PK Mode Measured value compliance with the PK Limits and lower than AVG Limits, the EUT shall be deemed to meet both PK & AVG Limits and then only PK Mode was measured, but AVG Mode didn't perform. In this case, a " * " marked in AVG Mode column of Interference Voltage Measured.
- (3) In the "Note" column, Peak means the margin value of Peak is higher than Average and the "Margin" column shows the margin value of Peak; AV means the margin value of Average is higher than Peak and the "Margin" column shows the margin value of Average.

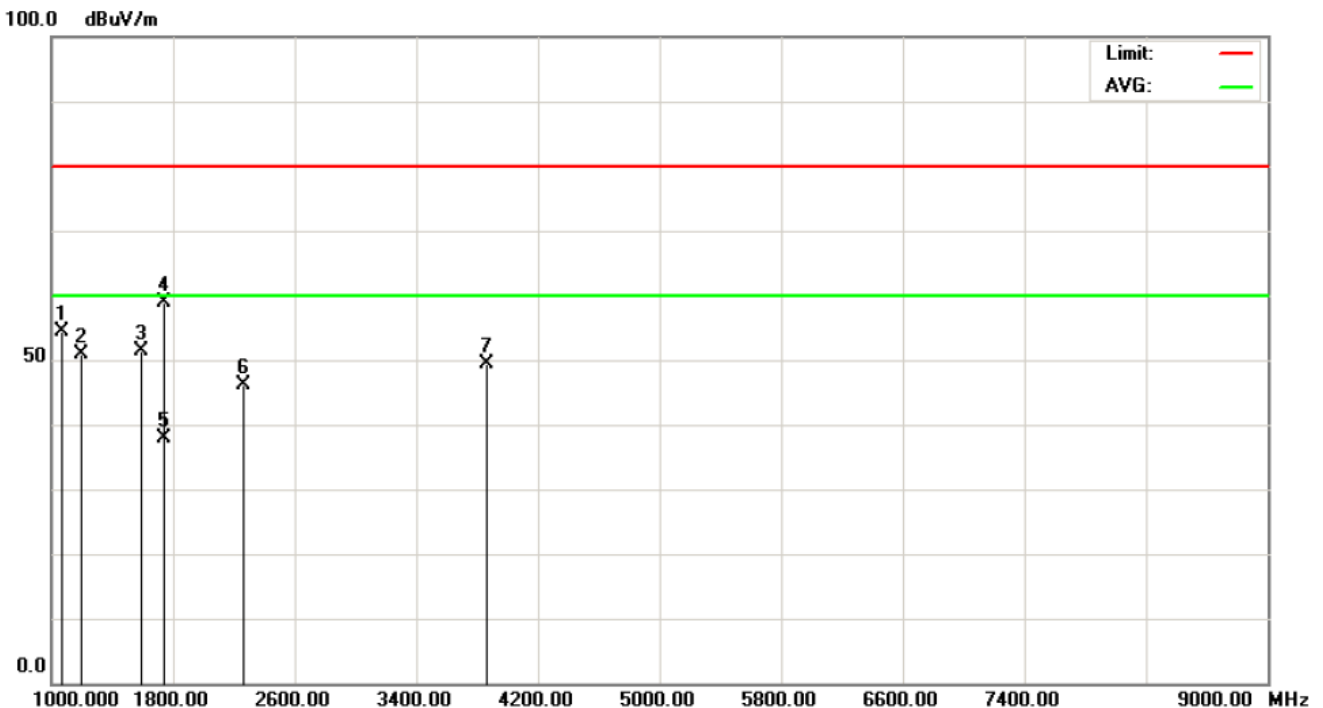



E.U.T :	Fanless embedded controller	Model Name :	xxxxxAEC-6612-xyxxxxx
Temperature :	24 °C	Relative Humidity :	51%
Test Voltage :	AC 120V/60Hz		
Test Mode :	FULL SYSTEM D-SUB 1920*1080/60Hz (xxxxAEC-6612-xyxxxxx)		

Freq. (MHz)	Polarization H/V	Reading Level(dBuV)		Correct Factor(dB)	Measurement(dBuV/m)		Limit(dBuV/m)		Margin (dB)	Note
		Peak	AV		Peak	AV	Peak	AV		
1064.000	H	64.87	*	-7.67	57.20	*	80.00	60.00	- 22.80	Peak
1192.000	H	54.81	*	-7.14	47.67	*	80.00	60.00	- 32.33	Peak
1432.000	H	56.80	*	-6.14	50.66	*	80.00	60.00	- 29.34	Peak
1592.000	H	52.93	*	-5.65	47.28	*	80.00	60.00	- 32.72	Peak
1736.000	H	60.87	*	-5.33	55.54	*	80.00	60.00	- 24.46	Peak
2392.000	H	47.58	*	-2.78	44.80	*	80.00	60.00	- 35.20	Peak

Remark :

- (1) Reading in which marked as PK means measurements by using are Peak Mode with instrument setting in RBW= 1 MHz, VBW= 1 MHz, Swp. Time = Auto.
Reading in which marked as AV means measurements by using are Average Mode with instrument setting in RBW= 1 MHz, VBW= 10 Hz, Swp. Time = Auto.
- (2) All readings are PK Mode value unless otherwise stated AVG in column of Note. If the PK Mode Measured value compliance with the PK Limits and lower than AVG Limits, the EUT shall be deemed to meet both PK & AVG Limits and then only PK Mode was measured, but AVG Mode didn't perform. In this case, a " * " marked in AVG Mode column of Interference Voltage Measured.
- (3) In the "Note" column, Peak means the margin value of Peak is higher than Average and the "Margin" column shows the margin value of Peak; AV means the margin value of Average is higher than Peak and the "Margin" column shows the margin value of Average.

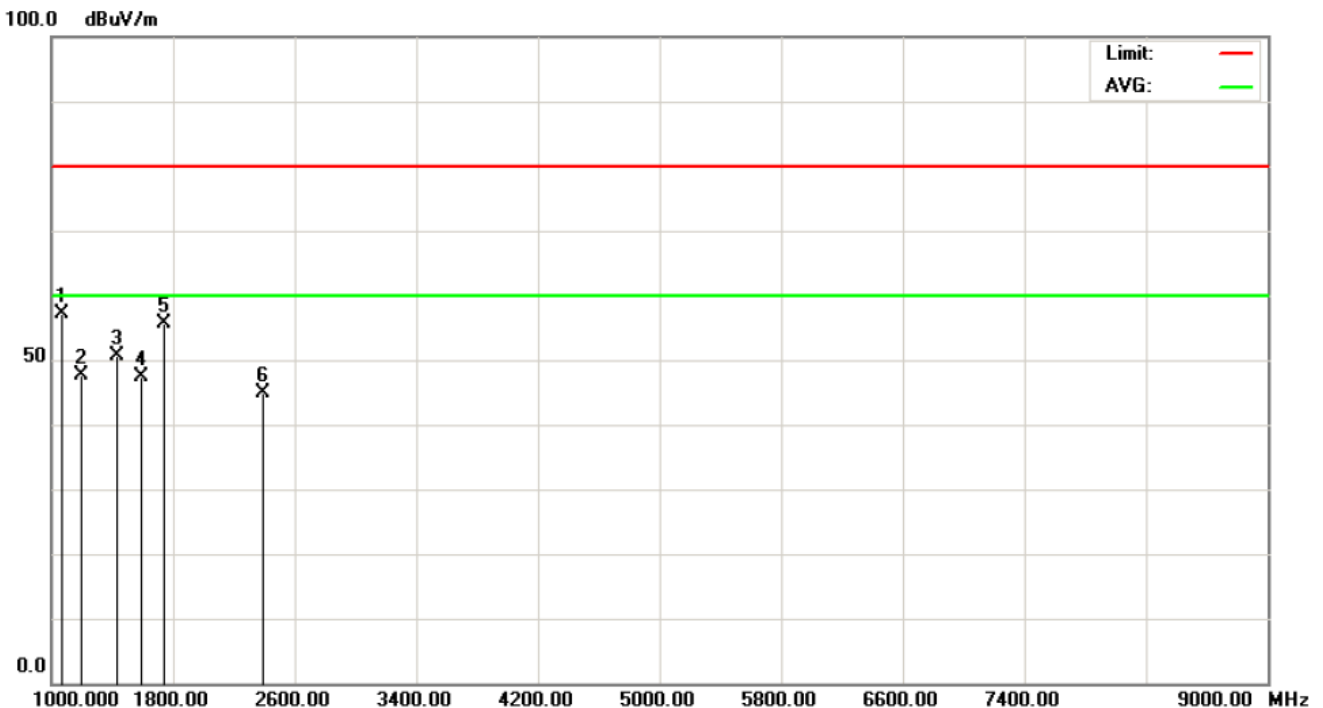



5. EUT TEST PHOTO

Conducted Measurement Photos

Mode 1





Conducted Measurement Photos

Mode 2





**Radiated Measurement Photos
BETWEEN 30MHZ AND 1000MHZ
Mode 1**

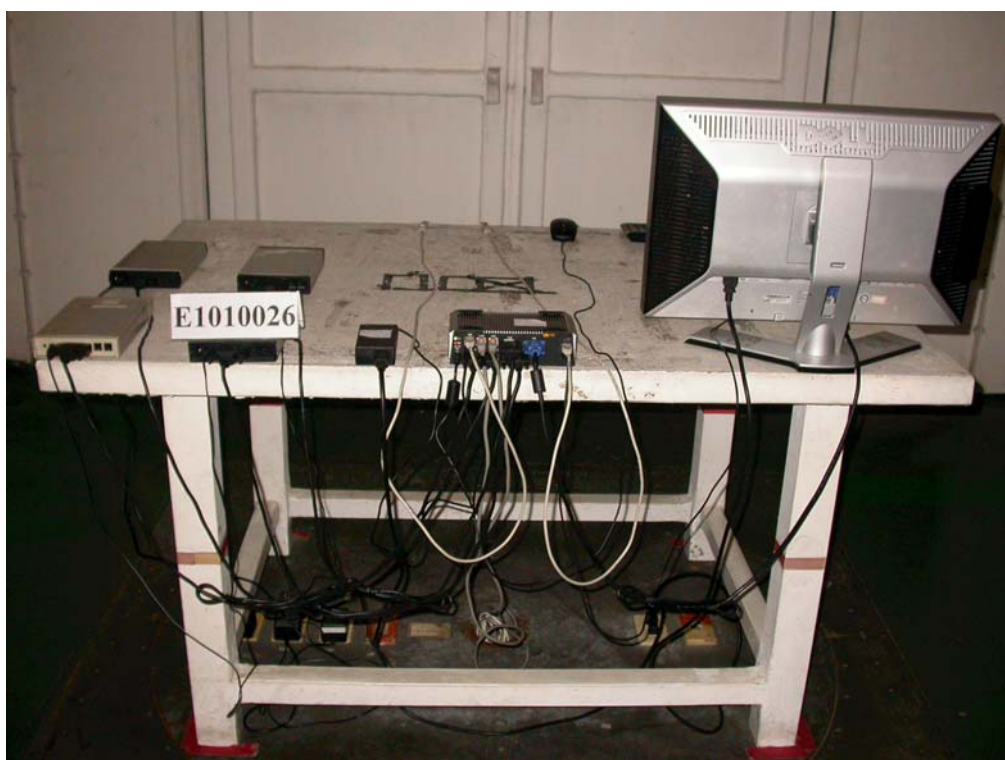

**Radiated Measurement Photos
BETWEEN 30MHZ AND 1000MHZ
Mode 2**





**Radiated Measurement Photos
ABOVE 1000MHZ
Mode 1**

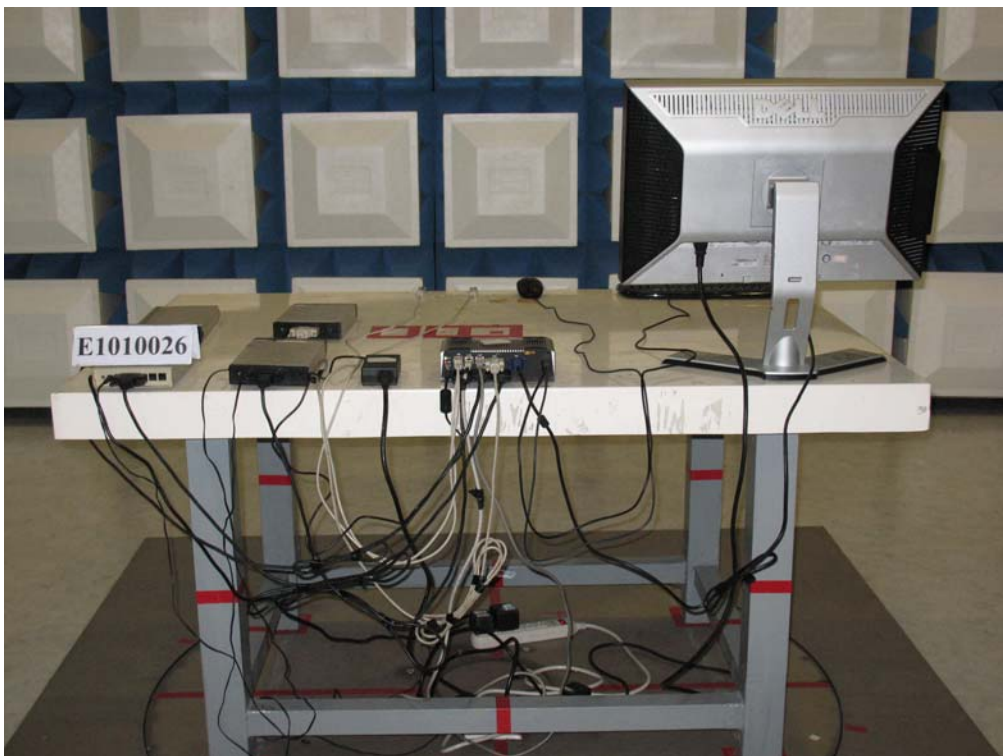
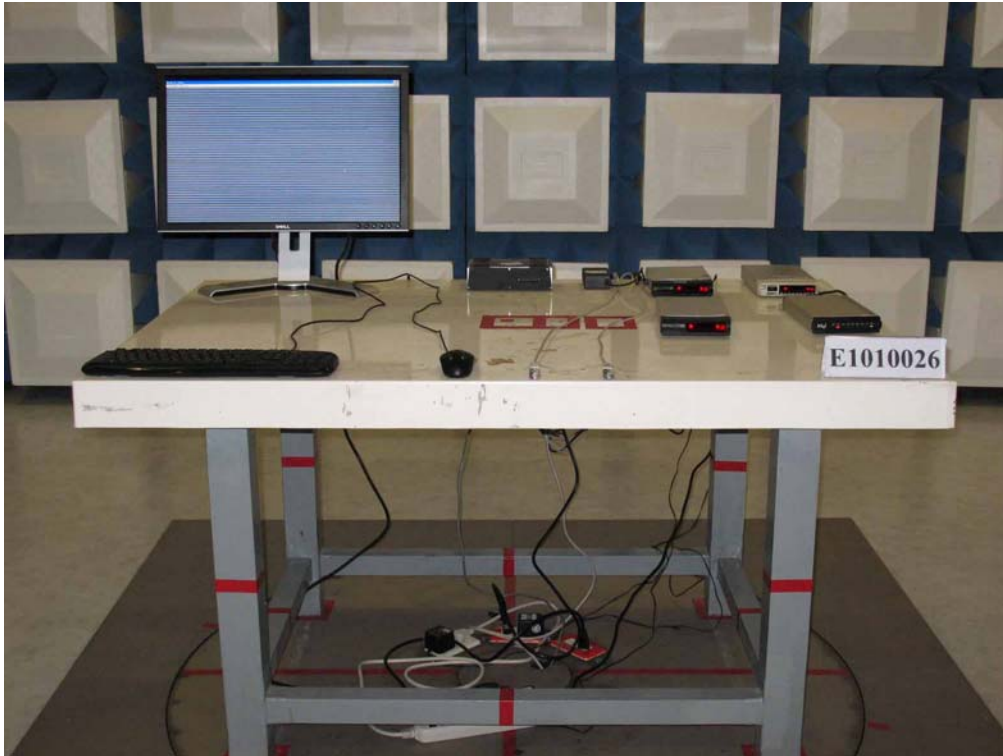



**Radiated Measurement Photos
ABOVE 1000MHZ
Mode 2**

