

Report NO: 12P010011

ACD-518R

Infotainment Remote Display

P5 Verification Test Report

Summary	<input checked="" type="checkbox"/> Pass <input type="checkbox"/> Fail <input type="checkbox"/> Pass with Deviation (Comment: _____)			
Test Results Category				
	Critical	Major	Minor	Enhancement
Defect Found	0	0	0	0
Defect Unsolved	0	0	0	0

Issue date	Approval	Test Engineer
2012/04/20	Wayne Chen	Louie Lee

Version Released Records

Date	Version	Change History	Note
2010/04/21	P3-1001	1. Re-composing test Items	
2010/06/01	P2P3-1001	1. New Test Report	
2010/06/21	P2P3-1002	1. Add BIOS -> SPI ROM Setting (South Bridge – GPIO)	
2010/12/02	P2P3-1003	1. New Test Report	
2011/02/23	P2P3-1101	1. Re-composing test Items	
2011/03/04	P2P3-1102	1. Add Specification Validation	

Note :

For all test items in this report, 3 results have been defined and described as follow:

- Pass:** Functionality work perfectly
- Fail:** Functionality failed and must be resolved in the next version
- N/A:** Functionality Not Applicable or Not Available

This test report will be updated when re-test completed in next version of the product..

Specification Verification

Engineering Specification

Item	Specification	Result	Note
Product Name	ACD-518R-Ax-1010	Pass	
Display	18.5", 1366 x768, 300 nit	Pass	
Touch Screen	ACD-518R-HT-A1 :General Glass ACD-518R-HTT-A2 :Projected Capacitive Touch Window	Pass	
Rear I/O panel	Speaker x 2 (2W)	Pass	
Front I/O panel	OSD function MENU / LCD on/off / AUTO / UP / DOWN	Pass	
Side I/O	ACD-518R-HT-A1 : w/o USB 2.0 PORT ACD-518R-HTT-A2 :USB 2.0 x 2 PORT	Pass	
Bottom I/O	ACD-518R-HT-A1: LAN x 2 / Line-out x 1/ Dip switch 1x4/ push switch x2/Power & Link LED ACD-518R-HTT-A2 : LAN x 1 / USB 2.0 x 1 port / Line-out x 1/ Dip switch 1x4/ push switch x2/Power & Link LED Line-out x 1 (when line-out · Speaker will be disabled)	Pass	Dip switch 0~F
Power Supply	DC Input 12 V w/ lock connector Built-in AC/DC power adapter , input voltage range 100~240 V	Pass	

O.S. Support

Item	Specification	Confirmed Result	Refer Chapter
Microsoft Embedded	Windows CE	N/A	
	Windows XP Embedded	N/A	
Microsoft Windows	Windows XP Professional English SP3 32 Bit	Pass	
	Windows 7 Ultimate English Version 32/64 Bit	Pass	
Linux	Linux kernel 2.6.3	Pass	

Environmental Specifications

Operating temperature	0°C ~ 40°C
Storage temperature	-4 ~ 158° F (-20 ~ 70° C)
Storage humidity	5 ~ 90% @ 40C, non-condensing
Vibration	1Grms, random, 5~500Hz, X/Y/Z axis
Shock	20G peak acceleration (11 msec. duration)
Drop	TBD (1 Corner, 3 Edge, 6 Surface)
EMC	CE /FCC class A

Note: Please refer to Environment Test Report for detail information

Platform Information

Host 1 (Used to generate video signals for testing ACD-518R) :

Item	Device Information	Test Item
System Model	GES-5500F	1,2,3,4,5,6,7,8,9
PCB Board	IMBI-QM57 A1.0	1,2,3,4,5,6,7,8,9
BIOS / Version	GES -5500F BIOS Rev0.4 11/23/2010 16:38:37	1,2,3,4,5,6,7,8,9
CPU Type	Intel Corel CPU i5-520M 2.40GHz	1,2,3,4,5,6,7,8,9
Memory Type	DSL DDR3-1066 CL7 2GB (ELPIDATWNJ1108BDSE-DJ-F 0937R90WS10) *1	1,2,3,4,5,6,7,8,9
SATA HDD	Fujitsu MH72080BH G2 80GB	1,2,3,4,5,6,7,8,9
Operating System	<input checked="" type="checkbox"/> Windows 7 Ultimate SP1 English Version 32Bit	6-2
DC Adapter	DC Power Input 12V / 5A	1,2,3,4,5,6,7,8,9
	Chipset Information with Windows 7 Ultimate SP1 English Version 32 Bit Driver Version	
Chipset Software	Intel Chipset Device Software: 9.1.1.1023(2009/11/2)	
PCH Bridge	Intel QM57	
Super IO Chipset	ITE IT8718F	
VGA Chipset	Intel HD Graphics 8.15.10.2238(2010/11/4)	
Audio Chipset	Realtek HD Audio 6.0.1.5854(2009/05/15)	
Ethernet Chipset	Intell82577LM Gigabit 11.2.19.0(2009/09/23) Intel Gigabit CT Desktop Adapter 11.0.103.0(2009/07/14)	

Summary Table of contents:

1. OSD Control Function Test.....	7
1.1. OSD Control Test.....	7
1.2. OSD On Screen Display Test	7
1.3. OSD Light Test.....	8
1.4. Modular System Industrial Workstation Function Test.....	8
1.5. Mechanism construction check.....	8
2. Basic Function Test.....	9
2.1. Video Function Test	9
2.2. Audio Function Test.....	11
2.3. LAN Function Test.....	11
2.4. Optional Function Test	12
2.5. LCD Monitor Test.....	13
3. Integration Test.....	14
3.1. USB Port Integration Test.....	14
3.2. Digital I/O Port Test	15
3.3. COM Port Integration Test.....	15
3.4. RS-422 / RS-485 Test.....	15
3.5. LPT Port Test	15
3.6. Burn In Test.....	15
4. Application Test.....	16
4.1. PCI Slot Function (PCI Adapter Card) Test.....	16
4.2. PCI-Express Function Test.....	16
4.3. Mini PCI Card Compatibility Test.....	17
4.4. CardBus (PCMCIA) Compatibility Function Test	17
4.5. ISA Slot Function Test	17
4.6. Adapter Compatibility- Industry Control Card PC/104, PC/104+, PCI-104.....	17
4.7. SSD Modules Compatibility Test	18
4.8. Peripheral Compatibility- Storage Device Test	18
4.9. Riser Card Function Test.....	19
5. Time Accuracy Test.....	19
5.1. System Clock & RTC Clock Test.....	19
5.2. Monitor Timer Test	19
5.3. Watchdog Timer Test	19
6. O.S. Compatibility Test	20
6.1. English Fedora core 15 – Kernel 2.6.38.6-26.rc1.fc15.i686.PAE	20
6.2. Windows 7 Ultimate English Version 32 Bit	21
6.3. Windows XP Ultimate English Version 32 Bit	22
7. BIOS Function Test	23
7.1. Boot Sequence Test.....	23
7.2. Power Management Test	23
7.3. Power On after Power Failure Test.....	23
7.4. AAEON Tag Check Utility	23
7.5. TPM Function Test	24
7.6. IAMT Function Test	24
7.7. Supervisor / User Password Test	24
7.8. CAN port Function Test	24
8. Performance Test	25
8.1. Performance Test	25
8.2. NOKIA Monitor Test	26
8.3. Performance Test	26
8.4. Screens Test	26
8.5. Monitor Test.....	26
8.6. Full HD 1920*1080 Test	26
9. Battery Test.....	29
9.1. Power Charge LED Test.....	29
9.2. Battery Life/Thermal Test	29
9.3. Power Option Alarm Test.....	29
10. Other Tests	錯誤! 尚未定義書籤。

10.1. Others Function Test錯誤! 尚未定義書籤。

1. OSD Control Function Test

1.1. OSD Control Test

OSD Control Function	Function			Note
	Pass	Fail	N/A	
LCD Backlight on/off	<input checked="" type="checkbox"/>	<input type="checkbox"/>	<input type="checkbox"/>	
Up / volume up	<input checked="" type="checkbox"/>	<input type="checkbox"/>	<input type="checkbox"/>	
Down / volume down	<input checked="" type="checkbox"/>	<input type="checkbox"/>	<input type="checkbox"/>	
Auto	<input checked="" type="checkbox"/>	<input type="checkbox"/>	<input type="checkbox"/>	
Menu	<input checked="" type="checkbox"/>	<input type="checkbox"/>	<input type="checkbox"/>	

1.2. OSD On Screen Display Test

OSD –On Screen Display	Function			Note
	Pass	Fail	N/A	
Sound volume(0~100)	<input checked="" type="checkbox"/>	<input type="checkbox"/>	<input type="checkbox"/>	
Image setting				
Auto Adjust	<input type="checkbox"/>	<input type="checkbox"/>	<input checked="" type="checkbox"/>	
Color Adjust	<input type="checkbox"/>	<input type="checkbox"/>	<input checked="" type="checkbox"/>	
Contrast (0~100)	<input checked="" type="checkbox"/>	<input type="checkbox"/>	<input type="checkbox"/>	
Brightness (0~100)	<input checked="" type="checkbox"/>	<input type="checkbox"/>	<input type="checkbox"/>	
Sharpness (0~4)	<input type="checkbox"/>	<input type="checkbox"/>	<input checked="" type="checkbox"/>	
H. Position	<input type="checkbox"/>	<input type="checkbox"/>	<input checked="" type="checkbox"/>	
V. Position	<input type="checkbox"/>	<input type="checkbox"/>	<input checked="" type="checkbox"/>	
Color				
9300	<input checked="" type="checkbox"/>	<input type="checkbox"/>	<input type="checkbox"/>	
6500	<input checked="" type="checkbox"/>	<input type="checkbox"/>	<input type="checkbox"/>	
5800	<input checked="" type="checkbox"/>	<input type="checkbox"/>	<input type="checkbox"/>	
SRGB	<input checked="" type="checkbox"/>	<input type="checkbox"/>	<input type="checkbox"/>	
User	R	<input checked="" type="checkbox"/>	<input type="checkbox"/>	
	G	<input checked="" type="checkbox"/>	<input type="checkbox"/>	
	B	<input checked="" type="checkbox"/>	<input type="checkbox"/>	
Exit	<input checked="" type="checkbox"/>	<input type="checkbox"/>	<input type="checkbox"/>	
OSD Menu				
OSD H.Pos. (0~100)	<input checked="" type="checkbox"/>	<input type="checkbox"/>	<input type="checkbox"/>	
OSD V.Pos. (0~100)	<input checked="" type="checkbox"/>	<input type="checkbox"/>	<input type="checkbox"/>	
OSD Timer (0~27)	<input checked="" type="checkbox"/>	<input type="checkbox"/>	<input type="checkbox"/>	
Signal Source(DVI / VGA)	<input checked="" type="checkbox"/>	<input type="checkbox"/>	<input type="checkbox"/>	DVI only
Reset	<input checked="" type="checkbox"/>	<input type="checkbox"/>	<input type="checkbox"/>	
Exit	<input checked="" type="checkbox"/>	<input type="checkbox"/>	<input type="checkbox"/>	
Language				
English	<input checked="" type="checkbox"/>	<input type="checkbox"/>	<input type="checkbox"/>	
Fran9ais	<input checked="" type="checkbox"/>	<input type="checkbox"/>	<input type="checkbox"/>	
Deutsch	<input checked="" type="checkbox"/>	<input type="checkbox"/>	<input type="checkbox"/>	
Espanol	<input checked="" type="checkbox"/>	<input type="checkbox"/>	<input type="checkbox"/>	
中文繁體	<input checked="" type="checkbox"/>	<input type="checkbox"/>	<input type="checkbox"/>	
中文簡體	<input checked="" type="checkbox"/>	<input type="checkbox"/>	<input type="checkbox"/>	
日本語	<input checked="" type="checkbox"/>	<input type="checkbox"/>	<input type="checkbox"/>	
Exit	<input checked="" type="checkbox"/>	<input type="checkbox"/>	<input type="checkbox"/>	

1.3. OSD Light Test

OSD Control Function	Function			Note
	Pass	Fail	N/A	
Power off	<input checked="" type="checkbox"/>	<input type="checkbox"/>	<input type="checkbox"/>	
Power on	<input checked="" type="checkbox"/>	<input type="checkbox"/>	<input type="checkbox"/>	
Stand by	<input checked="" type="checkbox"/>	<input type="checkbox"/>	<input type="checkbox"/>	

1.4. Modular System Industrial Workstation Function Test

Test Item	Result			Note
	Pass	Fail	N/A	
AC power outlet / inlet	<input checked="" type="checkbox"/>	<input type="checkbox"/>	<input type="checkbox"/>	
Power On / Off	<input checked="" type="checkbox"/>	<input type="checkbox"/>	<input type="checkbox"/>	
Power LED	<input type="checkbox"/>	<input type="checkbox"/>	<input checked="" type="checkbox"/>	
H.D.D LED	<input type="checkbox"/>	<input type="checkbox"/>	<input checked="" type="checkbox"/>	
DC-IN CON (+12V)	<input checked="" type="checkbox"/>	<input type="checkbox"/>	<input type="checkbox"/>	
VGA – IN (D – Sub)	<input type="checkbox"/>	<input type="checkbox"/>	<input checked="" type="checkbox"/>	
RJ45	<input checked="" type="checkbox"/>	<input type="checkbox"/>	<input type="checkbox"/>	
Touch Screen (USB Device)	<input checked="" type="checkbox"/>	<input type="checkbox"/>	<input type="checkbox"/>	
Touch Screen (RS-232 Device)	<input type="checkbox"/>	<input type="checkbox"/>	<input checked="" type="checkbox"/>	

1.5. Mechanism construction check

Test Item	Result			Note
	Pass	Fail	N/A	
Case construction check	<input type="checkbox"/>	<input type="checkbox"/>	<input checked="" type="checkbox"/>	
PCMCIA construction check	<input type="checkbox"/>	<input type="checkbox"/>	<input checked="" type="checkbox"/>	
CF Card construction check	<input type="checkbox"/>	<input type="checkbox"/>	<input checked="" type="checkbox"/>	
Component check	<input type="checkbox"/>	<input type="checkbox"/>	<input checked="" type="checkbox"/>	

2. Basic Function Test

2.1. Video Function Test

2.1.1. Single Output Function Test

Hardware Information with Windows 7 Ultimate SP1 English Version 32Bit Driver Version										
CPU	Intel Corei CPU i5-520M 2.40GHz									
Memory	DSL DDR3-1066 CL7 2GB (ELPIDATWNJ1108BDSE-DJ-F 0937R90WS10) *1									
SATA HDD	Fujitsu MH72080BH G2 80GB									
VGA	N/A									
DVI	ACD-518R									
TV	N/A									
Color Quality	<input checked="" type="checkbox"/> 16bit <input checked="" type="checkbox"/> 32bit									
Resolution	VGA			DVI			LVDS			Note
	Pass	Fail	N/A	Pass	Fail	N/A	Pass	Fail	N/A	
640X480	<input type="checkbox"/>	<input type="checkbox"/>	<input checked="" type="checkbox"/>	<input type="checkbox"/>	<input type="checkbox"/>	<input checked="" type="checkbox"/>	<input type="checkbox"/>	<input type="checkbox"/>	<input checked="" type="checkbox"/>	
800X600	<input type="checkbox"/>	<input type="checkbox"/>	<input checked="" type="checkbox"/>	<input checked="" type="checkbox"/>	<input type="checkbox"/>	<input type="checkbox"/>	<input type="checkbox"/>	<input type="checkbox"/>	<input checked="" type="checkbox"/>	
1024X768	<input type="checkbox"/>	<input type="checkbox"/>	<input checked="" type="checkbox"/>	<input checked="" type="checkbox"/>	<input type="checkbox"/>	<input type="checkbox"/>	<input type="checkbox"/>	<input type="checkbox"/>	<input checked="" type="checkbox"/>	
1152X864	<input type="checkbox"/>	<input type="checkbox"/>	<input checked="" type="checkbox"/>	<input checked="" type="checkbox"/>	<input type="checkbox"/>	<input type="checkbox"/>	<input type="checkbox"/>	<input type="checkbox"/>	<input checked="" type="checkbox"/>	
1280X600	<input type="checkbox"/>	<input type="checkbox"/>	<input checked="" type="checkbox"/>	<input type="checkbox"/>	<input type="checkbox"/>	<input checked="" type="checkbox"/>	<input type="checkbox"/>	<input type="checkbox"/>	<input checked="" type="checkbox"/>	
1280X720	<input type="checkbox"/>	<input type="checkbox"/>	<input checked="" type="checkbox"/>	<input checked="" type="checkbox"/>	<input type="checkbox"/>	<input type="checkbox"/>	<input type="checkbox"/>	<input type="checkbox"/>	<input checked="" type="checkbox"/>	
1280X768	<input type="checkbox"/>	<input type="checkbox"/>	<input checked="" type="checkbox"/>	<input checked="" type="checkbox"/>	<input type="checkbox"/>	<input type="checkbox"/>	<input type="checkbox"/>	<input type="checkbox"/>	<input checked="" type="checkbox"/>	
1280X960	<input type="checkbox"/>	<input type="checkbox"/>	<input checked="" type="checkbox"/>	<input type="checkbox"/>	<input type="checkbox"/>	<input checked="" type="checkbox"/>	<input type="checkbox"/>	<input type="checkbox"/>	<input checked="" type="checkbox"/>	
1280X1024	<input type="checkbox"/>	<input type="checkbox"/>	<input checked="" type="checkbox"/>	<input type="checkbox"/>	<input type="checkbox"/>	<input checked="" type="checkbox"/>	<input type="checkbox"/>	<input type="checkbox"/>	<input checked="" type="checkbox"/>	
1360X768	<input type="checkbox"/>	<input type="checkbox"/>	<input checked="" type="checkbox"/>	<input checked="" type="checkbox"/>	<input type="checkbox"/>	<input type="checkbox"/>	<input type="checkbox"/>	<input type="checkbox"/>	<input checked="" type="checkbox"/>	
1366X768	<input type="checkbox"/>	<input type="checkbox"/>	<input checked="" type="checkbox"/>	<input checked="" type="checkbox"/>	<input type="checkbox"/>	<input type="checkbox"/>	<input type="checkbox"/>	<input type="checkbox"/>	<input checked="" type="checkbox"/>	
1400X1050	<input type="checkbox"/>	<input type="checkbox"/>	<input checked="" type="checkbox"/>	<input type="checkbox"/>	<input type="checkbox"/>	<input checked="" type="checkbox"/>	<input type="checkbox"/>	<input type="checkbox"/>	<input checked="" type="checkbox"/>	
1600X900	<input type="checkbox"/>	<input type="checkbox"/>	<input checked="" type="checkbox"/>	<input type="checkbox"/>	<input type="checkbox"/>	<input checked="" type="checkbox"/>	<input type="checkbox"/>	<input type="checkbox"/>	<input checked="" type="checkbox"/>	
1600X1200	<input type="checkbox"/>	<input type="checkbox"/>	<input checked="" type="checkbox"/>	<input type="checkbox"/>	<input type="checkbox"/>	<input checked="" type="checkbox"/>	<input type="checkbox"/>	<input type="checkbox"/>	<input checked="" type="checkbox"/>	
1600X1050	<input type="checkbox"/>	<input type="checkbox"/>	<input checked="" type="checkbox"/>	<input type="checkbox"/>	<input type="checkbox"/>	<input checked="" type="checkbox"/>	<input type="checkbox"/>	<input type="checkbox"/>	<input checked="" type="checkbox"/>	
1792X1344	<input type="checkbox"/>	<input type="checkbox"/>	<input checked="" type="checkbox"/>	<input type="checkbox"/>	<input type="checkbox"/>	<input checked="" type="checkbox"/>	<input type="checkbox"/>	<input type="checkbox"/>	<input checked="" type="checkbox"/>	
1856X1392	<input type="checkbox"/>	<input type="checkbox"/>	<input checked="" type="checkbox"/>	<input type="checkbox"/>	<input type="checkbox"/>	<input checked="" type="checkbox"/>	<input type="checkbox"/>	<input type="checkbox"/>	<input checked="" type="checkbox"/>	
1920X1080	<input type="checkbox"/>	<input type="checkbox"/>	<input checked="" type="checkbox"/>	<input type="checkbox"/>	<input type="checkbox"/>	<input checked="" type="checkbox"/>	<input type="checkbox"/>	<input type="checkbox"/>	<input checked="" type="checkbox"/>	
1920X1200	<input type="checkbox"/>	<input type="checkbox"/>	<input checked="" type="checkbox"/>	<input type="checkbox"/>	<input type="checkbox"/>	<input checked="" type="checkbox"/>	<input type="checkbox"/>	<input type="checkbox"/>	<input checked="" type="checkbox"/>	
1920X1440	<input type="checkbox"/>	<input type="checkbox"/>	<input checked="" type="checkbox"/>	<input type="checkbox"/>	<input type="checkbox"/>	<input checked="" type="checkbox"/>	<input type="checkbox"/>	<input type="checkbox"/>	<input checked="" type="checkbox"/>	
2048X1536	<input type="checkbox"/>	<input type="checkbox"/>	<input checked="" type="checkbox"/>	<input type="checkbox"/>	<input type="checkbox"/>	<input checked="" type="checkbox"/>	<input type="checkbox"/>	<input type="checkbox"/>	<input checked="" type="checkbox"/>	
Rotation	<input type="checkbox"/>	<input type="checkbox"/>	<input checked="" type="checkbox"/>	<input checked="" type="checkbox"/>	<input type="checkbox"/>	<input type="checkbox"/>	<input type="checkbox"/>	<input type="checkbox"/>	<input checked="" type="checkbox"/>	Rotation (0 / 90 /180 /270)

Note: Pay attention to Full Screen under POST screen and Text Mode.

2.1.2. Dual Output Function Test

Selection	Output	Result			Note
		Pass	Fail	N/A	
Dual Display Clone	VGA + DVI	<input checked="" type="checkbox"/>	<input type="checkbox"/>	<input type="checkbox"/>	
Dual Display Twin		<input type="checkbox"/>	<input type="checkbox"/>	<input checked="" type="checkbox"/>	
Extended Desktop		<input checked="" type="checkbox"/>	<input type="checkbox"/>	<input type="checkbox"/>	
Dual Display Clone	VGA + LVDS	<input type="checkbox"/>	<input type="checkbox"/>	<input checked="" type="checkbox"/>	
Dual Display Twin		<input type="checkbox"/>	<input type="checkbox"/>	<input checked="" type="checkbox"/>	
Extended Desktop		<input type="checkbox"/>	<input type="checkbox"/>	<input checked="" type="checkbox"/>	

2.1.3. Video Resolution Test

Test points:

1. Power on without inserting any VGA connector until system reaches Windows desktop
2. Plug VGA connector into test machine while the system is booting to Windows; then check VGA driver and display.
3. Check brightness level and screen behavior of the monitor connected VGA output. The phenomena, normal "Ghost Image" or "Flicker", should be watched carefully.

	Result			Note
	Pass	Fail	N/A	
In Windows Desktop	<input checked="" type="checkbox"/>	<input type="checkbox"/>	<input type="checkbox"/>	

2.1.4. Video Resolution Test

LVDS Model	Result			Note
	Pass	Fail	N/A	
1_AUO G065VN01 V.0 / 6.5" / 640x480 / 18bit (4:3)	<input type="checkbox"/>	<input type="checkbox"/>	<input checked="" type="checkbox"/>	
2_AUO G065VN01 V.0 / 6.5" / 640x480 / 24bit (4:3)	<input type="checkbox"/>	<input type="checkbox"/>	<input checked="" type="checkbox"/>	
3_Data Image 7" / 800*480 / 18bit (16:9)	<input type="checkbox"/>	<input type="checkbox"/>	<input checked="" type="checkbox"/>	
4_AU G084SN05 V.3 / 8.4" / 800*600 / 18bit (4:3)	<input type="checkbox"/>	<input type="checkbox"/>	<input checked="" type="checkbox"/>	
5_AU B104SN02 V.0 / 10.4" / 800*600 / 18bit (4:3)	<input type="checkbox"/>	<input type="checkbox"/>	<input checked="" type="checkbox"/>	
6_AUO G084SN05 v7 / 8.4" / 800*600 / 24bit (4:3)	<input type="checkbox"/>	<input type="checkbox"/>	<input checked="" type="checkbox"/>	
7_AU G150XG01 V.0 / 15" / 1024*768 / 18bit (4:3)	<input type="checkbox"/>	<input type="checkbox"/>	<input checked="" type="checkbox"/>	
8_AU M150XN07 V.2 / 15" / 1024x768 / 24bit (4 :3)	<input type="checkbox"/>	<input type="checkbox"/>	<input checked="" type="checkbox"/>	
9_Toshiba /12.1"/1280 x 768 x 18bit (16:9)	<input type="checkbox"/>	<input type="checkbox"/>	<input checked="" type="checkbox"/>	
10_AU M170EG01 V.D/ 17" / 1280*1024 / 48bit (4 :3)	<input type="checkbox"/>	<input type="checkbox"/>	<input checked="" type="checkbox"/>	
11_AU M170XW01 V.1 / 17" / 1280x768 / 24bit (16 :9)	<input type="checkbox"/>	<input type="checkbox"/>	<input checked="" type="checkbox"/>	
12_AUO T260XW02 / 26" / 1366x768 / 24bit	<input type="checkbox"/>	<input type="checkbox"/>	<input checked="" type="checkbox"/>	
13_AU M201UN02 V.5 / 20.1" / 1600x1200x48bit	<input type="checkbox"/>	<input type="checkbox"/>	<input checked="" type="checkbox"/>	
14_AUO T370HW01 / 37" / 1920x1080 / 48bit	<input type="checkbox"/>	<input type="checkbox"/>	<input checked="" type="checkbox"/>	
15_AUO M190PW01 V0 / 19"/1440X900/48 bit	<input type="checkbox"/>	<input type="checkbox"/>	<input checked="" type="checkbox"/>	





2.2. Audio Function Test

[] No Support

Function Test	Result			Note	
	Pass	Fail	N/A		
L (Left) Channel	<input checked="" type="checkbox"/>	<input type="checkbox"/>	<input type="checkbox"/>	Line out function	
R (Right) Channel	<input checked="" type="checkbox"/>	<input type="checkbox"/>	<input type="checkbox"/>		
CD_In	<input type="checkbox"/>	<input type="checkbox"/>	<input checked="" type="checkbox"/>		
Line In	<input checked="" type="checkbox"/>	<input type="checkbox"/>	<input type="checkbox"/>	For ACG-203	
MICROPHONE	<input type="checkbox"/>	<input type="checkbox"/>	<input checked="" type="checkbox"/>		
6-channel mode for 5.1 speaker output	<input type="checkbox"/>	<input type="checkbox"/>	<input checked="" type="checkbox"/>		
8-channel mode for 7.1 speaker output	<input type="checkbox"/>	<input type="checkbox"/>	<input checked="" type="checkbox"/>		
S/P DIF function Test	Input	<input type="checkbox"/>	<input type="checkbox"/>	<input checked="" type="checkbox"/>	
	Output	<input type="checkbox"/>	<input type="checkbox"/>	<input checked="" type="checkbox"/>	

2.3. LAN Function Test

[] No Support

Function Test with 100M CAT6 LAN cable									
1000MBps LAN HUB		CISCO							
100MBps LAN HUB		N/A							
10MBps LAN HUB		N/A							
OnBoard LAN1		N/A			MAC Address			N/A	
OnBoard LAN2		N/A			MAC Address			N/A	
LAN Speed	Link / Active LED	Speed LED	LAN 1			LAN 2			Note
			Pass	Fail	N/A	Pass	Fail	N/A	
HOST ACG203 1000MBps			<input checked="" type="checkbox"/>	<input type="checkbox"/>	<input type="checkbox"/>	<input type="checkbox"/>	<input type="checkbox"/>	<input checked="" type="checkbox"/>	Speed LED 1G→Green 100M→Non LED
Client ACD-518R 1000MBps			<input checked="" type="checkbox"/>	<input type="checkbox"/>	<input type="checkbox"/>	<input checked="" type="checkbox"/>	<input type="checkbox"/>	<input type="checkbox"/>	A1 Version, RJ45 *2 A2 Version, RJ45 *1
DHCP Function			<input checked="" type="checkbox"/>	<input type="checkbox"/>	<input type="checkbox"/>	<input checked="" type="checkbox"/>	<input type="checkbox"/>	<input type="checkbox"/>	
1080P Video play test			<input checked="" type="checkbox"/>	<input type="checkbox"/>	<input type="checkbox"/>	<input checked="" type="checkbox"/>	<input type="checkbox"/>	<input type="checkbox"/>	
Internet ping test			<input type="checkbox"/>	<input type="checkbox"/>	<input checked="" type="checkbox"/>	<input type="checkbox"/>	<input type="checkbox"/>	<input checked="" type="checkbox"/>	

2.3.2. Throughput Test

No Support

DUT Platform Information:

<input type="checkbox"/>	Fedora Core 13
<input type="checkbox"/>	Cent 5.5
<input type="checkbox"/>	Ubuntu 10.1
<input type="checkbox"/>	Red Hat

Note : Connection-Level Performance (Interaction Constants Duration Time Set to 60 Sec.)

Graphics Media	N/A
LAN	N/A
Audio Driver	N/A

SMB Platform Information:

Chassis	SPIRENT Smartbits 600B
Chassis Version	2.80.003 (Cur) 2.50.000
Chassis Serial #	06014047
Library	6.00-29
API	5.50.42.01
File	0550042
Module	2 * LAN-3324A SmartMetrics XD 4-Port 10/100/1000Base-T Gigabit Ethernet
Test Software	SmartFlow5.50.42.1

Test Result: No Support

2.4. Optional Function Test

No Support

Function Test	Result			Note
	Pass	Fail	N/A	
3G Module	<input type="checkbox"/>	<input type="checkbox"/>	<input type="checkbox"/>	
GPRS	<input type="checkbox"/>	<input type="checkbox"/>	<input type="checkbox"/>	
Wireless LAN	<input type="checkbox"/>	<input type="checkbox"/>	<input type="checkbox"/>	
Bluetooth	<input type="checkbox"/>	<input type="checkbox"/>	<input type="checkbox"/>	

2.5. LCD Monitor Test

Monitor Integration Test			Result			Note
			Pass	Fail	N/A	
DVI display only	Win 7	1_Play 720P video file(RM)	<input checked="" type="checkbox"/>	<input type="checkbox"/>	<input type="checkbox"/>	
		2_Play 720P video file(WMV)	<input checked="" type="checkbox"/>	<input type="checkbox"/>	<input type="checkbox"/>	
		3_Play 1080P video file (RM)	<input checked="" type="checkbox"/>	<input type="checkbox"/>	<input type="checkbox"/>	
		4_Play 1080P video file (WMV)	<input checked="" type="checkbox"/>	<input type="checkbox"/>	<input type="checkbox"/>	
		5_Play 1080P video file (MPEG)	<input checked="" type="checkbox"/>	<input type="checkbox"/>	<input type="checkbox"/>	
		6_Play 1080P video file(MKV)	<input checked="" type="checkbox"/>	<input type="checkbox"/>	<input type="checkbox"/>	
	WinXP	1_Play 720P video file(RM)	<input checked="" type="checkbox"/>	<input type="checkbox"/>	<input type="checkbox"/>	
		2_Play 720P video file(WMV)	<input checked="" type="checkbox"/>	<input type="checkbox"/>	<input type="checkbox"/>	
		3_Play 1080P video file (RM)	<input checked="" type="checkbox"/>	<input type="checkbox"/>	<input type="checkbox"/>	
		4_Play 1080P video file (WMV)	<input checked="" type="checkbox"/>	<input type="checkbox"/>	<input type="checkbox"/>	
		5_Play 1080P video file (MPEG)	<input checked="" type="checkbox"/>	<input type="checkbox"/>	<input type="checkbox"/>	
		6_Play 1080P video file(MKV)	<input checked="" type="checkbox"/>	<input type="checkbox"/>	<input type="checkbox"/>	

3. Integration Test

	Hardware Information with Windows 7 Ultimate SP1 English Version 32 Bit Driver Version
CPU	Intel(R) Core(TM) CPU i5-520M 2.40GHz
Memory	DSL DDR3-1066 CL7 2GB (ELPIDATWVJ1108BDSE-DJ-F 0937R90WS10) *1
SATA HDD	Fujitsu MH72080BH G2 80GB
HOST	ACG-203 A2
Client display	AGD317R A2
	Chipset Information with Windows 7 Ultimate SP1 English Version 32 Bit Driver Version
Chipset Software	Intel(R) Chipset Device Software: 9.1.1.1023(2009/11/2)
PCH Bridge	Intel QM57
Super IO Chipset	ITE IT8718F
VGA Chipset	Intel(R) HD Graphics 8.15.10.2238(2010/11/4)
Audio Chipset	Realtek HD Audio 6.0.1.5854(2009/05/15)
Ethernet Chipset	Intel(R)82577LM Gigabit 11.2.19.0(2009/09/23) Intel(R) Gigabit CT Desktop Adapter 11.0.103.0(2009/07/14)

3.1. USB Port Integration Test

Item	USB Port	Boot			Function(Win7)			Note
		Pass	Fail	N/A	Pass	Fail	N/A	
USB HDD		<input checked="" type="checkbox"/>	<input type="checkbox"/>	<input type="checkbox"/>	<input checked="" type="checkbox"/>	<input type="checkbox"/>	<input type="checkbox"/>	
USB FDD Mitsumi D353GUE		<input type="checkbox"/>	<input type="checkbox"/>	<input checked="" type="checkbox"/>	<input type="checkbox"/>	<input type="checkbox"/>	<input checked="" type="checkbox"/>	
SONY USB2.0 DVD-R/W DRX-830UL		<input checked="" type="checkbox"/>	<input type="checkbox"/>	<input type="checkbox"/>	<input checked="" type="checkbox"/>	<input type="checkbox"/>	<input type="checkbox"/>	
USB Hub Test (Connect USB Device) HUB Port1: USB Keyboard / HUB Port2: USB Mouse / HUB Port3: USB HDD								
USB 2.0 HUB PowerSync / USB 2.0 4 Port HU-155					<input checked="" type="checkbox"/>	<input type="checkbox"/>	<input type="checkbox"/>	

Peripheral Devices Test List

USB Port Integration Test		Result			Note
		Pass	Fail	N/A	
USB KB	1_Microsoft Wired Keyboard600	<input checked="" type="checkbox"/>	<input type="checkbox"/>	<input type="checkbox"/>	
	2_Logitech Y-U0011	<input checked="" type="checkbox"/>	<input type="checkbox"/>	<input type="checkbox"/>	
USB MS	1_Logitech M-U0003	<input checked="" type="checkbox"/>	<input type="checkbox"/>	<input type="checkbox"/>	
	2_Microsoft 1113	<input checked="" type="checkbox"/>	<input type="checkbox"/>	<input type="checkbox"/>	
USB Flash	1_Kingston DT Ultimate G2 16GB USB3.0	<input checked="" type="checkbox"/>	<input type="checkbox"/>	<input type="checkbox"/>	
	2_ADATA C802 2GB	<input checked="" type="checkbox"/>	<input type="checkbox"/>	<input type="checkbox"/>	
	3_Transcend USB3.0 8GB	<input checked="" type="checkbox"/>	<input type="checkbox"/>	<input type="checkbox"/>	
USB DISK	1_Transcend TS500GSJ25D3 500GB	<input checked="" type="checkbox"/>	<input type="checkbox"/>	<input type="checkbox"/>	
	2_Generic External USB device 250GB	<input checked="" type="checkbox"/>	<input type="checkbox"/>	<input type="checkbox"/>	
USB Card Reader	1_Transcend Multi Card Reader M3	<input checked="" type="checkbox"/>	<input type="checkbox"/>	<input type="checkbox"/>	
USB DVD_ROM	1_ASUS SDRW-08D2S-U 8X DVD RW	<input checked="" type="checkbox"/>	<input type="checkbox"/>	<input type="checkbox"/>	
	2_Aopen EDR8865U DVD ROM	<input checked="" type="checkbox"/>	<input type="checkbox"/>	<input type="checkbox"/>	
USB FDD	1_MITSUMI D353FUE	<input type="checkbox"/>	<input type="checkbox"/>	<input checked="" type="checkbox"/>	
USB HUB	1_PowerSync / USB 2.0 4 Port HU-155	<input checked="" type="checkbox"/>	<input type="checkbox"/>	<input type="checkbox"/>	
	2_eSENSE 01-USE216	<input checked="" type="checkbox"/>	<input type="checkbox"/>	<input type="checkbox"/>	

3.2. Digital I/O Port Test

[X] No Support

DIO Address (___)	Result			Notes
	Pass	Fail	N/A	
DIO VCC +5V	<input type="checkbox"/>	<input type="checkbox"/>	<input type="checkbox"/>	

3.3. COM Port Integration Test

[X] No Support

Test Item	Result			Notes
	Pass	Fail	N/A	
Serial Modem Dial Out	<input type="checkbox"/>	<input type="checkbox"/>	<input type="checkbox"/>	
Serial Modem Ring In	<input type="checkbox"/>	<input type="checkbox"/>	<input type="checkbox"/>	Test with Modem
Serial Modem +12V	<input type="checkbox"/>	<input type="checkbox"/>	<input type="checkbox"/>	Test with Multimeter
Serial Modem +5V	<input type="checkbox"/>	<input type="checkbox"/>	<input type="checkbox"/>	Test with Multimeter

3.4. RS-422 / RS-485 Test

[X] No Support

Test Item	Result			Notes
	Pass	Fail	N/A	
RS-422 for COM2	<input type="checkbox"/>	<input type="checkbox"/>	<input type="checkbox"/>	Use loopback and WINSSD.exe to test RS-422 in Windows
RS-485 for COM2	<input type="checkbox"/>	<input type="checkbox"/>	<input type="checkbox"/>	Use ICP CON I-7044D D/IO Module in Windows(Support Auto flow control)
	<input type="checkbox"/>	<input type="checkbox"/>	<input type="checkbox"/>	The communication between the RS-485 port of two boards is linked with one 100m cable on Windows Terminal

3.5. LPT Port Test

[X] No Support

Test Item	Result			Notes
	Pass	Fail	N/A	
XEROX Phaser 3124 Laser Printer	<input type="checkbox"/>	<input type="checkbox"/>	<input type="checkbox"/>	

3.6. Burn In Test

Under Room Temperature: 26 °C

Test Item	Result			Note
	Pass	Fail	N/A	
BurnIn Test V6.0 Pro	<input checked="" type="checkbox"/>	<input type="checkbox"/>	<input type="checkbox"/>	Windows 7 Ultimate English Version 32 Bit

Note: COM PORT Baud Rate is set to 115200.

4. Application Test

4.1. PCI Slot Function (PCI Adapter Card) Test

[X] No Support

Adapter VGA Card	Set Simultaneous Display and Reboot			Note
	Pass	Fail	N/A	
CHAINTECH NVIDIA GeForce4 MX440-8X	<input type="checkbox"/>	<input type="checkbox"/>	<input type="checkbox"/>	
Adapter Sound Card	Play Sound			Note
	Pass	Fail	N/A	
Creative Sound BLASTER Live5.1	<input type="checkbox"/>	<input type="checkbox"/>	<input type="checkbox"/>	
Adapter SCSI Card	Copy files to SCSI HDD			Note
	Pass	Fail	N/A	
ADAPTEC Ultra160 SCSI ASC-29160	<input type="checkbox"/>	<input type="checkbox"/>	<input type="checkbox"/>	
Adapter Image Capture Card	Connect to CCD			Note
	Pass	Fail	N/A	
I-VIEW CP-1400AS (with Age STD-477FAI CCD)	<input type="checkbox"/>	<input type="checkbox"/>	<input type="checkbox"/>	
Adapter LAN Card	Connect to Internet			Note
	Pass	Fail	N/A	
Intel GD82559 10/100 Mbps Fast Ethernet Adapter	<input type="checkbox"/>	<input type="checkbox"/>	<input type="checkbox"/>	
INTEL PWLA8391GTBLK Pro/1000 Giga LAN Card	<input type="checkbox"/>	<input type="checkbox"/>	<input type="checkbox"/>	
Adapter RAID Card	RAID 0 , 1 , 10 Function Test			Note
	Pass	Fail	N/A	
ADAPTEC 1420SA RoHS 4-Port SATA II RAID	<input type="checkbox"/>	<input type="checkbox"/>	<input type="checkbox"/>	

4.2. PCI-Express Function Test

[X] No Support

PCI-Express x1	Function Test			Note
	Pass	Fail	N/A	
SUNIX SATA1414 eSATA & SATAII x1Express card	<input type="checkbox"/>	<input type="checkbox"/>	<input type="checkbox"/>	
Sysconnect SK-9E21D 10 /100/1000 Base-T Adapter PCI-Express x1 LAN Card	<input type="checkbox"/>	<input type="checkbox"/>	<input type="checkbox"/>	
PCI-Express x4	Function Test			Note
	Pass	Fail	N/A	
Adaptec AAR-1430SA SATAII HostRAID Controllers PCI-Express x4 RAID Card	<input type="checkbox"/>	<input type="checkbox"/>	<input type="checkbox"/>	
PCI-Express x16	Function Test			Note
	Pass	Fail	N/A	
ASUS EAX1600PRO/TD/256M/A (ATI Chipset) PCI-Express x16 VGA Card	<input type="checkbox"/>	<input type="checkbox"/>	<input type="checkbox"/>	
WINFAST PX6200 TC TDH PCI-Express x16 VGA Card	<input type="checkbox"/>	<input type="checkbox"/>	<input type="checkbox"/>	
Express card	Function Test			Note
	Pass	Fail	N/A	
SUNIX SATA II Express card	<input type="checkbox"/>	<input type="checkbox"/>	<input type="checkbox"/>	
SunBox 34mm Giga LAN Express Card	<input type="checkbox"/>	<input type="checkbox"/>	<input type="checkbox"/>	
Mini PCI Express Card	Function Test			Note
	Pass	Fail	N/A	

Ralink RT2571WF WLAN Mini Card (USB Interface)	<input type="checkbox"/>	<input type="checkbox"/>	<input type="checkbox"/>	
Sil3132 Mini PCI-E Function Test Card (USB Interface)	<input type="checkbox"/>	<input type="checkbox"/>	<input type="checkbox"/>	

4.3. Mini PCI Card Compatibility Test

No Support

Device Item	Function Test			Note
	Pass	Fail	N/A	
Mini PCI.10/100 Base-Tx LAN (W/Intel.82551QM .A1.0) (Model:PER-C10L)	<input type="checkbox"/>	<input type="checkbox"/>	<input type="checkbox"/>	
GM-101 WLAN 11b/g 54Mbps Mini PCI Card (Model: VNT6655AM)	<input type="checkbox"/>	<input type="checkbox"/>	<input type="checkbox"/>	
ADLINK mPCI-8750 ATI Rage XL Mini PCI VGA Card	<input type="checkbox"/>	<input type="checkbox"/>	<input type="checkbox"/>	

4.4. CardBus (PCMCIA) Compatibility Function Test

No Support

Device Item	Bit	Function Test			Note
		Pass	Fail	N/A	
Intel PRO/Wireless 2011B LAN PC Card (WPC2011BWW)	Slot 1 (Up)	<input type="checkbox"/>	<input type="checkbox"/>	<input type="checkbox"/>	[PC-200200]
	Slot 2 (Down)	<input type="checkbox"/>	<input type="checkbox"/>	<input type="checkbox"/>	
Kingston datapack DP-PCM2 / 2GB (PC Card TypeII HDD)	Slot 1 (Up)	<input type="checkbox"/>	<input type="checkbox"/>	<input type="checkbox"/>	[PC-200201]
	Slot 2 (Down)	<input type="checkbox"/>	<input type="checkbox"/>	<input type="checkbox"/>	
PCi GW-NS54SG Cardbus Adapter Wireless LAN Type-II	Slot 1 (Up)	<input type="checkbox"/>	<input type="checkbox"/>	<input type="checkbox"/>	[PC-200502]
	Slot 2 (Down)	<input type="checkbox"/>	<input type="checkbox"/>	<input type="checkbox"/>	
PCi GW-NS54SG Cardbus Adapter Wireless LAN Type-II	Slot 2 (Down)	<input type="checkbox"/>	<input type="checkbox"/>	<input type="checkbox"/>	[PC-200502]

4.5. ISA Slot Function Test

No Support

Test Item	Result	Result			Note
		Pass	Fail	N/A	
SCSI Card Adaptec AHA-1520B SCSI Card	<input type="checkbox"/>	<input type="checkbox"/>	<input type="checkbox"/>	<input type="checkbox"/>	[SS-002]
LAN Card NE2000 Compatible LAN Card (RTL8019AS)	<input type="checkbox"/>	<input type="checkbox"/>	<input type="checkbox"/>	<input type="checkbox"/>	[NW-014]
VGA Card CIRRUS LOGIC 5429 FCC ID:ICUVGA-GWV27A	<input type="checkbox"/>	<input type="checkbox"/>	<input type="checkbox"/>	<input type="checkbox"/>	[VC-008]

4.6. Adapter Compatibility- Industry Control Card PC/104, PC/104+, PCI-104

4.6.1. Device List: PC/104 Module

No Support

Test Item	Result			Notes
	Pass	Fail	N/A	
AAEON PCM-3660	<input type="checkbox"/>	<input type="checkbox"/>	<input type="checkbox"/>	

4.6.2. Device List: PC/104+ Module

No Support

Test Item	Result			Notes
	Pass	Fail	N/A	
AAEON PCM-3430	<input type="checkbox"/>	<input type="checkbox"/>	<input type="checkbox"/>	

4.6.3. Device List: PCI-104 Module

No Support

Test Item	Result			Notes
	Pass	Fail	N/A	
AAEON PCM-3730	<input type="checkbox"/>	<input type="checkbox"/>	<input type="checkbox"/>	

4.6.4. Device List: PCI/104 Express Module

No Support

Test Item	Result			Notes
	Pass	Fail	N/A	
AAEON PER-123	<input type="checkbox"/>	<input type="checkbox"/>	<input type="checkbox"/>	

4.7. SSD Modules Compatibility Test

SSD HDD Compatibility Test: No Support.

Cable Type: IDE SATA2 MLC SLC

Test Item	Result			Notes
	Pass	Fail	N/A	
Transcend SSD 16G - TS16GSSD25S	<input type="checkbox"/>	<input type="checkbox"/>	<input type="checkbox"/>	

4.8. Peripheral Compatibility- Storage Device Test

4.8.1. Disk on Chip (DOC) Test No Support.

Test Item		Result			Notes
		Pass	Fail	N/A	
DOC 2000 Model	16MB	<input type="checkbox"/>	<input type="checkbox"/>	<input type="checkbox"/>	M-System / MD2200-D16
DOC 2000 Onboard Address	CC00	<input type="checkbox"/>	<input type="checkbox"/>	<input type="checkbox"/>	
	D000	<input type="checkbox"/>	<input type="checkbox"/>	<input type="checkbox"/>	
	D400	<input type="checkbox"/>	<input type="checkbox"/>	<input type="checkbox"/>	
	D800	<input type="checkbox"/>	<input type="checkbox"/>	<input type="checkbox"/>	
	DC00	<input type="checkbox"/>	<input type="checkbox"/>	<input type="checkbox"/>	
	Disable	<input type="checkbox"/>	<input type="checkbox"/>	<input type="checkbox"/>	

4.8.2. Disk on module (DOM) Test

No Support.

Test Item	Result			Notes
	Pass	Fail	N/A	
Transcend / TS512MDOM40V / 512MB / IDE 40 Pin	<input type="checkbox"/>	<input type="checkbox"/>	<input type="checkbox"/>	
Transcend / TS512MDOM44V / 512MB / IDE 44 Pin	<input type="checkbox"/>	<input type="checkbox"/>	<input type="checkbox"/>	

4.9. Riser Card Function Test

[X] No Support.

Test Item	Result			Note
	Pass	Fail	N/A	
LAN	<input type="checkbox"/>	<input type="checkbox"/>	<input type="checkbox"/>	
PCI Slot	<input type="checkbox"/>	<input type="checkbox"/>	<input type="checkbox"/>	
PCI-e Slot	<input type="checkbox"/>	<input type="checkbox"/>	<input type="checkbox"/>	

5. Time Accuracy Test

5.1. System Clock & RTC Clock Test

Under Room Temperature: 26 °C

Item Function	Time Interval	Margin for error	Actual	Result			Note
				Pass	Fail	N/A	
RTC Clock in Power On Mode	24 hrs	+/-2 sec	Sec	<input type="checkbox"/>	<input type="checkbox"/>	<input checked="" type="checkbox"/>	
RTC Clock in Power Off Mode	24 hrs	+/-2 sec	Sec	<input type="checkbox"/>	<input type="checkbox"/>	<input checked="" type="checkbox"/>	

5.2. Monitor Timer Test

Installation	Actual		Note
Power On	2.60	Sec	Press the Power Button till recovery signal
Power OFF	1.25	Sec	Press the Power Button till no signal

5.3. Watchdog Timer Test

Use Function as below:

[X] No Support.

Time-Out Interval	Margin for error	Actual	Result			Note
			Pass	Fail	N/A	
10 sec	+/-2 sec	Sec	<input type="checkbox"/>	<input type="checkbox"/>	<input type="checkbox"/>	
60 sec	+/-2 sec	Sec	<input type="checkbox"/>	<input type="checkbox"/>	<input type="checkbox"/>	
255 sec	+/-2 sec	Sec	<input type="checkbox"/>	<input type="checkbox"/>	<input type="checkbox"/>	

Note : Under Room Temperature: 26°C / DOS Mode

6. O.S. Compatibility Test

6.1. English Fedora core 15 – Kernel 2.6.38.6-26.rc1.fc15.i686.PAE

[] No Support

Driver Information:

Chipset Software	System default
Graphics Media	System default
Audio Driver	System default
LAN Driver	System default

Install OS to SATA HDD:

Installation	Result			Note
	Pass	Fail	N/A	
Fedora core 15 – Kernel 2.6.38.6-26.rc1.fc15.i686.PAE	<input checked="" type="checkbox"/>	<input type="checkbox"/>	<input type="checkbox"/>	Type uname -a

Test Result:

Test Item	Result			Note
	Pass	Fail	N/A	
Display Function Test				
VGA -- Full Screen	<input type="checkbox"/>	<input type="checkbox"/>	<input checked="" type="checkbox"/>	
DVI -- Full Screen	<input checked="" type="checkbox"/>	<input type="checkbox"/>	<input type="checkbox"/>	
Network Function Test				
Connect to Internet – LAN 1	<input type="checkbox"/>	<input type="checkbox"/>	<input checked="" type="checkbox"/>	
Connect to Internet – LAN 2	<input type="checkbox"/>	<input type="checkbox"/>	<input checked="" type="checkbox"/>	
Audio Function Test				
Play Audio Function Test	<input type="checkbox"/>	<input type="checkbox"/>	<input checked="" type="checkbox"/>	Play Audio Test
Base Function Test				
USB Mouse Test	<input checked="" type="checkbox"/>	<input type="checkbox"/>	<input type="checkbox"/>	A2 version
USB Keyboard Test	<input checked="" type="checkbox"/>	<input type="checkbox"/>	<input type="checkbox"/>	A2 version
Console Redirection	<input type="checkbox"/>	<input type="checkbox"/>	<input checked="" type="checkbox"/>	
CD-ROM Test	<input type="checkbox"/>	<input type="checkbox"/>	<input checked="" type="checkbox"/>	
USB 2.0 Removable Devices	<input checked="" type="checkbox"/>	<input type="checkbox"/>	<input type="checkbox"/>	A2 version
Touch Function	<input checked="" type="checkbox"/>	<input type="checkbox"/>	<input type="checkbox"/>	A2 version
X Windows Application				
Start Button Office	<input checked="" type="checkbox"/>	<input type="checkbox"/>	<input type="checkbox"/>	Office function
X-Window	<input checked="" type="checkbox"/>	<input type="checkbox"/>	<input type="checkbox"/>	Startx – Desktop in Linux
Command Test On Text Mode: Attention Delay Phenomenon				
uname -a	<input checked="" type="checkbox"/>	<input type="checkbox"/>	<input type="checkbox"/>	Show information
Shutdown	<input checked="" type="checkbox"/>	<input type="checkbox"/>	<input type="checkbox"/>	Init 0 or shutdown -h now
Restart the Computer	<input checked="" type="checkbox"/>	<input type="checkbox"/>	<input type="checkbox"/>	Init 6 or shutdown -r now
Halt	<input checked="" type="checkbox"/>	<input type="checkbox"/>	<input type="checkbox"/>	Power Off Mode
ls / clear; cd /dev /ls -l	<input checked="" type="checkbox"/>	<input type="checkbox"/>	<input type="checkbox"/>	Command instruction

6.2. Windows 7 Ultimate English Version 32 Bit

[X] x32 Driver Information:

Chipset Software	Intel(R) Chipset Device Software: 9.1.1.1023(2009/11/2)
Graphics Media	Intel(R) HD Graphics 8.15.10.2238(2010/11/4)
Audio Driver	Realtek HD Audio 6.0.1.5854(2009/05/15)
LAN Driver	Intel(R)82577LM Gigabit 11.2.19.0(2009/09/23) Intel(R) Gigabit CT Desktop Adapter 11.0.103.0(2009/07/14)

[X] x64 Driver Information:

Chipset Software	Intel(R) Chipset Device Software: 9.1.1.1023(2009/11/2)
Graphics Media	Intel(R)GMA HD 8.15.10.1995(2009/11/6)
Audio Driver	Realtek HD Audio 6.0.1.5854(2009/05/15)
LAN Driver	Intel(R)82577LM Gigabit 11.2.19.0(2009/09/23) Intel(R) Gigabit CT Desktop Adapter 11.0.103.0(2009/07/14)

Install OS to SATA HDD:

Installation	Result			Note
	Pass	Fail	N/A	
English Windows 7 Ultimate ACPI Mode	<input checked="" type="checkbox"/>	<input type="checkbox"/>	<input type="checkbox"/>	

Test Results:

Test Item	Result			Note
	Pass	Fail	N/A	
Single Display				
DVI -- Full Screen	<input checked="" type="checkbox"/>	<input type="checkbox"/>	<input type="checkbox"/>	
Boot - Windows 7 Ultimate Advanced Options Menu				
Safe Mode	<input checked="" type="checkbox"/>	<input type="checkbox"/>	<input type="checkbox"/>	
Basic Function Test				
PS/2 Mouse and Keyboard	<input type="checkbox"/>	<input type="checkbox"/>	<input checked="" type="checkbox"/>	
USB Mouse and Keyboard	<input checked="" type="checkbox"/>	<input type="checkbox"/>	<input type="checkbox"/>	A2 Version
USB 2.0 Removable Devices	<input checked="" type="checkbox"/>	<input type="checkbox"/>	<input type="checkbox"/>	A2 Version
Touch Function	<input checked="" type="checkbox"/>	<input type="checkbox"/>	<input type="checkbox"/>	A2 Version
LAN Function Test				
LAN1 --- Auto	<input checked="" type="checkbox"/>	<input type="checkbox"/>	<input type="checkbox"/>	
LAN2 --- Auto	<input checked="" type="checkbox"/>	<input type="checkbox"/>	<input type="checkbox"/>	A1 Version
Audio Function Test				
Line Out Test	<input checked="" type="checkbox"/>	<input type="checkbox"/>	<input type="checkbox"/>	For ACD-518R
Line In Test	<input checked="" type="checkbox"/>	<input type="checkbox"/>	<input type="checkbox"/>	For ACG-203
Start Menu				
Log off User	<input checked="" type="checkbox"/>	<input type="checkbox"/>	<input type="checkbox"/>	
Shut down (S5)	<input checked="" type="checkbox"/>	<input type="checkbox"/>	<input type="checkbox"/>	
Standby	<input checked="" type="checkbox"/>	<input type="checkbox"/>	<input type="checkbox"/>	
Restart	<input checked="" type="checkbox"/>	<input type="checkbox"/>	<input type="checkbox"/>	
Hibernate (S4)	<input checked="" type="checkbox"/>	<input type="checkbox"/>	<input type="checkbox"/>	
1920*1080 Full HD movie test				
A2 Version, one to one network	<input checked="" type="checkbox"/>	<input type="checkbox"/>	<input type="checkbox"/>	a. ACG-203 → ACD-518R b. ACG-203 → HUB → ACD-518R
A1 Version, one to multiple network	<input checked="" type="checkbox"/>	<input type="checkbox"/>	<input type="checkbox"/>	ACG-203 → HUB → ACD-518R ↘ ACD-518R ↘ ACD-518R (one to three)

6.3. Windows XP Ultimate English Version 32 Bit

[X] x32 Driver Information:

Chipset Software	Intel(R) Chipset Device Software: 9.1.1.1023(2009/11/2)
Graphics Media	Intel(R)GMA HD 6.14.10.5179(2009/11/9)
Audio Driver	Realtek HD Audio 5.10.0.5854(2009/05/15)
LAN Driver	Intel(R)82577LM Gigabit 11.2.19.0(2009/09/23) Intel(R) Gigabit CT Desktop Adapter 11.1.6.0(2009/07/13)

Install OS to SATA HDD:

Installation	Result			Note
	Pass	Fail	N/A	
English Windows XP Ultimate ACPI Mode	<input checked="" type="checkbox"/>	<input type="checkbox"/>	<input type="checkbox"/>	

Test Results:

Test Item	Result			Note
	Pass	Fail	N/A	
Single Display				
VGA -- Full Screen	<input type="checkbox"/>	<input type="checkbox"/>	<input checked="" type="checkbox"/>	
DVI -- Full Screen	<input checked="" type="checkbox"/>	<input type="checkbox"/>	<input type="checkbox"/>	Resolution 1280*1024
LVDS -- Full Screen	<input type="checkbox"/>	<input type="checkbox"/>	<input checked="" type="checkbox"/>	
Boot - Windows XP Ultimate Advanced Options Menu				
Safe Mode	<input checked="" type="checkbox"/>	<input type="checkbox"/>	<input type="checkbox"/>	
Basic Function Test				
PS/2 Mouse and Keyboard	<input type="checkbox"/>	<input type="checkbox"/>	<input checked="" type="checkbox"/>	
USB Mouse and Keyboard	<input checked="" type="checkbox"/>	<input type="checkbox"/>	<input type="checkbox"/>	A2 Version
COM Port Mouse detect	<input type="checkbox"/>	<input type="checkbox"/>	<input checked="" type="checkbox"/>	
LPT1	<input type="checkbox"/>	<input type="checkbox"/>	<input checked="" type="checkbox"/>	
USB 2.0 Removable Devices	<input checked="" type="checkbox"/>	<input type="checkbox"/>	<input type="checkbox"/>	A2 Version
Touch Function	<input checked="" type="checkbox"/>	<input type="checkbox"/>	<input type="checkbox"/>	A2 Version
LAN Function Test				
LAN1 --- Auto	<input checked="" type="checkbox"/>	<input type="checkbox"/>	<input type="checkbox"/>	
LAN2 --- Auto	<input checked="" type="checkbox"/>	<input type="checkbox"/>	<input type="checkbox"/>	A1 Version
Audio Function Test				
Line Out Test	<input checked="" type="checkbox"/>	<input type="checkbox"/>	<input type="checkbox"/>	For ACD-518R
Line In Test	<input checked="" type="checkbox"/>	<input type="checkbox"/>	<input type="checkbox"/>	For ACG-203
Start Menu				
Log off User	<input checked="" type="checkbox"/>	<input type="checkbox"/>	<input type="checkbox"/>	
Shut down (S5)	<input checked="" type="checkbox"/>	<input type="checkbox"/>	<input type="checkbox"/>	
Standby	<input checked="" type="checkbox"/>	<input type="checkbox"/>	<input type="checkbox"/>	
Restart	<input checked="" type="checkbox"/>	<input type="checkbox"/>	<input type="checkbox"/>	
Hibernate (S4)	<input checked="" type="checkbox"/>	<input type="checkbox"/>	<input type="checkbox"/>	
1920*1080 Full HD movie test				
A2 Version one to one network	<input checked="" type="checkbox"/>	<input type="checkbox"/>	<input type="checkbox"/>	a. ACG-203→ACD-518R b. ACG-203→HUB→ACD-518R
A1 Version one to multiple network	<input checked="" type="checkbox"/>	<input type="checkbox"/>	<input type="checkbox"/>	ACG-203→HUB→ACD-518R ↘ ACD-518R ↘ ACD-518R (one to three)

7. BIOS Function Test

[X] No Support.

Hardware Information with XP Professional English SP3 32 Bit Driver Version	
CPU	N/A
Memory	N/A
HDD/CFD	N/A

7.1. Boot Sequence Test

Test Item	Result			Note
	Pass	Fail	N/A	
Floppy	<input type="checkbox"/>	<input type="checkbox"/>	<input type="checkbox"/>	
Hard Disk	<input type="checkbox"/>	<input type="checkbox"/>	<input type="checkbox"/>	
Removable (All Device Priority)	<input type="checkbox"/>	<input type="checkbox"/>	<input type="checkbox"/>	
CDROM	<input type="checkbox"/>	<input type="checkbox"/>	<input type="checkbox"/>	
USB HDD	<input type="checkbox"/>	<input type="checkbox"/>	<input type="checkbox"/>	
USB Floppy	<input type="checkbox"/>	<input type="checkbox"/>	<input type="checkbox"/>	
USB CD-ROM	<input type="checkbox"/>	<input type="checkbox"/>	<input type="checkbox"/>	
LAN [Boot From LAN First]	<input type="checkbox"/>	<input type="checkbox"/>	<input type="checkbox"/>	
Disable	<input type="checkbox"/>	<input type="checkbox"/>	<input type="checkbox"/>	
Check "Halt on" item – All error but K/B	<input type="checkbox"/>	<input type="checkbox"/>	<input type="checkbox"/>	

7.2. Power Management Test

7.2.1. APM Power Management Test

Test Item	Setting Test	Result			Note
		Pass	Fail	N/A	
Suspend Mode	Function Test	<input type="checkbox"/>	<input type="checkbox"/>	<input type="checkbox"/>	
Power Button	Delay 4 Sec	<input type="checkbox"/>	<input type="checkbox"/>	<input type="checkbox"/>	Soft-Off By PWRBTN
Power Button	Instant-Off	<input type="checkbox"/>	<input type="checkbox"/>	<input type="checkbox"/>	Soft-Off By PWRBTN

7.2.2. ACPI Power Management Test

Test Item	Result			Note
	Pass	Fail	N/A	
Enable ACPI Auto Configuration	<input type="checkbox"/>	<input type="checkbox"/>	<input type="checkbox"/>	
Enable Hibernation	<input type="checkbox"/>	<input type="checkbox"/>	<input type="checkbox"/>	From Windows 7
ACPI - S1 (POS)	<input type="checkbox"/>	<input type="checkbox"/>	<input type="checkbox"/>	Resume from PS/2 keyboard or mouse.
	<input type="checkbox"/>	<input type="checkbox"/>	<input type="checkbox"/>	Resume from USB keyboard or mouse.
ACPI - S3 (STR)	<input type="checkbox"/>	<input type="checkbox"/>	<input type="checkbox"/>	
Suspend Disable	<input type="checkbox"/>	<input type="checkbox"/>	<input type="checkbox"/>	

7.3. Power On after Power Failure Test

Test Item	Result			Note
	Pass	Fail	N/A	
Off	<input type="checkbox"/>	<input type="checkbox"/>	<input type="checkbox"/>	
On	<input type="checkbox"/>	<input type="checkbox"/>	<input type="checkbox"/>	
Former-Sts (Auto)	<input type="checkbox"/>	<input type="checkbox"/>	<input type="checkbox"/>	

7.4. AAEON Tag Check Utility

Test Item	Result			Note
	Pass	Fail	N/A	
Check AAEON BIOS OK	<input type="checkbox"/>	<input type="checkbox"/>	<input type="checkbox"/>	AONCHECK.EXE

7.5. TPM Function Test

Test Item	Result			Note
	Pass	Fail	N/A	
No Change	<input type="checkbox"/>	<input type="checkbox"/>	<input type="checkbox"/>	
Clear	<input type="checkbox"/>	<input type="checkbox"/>	<input type="checkbox"/>	
Enable & Active	<input type="checkbox"/>	<input type="checkbox"/>	<input type="checkbox"/>	
Disable & Disactive	<input type="checkbox"/>	<input type="checkbox"/>	<input type="checkbox"/>	Detect TPM device under Windows.

7.6. IAMT Function Test

Test Item	Result			Note
	Pass	Fail	N/A	
IAMT Function	<input type="checkbox"/>	<input type="checkbox"/>	<input type="checkbox"/>	

7.7. Supervisor / User Password Test

Test Item	Result			Note
	Pass	Fail	N/A	
Supervisor Password	<input type="checkbox"/>	<input type="checkbox"/>	<input type="checkbox"/>	
User Password	<input type="checkbox"/>	<input type="checkbox"/>	<input type="checkbox"/>	

7.8. CAN port Function Test

Basic Function Test					Note
Test Item	Interrupt: Polling or IRQ	Result			
		Pass	Fail	NA	
CAN1 transmits CAN2	CAN1:	<input type="checkbox"/>	<input type="checkbox"/>	<input type="checkbox"/>	
	CAN2:	<input type="checkbox"/>	<input type="checkbox"/>	<input type="checkbox"/>	
CAN2 transmits CAN1	CAN2:	<input type="checkbox"/>	<input type="checkbox"/>	<input type="checkbox"/>	
	CAN1:	<input type="checkbox"/>	<input type="checkbox"/>	<input type="checkbox"/>	

Note: Sets the interrupt for each port. Be sure that this setting matches the IRQ

8. Performance Test

Hardware Information with Windows 7 Ultimate English Version 32 Bit Driver Version	
CPU	Intel(R) Core(TM) CPU i5-520M 2.40GHz
Memory	DSL DDR3-1066 CL7 2GB (ELPIDATWVNJ1108BDSE-DJ-F 0937R90WS10) *1
SATA HDD	Fujitsu MH72080BH G2 80GB

8.1. Performance Test

Test Result: (Display set 1280*1024 test)

Testing Software	Scope		Note
	AAEON	Ref.	
PCMark2002			Only for Win 7
CPU	-	-	
Memory	31447	-	
HDD	1650	-	
Benchmark (A)	-	-	
PCMark2005			Windows 7 PCMarks
PCMark	5334	-	
CPU	6544	-	
Memory	4221	-	
Graphics	2212	-	
HDD	4446	-	
Benchmark (B)	-	-	
Average Efficiency	-	-	

Testing Software	Scope		Note
	AAEON	Ref.	
3Dmark2003 v360			Only for Win 7
3Dmark Score	2644	-	
CPU Score	1161	-	
Benchmark (A)	-	-	
3Dmark2005			Windows 7
3Dmark Score	1908	-	
CPU Score	11784	-	
Benchmark (B)	-	-	
Average Efficiency	-	-	

Testing Software	Scope		Note
	AAEON	Ref.	
Final Reality V1.01—BenchMark Test			Windows 7
2D image	38.49	-	
3D	5.26	-	
Bus transfer	29.39	-	
Overall	18.85	-	Reality marks
Benchmark (A)	-	-	

8.2. NOKIA Monitor Test

Under Room Temperature: 26 °C

	Result			
	Pass	Fail	N/A	
Nokia Monitor test	<input checked="" type="checkbox"/>	<input type="checkbox"/>	<input type="checkbox"/>	Windows 7 Ultimate English Version 32 Bit

8.3. Performance Test

Under Room Temperature: 26 °C

	Result			
	Pass	Fail	N/A	
Performance 7.0	<input checked="" type="checkbox"/>	<input type="checkbox"/>	<input type="checkbox"/>	Windows 7 Ultimate English Version 32 Bit

8.4. Screens Test

Under Room Temperature: 26 °C

	Result			
	Pass	Fail	N/A	
Test Screens	<input checked="" type="checkbox"/>	<input type="checkbox"/>	<input type="checkbox"/>	Windows 7 Ultimate English Version 32 Bit

8.5. Monitor Test

Under Room Temperature: 26 °C

	Result			
	Pass	Fail	N/A	
Monitor Test	<input checked="" type="checkbox"/>	<input type="checkbox"/>	<input type="checkbox"/>	Windows 7 Ultimate English Version 32 Bit

8.6. Full HD 1920*1080 Test

Under Room Temperature: 26 °C; OS: Windows 7 Ultimate English Version 32 Bit

Full HD Video play over 12 hours	Result			Remark
	Pass	Fail	N/A	
A2 Version with Hub	<input checked="" type="checkbox"/>	<input type="checkbox"/>	<input type="checkbox"/>	
A2 Version without Hub	<input checked="" type="checkbox"/>	<input type="checkbox"/>	<input type="checkbox"/>	

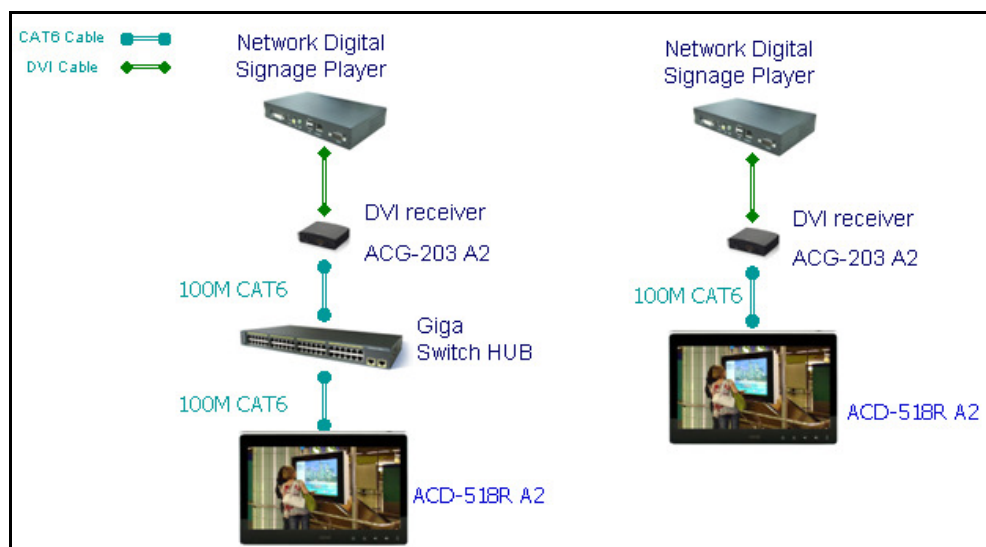

Full HD Video play over 12 hours	Result			Remark
	Pass	Fail	N/A	
A1 Version, one to one	<input checked="" type="checkbox"/>	<input type="checkbox"/>	<input type="checkbox"/>	With HUB
A1 Version, one to three	<input checked="" type="checkbox"/>	<input type="checkbox"/>	<input type="checkbox"/>	With HUB

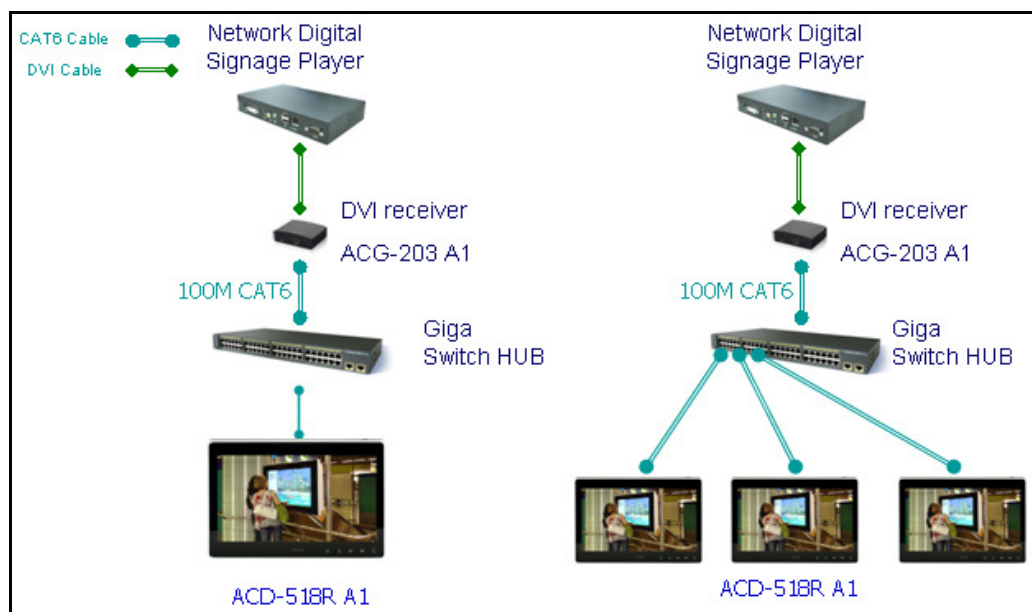

Full HD Video play over 12 hours	Result			Remark
	Pass	Fail	N/A	
A1 Version, one to nine	<input checked="" type="checkbox"/>	<input type="checkbox"/>	<input type="checkbox"/>	Use serial operation

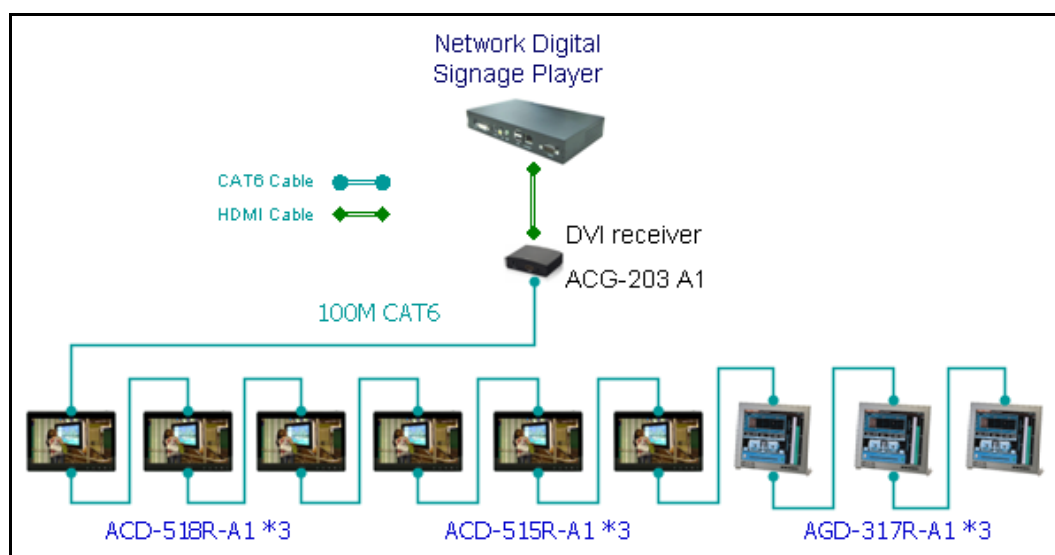

Full HD Video play over 12 hours	Result			Remark
	Pass	Fail	N/A	
Two group use same HUB: A2 Version, one to one A1 Version, one to six	<input checked="" type="checkbox"/>	<input type="checkbox"/>	<input type="checkbox"/>	A1 version use serial operation

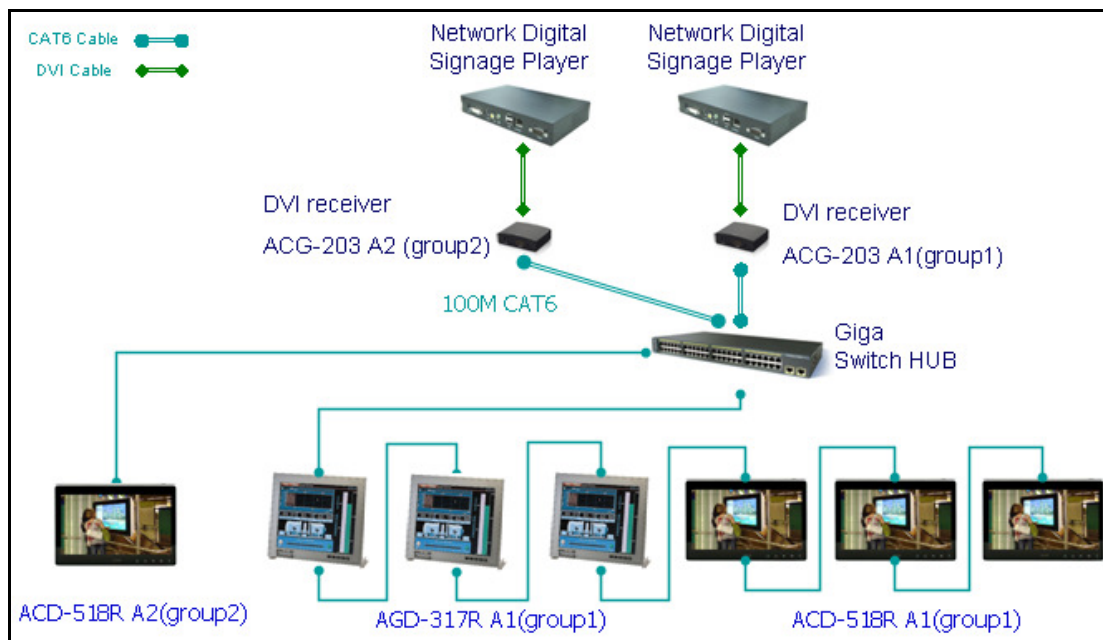

Full HD Video play over 12 hours	Result			Remark
	Pass	Fail	N/A	
Two group with same HUB: A2 Version, one to one A1 Version, one to nine	<input checked="" type="checkbox"/>	<input type="checkbox"/>	<input type="checkbox"/>	A1 Version use parallel operation

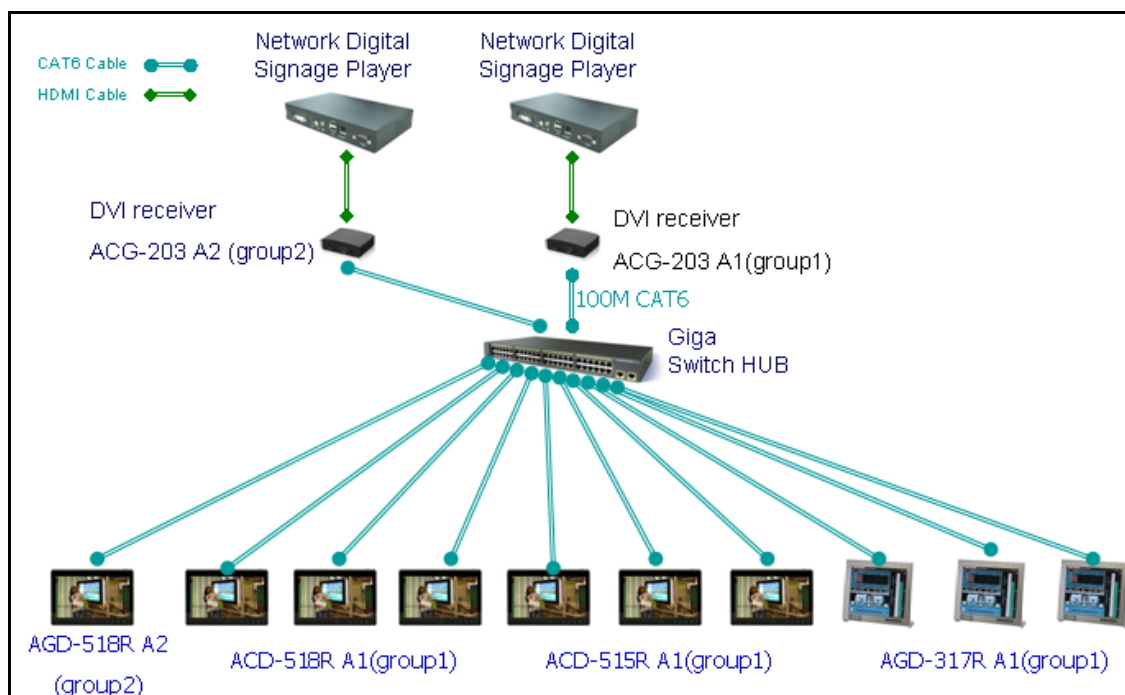

9. Battery Test

[X] No Support.

9.1. Power Charge LED Test

Power Charge LED Test	Result			Note
	Pass	Fail	N/A	
Plug the AC Power	<input type="checkbox"/>	<input type="checkbox"/>	<input type="checkbox"/>	
Unplug the AC Power	<input type="checkbox"/>	<input type="checkbox"/>	<input type="checkbox"/>	
Windows Battery icon Test	Result			Note
	Pass	Fail	N/A	
Plug the AC Power	<input type="checkbox"/>	<input type="checkbox"/>	<input type="checkbox"/>	
Unplug the AC Power	<input type="checkbox"/>	<input type="checkbox"/>	<input type="checkbox"/>	

9.2. Battery Life/Thermal Test

Battery Charge Time	Actual		SPEC		Note
Windows XP SP3 Without running any Software		mins		mins	Power level 0% charge to 99%
Battery Thermal Test					(Power level charge to 99%)
Battery Life Time	Actual		SPEC		Note
Windows XP SP3 with Prime 95 Full Loading Test		mins		mins	Power used 99% to 0%
Windows XP SP3 Without running any Software		mins		mins	Power used 99% to 0%

9.3. Power Option Alarm Test

Low Battery Alarm Actions	Result			Note
	Pass	Fail	N/A	
Display the low power message (Power level reach to 30%)	<input type="checkbox"/>	<input type="checkbox"/>	<input type="checkbox"/>	
Standby (Power level reach to 20%)	<input type="checkbox"/>	<input type="checkbox"/>	<input type="checkbox"/>	
Hibernate (Power level reach to 10%)	<input type="checkbox"/>	<input type="checkbox"/>	<input type="checkbox"/>	
Shut down (Power level reach to 3%)	<input type="checkbox"/>	<input type="checkbox"/>	<input type="checkbox"/>	