



EMC COMPLIANCE TEST REPORT

for

Industrial Display Monitor

Trade Name : N/A
Model Number : AMB-220A
Product Family : OPD-212A
Serial Number : N/A
Report Number : 02E9999-E
Date : March 20, 2002
Regulations : See below

Standards	Results (Pass/Fail)
EN 55022: 1998	PASS
EN 61000-3-2: 1995+A1: 1998+A2: 1998+A14: 2000	PASS
EN 61000-3-3: 1995	PASS
EN 50024: 1998	PASS
- IEC 61000-4-2: 1995 +A2: 2000	PASS
- IEC 61000-4-3: 1995	PASS
- IEC 61000-4-4: 1995	PASS
- IEC 61000-4-5: 1995	PASS
- IEC 61000-4-6: 1996	PASS
- IEC 61000-4-8: 1993	N/A
- IEC 61000-4-11: 1994	PASS

Prepared for :

AAEON Technology Inc.
5F, No. 135, Lane 235, Pao Chiao Rd., Hsin-Tien City,
Taipei, Taiwan, R. O. C.

Prepared by :

C&C LABORATORY CO., LTD.

#B1, 1st Fl., Universal Center,
No. 183, Sec. 1, Tatung Rd., Hsi Chin,
Taipei Hsien, Taiwan, R.O.C.

TEL: (02)86422071

FAX: (02)86422256



This report shall not be reproduced, except in full, without the written approval of
C&C Laboratory Co., Ltd.



EC-Declaration of Conformity

For the following equipment:

Industrial Display Monitor

(Product Name)

AMB-220A; OPD-212A

(Model Designation / Trade name)

AAEON Technology Inc.

(Manufacturer Name)

5F, No. 135, Lane 235, Pao Chiao Rd., Hsin-Tien City, Taipei, Taiwan, R. O. C.

(Manufacturer Address)

is herewith confirmed to comply with the requirements set out in the Council Directive on the Approximation of the Laws of the Member States relating to Electromagnetic Compatibility Directive (89/336/EEC, Amended by 92/31/EEC, 93/68/EEC & 98/13/EC), For the evaluation regarding the Electromagnetic Compatibility (89/336/EEC, Amended by 92/31/EEC & 93/68/EEC & 98/13/EC) the following standards are applied:

EN 55022: 1998

EN 61000-3-2: 1995+A1: 1998+A2: 1998+A14: 2000

EN 61000-3-3: 1995

EN50024: 1998

IEC 61000-4-2: 1995 +A2: 2000, IEC 61000-4-3: 1995, IEC 61000-4-4: 1995

IEC 61000-4-5: 1995, IEC 61000-4-6: 1996, IEC 61000-4-11: 1994

The following manufacturer / importer or authorized representative established within the EUT is responsible for this declaration:

(Company Name)

(Company Address)

Person responsible for making this declaration:

(Name, Surname)

(Position / Title)

(Place)

(Date)

(Legal Signature)

TABLE OF CONTENTS

DESCRIPTION	PAGE
VERIFICATION OF COMPLIANCE	5
GENERAL INFORMATION	6
SYSTRM DESCRIPTION	7
PRODUCT INFORMATION	8
SUPPORT EQUIPMENT	9
TEST FACILITY	10
TEST EQUIPMENT	11
SECTION 1 EN 55022(LINE CONDUCTED & RADIATED EMISSION)	14
MEASUREMENT PROCEDURE & LIMIT (LINE CONDUCTED EMISSION TEST)	14
MEASUREMENT PROCEDURE & LIMIT (RADIATED EMISSION TEST)	17
BLOCK DIAGRAM OF TEST SETUP	19
SUMMARY DATA	20
SECTION 2 EN61000-3-2 & EN 61000-3-3 (POWER HARMONICS & VOLTAGE FLUCTUATION/FLICKER)	22
BLOCK DIAGRAM OF TEST SETUP	22
RESULT	22
SECTION 3 IEC 61000-4-2 (ELECTROSTATIC DISCHARGE)	33
BLOCK DIAGRAM OF TEST SETUP	34
TEST PROCEDURE	34
PERFORMANCE & RESULT	38
SECTION 4 IEC 61000-4-3 (RADIATED ELECTROMAGNETIC FIELD)	38
BLOCK DIAGRAM OF TEST SETUP	39
TEST PROCEDURE	39
PERFORMANCE & RESULT	40

DESCRIPTION	PAGE
SECTION 5 IEC 61000-4-4 (FAST TRANSIENTS/BURST)	41
BLOCK DIAGRAM OF TEST SETUP	41
TEST PROCEDURE	42
PERFORMANCE & RESULT	42
SECTION 6 IEC 61000-4-5 (SURGE IMMUNITY)	43
BLOCK DIAGRAM OF TEST SETUP	43
TEST PROCEDURE	44
PERFORMANCE & RESULT	44
SECTION 7 IEC 61000-4-6 (CONDUCTED DISTURBANCE, INDUCED BY RADIO-FREQUENCY FIELDS)	45
BLOCK DIAGRAM OF TEST SETUP	45
TEST PROCEDURE	46
PERFORMANCE & RESULT	47
SECTION 8 IEC 61000-4-8 (Power Frequency Magnetic Field)	48
BLOCK DIAGRAM OF TEST SETUP	48
TEST PROCEDURE	49
PERFORMANCE & RESULT	49
SECTION 9 IEC 61000-4-11 (VOLTAGE DIP/INTERRUPTION)	50
BLOCK DIAGRAM OF TEST SETUP	50
TEST PROCEDURE	51
PERFORMANCE & RESULT	51
APPENDIX 1 PHOTOGRAPHS OF TEST SETUP	52
EN 55022 TEST	
EN 61000-3-2 TEST	
EN 61000-3-3 TEST	
IEC 61000-4-2 Test	
IEC 61000-4-3 Test	
IEC 61000-4-4 TEST	
IEC 61000-4-5 TEST	
IEC 61000-4-6 TEST	
IEC 61000-4-11 TEST	
APPENDIX 2 PHOTOGRAPHS OF EUT	62
APPENDIX 3 CONDUCTED EMISSION PLOT & RADIATED EMISSION DATA	71

VERIFICATION OF COMPLIANCE

Equipment Under Test: Industrial Display Monitor
Trade Name: N/A
Model Number: AMB-220A
Product Family: OPD-212A
Serial Number: N/A
Applicant: **AAEON Technology Inc.**
5F, No. 135, Lane 235, Pao Chiao Rd., Hsin-Tien City,
Taipei, Taiwan, R. O. C.
Manufacturer: **AAEON Technology Inc.**
5F, No. 135, Lane 235, Pao Chiao Rd., Hsin-Tien City,
Taipei, Taiwan, R. O. C.
Type of Test: EMC Directive 89/336/EEC for CE Marking
Technical Standards: EN 55022: 1998
EN 61000-3-2: 1995+A1: 1998+A2: 1998+A14: 2000
EN 61000-3-3: 1995
EN 50024: 1998
(IEC 61000-4-2: 1995 +A2: 2000, IEC 61000-4-3: 1995
IEC 61000-4-4: 1995, IEC 61000-4-5: 1995
IEC 61000-4-6: 1996, IEC 61000-4-11: 1994)
File Number: 02E9999-E
Date of test: March 11, 2002 & March 12, 2002
Deviation: N/A
Condition of Test Sample: Normal

The above equipment was tested by C&C Laboratory Co., Ltd. for compliance with the requirements set forth in EMC Directive 89/336/EEC and the Technical Standards mentioned above. This said equipment in the configuration described in this report shows the maximum emission levels emanating from equipment and the level of the immunity endurance of the equipment are within the compliance requirements.

The test results of this report relate only to the tested sample identified in this report.

Approved by Authorized Signatory: _____

RICK YEO / EMC MANAGER

GENERAL INFORMATION

Applicant: **AAEON Technology Inc.**
5F, No. 135, Lane 235, Pao Chiao Rd., Hsin-Tien City,
Taipei, Taiwan, R. O. C.

Contact Person: Milo Wang / Q. E. Dept. Engineer

Manufacturer: **AAEON Technology Inc.**
5F, No. 135, Lane 235, Pao Chiao Rd., Hsin-Tien City,
Taipei, Taiwan, R. O. C.

File Number: 02E9999-E

Date of Test: March 11, 2002 & March 12, 2002

Equipment Under Test: Industrial Display Monitor

Model Number: AMB-220A

Product Family: OPD-212A

Serial Number: N/A

Type of Test: EMC Directive 89/336/EEC for CE Marking

Technical Standards: EN 55022: 1998
EN 61000-3-2: 1995+A1: 1998+A2: 1998+A14: 2000
EN 61000-3-3: 1995
EN 50024: 1998
(IEC 61000-4-2: 1995 +A2: 2000, IEC 61000-4-3: 1995
IEC 61000-4-4: 1995, IEC 61000-4-5: 1995
IEC 61000-4-6: 1996, IEC 61000-4-11: 1994)

**Frequency Range
(EN 55022):** 150kHz to 30MHz for Line Conducted Test
30MHz to 1000MHz for Radiated Emission Test

Test Site **C&C LABORATORY CO., LTD.**
No. 199, Chung Sheng Road, Hsin Tien City, Taipei
Taiwan, R. O. C.

SYSTEM DESCRIPTION

EUT Test Procedure:

1. Windows 98 Boots System.
2. Run Winemc.Exe To Activate All Peripherals And Display “H” Pattern On Monitor Screen.

PRODUCT INFORMATION

Housing Type: Plastic w/ metal plate

EUT Power Rating: DC 12V from AC Adaptor

AC power during Test: 230VAC, 50Hz to AC Adaptor

AC Adaptor Manufacturer: EDAC

AC Adaptor Model Number: EA1050C

AC Power Cord Type: Unshielded, 1.8m (Detachable)

DC Power Cable Type: Shielded, 1.2m (Non-Detachable, with a ferrite core)

EUT I/O Cable (DB 9): Shielded, 1.8m (Detachable)

EUT I/O Cable (DB 15): Shielded, 1.2m (Detachable , with two ferrite cores)

OSC/Clock Frequencies : Y1= 14.318MHz; Q7= 24.576MHz; Y2= 14.318MHz

A/D Board Model: TB-86-1

LVDS Board Model: TB-903A

LCD Panel Brand / Model Number: Toshiba 12.1" / LTM12C289

Model Difference:

Model Name	Differences	Tested (Checked)
AMB-220A	Original Model	<input checked="" type="checkbox"/>
OPD-212A	Additional Model (Without the Case)	<input type="checkbox"/>

I/O Port of EUT:

I/O PORT TYPES	Q' TY	TESTED WITH
1). Serial Port (DB 9)	1	1
2). VGA Port (DB15)	1	1
3). Video (RCA)	1	1

Note: N/A

SUPPORT EQUIPMENT

No	Equipment	Model #	Serial #	FCC ID	Trade Name	Data Cable	Power Cord
1.	PS/2 Mouse	M-S34	LZE12352345	DZL211029	LOGITECH	Shielded, 1.9m	N/A
2.	Printer	2225C	2550540697	BS46XU2225C	HP	Shielded, 1.8 m	Unshielded, 1.8m
3.	Notebook	PS181L	N/A	DoC	TOSHIBA	DB9: Shielded, 1.8m DB15: Shielded, 1.2m With two ferrite cores RCA: Unshielded, 1.8m	Unshielded, 1.8m

Note: All the above equipment/cables were placed in worse case positions to maximize emission signals.

Grounding: Grounding was in accordance with the manufacturer's requirements and conditions for the intended use.

TEST FACILITY

- Location:** No. 199, Chung Sheng Road, Hsin Tien City,
Taipei, Taiwan, R. O. C.
- Description:** There are two 3/10m open area test sites and one line conducted lab for final test.
The Open Area Test Sites and the Line Conducted labs are constructed and calibrated to meet the FCC requirements in documents ANSI C63.4: 1992 and CISPR 22/EN 55022 requirements.
- Site Filing:** A site description is on file with the Federal Communications Commission, 7435 Oakland Mills Road, Columbia, MD 21046.

Registration also was made with Voluntary Control Council for Interference (VCCI).
- Site Accreditation:** Accredited by A2LA (Certificate #: 824.01) for EMC.

Also accredited by BSMI for the product category of Information Technology Equipment.
- Instrument Tolerance:** All measuring equipment is in accord with ANSI C63.4 and CISPR 22 requirements that meet industry regulatory agency and accreditation agency requirement.
- Ground Plane:** Two conductive reference ground planes were used during the Line Conducted Emission, one in vertical and the other in horizontal. The dimensions of these ground planes are as below. The vertical ground plane was placed distancing 40 cm to the rear of the wooden test table on where the EUT and the support equipment were placed during test. The horizontal ground plane projected 50 cm beyond the footprint of the EUT system and distanced 80 cm to the wooden test table. For Radiated Emission Test, one horizontal conductive ground plane extended at least 1m beyond the periphery of the EUT and the largest measuring antenna, and covered the entire area between the EUT and the antenna. It has no holes or gaps having longitudinal dimensions larger than one-tenth of a wavelength at the highest frequency of measurement up to 1GHz.

TEST EQUIPMENT LIST (EMISSION)

Instrumentation: The following list contains equipment used at C & C Laboratory, Co., Ltd. for testing. The equipment conforms to the CISPR 16-1 / ANSI C63.2-1988 Specifications for Electromagnetic Interference and Field Strength Instrumentation from 9kHz to 1.0 / 2.0 GHz.

Equipment used during the tests:

Open Area Test Site: #D

EQUIPMENT TYPE	MFR	MODEL NUMBER	SERIAL NUMBER	LAST CAL.	CAL. DUE
EMI TEST DISPLAY	R&S	DSAI-D 804.8932.52	827832/001	10/29/01	10/28/02
EMI TEST RF UNIT	R&S	ESBI-RF/1005.4300.52	827832/003	10/29/01	10/28/02
AMPLIFIER	HP	8447DB	1644A02328	05/07/01	05/06/02
ANTENNA	SCHWARZBECK	VULB 9160	3104	05/17/01	05/16/02
CABLE	TIME MICROWAVE	LMR-400	N-TYPE02	07/09/01	07/08/02

Conducted Emission Test Site: Conducted Room

EQUIPMENT TYPE	MFR	MODEL NUMBER	SERIAL NUMBER	LAST CAL.	CAL. DUE
TEST RECEIVER	R&S	ESHS20	840455/006	03/15/01	03/14/02
LISN	SOLAR	8012-50-R-24-BNC	8305114	07/23/01	07/22/02
LISN(EUT)	EMCO	3825/2	1435	01/16/02	01/15/03

The calibrations of the measuring instruments, including any accessories that may effect such calibration, are checked frequently to assure their accuracy. Adjustments are made and correction factors applied in accordance with instructions contained in the manual for the measuring instrument.

TEST EQUIPMENT LIST

For Power Harmonic & Voltage Fluctuation/Flicker Measurement:

Manufacturer/Type	Model No.	Serial No.	Last Cal.	Cal. Due
HP / Harmonic & Flicker Tester	6842A	3531A-000142	06/15/2001	06/14/2002

For ESD test:

Manufacturer/Type	Model No.	Serial No.	Last Cal.	Cal. Due
S.G. / ESD Simulator	SESD 2000	812006	02/08/2002	02/07/2003

For Radiated Electromagnetic Field immunity Measurement:

Manufacturer/Type	Model No.	Serial No.	Last Cal.	Cal. Due
R&S / Signal Generator	SMY 02	DE13751	01/10/2002	01/09/2003
IFI / "E" Field sensor/ Light Modulator Transmitter	EFS-5	713-0695	06/29/2001	06/28/2002
IFI / Combination Amplifier	SMX100	2067-1196	06/28/2001	06/27/2002
IFI / Leveling Pre-Amplifier	LPA-5B	714-0695	05/01/2001	04/30/2002
EMCO / Biconilog Antenna	3142	9609-1087	No Calibration Required	No Calibration Required

For Fast Transients/Burst test:

Manufacturer/Type	Model No.	Serial No.	Last Cal.	Cal. Due
KeyTek Instruments / EFT Generator	E421	9502326	11/01/2001	10/31/2002
KeyTek Instruments / Capacitive Clamp	CCL-4	9503290	No Calibration Required	No Calibration Required
HAEFELY TRENCH / Fast Transients/Burst Generator	PEFT- JUNIOR	583 333-117	08/21/2001	08/20/2002
HAEFELY TRENCH / Clamp	093 506.1	080 421.13	N/A	N/A

For Surge Immunity test:

Manufacturer/Type	Model No.	Serial No.	Last Cal.	Cal. Due
Surger Generator KeyTek Instruments	E501	9502324	11/01/2001	10/31/2002
Telecom Lines Coupler DECOUPLER KeyTek Instruments	CM-TELCD	0104399	05/01/2001	04/30/2002
I/O Signal Line DECOUPLER KeyTek Instruments	CM-I/OCD	0103234	05/01/2001	04/30/2002
HAEFELY TRENCH / Surge Tester	PSUGER 4010	583 334-71	09/01/2001	08/31/2002

For CS test:

Manufacturer/Type	Model No.	Serial No.	Last Cal.	Cal. Due
R&S / Signal Generator	SMY 02	DE13751	01/10/2002	01/09/2003
IFI / Combination Amplifier	SMX100	2067-1196	06/28/2001	06/27/2002
IFI / Leveling Pre-Amplifier	LPA-5B	714-0695	05/01/2001	04/30/2002
FISCHER / Power Line Coupling Decoupling Network	FCC-801-M3-16A	99122	10/27/2001	10/26/2002
FISCHER / Bulk Current Injection Probe	F-120-9B	54	10/30/2001	10/29/2002
Narda / High Power Attenuator	769-6	02541	10/26/2001	10/25/2002

For Power Frequency Magnetic Field test :

Manufacturer/Type	Model No.	Serial No.	Last Cal.	Cal. Due
Haefely / Magic Field Tester	MAG 100.1	081436-02	No Calibration Required	No Calibration Required
Extech Electronics / Frequency Converter	CFC-105	810390	No Calibration Required	No Calibration Required
CHY/ AC/DC Clamp Meter	932C	2K0900285	10/25/2001	10/24/2002

For Voltage Dips/Short Interruption and Voltage Variation Immunity test:

Manufacturer/Type	Model No.	Serial No.	Last Cal.	Cal. Due
Haefely / Dips/Inerruption/Variations Tester	PLINE 1610	081568-06	08/06/2001	08/05/2002
FLUKE / 79 Series II Multimeter	79-II	66400868	07/03/2001	07/02/2002

SECTION 1 EN 55022 (LINE CONDUCTED & RADIATED EMISSION)

MEASUREMENT PROCEDURE (PRELIMINARY LINE CONDUCTED EMISSION TEST)

- 1) The equipment was set up as per the test configuration to simulate typical actual usage per the user's manual. When the EUT is a tabletop system, a wooden table with a height of 0.8 meters is used and is placed on the ground plane as per EN 55022 (see Test Facility for the dimensions of the ground plane used). When the EUT is a floor-standing equipment, it is placed on the ground plane which has a 3-12 mm non-conductive covering to insulate the EUT from the ground plane.
- 2) Support equipment, if needed, was placed as per EN 55022.
- 3) All I/O cables were positioned to simulate typical actual usage as per EN 55022.
- 4) The EUT received DC 12V power through AC Adaptor and Line Impedance Stabilization Network (LISN) which supplied power source of 230VAC/ 50Hz and was grounded to the ground plane.
- 5) All support equipment received power from a second LISN supplying power of 110VAC/60Hz, if any.
- 6) The EUT test program was started. Emissions were measured on each current carrying line of the EUT using a spectrum analyzer / Receiver connected to the LISN powering the EUT. The LISN has two monitoring points: Line 1 (Hot Side) and Line 2 (Neutral Side). Two scans were taken: one with Line 1 connected to Analyzer / Receiver and Line 2 connected to a 50 ohm load; the second scan had Line 1 connected to a 50 ohm load and Line 2 connected to the Analyzer / Receiver.
- 7) Analyzer / Receiver scanned from 150kHz to 30MHz for emissions in each of the test modes.
- 8) During the above scans, the emissions were maximized by cable manipulation.
- 9) The following test mode were scanned during the preliminary test:

Mode(s):

No.	Mode of operation	Date	Data Report/Plot No.
1	VGA Mode	03/12/2002	9999C#(52, 51)
2	VIDEO Mode	03/11/2002	9999C#(24, 32)

- 10) After the preliminary scan, we found the following test mode producing the highest emission level.

Mode: 1.

Then, the EUT configuration and cable configuration of the above highest emission level were recorded for reference of final testing.

MEASUREMENT PROCEDURE (FINAL LINE CONDUCTED EMISSION TEST)

- 1) EUT and support equipment was set up on the test bench as per step 10 of the preliminary test.
- 2) A scan was taken on both power lines, Line 1 and Line 2, recording at least the six highest emissions. Emission frequency and amplitude were recorded into a computer in which correction factors were used to calculate the emission level and compare reading to the applicable limit. If EUT emission level was less -2dB to the A.V. limit in Q.P. mode, then the emission signal was re-checked using an A.V. detector.
- 3) The test data of the worst case condition(s) was reported on the Summary Data page.

Data Sample:

Freq (MHz)	Meter Reading (dBuV)	C.F. (dB)	Corrected Reading (dBuV)	Limits (dBuV)	Margin (dB)	Reading Type (P/Q/A)	Line (L1/L2)
x.xx	x.xx	x.xx	48.38	66.00	-17.62	A	L1

C.F.(Correction Factor)=Insertion Loss + Cable Loss

Corrected Reading = Metering Reading + C.F.

Margin=Corrected Reading - Limits

P=Peak Reading

L1=Hot

Q=Quasi-peak

L2=Neutral

A=Average Reading

Comments: N/A

LINE CONDUCTED EMISSION LIMIT (EN 55022)

Frequency	Maximum RF Line Voltage	
	Q.P.	AVERAGE
150kHz-500kHz	79dBuV	66dBuV
500kHz-5MHz	73dBuV	60dBuV
5MHz-30MHz	73dBuV	60dBuV

Note: The lower limit shall apply at the transition frequency.

MEASUREMENT PROCEDURE (COMMON MODE CONDUCTED EMISSION MEASUREMENT)

- 1) Selecting ISN for unscreened cable or a current probe for screened cable to take measurement.
- 2) The port of the EUT was connected to the remote side support equipment through the ISN/Current Probe and communication in normal condition.
- 3) Making a overall range scan by using the test receiver controlled by controller and record at least six highest emissions for showing in the test report.
- 4) Emission frequency and amplitude were recorded into a computer in which correction factors were used to calculate the emission level and compare reading to the applicable limit.
- 5) In case of measuring on the screened cable, the current limit shall be applied, otherwise the voltage limit should be applied.
- 6) The following test mode(s) were scanned during the preliminary test:
Mode: N/A (EUT no any Telecommunicate Port)
- 7) After the preliminary scan, we found the following test mode(s) producing the highest emission level and test date of the worst case was reported on the summary data page.
Mode: N/A

Data Sample:

Freq (MHz)	Meter Reading (dBUV)	C.F. (dB)	Corrected Reading (dBUV/m)	Limits (dBUV/m)	Margin (dB)	Reading Type (P/Q/A)
x.xx	x.xx	x.xx	59.26	74.00	-14.74	P

C.F.(Correction Factor)=Insertion Loss (9.5dB) + Cable Loss

Corrected Reading = Metering Reading + C.F.

Margin=Corrected Reading - Limits

P=Peak Reading

Q=Quasi-peak

A=Average Reading

Comments: N/A

COMMON MODE CONDUCTED EMISSION LIMIT AT TELECOMMUNICATION PORTS

<input type="checkbox"/> CE-Mark (EN 55022:1998)					
CLASS	Measuring Band	Voltage limit dB(uV)		Current limit dB(uA)	
		Q.P.	AV	Q.P.	AV
B	150kHz-500kHz	84-74	74-64	40-30	30-20
	500kHz-30MHz	74	64	30	20

Note: The lower limit shall apply at the transition frequency.

MEASUREMENT PROCEDURE (PRELIMINARY RADIATED EMISSION TEST)

- 1) The equipment was set up as per the test configuration to simulate typical actual usage per the user's manual. When the EUT is a tabletop system, a wooden turntable with a height of 0.8 meters is used which is placed on the ground plane as per EN 55022 (see Test Facility for the dimensions of the ground plane used). When the EUT is a floor-standing equipment, it is placed on the ground plane which has a 3-12 mm non-conductive covering to insulate the EUT from the ground plane.
- 2) Support equipment, if needed, was placed as per EN 55022.
- 3) All I/O cables were positioned to simulate typical actual usage as per EN 55022.
- 4) The EUT received DC 12V power source from AC Adaptor (AC 230V/50Hz) to the outlet socket under the turntable. All support equipment received 110VAC/60Hz power from another socket under the turntable, if any.
- 5) The antenna was placed at 10 meter away from the EUT as stated in EN 55022. The antenna connected to the analyzer via a cable and at times a pre-amplifier would be used.
- 6) The Analyzer / Receiver quickly scanned from 30MHz to 1000MHz. The EUT test program was started. Emissions were scanned and measured rotating the EUT to 360 degrees and positioning the antenna 1 to 4 meters above the ground plane, in both the vertical and the horizontal polarization, to maximize the emission reading level.
- 7) The following test mode were scanned during the preliminary test:

Mode(s):

No.	Mode of operation	Date	Data Report/Plot No.
1	VGA Mode	03/11/2002	9999D#(01, 02)
2	VIDEO Mode	03/11/2002	9999D#(03, 04)

- 8) After the preliminary scan, we found the following test mode producing the highest emission level.

Mode: 1.

Then, the EUT and cable configuration, antenna position, polarization and turntable position of the above highest emission level were recorded for final testing.

MEASUREMENT PROCEDURE (FINAL RADIATED EMISSION TEST)

- 1) EUT and support equipment were set up on the turntable as per step 8 of the preliminary test.
- 2) The Analyzer / Receiver scanned from 30MHz to 1000MHz. Emissions were scanned and measured rotating the EUT to 360 degrees, varying cable placement and positioning the antenna 1 to 4 meters above the ground plane, in both the vertical and the horizontal polarization, to maximize the emission reading level.
- 3) Recorded at least the six highest emissions. Emission frequency, amplitude, antenna position, polarization and turntable position were recorded into a computer in which correction factors were used to calculate the emission level and compare reading to the applicable limit and only Peak reading is presented. If EUT emission level was less-2dB to the limit, then the emission signal was re-checked using a Q.P. detector.
- 4) The test data of the worst case condition(s) was reported on the Summary Data page.

Data Sample:

Freq (MHz)	Meter Reading (dBuV)	C.F. (dB/m)	Corrected Reading (dBuV/m)	Limits (dBuV/m)	Margin (dB)	Reading Type P/Q/A	Pol. H/V
x.xx	x.xx	x.xx	40.82	47.00	-6.18	P	V

C.F.(Correction Factor)=Antenna Factor + Cable Loss + Attenuator(6dB) - Amplifier Gain

Corrected Reading = Metering Reading + C.F.

Margin=Corrected Reading – Limits

P=Peak Reading

H=Horizontal Polarization/Antenna

Q=Quasi-peak

V=Vertical Polarization/Antenna

A=Average Reading

Comments: N/A

RADIATED EMISSION LIMIT

Frequency (MHz)	Distance (m)	Maximum Field Strength Limit (dBu V/m/ Q.P.)
30-230	10	40
230-1000	10	47

Note: The lower limit shall apply at the transition frequency.

BLOCK DIAGRAM OF TEST SETUP

System Diagram of Connections between EUT and Simulators

EUT: Industrial Display Monitor

Trade Name: N/A

Model Number: AMB-220A

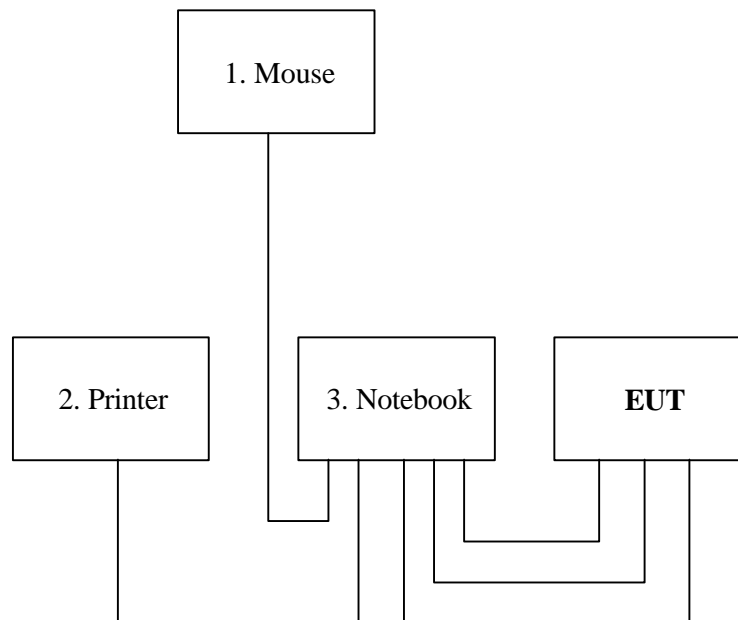

SUMMARY DATA (LINE CONDUCTED TEST)

Model Number: AMB-220A

Location: Conducted Room

Tested by: James Liao

Test Mode: Mode 1

Test Results: Passed

Temperature: 18

Humidity: 70%RH

(The chart below shows the highest readings taken from the final data)

Frequency Range Investigated				150 kHz TO 30 MHz			
Freq (MHz)	Meter Reading (dBuV)	C.F. (dB)	Corrected Reading (dBuV)	Limits (dBuV)	Margin (dB)	Reading Type (P/Q/A)	Line (L1/L2)
0.183	48.16	0.02	48.18	79.00	-30.82	P	L1
0.505	41.51	0.05	41.56	73.00	-31.44	P	L1
0.747	47.86	0.07	47.93	73.00	-25.07	P	L1
2.622	41.35	0.16	41.51	73.00	-31.49	P	L1
0.183	47.86	0.02	47.88	79.00	-31.12	P	L2
2.500	38.66	0.16	38.82	73.00	-34.18	P	L2

C.F.(Correction Factor)=Insertion Loss + Cable Loss

Corrected Reading = Metering Reading + C.F.

Margin=Corrected Reading - Limits

P=Peak Reading

L1=Hot

Q=Quasi-peak

L2=Neutral

A=Average Reading

Comments: N/A

SUMMARY DATA (RADIATED EMISSION TEST)

Model Number: AMB-220A

Location: Site # D

Tested by: James Liao

Polar: Vertical / Horizontal- 10m

Test Mode: Mode 1

Test Results: Passed

Temperature: 18

Humidity: 70%RH

(The chart below shows the highest readings taken from the final data)

Frequency Range Investigated (30 MHz TO 1000 MHz)							
Freq (MHz)	Meter Reading (dBuV)	C.F. (dB/m)	Corrected Reading (dBuV/m)	Limits (dBuV/m)	Margin (dB)	Reading Type P/Q/A	Pol. H/V
120.156	40.49	-8.21	32.28	40.00	-7.72	P	V
155.733	36.43	-5.31	31.12	40.00	-8.88	P	V
120.133	39.73	-8.21	31.52	40.00	-8.48	P	H
155.733	40.39	-5.31	35.08	40.00	-4.92	P	H
180.189	36.30	-6.54	29.76	40.00	-10.24	P	H
204.600	43.51	-8.00	35.51	40.00	-4.49	P	H

C.F.(Correction Factor)=Antenna Factor + Cable Loss - Amplifier Gain (+ Attenuator 6dB)

Corrected Reading = Metering Reading + C.F.

Margin=Corrected Reading - Limits

P=Peak Reading

H=Horizontal Polarization/Antenna

Q=Quasi-peak

V=Vertical Polarization/Antenna

A=Average Reading

Comments: N/A

SECTION 2 EN 61000-3-2 & EN 61000-3-3 (POWER HARMONICS & VOLTAGE FLUCTUATION / FLICKER)

POWER HARMONICS MEASUREMENT

Port : AC mains
Basic Standard : EN 61000-3-2 (1995+A1: 1998+A2: 1998 + A14: 2000)
Limits : Class A, Class D
Temperature : 20°C
Humidity : 70%
Test By : James Liao

VOLTAGE FLUCTUATION/FLICKER MEASUREMENT

Port : AC mains
Basic Standard : EN 61000-3-3 (1995)
Limits : § 5 of EN 61000-3-3
Temperature : 20°C
Humidity : 70%
Test By : James Liao

Block Diagram of Test Setup:

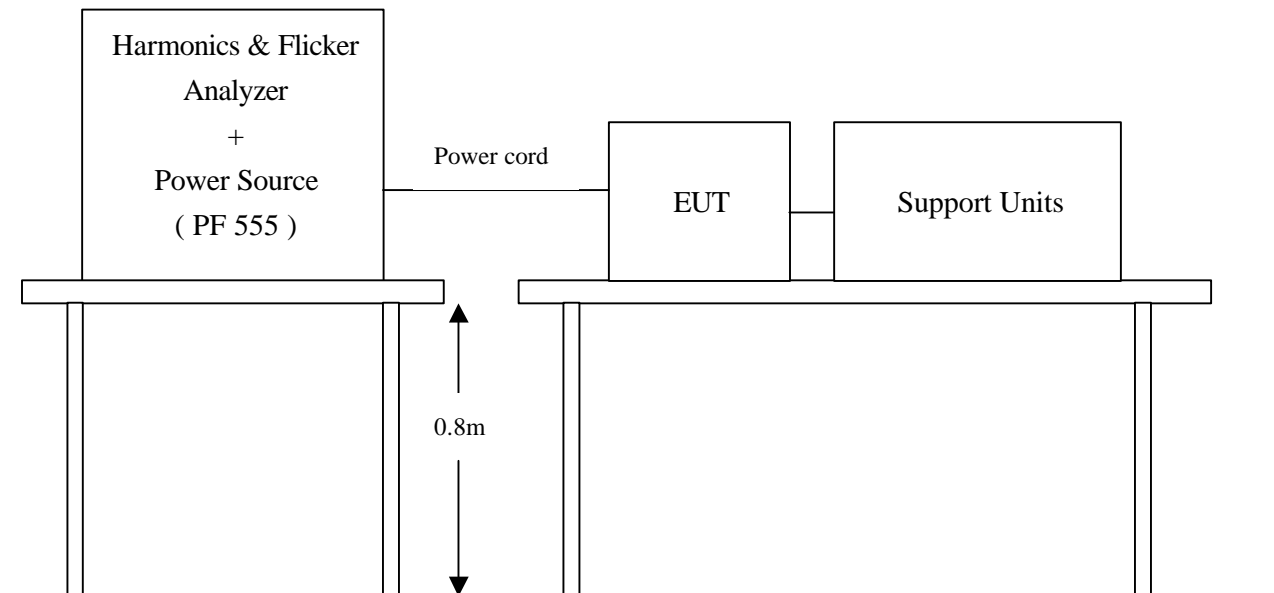

Result:

Please see the attached test data.

Approved by: Vince Chiang
Signature: James Date: 3/11/02

Final Test Result: PASS

Settings and Test Conditions Compliant to the Standard: Yes

Test Equipment Used:

Agilent 6842A Harmonic/Flicker Test System with serial number:
HFTS Software Version: A.05.03
Date Last Calibrated:

Test Equipment Settings:

Line Voltage: 230.00 V	Current Measurement Range: High
Line Frequency: 50 Hz	Measurement Window Type: Rectangular
Device Class: D	Measurement Delay: 10 seconds
RMS Current Limit: 13.1 A	Quasi-stationary Test Duration: 30.00 minutes
Peak Current Limit: 80.8 A	Class Determination Pre-test Duration: 10.00 seconds
Number of Records: 5625	

Overrides:

Test Limit Source (Power Measurements/Statistics): Maximum
Power Overrides: None
Test Limit Overrides: None

Pre-test Results for Class Determination:

Percent in Envelope: 100.0% Voltage THD Out-of-Specification?: No
Class D Equipment?: Yes Fundamental Current: 0.079 A

RMS Voltage: 229.9 V	RMS Current: 0.2 A	Real Power: 16.3 W
Frequency: 50.0 Hz	Peak Current: 0.9 A	Apparent Power: 41.3 VA
Voltage THD: 0.02%	Current THD: 89.37%	Power Factor: 0.396
Maximum Power: 16.3 W	Mean Power: 16.3 W	

Active Power Statistics:

100th Percentile: 16.3 W 99th Percentile: 16.3 W 95th Percentile: 16.3
90th Percentile: 16.3 W 50th Percentile: 16.3 W

Total Number of Failures:

None

Total Number of Errors:

None

Pre-Test Source Voltage Harmonics Data:

Harmonic Number	Limit (%)	Limit (Volts)	Max (%)	Max (Volts)
Fund.			100.0	229.877
2	0.20	0.460	0.005	0.012
3	0.90	2.069	0.006	0.013
4	0.20	0.460	0.005	0.012
5	0.40	0.920	0.007	0.017
6	0.20	0.460	0.001	0.003
7	0.30	0.690	0.003	0.008
8	0.20	0.460	0.002	0.003
9	0.20	0.460	0.006	0.013
10	0.20	0.460	0.003	0.006
11	0.10	0.230	0.005	0.011
12	0.10	0.230	0.002	0.005
13	0.10	0.230	0.006	0.014
14	0.10	0.230	0.002	0.004
15	0.10	0.230	0.003	0.008
16	0.10	0.230	0.003	0.007
17	0.10	0.230	0.008	0.018
18	0.10	0.230	0.003	0.007
19	0.10	0.230	0.005	0.012
20	0.10	0.230	0.001	0.003
21	0.10	0.230	0.008	0.017
22	0.10	0.230	0.003	0.007
23	0.10	0.230	0.005	0.013
24	0.10	0.230	0.001	0.002
25	0.10	0.230	0.004	0.010
26	0.10	0.230	0.001	0.003
27	0.10	0.230	0.002	0.006
28	0.10	0.230	0.001	0.001
29	0.10	0.230	0.005	0.011
30	0.10	0.230	0.003	0.006
31	0.10	0.230	0.001	0.003
32	0.10	0.230	0.001	0.002
33	0.10	0.230	0.002	0.004
34	0.10	0.230	0.001	0.001
35	0.10	0.230	0.002	0.004
36	0.10	0.230	0.003	0.006
37	0.10	0.230	0.003	0.006
38	0.10	0.230	0.002	0.004
39	0.10	0.230	0.004	0.009
40	0.10	0.230	0.001	0.002

Final Test Data:

Harmonic Number	Standard Limit (A rms)	Maximum Value (A rms)	Maximum Value (% Limit)	Mean Value (A rms)	Mean Value (% Limit)	Standard Deviation (A rms)	Standard Deviation (% Limit)	Pass (P) or Fail (F)
Fund.		0.0790		0.0765		0.0012		
2		0.0039		0.0032		0.0001		
3	2.3000	0.0674	2.9	0.0651	2.8	0.0012	0.1	P
4		0.0020		0.0016		0.0001		
5	1.1400	0.0640	5.6	0.0619	5.4	0.0011	0.1	P
6		0.0015		0.0010		0.0001		
7	0.7700	0.0607	7.9	0.0589	7.7	0.0010	0.1	P
8		0.0012		0.0009		0.0001		
9	0.4000	0.0575	14.4	0.0559	14.0	0.0008	0.2	P
10		0.0012		0.0007		0.0001		
11	0.3300	0.0539	16.3	0.0524	15.9	0.0007	0.2	P
12		0.0008		0.0004		0.0001		
13	0.2100	0.0493	23.5	0.0480	22.9	0.0006	0.3	P
14		0.0008		0.0004		0.0001		
15	0.1500	0.0439	29.3	0.0430	28.7	0.0006	0.4	P
16		0.0008		0.0004		0.0001		
17	0.1324	0.0390	29.5	0.0379	28.6	0.0007	0.6	P
18		0.0007		0.0003		0.0001		
19	0.1184	0.0342	28.9	0.0327	27.6	0.0009	0.8	P
20		0.0006		0.0002		0.0001		
21	0.1071	0.0293	27.4	0.0276	25.8	0.0011	1.0	P
22		0.0006		0.0002		0.0001		
23	0.0978	0.0246	25.2	0.0228	23.3	0.0012	1.2	P
24		0.0006		0.0002		0.0001		
25	0.0900	0.0201	22.4	0.0182	20.2	0.0012	1.4	P
26		0.0007		0.0002		0.0001		
27	0.0833	0.0161	19.3	0.0142	17.0	0.0012	1.4	P
28		0.0007		0.0002		0.0001		
29	0.0776	0.0126	16.2	0.0109	14.0	0.0011	1.4	P
30		0.0007		0.0003		0.0001		
31	0.0726	0.0097	13.4	0.0083	11.5	0.0008	1.2	P
32		0.0007		0.0003		0.0001		
33	0.0682	0.0077	11.3	0.0067	9.9	0.0005	0.7	P
34		0.0007		0.0003		0.0001		
35	0.0643	0.0066	10.2	0.0061	9.4	0.0002	0.3	P
36		0.0007		0.0002		0.0001		
37	0.0608	0.0064	10.5	0.0059	9.7	0.0002	0.3	P
38		0.0007		0.0003		0.0001		
39	0.0577	0.0066	11.4	0.0060	10.4	0.0002	0.4	P
40		0.0006		0.0002		0.0001		

Final Test Statistics:

Harmonic Number	Standard Limit (A rms)	Maximum Value (A rms)	Maximum Value (% Limit)	>50% of Limit (Count)	>75% of Limit (Count)	>90% of Limit (Count)	>95% of Limit (Count)	>100% of Limit (Count)	Pass (P) or Fail (F)
Fund.		0.0790							
2		0.0039		0	0	0	0	0	
3	2.3000	0.0674	2.9	0	0	0	0	0	P
4		0.0020		0	0	0	0	0	
5	1.1400	0.0640	5.6	0	0	0	0	0	F
6		0.0015		0	0	0	0	0	
7	0.7700	0.0607	7.9	0	0	0	0	0	F
8		0.0012		0	0	0	0	0	
9	0.4000	0.0575	14.4	0	0	0	0	0	F
10		0.0012		0	0	0	0	0	
11	0.3300	0.0539	16.3	0	0	0	0	0	P
12		0.0008		0	0	0	0	0	
13	0.2100	0.0493	23.5	0	0	0	0	0	F
14		0.0008		0	0	0	0	0	
15	0.1500	0.0439	29.3	0	0	0	0	0	P
16		0.0008		0	0	0	0	0	
17	0.1324	0.0390	29.5	0	0	0	0	0	F
18		0.0007		0	0	0	0	0	
19	0.1184	0.0342	28.9	0	0	0	0	0	F
20		0.0006		0	0	0	0	0	
21	0.1071	0.0293	27.4	0	0	0	0	0	F
22		0.0006		0	0	0	0	0	
23	0.0978	0.0246	25.2	0	0	0	0	0	P
24		0.0006		0	0	0	0	0	
25	0.0900	0.0201	22.4	0	0	0	0	0	F
26		0.0007		0	0	0	0	0	
27	0.0833	0.0161	19.3	0	0	0	0	0	F
28		0.0007		0	0	0	0	0	
29	0.0776	0.0126	16.2	0	0	0	0	0	P
30		0.0007		0	0	0	0	0	
31	0.0726	0.0097	13.4	0	0	0	0	0	F
32		0.0007		0	0	0	0	0	
33	0.0682	0.0077	11.3	0	0	0	0	0	P
34		0.0007		0	0	0	0	0	
35	0.0643	0.0066	10.2	0	0	0	0	0	F
36		0.0007		0	0	0	0	0	
37	0.0608	0.0064	10.5	0	0	0	0	0	P
38		0.0007		0	0	0	0	0	
39	0.0577	0.0066	11.4	0	0	0	0	0	F
40		0.0006		0	0	0	0	0	

Remarks

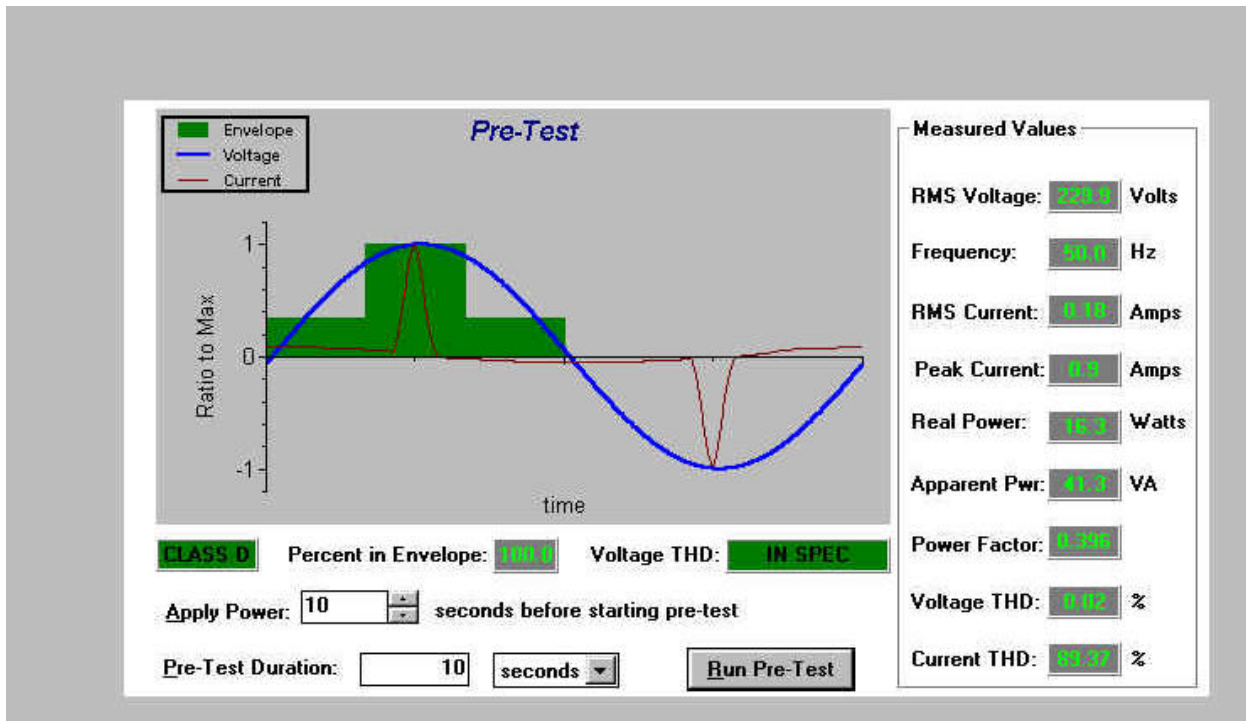

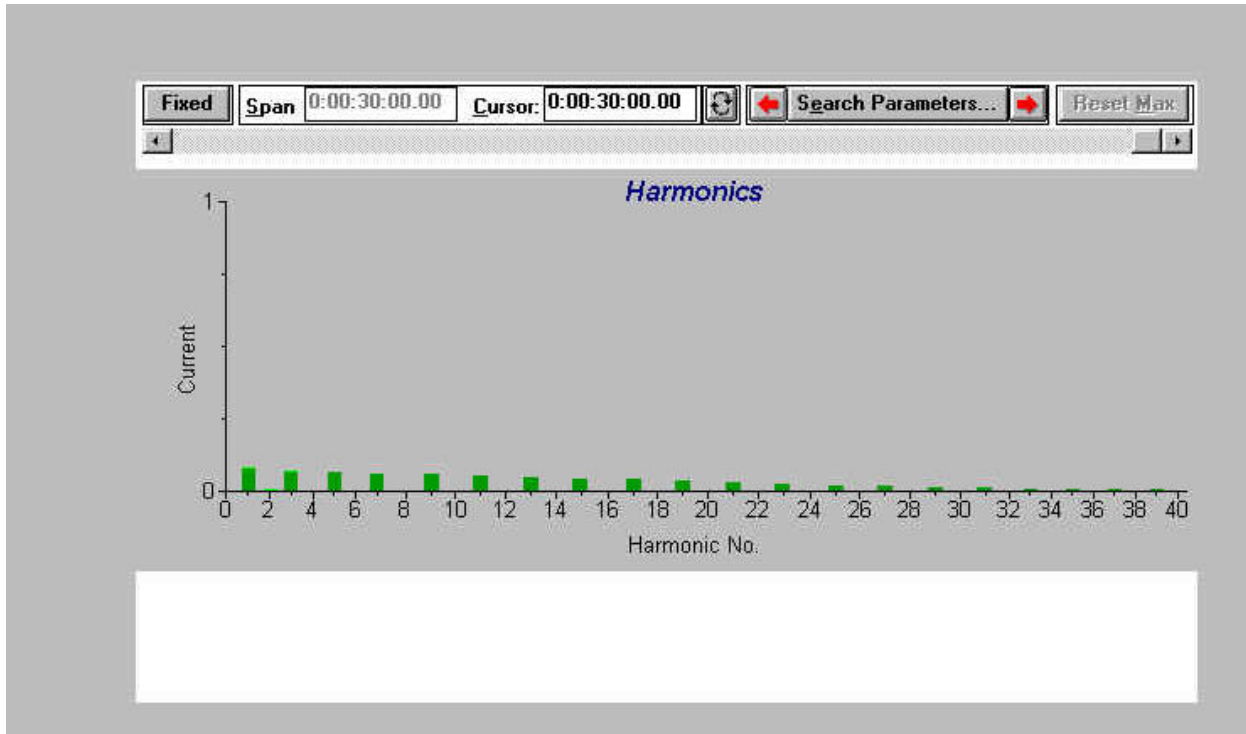

Approved by: Vince Chiang
Signature: James Date: 3/11.02

Final Test Result: PASS

Settings and Test Conditions Compliant to the Standard: Yes

Test Equipment Used:

Agilent 6042A Harmonic/Flicker Test System with serial number:
HFTS Software Version: A.05.03
Date Last Calibrated:

Test Equipment Settings:

Line Voltage: 230.00 V	Pst Integration Time: 10 minutes
Line Frequency: 50 Hz	Pst Integration Periods: 3
Measurement Delay: 10.0 seconds	Test Duration: 00:30:00
RMS Current Limit: 13.1 A	Peak Current Limit: 80.8 A

Overrides:

Pst/Plt Test Limit Overrides: None
RMS Test Limit Overrides: None

Equipment Under Test Pre-test Results:

RMS Voltage: 229.8 V	RMS Current: 0.2 A	Real Power: 15.4 W
Frequency: 50.0 Hz	Peak Current: 0.9 A	Apparent Power: 40.8 VA
Voltage THD: 0.02%	Current THD: 90.08%	Power Factor: 0.377

Total Number of Failures:

Total Number of Errors:

Pst: 0
Plt: 0
Dc: 0
Dmax: 0
Dt: 0

None

Final Test Summary:

```

-----
Dmax: 0.0          Fst: 0.07          P_0.1: 0.01
Dc: 0.0           Flt: 0.07          P_1s: 0.01
Dt: 0.00          Flt Threshold: 0.65         P_3s: 0.01
                                      P_10s: 0.01
                                      P_50s: 0.01
  
```

Final Test Data by Integration Period:

Number of Integration Periods: 3

Integration Periods	Pst (P.U.)	P_0.1 (P.U.)	F_1.0s (P.U.)	F_3.0s (P.U.)	P_10s (P.U.)	P_50s (P.U.)	Dc (%)	Dmax (%)	Dt (seconds)	Pass (P) or Fail (F)
1	0.07	0.01	0.01	0.01	0.01	0.01	-----	-----	-----	N/A
2	0.07	0.01	0.01	0.01	0.01	0.01	-----	-----	-----	N/A
3	0.07	0.01	0.01	0.01	0.01	0.01	-----	-----	-----	N/A

Remarks

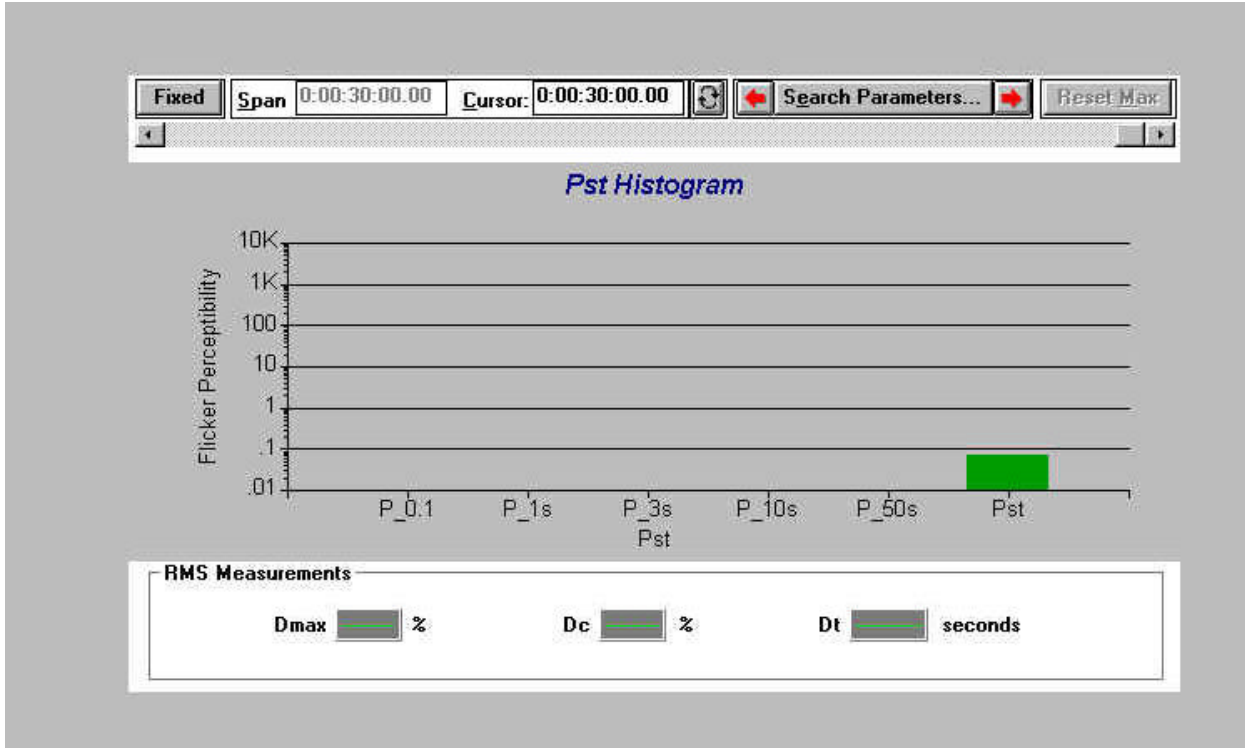

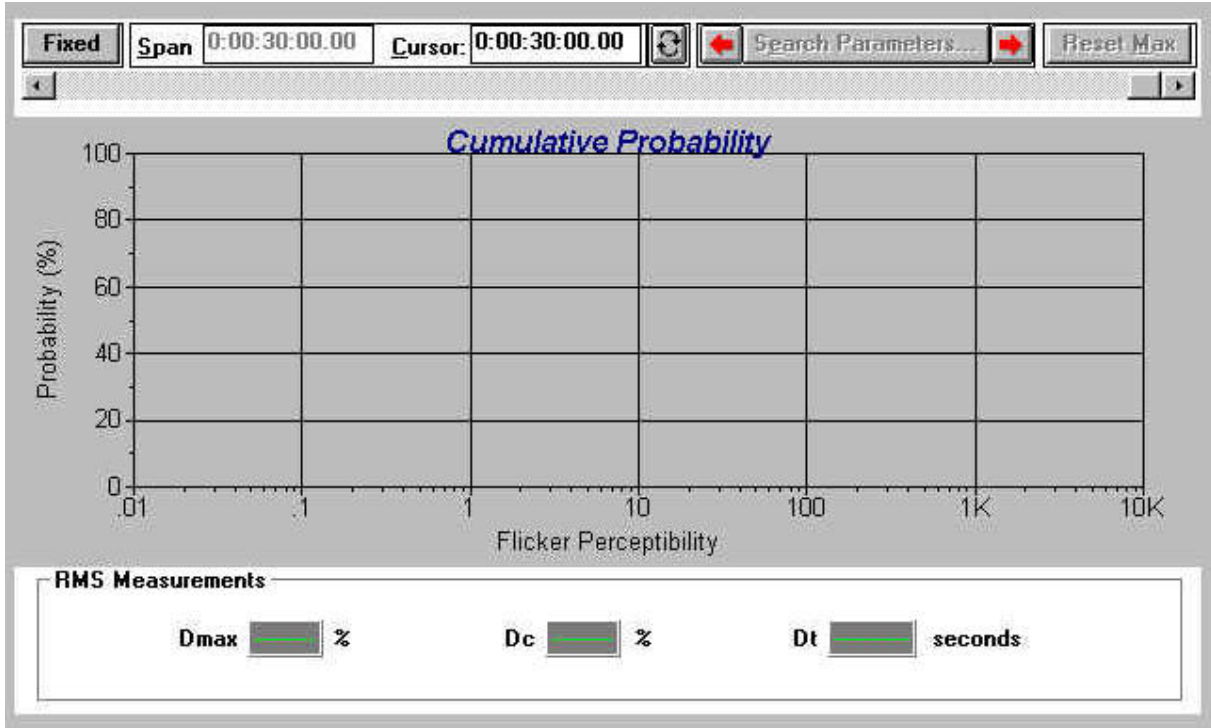

SECTION 3 IEC 61000-4-2 (ELECTROSTATIC DISCHARGE)

ELECTROSTATIC DISCHARGE (ESD) IMMUNITY TEST

Port : Enclosure
Basic Standard : IEC 61000-4-2
Requirements : ±8 kV (Air Discharge)
 : ±4kV (Contact Discharge)
 : ±4kV (Indirect Discharge)
Performance Criteria : B (Standard require)
Temperature/Humidity : 23⁰C /59%
Test By : Sam Hu

Block Diagram of Test Setup:

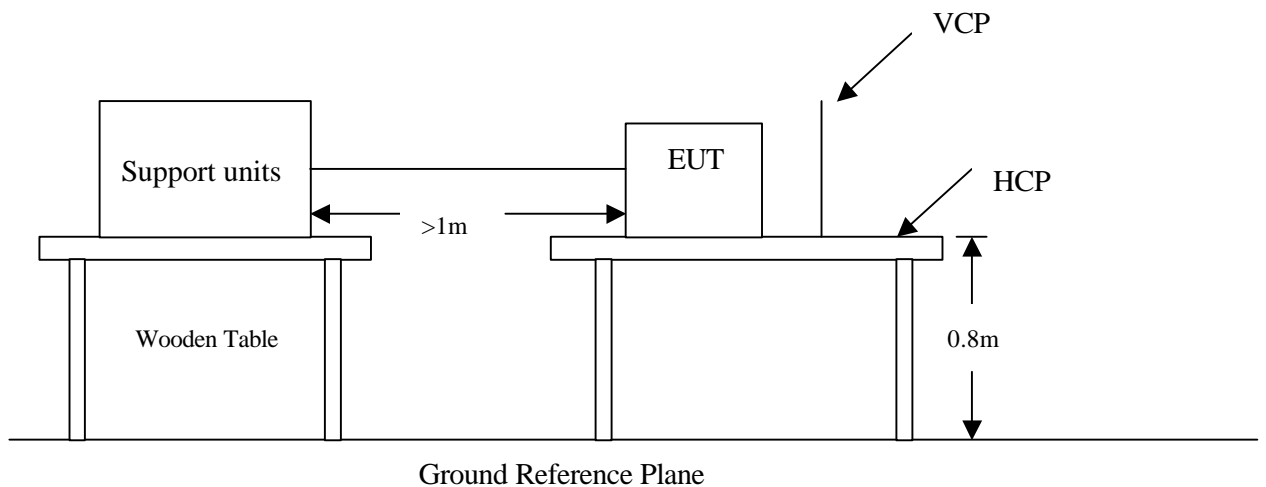

Test Procedure:

1. The EUT was located 0.1 m minimum from all side of the HCP.
2. The support units were located 1 m minimum away from the EUT.
3. A communication test program was loaded and executed in Windows mode.
4. PC sent transmit data to remote side via EUT.
5. As per the requirement of EN 55024; applying direct contact discharge at the sides other than front of EUT at minimum 50 discharges (25 positive and 25 negative) if applicable, can't be applied direct contact discharge side of EUT then the indirect discharge shall be applied. One of the test points shall be subjected to at least 50 indirect discharge (contact) to the front edge of horizontal coupling plane.
6. Other parts of EUT where it is not possible to perform contact discharge then selecting appropriate points of EUT for air discharge, a minimum of 10 single air discharges shall be applied.
7. The application of ESD to the contact of open connectors is not required.
8. Putting a mark on EUT to show tested points. The following test condition was followed during the tests.

The electrostatic discharges were applied as follows:

Amount of Discharges	Voltage	Coupling	Result (Pass/Fail)
Mini 25 /Point	±4kV	Contact Discharge	Pass
Mini 25 /Point	±4kV	Indirect Discharge HCP (Front)	Pass
Mini 25 /Point	±4kV	Indirect Discharge VCP (Back)	Pass
Mini 25 /Point	±4kV	Indirect Discharge VCP (Left)	Pass
Mini 25 /Point	±4kV	Indirect Discharge VCP (Right)	Pass
Mini 10 /Point	±8kV	Air Discharge	Pass

**** The tested points to EUT, please refer to attached page.**

(Blue arrow mark for contact discharge, red arrow mark for air discharge.)

Performance & Result:

- Criteria A:** The apparatus continues to operate as intended. No degradation of performance or loss of function is allowed below a performance level specified by the manufacturer, when the apparatus is used as intended. In some cases the performance level may be replaced by a permissible loss of performance.
- Criteria B:** The apparatus continues to operate as intended after the test. No degradation of performance or loss of function is allowed below a performance level specified by the manufacturer, when the apparatus is used as intended. In some cases the performance level may be replaced by a permissible loss of performance. During the test, degradation of performance is however allowed.
- Criteria C:** Temporary loss of function is allowed, provided the functions self recoverable or can be restored by the operation of controls.

<input checked="" type="checkbox"/> PASS <input type="checkbox"/> FAILED
Observation: No any function degraded during the tests.

The Tested Points of EUT

(Photo 1 of 6)



(Photo 2 of 6)

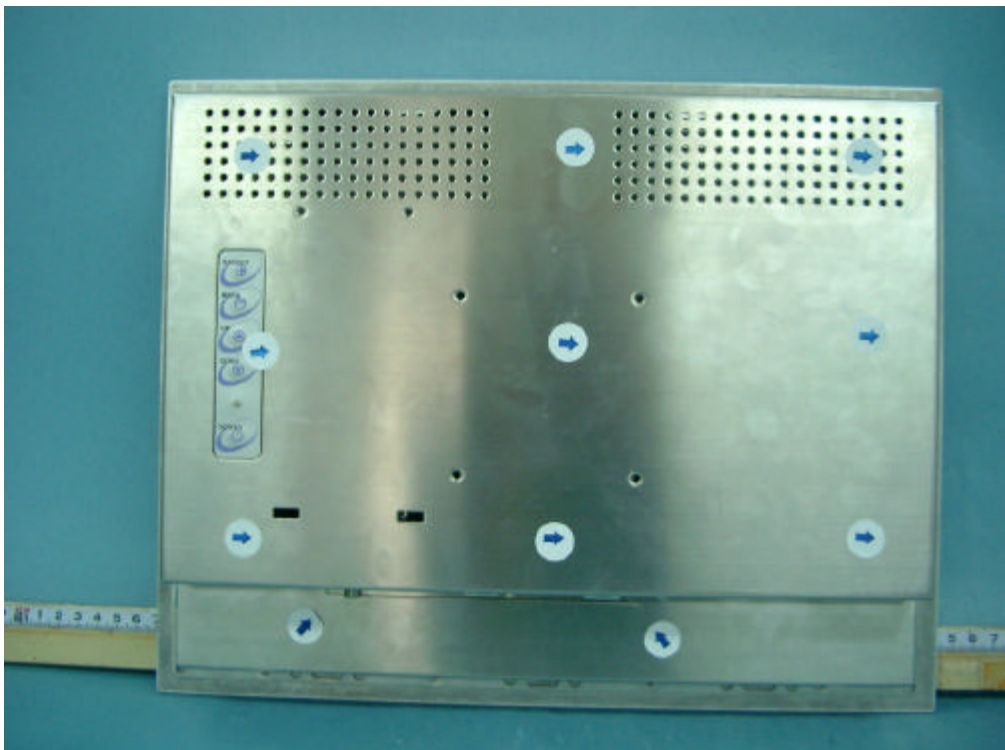

(Photo 3 of 6)

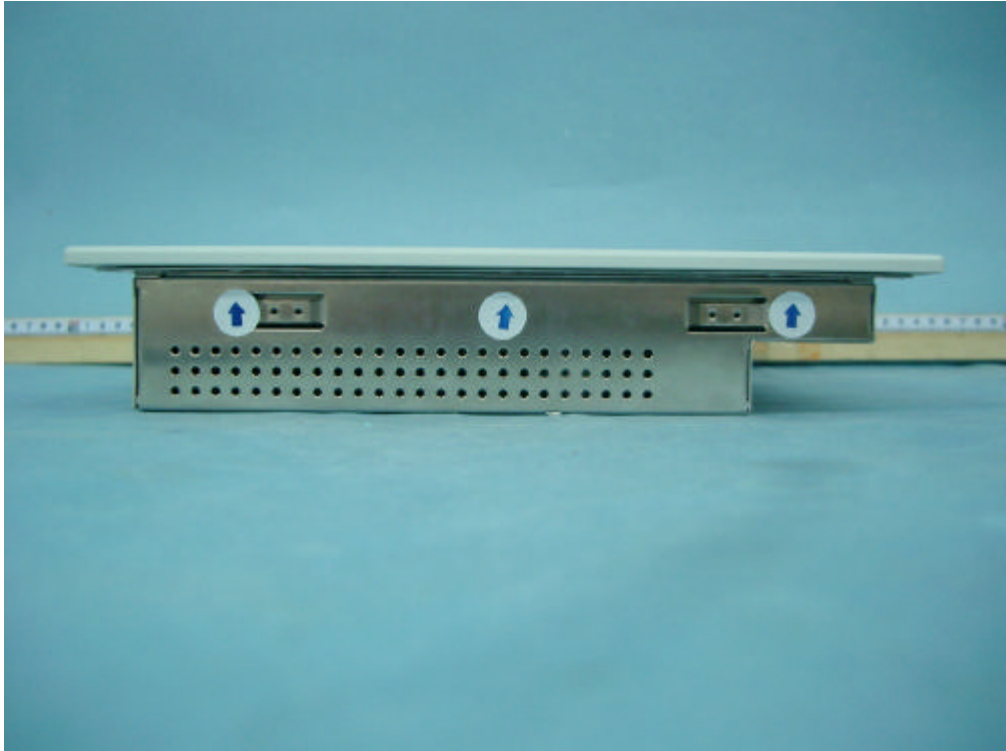

(Photo 4 of 6)

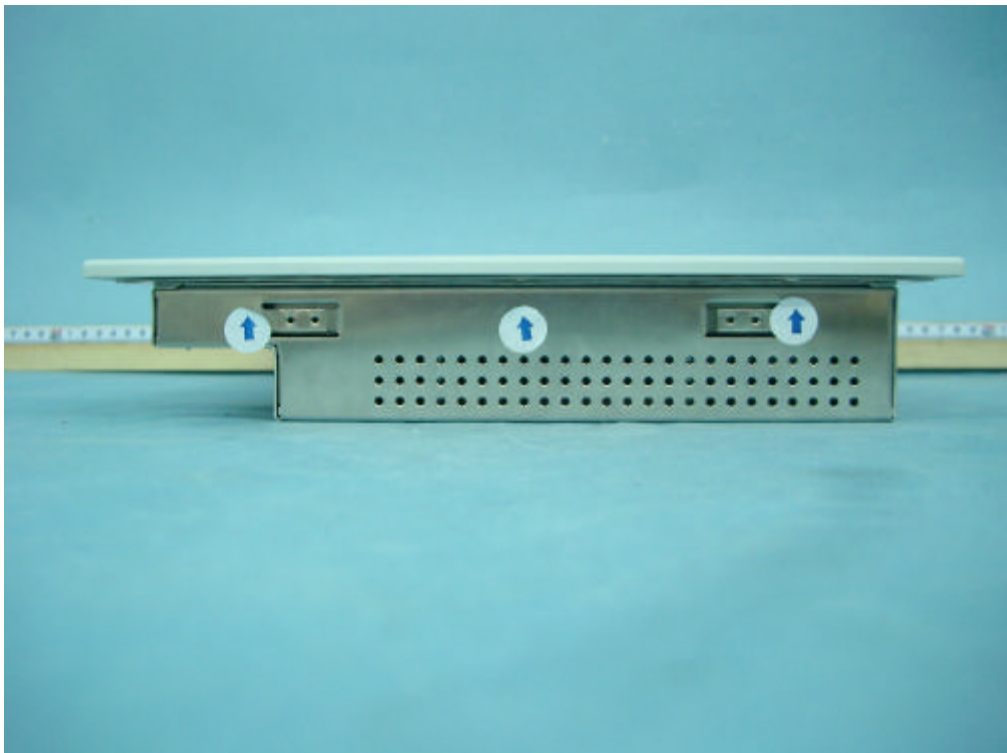

(Photo 5 of 6)



(Photo 6 of 6)



SECTION 4 IEC 61000-4-3 (RADIATED ELECTROMAGNETIC FIELD)

RADIATED ELECTROMAGNETIC FIELD IMMUNITY TEST

Port	: Enclosure
Basic Standard	: IEC 61000-4-3
Requirements	: 3 V/m / with 80% AM. 1kHz Modulation
Performance Criteria	: A (Standard require)
Tester	: Sam Hu
Temperature	: 24
Humidity	: 55%
Note	: The EUT not have acoustic interfaces, the annex A of EN 55024 should not be applied.

Block Diagram of Test Setup:

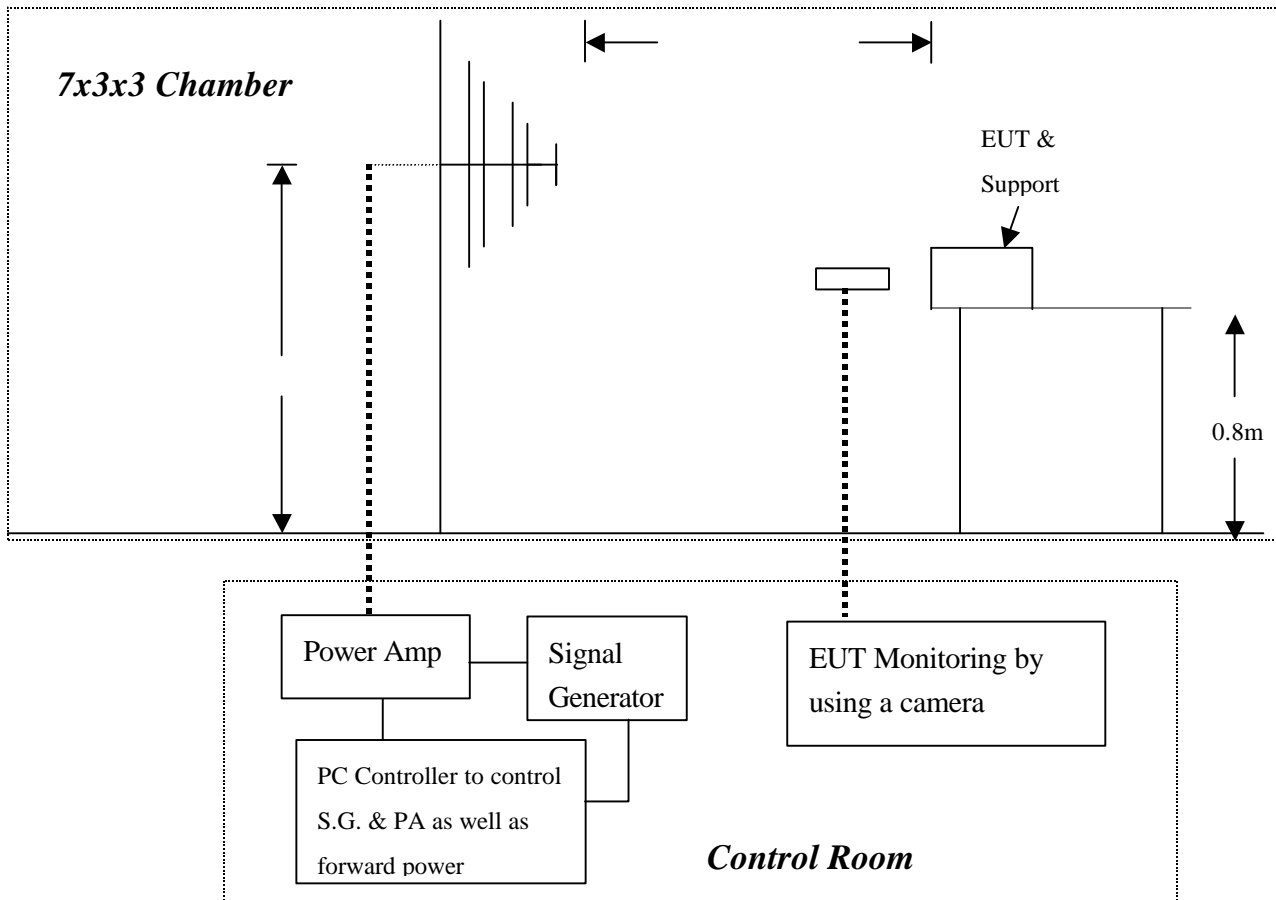

Test Procedure:

1. The EUT and support units were located at the edge of supporting table keep 3 meter away from transmitting antenna, it just the calibrated square area of field uniformity.
2. Adjusting the cables to be exposed to the electromagnetic filed as possible.
3. Performing a Radiated Emission Scan in range of 30 to 1000 MHz prior to do RS test and records the more higher emission frequencies for the reference of RS test, due to antenna effectiveness.
4. Adjusting the monitoring camera to monitor the “H” message as clear as possible.
5. Setting the testing parameters of RS test software per IEC 61000-4-3.
6. Referring to the tested data of step 3 to performing the RS test from 80 to 1000 MHz.
7. Recording the test result in following table.
8. Changing the EUT to the other side and repeat step 3 to 6, until 4 sides of EUT were verified.

IEC 61000-4-3 Final test conditions:

Test level : 3V/m
Steps : 1 % of fundamental
Dwell Time : 3 sec

Range (MHz)	Field	Modulation	Polarity	Position (°)	Result (Pass/Fail)
80-1000	3V	Yes	H	Front	Pass
80-1000	3V	Yes	V	Front	Pass
80-1000	3V	Yes	H	Right	Pass
80-1000	3V	Yes	V	Right	Pass
80-1000	3V	Yes	H	Back	Pass
80-1000	3V	Yes	V	Back	Pass
80-1000	3V	Yes	H	Left	Pass
80-1000	3V	Yes	V	Left	Pass

Performance & Result:

- Criteria A:** The apparatus continues to operate as intended. No degradation of performance or loss of function is allowed below a performance level specified by the manufacturer, when the apparatus is used as intended. In some cases the performance level may be replaced by a permissible loss of performance.
- Criteria B:** The apparatus continues to operate as intended after the test. No degradation of performance or loss of function is allowed below a performance level specified by the manufacturer, when the apparatus is used as intended. In some cases the performance level may be replaced by a permissible loss of performance. During the test, degradation of performance is however allowed.
- Criteria C:** Temporary loss of function is allowed, provided the functions self recoverable or can be restored by the operation of controls.

PASS

FAILED

Observation: No any function degraded during the tests.

SECTION 5 IEC 61000-4-4 (FAST TRANSIENTS/BURST)

FAST TRANSIENTS/BURST IMMUNITY TEST

Port : On Power Lines
Basic Standard : IEC 61000-4-4
Requirements : $\pm 1\text{kV}$ for Power Supply Lines
Performance Criteria : B (Standard require)
Temperature : 23°C
Humidity : 59%
Test By : Sam Hu

Block Diagram of Test Setup:

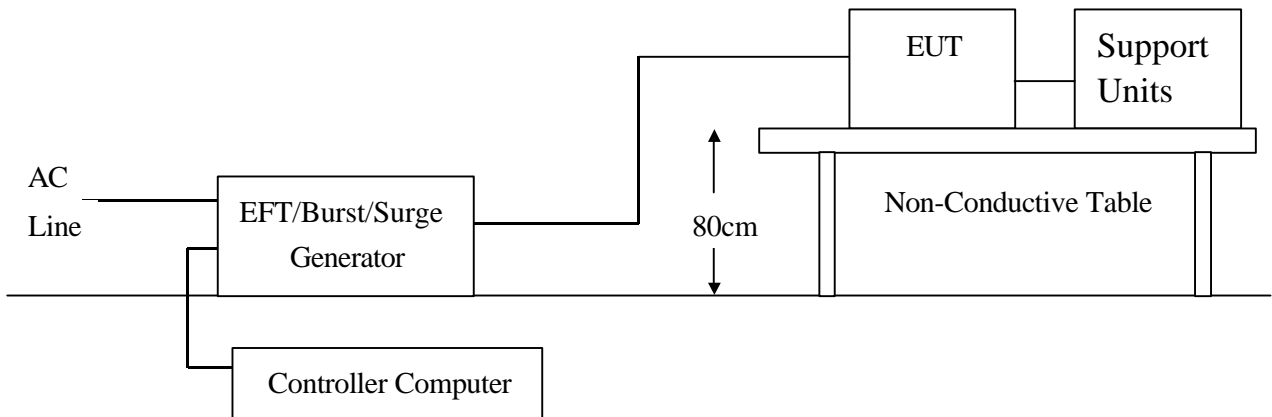

Test Procedure:

1. The EUT and support units were located on a wooden table 0.8 m away from ground reference plane.
2. A 1.0 meter long power cord was attached to EUT during the test.
3. The length of communication cable between communication port and clamp was keeping within 1 meter.
4. A test program was loaded and executed in Windows mode.
5. The data was display on the monitor and filling the screens.
6. The test program exercised related support units sequentially.
7. Repeating step 3 to 6 through the test.
8. Recording the test result as shown in following table.

Test conditions:

Impulse Frequency: 5kHz

Tr/Th: 5/50ns

Burst Duration: 15ms

Burst Period: 300mS

Inject Line	Voltage kV	Inject Method	Result (Pass/Fail)
L1	+/- 1	Direct	Pass
N	+/- 1	Direct	Pass
PE	+/- 1	Direct	Pass
L1+N	+/- 1	Direct	Pass
L1+PE	+/- 1	Direct	Pass
N+PE	+/- 1	Direct	Pass
L1+N+PE	+/- 1	Direct	Pass

Performance & Result:

- Criteria A:** The apparatus continues to operate as intended. No degradation of performance or loss of function is allowed below a performance level specified by the manufacturer, when the apparatus is used as intended. In some cases the performance level may be replaced by a permissible loss of performance.
- Criteria B:** The apparatus continues to operate as intended after the test. No degradation of performance or loss of function is allowed below a performance level specified by the manufacturer, when the apparatus is used as intended. In some cases the performance level may be replaced by a permissible loss of performance. During the test, degradation of performance is however allowed.
- Criteria C:** Temporary loss of function is allowed, provided the functions self recoverable or can be restored by the operation of controls.

PASS

FAILED

Observation: No any function degraded during the tests.

SECTION 6 IEC 61000-4-5 (SURGE IMMUNITY)

SURGE IMMUNITY TEST

Port	:	Power Cord
Basic Standard	:	IEC 61000-4-5
Requirements	:	+/- 1kV (Line to Line of Power Port) +/- 2kV (Line to Earth of Power Port)
Performance Criteria	:	B (Standard require)
Temperature	:	23
Humidity	:	59%
Test By	:	Sam Hu

Block Diagram of Test Setup:

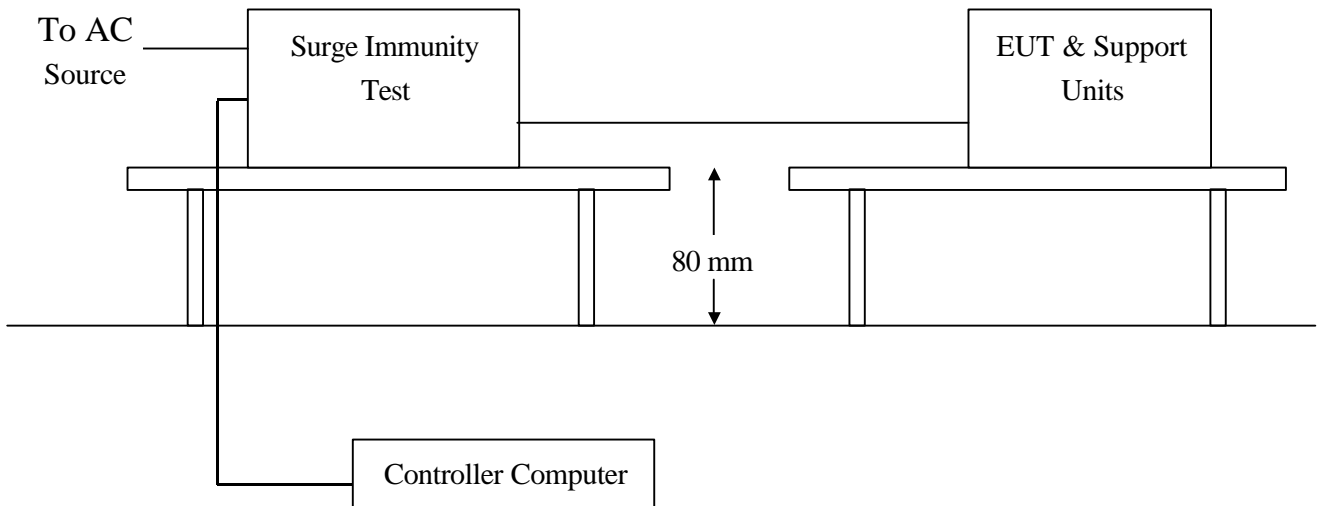

Test Procedure:

1. The EUT and support units were located on a wooden table 0.8 m away from ground floor.
2. A test program was loaded and executed in Windows mode.
3. The data was display on the monitor and filling the screens.
4. The test program exercised related support units sequentially.
5. Repeating step 3 to 4 through the test.
6. Recording the test result as shown in following table.

Test conditions:

Voltage Waveform : 1.2/50 us
 Current Waveform : 8/20 us
 Polarity : Positive/Negative
 Phase angle : 0°, 90°, 270°
 Number of Test : 5

Coupling Line	Voltage (kV)	Polarity	Coupling Method	Result (Pass/Fail)
L1-L2、 L1-PE、 L2-PE	1	Positive	Capacitive	Pass
L1-L2、 L1-PE、 L2-PE	1	Negative	Capacitive	Pass
L1-PE、 L2-PE	2	Positive	Capacitive	Pass
L1-PE、 L2-PE	2	Negative	Capacitive	Pass

Performance & Result:

- Criteria A:** The apparatus continues to operate as intended. No degradation of performance or loss of function is allowed below a performance level specified by the manufacturer, when the apparatus is used as intended. In some cases the performance level may be replaced by a permissible loss of performance.
- Criteria B:** The apparatus continues to operate as intended after the test. No degradation of performance or loss of function is allowed below a performance level specified by the manufacturer, when the apparatus is used as intended. In some cases the performance level may be replaced by a permissible loss of performance. During the test, degradation of performance is however allowed.
- Criteria C:** Temporary loss of function is allowed, provided the functions self recoverable or can be restored by the operation of controls.

<input checked="" type="checkbox"/> PASS <input type="checkbox"/> FAILED
Observation: No any function degraded during the tests.

SECTION 7 IEC 61000-4-6 (CONDUCTED DISTURBANCE/INDUCED BY RADIO-FREQUENCY FIELD)

CONDUCTED DISTURBANCE, INDUCED BY RADIO-FREQUENCY FIELDS

Port : AC Port
Basic Standard : IEC 61000-4-6
Requirements : 3V with 80% AM. Modulation
Injection Method : CDN-M2
Performance Criteria : A (Standard require)
Temperature : 24⁰C
Humidity : 55%
Test By : Sam Hu

Block Diagram of Test Setup:

Side view:

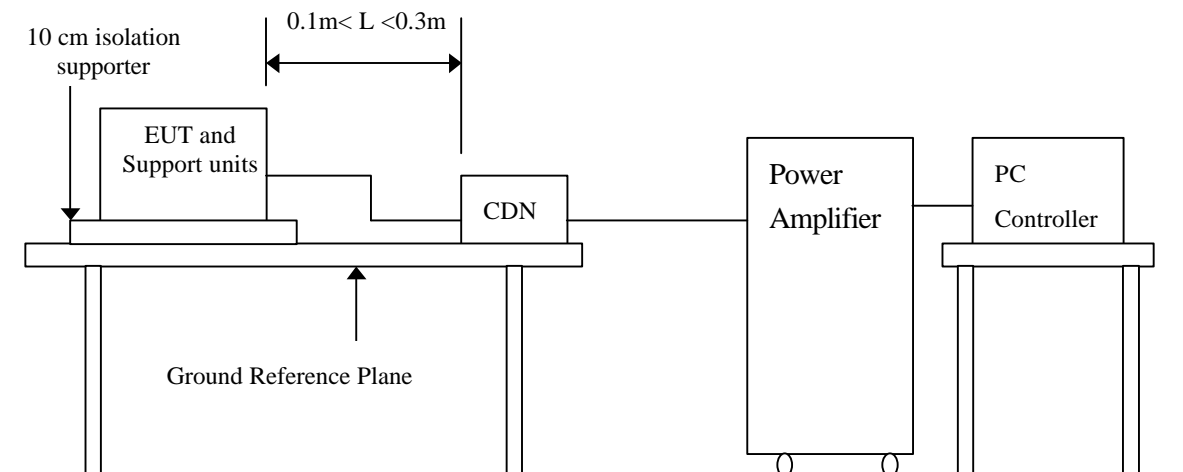

Top view:

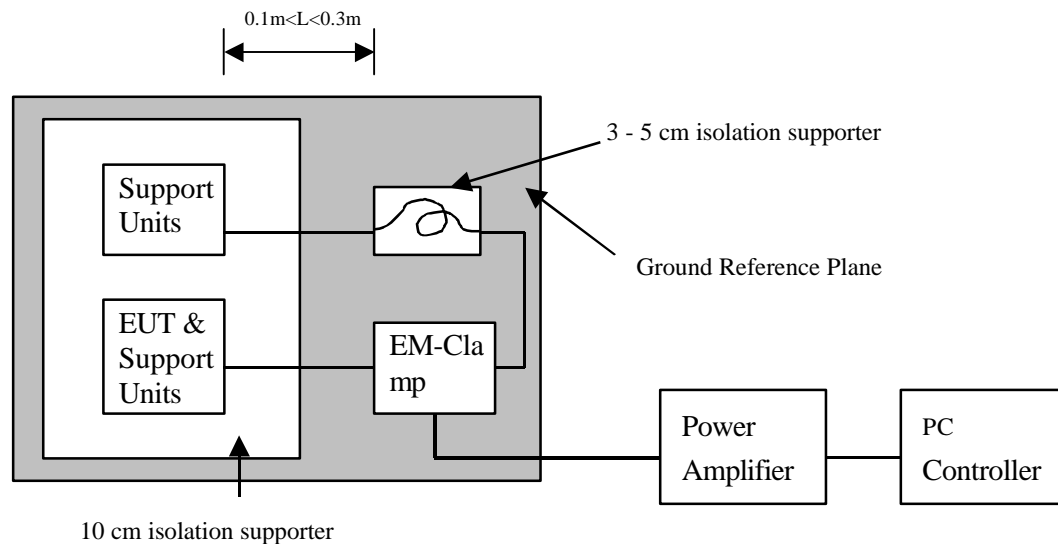

Test Procedure:

1. The EUT and support units were located at a ground reference plane with the interposition of a 0.1 m thickness insulating support and the CDN was located on GRP directly.
2. Transmit data messages were displayed on screen of Monitor.
3. Adjusting the monitoring camera to monitor the transmit data message as clear as possible.
4. Setting the testing parameters of CS test software per EN 61000-4-6.
5. Recording the test result in following table.

Test conditions:

Frequency Range : 0.15MHz-80MHz
Frequency Step : 1% of fundamental
Dwell Time : 3 sec

Range (MHz)	Field	Modulation	Result (Pass/Fail)
0.15-80	3V	Yes	Pass

Performance & Result:

- Criteria A:** The apparatus continues to operate as intended. No degradation of performance or loss of function is allowed below a performance level specified by the manufacturer, when the apparatus is used as intended. In some cases the performance level may be replaced by a permissible loss of performance.
- Criteria B:** The apparatus continues to operate as intended after the test. No degradation of performance or loss of function is allowed below a performance level specified by the manufacturer, when the apparatus is used as intended. In some cases the performance level may be replaced by a permissible loss of performance. During the test, degradation of performance is however allowed.
- Criteria C:** Temporary loss of function is allowed, provided the functions self-recoverable or can be restored by the operation of controls.

<input checked="" type="checkbox"/> PASS <input type="checkbox"/> FAILED
Observation: No any function degraded during the tests.

SECTION 8 IEC 61000-4-8 (POWER FREQUENCY MAGNETIC FIELD IMMUNITY TEST)

POWER FREQUENCY MAGNETIC FIELD IMMUNITY TEST

Port	: Enclosure
Basic Standard	: IEC 61000-4-8
Requirements	: 1 A/m
Performance Criteria	: A (Standard Required)
Temperature	: N/A
Humidity	: N/A
Test By	: N/A

Block Diagram of Test Setup:

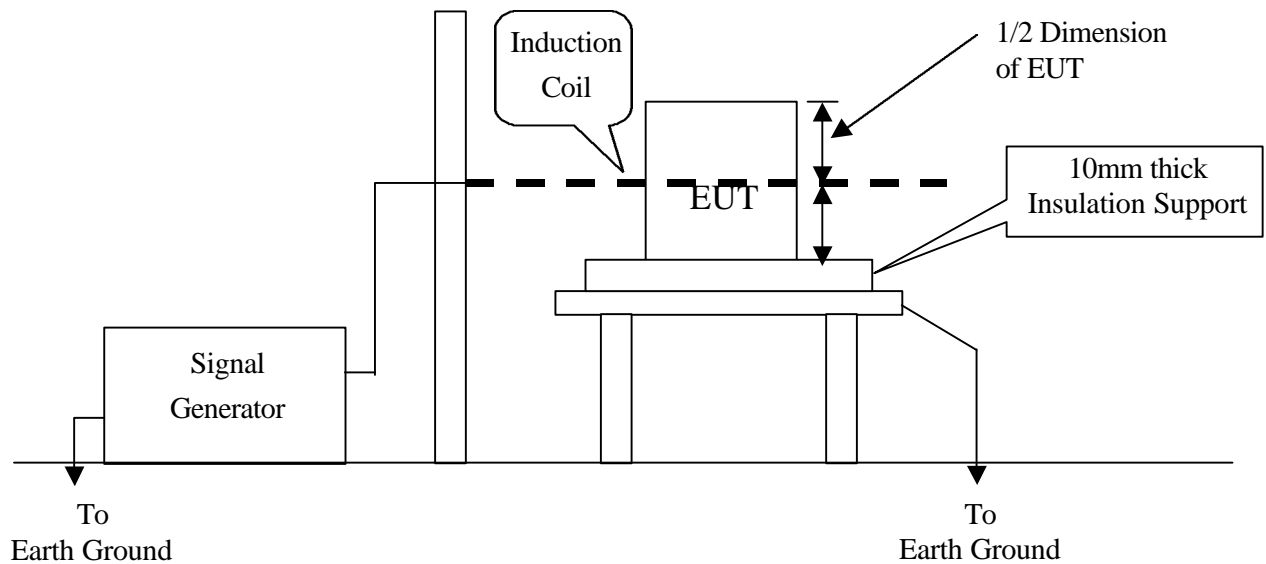

Test Procedure:

1. The EUT and support units were located on Ground Reference Plane with the interposition of a 0.1 m thickness insulation support.
2. Putting the induction coil on horizontal direction.(X direction)
3. A test program was loaded and executed in Windows mode.
4. The data was sent to the screen of EUT and filling the screen with upper case of “H” patterns.
5. The test program exercised related support units sequentially.
6. Repeating step 3 to 5 through the test.
7. Recording the test result as shown in following table.
8. Rotating the induction coil by 90⁰ (Y direction) then repeat step 3 to 7.
9. Rotating the induction coil by 90⁰ again (Z direction) then repeat step 3 to 7.

*. Test conditions:

Field Strength: 1A/m
 Power Freq.: 50Hz
 Orientation: X, Y, Z

Orientation	Field	Result (Pass/Fail)	Remark

****Note:** Not applicable, because no any component can be influenced by power magnetic fields.

Performance & Result:

Criteria A: The apparatus continues to operate as intended. No degradation of performance or loss of function is allowed below a performance level specified by the manufacturer, when the apparatus is used as intended. In some cases the performance level may be replaced by a permissible loss of performance.

Criteria B: The apparatus continues to operate as intended after the test. No degradation of performance or loss of function is allowed below a performance level specified by the manufacturer, when the apparatus is used as intended. In some cases the performance level may be replaced by a permissible loss of performance. During the test, degradation of performance is however allowed.

Criteria C: Temporary loss of function is allowed, provided the functions self recoverable or can be restored by the operation of controls.

PASS	<input type="checkbox"/> FAILED
Observation: N/A(EUT Without any magnetic component)	

SECTION 9 IEC 61000-4-11 (VOLTAGE DIPS, SHORT INTERRUPTIONS AND VOLTAGE VARIATIONS)

VOLTAGE DIPS / SHORT INTERRUPTIONS

Port : AC mains
Basic Standard : IEC 61000-4-11 (1994)
Requirement : PHASE ANGLE 0, 45, 90, 135, 180, 225, 270, 315 degrees

Voltage Dips	Test Level	Reduction	Duration	Performance
	% U_T	(%)	(periods)	Criteria
	<5	>95	0.5	B
70	30	25	C	

Voltage Interruptions	Test Level	Reduction	Duration	Performance
	% U_T	(%)	(periods)	Criteria
<5	>95	250	C	

Test Interval : Min. 10 sec.
Temperature : 23⁰C
Humidity : 59%
Test By : Sam Hu

Block Diagram of Test Setup:

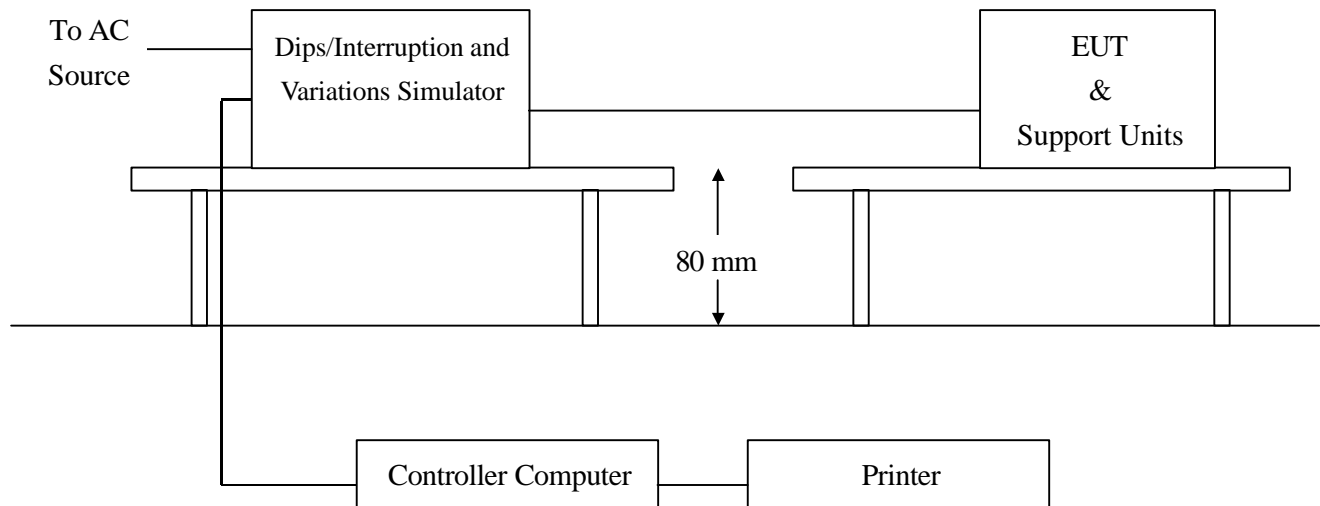

Test Procedure:

1. The EUT and support units were located on a wooden table, 0.8 m away from ground floor.
2. A test program was loaded and executed in Windows mode.
3. The data was displayed on the monitor and filling the screens.
4. The test program exercised related support units sequentially.
5. Setting the parameter of tests and then Perform the test software of test simulator.
6. Conditions changes to occur at 0 degree crossover point of the voltage waveform.
7. Repeating step 3 to 4 through the test.
8. Recording the test result in test record form.

Test conditions:

The duration with a sequence of three dips/interruptions with interval of 10s minimum (between each test events)

Voltage Dips:

Test Level % U _T	Reduction (%)	Duration (periods)	Observation	Meet Performance Criteria
0	100	0.5	Normal	A
70	30	25	Normal	A

Voltage Interruptions:

Test Level % U _T	Reduction (%)	Duration (periods)	Observation	Meet Performance Criteria
0	100	250	EUT shut down, But EUT can be auto recovered after EUT restart.	C

Normal: No any functions degrade during and after the test.

Performance & Result:

Criteria A: The apparatus continues to operate as intended. No degradation of performance or loss of function is allowed below a performance level specified by the manufacturer, when the apparatus is used as intended. In some cases the performance level may be replaced by a permissible loss of performance.

Criteria B: The apparatus continues to operate as intended after the test. No degradation of performance or loss of function is allowed below a performance level specified by the manufacturer, when the apparatus is used as intended. In some cases the performance level may be replaced by a permissible loss of performance. During the test, degradation of performance is however allowed.

Criteria C: Temporary loss of function is allowed, provided the functions self recoverable or can be restored by the operation of controls.

<input checked="" type="checkbox"/> PASS	<input type="checkbox"/> FAILED
---	--

APPENDIX 1

PHOTOGRAPHS OF TEST SETUP

LINE CONDUCTED EMISSION TEST (EN 55022)



RADIATED EMISSION TEST (EN 55022)



POWER HARMONIC & VOLTAGE FLUCTUATION / FLICKER TEST
(EN 61000-3-2, EN 61000-3-3)



ELECTROSTATIC DISCHARGE TEST (IEC 61000-4-2)



RADIATED ELECTROMAGNETIC FIELD (IEC 61000-4-3)
Front View

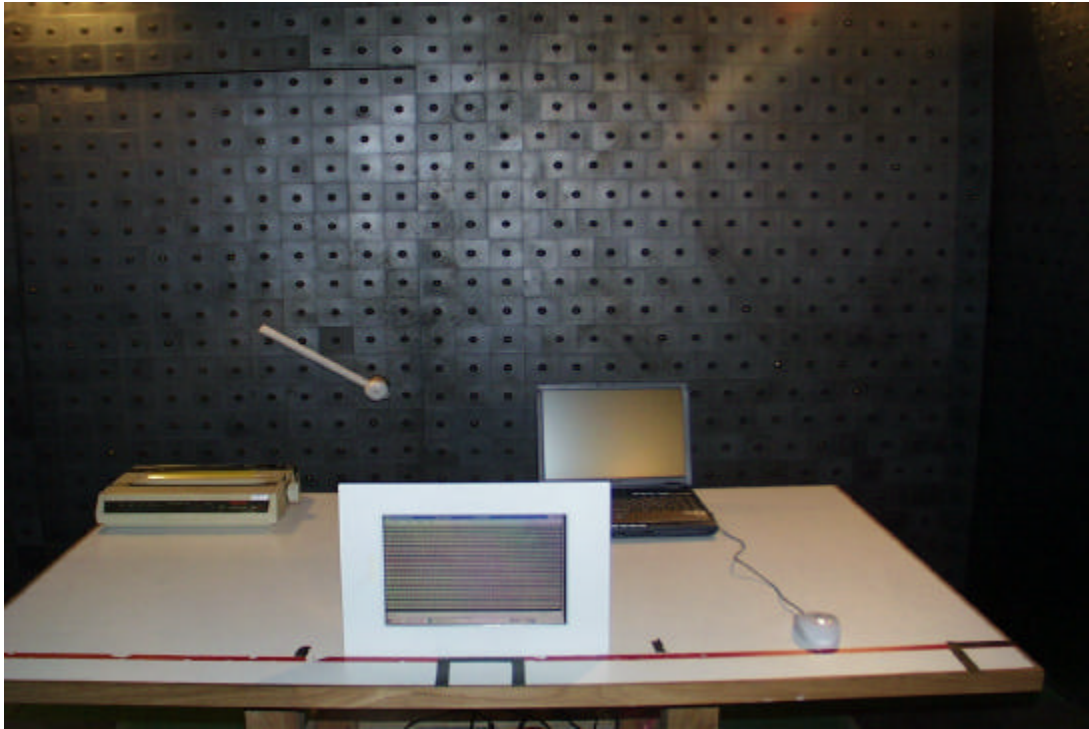

Back View

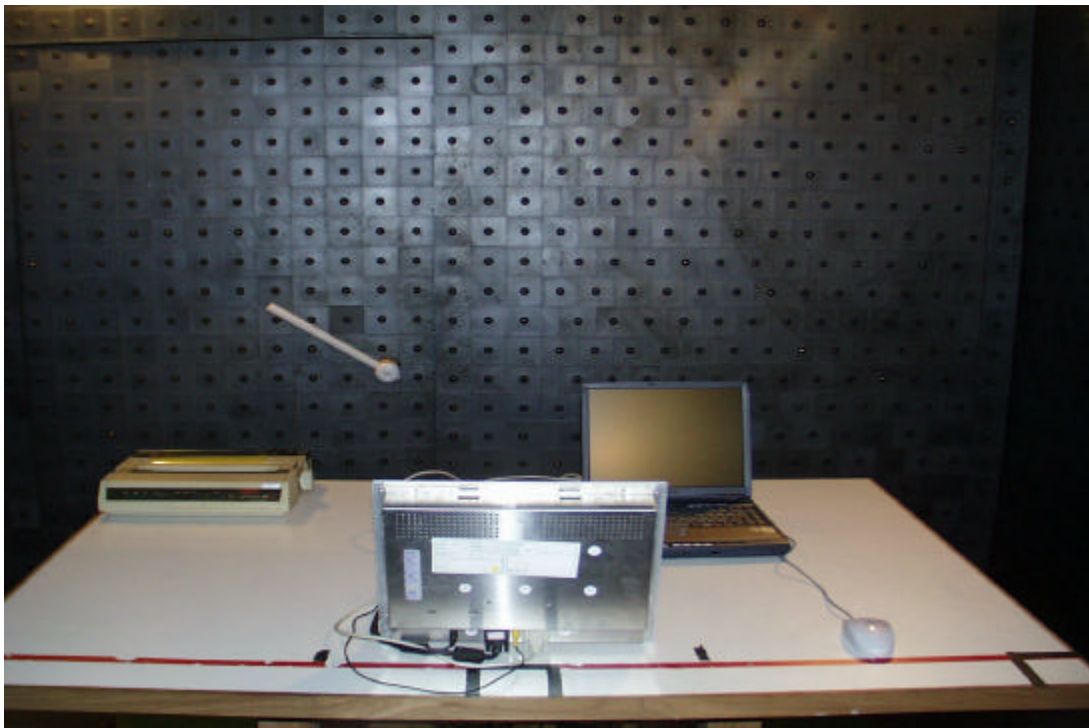

Right View

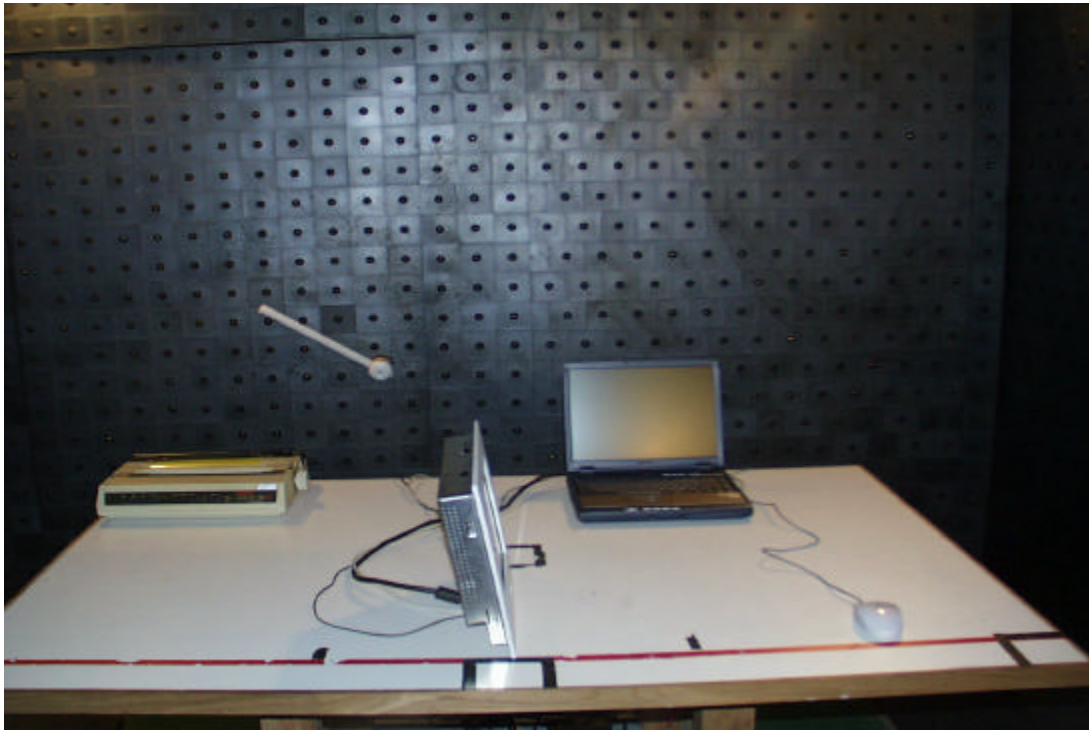

Left View

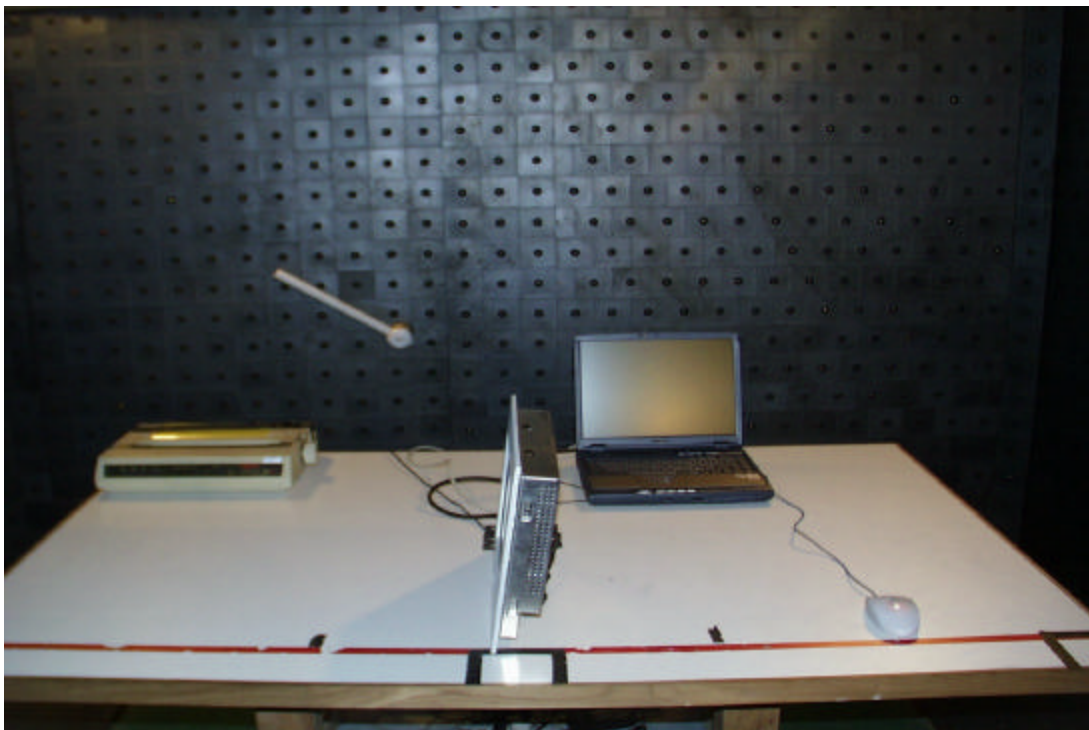

**FAST TRANSIENTS/BURST TEST & SURGE IMMUNITY TEST
(IEC 61000-4-4/5)**



CONDUCTED DISTURBANCE, INDUCED BY RADIO-FREQUENCY FIELDS TEST (IEC 61000-4-6)

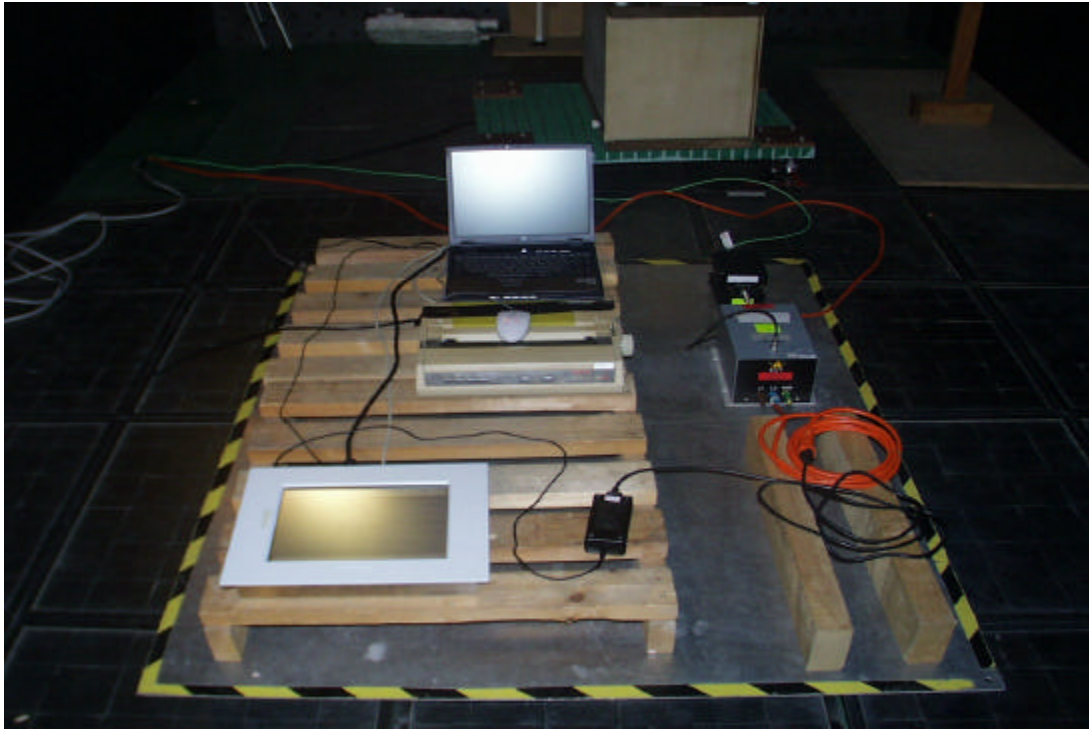

VOLTAGE DIPS / INTERRUPTION TEST (IEC 61000-4-11)



APPENDIX 2

PHOTOGRAPHS OF EUT

Model Number: AMB-220A

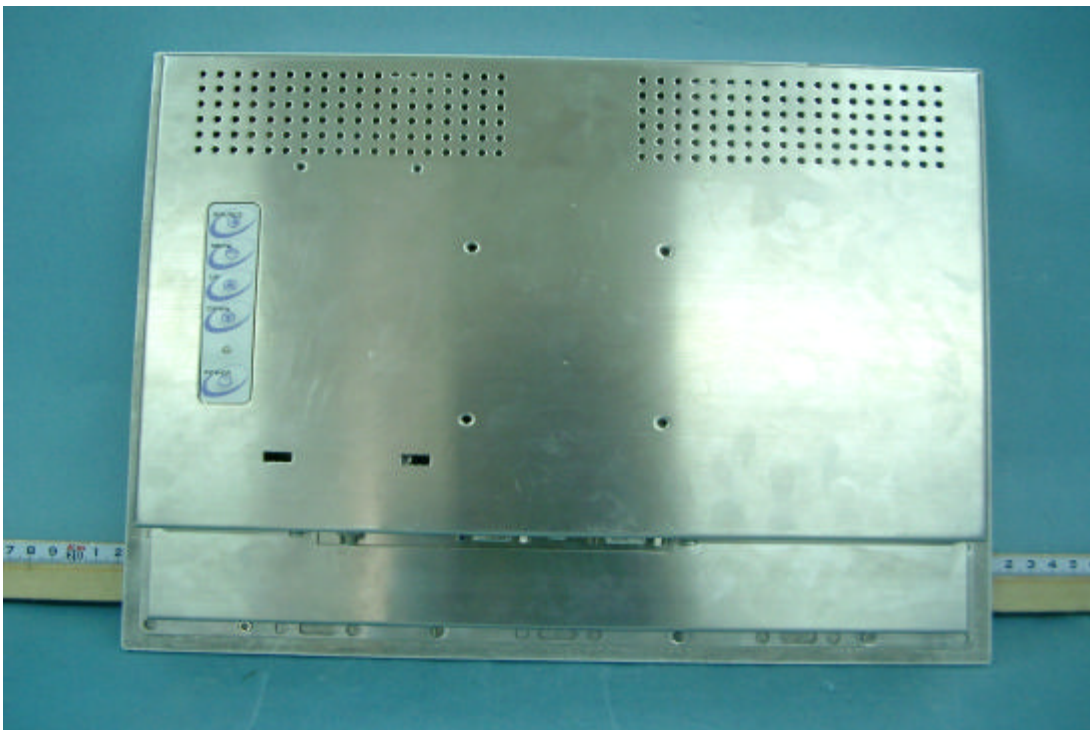





Model Number: OPD-212A

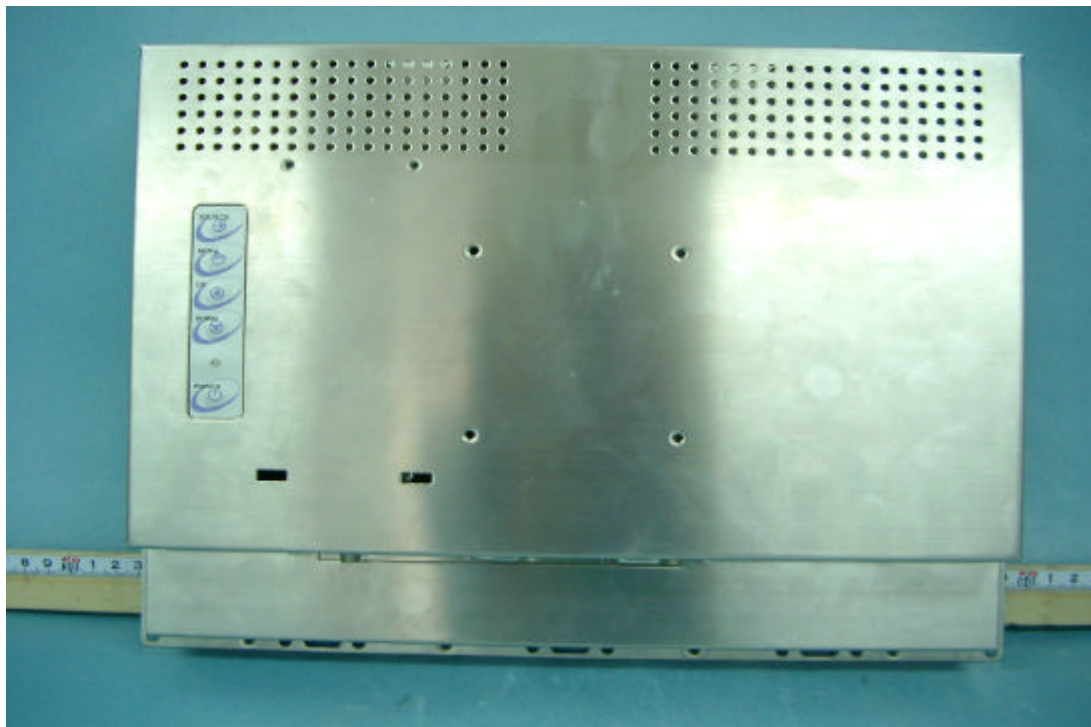



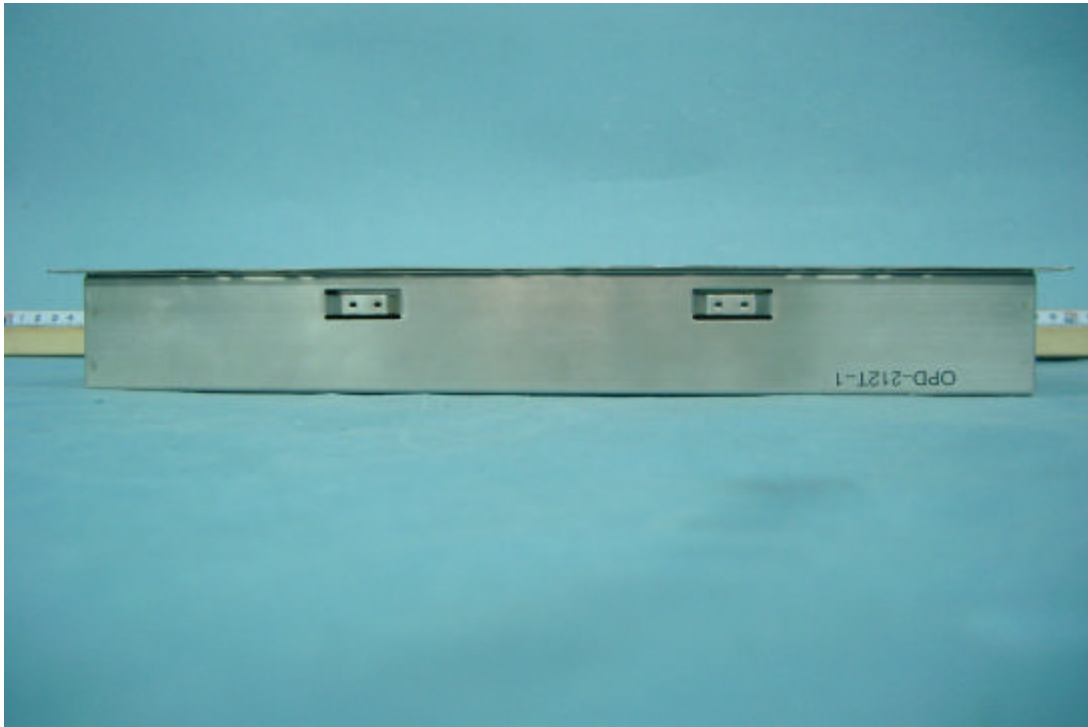

Cable & Adaptor





APPENDIX 3

CONDUCTED EMISSION PLOT RADIATED EMISSION DATA

Data#: 52 File#: 9999c.EMI

Date: 2002-03-12 Time: 10:03:14

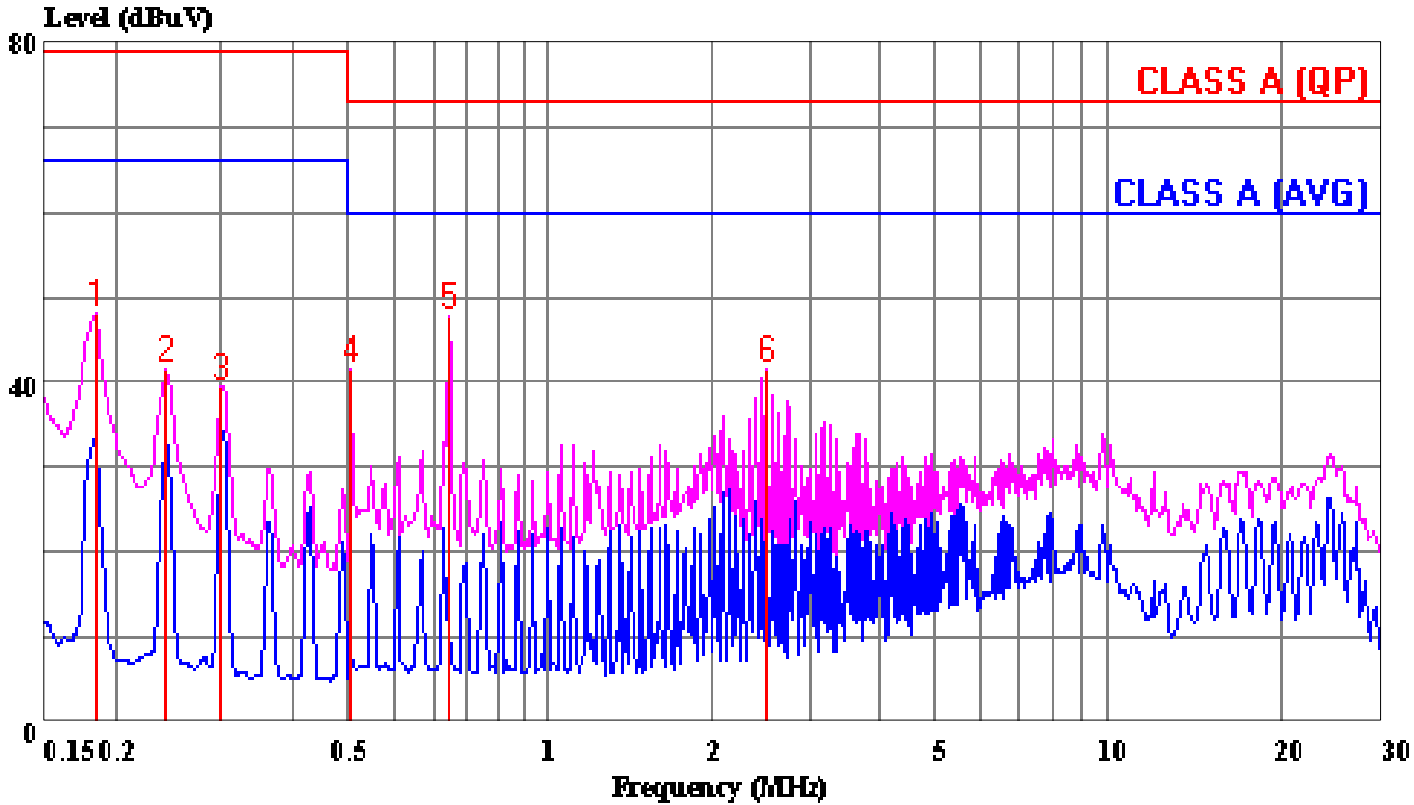

(CES Conducted)

Trace: 41 42

Ref Trace:

Condition: LINE
Report No. : 02E9999
Test Engr. : JAMES LIAO
Company : AAEON Technology Inc.
EUT : AMB-220A
Test Config : EUT/ ALL PERIPHERALS
Type of Test: EN 55022 CLASS A
Mode of Op. : VGA MODE (WORST)

Page: 1

	Read			Limit	Over	
Freq	Level	Factor	Level	Line	Limit	Remark
MHz	dBuV	dB	dBuV	dBuV	dB	
1	0.183	48.16	0.02	48.18	79.00	-30.82 Peak
2	0.243	41.38	0.02	41.40	79.00	-37.60 Peak
3	0.302	39.57	0.02	39.59	79.00	-39.41 Peak
4	0.505	41.51	0.05	41.56	73.00	-31.44 Peak
5	0.747	47.86	0.07	47.93	73.00	-25.07 Peak
6	2.622	41.35	0.16	41.51	73.00	-31.49 Peak

Data#: 51 File#: 9999c.EMI

Date: 2002-03-12 Time: 10:01:34

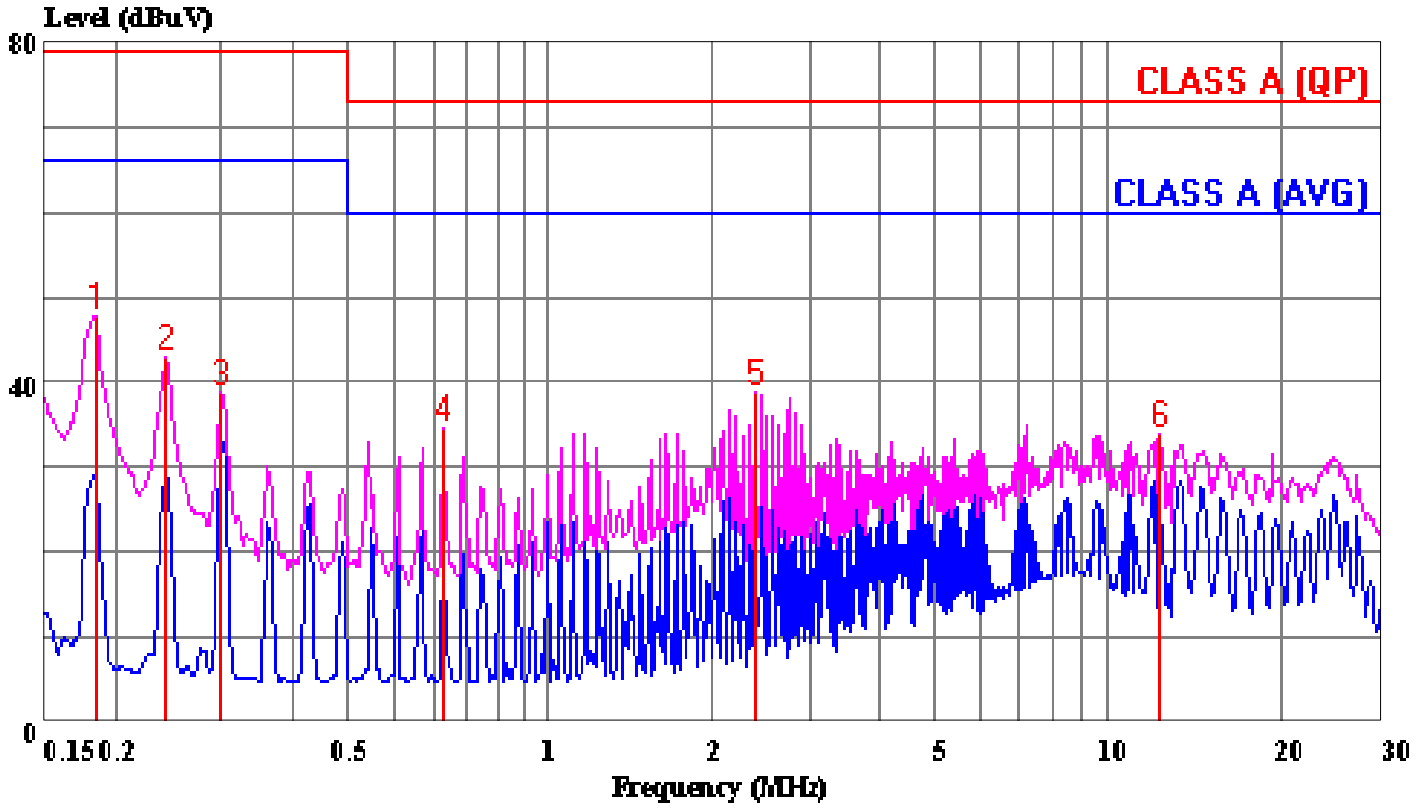

(CES Conducted)

Trace: 49 50

Ref Trace:

Condition: NEUTRAL
Report No. : 02E9999
Test Engr. : JAMES LIAO
Company : AAEON Technology Inc.
EUT : AMB-220A
Test Config : EUT/ ALL PERIPHERALS
Type of Test: EN 55022 CLASS A
Mode of Op. : VGA MODE (WORST)

Page: 1

	Read			Limit	Over	
Freq	Level	Factor	Level	Line	Limit	Remark
MHz	dBuV	dB	dBuV	dBuV	dB	
1	0.183	47.86	0.02	47.88	79.00	-31.12 Peak
2	0.243	42.92	0.02	42.94	79.00	-36.06 Peak
3	0.302	38.76	0.02	38.78	79.00	-40.22 Peak
4	0.724	34.47	0.07	34.54	73.00	-38.46 Peak
5	2.500	38.66	0.16	38.82	73.00	-34.18 Peak
6	12.384	33.56	0.37	33.93	73.00	-39.07 Peak

Data#: 1 File#: 9999d.EMI
D-Site

Date: 2002-03-11 Time: 18:08:15

Condition: VERTICAL / 10m
Report No. : 02E9999
Test Engr. : JAMES LIAO
Company : AAEON Technology Inc.
EUT : AMB-220A
Test Config : EUT/ALL PERIPHERALS
Type of Test: EN 55022 CLASS A
Mode of Op. : VGA MODE (WORST)

Page: 1

	Freq	Read Level	Factor	Level	Limit Line	Over Limit	Remark
	MHz	dBuV	dB	dBuV/m	dBuV/m	dB	
1	120.156	40.49	-8.21	32.28	40.00	-7.72	Peak
2	155.733	36.43	-5.31	31.12	40.00	-8.88	Peak
3	180.222	36.15	-6.54	29.61	40.00	-10.39	Peak
4	204.622	36.18	-8.00	28.18	40.00	-11.82	Peak
5	240.622	38.44	-6.48	31.96	47.00	-15.04	Peak
6	263.845	38.05	-5.83	32.22	47.00	-14.78	Peak
7	295.933	34.75	-4.88	29.87	47.00	-17.13	Peak
8	325.711	37.83	-4.09	33.74	47.00	-13.26	Peak

Data#: 2 File#: 9999d.EMI
D-Site

Date: 2002-03-11 Time: 18:18:22

Condition: HORIZONTAL / 10m
Report No. : 02E9999
Test Engr. : JAMES LIAO
Company : AAEON Technology Inc.
EUT : AMB-220A
Test Config : EUT/ALL PERIPHERALS
Type of Test: EN 55022 CLASS A
Mode of Op. : VGA MODE (WORTS)

Page: 1

	Freq	Read Level	Factor	Level	Limit Line	Over Limit	Remark
	MHz	dBuV	dB	dBuV/m	dBuV/m	dB	
1	120.133	39.73	-8.21	31.52	40.00	-8.48	Peak
2	155.733	40.39	-5.31	35.08	40.00	-4.92	Peak
3	180.189	36.30	-6.54	29.76	40.00	-10.24	Peak
4	204.600	43.51	-8.00	35.51	40.00	-4.49	Peak
5	240.494	39.17	-6.48	32.69	47.00	-14.31	Peak
6	263.583	38.31	-5.87	32.44	47.00	-14.56	Peak
7	295.911	35.49	-4.88	30.61	47.00	-16.39	Peak
8	325.722	38.87	-4.09	34.78	47.00	-12.22	Peak