

EMB-BT4

Industrial Motherboard

E10155
First Edition
April 2015

Copyright Notice

This document is copyrighted, 2015. All rights are reserved. The original manufacturer reserves the right to make improvements to the products described in this manual at any time without notice.

No part of this manual may be reproduced, copied, translated, or transmitted in any form or by any means without the prior written permission of the original manufacturer. Information provided in this manual is intended to be accurate and reliable. However, the original manufacturer assumes no responsibility for its use, or for any infringements upon the rights of third parties that may result from its use. The material in this document is for product information only and is subject to change without notice. While reasonable efforts have been made in the preparation of this document to assure its accuracy, the original manufacturer assumes no liabilities resulting from errors or omissions in this document, or from the use of the information contained herein.

The original manufacturer reserves the right to make changes in the product design without notice to its users.

Acknowledgments

All other products' name or trademarks are properties of their respective owners.

- AMI is a trademark of American Megatrends Inc.
- Intel®, Core™ are trademarks of Intel® Corporation.
- Microsoft Windows® is a registered trademark of Microsoft Corp.
- IBM, PC/AT, PS/2, and VGA are trademarks of International Business Machines Corporation.

The original manufacturer reserves the right to make changes in the product design without notice to its users.

All other product names or trademarks are properties of their respective owners.

Contents

Chapter 1	Product overview	1-1
1.1	Package contents.....	1-1
1.2	Features	1-1
1.3	Specifications.....	1-2
Chapter 2	Motherboard information	2-1
2.1	Before you proceed	2-1
2.2	Motherboard layout.....	2-2
2.3	Screw size.....	2-4
	2.3.1 Component side.....	2-4
	2.3.2 Solder side	2-5
2.4	Central Processing Unit (CPU)	2-6
2.5	System memory	2-6
	2.5.1 Installing a DIMM	2-7
2.6	Jumpers	2-8
2.7	Onboard LEDs	2-11
2.8	Connectors	2-12
	2.8.1 Rear panel connectors.....	2-12
	2.8.2 Internal connectors	2-14
Chapter 3	BIOS setup	3-1
3.1	BIOS setup.....	3-1
	3.1.1 Menu bar	3-2
3.2	Main menu	3-2
	3.2.1 System Date [Day MM/DD/YYYY]	3-2
	3.2.2 System Time [HH:MM:SS].....	3-2
3.3	Advanced menu	3-3
	3.3.1 Power Management.....	3-3
	3.3.2 CPU Configuration	3-4
	3.3.3 Super IO Configuration	3-4
	3.3.4 Dynamic Digital IO	3-5
	3.3.5 Trusting Computing.....	3-5
	3.3.6 USB Configuration	3-5
	3.3.7 Hardware Monitor	3-6
	3.3.8 IDE Configuration.....	3-7
3.4	Chipset menu	3-8

3.4.1	North Bridge Configuration	3-8
3.4.2	South Bridge Configuration.....	3-8
3.5	Security menu	3-9
3.5.1	Administrator Password.....	3-9
3.5.2	User Password.....	3-9
3.6	Boot menu	3-10
	Boot Configuration	3-10
3.7	Save & Exit menu	3-11
Appendix		A-1
Notices.....		A-1

Chapter 1

Product overview

1.1 Package contents

Check your industrial motherboard package for the following items.

- 1 x Industrial Motherboard
- 1 x SATA Cable
- 1 x I/O Shield
- 1 x Support CD



If any of the above items is damaged or missing, contact your distributor or sales representative immediately.

1.2 Features

- Intel® J1900 / N2807
- 2 x SO-DIMM, max. 8GB (64bit BIOS), DDR3L 1333MHz (J1900), 1 x SO-DIMM, max. 4GB (64bit BIOS), DDR3L 1333MHz (N2807)
- SATA 6.0 Gb/s x 2, SATA 3.0 Gb/s x 2, USB3.0 x 1, USB2.0 x 7
- 1 x Full-size Mini Card (PCIe +USB or mSATA) + SIM Card (mSATA default), Half-size Mini Card (PCIe + USB) x 1
- VGA, HDMI, 18/24-bit Dual Channel LVDS support

1.3 Specifications

SYSTEM	
Form factor	Mini-ITX
CPU	J1900 / N2807 , Bay Trail-D (4C @ 2GHz CPU, 688/750 (Turbo) GFX, ~10W TDP)
Memory	2 x SO-DIMM, max. 8GB (64 bit BIOS), DDR3L 1333 MHz (J1900), 1 x SO-DIMM, max. 4GB (64 bit BIOS), DDR3L 1333 MHz (N2807), non-ECC, un-buffered memory, (Bay Trail-D/M/I Premium) horizontal type
I/O Chipset	Fintech 81866D
Ethernet	1 x Realtek PCIe Gb LAN 8111G
BIOS	64Mbit Flash ROM, AMI BIOS
Wake on LAN	Yes (WOL/PXE)
Watchdog Timer	1~255 steps by software program
H/W Status Monitor	Monitors CPU/Chassis temperature Monitors Vcore/5V/3.3V/12V voltages Monitors CPU/Chassis fan speed
Smart Fan Control	Chassis Fan (fanless)
Power State	S3, S4, S5
Expansion slot	1 x Full-size Mini Card (PCIe +USB or mSATA) + SIM Card (mSATA default) 1 x Half-size Mini Card (PCIe +USB)
TPM	Infineon SLB9635 TT 1.2 (optional)
Battery	Lithium battery
Power requirement	12V DC
Board size	6.7 in. x 6.7 in. (17.0 cm x 17.0 cm)
Gross weight	1.1 lb (0.5 Kg)
Operating temperature	32°F~140°F (0°C~60°C)
Storage temperature	-40°F~185°F (-40°C~85°C)
Operating humidity	0%~90% relative humidity, non-condensing
Power compliance	Compliant with Eup/ErP
Certificate	CE/FCC

(continued on the next page)

DISPLAY	
Chipset	Intel® HD Graphics
Resolution	Up to 1920x1200@60Hz for VGA Up to 1920x1200@60Hz for HDMI Up to 1920x1080@60Hz, Dual Channel 18/24-bit (via CH7511) for LVDS/eDP
Output interface	1 x LVDS 1 x VGA 1 x HDMI
I/O	
Storage	2 x SATA 6.0Gb/s ports 2 x SATA 3.0Gb/s ports (1 colay with Full Size Mini Card) 1 x SATA power connector
Serial port	5 x RS-232, 1 x RS-232/422/485 supports 5V/12V/RI (COM1)
USB	9 x USB 2.0 ports (2 ports at back panel, 5 ports at mid-board,2 port at Mini Card interface) 1 x USB 3.0 ports (1 ports at back panel)
Fan	1 x Chassis Fan connector (4-pin)
PS/2 port	1 x PS/2 Keyboard / mouse port on rear I/O
Audio	Line-in Line-out
Ethernet	1 x RJ-45 ports on rear I/O
Display	1 x VGA (internal pin header) port on rear I/O 1 x HDMI port on rear I/O 1 x LVDS port on rear I/O
Others	1 x 8-bit Programmable Digital I/O 1 x Front panel connector 1 x AT/ATX mode select jumper (optional)

Chapter 2

Motherboard information

2.1 Before you proceed

Take note of the following precautions before you install motherboard components or change any motherboard settings.



CAUTION!

- Unplug the power cord from the wall socket before touching any component.
 - Before handling components, use a grounded wrist strap or touch a safely grounded object or a metal object, such as the power supply case, to avoid damaging them due to static electricity.
 - Hold components by the edges to avoid touching the ICs on them.
 - Whenever you uninstall any component, place it on a grounded antistatic pad or in the bag that came with the component.
 - Before you install or remove any component, ensure that the ATX power supply is switched off or the power cord is detached from the power supply. Failure to do so may cause severe damage to the motherboard, peripherals, or components.
-

2.2 Motherboard layout



NOTE: Place four screws into the holes indicated by circles to secure the motherboard to the chassis.



CAUTION! Do not overtighten the screws! Doing so can damage the motherboard.

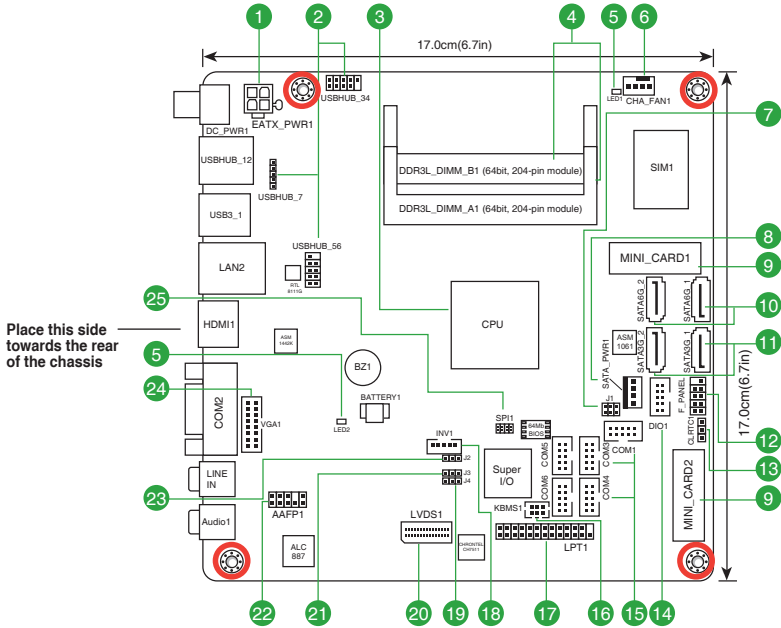

Connectors/Jumpers/Slots		Page
1.	12VDC connector (4-pin EATX_PWR1)	2-14
2.	USB 2.0 connector (10-1 pin USBHUB_34, USBHUB_56 and USBHUB_7)	2-19
3.	CPU	2-6
4.	SO-DIMM memory slots	2-6
5.	Standby Power LED (SB_PWR_LED1, Main_PWR_LED2)	2-11
6.	Chassis fan connectors (4-pin CHA_FAN1)	2-15
7.	COM1 Ring/+5V/+12V selection (6-pin J1)	2-10
8.	SATA power connector (SATA_PWR1)	2-17
9.	Minicard connector (MINI_CARD1, MINI_CARD2)	2-19
10.	Serial ATA 6.0Gb/s connectors (7-pin SATA6G_1, SATA6G_2)	2-17
11.	Serial ATA 3.0Gb/s connectors (7-pin SATA3G_1, SATA3G_2)	2-23
12.	System panel connector (10-1 pin F_PANEL)	2-16
13.	Clear RTC RAM (CLRRTC)	2-8
14.	Digital I/O connector (DIO1)	2-22
15.	Serial port connectors (10-1 pin COM1, COM3-6)	2-21
16.	PS/2 keyboard and mouse connector (KBMS1)	2-22
17.	LPT connector	2-20
18.	Backlight inverter power connector (5-pin INV1)	2-18
19.	LVDS panel voltage selection (3-pin J4)	2-21
20.	LVDS connector (30-pin LVDS1)	2-18
21.	Inverter backlight control of inverter selector (3-pin J3)	2-10
22.	Front panel audio connector (10-1 pin AAFP)	2-15
23.	Inverter voltage selection (3-pin J2)	2-9
24.	VGA connector (16-pin VGA)	2-23
25.	BIOS programmable connector (8-pin SPI)	2-20

2.3 Screw size

2.3.1 Component side

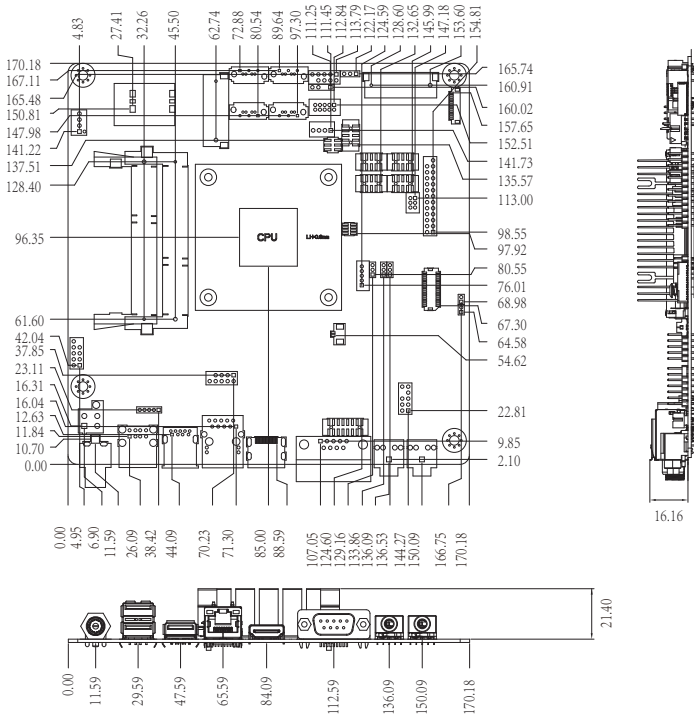

2.3.2 Solder side

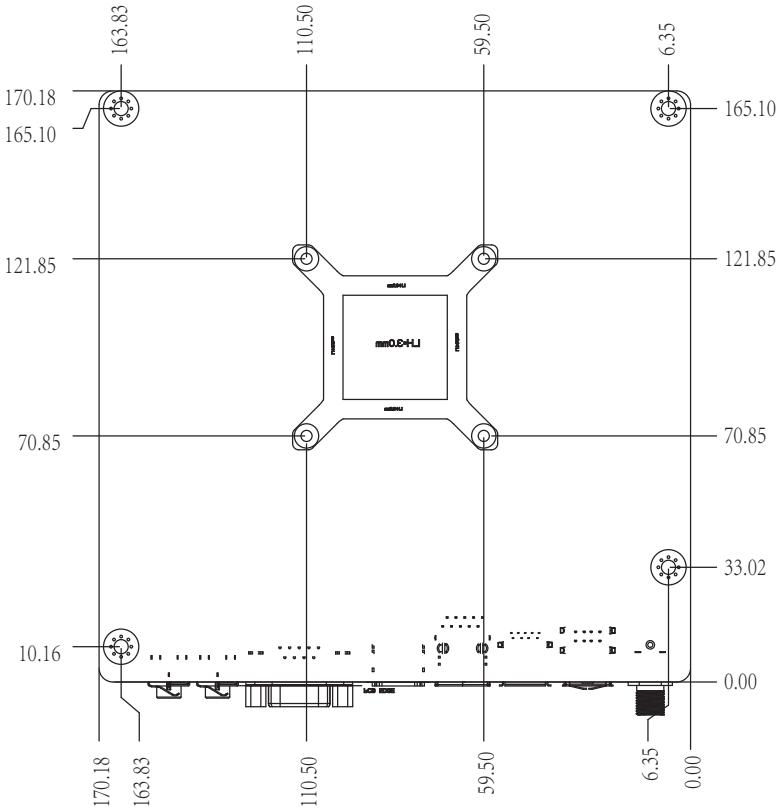

2.4 Central Processing Unit (CPU)

This motherboard comes with an Intel® J1900/N2807 processor.

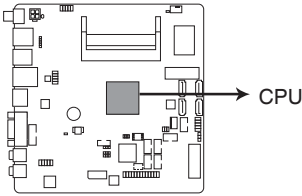

EMB-BT4 CPU

2.5 System memory

This motherboard comes with two Double Data Rate 3 Low Voltage (DDR3L) Small Outline Dual Inline Memory Modules (SO-DIMM) socket. The figure illustrates the location of the DDR3L DIMM socket:

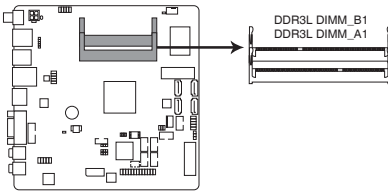

EMB-BT4 204-pin DDR3L DIMM sockets



NOTE: Use the SO-DIMM_A1 slot when inserting only one SO-DIMM.

2.5.1 Installing a DIMM

To install a SO-DIMM

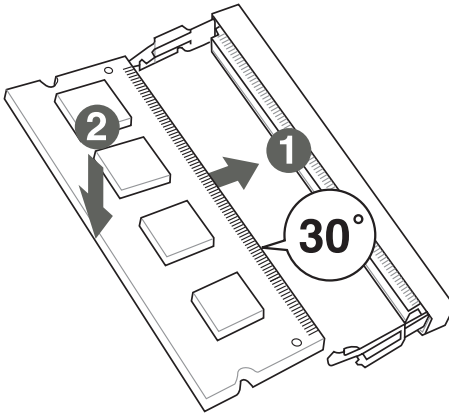

To remove a SO-DIMM

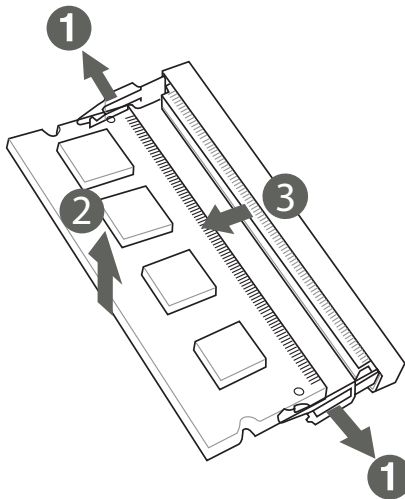

2.6 Jumpers

1. Clear RTC RAM (CLRRTC)

This jumper allows you to clear the Real Time Clock (RTC) RAM in CMOS. You can clear the CMOS memory of system setup parameters by erasing the CMOS RTC RAM data. The onboard button cell battery powers the RAM data in CMOS, which include system setup information such as system passwords.

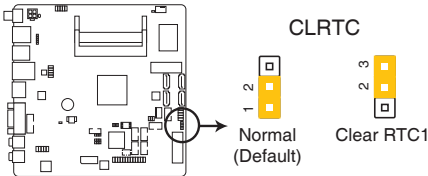

EMB-BT4 Clear RTC RAM

To erase the RTC RAM:

1. Turn OFF the computer and unplug the power cord.
2. Move the jumper cap from pins 1-2 (default) to pins 2-3. Keep the cap on pins 2-3 for about 5~10 seconds, then move the cap back to pins 1-2.
3. Plug the power cord and turn ON the computer.
4. Hold down the key during the boot process and enter BIOS setup to reenter data.



CAUTION! Except when clearing the RTC RAM, never remove the cap on CLRRTC jumper default position. Removing the cap will cause system boot failure!



NOTES:

- If the steps above do not help, remove the onboard battery and move the jumper again to clear the CMOS RTC RAM data. After clearing the CMOS, reinstall the battery.
 - You do not need to clear the RTC when the system hangs due to overclocking. For system failure due to overclocking, use the CPU Parameter Recall (C.P.R) feature. Shut down and reboot the system so the BIOS can automatically reset parameter settings to default values.
-

2. COM1 Ring/+5V/+12V selector (6-pin J1)

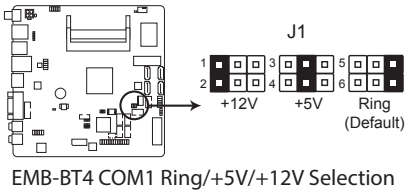

Setting	Pins
+12V	1-2
+5V	3-4
Ring (Default)	5-6

3. Inverter voltage selection (3-pin J2)

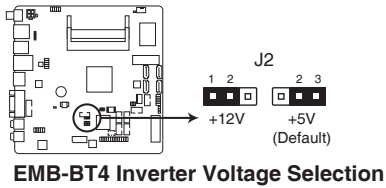

Setting	Pins
+12V	1-2
+5V (Default)	2-3

4. Inverter Backlight Control of Inverter selector (3-pin J3)

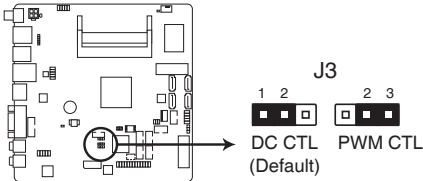

EMB-BT4 Mode Selection for Back Light Control of Inverter

Setting	Pins
DC Voltage Control (Default)	1-2
PWM Control	2-3

5. LVDS panel voltage selection (3-pin J4)

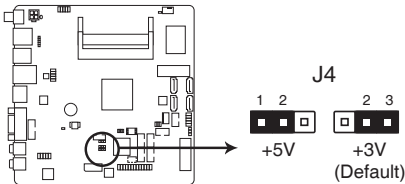

EMB-BT4 LVDS Panel Voltage Selection

Setting	Pins
+5V	1-2
+3V (Default)	2-3

2.7 Onboard LEDs

1. Standby Power LED

The motherboard comes with a standby power LED that lights up to indicate that the system is ON, in sleep mode, or in soft-off mode. This is a reminder that you should shut down the system and unplug the power cable before removing or plugging in any motherboard component. The illustration below shows the location of the onboard LED.

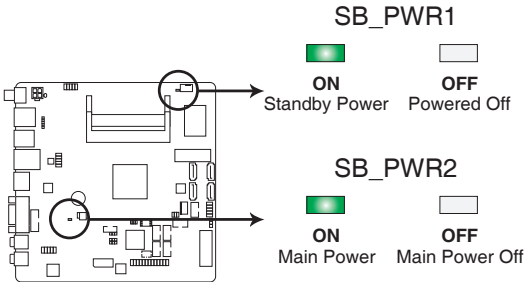

EMB-BT4 Onboard LEDs

2.8 Connectors

2.8.1 Rear panel connectors

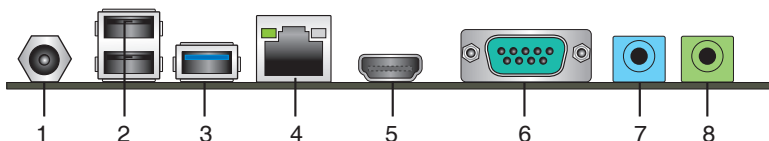

1. **DC power connector.** Insert the power adapter into this port.
2. **USB 2.0 ports.** These two 4-pin Universal Serial Bus (USB) ports are available for connecting USB 2.0/1.1 devices.



NOTE: Before you install Windows 7 operating system, go to BIOS Setup > Advanced > XHCI mode [Disabled], USB 2.0 (EHCI) support [Enabled], and set them back when you finish installing the operating system. .

3. **USB 3.0 ports.** These two 9-pin Universal Serial Bus (USB) ports connect to USB 3.0/2.0 devices.



NOTES:

- DO NOT connect a keyboard / mouse to any USB 3.0 port when installing Windows® operating system.
- Due to USB 3.0 controller limitation, USB 3.0 devices can only be used under Windows® OS environment and after the USB 3.0 driver installation.
- USB 3.0 devices can be used for data storage only.
- We strongly recommend that you connect USB 3.0 devices to USB 3.0 ports for a faster and better performance from your USB 3.0 devices.

4. **LAN2 (RJ-45) ports.** This port allows Gigabit connection to a Local Area Network (LAN) through a network hub. Refer to the table below for the LAN2 port LED indications.

LAN port LED indications

ACT/LINK LED		SPEED LED	
Status	Description	Status	Description
OFF	No link	OFF	10 Mbps connection
ORANGE	Linked	ORANGE	100 Mbps connection
BLINKING	Data activity	GREEN	1 Gbps connection

Activity Link LED Speed LED



LAN port

5. **HDMI port.** This port is for a High-Definition Multimedia Interface (HDMI) connector, and is HDCP compliant allowing playback of HD DVD, Blu-ray, and other protected content.
6. **Serial port (COM2).** This port connects a modem, or other devices that conform with serial specification. This serial port also supports RS-232 (COM2 is optional).
7. **Line In port (light blue).** This port connects the tape, CD, DVD player, or other audio sources.
8. **Line Out port (lime).** This port connects to a headphone or a speaker.

2.8.2 Internal connectors

1. 12VDC power connectors (4-pin EATX_PWR1)

This connector is for an EATX power supply plug. The power supply plug is designed to fit this connector in only one orientation. Find the proper orientation and push down firmly until the connector completely fits.

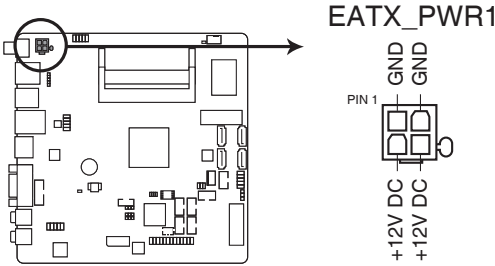

EMB-BT4 ATX power connector



IMPORTANT:

- For a fully configured system, we recommend that you use a power supply unit (PSU) that complies with ATX 12V Specification 2.0 (or later version).
 - DO NOT forget to connect the 4-pin ATX +12V power plug. Otherwise, the system will not have enough power.
 - We recommend that you use a PSU with higher power output when configuring a system with more power-consuming devices. The system may become unstable or may not boot up if the power is inadequate.
-

2. Chassis fan connectors (4-pin CHA_FAN1)

Connect the fan cables to the fan connectors on the motherboard, ensuring that the black wire of each cable matches the ground pin of the connector.

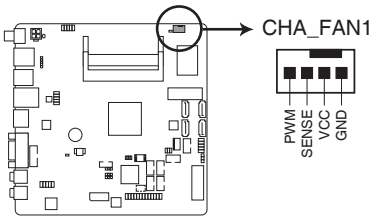

EMB-BT4 Chassis Fan connector



CAUTION: Do not forget to connect the fan cables to the fan connectors. Insufficient air flow inside the system may damage the motherboard components. These are not jumpers! Do not place jumper caps on the fan connectors!

3. Front panel audio connector (10-1 pin AAFP)

This connector is for a chassis-mounted front panel audio I/O module that supports either HD Audio or legacy AC'97 audio standard. Connect one end of the front panel audio I/O module cable to this connector.

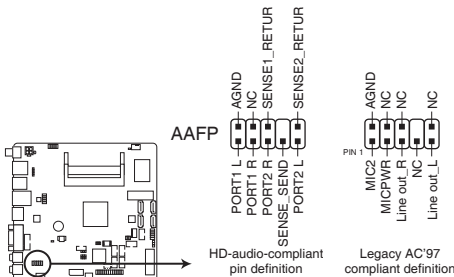

EMB-BT4 Front panel audio connector



IMPORTANT: We recommend that you connect a high-definition front panel audio module to this connector to avail of the motherboard's high-definition audio capability.

4. System panel connector (10-1 pin F_PANEL)

This connector supports several chassis-mounted functions.

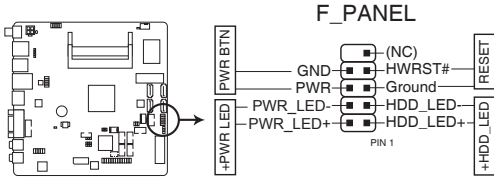

EMB-BT4 System panel connector

- **System power LED (2-pin PWR_LED)**

This 2-pin connector is for the system power LED. Connect the chassis power LED cable to this connector. The system power LED lights up when you turn on the system power, and blinks when the system is in sleep mode.

- **Hard disk drive activity LED (2-pin HDD_LED)**

This 2-pin connector is for the HDD Activity LED. Connect the HDD Activity LED cable to this connector. The HDD LED lights up or flashes when data is read from or written to the HDD.

- **ATX power button/soft-off button (2-pin PWR_BTN)**

This 2-pin connector is for the system power button.

- **Reset button (2-pin RESET)**

This 2-pin connector is for the chassis-mounted reset button for system reboot without turning off the system power.

5. Serial ATA 6.0Gb/s connector (7-pin SATA6G_1, SATA6G_2)

This connector connects to Serial ATA 6.0 Gb/s hard disk drives via Serial ATA 6.0 Gb/s signal cables.

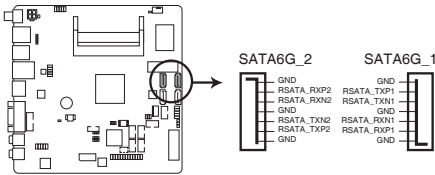

EMB-BT4 SATA 6.0Gb/s connectors



IMPORTANT:

- You must install Windows® XP Service Pack 3 or later version before using Serial ATA hard disk drives.
- When using hot-plug and NCQ, set the SATA Mode Selection item in the BIOS to [AHCI]. See section 3.3.7 IDE Configuration for details.

6. SATA power connector (4-pin SATA_PWR1)

This connector is for the SATA power cable. The power cable plug is designed to fit this connector in only one orientation. Find the proper orientation and push down firmly until the connector completely fit.

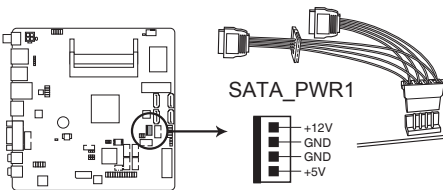

EMB-BT4 SATA POWER Connector



IMPORTANT: The SATA power connector supports 1A current to the maximum.

7. LVDS connector (30-pin LVDS1)

This connector is for an LCD monitor that supports Low-Voltage Differential Signaling (LVDS) interface.

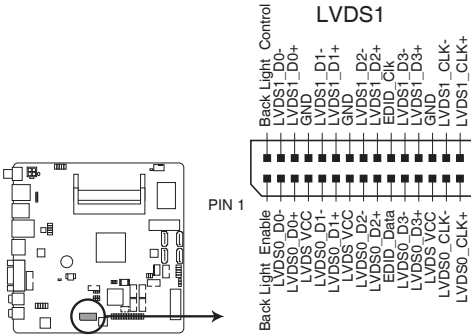

EMB-BT4 LVDS connector

8. Backlight inverter power connector (5-pin INV1)

Connect the backlight inverter power cable to this connector.

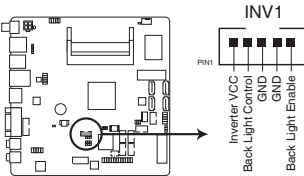

EMB-BT4 Inverter connector



IMPORTANT: The backlight inverter power connector supports 1A current to the maximum.

9. Minicard connector

Use this connector to connect a Minicard reader.

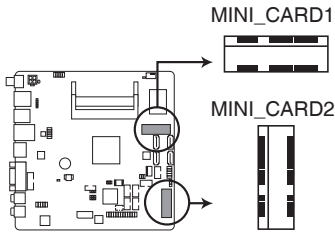

EMB-BT4 MINICARD connectors



NOTE: The Mini-card module is purchased separately.

10. USB 2.0 connector (10-1 pin USBHUB_34, USBHUB_56 and USBHUB_7)

These USB connectors comply with USB 2.0 specifications.

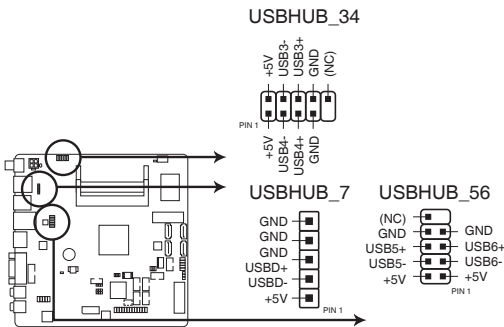

EMB-BT4 USB2.0 connectors



Never connect a 1394 cable to the USB connector. Doing so will damage the motherboard.



NOTES:

- The USB module cable is purchased separately.
- Before you install Windows 7 operating system, go to BIOS Setup > Advanced > XHCI mode [Disabled], USB 2.0 (EHCI) support [Enabled], and set them back when you finish installing the operating system.

11. BIOS programmable connector (8-pin SPI)

Use this connector to flash the BIOS ROM.

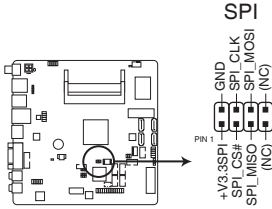

EMB-BT4 BIOS Programmable Connector

12. LPT connector (26-1 pin LPT1)

The LPT (Line Printing Terminal) connector supports devices such as a printer. LPT is standardized as IEEE 1284, which is the parallel port interface on IBM PC-compatible computers.

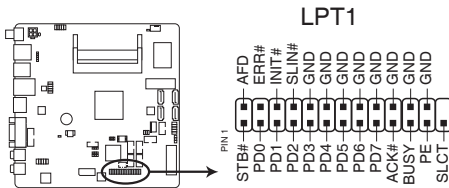

EMB-BT4 Parallel Port Connector

13. Serial port connectors (10-1 pin COM1, COM3-COM6)

These connectors are for serial (COM) ports. Connect the serial port module cable to this connector, then install the module to a slot opening at the back of the system chassis.

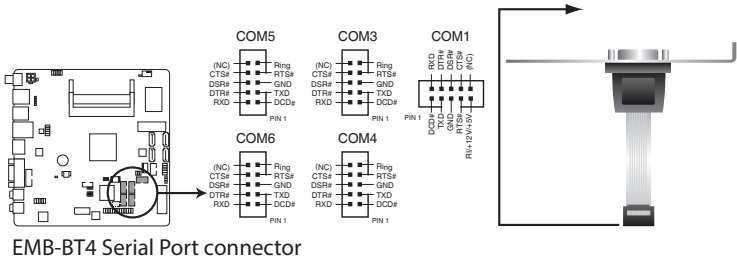

NOTE:

- The COM module is purchased separately.
- COM1 also supports RS-232 / RS-422 / RS-485. See the table below and section 3.3.2 **Super IO Configuration** for details.

Pin	Signal	Pin	Signal
1	DCD (422TXD-/485DATA-)	2	RXD (422RXD+)
3	TXD (422TXD+/485DATA+)	4	DTR (422RXD-)
5	GND	6	DSR
7	RTS	8	CTS
9	RI/+12V/+5V	10	N.C.

14. Digital I/O connector (10-pin DIO1)

This connector includes 8 I/O lines (In/Out programmable). All of the Digital I/O lines are programmable and each I/O pin can be individually programmed to support various devices.

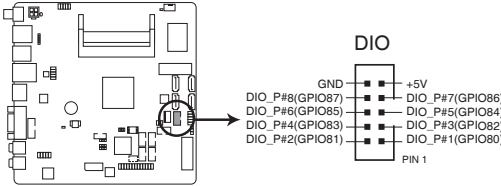

EMB-BT4 DIO connector

15. PS/2 keyboard/mouse connector (6-pin KBMS1)

This connector is for an IBM PS/2-compatible keyboard or mouse.

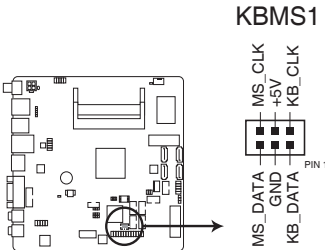

**EMB-BT4 Series PS/2
keyboard/mouse connector**

16. Serial ATA 3.0Gb/s connectors (7-pin SATA3G_1, SATA3G_2)

These connectors connect to Serial ATA 3.0 Gb/s hard disk drives and optical drives via Serial ATA 3.0 Gb/s signal cables.

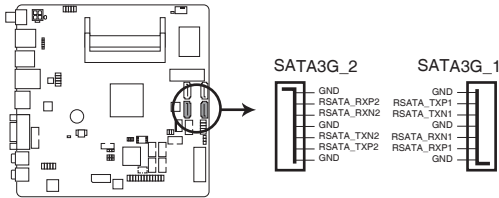

EMB-BT4 SATA 3.0Gb/s connectors



NOTE:

- You must install Windows® XP Service Pack 3 or later version before using Serial ATA hard disk drives.
- When using hot-plug and NCQ, set the SATA Mode Selection item in the BIOS to [AHCI]. See section 3.3.7 IDE Configuration for details

18. VGA connector (16-pin VGA)

This 16-pin connector is for a VGA monitor or other VGA-compatible devices.

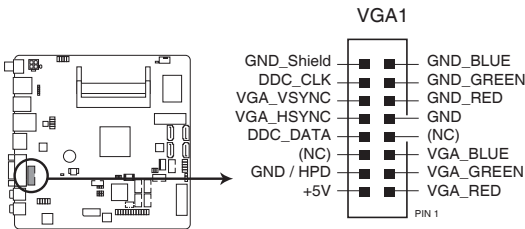

EMB-BT4 VGA Port connector

Chapter 3

BIOS setup

3.1 BIOS setup

Use the BIOS Setup to update the BIOS or configure settings. The BIOS screens include navigation keys and help to guide you in using the BIOS Setup program.

Entering BIOS Setup at startup

To enter BIOS Setup at startup:

Press <Delete> during the Power-On Self Test (POST). If you do not press <Delete>, POST continues with its routine.

Entering BIOS Setup after POST

To enter BIOS Setup after POST:

- Press <Ctrl>+<Alt>+ simultaneously.
- Press the reset button on the system chassis.
- Press the power button to turn the system off then back on. Do this option only if you failed to enter BIOS Setup using the first two options.



NOTE: Using the power button, reset button, or the <Ctrl>+<Alt>+ keys to reboot a running operating system can cause damage to your data or system. Always shut down the system properly from the operating system.



IMPORTANT:

- The default BIOS settings for this motherboard apply to most working conditions and ensures optimal performance. If the system becomes unstable after changing any BIOS settings, load the default settings to regain system stability. Select the option **Restore Defaults** under the Save & Exit Menu. See section 3.7 Exit Menu.
 - The BIOS setup screens shown in this section are for reference purposes only, and may not exactly match what you see on your screen.
-

3.1.1 Menu bar

The menu bar on top of the screen has the following main items:

Main	For changing the basic system configuration.
Advanced	For changing the advanced system settings.
Chipset	For viewing and changing chipset settings.
Security	For setting up BIOS security settings.
Boot	For changing the system boot configuration.
Save & Exit	For selecting the exit options and loading default settings.

To select an item on the menu bar, press the right or left arrow key on the keyboard until the desired item is highlighted.

3.2 Main menu

The Main menu provides you an overview of the basic system information, and allows you to set the system date, time, language, and security settings.

3.2.1 System Date [Day MM/DD/YYYY]

Allows you to set the system date.

3.2.2 System Time [HH:MM:SS]

Allows you to set the system time.

3.3 Advanced menu

The Advanced menu items allow you to change the settings for the CPU and other system devices.



Be cautious when changing the settings of the Advanced menu items. Incorrect field values can cause the system to malfunction.

3.3.1 Power Management

Power Mode [ATX Type]

Select power supply mode. Configuration options: [ATX Type] [AT Typ]

ERP Function [Disabled]

Enables or disables ERP power saving function. Configuration options: [Enabled] [Disabled]

Restore AC Power Loss [Last State]

- | | |
|--------------|--|
| [Power Off] | The system goes into off state after an AC power loss. |
| [Power On] | The system goes into on state after an AC power loss. |
| [Last State] | The system goes into either off or on state, whatever the system state was before the AC power loss. |

ACPI Settings

ACPI Sleep State [S3 (Suspend to RAM)]

Select the highest ACPI sleep state the system will enter when the Suspend button is pressed. Configuration options: [Suspend Disabled] [S3 (Suspend to RAM)]

Wake Configuration

Resume on PCIE/XHCI/RING [Disabled]

Enables or disables resume from PCIE/XHCI/RING signal: [Disabled] [Enabled]

Wake system from S5 [Disabled]

- | | |
|----------------|--|
| [Disabled] | Disables system wake up from S5. |
| [Fixed Time] | The system will wake up at the specified hr::min::sec. Configuration options: [Disabled] [Enabled] . |
| [Dynamic Time] | The system will wake up at the current time plus a specified number of minutes. |



The following items appear when **Fixed Time** is enabled.

Wake up day/hour/minute/second [0]

Specify the values for day/hour/minute/second.



The following items appear when **Wake System with Dynamic Time** is enabled.

Wake up minute increase [1]

Specify the number of minutes added to the current time before waking up system.

3.3.2 CPU Configuration

The items in this menu show CPU-related information.

Socket 0 CPU Information

Displays additional CPU information.

Intel Virtualization Technology [Enabled]

[Enabled] Allows a hardware platform to run multiple operating systems separately and simultaneously, enabling one system to virtually function as several systems.

[Disabled] Disables this function.

3.3.3 Super IO Configuration

Serial Port1~6 Configuration

The sub-items in this menu allow you to set the serial port configuration.

Serial Port [Enabled]

Allows you to enable or disable the serial port (COM). Configuration options: [Enabled] [Disabled]

Device Mode [RS232]

Allows you to select COM RS Mode. Configuration options: [RS232] [RS422] [RS485]

Change Settings [Auto]

Allows you to select the Serial Port base address. Configuration options: [Auto] [IO=3F8h; IRQ=4] [IO=3F8h; IRQ=3,4;] [IO=2F8h; IRQ=3,4;] [IO=3E8h; IRQ=3,4;] [IO=2E8h; IRQ=3,4;]

Parallel Port Configuration

The sub-items in this menu allow you to set the parallel port configuration.

Parallel Port [Enabled]

Allows you to enable or disable the parallel port (LPT/LPTE). Configuration options: [Enabled] [Disabled]

Change Settings [Auto]

Allows you to select an optimal setting for Super I/O devices. Configuration options: [Auto] [IO=378h; IRQ=7;] [IO=378h; IRQ=7;] [IO=278h; IRQ=7;] [IO=3BCh; IRQ=7;] [IO=378h;] [IO=278h;] [IO=3BCh;]

Device Mode [STD Printer Mode]

Allows you to select the Printer Port mode. Configuration options: [STD Printer Mode] [SPP Mode] [EPP-1.9 and SPP Mode] [EPP-1.7 and SPP Mode] [ECP Mode] [ECP and EPP 1.9 Mode] [ECP and EPP 1.7 Mode]

3.3.4 Dynamic Digital IO

The items in this menu allow you to modify Digital IO settings.

GPIO0~3 Direction [Input]

Set GPIO data flow as Input or Output. Configuration options: [Input] [Output]

GPIO4~7 Direction [Output]

Set GPIO data flow as Input or Output. Configuration options: [Input] [Output]

Output Level [High]

Configuration options: [High] [Low]

3.3.5 Trusting Computing

The items in this menu allow you to modify trusted computing settings.

Security Device Support [Disabled]

Enables or disables BIOS support for security device, which will not be displayed in the operating system. TCG EFI protocol and INT1A interface will not be available. Configuration options: [Disabled] [Enabled]

3.3.6 USB Configuration



The USB Devices item lists auto-detected values. If no USB device is detected, the item shows None.

Legacy USB Support [Enabled]

[Enabled] Enables the support for USB devices on legacy operating systems (OS).

[Disabled] USB devices are only available when running BIOS Setup.

[Auto] Allows the system to detect the presence of USB devices at startup. If detected, the USB controller legacy mode is enabled. If no USB device is detected, the legacy USB support is disabled.

3.3.7 Hardware Monitor

CHASSIS FAN

The sub-items in this menu configure available fans on the system.

Chassis Smart Fan control [Auto by Duty-Cycle]

Select Smart Fan control mode. Configuration options: [Auto by RPM] [Auto by Duty-Cycle] [Manual by RPM] [Manual by Duty-Cycle]

Target Temp. Sensor [System temperature2]

Configuration options: [system temperature1] [system temperature2]

Temperature Bound 1~4

Input temperature setting. Input value range: [0~127]

Segment 1~5 Speed (PWM)

Input fan speed in PWM duty-cycle. Input value range: [0~100]



The following item replaces Segment 1~5 Speed (PWM) when **Chassis Smart Fan Control** is set to [Auto by RPM].

Segment 1~5 Speed (%)

Input fan speed percentage. Input value range: [0~100]

Full Speed Count [3000]

Input fan full speed count value. Input value range: [500~15000]



Full Speed Count is only available when **Chassis Smart Fan Control** is set to [Auto by RPM].

Manual Setting [3000]

Specify fixed RPM. Input value range: [500~15000]



Manual Setting is the only item available when **Chassis Smart Fan Control** is set to [Manual by RPM].

Manual Setting [100]

Specify fixed Duty-Cycle. Input value range: [0~100]



Manual Setting is the only item available when **Chassis Smart Fan Control** is set to **[Manual by Duty-Cycle]**.

3.3.8 IDE Configuration

Serial-ATA (SATA) [Enabled]

Allows you to enable or disable Serial-ATA. Configuration options: [Enabled]
[Disabled]

SATA Mode [AHCI Mode]

Allows you to set the SATA configuration.

[AHCI Mode] Set to [AHCI] when you want the SATA hard disk drives to use AHCI (Advanced Host Controller Interface). AHCI allows the onboard storage driver to enable advanced Serial ATA features that increases storage performance on random workloads by allowing the drive to internally optimize the order of commands.

[IDE Mode] Set to [IDE] when you want to use the Serial ATA hard disk drives as Parallel ATA physical storage devices.

SATA Speed Support [Gen2]

Allows you to select the SATA speed. Configuration options: [Gen1] [Gen2]

Serial-ATA Port 0-1 [Enabled]

Allows you to enable or disable Serial-ATA Ports. Configuration options: [Enabled]
[Disabled]

SATA Port 0/1 HotPlug [Disabled]

Configuration options: [Enabled] [Disabled]

ASMedia Operation

SATA Mode [AHCI Mode]

Allows you to set the SATA mode.

3.4 Chipset menu

The Chipset menu items allow you to change configuration options for the North Bridge and South Bridge.

3.4.1 North Bridge Configuration

Max TOLUD [2GB]

Allows you to select more useable memory on x86 OS. If you use external graphic card, set this option to 2GB. Configuration options: [2 GB] [2.25 GB] [2.5GB] [2.75GB] [3 GB]

Primary IGFX Boot Display [VBIOS Default]

Select the Vedio Device which will be activated during POST. Your selection does not take effect if you have installed an external graphics device. Secondary boot display selection will appear based on your selection. VGA modes can be supported only on the primary display. Configuration options: [VBIOS Default] [CRT] [HDMI] [LVDS]

LVDS [Enabled]

Allows you to enable or disable LVDS (CH7511). Configuration options: [Disabled] [Enabled]

LVDS Panel Type [1024x768 18bit, 60Hz]

Allows you to configure LVDs panel used by Internal Graphics Device. Configuration options: [640x480, 18bit, 60Hz] [800x480, 18bit, 60Hz] [800x600, 18bit, 60Hz] [1024x600, 18bit, 60Hz] [1024x768, 18bit, 60Hz] [1024x768, 24bit, 60Hz] [1280x768, 24bit, 60Hz] [1280x1024, 48bit, 60Hz] [1366x768, 24bit, 60Hz] [1440x900, 48bit, 60Hz] [1600x1200, 48bit, 60Hz] [1920x1080, 48bit, 60Hz] [1920x1200, 48bit, 60Hz]

Backlight Level [70%]

Allows you to select the backlight brightness of LVDS. Configuration options: [0%] ~ [80%] [90%] [100%]

Backlight Invert [Normal]

Allows you to select the backlight control type of LVDS. Configuration options: [Normal] [Invert]

3.4.2 South Bridge Configuration

XHCI Mode [Enabled]

Allows you to enable or disable the mode of xHCI controller operation. Configuration options: [Disabled] [Enabled]

USB 2.0 (EHCI) Support [Disabled]

This item becomes configurable when you set the previous item to [Disabled] and allows you to enable or disable USB2.0 (EHCI) support. Configuration options: [Disabled] [Enabled]

PCI Express Port 0~3 [Enabled]

Configuration options: [Disabled] [Enabled]

Speed [Gen2]

Configuration options: [Auto] [Gen 1] [Gen 2]

3.5 Security menu

The Security menu items allow you to change the system security settings.

3.5.1 Administrator Password

If you have set an administrator password, we recommend that you enter the administrator password for accessing the system. Otherwise, you might be able to see or change only selected fields in the BIOS setup program.

To set an administrator password:

1. Select the Administrator Password item and press <Enter>.
2. From the Create New Password box, key in a password, then press <Enter>.
3. Confirm the password when prompted.

To change an administrator password:

1. Select the Administrator Password item and press <Enter>.
2. From the Enter Current Password box, key in the current password, then press <Enter>.
3. From the Create New Password box, key in a new password, then press <Enter>.
4. Confirm the password when prompted.

To clear the administrator password, follow the same steps as in changing an administrator password, but press <Enter> when prompted to create/confirm the password. After you clear the password, the Administrator Password item on top of the screen shows Not Installed.

3.5.2 User Password

If you have set a user password, you must enter the user password for accessing the system. The User Password item on top of the screen shows the default Not Installed. After you set a password, this item shows Installed.

To set a user password:

1. Select the User Password item and press <Enter>.
2. From the Create New Password box, key in a password, then press <Enter>.
3. Confirm the password when prompted.

To change a user password:

1. Select the User Password item and press <Enter>.
2. From the Enter Current Password box, key in the current password, then press <Enter>.
3. From the Create New Password box, key in a new password, then press <Enter>.
4. Confirm the password when prompted.

To clear the user password, follow the same steps as in changing a user password, but press <Enter> when prompted to create/confirm the password. After you clear the password, the **User Password** item on top of the screen shows **Not Installed**.

3.6 Boot menu

The Boot menu items allow you to change the system boot options.

Boot Configuration

Quiet Boot [Enabled]

This item enables/disables Quiet Boot. Configuration options: [Disabled] [Enabled]

LAN Boot [Disabled]

This item enables/disables LAN PXE OpROM. Configuration options: [Disabled] [Enabled]

Boot Option Priorities

These items specify the boot device priority sequence from the available devices. The number of device items that appears on the screen depends on the number of devices installed in the system.



-
- To select the boot device during system startup, press <F7> during POST.
 - To access Windows OS in Safe Mode, do any of the following:
 - Press <F5> during POST.
 - Press <F8> after POST.
-

Boot Override

These items displays the available devices. The number of device items that appears on the screen depends on the number of devices installed in the system. Click an item to start booting from the selected device.

3.7 Save & Exit menu

Save Changes and Reset

Once you are finished making your selections, choose this option from the Save & Exit menu to ensure the values you selected are saved. When you select this option, a confirmation window appears. Select Yes to save changes and reset.

Discard Changes and Reset

This option allows you to exit the Setup program without saving your changes. When you select this option or if you press <Esc>, a confirmation window appears. Select Yes to discard changes and exit.

Save Options

Save or discard changes to current configuration.

Restore Defaults

Save or restore User Defaults to all setup options.

Save as User Defaults

This item saves current configuration as User Default.

Restore User Defaults

This option restores User Defaults to all setup options.

Appendix

Notices

Federal Communications Commission Statement

This device complies with Part 15 of the FCC Rules. Operation is subject to the following two conditions:

- This device may not cause harmful interference.
- This device must accept any interference received including interference that may cause undesired operation.

This equipment has been tested and found to comply with the limits for a Class A digital device, pursuant to Part 15 of the FCC Rules. These limits are designed to provide reasonable protection against harmful interference in a residential installation. This equipment generates, uses and can radiate radio frequency energy and, if not installed and used in accordance with manufacturer's instructions, may cause harmful interference to radio communications. However, there is no guarantee that interference will not occur in a particular installation. If this equipment does cause harmful interference to radio or television reception, which can be determined by turning the equipment off and on, the user is encouraged to try to correct the interference by one or more of the following measures:

- Reorient or relocate the receiving antenna.
- Increase the separation between the equipment and receiver.
- Connect the equipment to an outlet on a circuit different from that to which the receiver is connected.
- Consult the dealer or an experienced radio/TV technician for help.



WARNING! The use of shielded cables for connection of the monitor to the graphics card is required to assure compliance with FCC regulations. Changes or modifications to this unit not expressly approved by the party responsible for compliance could void the user's authority to operate this equipment.



DO NOT throw the motherboard in municipal waste. This product has been designed to enable proper reuse of parts and recycling. This symbol of the crossed out wheeled bin indicates that the product (electrical and electronic equipment) should not be placed in municipal waste. Check local regulations for disposal of electronic products.



DO NOT throw the mercury-containing button cell battery in municipal waste. This symbol of the crossed out wheeled bin indicates that the battery should not be placed in municipal waste.



電子信息產品污染控制標示：圖中之數字為產品之環保使用期限。僅指電子信息產品中含有的有毒有害物質或元素不致發生外洩或突變從而對環境造成污染或對人身、財產造成嚴重損害的期限。

有毒有害物質或元素的名稱及含量說明標示：

部件名稱	有害物質或元素					
	鉛 (Pb)	汞 (Hg)	鎘 (Cd)	六 價 鉻 (Cr(VI))	多 溴 聯 苯 (PBB)	多 溴 二 苯 醚 (PBDE)
印刷電路板及其電子組件	×	○	○	○	○	○
外部信號連接頭及線材	×	○	○	○	○	○

○：表示該有毒有害物質在該部件所有均質材料中的含量均在 SJ/T 11363-2006 標準規定的限量要求以下。

×

×：表示該有毒有害物質至少在該部件的某一均質材料中的含量超出 SJ/T 11363-2006 標準規定的限量要求，然該部件仍符合歐盟指令 2002/95/EC 的規範。

備註：此產品所標示之環保使用期限，係指在一般正常使用狀況下。