

de next-V2K8

de next Board

User's Manual 2nd Ed

Copyright Notice

This document is copyrighted, 2023. All rights are reserved. The original manufacturer reserves the right to make improvements to the products described in this manual at any time without notice.

No part of this manual may be reproduced, copied, translated, or transmitted in any form or by any means without the prior written permission of the original manufacturer. Information provided in this manual is intended to be accurate and reliable. However, the original manufacturer assumes no responsibility for its use, or for any infringements upon the rights of third parties that may result from its use.

The material in this document is for product information only and is subject to change without notice. While reasonable efforts have been made in the preparation of this document to assure its accuracy, AAEMON assumes no liabilities resulting from errors or omissions in this document, or from the use of the information contained herein.

AAEMON reserves the right to make changes in the product design without notice to its users.

Acknowledgement

All other products' name or trademarks are properties of their respective owners.

- Microsoft Windows® is a registered trademark of Microsoft Corp.
- AMD Ryzen™ and Radeon™ are trademarks of Advanced Micro Devices, Inc.
- Intel® is a registered trademark of Intel Corporation.
- ITE is a trademark of Integrated Technology Express, Inc.
- IBM, PC/AT, PS/2, and VGA are trademarks of International Business Machines Corporation.
- Linux® is the registered trademark of Linus Torvalds in the U.S. and other countries.

All other product names or trademarks are properties of their respective owners.

Packing List

Before setting up your product, please make sure the following items have been shipped:

Item	Quantity
de next-V2K8	1
Copper Stud.M2.5	4

If any of these items are missing or damaged, please contact your distributor or sales representative immediately.

About this Document

This User's Manual contains all the essential information, such as detailed descriptions and explanations on the product's hardware and software features (if any), its specifications, dimensions, jumper/connector settings/definitions, and driver installation instructions (if any), to facilitate users in setting up their product.

Users may refer to the product page at AAEON.com for the latest version of this document.

Safety Precautions

Please read the following safety instructions carefully. It is advised that you keep this manual for future references

1. All cautions and warnings on the device should be noted.
2. Make sure the power source matches the power rating of the device.
3. Position the power cord so that people cannot step on it. Do not place anything over the power cord.
4. Always completely disconnect the power before working on the system's hardware.
5. No connections should be made when the system is powered as a sudden rush of power may damage sensitive electronic components.
6. If the device is not to be used for a long time, disconnect it from the power supply to avoid damage by transient over-voltage.
7. Always disconnect this device from any AC supply before cleaning.
8. While cleaning, use a damp cloth instead of liquid or spray detergents.
9. Make sure the device is installed near a power outlet and is easily accessible.
10. Keep this device away from humidity.
11. Place the device on a solid surface during installation to prevent falls
12. Do not cover the openings on the device to ensure optimal heat dissipation.
13. Watch out for high temperatures when the system is running.
14. Do not touch the heat sink or heat spreader when the system is running
15. Never pour any liquid into the openings. This could cause fire or electric shock.
16. As most electronic components are sensitive to static electrical charge, be sure to ground yourself to prevent static charge when installing the internal components. Use a grounding wrist strap and contain all electronic components in any static-shielded containers.

17. If any of the following situations arises, please the contact our service personnel:
 - i. Damaged power cord or plug
 - ii. Liquid intrusion to the device
 - iii. Exposure to moisture
 - iv. Device is not working as expected or in a manner as described in this manual
 - v. The device is dropped or damaged
 - vi. Any obvious signs of damage displayed on the device
18. **DO NOT LEAVE THIS DEVICE IN AN UNCONTROLLED ENVIRONMENT WITH TEMPERATURES BEYOND THE DEVICE'S PERMITTED STORAGE TEMPERATURES (SEE CHAPTER 1) TO PREVENT DAMAGE.**

Warning!



This device complies with Part 15 FCC Rules. Operation is subject to the following two conditions: (1) this device may not cause harmful interference, and (2) this device must accept any interference received including interference that may cause undesired operation.

Caution:

There is a danger of explosion if the battery is incorrectly replaced. Replace only with the same or equivalent type recommended by the manufacturer. Dispose of used batteries according to the manufacturer's instructions and your local government's recycling or disposal directives.

Attention:

Il y a un risque d'explosion si la batterie est remplacée de façon incorrecte. Ne la remplacer qu'avec le même modèle ou équivalent recommandé par le constructeur. Recycler les batteries usées en accord avec les instructions du fabricant et les directives gouvernementales de recyclage.

China RoHS Requirements (CN)

产品中有毒有害物质或元素名称及含量

AAEON Main Board/ Daughter Board/ Backplane

部件名称	有毒有害物质或元素					
	铅 (Pb)	汞 (Hg)	镉 (Cd)	六价铬 (Cr(VI))	多溴联苯 (PBB)	多溴二苯醚 (PBDE)
印刷电路板 及其电子组件	x	x	○	○	○	○
外部信号 连接器及线材	x	X	○	○	○	○
<p>O: 表示该有毒有害物质在该部件所有均质材料中的含量均在 SJ/T 11363-2006 标准规定的限量要求以下。</p> <p>X: 表示该有毒有害物质至少在该部件的某一均质材料中的含量超出 SJ/T 11363-2006 标准规定的限量要求。</p> <p>备注: 此产品所标示之环保使用期限, 系指在一般正常使用状况下。</p>						

China RoHS Requirement (EN)

Poisonous or Hazardous Substances or Elements in Products

AAEON Main Board/ Daughter Board/ Backplane

Component	Poisonous or Hazardous Substances or Elements					
	Lead (Pb)	Mercury (Hg)	Cadmium (Cd)	Hexavalent Chromium (Cr(VI))	Polybrominated Biphenyls (PBB)	Polybrominated Diphenyl Ethers (PBDE)
PCB & Other Components	x	x	○	○	○	○
Wires & Connectors for External Connections	x	x	○	○	○	○
<p>O: The quantity of poisonous or hazardous substances or elements found in each of the component's parts is below the SJ/T 11363-2006-stipulated requirement.</p> <p>X: The quantity of poisonous or hazardous substances or elements found in at least one of the component's parts is beyond the SJ/T 11363-2006-stipulated requirement.</p> <p>Note: The Environment Friendly Use Period as labeled on this product is applicable under normal usage only</p>						

Table of Contents

Chapter 1 - Product Specifications	1
1.1 Specifications	2
1.2 Block Diagram	5
Chapter 2 – Hardware Information	6
2.1 Dimensions	7
2.2 Jumpers and Connectors.....	9
2.3 List of Connectors.....	10
2.3.1 COM, USB 2.0, DIO (JCOM1)	11
2.3.2 DC In (JDCIN2).....	13
2.3.3 eDP (JEDP1).....	13
2.3.4 I2C, SMBus (JESPI1).....	15
2.3.5 FAN (JFAN1)	16
2.3.6 HDMI (JHDMI1)	16
2.3.7 LAN (JLAN1)	17
2.3.8 M.2 2280 M-Key (JM2M1)	19
2.3.9 PCIe (JPCIE_FPC1).....	22
2.3.10 RTC Battery (JRTC1).....	24
2.3.11 SATA (JSATA1)	24
2.3.12 SATA Power (JSATAP1)	25
2.3.13 USB 3.2 (JUSB1).....	25
Chapter 3 - AMI BIOS Setup	27
3.1 System Test and Initialization	28
3.2 AMI BIOS Setup	29
3.3 Setup Submenu: Main.....	30
3.4 Setup Submenu: Advanced.....	31
3.4.1 Graphics Configuration.....	32

3.4.2	CPU Configuration.....	33
3.4.2.1	CPU Common Options.....	34
3.4.3	Memory Configuration.....	35
3.4.4	Hardware Monitor.....	36
3.4.4.1	Smart Fan Mode Configuration.....	37
3.4.5	Power Management.....	38
3.4.5.1	AC Power Loss Options.....	39
3.4.6	AAEON BIOS Robot.....	40
3.4.6.1	Device Detecting Configuration.....	41
3.5	Setup Submenu: System I/O.....	43
3.5.1	PCI Express Configuration.....	44
3.5.2	Storage Configuration.....	45
3.5.2.1	NVMe Configuration.....	46
3.5.3	Digital IO Port Configuration.....	47
3.5.4	Legacy Logical Devices Configuration.....	48
3.5.4.1	Serial Port x Configuration.....	49
3.5.5	Serial Port Console Redirection.....	50
3.6	Setup Submenu: Security.....	51
3.6.1	Trusted Computing.....	52
3.6.2	Secure Boot.....	54
3.6.2.1	Key Management.....	55
3.7	Setup Submenu: Boot.....	56
3.8	Setup Submenu: Save & Exit.....	57
Chapter 4 – Driver Installation.....		58
4.1	Driver Download/Installation.....	59
Appendix A - I/O Information.....		61
A.1	I/O Address Map.....	62
A.2	Memory Address Map.....	63

A.3	IRQ Mapping Chart.....	64
Appendix B - Mating Connector & Cable List.....		66
B.1	List of Mating Connectors and Cables.....	67
Appendix C –Peripheral Device Installation.....		68
C.1	PER-R41P (PER-R41P:PCle[x4] Adapter Kit) Installation	69

Chapter 1

Product Specifications

1.1 Specifications

System

Form Factor	86mm x 55mm, Single board computer
CPU	AMD Ryzen™ Embedded V2718 with Radeon™ Graphics AMD Ryzen™ Embedded V2516 with Radeon™ Graphics
CPU TDP	10W, TDP up to 25W: V2718/V2516
Chipset	Integrated with AMD Ryzen™ Embedded SoC
Memory Type	Onboard LPDDR4x 3200MHz, up to 16GB
BIOS	UEFI
Wake on LAN	Yes
Watchdog Timer	255 Levels
Security	fTPM
RTC Battery	Lithium Battery 3V/240mAh
Dimension	3.38" x 2.17" (86mm x 55mm)

Power

Power Requirement	+12V DC-in
Power Supply Type	AT/ATX (Default: AT Mode)
Connector	DC Jack (Optional: 2 Pin Phoenix Connector)
Power Consumption	AMD Ryzen™ V2718 Processor, LPDDR4 3200MHz 16GB, 3.92A@12V, 47.04W during full loading test (Peak) AMD Ryzen™ V2718 Processor, LPDDR4 3200MHz 16GB, 3.07A@12V, 36.84W during full loading test (Steady)

Display

Controller	AMD Radeon™ Graphics
LVDS/EDP	eDP only, up to 3840 X 2160 Resolution
Display Interface	eDP x 1 HDMI 1.4b x 1
Multiple Display	Up to 2 Simultaneous Displays

Audio

Codec	—
Audio Interface	—
Speaker	—

External I/O

Ethernet	Realtek RTL8111H, 10/100/1000Base, RJ-45 x 1 Intel® i225LM, 10/100/2500Base, RJ-45 x 1
USB	USB 3.2 Gen 2 x 2 (Type-A)
Serial Port	—
Video	HDMI 1.4b x 1

Internal I/O

USB	USB 2.0 x 4 (Pin Header)
Serial Port	COM Port x 2 (RS-232/422/485 Pin Header)
Video	eDP x 1
SATA	SATA III x 1 +5V SATA Power Connector x 1
Audio	—
DIO/GPIO	8-Bit (Pin Header)

Internal I/O

SMBus/I2C	Optional
Touch	—
FAN	Smart Fan x 1
SIM	—
Front Panel	HDD LED, PWR LED, Power Button, Buzzer, Reset

Expansion

Mini PCIe/MSATA	—
M.2	M.2 2280 M-Key x 1 (PCIe [x2])
Others	—

Environment & Certification

Operating Temperature	32°F ~ 140°F (0°C ~ 60°C)
Storage Temperature	-40°F ~ 176°F (-40°C ~ 80°C)
Operating Humidity	0% ~ 90% relative humidity, non-condensing
MTBF (Hours)	609,263
EMC	CE/FCC Class A

1.2 Block Diagram

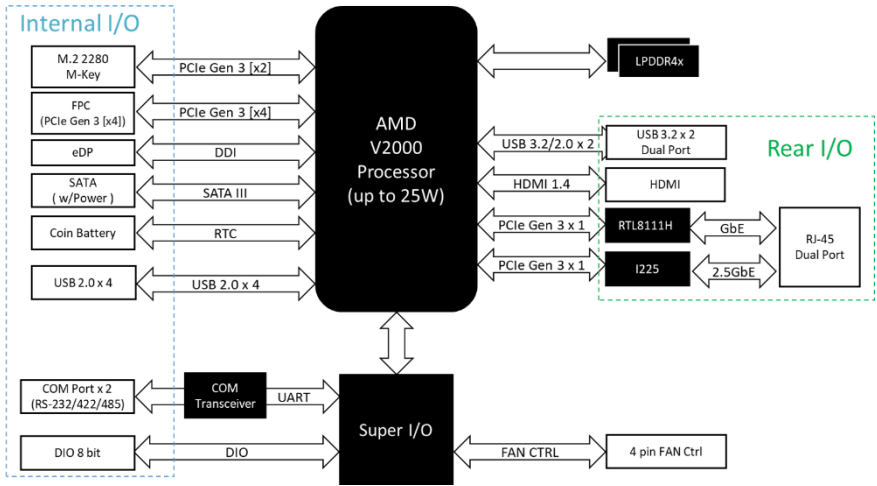

Chapter 2

Hardware Information

2.1 Dimensions

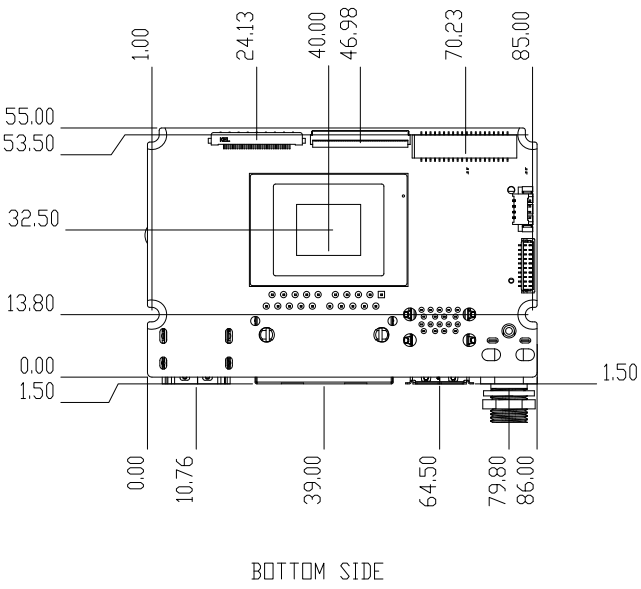
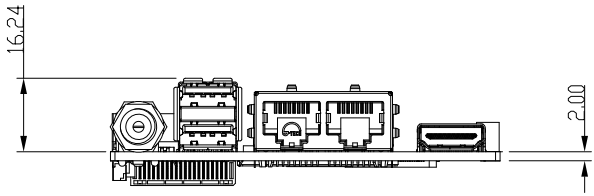
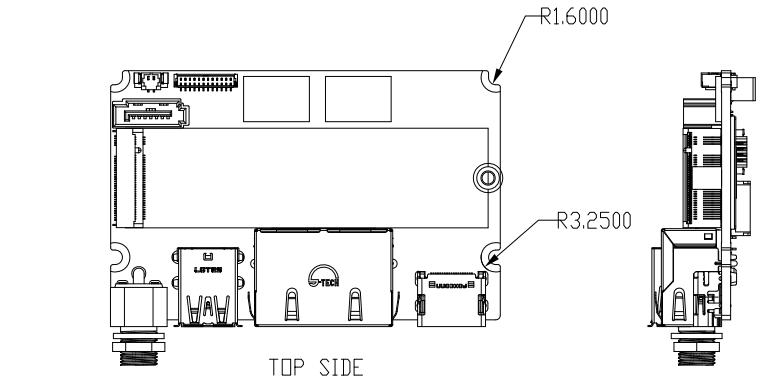

With CPU Cooler:

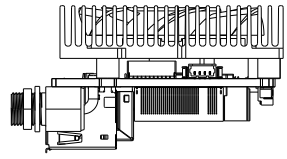
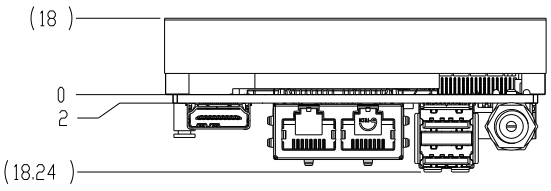
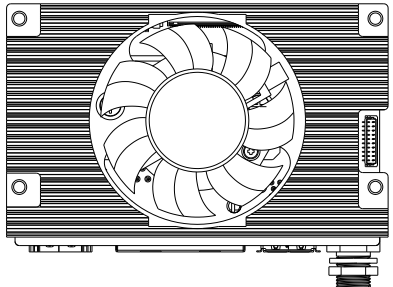

2.2 Jumpers and Connectors

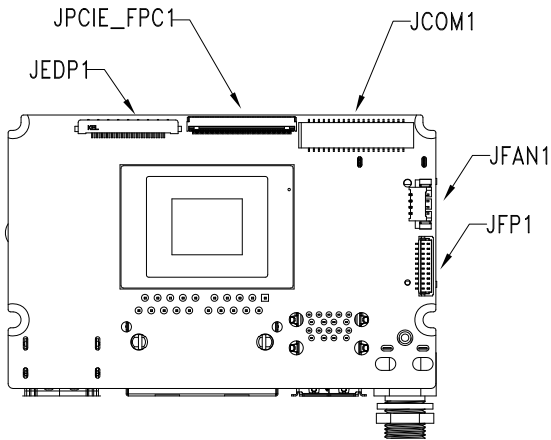
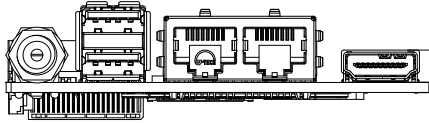
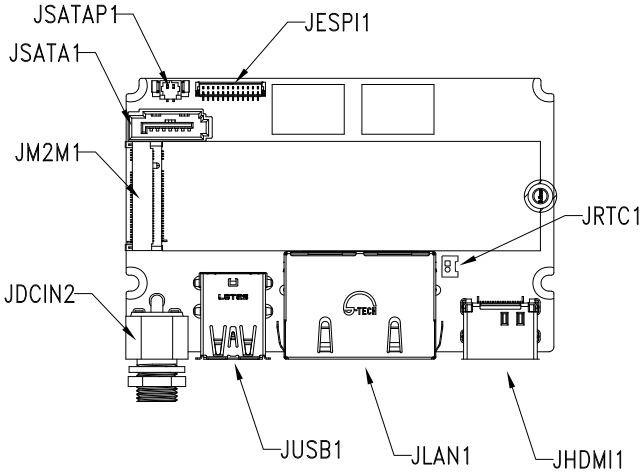

2.3 List of Connectors

Please refer to the table below for all of the board's connectors that you can configure for your application

Label	Function
JCOM1	COM, USB 2.0, DIO
JDCIN2	DC In
JEDP1	eDP
JESPI1	I2C, SMBus
JFAN1	FAN
JFP1	Front Panel
JHDMI1	HDMI
JLAN1	LAN
JM2M1	M.2 2280 M-Key
JPCIE_FPC1	PCIe
JRTC1	RTC Battery
JSATA1	SATA
JSATAP1	SATA Power
JUSB1	USB 3.2 Gen 2

2.3.1 COM, USB 2.0, DIO (JCOM1)

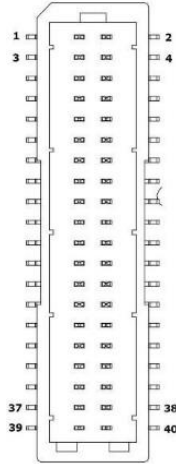

Pin	Pin Name	Signal Type	Signal Level
1	DIO_7	I/O	5V
2	DIO_6	I/O	5V
3	DIO_5	I/O	5V
4	DIO_4	I/O	5V
5	DIO_3	I/O	5V
6	DIO_2	I/O	5V
7	DIO_1	I/O	5V
8	DIO_0	I/O	5V
9	GND	GND	-
10	GND	GND	-
11	USB7_DN_CM	I/O	-
12	USB6_DN_CM	I/O	-
13	USB7_DP_CM	I/O	-
14	USB6_DP_CM	I/O	-
15	+V5A_USB2367	I/O	-

Pin	Pin Name	Signal Type	Signal Level
16	+V5A_USB2367	I/O	-
17	USB3_DN_CM	I/O	-
18	USB2_DN_CM	I/O	-
19	USB3_DP_CM	I/O	-
20	USB2_DP_CM	I/O	-
21	GND	GND	-
22	GND	GND	-
23	RI_2_CON	I/O	-
24	RI_1_CON	I/O	-
25	CTS_2_CON	I/O	-
26	CTS_1_CON	I/O	-
27	RTS_2_CON	I/O	-
28	RTS_1_CON	I/O	-
29	DSR_2_CON	I/O	-
30	DSR_1_CON	I/O	-
31	DTR_2_CON	I/O	-
32	DTR_1_CON	I/O	-
33	TX_2_CON	I/O	-
34	TX_1_CON	I/O	-
35	RX_2_CON	I/O	-
36	RX_1_CON	I/O	-
37	DCD_2_CON	I/O	-
38	DCD_1_CON	I/O	-
39	+V5S	PWR	-
40	GND	GND	-

2.3.2 DC In (JDCIN2)

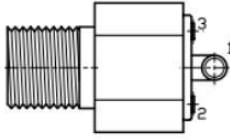

Pin	Pin Name	Signal Type
1	+VIN	PWR
2	GND	GND

2.3.3 eDP (JEDP1)

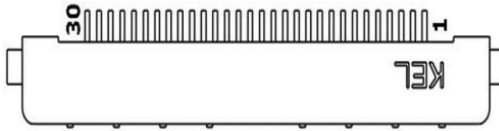

Pin	Pin Name	Signal Type
1	+VDD_EDP	PWR
2	+VDD_EDP	PWR
3	GND	GND
4	GND	GND
5	DDIO_LANE2_DN_CH	I/O
6	DDIO_LANE2_DP_CH	I/O
7	GND	GND
8	DDIO_LANE1_DN_CH	I/O
9	DDIO_LANE1_DP_CH	I/O
10	GND	GND
11	DDIO_LANE0_DN_CH	I/O

Pin	Pin Name	Signal Type
12	DDIO_LANE0_DP_CH	I/O
13	GND	GND
14	DDIO_LANE3_DN_CH	I/O
15	DDIO_LANE3_DP_CH	I/O
16	GND	GND
17	DDIO_AUX_DN_CH	I/O
18	DDIO_AUX_DP_CH	I/O
19	GND	GND
20	DDIO_BKLTCTL	I/O
21	NC	-
22	DDIO_BKLTEN	I/O
23	DDIO_HPD	I/O
24	GND	GND
25	GND	GND
26	GND	GND
27	+V12S	PWR
28	+V12S	PWR
29	+V12S	PWR
30	+V12S	PWR

2.3.4 I2C, SMBus (JESPI1)

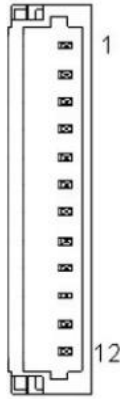

Pin	Pin Name	Signal Type
1	LAD0_ESPI1_DATA0	I/O
2	LAD0_ESPI1_DATA1	I/O
3	LAD0_ESPI1_DATA2	I/O
4	LAD0_ESPI1_DATA3	I/O
5	+V3P3S	PWR
6	LPC_FRAME#	I/O
7	I2C0_DATA_3P3S	I/O
8	GND	GND
9	I2C0_CLK_3P3S	I/O
10	SMB_DATA	I/O
11	SMB_CLK	I/O
12	SMB_ALERT#	I/O

2.3.5 FAN (JFAN1)

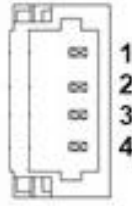

Pin	Pin Name	Signal Type
1	GND	GND
2	+V12S	PWR
3	FAN_1_TAC_CON	I/O
4	FAN_1_CTL_CON	I/O

2.3.6 HDMI (JHDMI1)

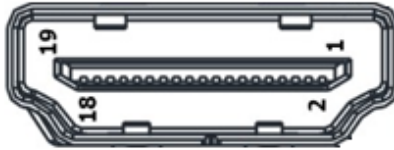

Pin	Pin Name	Signal Type
1	HDMI1_D2_DP_CM	I/O
2	GND	GND
3	HDMI1_D2_DN_CM	I/O
4	HDMI1_D1_DP_CM	I/O
5	GND	GND
6	HDMI1_D1_DN_CM	I/O
7	HDMI1_D0_DP_CM	I/O

Pin	Pin Name	Signal Type
8	GND	GND
9	HDMI1_D0_DN_CM	I/O
10	HDMI1_CLK_DP_CM	I/O
11	GND	GND
12	HDMI1_CLK_DN_CM	I/O
13	NC	-
14	NC	-
15	HDMI1_SCL	I/O
16	HDMI1_SDA	I/O
17	GND	GND
18	+V5S_HDMI	PWR
19	HDMI1_HPD	I/O

2.3.7 LAN (JLAN1)

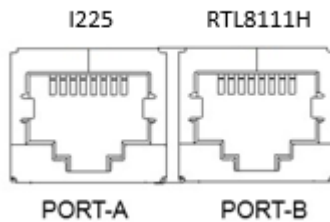

Pin	Pin Name	Signal Type
1P1	LAN2_MDI0+	I/O
1P2	LAN2_MDI0-	I/O
1P3	LAN2_MDI1+	I/O
1P4	LAN2_MDI1-	I/O

Pin	Pin Name	Signal Type
1P5	LAN2_CT	I/O
1P6	LAN2_CT	I/O
1P7	LAN2_MDI2+	I/O
1P8	LAN2_MDI2-	I/O
1P9	LAN2_MDI3+	I/O
1P10	LAN2_MDI3-	I/O
2P1	LAN1_MDI0+	I/O
2P2	LAN1_MDI0-	I/O
2P3	LAN1_MDI1+	I/O
2P4	LAN1_MDI1-	I/O
2P5	LAN1_CT	I/O
2P6	LAN1_CT	I/O
2P7	LAN1_MDI2+	I/O
2P8	LAN1_MDI2-	I/O
2P9	LAN1_MDI3+	I/O
2P10	LAN1_MDI3-	I/O

2.3.8 M.2 2280 M-Key (JM2M1)

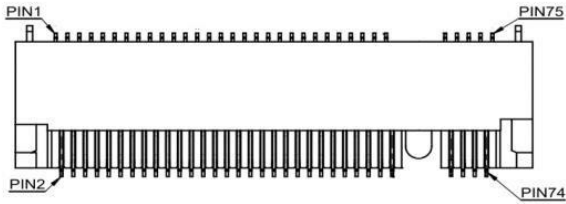

Pin	Pin Name	Signal Type
1	GND	GND
2	+V3P3S	PWR
3	GND	GND
4	+V3P3S	PWR
5	NC	-
6	CARD_PWR_EN_R	I/O
7	NC	-
8	NC	-
9	GND	GND
10	NC	-
11	NC	-
12	+V3P3S	PWR
13	NC	-
14	+V3P3S	PWR
15	GND	GND
16	+V3P3S	PWR
17	NC	-
18	+V3P3S	PWR
19	NC	-

Pin	Pin Name	Signal Type
20	NC	-
21	GND	GND
22	NC	-
23	NC	-
24	NC	-
25	NC	-
26	NC	-
27	GND	GND
28	NC	-
29	GPP_RXN9_SATA3_RXN	I/O
30	NC	-
31	GPP_RXP9_SATA3_RXP	I/O
32	NC	-
33	GND	GND
34	NC	-
35	GPP_TXN9_SATA3_TXN	I/O
36	NC	-
37	GPP_TXP9_SATA3_TXP	I/O
38	NC	-
39	GND	GND
40	M2M_SMB_CLK	I/O
41	GPP_RXN8_SATA2_RXN	I/O
42	M2M_SMB_DATA	I/O
43	GPP_RXP8_SATA2_RXP	I/O
44	NC	-
45	GND	GND

Pin	Pin Name	Signal Type
46	NC	-
47	GPP_TXN8_SATA2_TXN	I/O
48	NC	-
49	GPP_TXP8_SATA2_TXP	I/O
50	BUF_PLT_RST#	I/O
51	GND	GND
52	M2M_CLKREQ#	I/O
53	GPP_CLKN3_M2M	I/O
54	PCIE_WAKE#	I/O
55	GPP_CLKP3_M2M	I/O
56	NC	-
57	GND	GND
58	NC	-
59	NC	-
60	M2M_SSCLK	I/O
61	NC	-
62	+V3P3S	PWR
63	GND	GND
64	+V3P3S	PWR
65	GND	GND
66	+V3P3S	PWR
67	GND	GND
68	GND	GND
69	GND	GND
70	GND	GND
71	+V3P3S	PWR

Pin	Pin Name	Signal Type
72	GND	GND
73	+V3P3S	PWR
74	NC	-
75	CARD_PWR_EN_R	I/O

2.3.9 PCIe (JPCIE_FPC1)

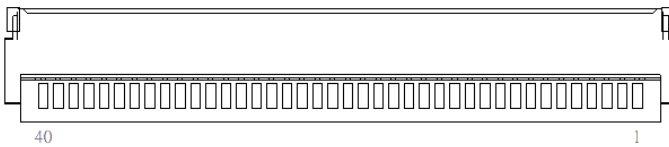

Pin	Pin Name	Signal Type	Signal Level
1	+V3P3S	PWR	+3.3V
2	+V3P3S	PWR	+3.3V
3	+V3P3S	PWR	+3.3V
4	SMB_DATA	I/O	+3.3V
5	SMB_CLK	I/O	-
6	BUF_PLT_RST#	I/O	-
7	+V3P3A	PWR	-
8	GND	GND	-
9	FPC_PCIE_RXP5	I/O	-
10	FPC_PCIE_RXN5	I/O	-
11	GND	GND	-
12	FPC_PCIE_RXP7	I/O	-
13	FPC_PCIE_RXN7	I/O	-
14	GND	GND	-

Pin	Pin Name	Signal Type	Signal Level
15	FPC_PCIE_RXP6	I/O	-
16	FPC_PCIE_RXN6	I/O	-
17	GND	GND	-
18	FPC_PCIE_RXP4	I/O	-
19	FPC_PCIE_RXN4	I/O	-
20	GND	GND	-
21	FPC_PCIE_TXN7	I/O	-
22	FPC_PCIE_TXP7	I/O	-
23	GND	GND	-
24	FPC_PCIE_TXN6	I/O	-
25	FPC_PCIE_TXP6	I/O	-
26	GND	GND	-
27	FPC_PCIE_TXN5	I/O	-
28	FPC_PCIE_TXP5	I/O	-
29	GND	GND	-
30	GPP_CLKN2_FPC	I/O	-
31	GPP_CLKP2_FPC	I/O	-
32	GND	GND	-
33	FPC_PCIE_TXN4	I/O	-
34	FPC_PCIE_TXP4	I/O	-
35	GND	GND	-
36	+V12S	PWR	-
37	+V12S	PWR	-
38	+V12S	PWR	-
39	+V12S	PWR	-
40	+V12S	PWR	-

2.3.10 RTC Battery (JRTC1)

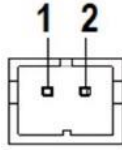

Pin	Pin Name	Signal Type
1	+VRTC_BATT	PWR
2	GND	GND

2.3.11 SATA (JSATA1)

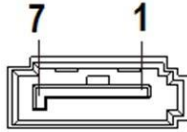

Pin	Pin Name	Signal Type
1	GND	GND
2	SATA_0_TXP	I/O
3	SATA_0_TXN	I/O
4	GND	GND
5	SATA_0_RXN	I/O
6	SATA_0_RXP	I/O
7	GND	GND

2.3.12 SATA Power (JSATAP1)

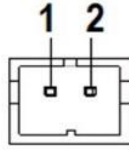

Pin	Pin Name	Signal Type
1	+V5S	PWR
2	GND	GND

2.3.13 USB 3.2 (JUSB1)

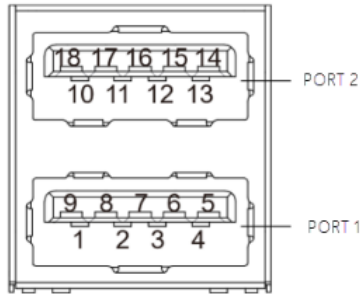

Pin	Pin Name	Signal Type
1	+V5A_USB_01	PWR
2	USBD0-	I/O
3	USBD0+	I/O
4	GND	GND
5	USB3_RXN0_C	I/O
6	USB3_RXNP_C	I/O
7	GND	GND

Pin	Pin Name	Signal Type
8	USB3_TXN0_C	I/O
9	USB3_TXP0_C	I/O
10	+V5A_USB_01	PWR
11	USBD1-	I/O
12	USBD1+	I/O
13	GND	GND
14	USB3_RXN1_C	I/O
15	USB3_RXP1_C	I/O
16	GND	GND
17	USB3_TXN1_C	I/O
18	USB3_TXP1_C	I/O

Chapter 3

AMI BIOS Setup

3.1 System Test and Initialization

The board uses certain routines to perform testing and initialization. If an error, fatal or non-fatal, is encountered, a few short beeps or an error message will be outputted. The board can usually continue the boot up sequence with non-fatal errors.

The system configuration verification routines check the current system configuration against the values stored in the CMOS memory. If they do not match, an error message will be outputted, in which case you will need to run the BIOS setup program to set the configuration information in memory.

There are three situations in which you will need to change the CMOS settings:

- You are starting your system for the first time
- You have changed your system's hardware
- The CMOS memory has lost power and the configuration information is erased

The system's CMOS memory uses a backup battery for data retention, which is to be replaced once emptied.

3.2 AMI BIOS Setup

The AMI BIOS ROM has a pre-installed Setup program that allows users to modify basic system configurations, which is stored in the battery-backed CMOS RAM and BIOS NVRAM so that the information is retained when the power is turned off.

To enter BIOS Setup, press or <F2> immediately while your computer is powering up.

The function for each interface can be found below.

Main – Date and time can be set here. Press <Tab> to switch between date elements

Advanced – Enable/ Disable boot option for legacy network devices

System I/O – Enable/ Disable System input and output port

Security – The setup administrator password can be set here

Boot – Enable/ Disable quiet Boot Option

Save & Exit – Save your changes and exit the program

3.3 Setup Submenu: Main

Aptio Setup - American Megatrends International, LLC.

Main Advanced System I/O Security Boot Save & Exit

== BIOS Information ==
de next-V2K8 R1.4 (DN2KAM14)(10/13/2022)

== CPU Information ==
Socket0: AMD Ryzen Embedded V2718 with Radeon Graphics

== MEM Information ==
Total Memory: 16384 MB (DDR4)

System Date [Fri 01/01/2021]
System Time [00:01:29]

Access Level Administrator

Set the Date. Use Tab to switch between Date elements.
Default Ranges:
Year: 1998-2199
Months: 1-12
Days: dependent on month

++: Select Screen
T1: Select Item
Enter: Select
+/-: Change Opt.
F1: General Help
F2: Previous Values
F3: Optimized Defaults
F4: Save & Exit
ESC: Exit

Ver. 2.21.1277 Copyright (C) 2022 American Megatrends International, LLC.

de next Board

de next-V2K8

3.4 Setup Submenu: Advanced

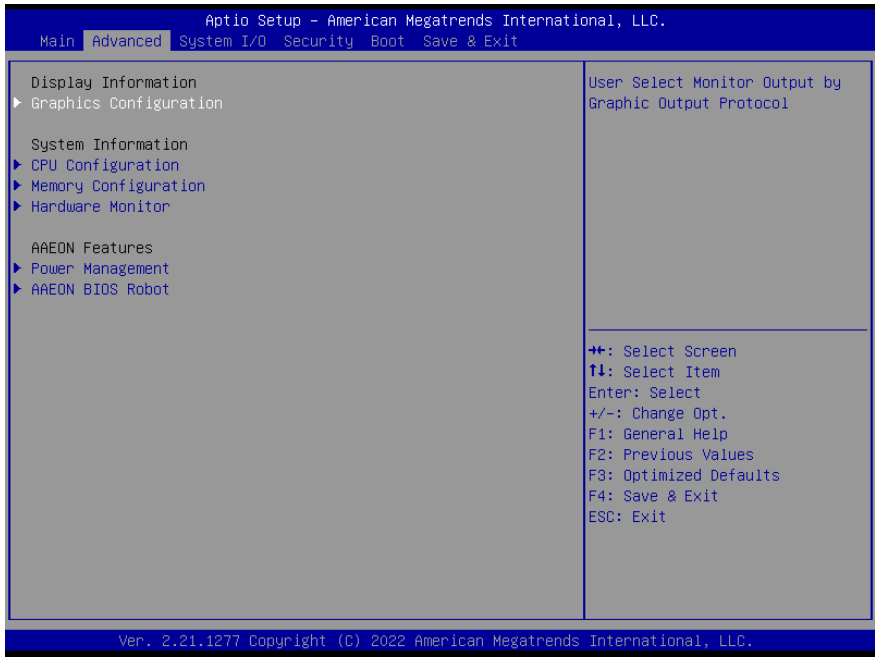

3.4.1 Graphics Configuration

de next Board

de next-V2K8

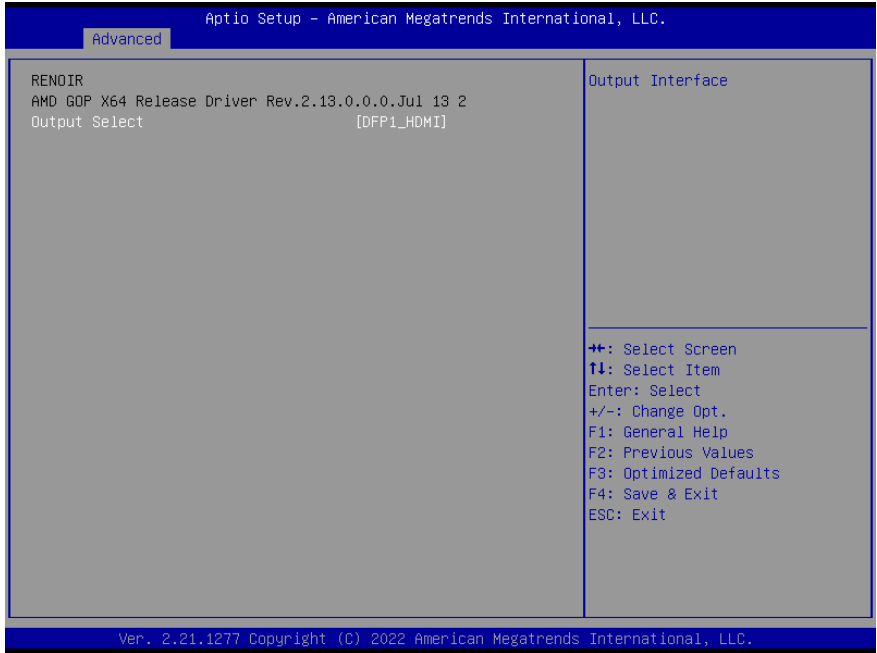

3.4.2 CPU Configuration

de next Board

de next-V2K8

Aptio Setup - American Megatrends International, LLC.

Advanced

<p>CPU Configuration</p> <p>Socket0: AMD Ryzen Embedded V2718 with Radeon Graphics 8 Core(s) Running @ 1718 MHz 1218 mV Processor Family: 17h Processor Model: 60h-6Fh CPUID: 00860F01 Current Speed:1700 MHz Min Speed:1400 MHz Microcode Patch Level: 8600106</p> <p>----- Cache per core ----- L1 Instruction Cache: 32 KB/8-way L1 Data Cache: 32 KB/8-way L2 Cache: 512 KB/8-way Total L3 Cache per Socket: 8 MB/16-way</p> <p>▶ CPU Common Options</p>	<p>CPU Common Options</p> <p>++: Select Screen ↑↓: Select Item Enter: Select +/-: Change Opt. F1: General Help F2: Previous Values F3: Optimized Defaults F4: Save & Exit ESC: Exit</p>
--	---

Ver. 2.21.1277 Copyright (C) 2022 American Megatrends International, LLC.

3.4.2.1 CPU Common Options

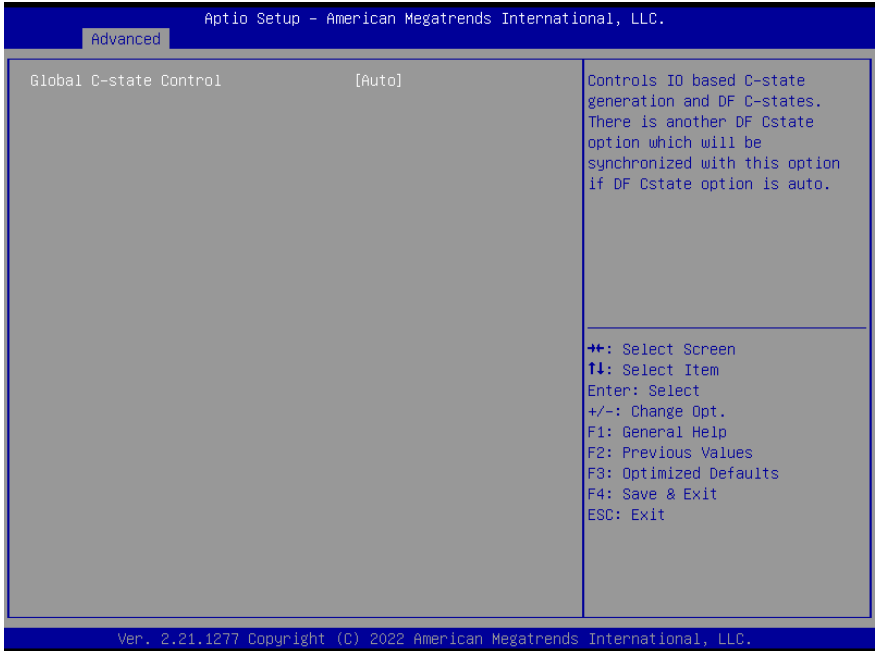

Options Summary		
Global C-state Control	Disabled	
	Enabled	
	Auto	Optimal Default
Controls IO based C-state generation and DF C-states. There is another DF C-state option which will be synchronized with this option if DF C-state option is auto.		

3.4.3 Memory Configuration

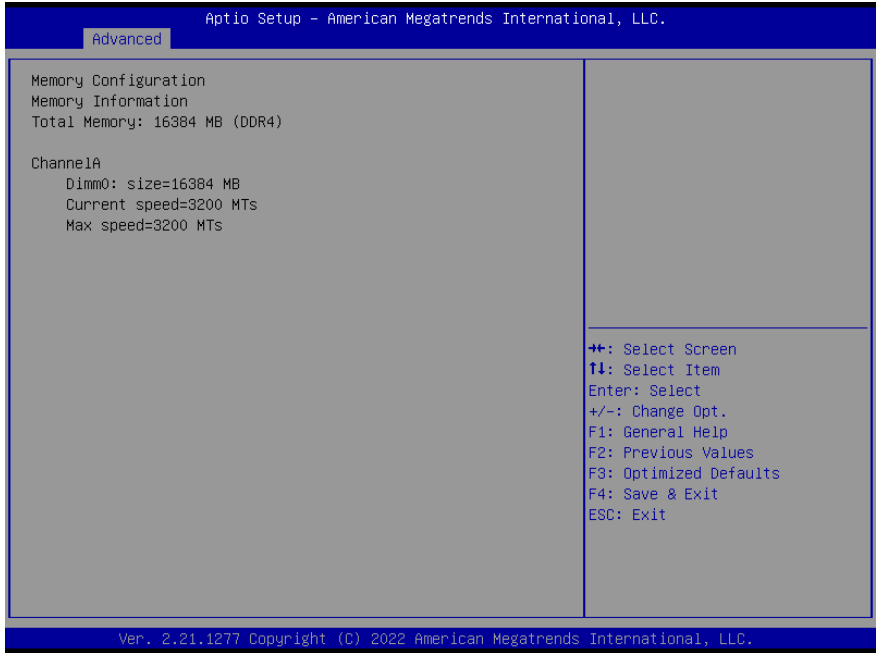

3.4.4 Hardware Monitor

de next Board

de next-V2K8

Aptio Setup - American Megatrends International, LLC.

Advanced

<p>Pc Health Status</p> <p>System Temperature : +35 ℃ System Temperature 2 : +32 ℃ System FAN : 4424 RPM VCORE : +1.200 V +12V : +11.221 V +5V : +4.918 V VMEM : +1.096 V +3.3V : +3.328 V 3VSB : +3.312 V 5VSB : +5.016 V VBAT : +3.248 V</p> <p>Smart Fan [Enabled] ▶ Smart Fan Mode Configuration</p>	<p>Enable or Disable Smart Fan</p> <hr/> <p> ++: Select Screen ↑↓: Select Item Enter: Select +/-: Change Opt. F1: General Help F2: Previous Values F3: Optimized Defaults F4: Save & Exit ESC: Exit </p>
---	--

Ver. 2.21.1277 Copyright (C) 2022 American Megatrends International, LLC.

Options Summary		
Smart Fan	Disabled	
	Enabled	Optimal Default
Enable or Disable Smart Fan.		

3.4.4.1 Smart Fan Mode Configuration

Aptio Setup - American Megatrends International, LLC.

Advanced

Smart Fan Mode Configuration		Output PWM mode (push pull) to control 4-wire fans. Linear fan application circuit to control 3-wire fan speed by fan's power terminal. Output PWM mode (open drain) to control Intel 4-wire fans.
FAN1 Output Mode	[Output PWM mode (open drain)]	
Fan 1 Smart Fan Control	[Auto Duty-Cycle Mode]	
Temperature Source	[System Temperature]	
Temperature 1	60	
Temperature 2	50	
Temperature 3	40	
Temperature 4	30	
Duty Cycle 1	85	
Duty Cycle 2	70	
Duty Cycle 3	60	
Duty Cycle 4	50	
Duty Cycle 5	40	

++: Select Screen
↑↓: Select Item
Enter: Select
+/-: Change Opt.
F1: General Help
F2: Previous Values
F3: Optimized Defaults
F4: Save & Exit
ESC: Exit

Ver. 2.21.1277 Copyright (C) 2022 American Megatrends International, LLC.

3.4.5 Power Management

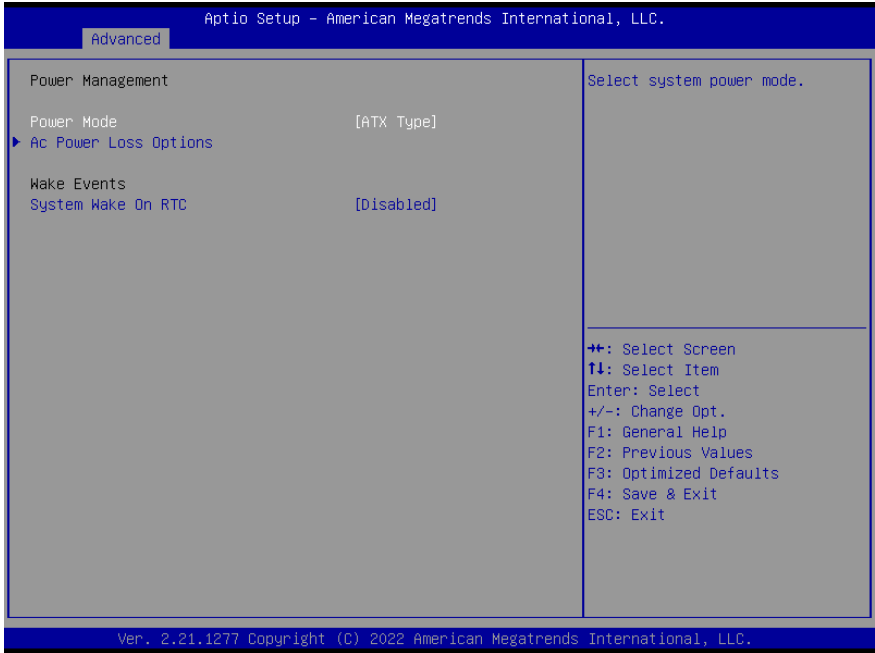

Options Summary		
Power Mode	ATX Type	Optimal Default, Failsafe Default
	AT Type	
Select system power mode		
System Wake On RTC	Disabled	Optimal Default
	By Date	
	By Weekday	
	Bypass	
By Date: System will wake on the day with hr: min: sec specified.		
By Weekday: System will wake on the enabled weekday with hr: min: sec specified.		
Bypass: BIOS will not control RTC wake function.		
Wake up day	0-31	For by date
Select 0 for daily system wake up, 1-31 for which day of the month that you would like the system to wake up.		
Sunday/Monday/Tuesday/ Wednesday/Thursday/ Friday/Saturday	Disabled	For by weekday.
	Enabled	
Enable or disable RTC wake up on weekday.		

Options Summary

Wake up hour	0-23
Select 0-23. For example, enter 3 for 3am and 15 for 3pm.	
Wake up minute	0-59
Wake up second	0-59

3.4.5.1 AC Power Loss Options

Aptio Setup - American Megatrends International, LLC.

Advanced

Ac Power Loss Options

Ac Loss Control [Always Off]

Select Ac Loss Control Method

++: Select Screen
 ↑↓: Select Item
 Enter: Select
 +/-: Change Opt.
 F1: General Help
 F2: Previous Values
 F3: Optimized Defaults
 F4: Save & Exit
 ESC: Exit

Ver. 2.21.1277 Copyright (C) 2022 American Megatrends International, LLC.

Options Summary

Ac Loss Control	Always Off	
	Always On	Optimal Default
	Last State	

Select Ac Loss Control Method.

Please note that AC Loss Control isn't supported in Auto Power Button Mode.

3.4.6 AAEON BIOS Robot

de next Board

de next-V2K8

Aptio Setup - American Megatrends International, LLC.

Advanced

AAEON BIOS Robot		Enabled - Robot set Watch Dog Timer(WDT) right after power on, before BIOS start POST process. And then Robot will clear WDT on completion of POST. WDT will reset system automatically if it is not cleared before its timer counts down to zero.
Sends watch dog before BIOS POST	[Disabled]	++: Select Screen ↑↓: Select Item Enter: Select +/-: Change Opt. F1: General Help F2: Previous Values F3: Optimized Defaults F4: Save & Exit ESC: Exit
POST Timer (second)	30	
Sends watch dog before booting OS	[Disabled]	
OS Timer (minute)	3	
Delayed POST (PEI phase)	[Disabled]	
Delayed time (second)	10	
Delayed POST (DXE phase)	[Disabled]	
Delayed time (second)	10	
Reset system once	[Disabled]	
Soft or hard reset	[Soft reset]	
▶ Device detecting configuration		

Ver. 2.21.1277 Copyright (C) 2022 American Megatrends International, LLC.

Options Summary		
Sends watch dog before BIOS POST	Disabled	Optimal Default
	Enabled	
Robot set Watch Dog Timer (WDT) right after power on, before BIOS start POST process. And then Robot will clear WDT on completion of POST. WDT will reset system automatically if it is not cleared before its timer counts down to zero.		
Sends watch dog before booting OS	Disabled	Optimal Default
	Enabled	
Robot set Watch Dog Timer (WDT) after POST completion, before BIOS transfer control to OS. WARNING: Before enabling this function, a program in OS must be in responsible for clearing WDT. Also, this function should be disabled if OS is going to update itself.		
Delayed POST (PEI phase)	Disabled	Optimal Default
	Enabled	
Robot holds BIOS from starting POST, right after power on. This allows BIOS POST to start with stable power or start after system is physically warmed-up.		
Delayed POST (DXE phase)	Disabled	Optimal Default
	Enabled	

Options Summary

Robot holds BIOS before POST completion. This allows BIOS POST to start with stable power or start after system is physically warmed-up.

Reset system once	Disabled	Optimal Default
	Enabled	

Robot resets system for one time on each boot. This will send a soft or hard reset to onboard devices, thus puts devices to more stable state.

3.4.6.1 Device Detecting Configuration

Aptio Setup - American Megatrends International, LLC.

Advanced

<p>Device detecting configuration</p> <ul style="list-style-type: none"> ▶ Device #1 detecting configuration ▶ Device #2 detecting configuration ▶ Device #3 detecting configuration ▶ Device #4 detecting configuration ▶ Device #5 detecting configuration <p>If any device is detected in unexpected condition, the robot will do following</p> <table style="width: 100%; border: none;"> <tr> <td>Action</td> <td>[Reset System]</td> </tr> <tr> <td>Soft or hard reset</td> <td>[Soft]</td> </tr> <tr> <td>Retry-Count</td> <td>3</td> </tr> <tr> <td>At time</td> <td>[After show logo]</td> </tr> </table>	Action	[Reset System]	Soft or hard reset	[Soft]	Retry-Count	3	At time	[After show logo]	<p>Device #1 detecting configuration</p> <hr/> <p> ++: Select Screen F1: Select Item Enter: Select +/-: Change Opt. F1: General Help F2: Previous Values F3: Optimized Defaults F4: Save & Exit ESC: Exit </p>
Action	[Reset System]								
Soft or hard reset	[Soft]								
Retry-Count	3								
At time	[After show logo]								

Ver. 2.21.1277 Copyright (C) 2022 American Megatrends International, LLC.

Options Summary

Action	Reset System	Optimal Default
	Hold System	

Select action that robot should do.

Soft or hard reset	Soft	Optimal Default
	Hard	

Select reset type robot should send on each boot.

Retry-Count	3	
-------------	---	--

Robot will reset system at most counter times, and then let system continue its POST.

3.5 Setup Submenu: System I/O

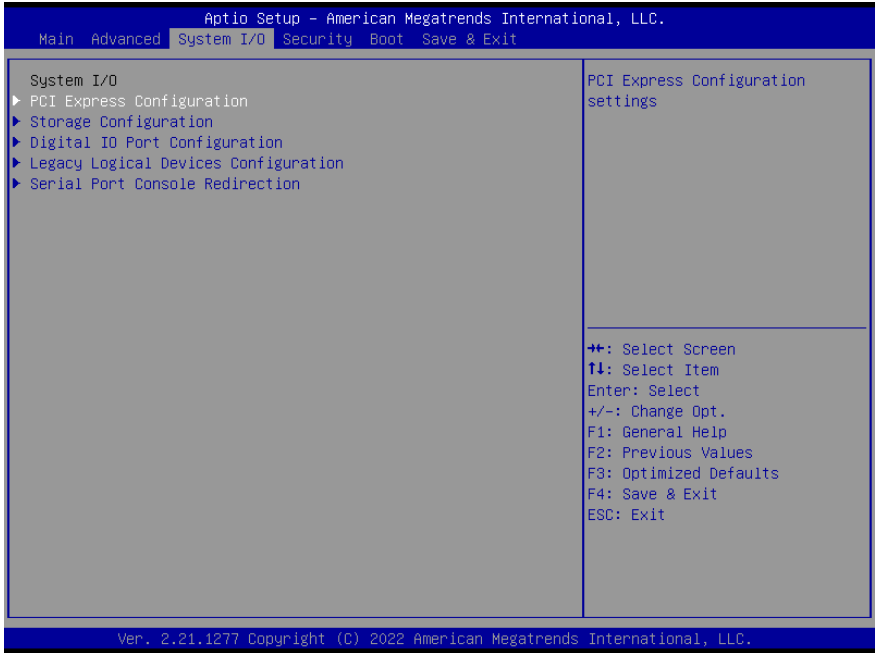

Options summary

Cont.	Hotplug Enhanced	
	Hotplug Inboard	
	Auto	Default
NB Root Port Hotplug Mode Control.		

3.5.2 Storage Configuration

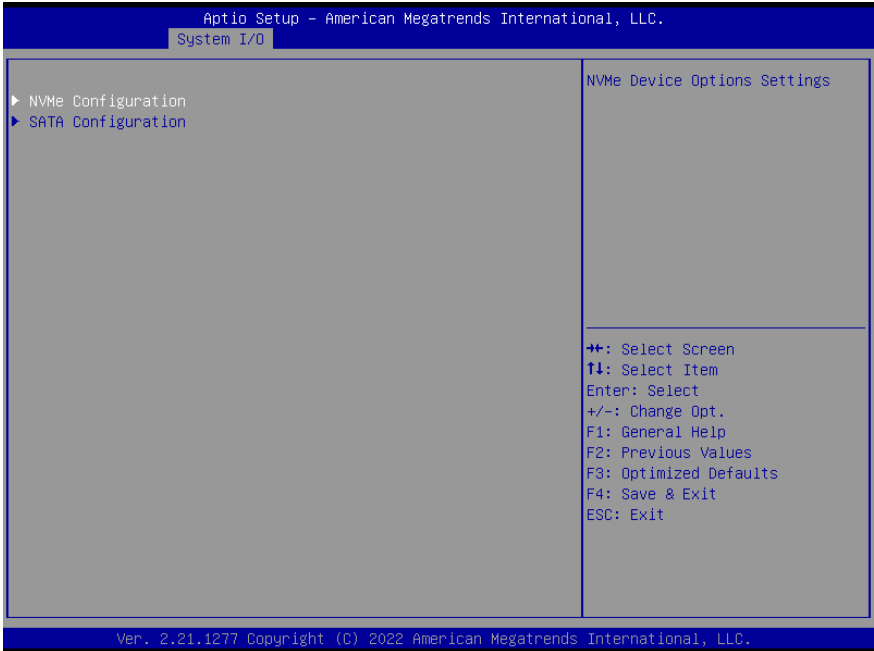

3.5.2.1 NVMe Configuration

Aptio Setup - American Megatrends International, LLC.
System I/O

NVMe Configuration ▶ TS256GME652T-I		
		⇧+: Select Screen ⇩: Select Item Enter: Select +/-: Change Opt. F1: General Help F2: Previous Values F3: Optimized Defaults F4: Save & Exit ESC: Exit

Ver. 2.21.1277 Copyright (C) 2022 American Megatrends International, LLC.

Aptio Setup - American Megatrends International, LLC.
System I/O

Seg:Bus:Dev:Func 00:03:00:00 Model Number TS256GME652T-I Total Size 256.0 GB Vendor ID 126F Device ID 2263	Select either Short or Extended Self Test. Short option will take couple of minutes and extended option will take several minutes to complete.
Namespace: 1 Size: 256.0 GB	
Device Self Test: Self Test Option [Short] Self Test Action [Controller Only Test] Run Device Self Test	
Short Device Selftest Result [Not Available] Extended Device Selftest Result [Not Available]	⇧+: Select Screen ⇩: Select Item Enter: Select +/-: Change Opt. F1: General Help F2: Previous Values F3: Optimized Defaults F4: Save & Exit ESC: Exit

Ver. 2.21.1277 Copyright (C) 2022 American Megatrends International, LLC.

de next Board

de next-V2K8

3.5.3 Digital IO Port Configuration

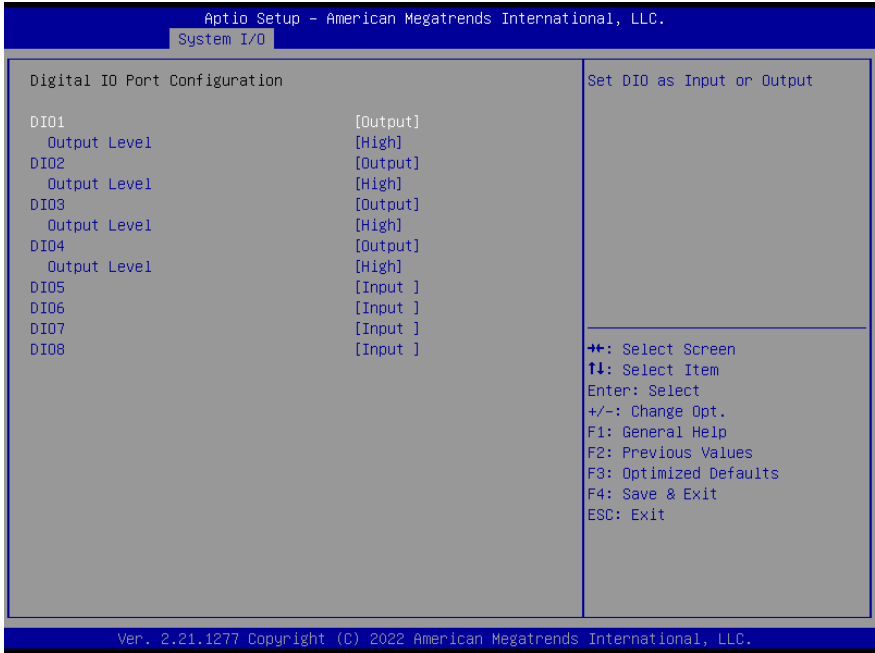

Options Summary	
DIO PORT x	Input Output
Set DIO as Input or Output	
Output Level	Low High
Set output level when DIO pin is output.	

3.5.4 Legacy Logical Devices Configuration

Aptio Setup - American Megatrends International, LLC.
System I/O

AMI SIO Driver Version : A5.17.00

Super IO Chip Logical Device(s) Configuration

- ▶ [*Active*] Serial Port 1
- ▶ [*Active*] Serial Port 2

WARNING: Logical Devices state on the left side of the control, reflects the current Logical Device state. Changes made during Setup Session will be shown after you restart the system.

View and Set Basic properties of the SIO Logical device. Like IO Base, IRQ Range, DMA Channel and Device Mode.

++: Select Screen
↑↓: Select Item
Enter: Select
+/-: Change Opt.
F1: General Help
F2: Previous Values
F3: Optimized Defaults
F4: Save & Exit
ESC: Exit

Ver. 2.21.1277 Copyright (C) 2022 American Megatrends International, LLC.

3.5.4.1 Serial Port x Configuration

de next Board

de next-V2K8

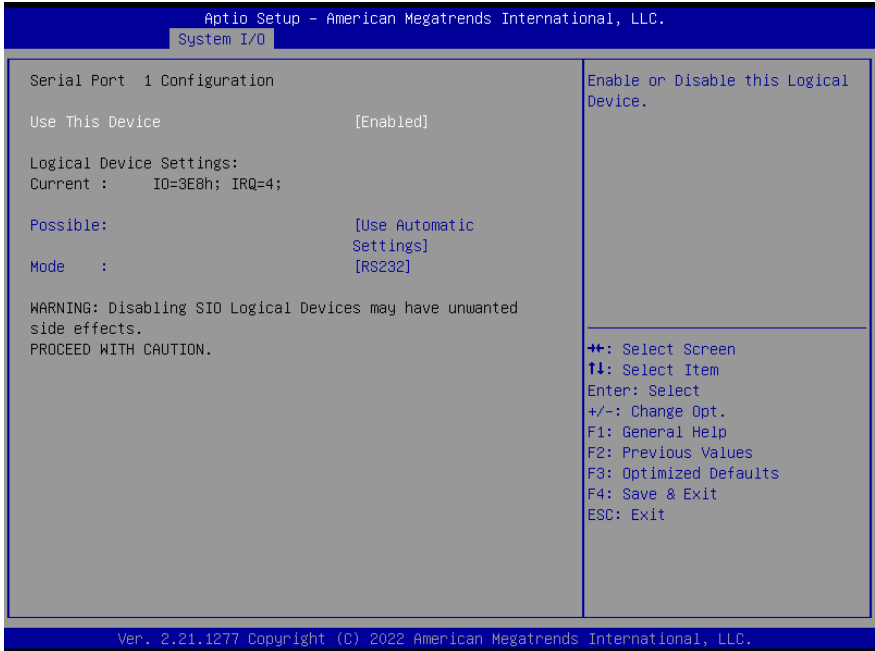

Options Summary		
Use This Device	Disabled	
	Enabled	Optimal Default
Enable or Disable this Logical Device.		
Possible	Use Automatic Settings	Optimal Default
	IO=3E8h; IRQ=4;	
	IO=2F8h; IRQ=3;	
Allows the user to change the device resource settings. New settings will be reflected on this setup page after system restarts.		
Mode	RS232	Optimal Default
	RS422	
	RS485	
UART RS232, 422, 485 selection.		

3.5.5 Serial Port Console Redirection

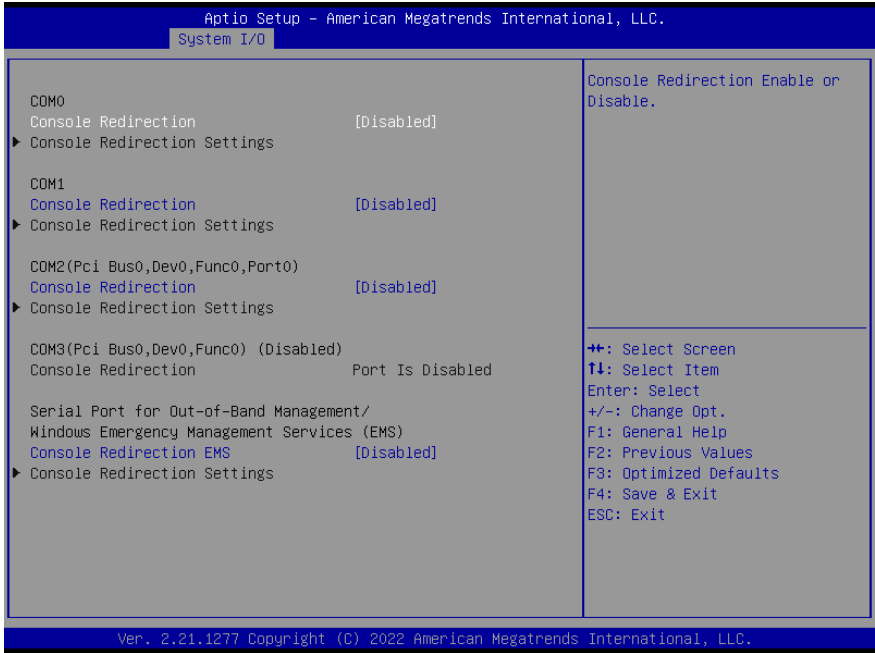

Options Summary		
COM0/1/2 Console Redirection	Disabled	Default
	Enabled	
Console Redirection Enable or Disable.		
Console Redirection EMS	Disabled	Default
	Enabled	
Serial Port for Out-of-Band Management/ Windows Emergency Management Services (EMS) Console Redirection Enable or Disable.		

3.6 Setup Submenu: Security

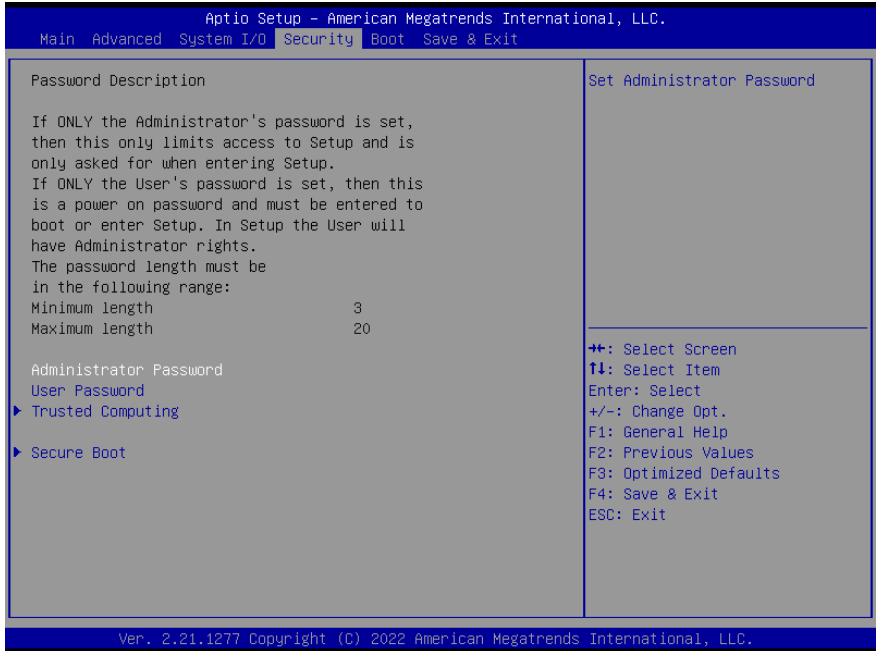

Change User/Supervisor Password

You can install a Supervisor password, and if you install a supervisor password, you can then install a user password. A user password does not provide access to many of the features in the Setup utility.

If you highlight these items and press Enter, a dialog box appears which lets you enter a password. You can enter no more than six letters or numbers. Press Enter after you have typed in the password. A second dialog box asks you to retype the password for confirmation. Press Enter after you have retyped it correctly. The password is required at boot time, or when the user enters the Setup utility.

Removing the Password

Highlight this item and type in the current password. At the next dialog box press Enter to disable password protection.

3.6.1 Trusted Computing

de next Board

de next-V2K8

Aptio Setup – American Megatrends International, LLC.

Security

<p>TPM 2.0 Device Found Firmware Version: 3.77 Vendor: AMD</p> <p>Security Device Support [Enable] Active PCR banks SHA-1,SHA256 Available PCR banks SHA-1,SHA256</p> <p>SHA-1 PCR Bank [Enabled] SHA256 PCR Bank [Enabled]</p> <p>Pending operation [None] Platform Hierarchy [Enabled] Storage Hierarchy [Enabled] Endorsement Hierarchy [Enabled] TPM 2.0 UEFI Spec Version [TCG_2] Physical Presence Spec Version [1.3] TPM 2.0 InterfaceType [CRB] Device Select [Auto] Disable Block Sid [Disabled]</p>	<p>Enables or Disables BIOS support for security device. O.S. will not show Security Device. TCG EFI protocol and INT1A interface will not be available.</p> <hr/> <p>++: Select Screen T1: Select Item Enter: Select +/-: Change Opt. F1: General Help F2: Previous Values F3: Optimized Defaults F4: Save & Exit ESC: Exit</p>
--	--

Ver. 2.21.1277 Copyright (C) 2022 American Megatrends International, LLC.

Options Summary		
Security Device Support	Disabled	
	Enabled	Optimal Default, Failsafe Default
Enable or Disable BIOS support for security device.		
SHA-1 PCR Bank	Disabled	
	Enabled	Optimal Default, Failsafe Default
Enable or Disable SHA-1 PCR Bank.		
SHA256 PCR Bank	Disabled	
	Enabled	Optimal Default, Failsafe Default
Enable or Disable SHA256 PCR Bank.		
Pending operation	None	Optimal Default,
	TPM Clear	
Schedule an operation for the security device.		
Platform Hierarchy	Disabled	
	Enabled	Optimal Default, Failsafe Default
Enable or Disable Platform Hierarchy.		

Options Summary		
Storage Hierarchy	Disabled	
	Enabled	Optimal Default, Failsafe Default
Enable or Disable Storage Hierarchy.		
Endorsement Hierarchy	Disabled	
	Enabled	Optimal Default, Failsafe Default
Enable or Disable Endorsement Hierarchy.		
TPM2.0 UEFI Spec Version	TCG_1_2	
	TCG_2	Optimal Default
Select the TCG2 Select Version Support.		
Physical Presence Spec Version	1.2	
	1.3	Optimal Default
Select to Tell O.S. to support PPI Spec Version 1.2 or 1.3.		
Device select	TPM 1.2	
	TPM 2.0	
	Auto	Optimal Default
Device select.		
Disable Block Sid	Enabled	
	Disabled	Optimal Default
Override to allow SID authentication in TCG Storage device.		

3.6.2 Secure Boot

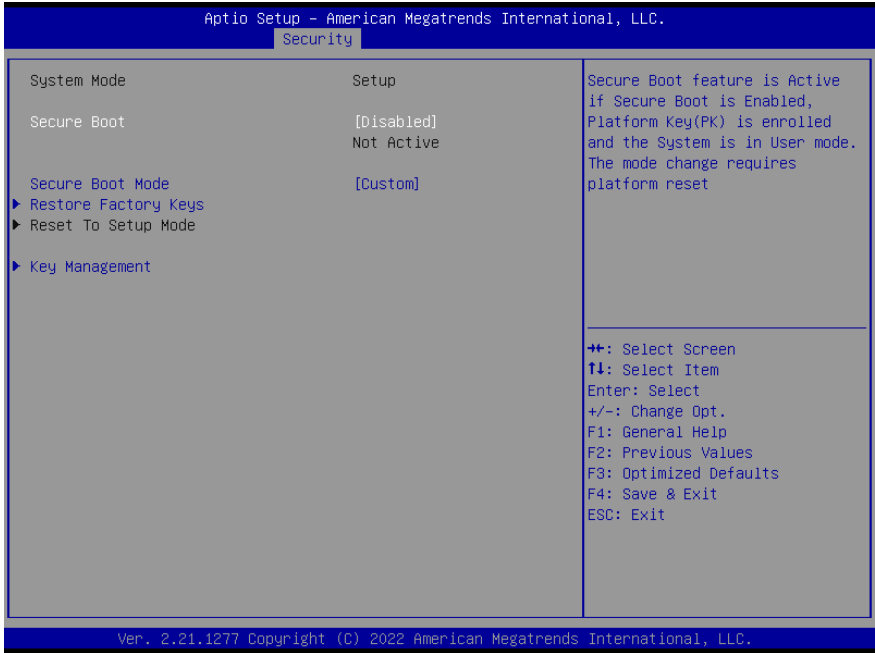

Options Summary		
Secure Boot	Disabled	Default
	Enabled	
Secure Boot feature is Active if Secure is Enabled, Platform Key (PK) is enrolled and the System is in User mode. The mode change requires platform reset.		
Secure Boot Mode	Standard	
	Custom	Default
Secure Boot mode selector.		

3.6.2.1 Key Management

Aptio Setup - American Megatrends International, LLC.

Security

Vendor Keys	Valid	Install factory default Secure Boot keys after the platform reset and while the System is in Setup mode		
Factory Key Provision	[Disabled]			
▶ Restore Factory Keys				
▶ Reset To Setup Mode				
▶ Export Secure Boot variables				
▶ Enroll Efi Image				
Device Guard Ready				
▶ Remove 'UEFI CA' from DB				
▶ Restore DB defaults				
Secure Boot variable	Size	Keys	Key Source	++: Select Screen ↑↓: Select Item Enter: Select +/-: Change Opt. F1: General Help F2: Previous Values F3: Optimized Defaults F4: Save & Exit ESC: Exit
▶ Platform Key(PK)	0	0	No Keys	
▶ Key Exchange Keys	0	0	No Keys	
▶ Authorized Signatures	0	0	No Keys	
▶ Forbidden Signatures	0	0	No Keys	
▶ Authorized TimeStamps	0	0	No Keys	
▶ OsRecovery Signatures	0	0	No Keys	

Ver. 2.21.1277 Copyright (C) 2022 American Megatrends International, LLC.

3.7 Setup Submenu: Boot

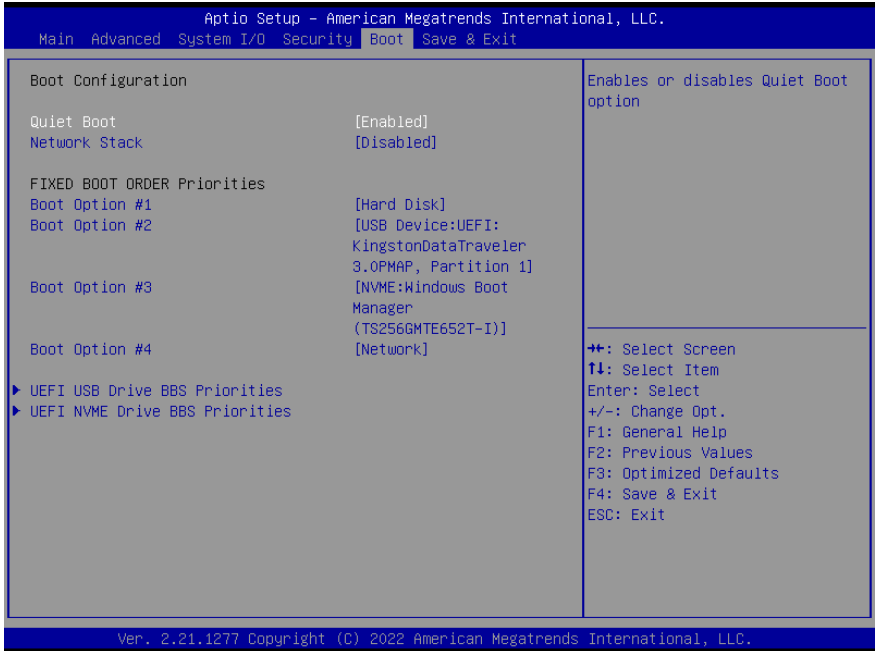

Options Summary		
Quiet Boot	Disabled	
	Enabled	Default
Enable or Disable showing boot logo.		
Network Stack	Disabled	Default
	Enabled	
Enable/Disable UEFI Network Stack		
Boot Option #1	Hard Disk	Default
Boot Option #2	USB Device	Default
Boot Option #3	NVME	Default
Boot Option #4	Network	Default
Sets the system boot order for FIXED BOOT ORDER Priorities.		

3.8 Setup Submenu: Save & Exit



Chapter 4

Driver Installation

4.1 Driver Download/Installation

Drivers for the de next-V2K8 can be downloaded from the product page on the AAEON website by following this link:

<https://www.aaeon.com/en/p/embedded-single-board-computers-denext-v2k8>

Download the driver(s) you need and follow the steps below to install them.

Step 1 – Install Chipset Driver

1. Open the **Chipset Driver** folder
2. Run the **AMD_Chipset_Software.exe** file in the folder
3. Follow the instructions
4. Drivers will be installed automatically

Step 2 – Install Graphics Driver

1. Open the **Graphics Driver** folder
2. Run the **Setup.exe** file in the folder
3. Follow the instructions
4. Drivers will be installed automatically

Step 3.1 – Install LAN Driver (Windows 10)

1. Open the **LAN Driver** folder and select **Install_Win10_10056_03222022.zip**
2. Run the **Install_Win10_10056_03222022.exe** file in the folder
3. Follow the instructions
4. Drivers will be installed automatically

Step 3.2 – Install LAN Driver (Intel®)

Note: You must install Intel Ethernet device drivers before you can install Intel® PROSet.

Step 3.2.1 Intel Ethernet Device Drivers

1. Open the **Intel LAN** folder
2. Run the **Wired_driver_26.3_x64.exe** file in the folder
3. Follow the instructions
4. Drivers will be installed automatically

Step 3.2.2 Intel® PROSet Drivers

1. Open the **Intel LAN** folder
2. Run the **Wired_PROSet_26.3_x64.exe** file in the folder
3. Follow the instructions
4. Drivers will be installed automatically

Step 4 – Install Linux Peripheral Drivers

1. Open the **Linux Driver-Peripheral** folder
2. Follow the instructions given for I2C, SMBus, and WMI Linux driver packages.
3. Follow the instructions to install the drivers manually.

Appendix A

I/O Information













































A.2 Memory Address Map













































de next Board

de next-V2K8

Icon	Address Range	Device Name
Folder	[0000000000A0000 - 0000000000BFFFFF]	PCI Express Root Complex
Folder	[0000000000C0000 - 0000000000DFFFFF]	PCI Express Root Complex
Key	[00000000CC4EA000 - 00000000CC4EDFFF]	信賴平台模組 2.0
Key	[00000000CC4EE000 - 00000000CC4F1FFF]	信賴平台模組 2.0
Folder	[00000000D0000000 - 00000000DFFFFFFF]	AMD Radeon(TM) Graphics
Folder	[00000000D0000000 - 00000000E01FFFFFFF]	PCI Express Root Port
Folder	[00000000D0000000 - 00000000FEBFFFFFFF]	PCI Express Root Complex
Folder	[00000000E0000000 - 00000000E01FFFFFFF]	AMD Radeon(TM) Graphics
Folder	[00000000F0000000 - 00000000F7FFFFFFF]	系統主機板
Folder	[00000000FD000000 - 00000000FDFFFFFFF]	主機板資源
Key	[00000000FE300000 - 00000000FE33FFFFFFF]	AMD USB 3.10 可延伸主機控制器 - 1.10 (Microsoft)
Folder	[00000000FE300000 - 00000000FE6FFFFFFF]	PCI Express Root Port
Key	[00000000FE400000 - 00000000FE43FFFFFFF]	AMD USB 3.10 可延伸主機控制器 - 1.10 (Microsoft)
Key	[00000000FE500000 - 00000000FE53FFFFFFF]	AMD PSP 10.0 Device
Folder	[00000000FE600000 - 00000000FE67FFFFFFF]	AMD Radeon(TM) Graphics
Folder	[00000000FE680000 - 00000000FE6BFFFFFFF]	AMD Audio CoProcessor
Folder	[00000000FE6F0000 - 00000000FE6F7FFF]	High Definition Audio 控制器
Folder	[00000000FE6F8000 - 00000000FE6FBFFF]	High Definition Audio 控制器
Key	[00000000FE6FE000 - 00000000FE6FFFFFFF]	AMD PSP 10.0 Device
Folder	[00000000FE700000 - 00000000FE73FFFFFFF]	Intel(R) Ethernet Controller (3) I225-LM
Folder	[00000000FE700000 - 00000000FE83FFFFFFF]	PCI Express Root Port
Folder	[00000000FE800000 - 00000000FE803FFF]	Intel(R) Ethernet Controller (3) I225-LM
Key	[00000000FE900000 - 00000000FE903FFF]	標準 NVM Express 控制器
Folder	[00000000FE900000 - 00000000FE93FFFFFFF]	PCI Express Root Port
Folder	[00000000FEA00000 - 00000000FEA03FFF]	Realtek PCIe GbE Family Controller #2
Folder	[00000000FEA00000 - 00000000FEA03FFF]	Realtek PCIe GbE Family Controller
Folder	[00000000FEA00000 - 00000000FEA3FFFFFFF]	PCI Express Root Port
Folder	[00000000FEA04000 - 00000000FEA04FFF]	Realtek PCIe GbE Family Controller #2
Folder	[00000000FEA04000 - 00000000FEA04FFF]	Realtek PCIe GbE Family Controller
Folder	[00000000FEB80000 - 00000000FEB3FFFFFFF]	主機板資源
Folder	[00000000FEC00000 - 00000000FEC00FFF]	主機板資源
Folder	[00000000FEC01000 - 00000000FEC01FFF]	主機板資源
Folder	[00000000FEC10000 - 00000000FEC10FFF]	主機板資源
Folder	[00000000FED00000 - 00000000FED003FFF]	高精度度事件計時器
Folder	[00000000FED80000 - 00000000FED83FFFFFFF]	主機板資源
Folder	[00000000FED81200 - 00000000FED812FFF]	AMD GPIO Controller
Folder	[00000000FED81500 - 00000000FED818FFF]	AMD GPIO Controller
Folder	[00000000FEDC0000 - 00000000FEDC0FFF]	主機板資源
Folder	[00000000FEDC2000 - 00000000FEDC2FFF]	AMD I2C Controller
Folder	[00000000FEE00000 - 00000000FEE00FFF]	主機板資源
Folder	[00000000FEE00000 - 00000000FFFFFFF]	PCI Express Root Complex
Folder	[00000000FF000000 - 00000000FFFFFFF]	主機板資源

A.3 IRQ Mapping Chart

▼	插斷要求 (IRQ)	
		(ISA) 0x00000000 (00) 系統計時器
		(ISA) 0x00000000 (00) 高精度事件計時器
		(ISA) 0x00000003 (03) Communications Port (COM2)
		(ISA) 0x00000004 (04) Communications Port (COM1)
		(ISA) 0x00000007 (07) AMD GPIO Controller
		(ISA) 0x00000008 (08) 高精度事件計時器
		(ISA) 0x0000000A (10) AMD I2C Controller
		(ISA) 0x00000036 (54) Microsoft ACPI-Compliant System
		(ISA) 0x00000037 (55) Microsoft ACPI-Compliant System
		(ISA) 0x00000038 (56) Microsoft ACPI-Compliant System
		(ISA) 0x00000039 (57) Microsoft ACPI-Compliant System
		(ISA) 0x0000003A (58) Microsoft ACPI-Compliant System
		(ISA) 0x0000003B (59) Microsoft ACPI-Compliant System
		(ISA) 0x0000003C (60) Microsoft ACPI-Compliant System
		(ISA) 0x0000003D (61) Microsoft ACPI-Compliant System
		(ISA) 0x0000003E (62) Microsoft ACPI-Compliant System
		(ISA) 0x0000003F (63) Microsoft ACPI-Compliant System
		(ISA) 0x00000040 (64) Microsoft ACPI-Compliant System
		(ISA) 0x00000041 (65) Microsoft ACPI-Compliant System
		(ISA) 0x00000042 (66) Microsoft ACPI-Compliant System
		(ISA) 0x00000043 (67) Microsoft ACPI-Compliant System
		(ISA) 0x00000044 (68) Microsoft ACPI-Compliant System
		(ISA) 0x00000045 (69) Microsoft ACPI-Compliant System
		(ISA) 0x00000046 (70) Microsoft ACPI-Compliant System
		(ISA) 0x00000047 (71) Microsoft ACPI-Compliant System
		(ISA) 0x00000048 (72) Microsoft ACPI-Compliant System
		(ISA) 0x00000049 (73) Microsoft ACPI-Compliant System
		(ISA) 0x0000004A (74) Microsoft ACPI-Compliant System
		(ISA) 0x0000004B (75) Microsoft ACPI-Compliant System
		(ISA) 0x0000004C (76) Microsoft ACPI-Compliant System
		(ISA) 0x0000004D (77) Microsoft ACPI-Compliant System
		(ISA) 0x0000004E (78) Microsoft ACPI-Compliant System
		(ISA) 0x0000004F (79) Microsoft ACPI-Compliant System
		(ISA) 0x00000050 (80) Microsoft ACPI-Compliant System
		(ISA) 0x00000051 (81) Microsoft ACPI-Compliant System
		(ISA) 0x00000052 (82) Microsoft ACPI-Compliant System
		(ISA) 0x00000053 (83) Microsoft ACPI-Compliant System
		(ISA) 0x00000054 (84) Microsoft ACPI-Compliant System
		(ISA) 0x00000055 (85) Microsoft ACPI-Compliant System
		(ISA) 0x00000056 (86) Microsoft ACPI-Compliant System
		(ISA) 0x00000057 (87) Microsoft ACPI-Compliant System
		(ISA) 0x00000058 (88) Microsoft ACPI-Compliant System
		(ISA) 0x00000059 (89) Microsoft ACPI-Compliant System
		(ISA) 0x0000005A (90) Microsoft ACPI-Compliant System

	(PCI) 0xFFFFFD2 (-46)	Intel(R) Ethernet Controller (3) I225-LM
	(PCI) 0xFFFFFD3 (-45)	Intel(R) Ethernet Controller (3) I225-LM
	(PCI) 0xFFFFFD4 (-44)	AMD USB 3.10 可延伸主機控制器 - 1.10 (Microsoft)
	(PCI) 0xFFFFFD5 (-43)	AMD USB 3.10 可延伸主機控制器 - 1.10 (Microsoft)
	(PCI) 0xFFFFFD6 (-42)	AMD USB 3.10 可延伸主機控制器 - 1.10 (Microsoft)
	(PCI) 0xFFFFFD7 (-41)	AMD USB 3.10 可延伸主機控制器 - 1.10 (Microsoft)
	(PCI) 0xFFFFFD8 (-40)	AMD USB 3.10 可延伸主機控制器 - 1.10 (Microsoft)
	(PCI) 0xFFFFFD9 (-39)	AMD USB 3.10 可延伸主機控制器 - 1.10 (Microsoft)
	(PCI) 0xFFFFFDA (-38)	AMD USB 3.10 可延伸主機控制器 - 1.10 (Microsoft)
	(PCI) 0xFFFFFDB (-37)	AMD USB 3.10 可延伸主機控制器 - 1.10 (Microsoft)
	(PCI) 0xFFFFFDC (-36)	AMD Radeon(TM) Graphics
	(PCI) 0xFFFFFDD (-35)	AMD Radeon(TM) Graphics
	(PCI) 0xFFFFFDE (-34)	AMD Radeon(TM) Graphics
	(PCI) 0xFFFFFDF (-33)	AMD Radeon(TM) Graphics
	(PCI) 0xFFFFFE0 (-32)	Realtek PCIe GbE Family Controller #2
	(PCI) 0xFFFFFE1 (-31)	AMD USB 3.10 可延伸主機控制器 - 1.10 (Microsoft)
	(PCI) 0xFFFFFE2 (-30)	AMD USB 3.10 可延伸主機控制器 - 1.10 (Microsoft)
	(PCI) 0xFFFFFE3 (-29)	AMD USB 3.10 可延伸主機控制器 - 1.10 (Microsoft)
	(PCI) 0xFFFFFE4 (-28)	AMD USB 3.10 可延伸主機控制器 - 1.10 (Microsoft)
	(PCI) 0xFFFFFE5 (-27)	AMD USB 3.10 可延伸主機控制器 - 1.10 (Microsoft)
	(PCI) 0xFFFFFE6 (-26)	AMD USB 3.10 可延伸主機控制器 - 1.10 (Microsoft)
	(PCI) 0xFFFFFE7 (-25)	AMD USB 3.10 可延伸主機控制器 - 1.10 (Microsoft)
	(PCI) 0xFFFFFE8 (-24)	AMD USB 3.10 可延伸主機控制器 - 1.10 (Microsoft)
	(PCI) 0xFFFFFE9 (-23)	AMD PSP 10.0 Device
	(PCI) 0xFFFFFEA (-22)	AMD PSP 10.0 Device
	(PCI) 0xFFFFFEB (-21)	標準 NVMe Express 控制器
	(PCI) 0xFFFFFEC (-20)	標準 NVMe Express 控制器
	(PCI) 0xFFFFFED (-19)	標準 NVMe Express 控制器
	(PCI) 0xFFFFFEE (-18)	標準 NVMe Express 控制器
	(PCI) 0xFFFFFEF (-17)	標準 NVMe Express 控制器
	(PCI) 0xFFFFFF0 (-16)	標準 NVMe Express 控制器
	(PCI) 0xFFFFFF1 (-15)	標準 NVMe Express 控制器
	(PCI) 0xFFFFFF2 (-14)	標準 NVMe Express 控制器
	(PCI) 0xFFFFFF3 (-13)	標準 NVMe Express 控制器
	(PCI) 0xFFFFFF4 (-12)	標準 NVMe Express 控制器
	(PCI) 0xFFFFFF5 (-11)	標準 NVMe Express 控制器
	(PCI) 0xFFFFFF6 (-10)	標準 NVMe Express 控制器
	(PCI) 0xFFFFFF7 (-9)	標準 NVMe Express 控制器
	(PCI) 0xFFFFFF8 (-8)	標準 NVMe Express 控制器
	(PCI) 0xFFFFFF9 (-7)	標準 NVMe Express 控制器
	(PCI) 0xFFFFFFA (-6)	標準 NVMe Express 控制器
	(PCI) 0xFFFFFFB (-5)	PCI Express Root Port
	(PCI) 0xFFFFFFC (-4)	PCI Express Root Port
	(PCI) 0xFFFFFFD (-3)	PCI Express Root Port
	(PCI) 0xFFFFFFE (-2)	PCI Express Root Port

Appendix B

Mating Connector & Cable List

B.1 List of Mating Connectors and Cables

Con. Label	Function	Mating Connector		Available Cable	Cable P/N
		Vendor	Model no		
JCOM1	Connector: USB2.0 x 4 DIO 8 bit COM x 2	Aces	50246-04001-001	Cable 40Pin, de next cable for USB2.0 x 4, COM Port x 2, DIO 8 bit	170X000512
JFP1	Front Panel Connector	CATCH	1204-700-10SMR	Power Button Cable	170X000603
JSATA1	SATA Connector	Molex	887505318	SATA Cable,180D.Length 20cm	1709070200
JSATAP1	SATA Power Connector	Molex	51021-0200	SATA Power Cable	170X000322

Appendix C

Peripheral Device Installation

C.1 PER-R41P (PER-R41P:PCle[x4] Adapter Kit) Installation

Note: Please follow these instructions and ensure the direction of adaptor kit corresponds to the below pictures prior to powering up de next-V2K8 board. Any installation error will cause critical damage to the de next-V2K8 board and/or adapter kit.

Step 1: Flip up the black plastic on the PER-R41P adapter card.

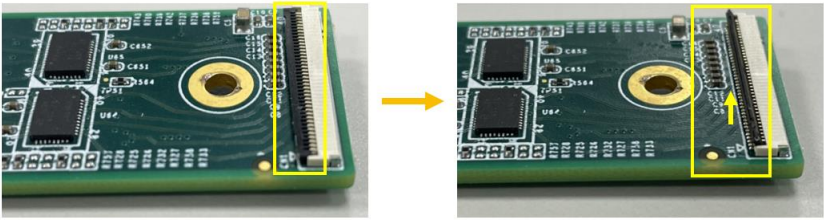

Step 2: Plug the FPC cable (GF1) into the connector, and flip down the black plastic.

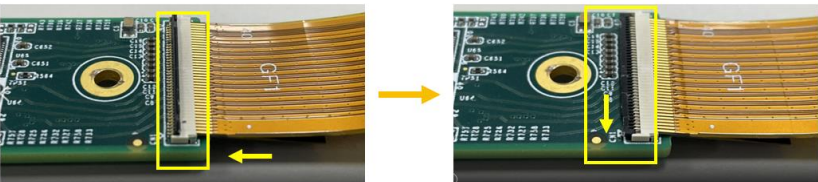

Step 3: Flip up the black plastic on the de next-V2K8 board.

Plug the FPC cable (GF2) into the connector on the de next-V2K8 board and flip down the black plastic to affix the FPC cable.

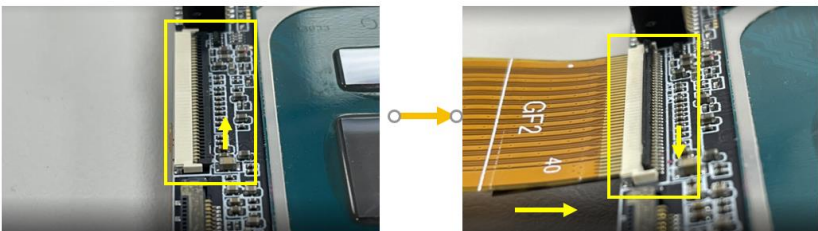

Step 4: Check the FPC Installation again before powering up the board.

(A) Top side:

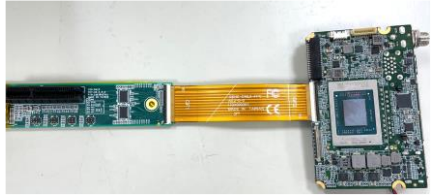

(B) Bottom Side:

