

Installation

This chapter describes how to set up the main board hardware, including instructions on setting jumpers and connecting peripherals, switches, and indicators. Be sure to read all the safety precautions before you begin the installation procedure.

Safety precautions

Warning! Always completely disconnect the power cord from your chassis whenever you are working on it. Do not make connections while the power is on because sensitive electronic components can be damaged by the sudden rush of power. Only experienced electronics personnel should open the PC chassis.



Caution! Always ground yourself to remove any static charge before touching the CPU card. Modern electronic devices are very sensitive to static electric charges. Use a grounding wrist strap at all times. Place all electronic components on a static-dissipative surface or in a static-shielded bag when they are not in the chassis.



Removing the CPU

The SBC-776 all-in-one CPU module supports most Pentium III/ Celeron or 586 CPUs. The system's performance depends on the CPU you choose. You can install or upgrade the CPU in the board's PGA socket by following the procedures outlined below. If your system has an existing CPU, you need to remove it before installing the new CPU.

Removing a CPU

1. Disconnect power from the chassis, and unplug all connections to the CPU card. Then, remove the CPU card from the chassis by following the instructions in the user's manual for your chassis.
2. Lift the CPU out of the PGA socket. The old chip may be difficult to remove. You may find spray chip lubricant, designed for pin-grid-array (PGA) devices, and a chip puller helpful. These are available at electronics hobbyists' supply stores.

Installing A CPU

To install the CPU, follow the instructions that came with it. If no documentation was provided, the general procedures for installing a CPU are outlined below:

1. Lubricate the pins on the CPU with lubricant for PGA devices. This makes the CPU slide in much easier and greatly reduces the chance of damaging the pins and other components.
2. Carefully align the CPU so that it is parallel to the socket. Make sure that the notch on the corner of the CPU matches the notch on the inside of the socket.
3. Gently push the CPU into the socket. There will probably be a small gap between the CPU and the socket even when it is fully seated. **DO NOT USE EXCESSIVE FORCE!**

When you install a new CPU, you may have to adjust other settings on the board, such as CPU type, CPU clock, and PCI speed, to accommodate it. Make sure that the settings are correct for your CPU. **Improper settings may damage the CPU.**

Installing DRAM (DIMMs)

System Memory

The SBC-776 contains three sockets for 168-pin dual inline memory module (DIMM). The socket uses 3.3 V unbuffered synchronous DRAM (SDRAM). DIMM is available in capacities of 16, 32, 64, 128 or 256 MB. The socket can be filled in the DIMM of any size, giving your SBC-776 single board computer between 16 and 512 MB of memory.

Supplementary information about DIMM

SBC-776 can accept PC-133 SDRAM DIMM Module(with or without parity).

Single-sided modules are typically 16 or 64 MB; double-sided modules are usually 32, 128 or 256 MB.

Memory Installation Procedures

To install DIMM, first make sure the two handles of the DIMM socket are in the "open" position. i.e. The handles remain outward. Slowly slide the DIMM module along the plastic guides on both ends of the socket. Then press the DIMM module right down into the socket, until you hear a click. This is when the two handles have automatically locked the memory module into the correct position of the DIMM socket. (See Figure below) To take away the memory module, just push both handles outward, and the memory module will be ejected by the mechanism in the socket.

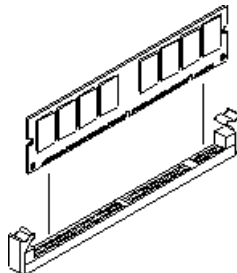

Jumpers

Jumpers	Function
JP1	VGA or AGP VGA Select Header
JP2	Clear CMOS Selection
JP3	Watchdog Function Select
JP4	RS-232/422/485 COM 2 Setting
JP5	DiskOnChip Address Selection
JP6	Function Select
JP7	CPU/DIMM Speed Select
JP8	LCD Panel's Voltage Setting
JP9	RS-232/422/485 COM2 Setting
JP10	LCD or VGA Enable Header

Connectors

Connector	Function
CN2,3,4	SDRAM Slot
CN5	AGP Slot
CN6	VGA Connector
CN7	Primary IDE Connector
CN8	Compact Flash
CN9,10	USB Dual Port Header
CN11	Audio Connector
CN12	Floppy Drive Connector
CN13	PS/2 Keyboard and Mouse Connector
CN14	Parallel Port Connector
CN15	COM 1 Serial Port
CN16	COM 2 Serial Port
CN20,22	LAN RJ-45 Connector
CN21	SCSI Connector
CN23	ATX Power Supply
CN24	Speaker/Buzzer
CN25	System FAN 1 Connector
CN26	CPU Fan Connector
CN27	System FAN 2 Connector
CN28	LCD Backlight Power Connector
CN29	TFT LCD Panel Connector
CN31	PS/2 Keyboard Header
CN32	PS/2 Mouse Header

Locating Jumpers and Connectors

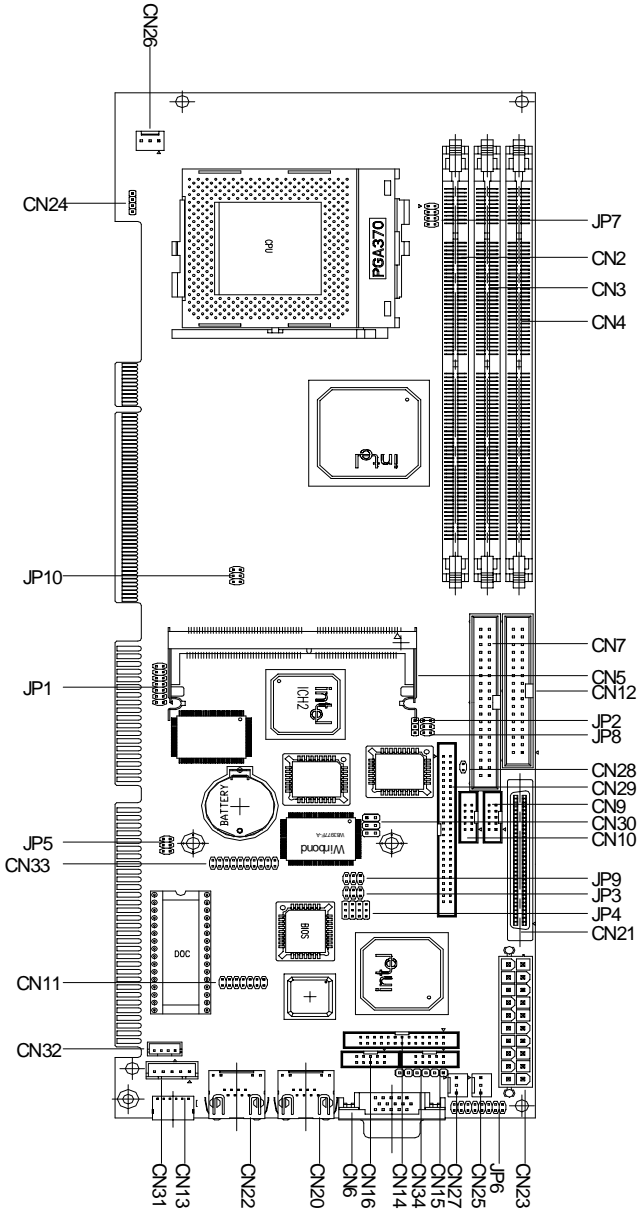

Locating Jumpers and Connectors

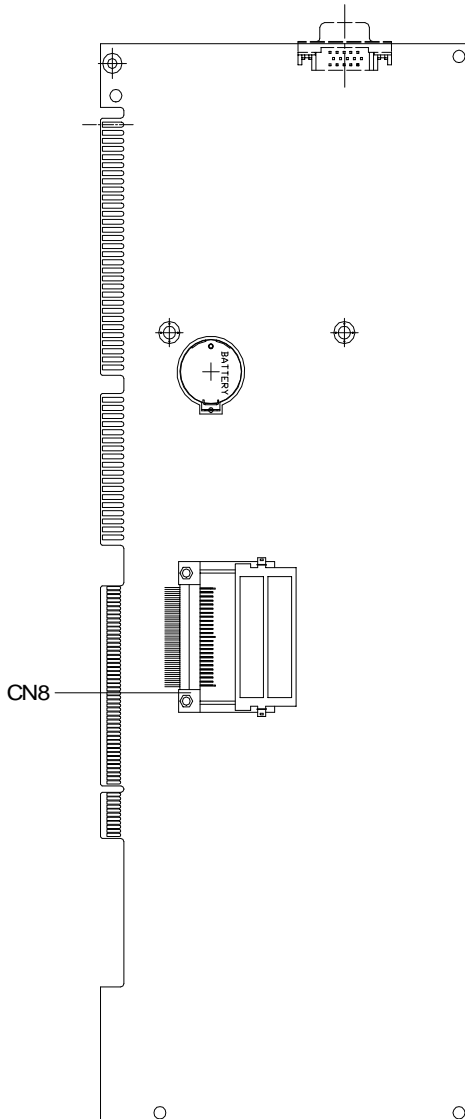

Mechanical Drawing

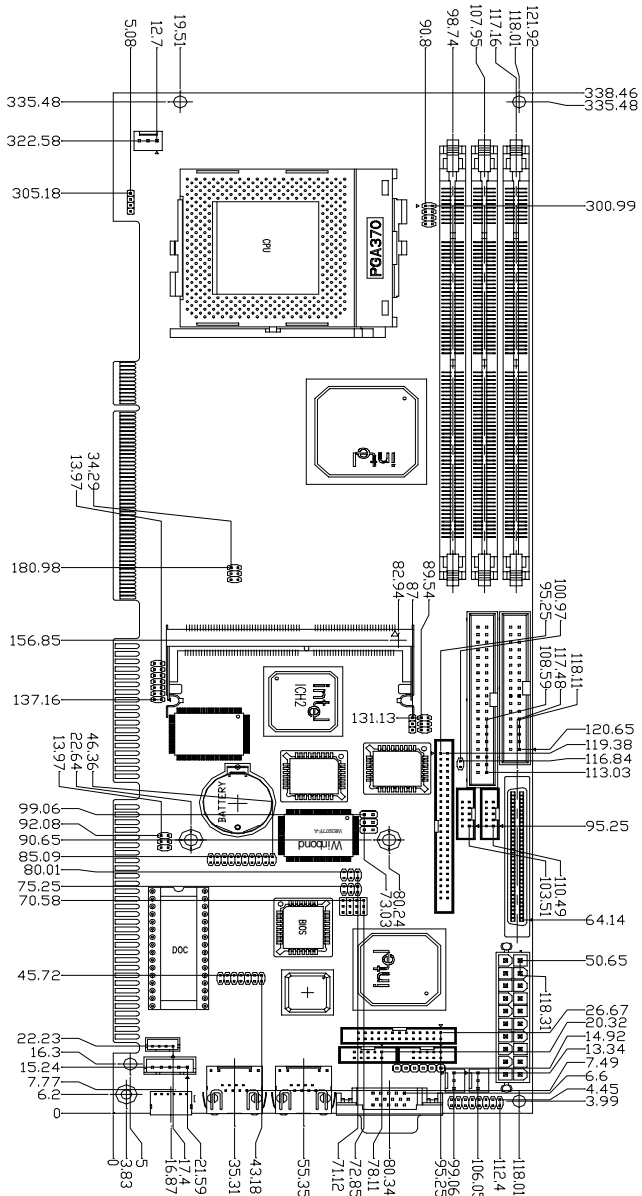

Mechanical Drawing

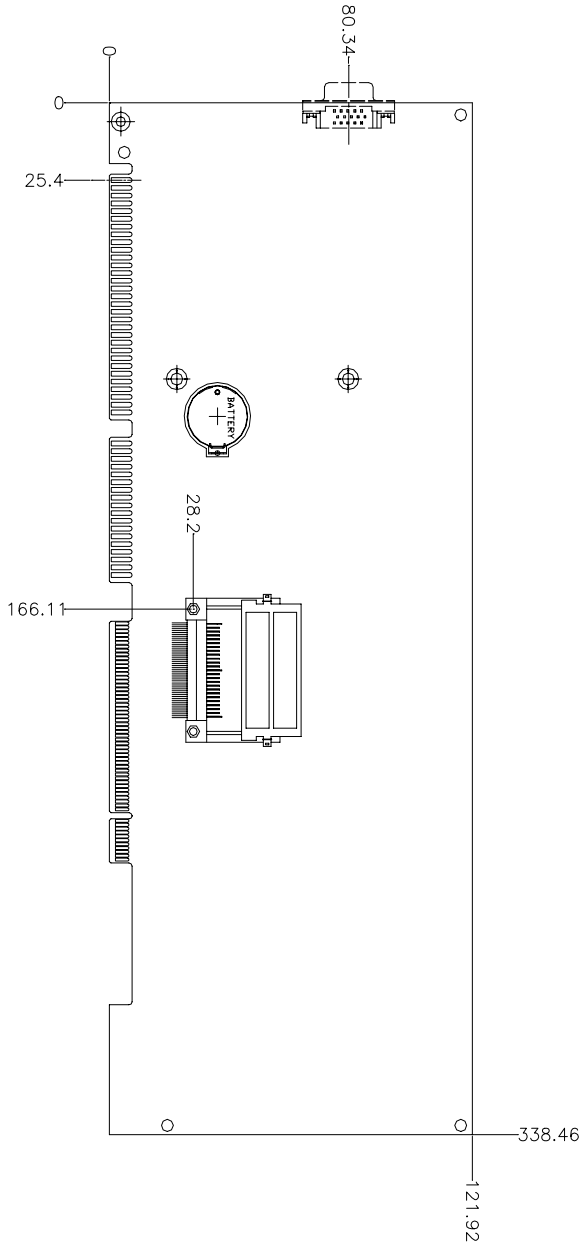

VGA or AGP VGA Header Select (JP 1)

Select AGP/VGA

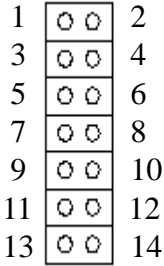

Select on board VGA

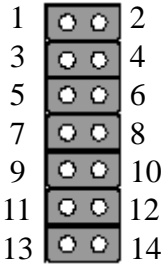

Clear CMOS (JP2)

You can use JP2 to clear the CMOS data if necessary. To reset the CMOS data, place a jumper on JP2 for just a few seconds, then remove the jumper.

Clear CMOS (JP2)

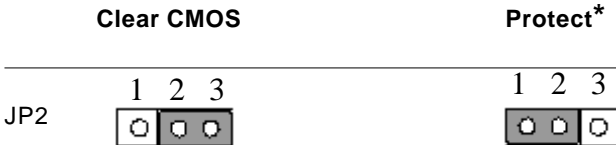

*default

Watchdog Timer Function Select (JP3)

The mainboard is equipped with a watchdog timer that resets the CPU or generates an interrupt if processing comes to a standstill for whatever reason. This feature ensures system reliability in industrial stand-alone and unmanned environments.

Reset

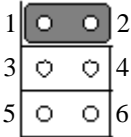

IRQ15

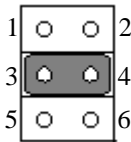

NMI

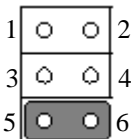

RS-232/422/485 COM 2 (JP4 & JP9) Setting

The SBC-776 COM 2 serial port can be selected as RS-232/422/485 by setting JP4.

*RS-232

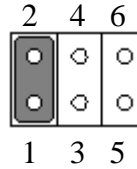
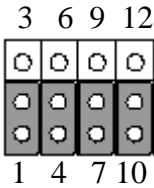

*RS-485

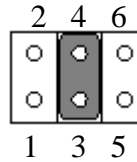
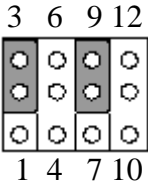

*RS-422

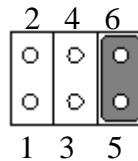
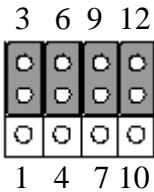

DiskOnChip Address Selection (JP5)

The DiskOnChip 2000 occupies an 8 Kbyte window in the upper memory address range of C800 to D400. You should ensure this does not conflict with any other device's memory address. JP5 controls the memory address of the Flash Disk.

*D400H

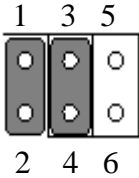

*DC00H

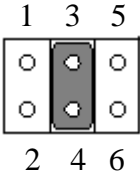

*CE00H

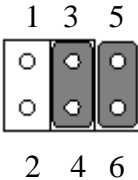

*D000H

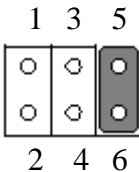

*E000H

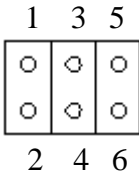

*DOC Disable

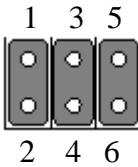

*D800H

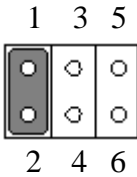

*C800H

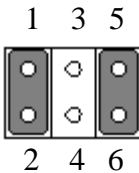

These addresses might conflict with the ROM BIOS of other peripheral boards, Please select the appropriate memory address to avoid memory conflicts.

Function Select Header (JP 6)









Next you may want to install external switches to monitor and control the mainboard. These features are completely optional — install them only if you need them. The front panel connector (JP6) is an 16-pin male, dual in-line header and provides connections for a speaker, hard disk access indicator and an input switch for resetting the card.

Speaker

The mainboard can drive an 8Ω external speaker at 0.5 watts. If there is no external speaker, the SBC-776 provides an onboard buzzer as an alternative.

LED interface

The front panel LED indicator for hard disk access is an active low signal (24 mA sink rate).

1		2	Power Button
3		4	Reset Switch
5		6	Suspend Switch
7		8	Hard Disk LED
9		10	Power LED
11		12	Suspend LED
13		14	SCSI LED
15		16	Chassis Open Detected

CPU/DIMM Speed Select Header (JP 7)

CPU/133 DIMM/133

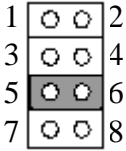

CPU/133 DIMM/100

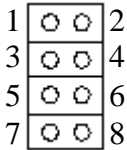

CPU/100 DIMM/100

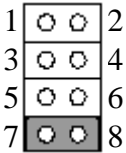

CPU/66 DIMM/100

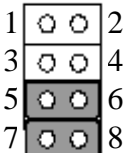

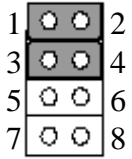

LCD Panel's Voltage Setting (JP 8)

*LCD Panel power: +5V; Backlight power: +5V

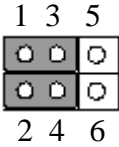

*LCD Panel power: +5V; Backlight power: +12V

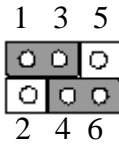

*LCD Panel power: +3.3V; Backlight power: +5V

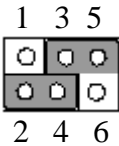

*LCD Panel power: +3.3V; Backlight power: +12V

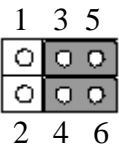

LCD or VGA Enable Header (JP10)

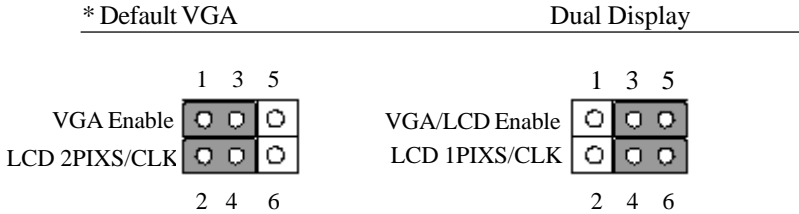

VGA connector (CN6)

The mainboard's PCI SVGA interface can drive conventional CRT displays and is capable of driving a wide range of flat panel displays, including electroluminescent (EL), gas plasma, passive LCD, and active LCD displays. The board has two connectors to support these displays, one for standard CRT VGA monitors and one for flat panel displays.

VGA display connector (CN6)

CN6 is a 15-pin, dual-in-line header used for conventional CRT displays. A simple one-to-one adapter can be used to match CN6 to a standard 15-pin D-SUB connector commonly used for VGA.

VGA display connector (CN6)			
Pin	Signal	Pin	Signal
1	RED	9	VCC
2	GREEN	10	GND
3	BLUE	11	N/C
4	N/C	12	DDDA
5	GND	13	H-SYNC
6	GND	14	V-SYNC
7	GND	15	DDCK
8	GND	16	N/C

IDE Hard Drive Connector (CN7)

IDE hard drive connector (CN7)

Pin	Signal	Pin	Signal
1	IDE RESET	2	GND
3	DATA 7	4	DATA 8
5	DATA 6	6	DATA 9
7	DATA 5	8	DATA 10
9	DATA 4	10	DATA 11
11	DATA 3	12	DATA 12
13	DATA 2	14	DATA 13
15	DATA 1	16	DATA 14
17	DATA 0	18	DATA 15
19	SIGNAL GND	20	N/C
21	IDEPDREQR	22	GND
23	IO WRITE	24	GND
25	IO READ	26	GND
27	IO CHANNEL READY	28	GND
29	IDEPDACKX	30	GND
31	IRQ14	32	IOCS16
33	ADDR 1	34	P66DET
35	ADDR 0	36	ADDR 2
37	HARD DISK SELECT 0	38	HARD DISK SELECT 1
39	IDE ACTIVE	40	MGND
41	VCC	42	VCC
43	GND	44	N/C

USB connector (CN9, CN10)

The SBC-776 provides two USB (Universal Serial Bus) interfaces, which give complete plug and play, hot attach/detach for up to 127 external devices. The USB interfaces comply with USB specification Rev. 1.0, and can be disabled in the system BIOS setup.

USB connector (CN9)

Pin	Function	Pin	Function
1	VCC	2	GND
3	USBD0-	4	GND
5	UDBD0+	6	USBD1+
7	GND	8	USBD1-
9	GND	10	VCC

USB connector (CN10)

Pin	Function	Pin	Function
1	VCC	2	GND
3	USBD2-	4	GND
5	USBD2+	6	USBD3+
7	GND	8	USBD3-
9	GND	10	VCC

Audio Connector (CN11)

On board SBC-776, there is a 14-pin header for audio capability. The pin definition is provided below.

Audio connector (CN 11)

Pin	Signal	Pin	Signal
1	MIC IN	2	MIC VCC
3	GND	4	CD IN GND
5	LINE IN L	6	CD IN L I/P
7	LINE IN R	8	CD N GND
9	GND	10	CD IN R I/P
11	LINE OUT L	12	LINE OUT R
13	GND	14	GND

Floppy Drive Connector (CN12)

Floppy drive connector (CN12)

Pin	Signal	Pin	Signal
1	GND	2	DENSITY SELECT
3	GND	4	N/C
5	GND	6	DRIVE TYPE
7	GND	8	INDEX
9	GND	10	MOTOR 0
11	GND	12	DRIVE SELECT 1
13	GND	14	DRIVE SELECT 2
15	GND	16	MOTOR 1
17	GND	18	DIRECTION
19	GND	20	STEP
21	GND	22	WRITE DATA
23	GND	24	WRITE GATE
25	GND	26	TRACK 0
27	GND	28	WRITE PROTECT
29	GND	30	READ DATA
31	GND	32	HEAD DELECT
33	GND	34	DISK CHANGE

PS/2 Keyboard and Mouse Connector (CN13)

On board SBC-776, there is a standard 6-pin header for PS/2 keyboard and mouse connector. The pin definition is provided below.

Keyboard and mouse connector (CN 13)

Pin	Signal	Pin	Signal
1	KB DATA	2	MS DATA
3	GND	4	VCC
5	KB CLOCK	6	MS CLOCK

Parallel port connector (CN14)

Normally, the parallel port is used to connect the board to a printer. The SBC-776 includes an onboard parallel port, accessed through CN14, a 26-pin flat-cable connector. A traditional DB-25 connector cable is needed to install the printer to the board. The cable has a 26-pin connector on one end and a DB-25 connector on the other.

Parallel port IRQ

The onboard parallel port is designated as LPT1 and can be disabled or changed to LPT2 or LPT3 in the system BIOS setup.

Parallel port connector table (CN14)

Parallel port connector (CN14)

Pin	Signal	Pin	Signal
1	/STB	2	D0
3	D1	4	D2
5	D3	6	D4
7	D5	8	D6
9	D7	10	/ACK
11	BUSY	12	PE
13	SLCT	14	/AUTOFD
15	/ERR	16	/INIT
17	/SLCTINI	18	GND
19	GND	20	GND
21	GND	22	GND
23	GND	24	GND
25	GND	26	N/C

COM 1 (CN 15) & COM 2 (CN 16) Serial Ports

On board offer four set serial ports for serial devices connection. Two of them are the D-Sub type, pin definition show as below, for another two, please refer to page ?.

COM 1 RS-232 (CN15)

Pin	Signal	Pin	Signal
1	SDCDB1X	6	SDSRB1X
2	SRXDB1	7	SRTSB1X
3	STXDB1	8	SCTSB1X
4	SDTRB1X	9	SRIB1X
5	GND	10	NC

COM 1 RS-232 (CN16)

Pin	Signal	Pin	Signal
1	SDCDB2X	6	SDSRB2X
2	SRXDB2	7	SRTSB2X
3	STXDB2	8	SCTSB2X
4	SDTRB2X	9	SRIB2X
5	GND	10	NC

SCSI-2 68-PinConnector (CN 21)

SBC-776 has a 68 pin connector for the Ultra 2 SCSI connection. Please pay attention when connecting the SCSI device, because you must determine the last device on the SCSI chain.

PIN	FUNCTION	PIN	FUNCTION
1	SD+12	35	SD-12
2	SD+13	36	SD-13
3	SD+14	37	SD-14
4	SD+15	38	SD-15
5	SDP+1	39	SDP-1
6	SD+0	40	SD-0
7	SD+1	41	SD-1
8	SD+2	42	SD-2
9	SD+3	43	SD-3
10	SD+4	44	SD-4
11	SD+5	45	SD-5
12	SD+6	46	SD-6
13	SD+7	47	SD-7
14	SDP + 0	48	SDP - 0
15	GND	49	GND
16	DIFS	50	SENIN
17	TPWEX	51	TPWEX
18	TPWEX	52	TPWEX
19	NC	53	NC
20	GND	54	GND
21	SATN+	55	SATN-
22	GND	56	GND
23	SBSY+	57	SBSY-
24	SACK+	58	SACK-
25	SRST+	59	SRST-
26	SMSG+	60	SMSG-
27	SSEL+	61	SSEL-
28	SCD +	62	SCD-
29	SREQ+	63	SREQ-
30	SIO+	64	SIO-
31	SD+8	65	SD-8
32	SD+9	66	SD-9
33	SD+10	67	SD-10
34	SD+11	68	SD-11

100Base-Tx LAN connector (CN22,20)

On board supports one standard RJ-45 connector for ethernet connection. The RJ-45 connector has two LED indicators. Both LED displays indicate the speed of information being processed, however the Lan speed does vary.

* The on board Intel 82559XX fast ethernet controller supports 10Mb/s and 100Mb/s N-way auto-negotiation operation.

Green LED: 100MLAN speed

Yellow LED: 10MLAN speed

100Base-Tx Ethernet connector (CN22)

Pin	Signal	Pin	Sig
1	Tx+	5	N/C
2	TX-	6	RX-
3	RX+	7	N/C
4	N/C	8	N/C

Green LED: 100MLAN speed

Yellow LED: 10MLAN speed

100Base-Tx Ethernet connector (CN20)

Pin	Signal	Pin	Sig
1	Tx+	5	N/C
2	TX-	6	RX-
3	RX+	7	N/C
4	N/C	8	N/C

Power connector (CN23)

ATX power connector (CN23)

The ATX power supply uses 20-pin connector shown below. Make sure you plug in the right direction.

ATX power connector (CN23)

Pin	Signal	Pin	Signal
1	+3.3V	11	+3.3V
2	+3.3V	12	-12V
3	GND	13	GND
4	+5V	14	POWER ON
5	GND	15	GND
6	+5 V	16	GND
7	GND	17	GND
8	POWER OK	18	-5V
9	+5VSB	19	+5V
10	+12V	20	+5V

Speaker/Buzzer (CN 24)

You can choose to use the internal buzzer on the SBC-776 board, or you may use your own external speaker.

Speaker/Buzzer (CN24)

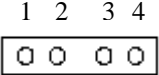
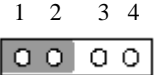
	Speaker	On Board Buzzer
CN24		

Fan power connectors (CN25, 26, 27)

CPU fan power connector (CN 26)

Plug in the fan cable to the 3-pin fan connector onboard. The fan connector is marked CN26.

CPU fan power connector (CN26)

Pin	Signal
1	GND
2	+12V
3	Fan speed sensor

System fan 1 connector (CN 25)

Pin	Signal
1	GND
2	+12V
3	Fan speed sensor

System fan 2 connector (CN27)

Pin	Signal
1	GND
2	+12V
3	Fan speed sensor

LCD Backlight Power Connector (CN 28)

LCD Backlight Power Connector (CN 28)

Pin	Signal
1	BLKVCC
2	GND

TFT LCD panel connector (CN 29)

LCD panel connector (CN 29)

Pin	Signal	Pin	Signal
1	BLKVCC	2	BLKVCC
3	GND	4	GND
5	LDCVCC	6	LCDVCC
7	ENAVEE	8	GND
9	P0	10	P1
11	P2	12	P3
13	P4	14	P5
15	P6	16	P7
17	P8	18	P9
19	P10	20	P11
21	P12	22	P13
23	P14	24	P15
25	P16	26	P17
27	P18	28	P19
29	P20	30	P21
31	P22	32	P23
33	P24	34	P25
35	SHFCLK	36	VSYNC
37	DE	38	HSYNC
39	GND	40	FPBLEN
41	P26	42	P27
43	P28	44	P29
45	P30	46	P31
47	P32	48	P33
49	P34	50	P35

PS/2 Keyboard Header (CN31)

Onboard there is a 5-pin header for keyboard connection, the pin definition is provided below.

PS/2 Keyboard Header (CN 31)

Pin	Signal	Pin	Signal
1	KB CLOCK	2	KB DATA
3	NC	4	GND
5	VCC		

PS/2 Mouse Header (CN 32)

Onboard there is a 4-pin header for keyboard connection, the pin definition is provided below.

PS/2 Mouse Header (CN 32)

Pin	Signal	Pin	Signal
1	MS CLOCK	2	MS DATA
3	GND	4	VCC
