

**POP-150 G5**

Intel® Atom N270

1.6GHz Processor

Point of Promotion Panel PC

With 15" 4:3 TFT LCD

## **Copyright Notice**

This document is copyrighted, 2009. All rights are reserved. The original manufacturer reserves the right to make improvements to the products described in this manual at any time without notice.

No part of this manual may be reproduced, copied, translated, or transmitted in any form or by any means without the prior written permission of the original manufacturer. Information provided in this manual is intended to be accurate and reliable. However, the original manufacturer assumes no responsibility for its use, or for any infringements upon the rights of third parties that may result from its use.

The material in this document is for product information only and is subject to change without notice. While reasonable efforts have been made in the preparation of this document to assure its accuracy, AAEON assumes no liabilities resulting from errors or omissions in this document, or from the use of the information contained herein.

AAEON reserves the right to make changes in the product design without notice to its users.

## Acknowledgments

All other products' name or trademarks are properties of their respective owners.

- Award is a trademark of Award Software International, Inc.
- VIA is a trademark of VIA Technologies, Inc.
- RTL is a trademark of Realtek Semi-Conductor Co., Ltd.
- Intel<sup>®</sup> and Celeron<sup>®</sup> are trademarks of Intel<sup>®</sup> Corporation.
- Microsoft Windows<sup>®</sup> is a registered trademark of Microsoft Corp.
- IBM, PC/AT, PS/2, and VGA are trademarks of International Business Machines Corporation.
- ESS is a trademark of ESS Technology, Inc.
- UMC is a trademark of United Microelectronics Corporation.
- SMI is a trademark of Silicon Motion, Inc.
- Creative is a trademark of Creative Technology LTD.

**All other product names or trademarks are properties of their respective owners.**

## Packing List

Before you begin operating your PC, please make sure that the following materials are enclosed:

- 1 POP-150 G5 Panel PC
- 1 PS/2 Y type keyboard / mouse cable
- 1 CD-ROM for manual (in PDF format)

If any of these items should be missing or damaged, please contact your distributor or sales representative immediately.

## Safety & Warranty

1. Read these safety instructions carefully.
2. Keep this user's manual for later reference.
3. Disconnect this equipment from any AC outlet before cleaning. Do not use liquid or spray detergents for cleaning. Use a damp cloth.
4. For pluggable equipment, the power outlet must be installed near the equipment and must be easily accessible.
5. Keep this equipment away from humidity.
6. Put this equipment on a firm surface during installation. Dropping it or letting it fall could cause damage.
7. The openings on the enclosure are for air convection. Protect the equipment from overheating. **DO NOT COVER THE OPENINGS.**
8. Make sure the voltage of the power source is correct before connecting the equipment to the power outlet.
9. Position the power cord so that people cannot step on it. Do not place anything over the power cord.
10. All cautions and warnings on the equipment should be noted.
11. If the equipment is not used for a long time, disconnect it from the power source to avoid damage by transient over-voltage.
12. Never pour any liquid into an opening. This could cause fire or electrical shock.
13. Never open the equipment. For safety reasons, only qualified service personnel should open the equipment.
14. If any of the following situations arises, get the equipment checked by service personnel:
  - a. The power cord or plug is damaged.
  - b. Liquid has penetrated into the equipment.
  - c. The equipment has been exposed to moisture.

- d. The equipment does not work well, or you cannot get it to work according to the user's manual.
  - e. The equipment has been dropped and damaged.
  - f. The equipment has obvious signs of breakage.
15. DO NOT LEAVE THIS EQUIPMENT IN AN ENVIRONMENT WHERE THE STORAGE TEMPERATURE IS BELOW -20°C (-4°F) OR ABOVE 60°C (140°F). IT MAY DAMAGE THE EQUIPMENT.

## FCC

### **Warning!**



This device complies with Part 15 FCC Rules. Operation is subject to the following two conditions: (1) this device may not cause harmful interference, and (2) this device must accept any interference received including interference that may cause undesired operation.

### **Caution:**

*There is a danger of explosion if the battery is incorrectly replaced. Replace only with the same or equivalent type recommended by the manufacturer. Dispose of used batteries according to the manufacturer's instructions and your local government's recycling or disposal directives.*

## Below Table for China RoHS Requirements

产品中有毒有害物质或元素名称及含量

## AAEON Panel PC/ Workstation

部件名称	有毒有害物质或元素					
	铅 (Pb)	汞 (Hg)	镉 (Cd)	六价铬 (Cr(VI))	多溴联苯 (PBB)	多溴二苯醚 (PBDE)
印刷电路板 及其电子组件	×	○	○	○	○	○
外部信号 连接器及线材	×	○	○	○	○	○
外壳	×	○	○	○	○	○
中央处理器 与内存	×	○	○	○	○	○
硬盘	×	○	○	○	○	○
液晶模块	×	○	○	○	○	○
光驱	×	○	○	○	○	○
触控模块	×	○	○	○	○	○
电源	×	○	○	○	○	○

**O:** 表示该有毒有害物质在该部件所有均质材料中的含量均在  
SJ/T 11363-2006 标准规定的限量要求以下。

**X:** 表示该有毒有害物质至少在该部件的某一均质材料中的含量超出  
SJ/T 11363-2006 标准规定的限量要求。

备注:

- 一、此产品所标示之环保使用期限，系指在一般正常使用状况下。
- 二、上述部件物质中央处理器、内存、硬盘、光驱、触控模块为选购品。

# Contents

## Chapter 1 General Information

1.1 Introduction.....	1-2
1.2 Specification .....	1-3
1.3 Dimension .....	1-5

## Chapter 2 Hardware Installation

2.1 Open-frame Mounting Installation.....	2-2
2.2 COM 1/2 Connector .....	2-3

## Chapter 3 Award BIOS set up

3.1 System Test and Initialization .....	3-2
3.2 Award BIOS Setup .....	3-3

## Chapter 4 Driver Installation

4.1 Installation .....	4-3
------------------------	-----



Chapter

1

**General  
Information**

## **1.1 Introduction**

---

The POP-150 G5 Point of Promotion Panel PC is an Intel® Atom N270 1.6GHz processor computer that is designed to serve as a Digital signage market. It is a PC-based system with 15" color TFT LCD display, onboard Ethernet controller, multi-COM port interfaces and an audio controller. With a built-in Compact Flash socket, the POP-150 G5 is as compact and user friendly as a multi-function computer. In addition, its Open-frame design makes it fitted to a variety of cutout installation in building & public field. In addition, it can be wall mounted or DIN Rail mounted.

For system integrators, this simple, complete, compact and highly integrated system let you easily build a point of promotion into your applications. Common industrial applications include factory automation systems, precision machinery, and production process control. It is also suitable for many non-industrial applications, including vending machine, and car park automation. Our point of promotion panel pc is a reliable & cost-effective solution to your daily business.

## 1.2 Specification

---

### **System**

- CPU Onboard Intel® Atom N270 1.6GHz Processor
- System Memory 512MB, up to 2GB DDRII SDRAM
- LCD / CRT Controller Intel® 945 GSE
- Ethernet 10/100/1000Base-TX RJ-45 connector x 2 (Optional)
- I/O Port RS-232 x 1, RS-232/422/485 x 1; USB2.0 x 2; Audio Line-out x 1; PS/2 x 1 (keyboard + Mouse Mini-DIN)
- Storage Disk Drive 2.5" Hard Disk Drive Bay/ Type II Compact Flash™ slot (Internal)
- OS Support Windows® XP, Windows® XP Embedded

### **Mechanical**

- Construction Open frame
- Front Panel Color SGCC metal color
- Mounting VESA 100/75
- Dimension 15" (W) x 11.61" (H) x 2.36" (D) (382mm x 295mm x 60mm)

- Net Weight 13.2 lb (6Kg)
- Gross Weight 15.4 lb (7Kg)

### ***Environmental***

- Operating Temperature 32°F~104°F (0°C~40°C);
- Storage Temperature -4°F ~140°F (-20°C~60°C)
- Operating Humidity 10 to 90%@40°C, non-condensing
- EMC CE/FCC Class A

### ***Power Supply***

- DC-DC input Input Range: 9~30V DC

### ***LCD***

- Display Type 15" Color TFT LCD
- Max. Resolution 1024 x 768
- Max. Colors 16.7M
- Dot Size 0.297 mm x 0.297 mm
- Luminance 250 nits
- Viewing Angle 150° (H) x 140° (V)
- Backlight MTBF 30,000 Hours

### ***Touch Screen***

- Type 5-wire, analog resistive
- Resolution 2048 x 2048
- Light Transmission 80%
- Lifetime 35 million activations

**Note:** All AAEON's LCD products are manufactured with High precision technology. However, in all LCD panels there maybe a small number of defective pixels that do not change color. This is a normal occurrence for all LCD displays from all manufacturers and should not be noticeable or objectionable under normal operation. AAEON qualify the LCD panel following industry standard: total 7 dead pixels on a screen or if there are 3 within 1 inch square area of each other on the display.

### 1.3 Dimension

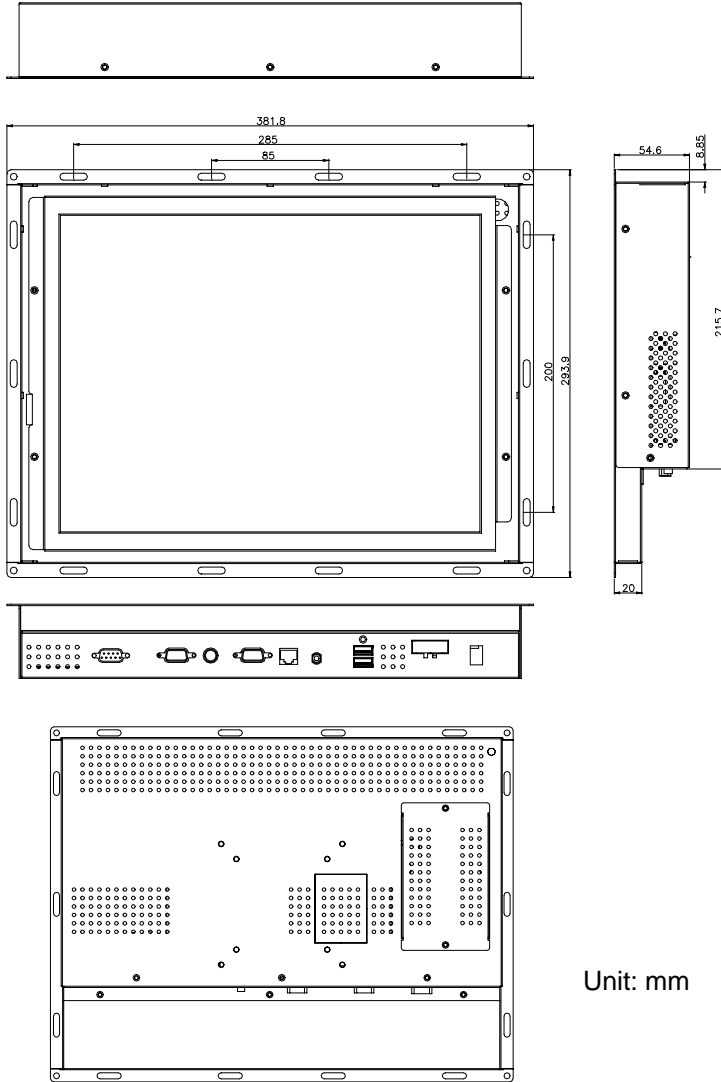

Unit: mm

Chapter

2

# Hardware Installation

## 2.1 Open-frame Mounting Installation

---

The display panel can be mounted into the wall. You will need at least 4 screws and Follow the steps below:

Step 1: Prepare required screws on the wall as the hole for mounting on the Bezel of Panel PC

Step 2: Place the panel PC onto the wall

Step 3: Screws the nuts and fix the unit

**Note:** User can consider putting a glasses or Acrylic panel between Panel PC and Wall for protection of Screen.

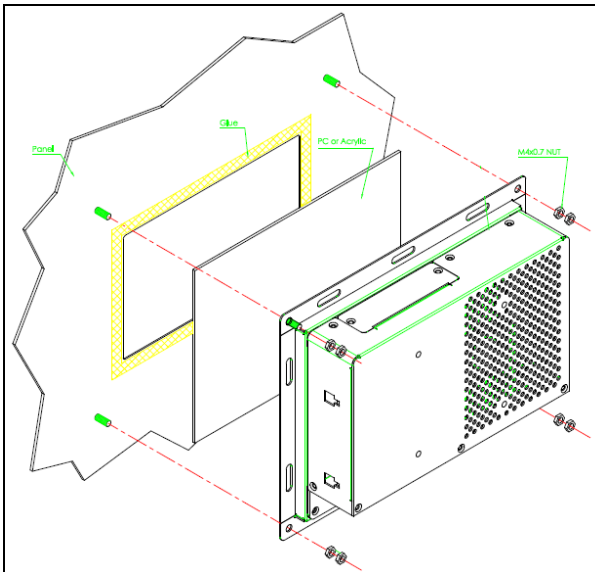



## 2.2 COM 1 / 2 Connector

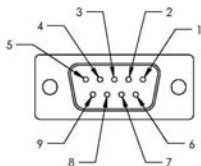

Pin	Signal	Pin	Signal
1	DCD1	2	RXD1
3	TXD1	4	DTR1
5	GND	6	DSR1
7	RTS1	8	CTS1
9	RI1		

### COM2/ RS-422 Mode

Pin	Signal	Pin	Signal
1	TXD-	2	RXD+
3	TXD+	4	RXD-
5	Ground	6	N/C
7	N/C	8	N/C
9	N/C	10	N/C

### COM2/ RS-485 Mode

Pin	Signal	Pin	Signal
1	TXD-	2	N/C
3	TXD+	4	N/C
5	Ground	6	N/C
7	N/C	8	N/C
9	N/C	10	N/C

Chapter

3

# Award BIOS Setup

### 3.1 System Test and Initialization

---

These routines test and initialize board hardware. If the routines encounter an error during the tests, you will either hear a few short beeps or see an error message on the screen. There are two kinds of errors: fatal and non-fatal. The system can usually continue the boot up sequence with non-fatal errors. Non-fatal error messages usually appear on the screen along with the following instructions:

Press <F1> to RESUME

Write down the message and press the F1 key to continue the boot up sequence.

#### **System configuration verification**

These routines check the current system configuration against the values stored in the CMOS memory. If they do not match, the program outputs an error message. You will then need to run the BIOS setup program to set the configuration information in memory.

There are three situations in which you will need to change the CMOS settings:

1. You are starting your system for the first time
2. You have changed the hardware attached to your system
3. The CMOS memory has lost power and the configuration information has been erased.

The POP-150 G5 CMOS memory has an integral lithium battery backup for data retention. However, you will need to replace the complete unit when it finally runs down.

## 3.2 Award BIOS Setup

---

Awards BIOS ROM has a built-in Setup program that allows users to modify the basic system configuration. This type of information is stored in battery-backed CMOS RAM so that it retains the Setup information when the power is turned off.

### Entering Setup

Power on the computer and press <Del> immediately. This will allow you to enter Setup.

### Standard CMOS Features

Use this menu for basic system configuration. (Date, time, IDE, etc.)

### Advanced BIOS Features

Use this menu to set the advanced features available on your system.

### Advanced Chipset Features

Use this menu to change the values in the chipset registers and optimize your system performance.

### Integrated Peripherals

Use this menu to specify your settings for integrated peripherals. (Primary slave, secondary slave, keyboard, mouse etc.)

### Power Management Setup

Use this menu to specify your settings for power management. (HDD power down, power on by ring, KB wake up, etc.)

### PnP/PCI Configurations

This entry appears if your system supports PnP/PCI.

## **PC Health Status**

This menu allows you to set the shutdown temperature for your system.

## **Frequency/Voltage Control**

Use this menu to specify your settings for auto detect DIMM/PCI clock and spread spectrum.

## **Load Fail-Safe Defaults**

Use this menu to load the BIOS default values for the minimal/stable performance for your system to operate.

## **Load Optimized Defaults**

Use this menu to load the BIOS default values that are factory settings for optimal performance system operations. While AWARD has designated the custom BIOS to maximize performance, the factory has the right to change these defaults to meet their needs.

## **Set Supervisor/User Password**

Use this menu to set Supervisor/User Passwords.

## **Save and Exit Setup**

Save CMOS value changes to CMOS and exit setup.

## **Exit Without Saving**

Abandon all CMOS value changes and exit setup.

**You can refer to the "AAEON BIOS Item Description.pdf" file in the CD for the meaning of each setting in this chapter.**

Chapter

4

# Driver Installation

There are several installation ways depending on the driver package under different Operating System application. The Autorun program will run automatically. However, if the Autorun program cannot be run smoothly, please follow the sequence below to install the drivers:

Step 1 - INF Update Utility v8.2.0.1014 Installation

Step 2 - Intel Graphics Media Accelerator Driver Installation

Step 3 - Intel Ethernet Driver Installation

Step 4 - Realtek ALC655 Audio Driver v3.71 Installation

Step 5 - PenMount 6300 Touch Driver Installation

USB 2.0 Drivers are available for download using Windows Update for both Windows XP and Windows 2000. For additional information regarding USB 2.0 support in Windows XP and Windows 2000, please visit [www.microsoft.com/hwdev/usb/](http://www.microsoft.com/hwdev/usb/).

For installation procedures of each driver, you may see the details in the following.

## 4.1 Installation

---

Insert the POP-150 G5 CD-ROM into the CD-ROM drive and install the drivers from Step 1 to Step 5 in order.

Step 1 – INF Update Utility v8.2.0.1014

1. Click on the **Step 1- INF Update Utility v8.2.0.1014** folder
2. Double click on **Setup.exe**
3. Follow the instructions that the window shows
4. The system will help you install the driver automatically

Step 2 – Intel Graphics Media Accelerator Driver

1. Click on the **Step 2 – Intel Graphics Media Accelerator Driver** folder
2. Select the OS your system is
3. Double click on **Setup.exe**
4. Follow the instructions that the window shows
5. The system will help you install the driver automatically

Step 3 –Intel Ethernet Driver

1. Click on the **Step 3 –Intel Ethernet Driver** folder
2. Select the OS your system is
3. Double click on **.exe** file
4. Follow the instructions that the window shows
5. The system will help you install the driver automatically



Step 4 –Realtek ALC655 Audio Driver v3.71

1. Click on the **Step 4 – Realtek ALC655 Audio Driver v3.71** folder
2. Select the OS your system is
3. Double click on **setup.exe**
4. Follow the instructions that the window shows
5. The system will help you install the driver automatically

Step 5 – PenMount 6300 Touch Driver

1. Click on the **Step 5 – PenMount 6300 Touch Driver** folder
2. double click on **Setup.exe**
3. Follow the instructions that the window shows
4. The system will help you install the driver automatically