

PICO-KBU4

PICO-KBU4 Single-Board Computer

User's Manual 5th Ed

Copyright Notice

This document is copyrighted, 2020. All rights are reserved. The original manufacturer reserves the right to make improvements to the products described in this manual at any time without notice.

No part of this manual may be reproduced, copied, translated, or transmitted in any form or by any means without the prior written permission of the original manufacturer. Information provided in this manual is intended to be accurate and reliable. However, the original manufacturer assumes no responsibility for its use, or for any infringements upon the rights of third parties that may result from its use.

The material in this document is for product information only and is subject to change without notice. While reasonable efforts have been made in the preparation of this document to assure its accuracy, AAEMON assumes no liabilities resulting from errors or omissions in this document, or from the use of the information contained herein.

AAEMON reserves the right to make changes in the product design without notice to its users.

Acknowledgement

All other products' name or trademarks are properties of their respective owners.

- Microsoft Windows® is a registered trademark of Microsoft Corp.
- ITE is a trademark of Integrated Technology Express, Inc.
- IBM, PC/AT, PS/2, and VGA are trademarks of International Business Machines Corporation.

All other product names or trademarks are properties of their respective owners.

Packing List

Before setting up your product, please make sure the following items have been shipped:

Item	Quantity
● PICO-KBU4	1

If any of these items are missing or damaged, please contact your distributor or sales representative immediately.

About this Document

This User's Manual contains all the essential information, such as detailed descriptions and explanations on the product's hardware and software features (if any), its specifications, dimensions, jumper/connector settings/definitions, and driver installation instructions (if any), to facilitate users in setting up their product.

Users may refer to the product page at AAEON.com for the latest version of this document.

Safety Precautions

Please read the following safety instructions carefully. It is advised that you keep this manual for future references

1. All cautions and warnings on the device should be noted.
2. Make sure the power source matches the power rating of the device.
3. Position the power cord so that people cannot step on it. Do not place anything over the power cord.
4. Always completely disconnect the power before working on the system's hardware.
5. No connections should be made when the system is powered as a sudden rush of power may damage sensitive electronic components.
6. If the device is not to be used for a long time, disconnect it from the power supply to avoid damage by transient over-voltage.
7. Always disconnect this device from any AC supply before cleaning.
8. While cleaning, use a damp cloth instead of liquid or spray detergents.
9. Make sure the device is installed near a power outlet and is easily accessible.
10. Keep this device away from humidity.
11. Place the device on a solid surface during installation to prevent falls
12. Do not cover the openings on the device to ensure optimal heat dissipation.
13. Watch out for high temperatures when the system is running.
14. Do not touch the heat sink or heat spreader when the system is running
15. Never pour any liquid into the openings. This could cause fire or electric shock.
16. As most electronic components are sensitive to static electrical charge, be sure to ground yourself to prevent static charge when installing the internal components. Use a grounding wrist strap and contain all electronic components in any static-shielded containers.

17. If any of the following situations arises, please the contact our service personnel:
 - i. Damaged power cord or plug
 - ii. Liquid intrusion to the device
 - iii. Exposure to moisture
 - iv. Device is not working as expected or in a manner as described in this manual
 - v. The device is dropped or damaged
 - vi. Any obvious signs of damage displayed on the device
18. **DO NOT LEAVE THIS DEVICE IN AN UNCONTROLLED ENVIRONMENT WHERE THE STORAGE TEMPERATURE IS BELOW -20° C (-4°F) OR ABOVE 60°C (140°F) TO PREVENT DAMAGE.**

Warning!



This device complies with Part 15 FCC Rules. Operation is subject to the following two conditions: (1) this device may not cause harmful interference, and (2) this device must accept any interference received including interference that may cause undesired operation.

Caution:

There is a danger of explosion if the battery is incorrectly replaced. Replace only with the same or equivalent type recommended by the manufacturer. Dispose of used batteries according to the manufacturer's instructions and your local government's recycling or disposal directives.

Attention:

Il y a un risque d'explosion si la batterie est remplacée de façon incorrecte. Ne la remplacer qu'avec le même modèle ou équivalent recommandé par le constructeur. Recycler les batteries usées en accord avec les instructions du fabricant et les directives gouvernementales de recyclage.

China RoHS Requirements (CN)

产品中有毒有害物质或元素名称及含量

AAEON Main Board/ Daughter Board/ Backplane

部件名称	有毒有害物质或元素					
	铅 (Pb)	汞 (Hg)	镉 (Cd)	六价铬 (Cr(VI))	多溴联苯 (PBB)	多溴二苯醚 (PBDE)
印刷电路板 及其电子组件	○	○	○	○	○	○
外部信号 连接器及线材	○	○	○	○	○	○
<p>O: 表示该有毒有害物质在该部件所有均质材料中的含量均在 SJ/T 11363-2006 标准规定的限量要求以下。</p> <p>X: 表示该有毒有害物质至少在该部件的某一均质材料中的含量超出 SJ/T 11363-2006 标准规定的限量要求。</p> <p>备注: 此产品所标示之环保使用期限, 系指在一般正常使用状况下。</p>						

China RoHS Requirement (EN)

Poisonous or Hazardous Substances or Elements in Products

AAEON Main Board/ Daughter Board/ Backplane

Component	Poisonous or Hazardous Substances or Elements					
	Lead (Pb)	Mercury (Hg)	Cadmium (Cd)	Hexavalent Chromium (Cr(VI))	Polybrominated Biphenyls (PBB)	Polybrominated Diphenyl Ethers (PBDE)
PCB & Other Components	○	○	○	○	○	○
Wires & Connectors for External Connections	○	○	○	○	○	○
<p>O: The quantity of poisonous or hazardous substances or elements found in each of the component's parts is below the SJ/T 11363-2006-stipulated requirement.</p> <p>X: The quantity of poisonous or hazardous substances or elements found in at least one of the component's parts is beyond the SJ/T 11363-2006-stipulated requirement.</p> <p>Note: The Environment Friendly Use Period as labeled on this product is applicable under normal usage only</p>						

Table of Contents

Chapter 1 - Product Specifications	1
1.1 Specifications	2
Chapter 2 – Hardware Information	5
2.1 Dimensions	6
2.2 Jumpers and Connectors.....	8
2.3 List of Jumpers	10
2.3.1 LVDS Backlight Lightness Control Mode Selection (JP3).....	10
2.3.2 LVDS Operating Voltage Selection (JP4).....	10
2.3.3 LVDS Backlight Inverter Voltage Selection (JP4).....	11
2.3.4 Clear CMOS Jumper (JP5).....	11
2.3.5 Auto Power Button Enable/Disable Selection (JP5).....	11
2.4 List of Connectors.....	12
2.4.1 RTC Battery Connector (CN1).....	13
2.4.2 HDMI (CN2)	13
2.4.3 LVDS Inverter / Backlight Connector (CN4)	15
2.4.4 LVDS Port (CN5).....	16
2.4.5 LAN (RJ-45) Port1 (CN6).....	18
2.4.6 LAN (RJ-45) Port2 (CN7)	19
2.4.7 Digital IO Port (CN9).....	20
2.4.8 USB 2.0 Port 1/2 (CN10).....	21
2.4.9 USB 2.0/3.0 Port 3 Port 3/4 (CN11)	22
2.4.10 External +12V Input (CN14).....	23
2.4.11 Front Panel Port (CN15)	23
2.4.12 COM Port1/ COM Port2 (CN16).....	24
2.4.13 BIO Bank1 Connector (CN17).....	26
2.4.14 LPC Port (CN19).....	30

2.4.15	SATA Port (CN20).....	31
2.4.16	+5V Output for SATA HDD (CN21).....	31
2.4.17	M.2 (Key B) Connector (CN26)	32
2.4.18	Smart FAN Connector (CN27).....	35
2.4.19	M.2 (Key E) Connector (CN30).....	35
2.4.20	DDR4 SO-DIMM Slot (DIMM1).....	38
2.5	Function Block.....	39
2.6	Assembly Options	40
Chapter 3 - AMI BIOS Setup		42
3.1	System Test and Initialization	43
3.2	AMI BIOS Setup	44
3.3	Setup Submenu: Main	45
3.4	Setup Submenu: Advanced.....	46
3.4.1	CPU configuration	47
3.4.2	SATA Configuration	48
3.4.3	Hardware Monitor	49
3.4.3.1	CPU Smart Fan Mode Configuration	50
3.4.4	SIO Configuration.....	51
3.4.4.1	Serial Port Configuration	52
3.4.5	USB Configuration	53
3.4.6	Digital IO Port Configuration	54
3.4.7	Power management.....	55
3.4.8	Firmware Update Configuration	56
3.5	Setup Submenu: Chipset	57
3.5.1	System Agent (SA) Configuration	58
3.5.1.1	Graphics Configuration.....	59
3.5.2	PCH-IO Configuration	62
3.6	Setup Submenu: Security.....	64

3.6.1	Secure Boot.....	65
3.6.1.1	Key Management.....	66
3.7	Setup Submenu: Boot.....	68
3.7.1	BBS Priorities.....	69
3.8	Setup Submenu: Exit.....	70
Chapter 4 – Drivers Installation.....		71
4.1	Driver Download/Installation.....	72
Appendix A - I/O Information.....		74
A.1	I/O Address Map.....	75
A.2	Memory Address Map.....	76
A.3	IRQ Mapping Chart.....	77
Appendix B – Mating Connectors.....		78
B.1	List of Mating Connectors and Cables.....	79

Chapter 1

Product Specifications

1.1 Specifications

System

Form Factor	Pico-ITX
CPU	7th Generation Intel® Core™ U-series processors: Intel® Core™ i7-7600U, i5-7300U, i3-7100U Celeron® 3965U (optional)
CPU Frequency	Up to 3.9/2.8 GHz
Chipset	7th Generation Intel® Core™ U-series processors: Intel® Core™ i7-7600U, i5-7300U, i3-7100U Celeron® 3965U (optional)
Memory Type	DDR4 1866/2133MHz SODIMM x 1, Max 16 GB
Max. Memory Capacity	Up to 16 GB
BIOS	AMI/SPI
Wake On LAN	Yes
Watchdog Timer	255 Levels
Power Requirement	+12V AT/ATX (default)
Power Supply Type	AT/ATX (default)
Power Consumption (Typical)	i7-7600@DDR4 16GB, 12V@2.3A
System Cooling	Heat-spreader, heatsink & cooler (Smart FAN) optional
Dimension	3.94" x 2.84" (100mm x 72mm)

System

Gross Weight	0.55 lbs. (0.25 kg)
Operating Temperature	32°F ~ 140°F (0°C ~ 60°C)
Storage Temperature	-40°F ~ 176°F (-40°C ~ 80°C)
Operating Humidity	0% ~ 90% relative humidity, non-condensing
MTBF (Hours)	163,000
Certification	CE, FCC

Display

Chipset	7th Generation Intel® Core™ U-series processors: Intel® Core™ i7-7600U, i5-7300U, i3-7100U Celeron® 3965U (optional)
Resolution	LVDS (18/24-bit 2CH) 1920 x 1200 HDMI 1.4b up to 4096 x 2304 (4K) DDI (BIO)
LCD Interface	18/24-bit 2CH LVDS

I/O

Storage/SSD	SATA 6.0 Gb/s x 1, M.2 B-key (2242)
Ethernet	Realtek 8111G Gigabit Ethernet 10/100/1000Base-TX, RJ-45 x 2
USB Port	USB 3.0 x 2 Rear I/O USB 2.0 x 2 Pin header

I/O

Serial Port	COM1: RS-232 x 1 COM2: RS-232/422/485 x 1 (Ring/ +5V/ +12V)
Audio	Line-out x1
DIO	4-bit (2-in, 2-out)
Expansion Slot	M.2 E-Key (2230) BIO (optional) I2C x 1 or SMBus x 1
SIM	—
TPM	—
Touch	—

Chapter 2

Hardware Information

2.1 Dimensions

Component Side

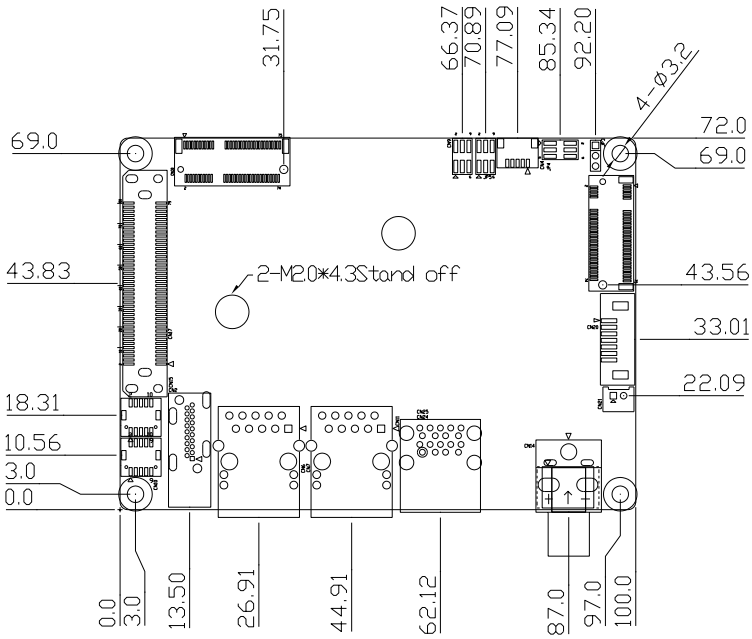

Component Side

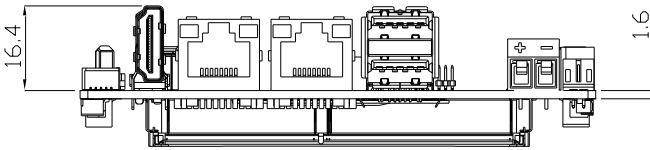

Solder Side

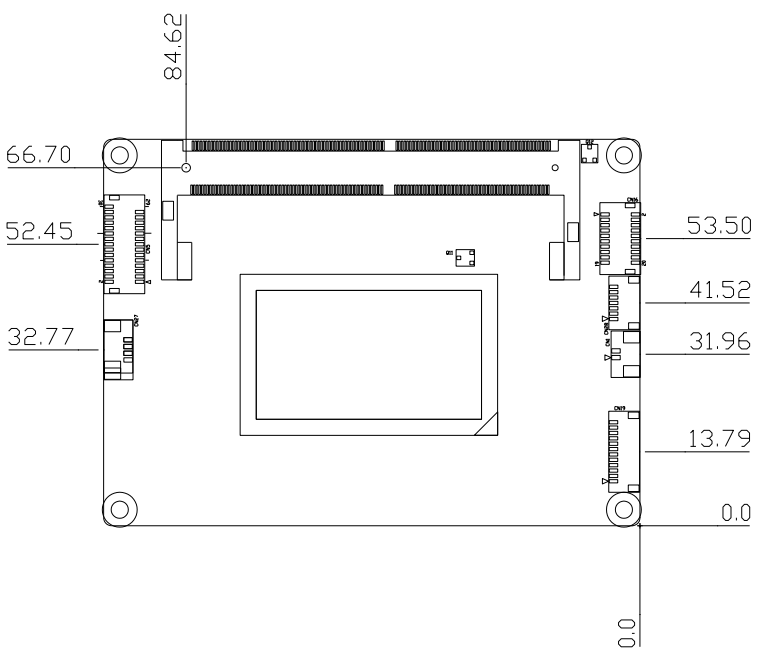

Solder Side

2.2 Jumpers and Connectors

Component Side

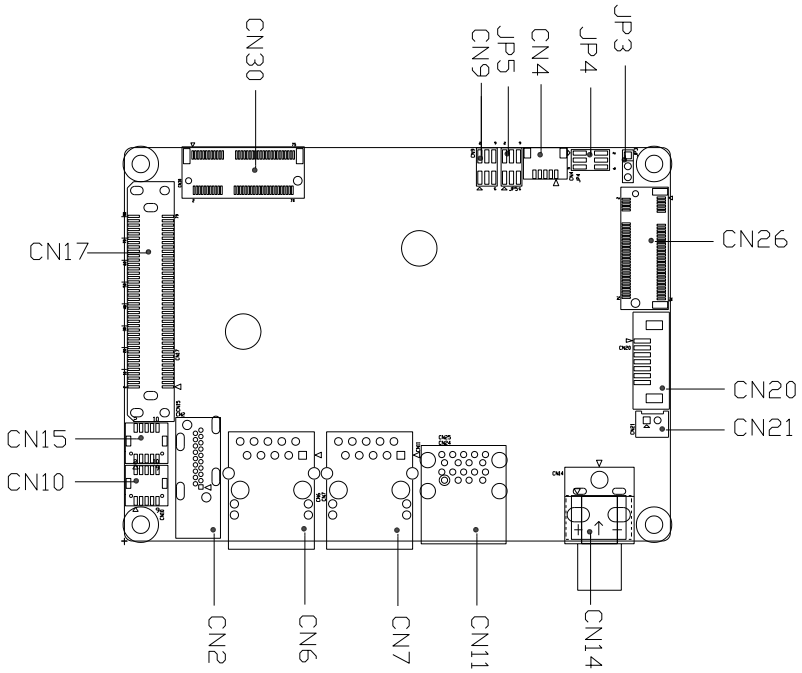

Component Side

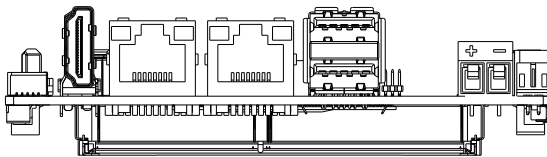

Solder Side

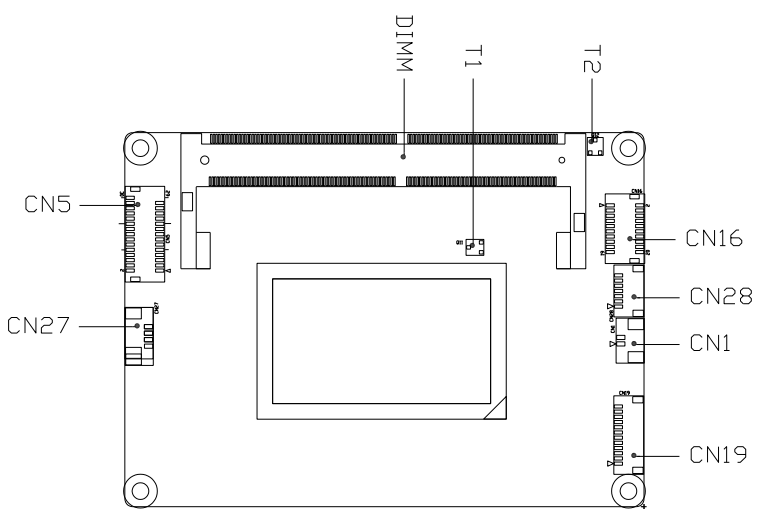

Solder Side

2.3 List of Jumpers

Please refer to the table below for all of the board's jumpers that you can configure for your application

Label	Function
JP3	LVDS Backlight Lightness Control Mode Selection
JP4	LVDS Operating Voltage Selection LVDS Backlight Inverter Voltage Selection
JP5	Clear CMOS Jumper Auto Power Button Enable/Disable Selection

2.3.1 LVDS Backlight Lightness Control Mode Selection (JP3)

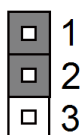

VR Mode(Default)

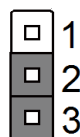

PWM Mode

2.3.2 LVDS Operating Voltage Selection (JP4)

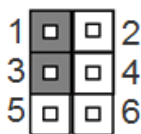

+5V

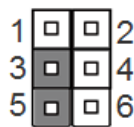

+3.3V (Default)

2.3.3 LVDS Backlight Inverter Voltage Selection (JP4)

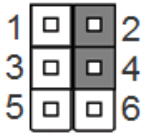

+12V (Default)

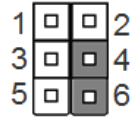

+5V

2.3.4 Clear CMOS Jumper (JP5)

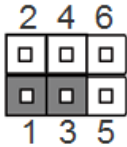

Normal (Default)

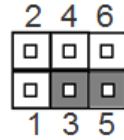

Clear CMOS

2.3.5 Auto Power Button Enable/Disable Selection (JP5)

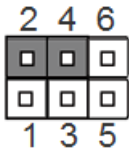

Enable Auto Power Button (Default)

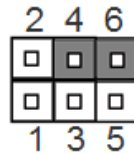

Disable Auto Power Button

2.4 List of Connectors

Please refer to the table below for all of the board's connectors that you can configure for your application

Label	Function
CN1	RTC Battery Connector
CN2	HDMI
CN4	LVDS Inverter / Backlight Connector
CN5	LVDS Port
CN6	LAN (RJ-45) Port1
CN7	LAN (RJ-45) Port2
CN9	Digital IO Port
CN10	USB 2.0 Port 1/2
CN11	USB 2.0/3.0 Port 3 Port 0/1
CN14	External +12V Input
CN15	Front Panel
CN16	COM Port1/ COM Port2
CN17	BIO Bank1 Connector
CN19	LPC Port
CN20	SATA Port
CN21	+5V Output for SATA HDD
CN26	M.2 (Key B) Connector
CN27	Smart FAN Connector
CN30	M.2 (Key E) Connector
DIMM1	DDR4 SO-DIMM Slot

2.4.1 RTC Battery Connector (CN1)

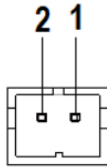

Pin	Pin Name	Signal Type	Signal Level
1	+3.3V	PWR	+3.3V
2	GND	GND	GND

2.4.2 HDMI (CN2)

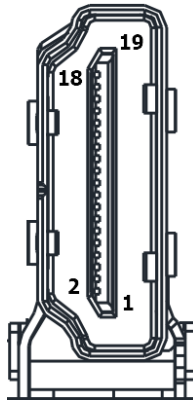

Pin	Pin Name	Signal Type	Signal level
1	HDMI_TX2+	DIFF	
2	GND	GND	GND
3	HDMI_TX2-	DIFF	
4	HDMI_TX1+	DIFF	
5	GND	GND	GND
6	HDMI_TX1-	DIFF	

Pin	Pin Name	Signal Type	Signal level
7	HDMI_TX0+	DIFF	
8	GND	GND	GND
9	HDMI_TX0-	DIFF	
10	HDMI_CLK+	DIFF	
11	GND	GND	GND
12	HDMI_CLK-	DIFF	
13	NC		
14	NC		
15	DDC_CLK	I/O	+5V
16	DDC_DATA	I/O	+5V
17	GND	GND	GND
18	+5V	PWR	+5V
19	HDMI_HPD		

2.4.3 LVDS Inverter / Backlight Connector (CN4)

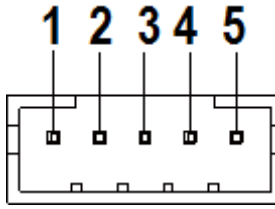

Pin	Pin Name	Signal Type	Signal Level
1	BKL_PWR	PWR	+5V/+12V
2	BKL_CONTROL	OUT	
3	GND	GND	GND
4	GND	GND	GND
5	BKL_ENABLE	OUT	+3.3V

Note: LVDS/BKL_PWR can be set to +5V or +12V by JP4.

Note: LVDS/BKL_CONTROL can be set by JP3.

Note: The driving current supports up to 1A.

2.4.4 LVDS Port (CN5)

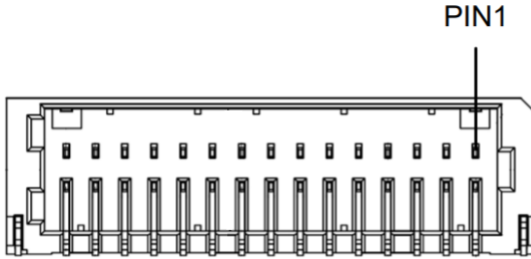

Note: LVDS LCD_PWR can be set to +3.3V or +5V by JP4.

Note: The max driving current is 1A.

Pin	Pin Name	Signal Type	Signal Level
1	BKL_ENABLE	OUT	
2	BKL_CONTROL	OUT	
3	LCD_PWR	PWR	+3.3V/+5V
4	GND	GND	GND
5	LVDS_A_CLK-	DIFF	
6	LVDS_A_CLK+	DIFF	
7	LCD_PWR	PWR	+3.3V/+5V
8	GND	GND	GND
9	LVDS_DA0-	DIFF	
10	LVDS_DA0+	DIFF	
11	LVDS_DA1-	DIFF	
12	LVDS_DA1+	DIFF	
13	LVDS_DA2-	DIFF	
14	LVDS_DA2+	DIFF	
15	LVDS_DA3-	DIFF	
16	LVDS_DA3+	DIFF	
17	DDC_DATA	I/O	+3.3V

Pin	Pin Name	Signal Type	Signal Level
18	DDC_CLK	I/O	+3.3V
19	LVDS_DB0-	DIFF	
20	LVDS_DB0+	DIFF	
21	LVDS_DB1-	DIFF	
22	LVDS_DB1+	DIFF	
23	LVDS_DB2-	DIFF	
24	LVDS_DB2+	DIFF	
25	LVDS_DB3-	DIFF	
26	LVDS_DB3+	DIFF	
27	LCD_PWR	PWR	+3.3V/+5V
28	GND	GND	GND
29	LVDS_B_CLK-	DIFF	
30	LVDS_B_CLK+	DIFF	

2.4.5 LAN (RJ-45) Port1 (CN6)

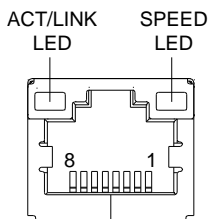

Pin	Pin Name	Signal Type	Signal Level
1	MDI0+	DIFF	
2	MDI0-	DIFF	
3	MDI1+	DIFF	
4	MDI2+	DIFF	
5	MDI2-	DIFF	
6	MDI1-	DIFF	
7	MDI3+	DIFF	
8	MDI3-	DIFF	

2.4.6 LAN (RJ-45) Port2 (CN7)

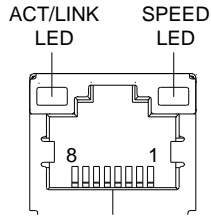

Pin	Pin Name	Signal Type	Signal Level
1	MDI0+	DIFF	
2	MDI0-	DIFF	
3	MDI1+	DIFF	
4	MDI2+	DIFF	
5	MDI2-	DIFF	
6	MDI1-	DIFF	
7	MDI3+	DIFF	
8	MDI3-	DIFF	

2.4.7 Digital IO Port (CN9)

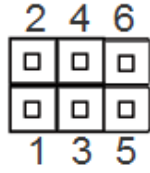

Pin	Pin Name	Signal Type	Signal Level
1	+5V	PWR	+5V
2	DIO_0	IN/OUT	
3	DIO_1	IN/OUT	
4	DIO_2	IN/OUT	
5	DIO_3	IN/OUT	
6	GND	GND	GND

2.4.8 USB 2.0 Port 1/2 (CN10)

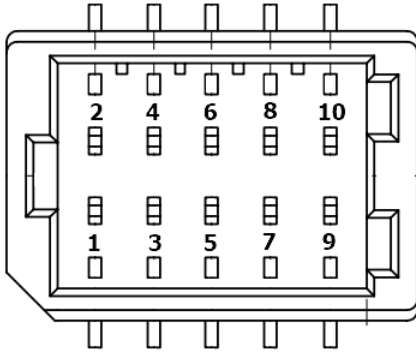

Pin	Pin Name	Signal Type	Signal Level
1	+V5SB	PWR	+5V
2	+V5SB	PWR	+5V
3	USB1_D-	DIFF	
4	USB2_D-	DIFF	
5	USB1_D+	DIFF	
6	USB2_D+	DIFF	
7	GND	GND	GND
8	GND	GND	GND
9	GND	GND	GND
10	GND	GND	GND

2.4.9 USB 2.0/3.0 Port 3 Port 3/4 (CN11)

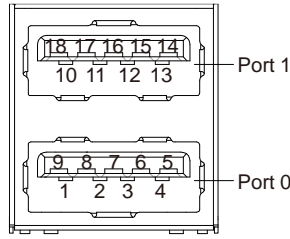

Pin	Pin Name	Signal Type	Signal Level
1	+V5SB	PWR	+5V
2	USB3_D-	DIFF	
3	USB3_D+	DIFF	
4	GND	GND	GND
5	USB3_SSRX-	DIFF	
6	USB3_SSRX+	DIFF	
7	GND	GND	GND
8	USB3_SSTX-	DIFF	
9	USB3_SSTX+	DIFF	
10	+V5SB	PWR	+5V
11	USB4_D-	DIFF	
12	USB4_D+	DIFF	
13	GND	GND	GND
14	USB4_SSRX-	DIFF	
15	USB4_SSRX+	DIFF	
16	GND	GND	GND
17	USB4_SSTX-	DIFF	
18	USB4_SSTX+	DIFF	

2.4.10 External +12V Input (CN14)

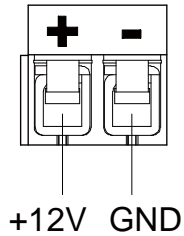

Pin	Pin Name	Signal Type	Signal Level
1	+12V	PWR	+12V
2	GND	GND	GND

2.4.11 Front Panel Port (CN15)

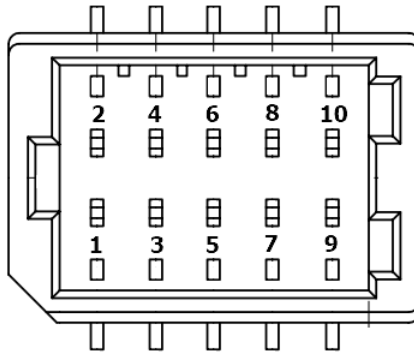

Pin	Pin Name	Signal Type	Signal level
1	GND	GND	GND
2	EXT_PWRBTN#	IN	
3	SATA_LED-	OUT	
4	SATA_LED+	OUT	
5	BUZZER-	OUT	
6	BUZZER+	OUT	

Pin	Pin Name	Signal Type	Signal level
7	GND	GND	GND
8	PWR_LED+	OUT	
9	GND	GND	GND
10	HWRST#	IN	

2.4.12 COM Port1/ COM Port2 (CN16)

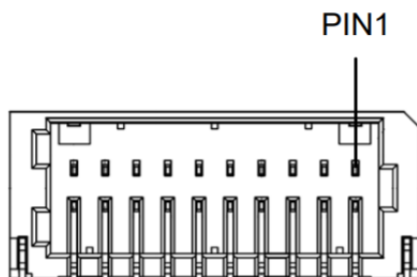

Pin	Pin Name	Signal Type	Signal Level
1	LOUT_L	OUT	
2	LOUT_R	OUT	
3	GND	GND	GND
4	AGND	GND	GND
5	DCDA	IN	
6	DCDB	IN	
7	RXA	IN	
8	RXB	IN	
9	TXA	OUT	±9V
10	TXB	OUT	±9V
11	DTRA	OUT	±9V
12	DTRB	OUT	±9V

Pin	Pin Name	Signal Type	Signal Level
13	DSRA	IN	
14	DSRB	IN	
15	RTSA	OUT	±9V
16	RTSB	OUT	±9V
17	CTSA	IN	
18	CTSB	IN	
19	RIA/+5V/+12V	IN/ PWR	+5V/+12V
20	RIB/+5V/+12V	IN/ PWR	+5V/+12V

COM Port 2 RS-422

Pin	Pin Name	Signal Type	Signal Level
3	GND	GND	GND
6	RS422_TX-	OUT	±5V
8	RS422_TX+	OUT	±5V
10	RS422_RX+	IN	
12	RS422_RX-	IN	

COM Port 2 RS-485

Pin	Pin Name	Signal Type	Signal Level
3	GND	GND	GND
6	RS485_D-	I/O	±5V
8	RS485_D+	I/O	±5V

Note: COM2 RS-232/422/485 can be set by BIOS setting. Default is RS-232.

Note: COM2 RI/+5V/+12V function can be set by BOM (R317-RI/R316-+12V/R318-+5V)

2.4.13 BIO Bank1 Connector (CN17)

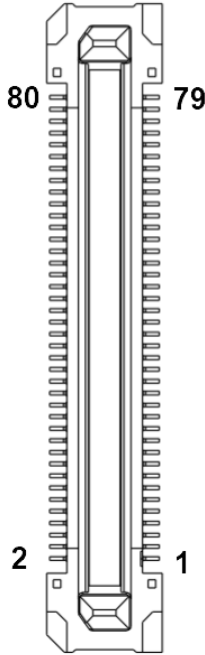

Pin	Pin Name	Signal Type	Signal Level
1	+12V	PWR	+12V
2	GND	GND	GND
3	GND	GND	GND
4	PCIE9_TXN	DIFF	
5	PCIE9_RXN	DIFF	
6	PCIE9_TXP	DIFF	
7	PCIE9_RXP	DIFF	
8	GND	GND	GND
9	GND	GND	GND
10	PCIE10_TXN	DIFF	

Pin	Pin Name	Signal Type	Signal Level
11	PCIE10_RXN	DIFF	
12	PCIE10_TXP	DIFF	
13	PCIE10_RXP	DIFF	
14	GND	GND	GND
15	GND	GND	GND
16	PS_ON#	OUT	
17	DDI1_CTRL_CLK	OUT	
18	DDI1_CTRL_DATA	IN/OUT	
19	+V5A	PWR	+5V
20	+V5A	PWR	+5V
21	+V5A	PWR	+5V
22	+V5A	PWR	+5V
23	CLK_PCIE_P4	DIFF	
24	BUF_PLT_RST#	OUT	
25	CLK_PCIE_N4	DIFF	
26	GND	GND	GND
27	GND	GND	GND
28	DDI1_LANE1_DN	OUT	
29	DDI1_LANE0_DN	OUT	
30	DDI1_LANE1_DP	OUT	
31	DDI1_LANE0_DP	OUT	
32	GND	GND	GND
33	GND	GND	GND
34	DDI1_LANE3_DN	OUT	
35	DDI1_LANE2_DN	OUT	
36	DDI1_LANE3_DP	OUT	

Pin	Pin Name	Signal Type	Signal Level
37	DDI1_LANE2_DP	OUT	
38	GND	GND	GND
39	GND	GND	GND
40	DDI1_HPD	OUT	
41	DDI1_AUX_DN	OUT	
42	GND	GND	GND
43	DDI1_AUX_DP	OUT	
44	USB3_4_TXN	IN/OUT	
45	GND	GND	GND
46	USB3_4_TXP	IN/OUT	
47	USB2N_4	IN/OUT	
48	GND	GND	GND
49	USB2P_4	IN/OUT	
50	USB3_4_RXN	IN/OUT	
51	GND	GND	GND
52	USB3_4_RXP	IN/OUT	
53	SMB_CLK	OUT	+3.3V
54	GND	GND	GND
55	SMB_DATA	IN/OUT	+3.3V
56	PCIE_WAKE#	IN	
57	GND	GND	GND
58	USB2_OC3#	IN	
59	+V5S	PWR	+5V
60	USB2_OC3#	IN	
61	+V5S	PWR	+5V
62	+V5S	PWR	+5V

Pin	Pin Name	Signal Type	Signal Level
63	+V5S	PWR	+5V
64	+V5S	PWR	+5V
65	LPC_AD0	IN/OUT	
66	LPC_FRAME#	OUT	
67	LPC_AD1	IN/OUT	
68	INT_SERIRQ	IN/OUT	
69	LPC_AD2	IN/OUT	
70	NC	NC	
71	LPC_AD3	IN/OUT	
72	BIO_PWR_OK	IN	
73	GND	GND	GND
74	AUD_GND	GND	GND
75	LPC_CLK_BIO	OUT	
76	LOUT_L	OUT	
77	PME#	OUT	
78	LOUT_R	OUT	
79	GND	GND	GND
80	GND	GND	GND

2.4.14 LPC Port (CN19)

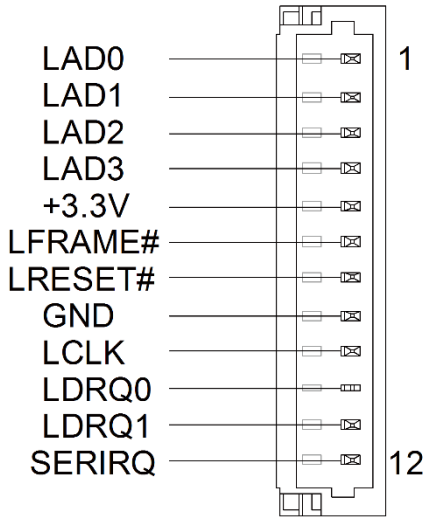

Pin	Pin Name	Signal Type	Signal Level
1	LAD0	IN/OUT	+3.3V
2	LAD1	IN/OUT	+3.3V
3	LAD2	IN/OUT	+3.3V
4	LAD3	IN/OUT	+3.3V
5	+V3.3S	PWR	+3.3V
6	LFRAME#	IN	
7	LRESET#	OUT	+3.3V
8	GND	GND	GND
9	LCLK	OUT	
10	SMB_DATA/ I2C_SDA	IN/OUT	
11	SMB_CLK/ I2C_CLK	OUT	
12	SMB_ALERT/ INT_SERIRQ	IN	+3.3V

2.4.15 SATA Port (CN20)

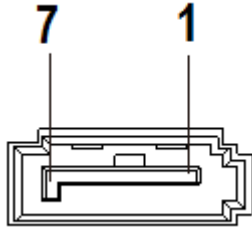

Pin	Pin Name	Signal Type	Signal Level
1	GND	GND	
2	SATA_TX+	DIFF	
3	SATA_TX-	DIFF	
4	GND	GND	
5	SATA_RX-	DIFF	
6	SATA_RX+	DIFF	
7	GND	GND	

2.4.16 +5V Output for SATA HDD (CN21)

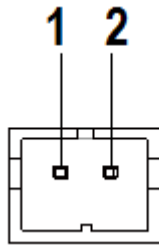

Pin	Pin Name	Signal Type	Signal Level
1	+V5S	PWR	+5V
2	GND	GND	GND

2.4.17 M.2 (Key B) Connector (CN26)

Pin	Pin Name	Signal Type	Signal Level
1	GND	GND	GND
2	+V3.3S	PWR	+3.3V
3	GND	GND	GND
4	+V3.3S	PWR	+3.3V
5	GND	GND	GND
6	NC	NC	
7	USB2P_10	IN/OUT	
8	W_DISABLE0#	OUT	
9	USB2N_10	IN/OUT	
10	SSD_LED#	IN	
11	GND	GND	GND
20	NC	NC	
21	GND	GND	GND
22	NC	NC	
23	NC	NC	
24	NC	NC	
25	NC	NC	
26	NC	NC	
27	GND	GND	GND
28	NC	NC	
29	PCIE11_RXN	DIFF	
30	NC	NC	
31	PCIE11_RXP	DIFF	
32	NC	NC	

Pin	Pin Name	Signal Type	Signal Level
33	GND	GND	GND
34	NC	NC	
35	PCIE11_TXN	DIFF	
36	NC	NC	
37	PCIE11_TXP	DIFF	
38	NC	NC	
39	GND	GND	GND
40	NC	NC	
41	SATA2_RXP	DIFF	
42	NC	NC	
43	SATA2_RXN	DIFF	
44	NC	NC	
45	GND	GND	GND
46	NC	NC	
47	SATA2_TXN	DIFF	
48	NC	NC	
49	SATA2_TXP	DIFF	
50	BUF_PLT_RST#	OUT	
51	GND	GND	GND
52	PCIE_CLK_REQ3#	IN	
53	PCIE3_CLKN	DIFF	
54	PCIE_WAKE#	IN	
55	PCIE3_CLKP	DIFF	
56	NC	NC	
57	GND	GND	GND
58	NC	NC	

Pin	Pin Name	Signal Type	Signal Level
59	NC	NC	
60	NC	NC	
61	NC	NC	
62	NC	NC	
63	NC	NC	
64	NC	NC	
65	NC	NC	
66	NC	NC	
67	NC	NC	
68	NC	NC	
69	GND	GND	GND
70	+V3.3S	PWR	+3.3V
71	GND	GND	GND
72	+V3.3S	PWR	+3.3V
73	GND	GND	GND
74	+V3.3S	PWR	+3.3V
75	NC	NC	

2.4.18 Smart FAN Connector (CN27)

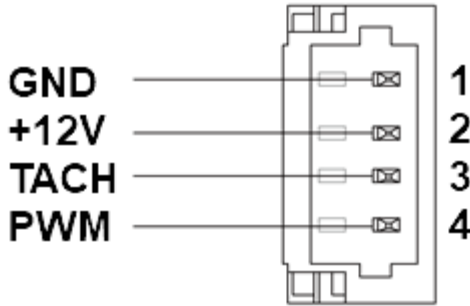

Pin	Pin Name	Signal Type	Signal Level
1	GND	GND	GND
2	+V3.3S	PWR	+12V
3	TACH	IN	
4	PWM	OUT	

2.4.19 M.2 (Key E) Connector (CN30)

Pin	Pin Name	Signal Type	Signal Level
1	GND	GND	GND
2	+V3.3A	PWR	+3.3V
3	USB2P_5	IN/OUT	
4	+V3.3A	PWR	+3.3V
5	USB2N_5	IN/OUT	
6	NC	NC	
7	GND	GND	GND
8	NC	NC	
9	NC	NC	

Pin	Pin Name	Signal Type	Signal Level
10	NC	NC	
11	NC	NC	
12	NC	NC	
13	NC	NC	
14	NC	NC	
15	NC	NC	
16	NC	NC	
17	NC	NC	
18	NC	NC	
19	NC	NC	
20	NC	NC	
21	NC	NC	
22	NC	NC	
23	NC	NC	
32	NC	NC	
33	GND	GND	GND
34	NC	NC	
35	PCIE1_TXP	DIFF	
36	NC	NC	
37	PCIE1_TXN	DIFF	
38	NC	NC	
39	GND	GND	GND
40	NC	NC	
41	PCIE1_RXP	DIFF	
42	NC	NC	
43	PCIE1_RXN	DIFF	

Pin	Pin Name	Signal Type	Signal Level
44	NC	NC	
45	GND	GND	GND
46	NC	NC	
47	PCIE1_CLKP	DIFF	
48	NC	NC	
49	PCIE1_CLKN	DIFF	
50	NC	NC	
51	GND	GND	GND
52	BUF_PLT_RST#	OUT	
53	PCIE_CLK_REQ1#	IN	
54	W_DISABLE1#	OUT	
55	PCIE_WAKE#	IN	
56	W_DISABLE2#	OUT	
57	GND	GND	GND
58	NC	NC	
59	NC	NC	
60	NC	NC	
61	NC	NC	
62	NC	NC	
63	GND	GND	GND
64	NC	NC	
65	NC	NC	
66	NC	NC	
67	NC	NC	
68	NC	NC	
69	GND	GND	GND

Pin	Pin Name	Signal Type	Signal Level
70	NC	NC	
71	NC	NC	
72	+V3.3S	PWR	+3.3V
73	NC	NC	
74	+V3.3S	PWR	+3.3V
75	GND	GND	GND

2.4.20 DDR4 SO-DIMM Slot (DIMM1)

Standard specification

2.5 Function Block

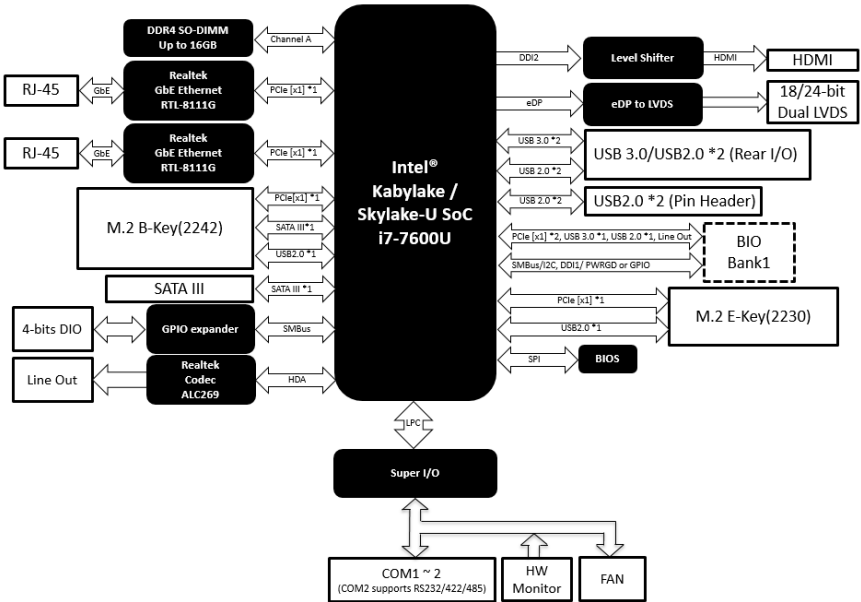

2.6 Assembly Options

Option1 (Part Number : PICO-KBU4-FAN01)

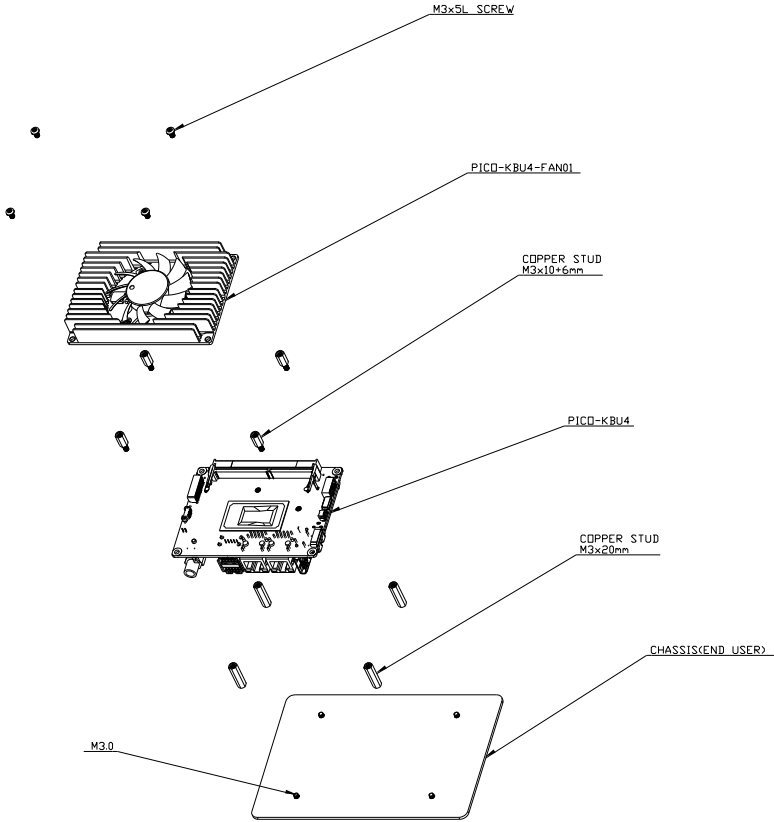

Option2(Part Number : PICO-KBU4-HSK01)

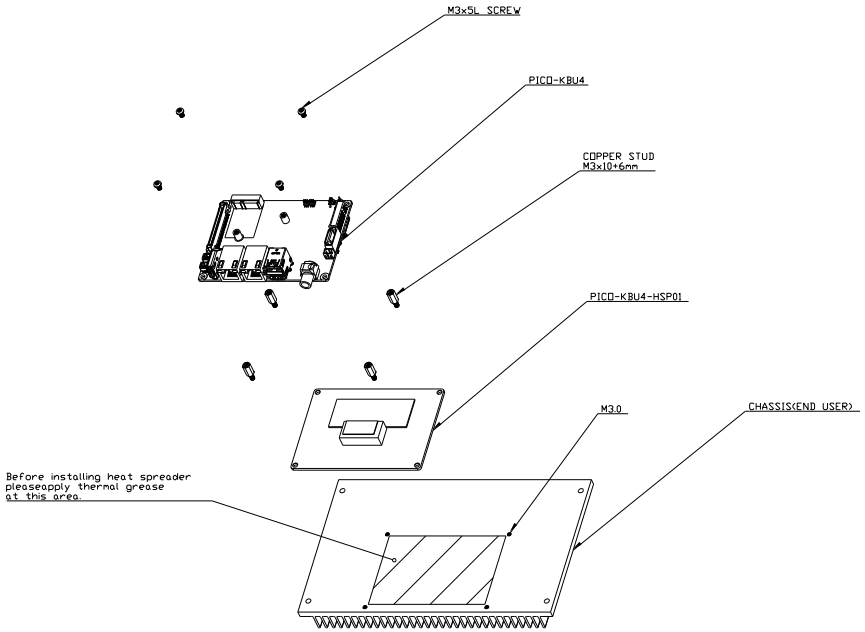

Chapter 3

AMI BIOS Setup

3.1 System Test and Initialization

The system uses certain routines to perform testing and initialization during the boot up sequence. If an error, fatal or non-fatal, is encountered, the system will output a few short beeps or display an error message. The system can usually continue the boot up sequence with non-fatal errors.

The system configuration verification routines check the current system configuration against the values stored in the CMOS memory and BIOS NVRAM. If a system configuration is not found or an error is detected, the system will load the default configuration and reboot automatically.

There are four situations in which you will need to setup system configuration:

1. You are starting your system for the first time
2. You have changed the hardware attached to your system
3. The system configuration was reset by the Clear-CMOS jumper
4. The CMOS memory has lost power and the configuration information has been erased.

The system CMOS memory has an integral lithium battery backup for data retention. However, you will need to replace the battery unit when it runs down.

3.2 AMI BIOS Setup

AMI BIOS ROM has a built-in Setup program that allows users to modify the basic system configuration. This type of information is stored in battery-backed CMOS RAM and BIOS NVRAM so that it retains the Setup information when the power is turned off.

Entering Setup

Power on the computer and press or <ESC> immediately. This will allow you to enter Setup.

Main

Set the date, use tab to switch between date elements.

Advanced

Enable/disable boot option for legacy network devices.

Chipset

Host bridge parameters.

Security

Set setup administrator password.

Boot

Enables/disables quiet boot option.

Save & Exit

Exit system setup after saving the changes.

3.3 Setup Submenu: Main



3.4 Setup Submenu: Advanced

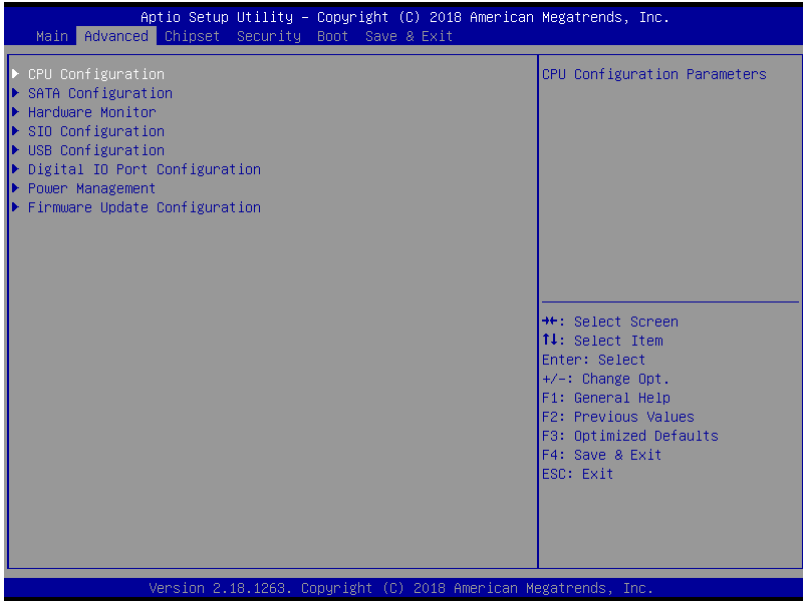

3.4.1 CPU configuration

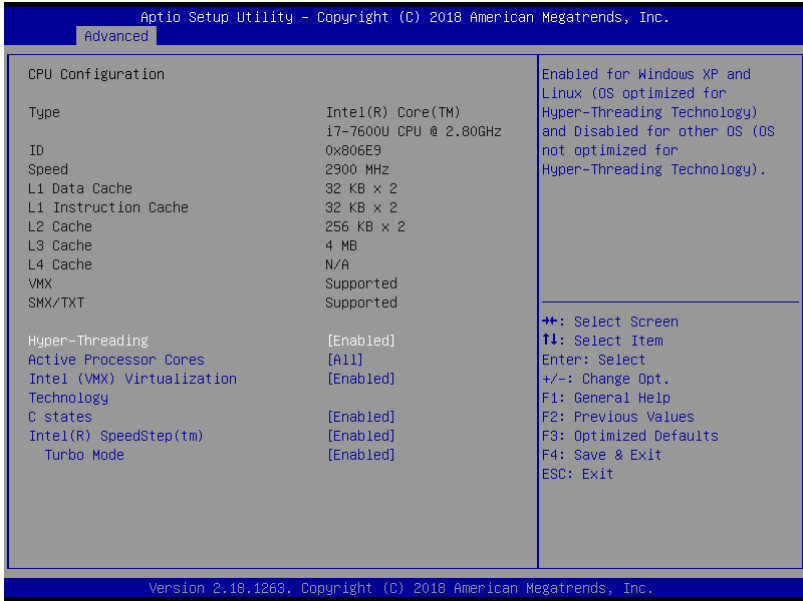

Options Summary		
Hyper-Threading	Disabled	
	Enabled	Optimal Default, Failsafe Default
Enable for Linux and Disabled for other OS.		
Active Processor Cores	All	Optimal Default, Failsafe Default
	1	
Number of cores to enable in each processor package.		
Intel (VMX) Virtualization Technology	Disabled	
	Enabled	Optimal Default, Failsafe Default
When enabled, a VMM can utilize the additional hardware capabilities provided by Vanderpool Technology.		
CPU C states	Disabled	
	Enabled	Optimal Default, Failsafe Default
Enable/Disable CPU power Management. Allows CPU to go to C states when it's not 100% utilized.		
Intel® SpeedStep™	Disabled	
	Enabled	Optimal Default, Failsafe Default
Allows more than two frequency ranges to be supported.		

Options Summary

Turbo Mode	Disabled	
	Enabled	Optimal Default, Failsafe Default
Enable/Disable processor turbo mode.		

3.4.2 SATA Configuration

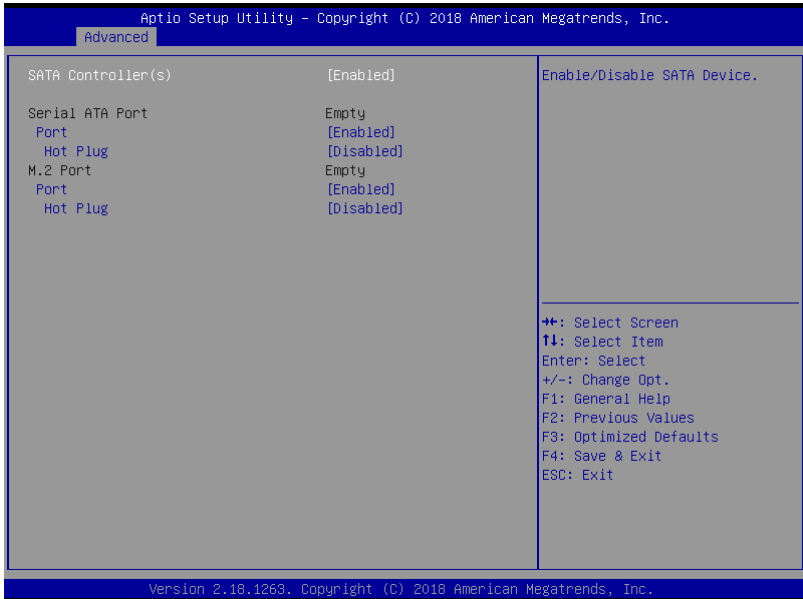

Options Summary

SATA Controller(s)	Enabled	Optimal Default, Failsafe Default
	Disabled	
Enable or disable SATA Device.		
Port X	Disabled	
	Enabled	Optimal Default, Failsafe Default
Enable or Disable SATA Port.		
Hot Plug	Disabled	Optimal Default, Failsafe Default
	Enabled	
Designates this port as Hot Pluggable.		

3.4.3 Hardware Monitor

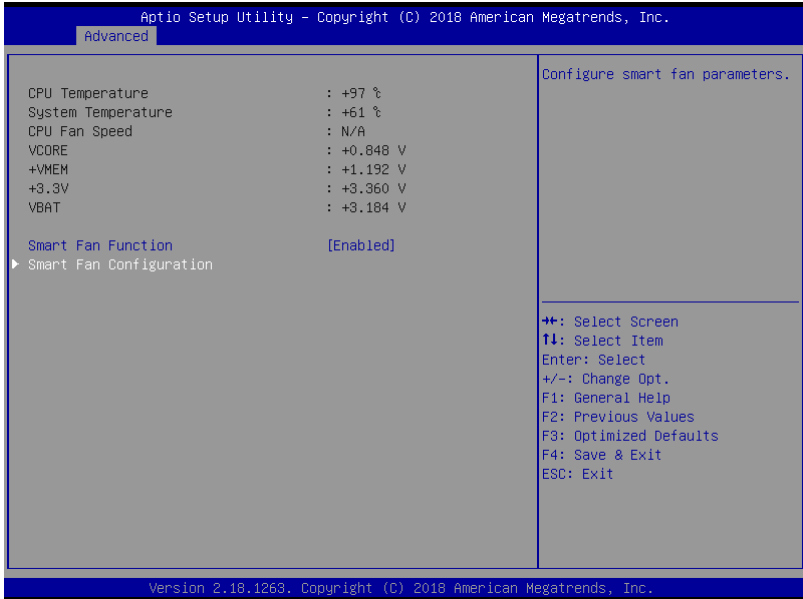

3.4.3.1 CPU Smart Fan Mode Configuration

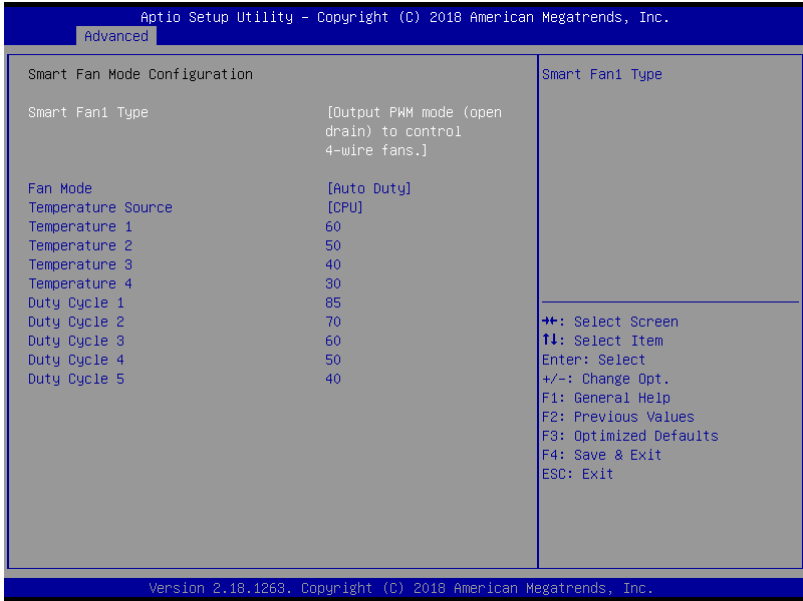

Options Summary		
Smart Fan1 Type	Use linear fan application circuit.	
	Output PWM mode (open drain) to control 4-wire fans.	Optimal Default, Failsafe Default
Smart fan type		
Fan Mode	Manual Duty	
	Auto Duty	Optimal Default, Failsafe Default
Smart fan mode		
Temperature Source	CPU	Optimal Default, Failsafe Default
Select the monitored temperature source for this fan.		

3.4.4 SIO Configuration

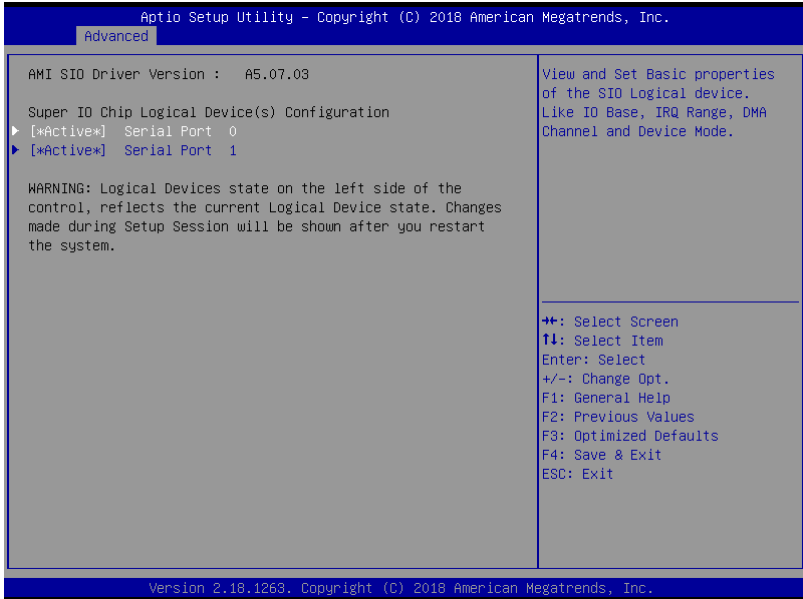

3.4.4.1 Serial Port Configuration

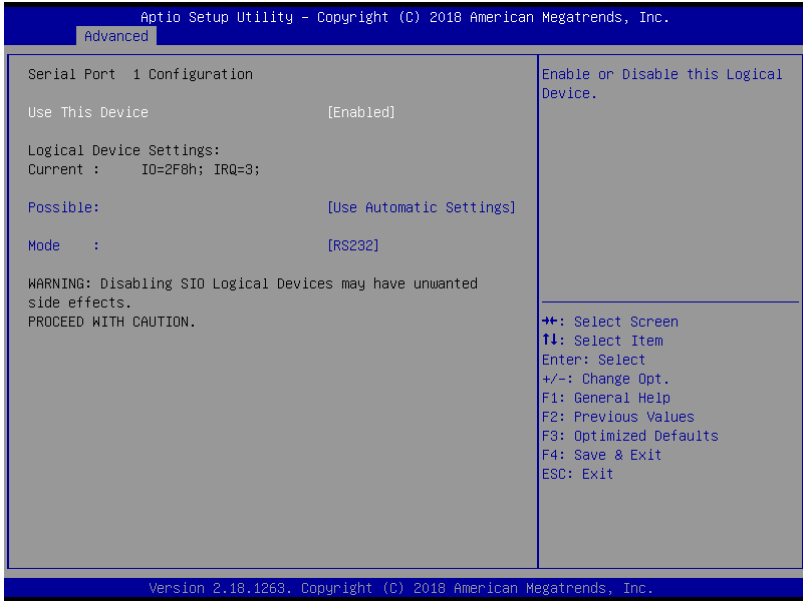

Options Summary		
Use This Device	Disabled	
	Enabled	Optimal Default, Failsafe Default
Enable or Disable Serial Port (COM)		
Possible:	Use Automatic Settings	Optimal Default, Failsafe Default
	IO=2F8; IRQ=3;	
	IO=3F8; IRQ=4;	
Select an optimal setting for IO device		
Mode:	RS232	Optimal Default, Failsafe Default
	RS422;	
	RS485	
UART 232/422/485 selection		

3.4.5 USB Configuration

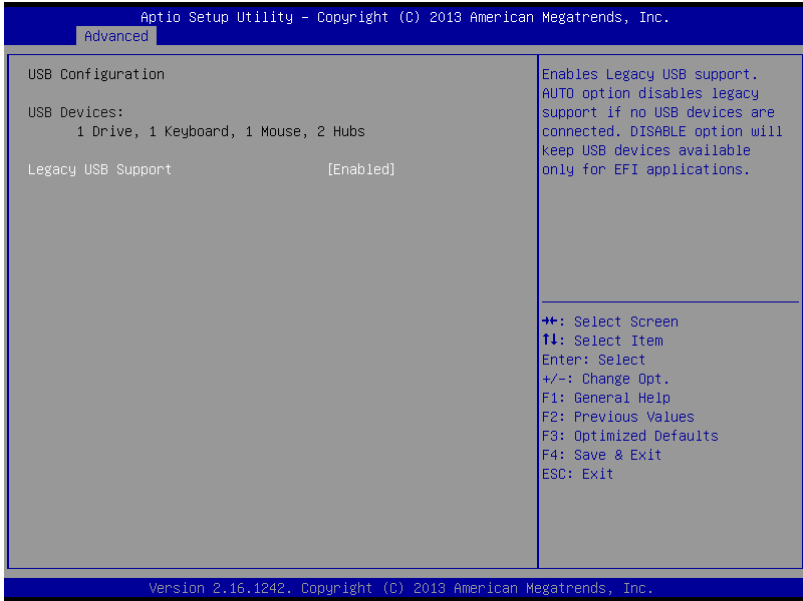

Options Summary		
Legacy USB Support	Enabled	Optimal Default, Failsafe Default
	Disabled	
	Auto	
Enables BIOS Support for Legacy USB Support. When enabled, USB can be functional in legacy environment like DOS. AUTO option disables legacy support if no USB devices are connected		
Device Name (Emulation Type)	Auto	Optimal Default, Failsafe Default
	Floppy	
	Forced FDD	
	CDROM	
If Auto. USB devices less than 530MB will be emulated as Floppy and remaining as Floppy and remaining as hard drive. Forced FDD option can be used to force a HDD formatted drive to boot as FDD (Ex. ZIP drive)		
USB Port 0/1 function routing	FCH USB port 8/9	Optimal Default, Failsafe Default
	FCH USB port 0/1	

3.4.6 Digital IO Port Configuration



Options Summary		
DIO Port	Output	
	Input	
Set DIO as Input or Output		
Output Level	High	Optimal Default, Failsafe Default
	Low	
Set output level when DIO pin is output		

3.4.7 Power management

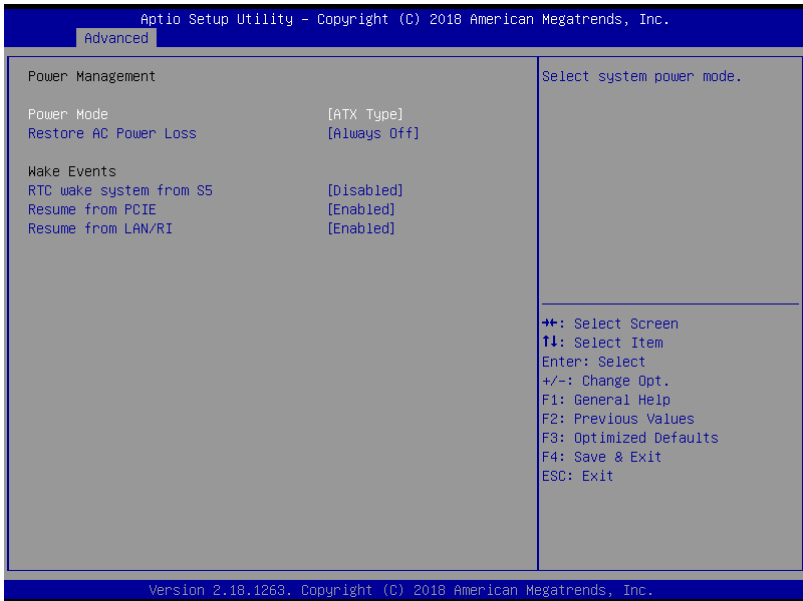

Options Summary		
Power Mode	ATX Type	Optimal Default, Failsafe Default
	AT Type	
Select power supply mode.		
Restore on Power Loss	Last State	
	Always On	
	Always Off	Optimal Default, Failsafe Default
Select power state when power is re-applied after a power failure.		
RTC wake system from S5	Disabled	Optimal Default, Failsafe Default
	Fixed Time	
Enable or disable System wake on alarm event. When enabled, System will wake on the hr::min::sec specified		
Resume from PCIE	Disabled	
	Enabled	Optimal Default, Failsafe Default
Enable/Disable resume from PCIE		
Resume form LAN/RI	Disabled	
	Enabled	Optimal Default, Failsafe Default
Enable/Disable resume from PCIE		

3.4.8 Firmware Update Configuration

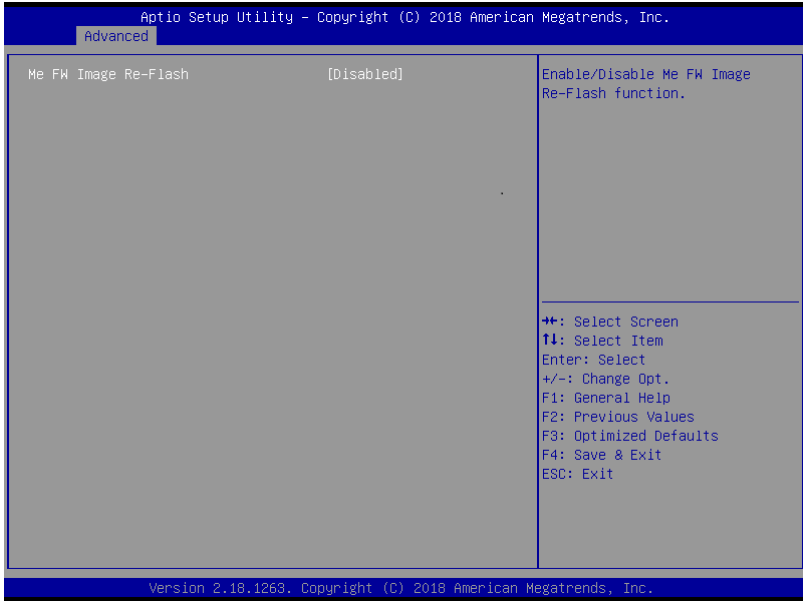

Options Summary		
Me FW Image Re-Flash	Disabled	Optimal Default, Failsafe Default
	Enabled	
Enable/Disable Me FW Image Re-Flash function.		

3.5 Setup Submenu: Chipset

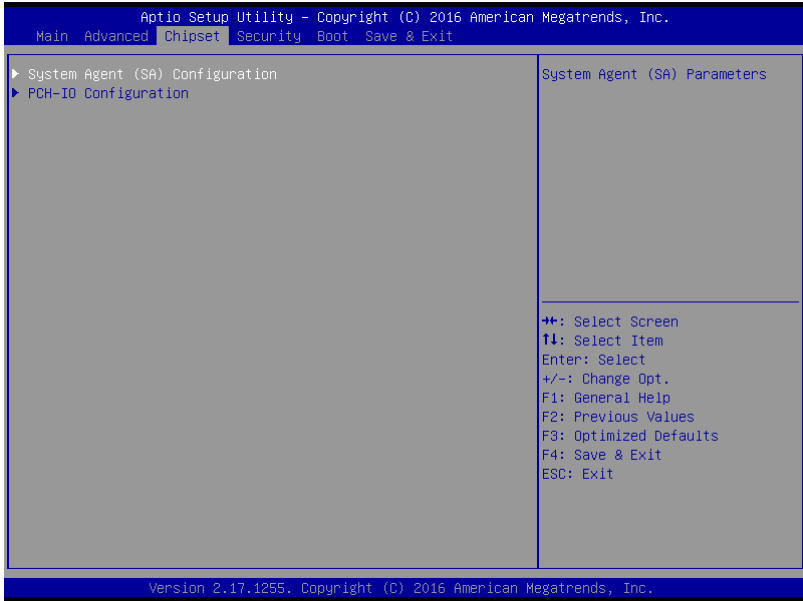

3.5.1 System Agent (SA) Configuration

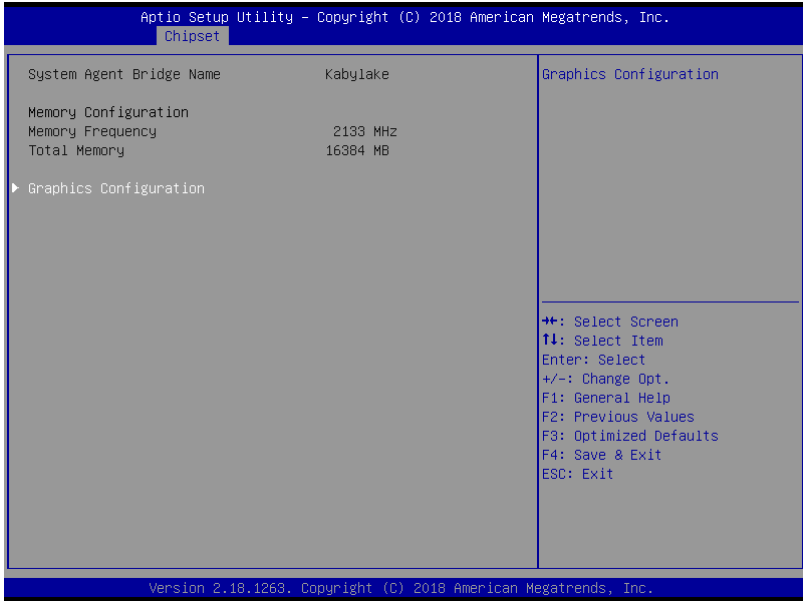

3.5.1.1 Graphics Configuration

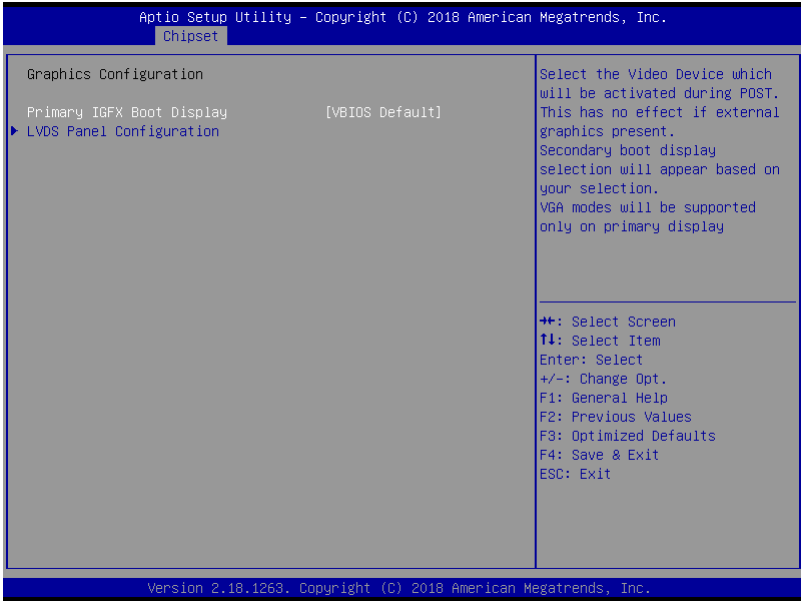

Options Summary		
Primary IGFX Boot Display	VBIOS Default	Optimal Default, Failsafe Default
	HDMI	
	LVDS	
<p>Select the Video Device which will be activated during POST. This has no effect if external graphic present.</p> <p>Secondary boot display selection will appear based on your selection.</p>		

3.5.1.1.1 LVDS Panel Configuration

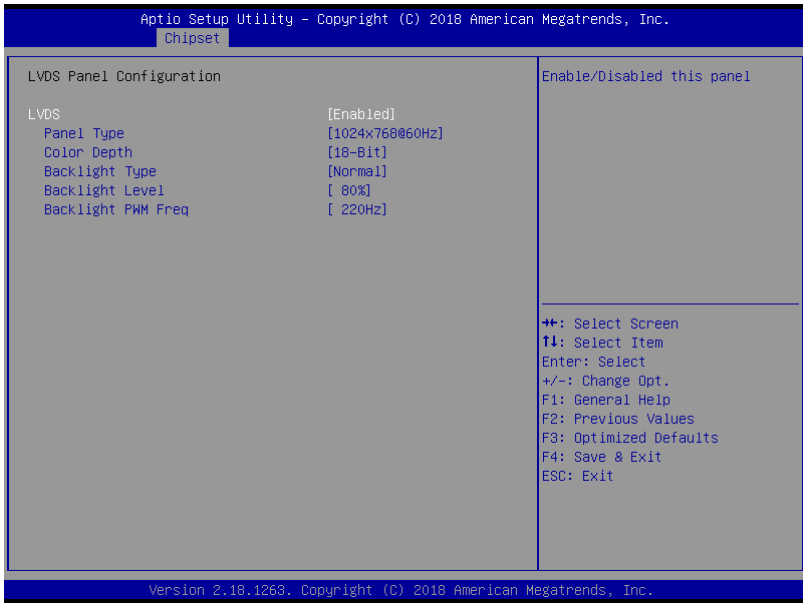

Options Summary		
LVDS	Disabled	
	Enabled	Optimal Default, Failsafe Default
Enable/Disabled this panel.		
LVDS Panel Type	640x480,18bit,60Hz	
	800x480,18bit,60Hz	
	800x600,18bit,60Hz	
	1024x600,18bit,60Hz	
	1024x768,18bit,60Hz	Optimal Default, Failsafe Default
	1024x768,24bit,60Hz	
	1280x768,24bit,60Hz	
	1280x1024,48bit,60Hz	
	1366x768,24bit,60Hz	
	1440x900,48bit,60Hz	
	1600x1200,48bit,60Hz	
	1920x1080,48bit,60Hz	
	1920x1200,48bit,60Hz	

Options Summary

Select LCD panel used by Internal Graphics Device by selecting the appropriate setup item.

Color Depth	18-bit	Optimal Default, Failsafe Default
	24-bit	
	36-bit	
	48-bit	

Select panel type

Backlight Type	Normal	Optimal Default, Failsafe Default
	Inverted	

Select backlight control signal type

Backlight Level	0%	
	10%	
	20%	
	30%	
	40%	
	50%	
	60%	
	70%	
	80%	Optimal Default, Failsafe Default
	90%	
100%		

Select backlight control level

Backlight PWM Freq	100Hz	
	200Hz	
	220Hz	Optimal Default, Failsafe Default
	500Hz	
	1KHz	
	2.2KHz	
	6.5KHz	

Select PWM frequency of backlight control signal

3.5.2 PCH-IO Configuration

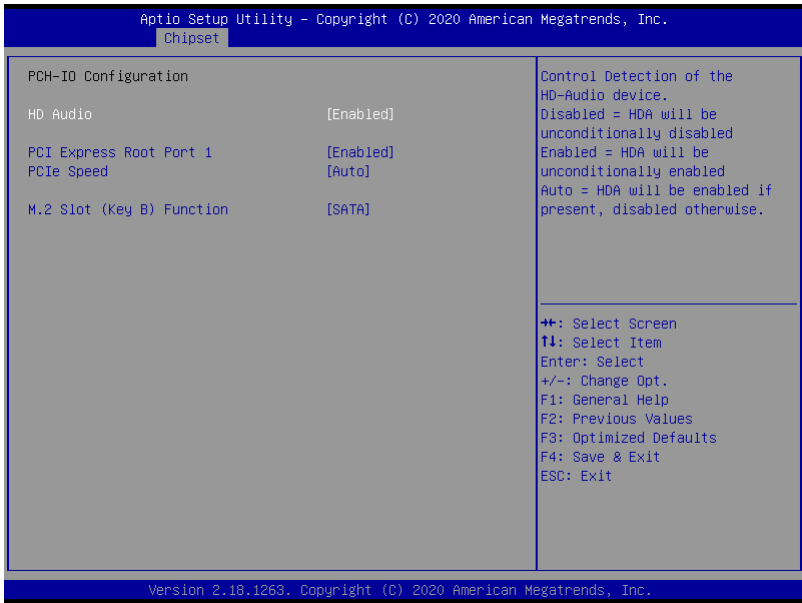

Options Summary		
HD Audio	Disabled	
	Enabled	Optimal Default, Failsafe Default
Control Detection of the HD-Audio device. Disabled = HDA will be unconditionally disabled Enabled = HDA will be unconditionally enabled Auto = HDA will be enabled if present, disabled otherwise.		
PCI Express Root Port 1	Enabled	Optimal Default, Failsafe Default
	Disabled	
Enable or disable PCI Express Root Port 1		
PCIe Lane Gen Speed	Auto	Optimal Default, Failsafe Default
	Gen1	
	Gen2	
	Gen3	
Select PCI Express port speed.		
M.2 Slot (Key B) Function	SATA	Optimal Default, Failsafe Default
	PCIe	
Switch M.2 slot function		

Options Summary		
PCI Express Root 12	Disabled	
	Enabled	Optimal Default, Failsafe Default
Enable/ Disable M.2 Slot PCIE		
PCIE Speed	Auto	Optimal Default, Failsafe Default
	Gen1	
	Gen1	
	Gen1	
Config PCIe speed		

3.6 Setup Submenu: Security

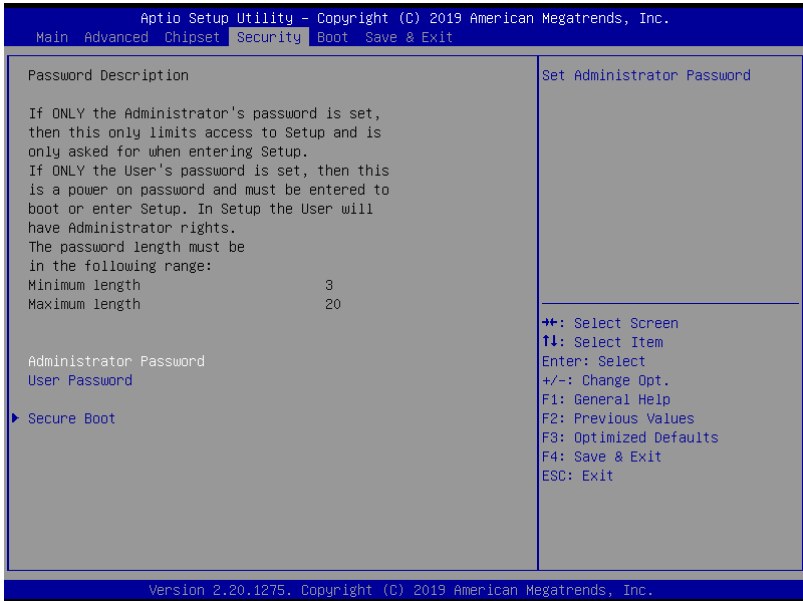

Change User/Administrator Password

You can set an Administrator Password or User Password. An Administrator Password must be set before you can set a User Password. The password will be required during boot up, or when the user enters the Setup utility. A User Password does not provide access to many of the features in the Setup utility.

Select the password you wish to set, and press Enter. In the dialog box, enter your password (must be between 3 and 20 letters or numbers). Press Enter and retype your password to confirm. Press Enter again to set the password.

Removing the Password

Select the password you want to remove and enter the current password. At the next dialog box press Enter to disable password protection.

3.6.1 Secure Boot

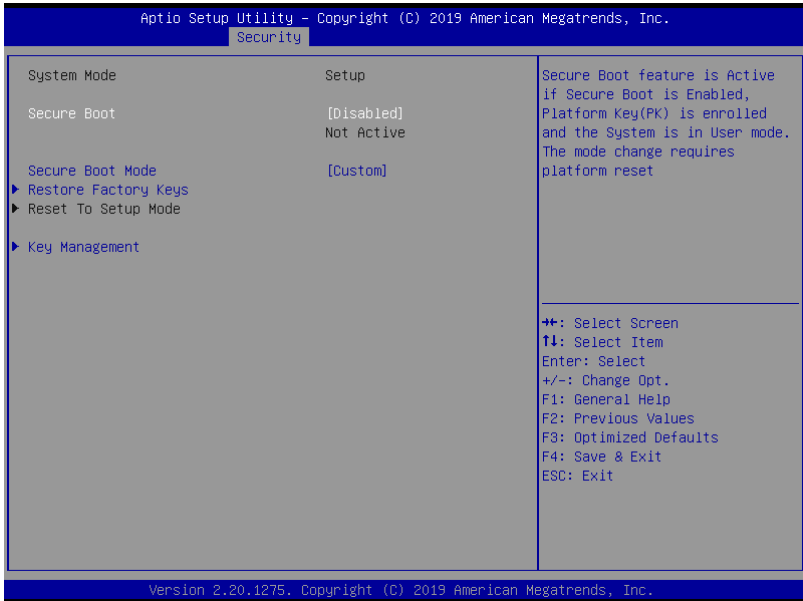

Options Summary		
Secure Boot	Disabled	Optimal Default, Failsafe Default
	Enabled	
Secure Boot feature is Active if Secure Boot is Enabled, Platform Key (PK) is enrolled and the System is in User mode. The mode change requires platform reset		
Secure Boot Mode	Custom	Optimal Default, Failsafe Default
	Standard	
Secure Boot mode options: Standard or Custom. In Custom mode, Secure Boot Policy variables can be configured by a physically present user without full authentication		
Restore Factory Keys		
Force System to User Mode. Install factory default Secure Boot key databases		
Reset To Setup Mode		
Delete all Secure Boot key databases from NVRAM		

3.6.1.1 Key Management

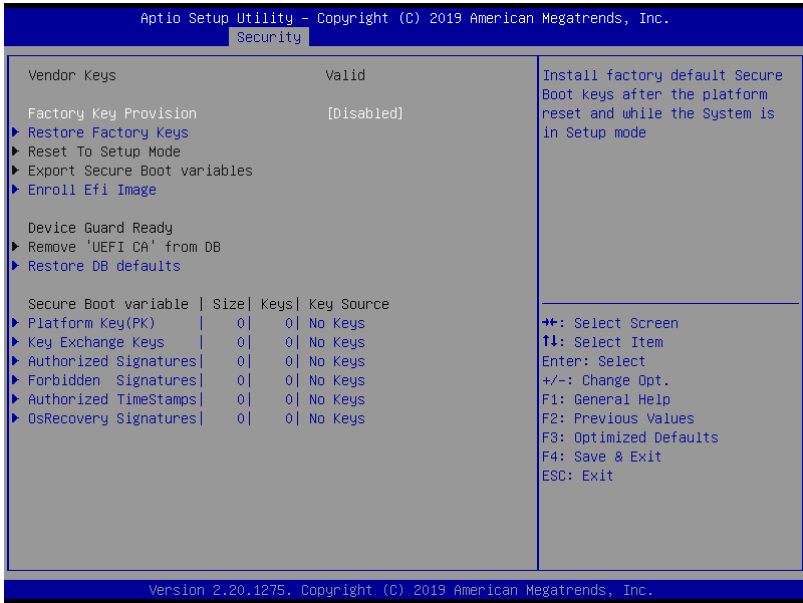

Options Summary		
Factory Key Provision	Disabled	Optimal Default, Failsafe Default
	Enabled	
Secure Boot feature is Active if Secure Boot is Enabled, Platform Key (PK) is enrolled and the System is in User mode. The mode change requires platform reset		
Restore Factory Keys		
Force System to User Mode. Install factory default Secure Boot key databases		
Reset To Setup Mode		
Delete all Secure Boot key databases from NVRAM		
Export Secure Boot variables		
Copy NVRAM content of Secure Boot variables to files in a root folder on a file system device		
Enroll Efi Image		
Allow the image to run in Secure Boot mode. Enroll SHA256 Hash certificate of a PE image into Authorized Signature Database (db)		

Options Summary		
Remove 'UEFI CA' from DB		
Device Guard ready system must not list 'Microsoft UEFI CA' Certificate in Authorized Signature database (db)		
Restore DB defaults		
Restore DB variable to factory defaults		
Platform Key(PK)	Details	
	Export	
	Update	
	Delete	
Key Exchange Keys	Details	
	Export	
	Update	
	Append	
	Delete	
Authorized Signatures	Details	
	Export	
	Update	
	Append	
	Delete	
Forbidden Signatures	Details	
	Export	
	Update	
	Append	
	Delete	
Authorized TimeStamps	Update	
	Append	
OsRecovery Signatures	Update	
	Append	
Enroll Factory Defaults or load certificates from a file: 1.Public Key Certificate: a)EFI_SIGNATURE_LIST b)EFI_CERT_X509 (DER) c)EFI_CERT_RSA2048 (bin) d)EFI_CERT_SHAXXX 2.Authenticated UEFI Variable 3.EFI PE/COFF Image(SHA256) Key Source: Factory,External,Mixed		

3.7 Setup Submenu: Boot

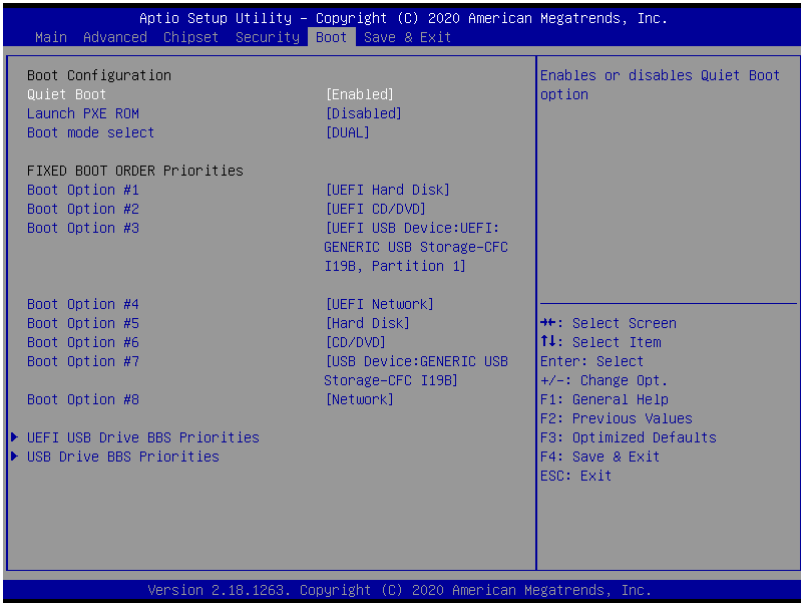

Options Summary		
Quiet Boot	Disabled	
	Enabled	Optimal Default, Failsafe Default
Enable/ Disable showing boot logo.		
Lunch PXE ROM	Disabled	Optimal Default, Failsafe Default
	Enabled	
Controls the execution of UEFI and Legacy Network OpROM		
Boot mode select	LEGACY	
	UEFI	
	DUAL	Optimal Default, Failsafe Default
Select boot mode		

3.7.1 BBS Priorities

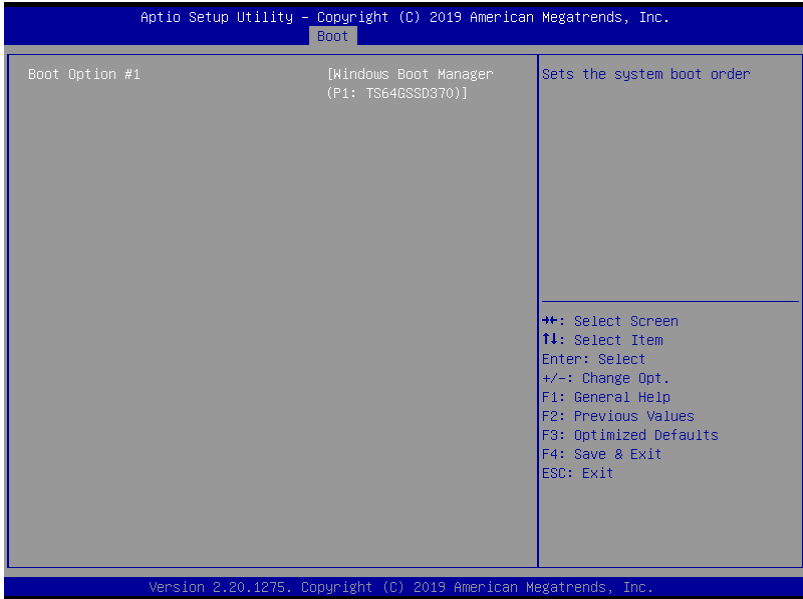

3.8 Setup Submenu: Exit

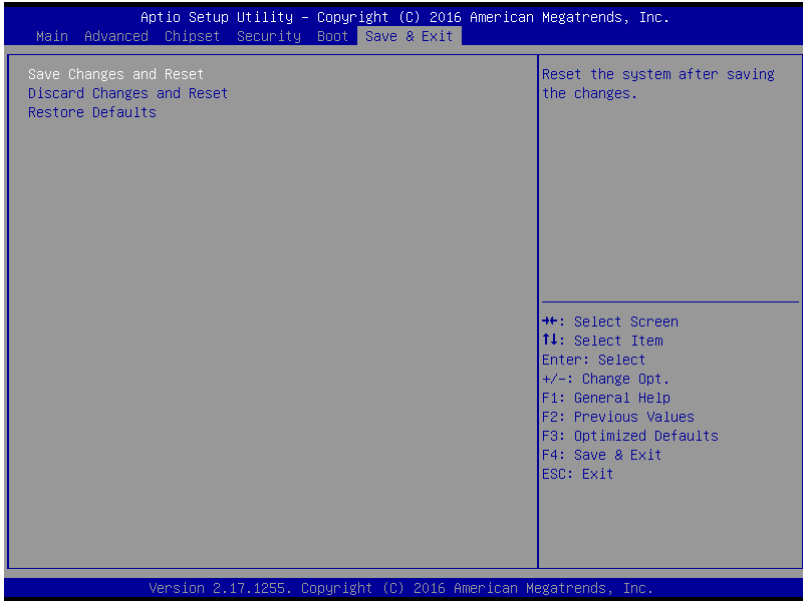

Chapter 4

Drivers Installation

4.1 Driver Download/Installation

Drivers for the PICO-KBU4 can be downloaded from the product page on the AAEON website by following this link:

<https://www.aaeon.com/en/p/pico-itx-boards-pico-kbu4#downloads>

Download the driver(s) you need and follow the steps below to install them.

Step 1 – Install Chipset Driver

1. Open the **STEP1 - CHIPSET** folder and open the **SetupChipset.exe** file
2. Follow the instructions
3. Drivers will be installed automatically

Step 2 – Install Graphic Driver

1. Open the **STEP2 - Graphic** folder and open the **Setup.exe** file
2. Follow the instructions
3. Driver will be installed automatically

Step 3 – Install LAN Driver

1. Open the **STEP3 - LAN** folder and select your OS
2. Open the **.exe** file in the folder
3. Follow the instructions
4. Driver will be installed automatically

Step 4 – Install Audio Driver

1. Open the **STEP4 - Audio** folder and select your OS
2. Open the **Setup.exe** file
3. Follow the instructions
4. Driver will be installed automatically

Step 5 – Install Serial Port Driver (Optional)

1. Open the **STEP5 – Serial Port Driver** folder and select your OS
2. Open the **.exe** file
3. Follow the instructions
4. Driver will be installed automatically

Step 6 – Install USB 3.0 Driver (Skylake Windows 7 Only)

1. Open the **Step6 - USB3.0** folder followed by **Setup.exe**
2. Follow the instructions
3. Drivers will be installed automatically

Appendix A

I/O Information

A.1 I/O Address Map

PICO-ITX Board

PICO-KBU4

Input/output (IO)	
▼	[0000000000000000 - 000000000000CF7] PCI Express Root Complex
▶	[0000000000000020 - 0000000000000021] Programmable interrupt controller
▶	[0000000000000024 - 0000000000000025] Programmable interrupt controller
▶	[0000000000000028 - 0000000000000029] Programmable interrupt controller
▶	[000000000000002C - 000000000000002D] Programmable interrupt controller
▶	[000000000000002E - 000000000000002F] Motherboard resources
▶	[0000000000000030 - 0000000000000031] Programmable interrupt controller
▶	[0000000000000034 - 0000000000000035] Programmable interrupt controller
▶	[0000000000000038 - 0000000000000039] Programmable interrupt controller
▶	[000000000000003C - 000000000000003D] Programmable interrupt controller
▶	[0000000000000040 - 0000000000000043] System timer
▶	[000000000000004E - 000000000000004F] Motherboard resources
▶	[0000000000000050 - 0000000000000053] System timer
▶	[0000000000000060 - 0000000000000060] Standard PS/2 Keyboard
▶	[0000000000000061 - 0000000000000061] Motherboard resources
▶	[0000000000000063 - 0000000000000063] Motherboard resources
▶	[0000000000000064 - 0000000000000064] Standard PS/2 Keyboard
▶	[0000000000000065 - 0000000000000065] Motherboard resources
▶	[0000000000000067 - 0000000000000067] Motherboard resources
>	[0000000000000070 - 0000000000000077] System CMOS/real time clock
▶	[0000000000000080 - 0000000000000080] Motherboard resources
▶	[0000000000000092 - 0000000000000092] Motherboard resources
▶	[00000000000000A0 - 00000000000000A1] Programmable interrupt controller
▶	[00000000000000A4 - 00000000000000A5] Programmable interrupt controller
▶	[00000000000000A8 - 00000000000000A9] Programmable interrupt controller
▶	[00000000000000AC - 00000000000000AD] Programmable interrupt controller
▶	[00000000000000B0 - 00000000000000B1] Programmable interrupt controller
▶	[00000000000000B2 - 00000000000000B3] Motherboard resources
▶	[00000000000000B4 - 00000000000000B5] Programmable interrupt controller
▶	[00000000000000B8 - 00000000000000B9] Programmable interrupt controller
▶	[00000000000000BC - 00000000000000BD] Programmable interrupt controller
▶	[00000000000002F8 - 00000000000002FF] Communications Port (COM2)
▶	[00000000000003B0 - 00000000000003BB] Intel(R) HD Graphics 620
▶	[00000000000003C0 - 00000000000003DF] Intel(R) HD Graphics 620
▶	[00000000000003F8 - 00000000000003FF] Communications Port (COM1)
▶	[00000000000004D0 - 00000000000004D1] Programmable interrupt controller
▶	[0000000000000680 - 000000000000069F] Motherboard resources
▶	[0000000000000A00 - 0000000000000A0F] Motherboard resources
▶	[0000000000000A10 - 0000000000000A1F] Motherboard resources
▼	[000000000000D00 - 000000000000FFFF] PCI Express Root Complex
▶	[000000000000164E - 000000000000164F] Motherboard resources
>	[0000000000001800 - 00000000000018FE] Motherboard resources
>	[000000000000D000 - 000000000000DFFF] Mobile 6th/7th Generation Intel(R) Processor Family I/O PCI Express Root Port #4 - 9D13
>	[000000000000E000 - 000000000000EFFF] Mobile 6th/7th Generation Intel(R) Processor Family I/O PCI Express Root Port #3 - 9D12
▶	[000000000000F000 - 000000000000F03F] Intel(R) HD Graphics 620
▶	[000000000000F040 - 000000000000F05F] Mobile 6th/7th Generation Intel(R) Processor Family I/O SMBUS - 9D23
▶	[000000000000F060 - 000000000000F07F] Standard SATA AHCI Controller
▶	[000000000000F080 - 000000000000F083] Standard SATA AHCI Controller
▶	[000000000000F090 - 000000000000F097] Standard SATA AHCI Controller
▶	[000000000000FF00 - 000000000000FFFE] Motherboard resources
>	[000000000000FFFF - 000000000000FFFF] Motherboard resources







































A.2 Memory Address Map

PICO-ITX Board

PICO-KBU4

Address Range	Device Name
[0000000000A0000 - 0000000000BFFFFF]	Intel(R) HD Graphics 620
[00000000000A0000 - 00000000000BFFFFF]	PCI Express Root Complex
[00000000090000000 - 000000000DFFFFFFF]	PCI Express Root Complex
[00000000C00000000 - 000000000CFFFFFFF]	Intel(R) HD Graphics 620
[00000000D00000000 - 00000000D0003FFF]	Realtek PCIe GBE Family Controller #2
[00000000D00000000 - 00000000D000FFFFF]	Mobile 6th/7th Generation Intel(R) Processor Family I/O PCI Express Root Port #4 - 9D13
[00000000D01000000 - 00000000D0103FFF]	Realtek PCIe GBE Family Controller
[00000000D01000000 - 00000000D01FFF7FF]	Mobile 6th/7th Generation Intel(R) Processor Family I/O PCI Express Root Port #3 - 9D12
[00000000DE0000000 - 00000000DEFFFFFFF]	Intel(R) HD Graphics 620
[00000000DF0000000 - 00000000DF000FFFF]	Realtek PCIe GBE Family Controller #2
[00000000DF0000000 - 00000000DF000FFFF]	Mobile 6th/7th Generation Intel(R) Processor Family I/O PCI Express Root Port #4 - 9D13
[00000000DF1000000 - 00000000DF100FFFF]	Realtek PCIe GBE Family Controller
[00000000DF1000000 - 00000000DF1FFF7FF]	Mobile 6th/7th Generation Intel(R) Processor Family I/O PCI Express Root Port #3 - 9D12
[00000000DF2100000 - 00000000DF21FFF7F]	Intel(R) USB 3.0 eXtensible Host Controller - 1.0 (Microsoft)
[00000000DF2280000 - 00000000DF229FFFF]	Standard SATA AHCI Controller
[00000000DF22A0000 - 00000000DF22A0FFF]	Mobile 6th/7th Generation Intel(R) Processor Family I/O SMBUS - 9D23
[00000000DF22B0000 - 00000000DF22B7FFF]	Standard SATA AHCI Controller
[00000000DF22C0000 - 00000000DF22C0FFF]	Standard SATA AHCI Controller
[00000000DF22D0000 - 00000000DF22DFFFF]	Mobile 6th/7th Generation Intel(R) Processor Family I/O Thermal subsystem - 9D31
[00000000DFFE00000 - 00000000DFFFFFFFF]	Motherboard resources
[00000000E00000000 - 00000000EFFFFFFF]	Motherboard resources
[00000000FD0000000 - 00000000FDABFFFFF]	Motherboard resources
[00000000FD0000000 - 00000000FE7FFFFF]	PCI Express Root Complex
[00000000FDAC00000 - 00000000FDACFFFFF]	Motherboard resources
[00000000FDAD00000 - 00000000FDADFFFFF]	Motherboard resources
[00000000FDAE00000 - 00000000FDAEFFFFF]	Motherboard resources
[00000000FDAF00000 - 00000000FDAFFFFF]	Motherboard resources
[00000000FDB000000 - 00000000FDBFFFFF]	Motherboard resources
[00000000FE0000000 - 00000000FE01FFFFF]	Motherboard resources
[00000000FE0280000 - 00000000FE028FFFF]	Motherboard resources
[00000000FE0290000 - 00000000FE029FFFF]	Motherboard resources
[00000000FE0300000 - 00000000FE033FFFF]	High Definition Audio Controller
[00000000FE0360000 - 00000000FE03BFFFF]	Motherboard resources
[00000000FE03D0000 - 00000000FE3FFFFF]	Motherboard resources
[00000000FE4000000 - 00000000FE40FFFFF]	High Definition Audio Controller
[00000000FE4100000 - 00000000FE7FFFFF]	Motherboard resources
[00000000FED000000 - 00000000FED003FFF]	High precision event timer
[00000000FED100000 - 00000000FED17FFFF]	Motherboard resources
[00000000FED180000 - 00000000FED18FFFF]	Motherboard resources
[00000000FED190000 - 00000000FED19FFFF]	Motherboard resources
[00000000FED200000 - 00000000FED3FFFFF]	Motherboard resources
[00000000FED450000 - 00000000FED8FFFFF]	Motherboard resources
[00000000FED900000 - 00000000FED93FFFF]	Motherboard resources
[00000000FEE000000 - 00000000FEEFFFFFFF]	Motherboard resources
[00000000FF0000000 - 00000000FFFFFFF]	Legacy device
[00000000FF0000000 - 00000000FFFFFFF]	Motherboard resources

A.3 IRQ Mapping Chart

Interrupt request (IRQ)		
	(ISA) 0x00000000 (00)	System timer
	(ISA) 0x00000001 (01)	Standard PS/2 Keyboard
	(ISA) 0x00000003 (03)	Communications Port (COM2)
	(ISA) 0x00000004 (04)	Communications Port (COM1)
	(ISA) 0x00000008 (08)	System CMOS/real time clock
	(ISA) 0x0000000C (12)	PS/2 Compatible Mouse
	(ISA) 0x0000000E (14)	Motherboard resources
<hr/>		
	(ISA) 0x000001E8 (488)	Microsoft ACPI-Compliant System
	(ISA) 0x000001E9 (489)	Microsoft ACPI-Compliant System
	(ISA) 0x000001EA (490)	Microsoft ACPI-Compliant System
	(ISA) 0x000001EB (491)	Microsoft ACPI-Compliant System
	(ISA) 0x000001EC (492)	Microsoft ACPI-Compliant System
	(ISA) 0x000001ED (493)	Microsoft ACPI-Compliant System
	(ISA) 0x000001EE (494)	Microsoft ACPI-Compliant System
	(ISA) 0x000001EF (495)	Microsoft ACPI-Compliant System
	(ISA) 0x000001F0 (496)	Microsoft ACPI-Compliant System
	(ISA) 0x000001F1 (497)	Microsoft ACPI-Compliant System
	(ISA) 0x000001F2 (498)	Microsoft ACPI-Compliant System
	(ISA) 0x000001F3 (499)	Microsoft ACPI-Compliant System
	(ISA) 0x000001F4 (500)	Microsoft ACPI-Compliant System
	(ISA) 0x000001F5 (501)	Microsoft ACPI-Compliant System
	(ISA) 0x000001F6 (502)	Microsoft ACPI-Compliant System
	(ISA) 0x000001F7 (503)	Microsoft ACPI-Compliant System
	(ISA) 0x000001F8 (504)	Microsoft ACPI-Compliant System
	(ISA) 0x000001F9 (505)	Microsoft ACPI-Compliant System
	(ISA) 0x000001FA (506)	Microsoft ACPI-Compliant System
	(ISA) 0x000001FB (507)	Microsoft ACPI-Compliant System
	(ISA) 0x000001FC (508)	Microsoft ACPI-Compliant System
	(ISA) 0x000001FD (509)	Microsoft ACPI-Compliant System
	(ISA) 0x000001FE (510)	Microsoft ACPI-Compliant System
	(ISA) 0x000001FF (511)	Microsoft ACPI-Compliant System
	(PCI) 0x0000000B (11)	Mobile 6th/7th Generation Intel(R) Processor Family I/O Thermal subsystem - 9D31
	(PCI) 0x0000000B (11)	Mobile 6th/7th Generation Intel(R) Processor Family I/O SMBUS - 9D23
	(PCI) 0x00000010 (16)	High Definition Audio Controller
	(PCI) 0x00000012 (18)	Realtek PCIe GBE Family Controller
	(PCI) 0x00000013 (19)	Realtek PCIe GBE Family Controller #2
	(PCI) 0xFFFFFFF0 (-4)	Intel(R) USB 3.0 eXtensible Host Controller - 1.0 (Microsoft)
	(PCI) 0xFFFFFFF0 (-3)	Intel(R) HD Graphics 620
	(PCI) 0xFFFFFFF0 (-2)	Standard SATA AHCI Controller

Appendix B

Mating Connectors

B.1 List of Mating Connectors and Cables

The table notes mating connectors and available cables.

Connector Label	Function	Mating Connector		Available Cable	Cable P/N
		Vendor	Model no		
CN1	Battery	Molex	51021-0200	Battery Cable	175011301C
CN2	HDMI	Molex	88768-9900	NA	NA
CN4	LVDS Port Inverter/ Backlight Connector	JST	SHR-05V-S-B	LVDS Inverter Cable	1709050203
CN5	LVDS Port	ACES	50247-030H0H0-001	LVDS Cable	1704300030
CN6	LAN Connector	Molex	44915-0001	NA	NA
CN7	LAN Connector	Molex	44915-0001	NA	NA
CN9	Digital IO Port	Molex	78120-0607	NA	NA
CN10	USB 2.0 Connector	ACES	50247-010H0H0-001	USB Cable	170010010D
CN11	USB 3.0 Connector	Wurth Electronics	710-692112030100	NA	NA
CN14	External +12V Input	Molex	19211-0003	Power Cable	170204010R
CN15	Front Panel Connector	ACES	50247-010H0H0-001	Front Panel Cable	1709100108
CN16	COM Port 1/2 & line out Connector	ACES	50247-020H0H0-001	COM Port Cable	1701200101
CN17	BIO Connector	Hirose	FX18-80S-0.8SV20	NA	NA
CN19	LPC Port	JST	SHR-12V-S-B	AAEON LPC Cable	1703120130
CN20	SATA Port	Molex	887505318	NA	NA

Connector Label	Function	Mating Connector		Available Cable	Cable P/N
		Vendor	Model no		
CN21	+5V Output for SATA HDD	JST	PHR-2	SATA power Cable	1702150155
CN23	DC Jack (Optional)	HUANG JI	5525C257-3T00-R1-7.5	Power Cable	1702041004
CN27	FAN Connector	Molex	51021-0400	NA	NA