

# PICO-EHL4-A11

---

PICO-ITX Single Board Computer

User's Manual 1<sup>st</sup> Ed

## Copyright Notice

---

This document is copyrighted, 2022. All rights are reserved. The original manufacturer reserves the right to make improvements to the products described in this manual at any time without notice.

No part of this manual may be reproduced, copied, translated, or transmitted in any form or by any means without the prior written permission of the original manufacturer. Information provided in this manual is intended to be accurate and reliable. However, the original manufacturer assumes no responsibility for its use, or for any infringements upon the rights of third parties that may result from its use.

The material in this document is for product information only and is subject to change without notice. While reasonable efforts have been made in the preparation of this document to assure its accuracy, AAEMON assumes no liabilities resulting from errors or omissions in this document, or from the use of the information contained herein.

AAEMON reserves the right to make changes in the product design without notice to its users.

## Acknowledgement

---

All other products' name or trademarks are properties of their respective owners.

- Microsoft Windows® is a registered trademark of Microsoft Corp.
- Intel®, Celeron® and Pentium® are registered trademarks of Intel Corporation
- Intel Atom™ is a trademark of Intel Corporation
- ITE is a trademark of Integrated Technology Express, Inc.
- IBM, PC/AT, PS/2, and VGA are trademarks of International Business Machines Corporation.

All other product names or trademarks are properties of their respective owners.

Omission of a product name from this list does not imply any claim to ownership by the publisher of this document.

## Packing List

---

Before setting up your product, please make sure the following items have been shipped:

Item	Quantity
● PICO-EHL4-A11	1

If any of these items are missing or damaged, please contact your distributor or sales representative immediately.

## About this Document

---

This User's Manual contains all the essential information, such as detailed descriptions and explanations on the product's hardware and software features (if any), its specifications, dimensions, jumper/connector settings/definitions, and driver installation instructions (if any), to facilitate users in setting up their product.

Users may refer to the product page on [AAEON.com](http://AAEON.com) for the latest version of this document.

## Safety Precautions

---

Please read the following safety instructions carefully. It is advised that you keep this manual for future references

1. All cautions and warnings on the device should be noted.
2. Make sure the power source matches the power rating of the device.
3. Position the power cord so that people cannot step on it. Do not place anything over the power cord.
4. Always completely disconnect the power before working on the system's hardware.
5. No connections should be made when the system is powered as a sudden rush of power may damage sensitive electronic components.
6. If the device is not to be used for a long time, disconnect it from the power supply to avoid damage by transient over-voltage.
7. Always disconnect this device from any AC supply before cleaning.
8. While cleaning, use a damp cloth instead of liquid or spray detergents.
9. Make sure the device is installed near a power outlet and is easily accessible.
10. Keep this device away from humidity.
11. Place the device on a solid surface during installation to prevent falls
12. Do not cover the openings on the device to ensure optimal heat dissipation.
13. Watch out for high temperatures when the system is running.
14. Do not touch the heat sink or heat spreader when the system is running
15. Never pour any liquid into the openings. This could cause fire or electric shock.
16. As most electronic components are sensitive to static electrical charge, be sure to ground yourself to prevent static charge when installing the internal components. Use a grounding wrist strap and contain all electronic components in any static-shielded containers.

17. If any of the following situations arises, please the contact our service personnel:
  - i. Damaged power cord or plug
  - ii. Liquid intrusion to the device
  - iii. Exposure to moisture
  - iv. Device is not working as expected or in a manner as described in this manual
  - v. The device is dropped or damaged
  - vi. Any obvious signs of damage displayed on the device
  
18. **DO NOT LEAVE THIS DEVICE IN AN UNCONTROLLED ENVIRONMENT WHERE THE STORAGE TEMPERATURE IS BELOW -20° C (-4°F) OR ABOVE 60°C (140°F) TO PREVENT DAMAGE.**

### **Warning!**



This device complies with Part 15 FCC Rules. Operation is subject to the following two conditions: (1) this device may not cause harmful interference, and (2) this device must accept any interference received including interference that may cause undesired operation.

### **Caution:**

*There is a danger of explosion if the battery is incorrectly replaced. Replace only with the same or equivalent type recommended by the manufacturer. Dispose of used batteries according to the manufacturer's instructions and your local government's recycling or disposal directives.*

### **Attention:**

*Il y a un risque d'explosion si la batterie est remplacée de façon incorrecte. Ne la remplacer qu'avec le même modèle ou équivalent recommandé par le constructeur. Recycler les batteries usées en accord avec les instructions du fabricant et les directives gouvernementales de recyclage.*



## China RoHS Requirements (CN)

产品中有毒有害物质或元素名称及含量

AAEON Main Board/ Daughter Board/ Backplane

部件名称	有毒有害物质或元素					
	铅 (Pb)	汞 (Hg)	镉 (Cd)	六价铬 (Cr(VI))	多溴联苯 (PBB)	多溴二苯醚 (PBDE)
印刷电路板 及其电子组件	○	○	○	○	○	○
外部信号 连接器及线材	○	○	○	○	○	○
<p>O: 表示该有毒有害物质在该部件所有均质材料中的含量均在 SJ/T 11363-2006 标准规定的限量要求以下。</p> <p>X: 表示该有毒有害物质至少在该部件的某一均质材料中的含量超出 SJ/T 11363-2006 标准规定的限量要求。</p> <p>备注: 此产品所标示之环保使用期限, 系指在一般正常使用状况下。</p>						

## China RoHS Requirement (EN)

Poisonous or Hazardous Substances or Elements in Products

AAEON Main Board/ Daughter Board/ Backplane

Component	Poisonous or Hazardous Substances or Elements					
	Lead (Pb)	Mercury (Hg)	Cadmium (Cd)	Hexavalent Chromium (Cr(VI))	Polybrominated Biphenyls (PBB)	Polybrominated Diphenyl Ethers (PBDE)
PCB & Other Components	○	○	○	○	○	○
Wires & Connectors for External Connections	○	○	○	○	○	○
<p>O: The quantity of poisonous or hazardous substances or elements found in each of the component's parts is below the SJ/T 11363-2006-stipulated requirement.</p> <p>X: The quantity of poisonous or hazardous substances or elements found in at least one of the component's parts is beyond the SJ/T 11363-2006-stipulated requirement.</p> <p><b>Note:</b> The Environment Friendly Use Period as labeled on this product is applicable under normal usage only</p>						

# Table of Contents

---

<b>Chapter 1 - Product Specifications</b> .....	<b>1</b>
1.1 Specifications .....	2
1.2 Function Block Diagram .....	5
<b>Chapter 2 – Hardware Information</b> .....	<b>6</b>
2.1 Dimensions .....	7
2.2 Jumpers and Connectors.....	9
2.3 List of Jumpers .....	11
2.3.1 Clear CMOS Jumper & Auto Power Button Enable/Disable (JP1) .....	11
2.4 List of Connectors.....	12
2.4.1 RTC Battery Connector (CN1) .....	13
2.4.2 LVDS Back Light Inverter (CN2).....	13
2.4.3 LVDS/eDP [Reserved] (CN3) .....	14
2.4.4 Dual HDMI (CN4) .....	16
2.4.5 Dual RJ45 (CN5).....	19
2.4.6 SATA Port (CN6).....	21
2.4.7 +5V SATA Power Connector (CN7).....	21
2.4.8 DIO 4-bit Header (CN8).....	22
2.4.9 USB 2.0/3.2 GEN 2 Port1~Port2 (CN9) .....	23
2.4.10 USB 2.0 Dual Port Header (CN10).....	24
2.4.11 mSATA/ Mini Card Slot (CN11) .....	25
2.4.12 M.2 E-Key Slot (CN12) .....	27
2.4.13 CAN Bus Dual Port Header (CN13).....	30
2.4.14 COM Dual Port Header (CN15) .....	31
2.4.15 SPI Port (CN17).....	32
2.4.16 eSPI/ SMBus/ I2C (CN18).....	33
2.4.17 4-pin Smart Fan Connector (CN19).....	34

2.4.18	Power Input +12V (CN20).....	34
2.4.19	Front Panel (CN21) .....	35
2.4.20	DC Jack Power Input [Reserved] (CN22).....	36
2.4.21	Single RJ45 [Reserved] (CN23).....	37
2.5	Thermal Assembly Options .....	38
2.5.1	Active Cooling Fan FAN01.....	38
2.5.2	Fan-less Heatspreader HSP01.....	39
2.5.3	Heatsink HSK01 (with Heatspreader).....	40
<b>Chapter 3 - AMI BIOS Setup .....</b>		<b>41</b>
3.1	System Test and Initialization .....	42
3.2	AMI BIOS Setup .....	43
3.3	Setup Submenu: Main.....	44
3.4	Setup Submenu: Advanced.....	45
3.4.1	CPU Configuration.....	46
3.4.2	PCH-FW Configuration .....	47
3.4.2.1	Firmware Update Configuration .....	48
3.4.3	Trusted Computing .....	49
3.4.4	SATA Configuration .....	51
3.4.5	SDIO Configuration.....	52
3.4.6	Hardware Monitor.....	53
3.4.6.1	Smart Fan Mode Configuration .....	54
3.4.7	SIO Configuration .....	55
3.4.7.1	Serial Port Configuration .....	56
3.4.8	AAEON BIOS Robot.....	57
3.4.9	Power Management .....	59
3.4.10	Digital IO Port Configuration .....	60
3.5	Setup Submenu: Chipset .....	61
3.5.1	System Agent (SA) Configuration.....	62

3.5.1.1	Memory Configuration .....	63
3.5.1.2	Graphics Configuration .....	64
3.5.2	PCH-IO Configuration .....	67
3.6	Setup Submenu: Security .....	68
3.6.1	Secure Boot .....	69
3.6.1.1	Key Management .....	70
3.7	Setup Submenu: Boot .....	72
3.8	Setup Submenu: Save & Exit .....	73
<b>Chapter 4</b>	<b>– Drivers Installation .....</b>	<b>74</b>
4.1	Drivers Download and Installation .....	75
<b>Appendix A</b>	<b>– Mating Connectors .....</b>	<b>77</b>
A.1	List of Mating Connectors and Cables .....	78
<b>Appendix B</b>	<b>- I/O Information .....</b>	<b>80</b>
B.1	Direct Memory Access (DMA) Map .....	81
B.2	I/O Address Map .....	82
B.3	IRQ Mapping Chart .....	83
B.4	Large Memory Map .....	94
B.5	Memory Address Map .....	95
<b>Appendix C</b>	<b>- Watchdog Timer Programming .....</b>	<b>97</b>
C.1	Introduction to Watchdog Timer .....	98
C.2	Programing the Watchdog Timer with AAEON SDK .....	99
C.3	Programing Watchdog Timer with AAEON Windows EAPI .....	100
C.3.1	Watchdog Timer Functions .....	101
C.3.1.1	EapiWDogGetCap() .....	101
C.3.1.2	EapiWDogStart() .....	102
C.3.1.3	EapiWDogTrigger() .....	103
C.3.1.4	EapiWDogStop() .....	103
C.3.1.5	EapiWDogReloadTimer() .....	104

C.3.1.6	EapiWDogGetStatus().....	104
C.3.1.7	EapiWDogSetStatus() .....	105

# Chapter 1

---

Product Specifications

## 1.1 Specifications

---

### System

<b>Form Factor</b>	PICO-ITX
<b>CPU</b>	Intel® Atom™ x6000E series, Intel® Pentium and Celeron® N and J series processors Intel® Atom™ x6425RE (4C, 1.9GHz, TDP 12W) Intel® Atom™ x6414RE (4C, 1.5GHz, TDP 9W) Intel® Atom™ x6212RE (2C, 1.2GHz, TDP 6W) Intel® Atom™ x6425E (4C, 2.0GHz, up to 3GHz, TDP 12W) Intel® Atom™ x6413E (4C, 1.5GHz, up to 3GHz, TDP 9W) Intel® Atom™ x6211E (2C, 1.2GHz, up to 3GHz, TDP 6W) Intel® Pentium® J6426 (4C, 1.8GHz, up to 3GHz, TDP 10W) Intel® Pentium® N6415 (4C, 1.2GHz, up to 3GHz, TDP-up 6.5W) Intel® Celeron® J6412 (4C, 1.8GHz, up to 3GHz, TDP 10W) Intel® Celeron® J6210 (2C, 1.2GHz, up to 3GHz, TDP 6.5W) (Intel® Atom™ x6427FE/x6200FE by request)
<b>Chipset</b>	Intel® Elkhart Lake SoC Processor
<b>Memory Type</b>	On Board LPDDR4x 3200 MHz, up to 16GB, support IB ECC (select SKUs)
<b>BIOS</b>	UEFI
<b>Wake On LAN</b>	Yes
<b>Watchdog Timer</b>	255 Levels
<b>Security</b>	Intel® PTT (Integrated TPM)
<b>RTC Battery</b>	Lithium Battery 3V/240mAh
<b>Dimensions</b>	3.94" x 2.84" (100mm x 72mm)
<b>Gross Weight</b>	0.18 lbs. (0.08 kg)



## System

OS Support	Windows 10 (64 bit)
	Ubuntu 20.04.3(IOT)/Kernel 5.13

## Power

Power Requirement	+12V
Power Supply Type	AT/ATX
Connector	Phoenix 2-pin Connector (Default)
	Lockable DC Jack Connector (Colay)
Power Consumption	Intel® Atom™ x6425E, LPDDR4x onboard 16GB, 2.48A@ +12V (Typical)
	Intel® Atom™ x6425E, LPDDR4x onboard 16GB, 2.62A@ +12V (Max)

## Display

Controller	Intel® Atom™ x6000E series, Intel® Pentium and Celeron® N and J series processors
LVDS/eDP	eDP x 1, (up to HBR3, 8K x 4K 30Hz), /LVDS (18/24bit 2CH) default: LVDS
Display Interface	HDMI 2.0b x 1 (4K x 2K 60Hz)
Multiple Display	Up to 3 Simultaneous Displays

## External I/O

Ethernet	Realtek RTL8111H-CG, 10/100/1000Base-TX, RJ-45 x 2
USB	USB 3.2 Gen 2 x 2
Serial Port	RS-232/422/485 x 2
Video	HDMI 2.0b x 2 (4K x 2K 60Hz)

## Internal I/O

USB	USB 2.0 x 2
Serial Port	COM1, COM2 (RS232/422/485, supports 5V/12V/RI)
Video	—
SATA	SATA III x 1 +5V SATA Power Connector x 1
DIO/GPIO	4-Bit
SMBus/I2C	I2C/SMBus x 1 (SMBUS as default, I2C select by BOM)
Touch	—
Fan	4-pin Smart Fan x 1
SIM	—
Front Panel	HDD LED, PWR LED, Power Button, Buzzer, Reset

## Expansion

Mini PCI-E/mSATA	Full size mPCIe/mSATA x 1 (SATA as default, PCIe selected by BIOS)
M.2	M.2 E-Key 2230 x 1 (PCIe x1/USB 2.0)
Others	CANBUS x 2 (optional, N6210/J6412 not support, support up to 5Mbit/s) SMBUS/I2C + eSPI x 1 (SMBUS as default, I2C selected by HW BOM)

## Environmental

Operating Temperature	32°F ~ 140°F (0°C ~ 60°C)
Storage Temperature	-40 °F ~ 176 °F (-40°C ~ 80°C)
Operating Humidity	0% ~ 90% relative humidity, non-condensing
MTBF (Hours)	489,989
EMC	CE/FCC Class A

## 1.2 Function Block Diagram

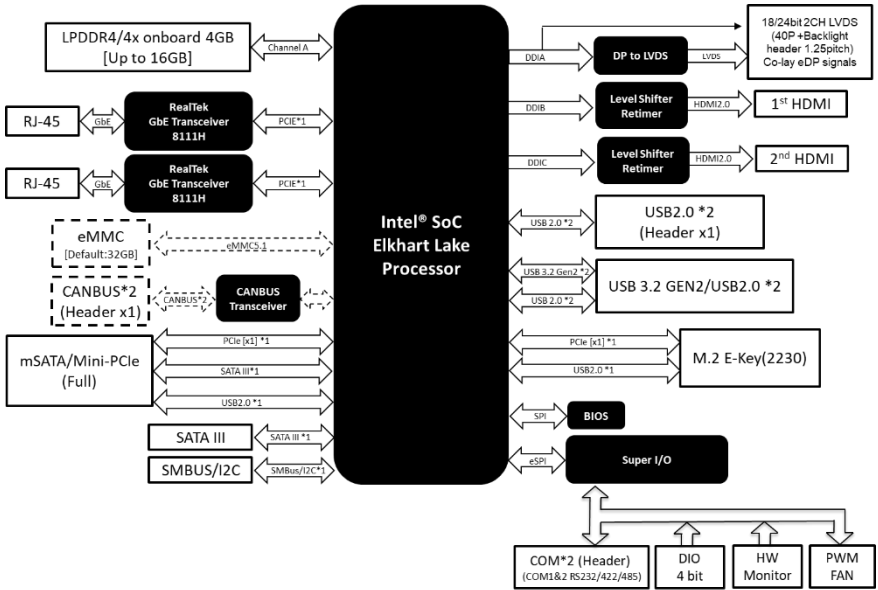

# Chapter 2

---

Hardware Information

## 2.1 Dimensions

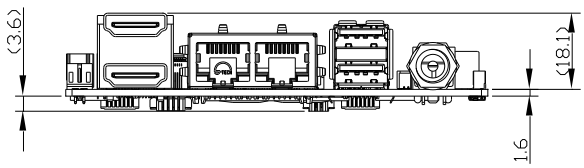
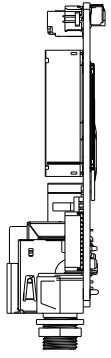
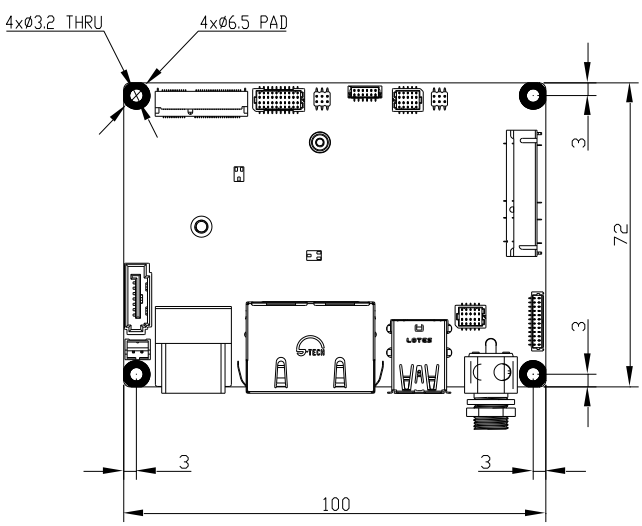

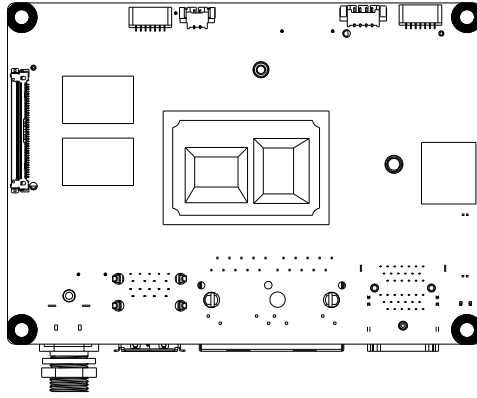

Solder Side

## 2.2 Jumpers and Connectors

Component Side:

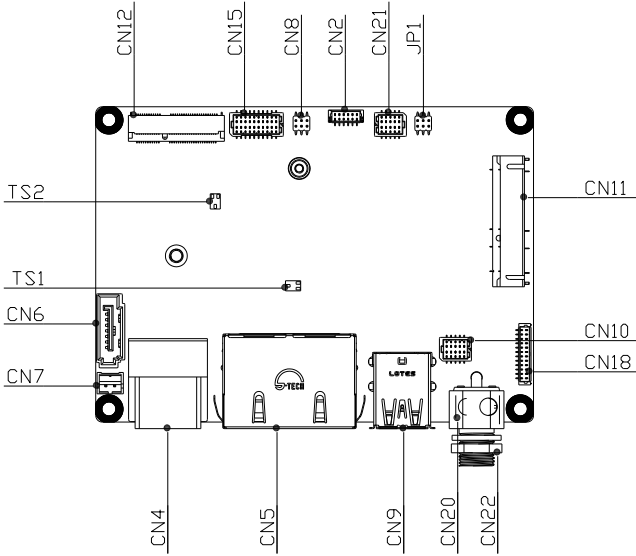

Component Side

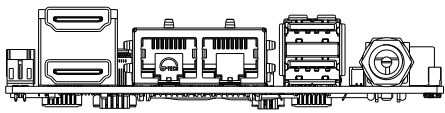
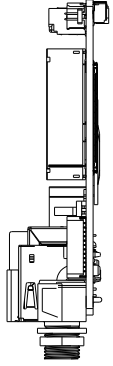

Solder Side:

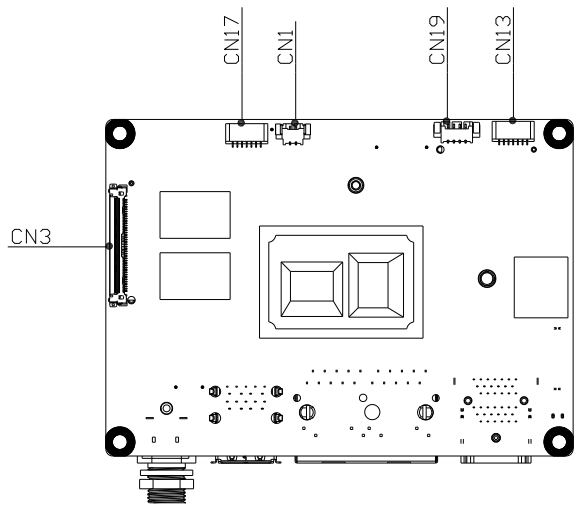



## 2.3 List of Jumpers

Jumpers allow users to manually customize system configurations to their suitable application needs.

Please refer to the table below for all of the board's jumpers that you can configure for your application

Label	Function
JP1	Clear CMOS Jumper & Auto Power Button Enable/Disable

### 2.3.1 Clear CMOS Jumper & Auto Power Button Enable/Disable (JP1)

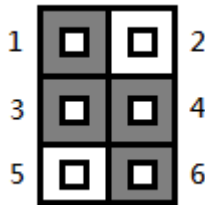

#### Clear CMOS Jumper

1-3	Save CMOS	Default
3-5	Clear CMOS	-

#### Auto Power Button Enable/Disable

2-4	Disable	-
4-6	Enable	Default

## 2.4 List of Connectors

Please refer to the table below for all of the board's connectors that you can configure for your application

Label	Function
CN1	RTC Battery Connector
CN2	LVDS Back Light Inverter
CN3	LVDS/eDP [Reserved]
CN4	Dual HDMI
CN5	Dual RJ45
CN6	SATA
CN7	SATA Power
CN8	4-bit DIO Header
CN9	USB 2.0/3.2 GEN 2 Port1~Port2
CN10	USB 2.0 Header [Support 2 ports]
CN11	mSATA/mini-Card
CN12	M.2 E-Key
CN13	CAN Bus Header [Supports 2 ports]
CN15	COM Header [Supports 2 ports]
CN17	SPI
CN18	eSPI/SMBus/I2C
CN19	4-pin Smart FAN
CN20	Power Input 12V
CN21	Front Panel
CN22	DC Jack Power Input [Reserved]
CN23	Single RJ45 [Reserved]

### 2.4.1 RTC Battery Connector (CN1)

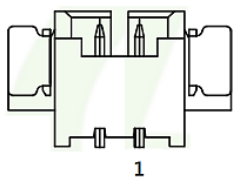

Pin	Pin Name	Signal Type	Signal Level
1	+3.3V	PWR	+3.3V
2	GND	GND	-

### 2.4.2 LVDS Back Light Inverter (CN2)

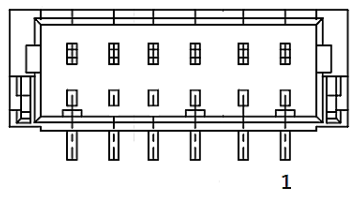

Pin	Pin Name	Signal Type	Signal Level
1	BLK_PWR	PWR	+12V (Default)/ +5V
2	BLK_PWR	PWR	+12V (Default)/ +5V
3	BKL_CONTROL	-	-
4	GND	GND	-
5	GND	GND	-
6	BKL_ENABLE	-	+3.3V

**Note 1:** Backlight Power can be 12V or 5V, set by BOM: SKU R466 for 12V and SKU R2679 for 5V (Default is 12V).

**Note 2:** CN2 max current 2A.

### 2.4.3 LVDS/eDP [Reserved] (CN3)

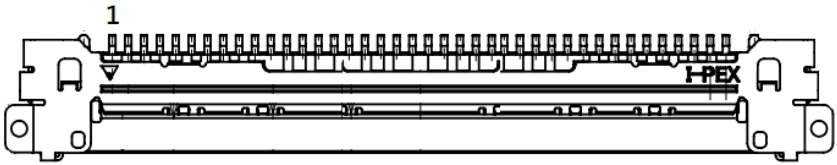

Pin	Pin Name	Signal Type	Signal Level
1	GND	GND	-
2	LVD1_CB_3_DP	DIFF	-
3	LVD1_CB_3_DN	DIFF	-
4	GND	GND	-
5	LVD1_CB_CLKP	DIFF	-
6	LVD1_CB_CLKN	DIFF	-
7	GND	GND	-
8	LVD1_CB_2_DP	DIFF	-
9	LVD1_CB_2_DN	DIFF	-
10	GND	GND	-
11	LVD1_CB_1_DP	DIFF	-
12	LVD1_CB_1_DN	DIFF	-
13	GND	GND	-
14	LVD1_CB_0_DP	DIFF	-
15	LVD1_CB_0_DN	DIFF	-

Pin	Pin Name	Signal Type	Signal Level
16	GND	GND	-
17	+V3P3S	PWR	+3.3V
18	LVD1_DDC_CLK/ DDIO_HPD	Signal	-
19	LVD1_BKLTEN/ DDIO_BKLTEN	Signal	-
20	LVD1_DDC_DATA	Signal	-
21	LVD1_BKLCTL/ DDIO_BKLCTL	Signal	-
22	GND	GND	-
23	LVD1_CA_CLKP/ DDIO_AUX_DP	DIFF	-
24	LVD1_CA_CLKN/ DDIO_AUX_DN	DIFF	-
25	GND	GND	-
26	LVD1_CA_3_DP/ DDIO_LANE3_DP	DIFF	-
27	LVD1_CA_3_DN/ DDIO_LANE3_DN	DIFF	-
28	GND	GND	-
29	LVD1_CA_0_DP/ DDIO_LANE0_DP	DIFF	-
30	LVD1_CA_0_DN/ DDIO_LANE0_DN	DIFF	-
31	GND	GND	-
32	LVD1_CA_1_DP/ DDIO_LANE1_DP	DIFF	-
33	LVD1_CA_1_DN/ DDIO_LANE1_DN	DIFF	-
34	GND	GND	-
35	LVD1_CA_2_DP/ DDIO_LANE2_DP	DIFF	-
36	LVD1_CA_2_DN/ DDIO_LANE2_DN	DIFF	-
37	GND	GND	-

Pin	Pin Name	Signal Type	Signal Level
38	+VDD	PWR	+3.3V
39	+VDD	PWR	+3.3V
40	+VDD	PWR	+3.3V

**Note:** CN3: VDD power current max: 1.5A.

### 2.4.4 Dual HDMI (CN4)

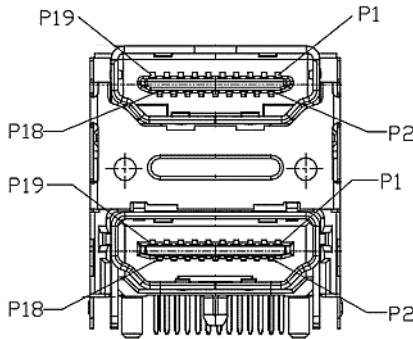

Pin	Pin Name	Signal Type	Signal Level
1	HDMI_TX2+	DIFF	-
2	GND	GND	-
3	HDMI_TX2-	DIFF	-
4	HDMI_TX1+	DIFF	-
5	GND	GND	-
6	HDMI_TX1-	DIFF	-
7	HDMI_TX0+	DIFF	-
8	GND	GND	-

Pin	Pin Name	Signal Type	Signal Level
9	HDMI_TX0-	DIFF	-
10	HDMI_CLK+	DIFF	-
11	GND	GND	-
12	HDMI_CLK-	DIFF	-
13	NC	-	-
14	NC	-	-
15	DDC_CLK	I/O	+5V
16	DDC_DATA	I/O	+5V
17	GND	GND	-
18	+5V	PWR	+5V
19	HDMI_HPD	-	-
20	HDMI_TX2+	DIFF	-
21	GND	GND	-
22	HDMI_TX2-	DIFF	-
23	HDMI_TX1+	DIFF	-
24	GND	GND	-
25	HDMI_TX1-	DIFF	-
26	HDMI_TX0+	DIFF	-
27	GND	GND	-
28	HDMI_TX0-	DIFF	-
29	HDMI_CLK+	DIFF	-
30	GND	GND	-
31	HDMI_CLK-	DIFF	-
32	NC	-	-
33	NC	-	-
34	DDC_CLK	I/O	+5V

Pin	Pin Name	Signal Type	Signal Level
35	DDC_DATA	I/O	+5V
36	GND	GND	-
37	+5V	PWR	+5V
38	HDMI_HPD	-	-



## 2.4.5 Dual RJ45 (CN5)

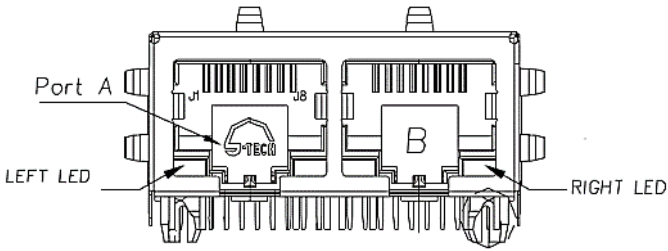

Pin	Pin Name	Signal Type	Signal Level
1P1	LAN1_MDI0+	DIFF	-
1P2	LAN1_MDI0-	DIFF	-
1P3	LAN1_MDI1+	DIFF	-
1P4	LAN1_MDI1-	DIFF	-
1P5	GND	GND	-
1P6	GND	GND	-
1P7	LAN1_MDI2+	DIFF	-
1P8	LAN1_MDI2-	DIFF	-
1P9	LAN1_MDI3+	DIFF	-
1P10	LAN1_MDI3-	DIFF	-
1L1	LAN1_LED_LNK#_ACT	Signal	-
1L2	+V3P3A	VDD	3.3V
1L3	LAN1_LED_100#	Signal	-
1L4	LAN1_LED_1000#	Signal	-
2P1	LAN2_MDI0+	DIFF	-
2P2	LAN2_MDI0-	DIFF	-
2P3	LAN2_MDI1+	DIFF	-

Pin	Pin Name	Signal Type	Signal Level
2P4	LAN2_MDI1-	DIFF	-
2P5	GND	GND	-
2P6	GND	GND	-
2P7	LAN2_MDI2+	DIFF	-
2P8	LAN2_MDI2-	DIFF	-
2P9	LAN2_MDI3+	DIFF	-
2P10	LAN2_MDI3-	DIFF	-
2L1	LAN2_LED_LNK#_ACT	Signal	-
2L2	+V3P3A	VDD	3.3V
2L3	LAN2_LED_100#	Signal	-
2L4	LAN2_LED_1000#	Signal	-

## 2.4.6 SATA Port (CN6)

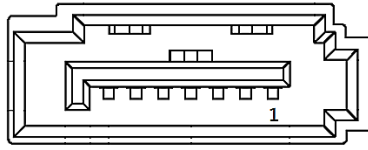

Pin	Pin Name	Signal Type	Signal Level
1	GND	GND	-
2	SATA_1_TXP	DIFF	-
3	SATA_1_TXN	DIFF	-
4	GND	GND	-
5	SATA_1_RXN	DIFF	-
6	SATA_1_RXP	DIFF	-
7	GND	GND	-

## 2.4.7 +5V SATA Power Connector (CN7)

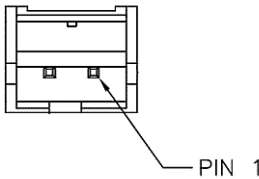

Pin	Pin Name	Signal Type	Signal Level
1	+V5S	VDD	+5V
2	GND	GND	-

**Note:** CN7 SATA Power max current 1.5A.

## 2.4.8 DIO 4-bit Header (CN8)

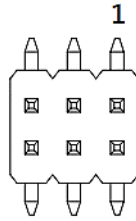

Pin	Pin Name	Signal Type	Signal Level
1	+V5S	VDD	5V
2	DIO_0	Signal	-
3	DIO_1	Signal	-
4	DIO_2	Signal	-
5	DIO_3	Signal	-
6	GND	GND	GND

**Note:** CN8 DIO power max current: 0.5A.

## 2.4.9 USB 2.0/3.2 GEN 2 Port1~Port2 (CN9)

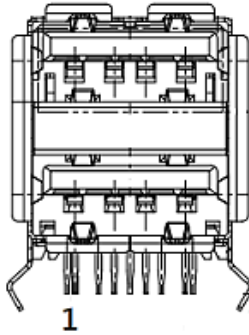

Pin	Pin Name	Signal Type	Signal Level
1	+V5A_USB12	PWR	+5V
2	USB2_0_DN	DIFF	-
3	USB2_0_DP	DIFF	-
4	GND	GND	-
5	USB3_0_RXN	DIFF	-
6	USB3_0_RXP	DIFF	-
7	GND	GND	-
8	USB3_0_TXN	DIFF	-
9	USB3_0_TXP	DIFF	-
10	+V5A_USB12	PWR	+5V
11	USB2_1_DN	DIFF	-
12	USB2_1_DP	DIFF	-
13	GND	GND	-
14	USB3_1_RXN	DIFF	-
15	USB3_1_RXP	DIFF	-

Pin	Pin Name	Signal Type	Signal Level
16	GND	GND	-
17	USB3_1_TXN	DIFF	-
18	USB3_1_TXP	DIFF	-

**Note:** CN9 USB Power max current: 2.0A, 1.0A for each port.

### 2.4.10 USB 2.0 Dual Port Header (CN10)

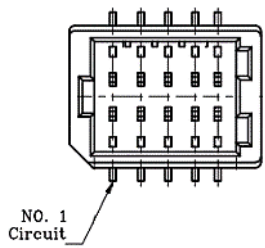

Pin	Pin Name	Signal Type	Signal Level
1	+V5A_USB34	PWR	+5V
2	+V5A_USB34	PWR	+5V
3	USB2_2_DN	DIFF	-
4	USB2_3_DN	DIFF	-
5	USB2_2_DP	DIFF	-
6	USB2_3_DP	DIFF	-
7	GND	GND	-
8	GND	GND	-
9	GND	GND	-
10	GND	GND	-

**Note:** CN10 USB Power max current: 2.0A, 1.0A for each port.

## 2.4.11 mSATA/ Mini Card Slot (CN11)

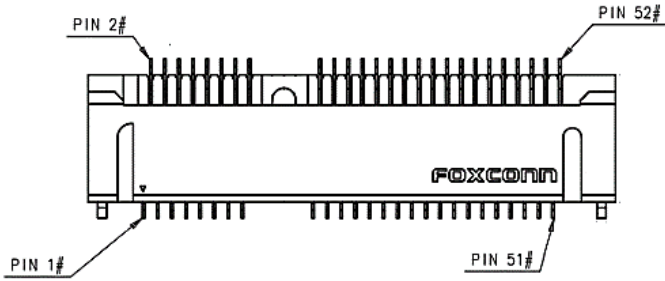

Pin	Pin Name	Signal Type	Signal Level
1	PCIE_WAKE#	IN	-
2	+3.3V	PWR	+3.3V
3	NC	-	-
4	GND	GND	-
5	NC	-	-
6	+1.5V	PWR	+1.5V
7	PCIE_CLK_REQ#	IN	-
8	NC	-	-
9	GND	GND	-
10	NC	-	-
11	PCIE_REF_CLK-	DIFF	-
12	NC	-	-
13	PCIE_REF_CLK+	DIFF	-
14	NC	-	-
15	GND	GND	-
16	NC	-	-

Pin	Pin Name	Signal Type	Signal Level
17	NC	-	-
18	GND	GND	-
19	NC	-	-
20	W_DISABLE#	OUT	+3.3V
21	GND	GND	-
22	PCIE_RST#	OUT	+3.3V
23	PCIE_RX-/SATA_RX+	DIFF	-
24	+3.3V	PWR	+3.3V
25	PCIE_RX+/SATA_RX-	DIFF	-
26	GND	GND	-
27	GND	GND	-
28	+1.5V	PWR	+1.5V
29	GND	GND	-
30	SMB_CLK	I/O	+3.3V
31	PCIE_TX-/SATA_TX-	DIFF	-
32	SMB_DATA	I/O	+3.3V
33	PCIE_TX+/SATA_TX+	DIFF	-
34	GND	GND	-
35	GND	GND	-
36	USB_D-	DIFF	-
37	GND	GND	-
38	USB_D+	DIFF	-
39	+3.3V	PWR	+3.3V
40	GND	GND	-
41	+3.3V	PWR	+3.3V
42	NC	-	-



Pin	Pin Name	Signal Type	Signal Level
43	GND	GND	-
44	NC	-	-
45	NC	-	-
46	NC	-	-
47	NC	-	-
48	+1.5V	PWR	+1.5V
49	NC	-	-
50	GND	GND	-
51	NC	-	-
52	+3.3V	PWR	+3.3V

### 2.4.12 M.2 E-Key Slot (CN12)

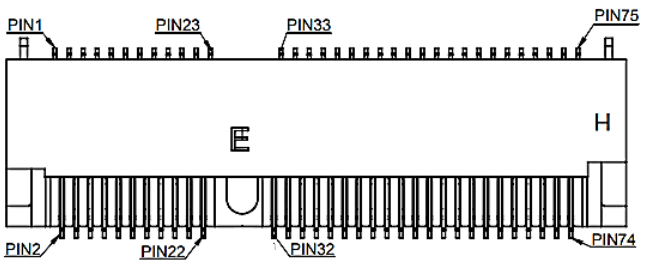

Pin	Pin Name	Signal Type	Signal Level
1	GND	GND	-
2	+V3P3A	PWR	3.3V
3	USB2_4_DP	DIFF	-
4	+V3P3A	PWR	3.3V
5	USB2_4_DN	DIFF	-

Pin	Pin Name	Signal Type	Signal Level
6	NC	-	-
7	GND	GND	-
8	NC	-	-
9	NC	-	-
10	NC	-	-
11	NC	-	-
12	NC	-	-
13	NC	-	-
14	NC	-	-
15	NC	-	-
16	NC	-	-
17	NC	-	-
18	GND	GND	--
19	NC	-	-
20	NC	-	-
21	NC	-	-
22	NC	-	-
23	NC	-	-
32	NC	-	-
33	GND	GND	-
34	NC	-	-
35	PCIE_2_TXP	DIFF	-
36	NC	-	-
37	PCIE_2_TXN	DIFF	-
38	NC	-	-
39	GND	GND	-

Pin	Pin Name	Signal Type	Signal Level
40	NC	-	-
41	PCIE_2_RXP	DIFF	-
42	NC	-	-
43	PCIE_2_RXN	GND	-
44	NC	-	-
45	GND	GND	-
46	NC	-	-
47	PCIE_0_CLK_DP	DIFF	-
48	NC	-	-
49	PCIE_0_CLK_DN	DIFF	-
50	NC	-	--
51	GND	GND	-
52	BUF_PLT_RST#	Signal	-
53	PCIE_CLKREQ#0	Signal	-
54	SOC_BT_EN	Signal	-
55	PCIE_WAKE#	Signal	-
56	SOC_WIFI_EN	Signal	-
57	GND	GND	--
58	NC	-	-
59	NC	-	-
60	NC	-	-
61	NC	-	-
62	NC	-	-
63	GND	GND	-
64	NC	-	-
65	NC	-	-

Pin	Pin Name	Signal Type	Signal Level
66	NC	-	-
67	NC	-	-
68	NC	-	-
69	GND	GND	-
70	NC	-	-
71	NC	-	-
72	+V3P3A	PWR	3.3V
73	NC	-	-
74	+V3P3A	PWR	3.3V
75	GND	GND	-

### 2.4.13 CAN Bus Dual Port Header (CN13)

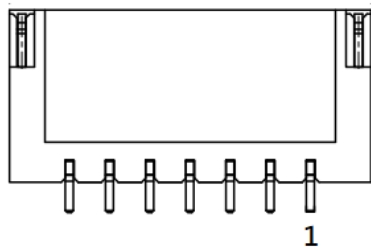

Pin	Pin Name	Signal Type	Signal Level
1	+V5A	PWR	+5V
2	+V3P3A	PWR	+3.3V
3	CAN_BUS0_H	-	-
4	CAN_BUS0_L	-	-
5	GND	GND	-
6	CAN_BUS1_H	-	-
7	CAN_BUS1_L	-	-

## 2.4.14 COM Dual Port Header (CN15)

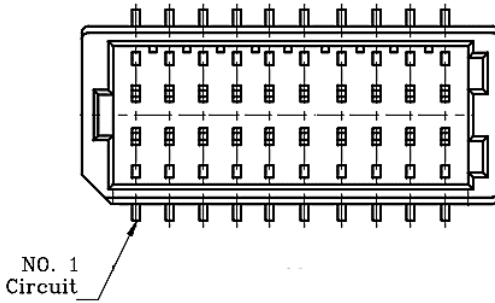

Pin	RS232 Signal	RS422 Signal	RS485 Signal
1	DCD_1	TX_1-	DATA_1-
2	DCD_2	TX_2-	DATA_2-
3	RX_1	TX_1+	DATA_1+
4	RX_2	TX_2+	DATA_2+
5	TX_1	RX_1+	-
6	TX_2	RX_2+	-
7	DTR_1	RX_1-	-
8	DTR_2	RX_2-	-
9	GND	GND	GND
10	GND	GND	GND
11	DSR_1	-	-
12	DSR_2	-	-
13	RTS_1	-	-
14	RTS_2	-	-
15	CTS_1	-	-
16	CTS_2	-	-
17	RI_1/12V/5V	-	-
18	RI_2/12V/5V	-	-

Pin	RS232 Signal	RS422 Signal	RS485 Signal
19	UART_TX	-	-
20	UART_RX	-	-

**Note 1:** COM RS-232/ 422/ 485 mode can be set by BIOS. Default is RS-232.

**Note 2:** RI1/+5V/+12V can be set by BOM (R423 RI/ R369 +12V/ R370 +5V). Default is RING.

**Note 3:** RI2/+5V/+12V can be set by BOM (R424 RI/ R372 +12V/ R373 +5V). Default is RING.

**Note 4:** Max current: 0.5A for each port.

### 2.4.15 SPI Port (CN17)

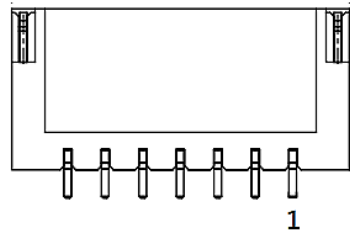

Pin	Pin Name	Signal Type	Signal Level
1	SPI_SO	Signal	-
2	GND	GND	-
3	SPI_CLK	Signal	-
4	+V3P3A_SPI	PWR	+3.3V
5	SPI_SI	Signal	-
6	SPI_CS	Signal	-
7	NC	-	-

## 2.4.16 eSPI/ SMBus/ I2C (CN18)

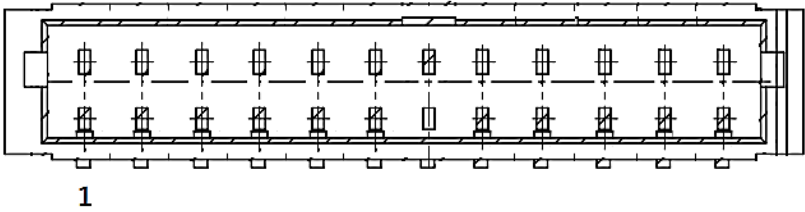

Pin	Pin Name	Signal Type	Signal Level
1	ESPI_IO0	IN/OUT	+1.8V
2	ESPI_IO1	IN/OUT	+1.8V
3	ESPI_IO2	IN/OUT	+1.8V
4	ESPI_IO3	IN/OUT	+1.8V
5	+V3.3S	PWR	+3.3V
6	ESPI_CS	Signal	-
7	ESPI_RESET#	OUT	+1.8V
8	GND	GND	-
9	ESPI_CLK	OUT	1.8V
10	SMB_DATA/ I2C_SDA	IN/OUT	+3.3V
11	SMB_CLK/ I2C_CLK	OUT	+3.3V
12	SMB_ALERT/ INT_SERIRQ	IN	+3.3V

### 2.4.17 4-pin Smart Fan Connector (CN19)

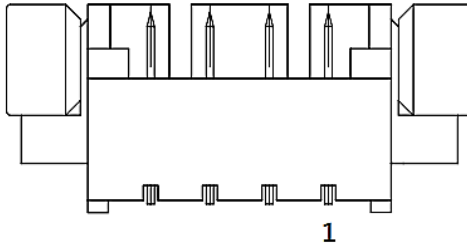

Pin	Pin Name	Signal Type	Signal Level
1	GND	GND	-
2	+V12S	PWR	+12V
3	FAN_TAC	Signal	-
4	FAN_CTL	Signal	-

**Note:** CN19 Smart Fan power max current: 1.0A.

### 2.4.18 Power Input +12V (CN20)

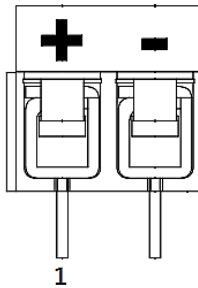

Pin	Pin Name	Signal Type	Signal Level
1	+V_IN	PWR	+12V
2	GND	GND	-



## 2.4.19 Front Panel (CN21)

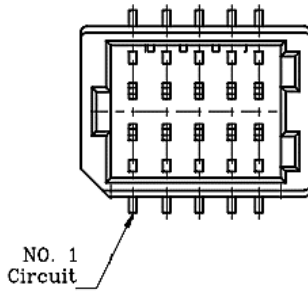

Pin	Pin Name	Signal Type	Signal Level
1	GND	GND	-
2	EXT_PWRBTN#	Signal	-
3	FP_IDELED#	Signal	-
4	+V3P3S	PWR	+3.3V
5	FP_BUZZER	Signal	-
6	+V5S	PWR	+5V
7	GND	-	-
8	+V3P3S	PWR	+3.3V
9	GND	-	-
10	HWRST#	Signal	-

## 2.4.20 DC Jack Power Input [Reserved] (CN22)

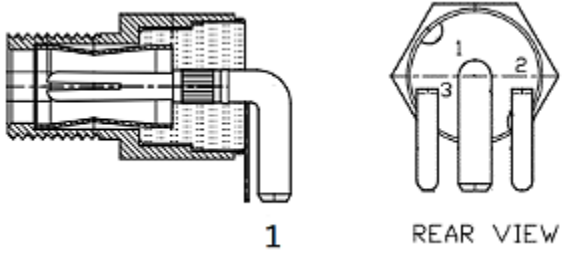

Pin	Pin Name	Signal Type	Signal Level
1	+V_IN	PWR	+12V
2	GND	GND	-
3	GND	GND	-

## 2.4.21 Single RJ45 [Reserved] (CN23)

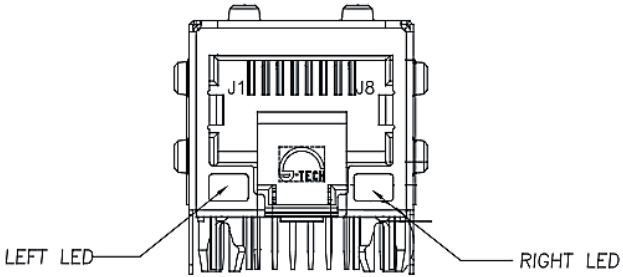

Pin	Pin Name	Signal Type	Signal Level
1P1	LAN1_MDI0+	DIFF	-
1P2	LAN1_MDI0-	DIFF	-
1P3	LAN1_MDI1+	DIFF	-
1P4	LAN1_MDI1-	DIFF	-
1P5	GND	GND	-
1P6	GND	GND	-
1P7	LAN1_MDI2+	DIFF	-
1P8	LAN1_MDI2-	DIFF	-
1P9	LAN1_MDI3+	DIFF	-
1P10	LAN1_MDI3-	DIFF	-
1L1	LAN1_LED_LNK#_ACT	Signal	-
1L2	+V3P3A	VDD	3.3V
1L3	LAN1_LED_100#	Signal	-
1L4	LAN1_LED_1000#	Signal	-

## 2.5 Thermal Assembly Options

### 2.5.1 Active Cooling Fan FAN01

Active Cooling Fan, Part Number: PICO-EHL4-FAN01

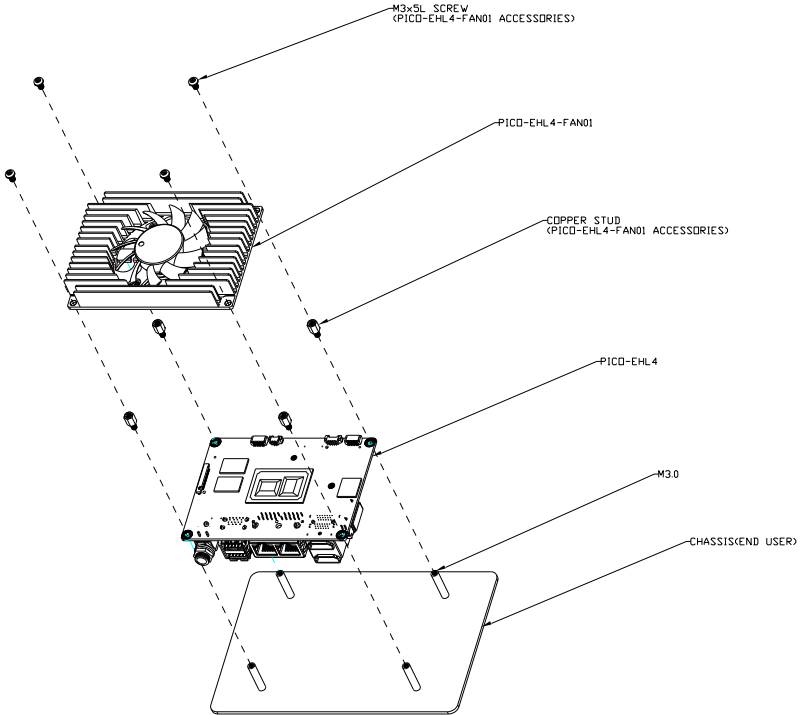

## 2.5.2 Fan-less Heatspreader HSP01

Heat spreader/ fan-less assembly, Part Number: PICO-EHL4-HSP01

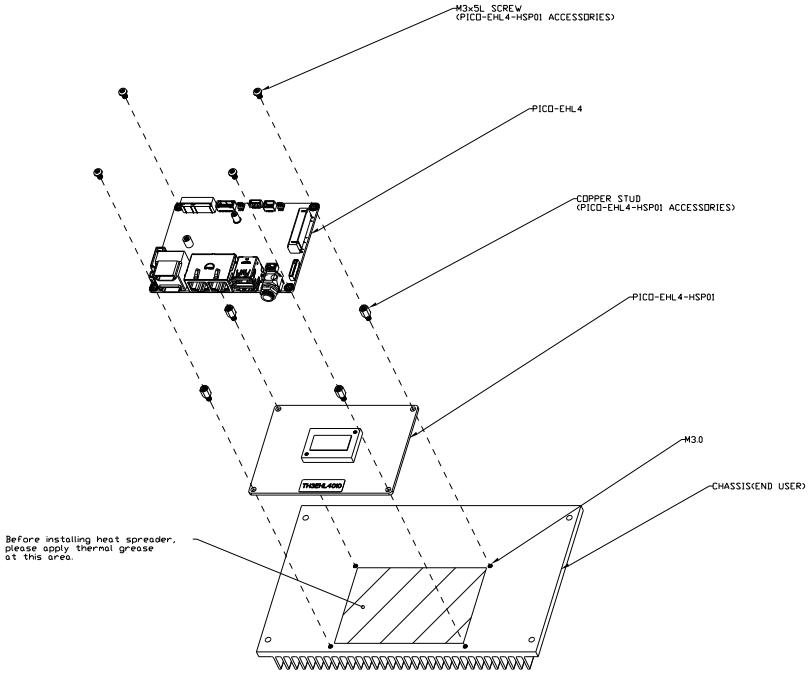

## 2.5.3 Heatsink HSK01 (with Heatspreader)

Heatsink with heatspreader, Part Number: PICO-EHL4-HSK01

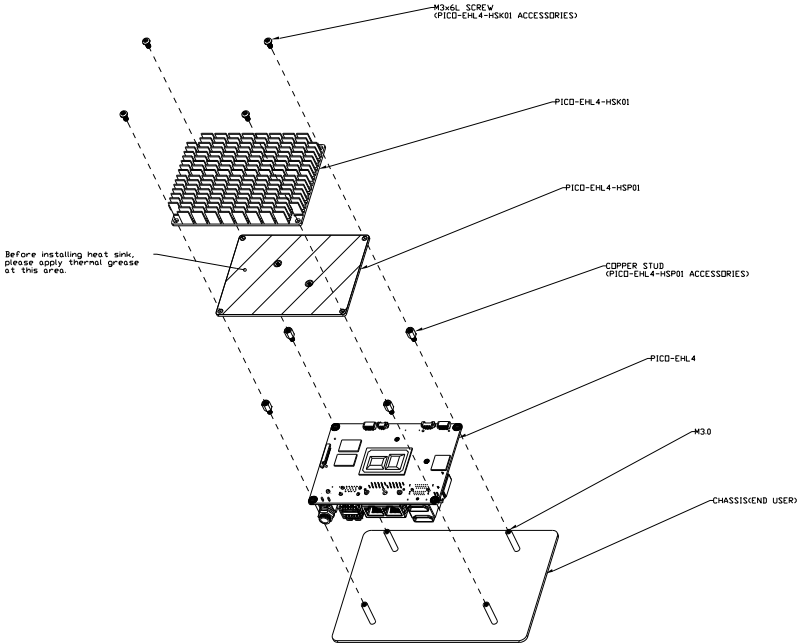

# Chapter 3

---

AMI BIOS Setup

## 3.1 System Test and Initialization

---

These routines test and initialize board hardware. If the routines encounter an error during the tests, you will either hear a few short beeps or see an error message on the screen. There are two kinds of errors: fatal and non-fatal. The system can usually continue the boot up sequence with non-fatal errors.

### System configuration verification

These routines check the current system configuration stored in the CMOS memory and BIOS NVRAM. If system configuration is not found or a system configuration data error is detected, the system will load optimized default and re-boot with this default system configuration automatically.

There are four situations in which you will need to setup system configuration:

1. You are starting your system for the first time
2. You have changed the hardware attached to your system
3. The system configuration is reset by Clear-CMOS jumper
4. The CMOS memory has lost power and the configuration information has been erased.

The PICO-EHL4-A11 CMOS memory has an integral lithium battery backup for data retention. However, you will need to replace the complete unit when it finally runs down.



## 3.2 AMI BIOS Setup

---

AMI BIOS ROM has a built-in Setup program that allows users to modify the basic system configuration. This type of information is stored in battery-backed CMOS RAM and BIOS NVRAM so that it retains the Setup information when the power is turned off.

### Entering Setup

Power on the computer and press <Del> or <ESC> immediately. This will allow you to enter Setup.

### Main

Set the date, use tab to switch between date elements.

### Advanced

Enable/disable boot option for legacy network devices.

### Chipset

Host bridge parameters.

### Boot

Enables/disables quiet boot option.

### Security

Set setup administrator password.

### Save & Exit

Exit system setup after saving the changes.

### 3.3 Setup Submenu: Main

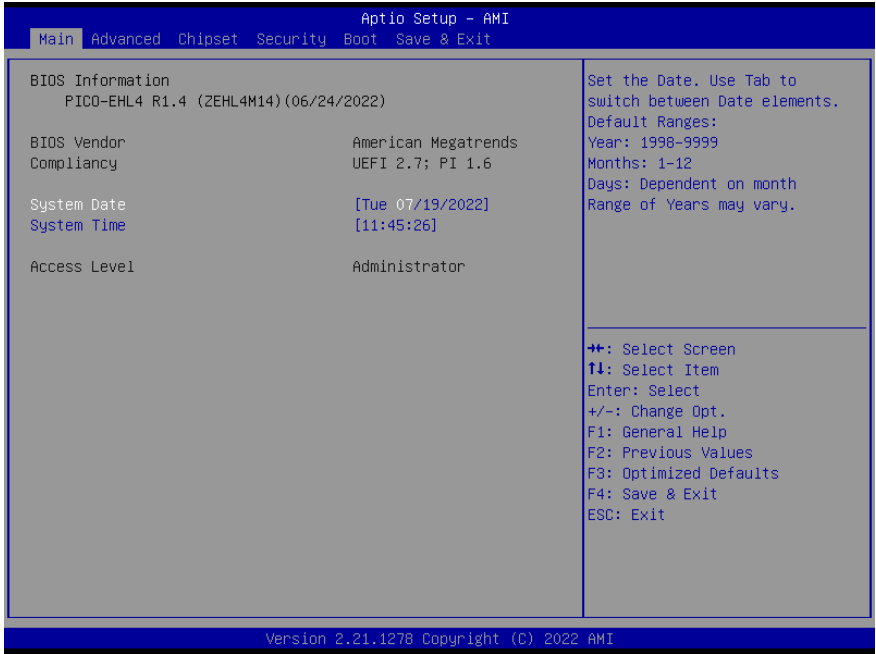

### 3.4 Setup Submenu: Advanced

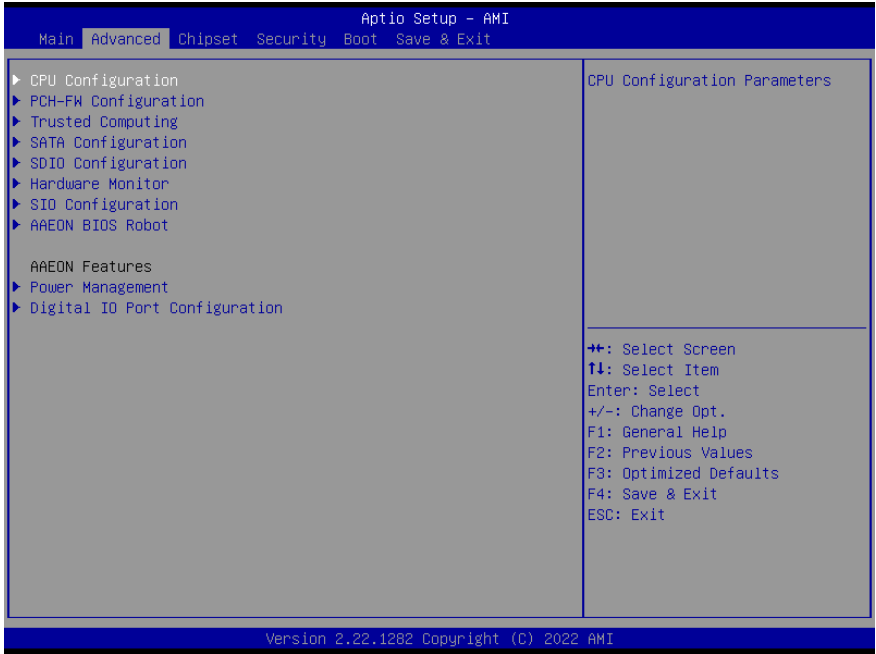

### 3.4.1 CPU Configuration

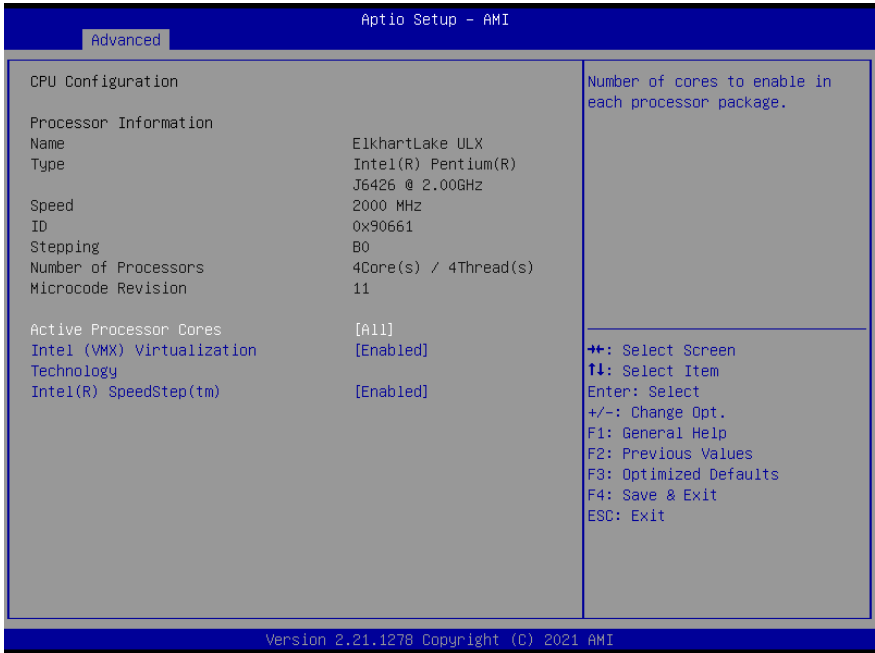

Options Summary		
Active Processor Cores	All	Optimal Default, Failsafe Default
	1~N	
Number of cores to enable in each processor package.		
Intel (VMX) Virtualization Technology	Disabled	
	Enabled	Optimal Default, Failsafe Default
When enabled, a VMM can utilize the additional hardware capabilities provided by Vanderpool Technology.		

## 3.4.2 PCH-FW Configuration

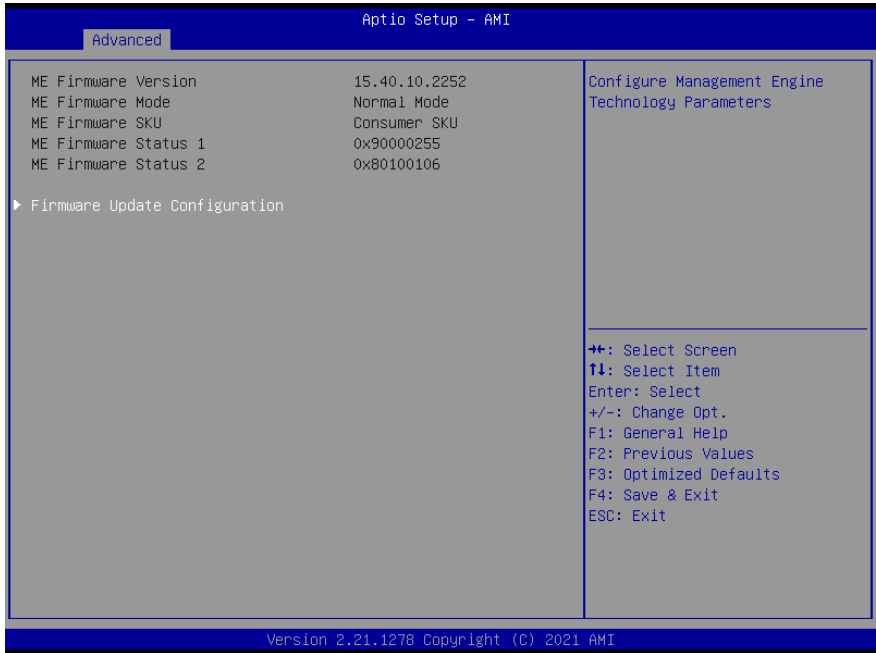

### 3.4.2.1 Firmware Update Configuration

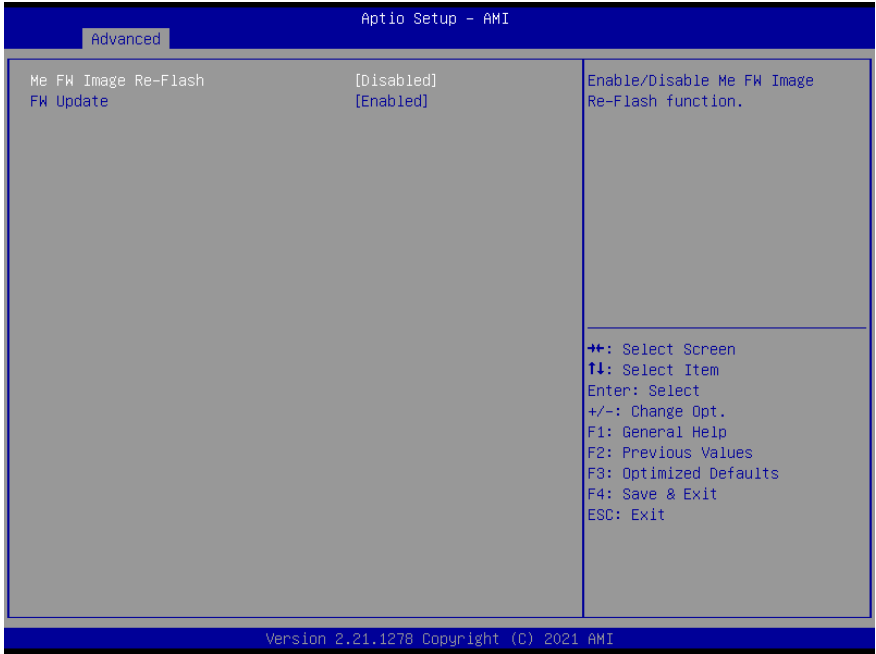

Options Summary		
Me FW Image Re-Flash	Enabled	
	Disabled	Optimal Default, Failsafe Default
Enable/Disable Me FW Image Re-Flash function.		
FW Update	Disabled	
	Enabled	Optimal Default, Failsafe Default
Enable/Disable ME FW Update function.		

### 3.4.3 Trusted Computing

Aptio Setup - AMI

**Advanced**

TPM 2.0 Device Found Firmware Version: 600.15 Vendor: INTC	Enables or Disables BIOS support for security device. O.S. will not show Security Device. TCG EFI protocol and INT1A interface will not be available.
Security Device Support [Enable] Active PCR banks SHA256 Available PCR banks SHA-1,SHA256,SHA384,SM3	
SHA-1 PCR Bank [Disabled] SHA256 PCR Bank [Enabled] SHA384 PCR Bank [Disabled] SM3_256 PCR Bank [Disabled]	
Pending operation [None] Platform Hierarchy [Enabled] Storage Hierarchy [Enabled] Endorsement Hierarchy [Enabled] TPM 2.0 UEFI Spec Version [TCG_2] Physical Presence Spec Version [1.3] TPM 2.0 InterfaceType [CRB] Device Select [Auto]	+*: Select Screen ↑↓: Select Item Enter: Select +/-: Change Opt. F1: General Help F2: Previous Values F3: Optimized Defaults F4: Save & Exit ESC: Exit

Version 2.21.1278 Copyright (C) 2021 AMI

Options Summary		
Security Device Support	Enable	Optimal Default, Failsafe Default
	Disable	
Enables or Disables BIOS support for security device. O.S. will not show Security Device. TCG EFI protocol and INT1A interface will not be available.		
SHA-1 PCR Bank	Disabled	Optimal Default, Failsafe Default
	Enabled	
Enable or Disable SHA-1 PCR Bank		
SHA256 PCR Bank	Enabled	Optimal Default, Failsafe Default
	Disabled	
Enable or Disable SHA256 PCR Bank.		
SHA384 PCR Bank	Enabled	Optimal Default, Failsafe Default
	Disabled	
Enable or Disable SHA384 PCR Bank.		

Options Summary		
SM3_256 PCR Bank	Enabled	Optimal Default, Failsafe Default
	Disabled	
Enable or Disable SM3_256 PCR Bank		
Pending operation	None	Optimal Default, Failsafe Default
	TPM Clear	
Schedule an Operation for the Security Device. NOTE: Your Computer will reboot during restart in order to change State of Security Device.		
Platform Hierarchy	Enabled	Optimal Default, Failsafe Default
	Disabled	
Enable or Disable Platform Hierarchy		
Storage Hierarchy	Enabled	Optimal Default, Failsafe Default
	Disabled	
Enable or Disable Storage Hierarchy		
Endorsement Hierarchy	Enabled	Optimal Default, Failsafe Default
	Disabled	
Enable or Disable Endorsement Hierarchy		
TPM 2.0 UEFI Spec Version	TCG_2	Optimal Default, Failsafe Default
	TCG_1_2	
Select the TCH2 Spec Version Support. TCG_1_2: The Compatible mode for Win8/Win10 TCG_2: Support new TCG2 protocol and event format for Win10 or later		
Physical Presence Spec Version	1.3	Optimal Default, Failsafe Default
	1.2	
Select to Tell O.S. to support PPI Spec Version 1.2 or 1.3. Note some HCK tests might not support 1.3		
Device Select	Auto	Optimal Default, Failsafe Default
	TPM 1.2	
	TPM 2.0	
TPM 1.2 will restrict support to TPM 1.2 devices, TPM 2.0 will restrict support to TPM 2.0 devices, Auto will support both with the default set to TPM 2.0 devices if not found, TPM 1.2 devices will be enumerated.		



### 3.4.4 SATA Configuration



Options Summary		
SATA Controller(s)	Enabled	Optimal Default, Failsafe Default
	Disabled	
Enable/Disable SATA Device.		
Port*	Enabled	Optimal Default, Failsafe Default
	Disabled	
Enable or Disable SATA Port.		

### 3.4.5 SDIO Configuration

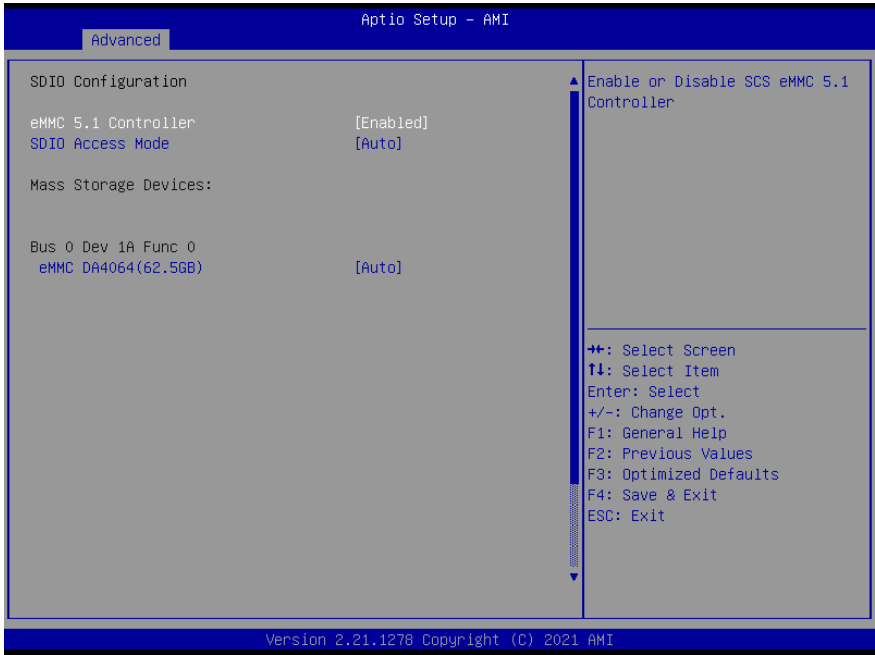

Options Summary		
eMMC 5.1 Controller	Enabled	Optimal Default, Failsafe Default
	Disabled	
Enable or Disable SCS eMMC 5.1 Controller		
SDIO Access Mode	Auto	Optimal Default, Failsafe Default
	ADMA	
	SDMA	
<p><b>Auto Option:</b> Access SD device in DMA mode if controller supports it, otherwise in PIO mode.</p> <p><b>DMA Option:</b> Access SD device in DMA mode.</p> <p><b>PIO Option:</b> Access SD device in PIO mode.</p>		

### 3.4.6 Hardware Monitor

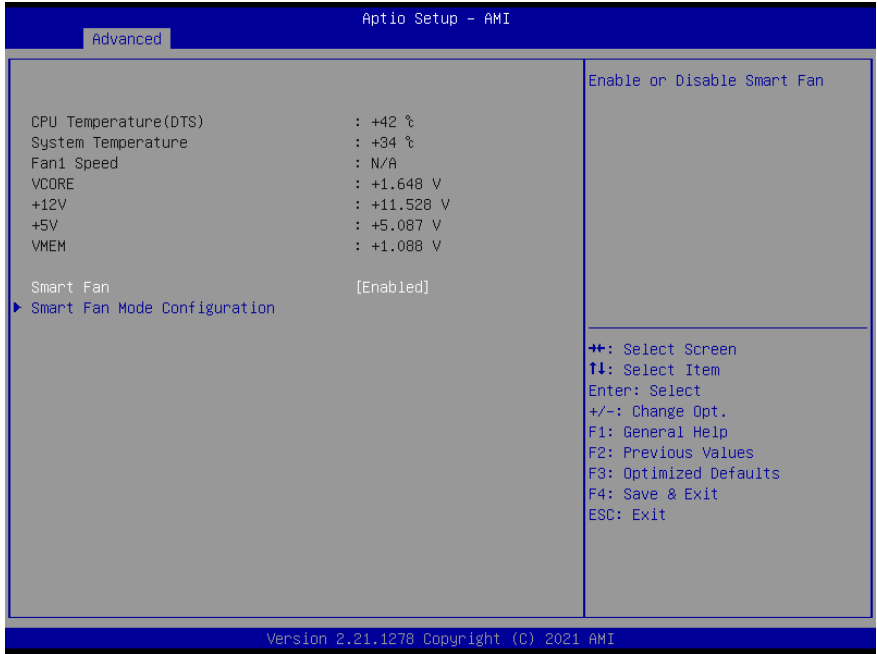

### 3.4.6.1 Smart Fan Mode Configuration

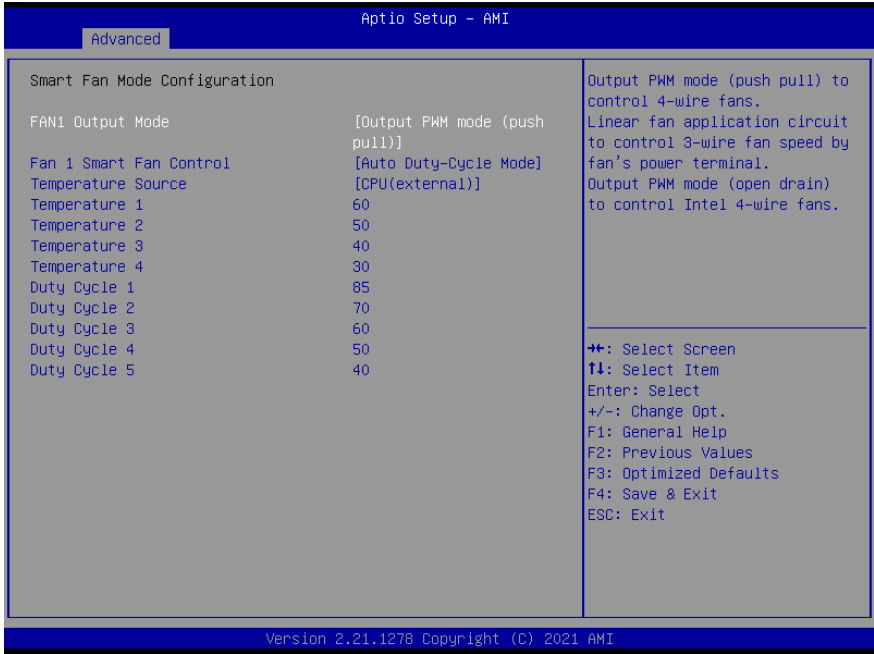

Options Summary		
Fan1 Output Mode	Output PWM mode (open drain)	
	Output PWM mode (push pull)	Optimal Default, Failsafe Default
Output PWM mode (push pull) to control 4-wire fans. Linear fan application circuit to control 3-wire fan speed by fan's power terminal. Output PWM mode (open drain) to control Intel 4-wire fans.		
Fan1 Smart Fan control	Manual Duty Mode	
	Auto Duty-Cycle Mode	Optimal Default, Failsafe Default
Smart Fan Mode select		
Manual Duty Mode	60	Optimal Default, Failsafe Default
Manual mode fan control, user can write expected duty cycle (PWM fan type) 1-100		

### 3.4.7 SIO Configuration



### 3.4.7.1 Serial Port Configuration



Options Summary		
Use This Device	Disabled	
	Enabled	Optimal Default, Failsafe Default
Enable or Disable Serial Port (COM)		
Possible:	Use Automatic Settings	Optimal Default, Failsafe Default
	IO=2F8; IRQ=3;	
	IO=3F8; IRQ=4;	
Select an optimal setting for IO device		
Mode	RS232	Optimal Default, Failsafe Default
	RS422	
	RS485	
Uart RS232/422/485 selection		

### 3.4.8 AAEON BIOS Robot



Options Summary		
Sends watch dog before BIOS POST	Disabled	Optimal Default, Failsafe Default
	Enabled	
Enabled - Robot set Watch Dog Timer (WDT) right after power on, before BIOS start POST process. And then Robot will clear WDT on completion of POST. WDT will reset system automatically if it is not cleared before its timer counts down to zero.		
POST Timer (second)	30	Optimal Default, Failsafe Default
Timer count set to Watch Dog Timer for POST. WARNING: Do not set to a value equal or shorter than normal POST time, otherwise system may never complete POST unless clearing BIOS settings. More than 2x normal POST time is suggested.		
Sends watch dog before booting OS	Disabled	Optimal Default, Failsafe Default
	Enabled	

Enabled - Robot set Watch Dog Timer (WDT) after POST completion, before BIOS transfer control to OS. WARNING: Before enabling this function, a program in OS must be in responsible for clearing WDT. Also, this function should be disabled if OS is going to update itself.		
<b>OS Timer (minute)</b>	3	Optimal Default, Failsafe Default
Timer count set to Watch Dog Timer for OS loading.		
<b>Delayed POST (PEI phase)</b>	Disabled	Optimal Default, Failsafe Default
	Enabled	
Enabled - Robot holds BIOS from starting POST, right after power on. This allows BIOS POST to start with stable power or start after system is physically warmed-up. Note: Robot does this before 'Sends watch dog'.		
<b>Delayed time (second)</b>	10	Optimal Default, Failsafe Default
Period of time for Robot to hold BIOS from POST.		
<b>Delayed POST (DXE phase)</b>	Disabled	Optimal Default, Failsafe Default
	Enabled	
Enabled - Robot holds BIOS before POST completion. This allows BIOS POST to start with stable power or start after system is physically warmed-up. Note: Robot does this after 'Sends watch dog before BIOS POST'		
<b>Delayed time (second)</b>	10	Optimal Default, Failsafe Default
Period of time for Robot to hold BIOS from POST.		
<b>Reset system once</b>	Disabled	Optimal Default, Failsafe Default
	Enabled	
Enabled - Robot resets system for one time on each boot. This will send a soft or hard reset to onboard devices, thus puts devices to more stable state.		
<b>Soft or hard reset</b>	Soft reset	Optimal Default, Failsafe Default
	Hard reset	
Select reset type robot should send on each boot.		



### 3.4.9 Power Management

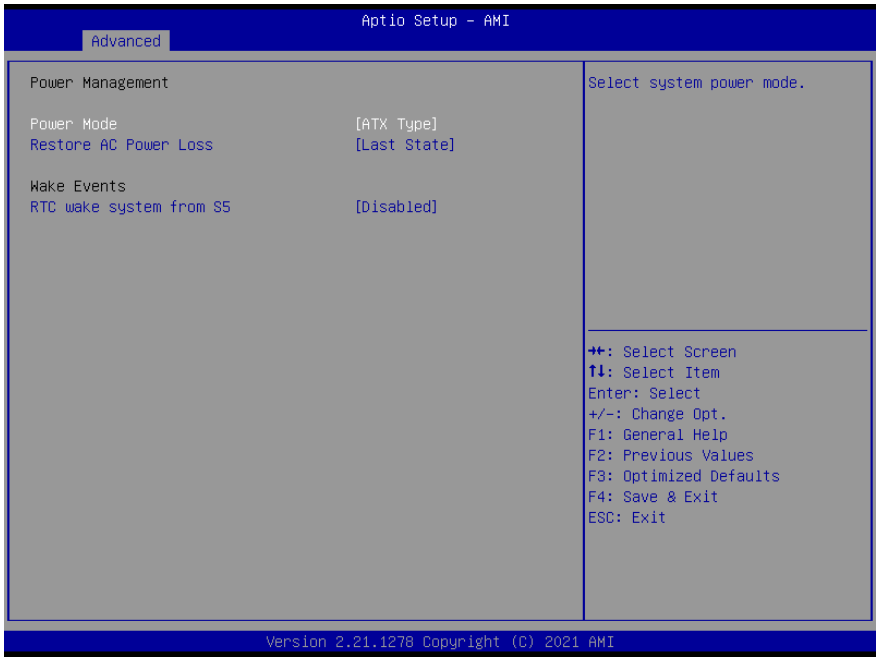

Options Summary		
Power Mode	ATX Type	Optimal Default, Failsafe Default
	AT Type	
Select power supply mode.		
Restore AC Power Loss	Last State	Optimal Default, Failsafe Default
	Always On	
	Always Off	
Select power state when power is re-applied after a power failure.		
RTC wake system from S5	Disabled	Optimal Default, Failsafe Default
	Fixed Time	
	Dynamic Time	
	Bypass	
Fixed Time: System will wake on the hr :: min :: sec specified		
Dynamic Time : System will wake on the current time + Increase minutes(s).		
Bypass: BIOS will not control RTC wake function during system shutdown		

### 3.4.10 Digital IO Port Configuration

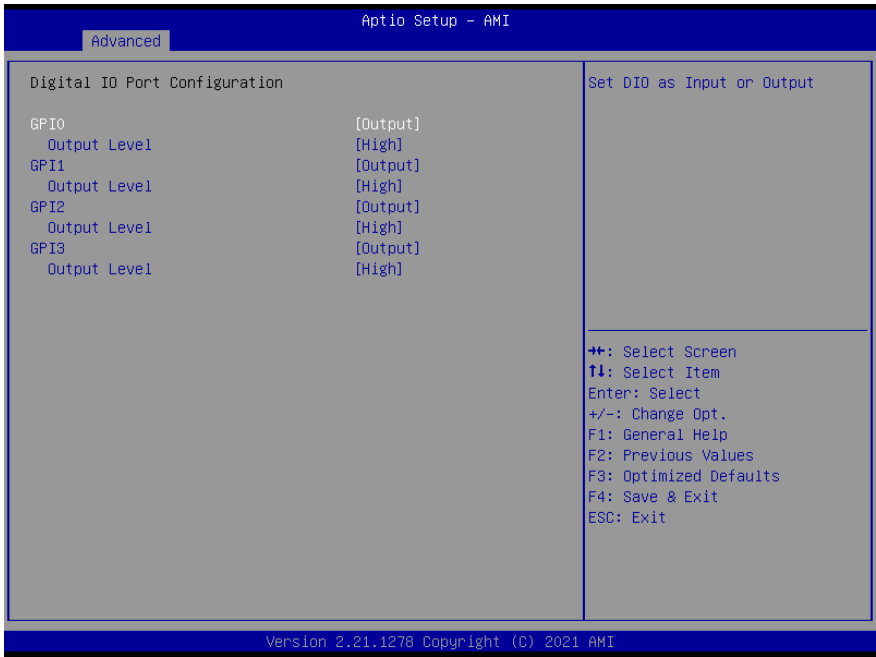

Options Summary		
DIO Port0~3	Output	Optimal Default, Failsafe Default
	Input	
Set DIO as Input or Output		
Output Level	High	Optimal Default, Failsafe Default
	Low	
Set output level when DIO pin is output		

### 3.5 Setup Submenu: Chipset



### 3.5.1 System Agent (SA) Configuration

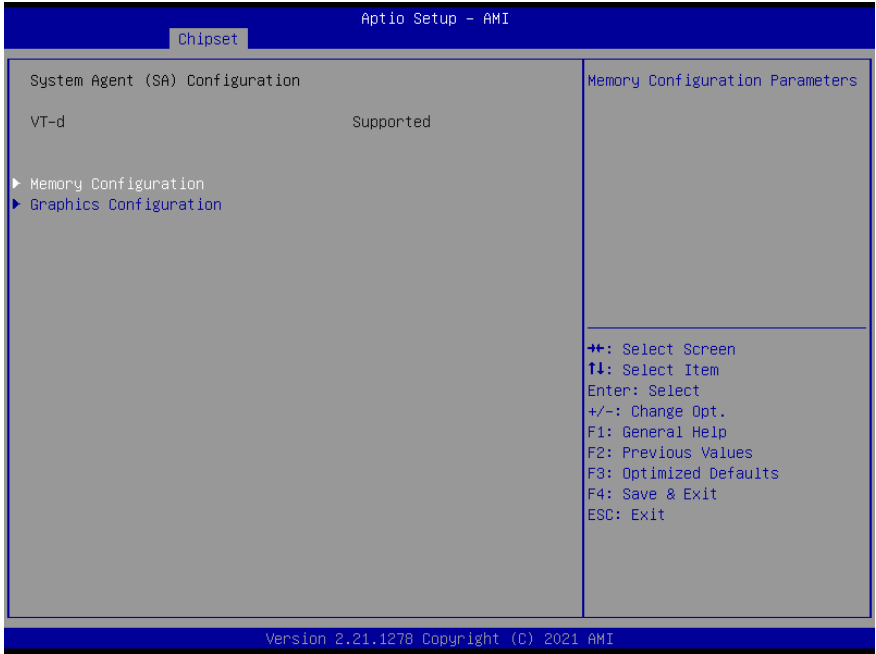

### 3.5.1.1 Memory Configuration



### 3.5.1.2 Graphics Configuration

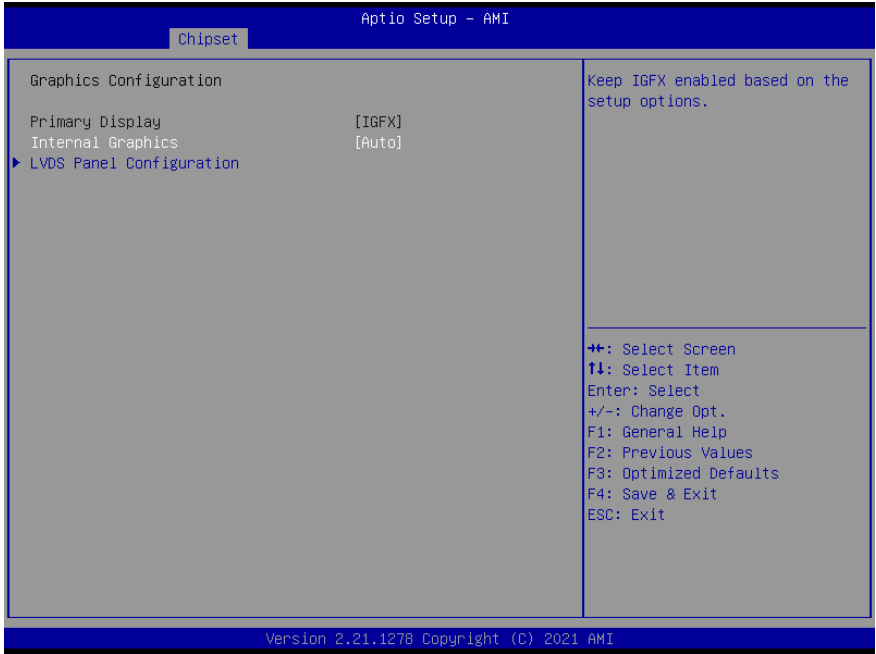

Options Summary		
Internal Graphics	Auto	Optimal Default, Failsafe Default
	Disabled	
	Enabled	
Keep IGFX enabled based on the setup options.		

### 3.5.1.2.1 LVDS Panel Configuration

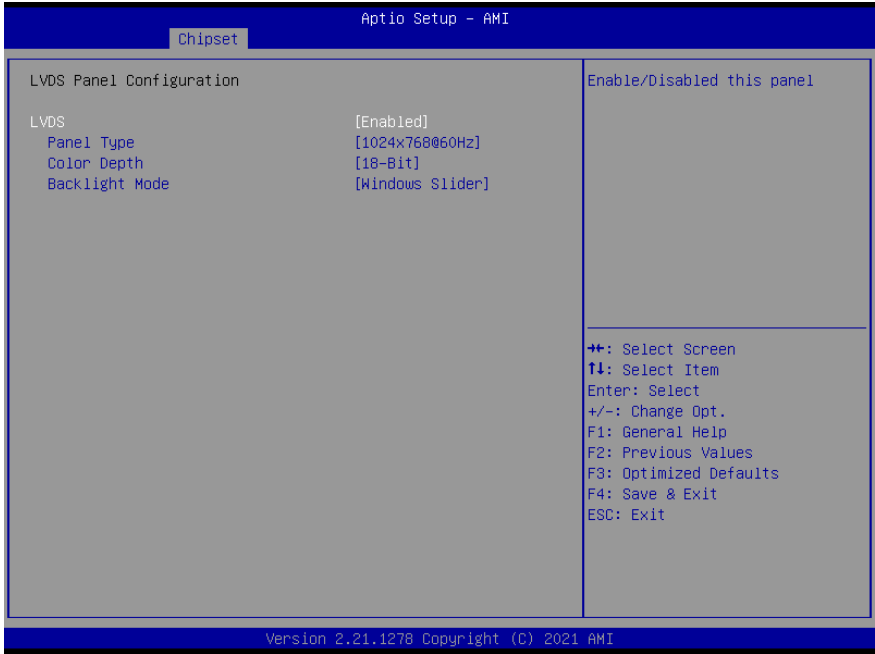

Options Summary		
LVDS	Disabled	
	Enabled	Optimal Default, Failsafe Default
Enable/Disable this panel.		
LVDS Panel Type	640X480@60HZ	
	800X480@60HZ	
	800X600@60HZ	
	1024X600@60HZ	
	1024X768@60HZ	Optimal Default, Failsafe Default
	1280X768@60HZ	
	1280X800@60HZ	
	1280X1024@60HZ	
	1366X768@60HZ	
1440X900@60HZ		
Select panel type		

Options Summary		
Color Depth	18-bit	Optimal Default, Failsafe Default
	24-bit	
Select Color Depth		
Backlight Mode	Windows Slider	Optimal Default, Failsafe Default
	BIOS & Application	
Select backlight control signal type		
Backlight Type	Normal	Optimal Default, Failsafe Default
	Inverted	
Select backlight control signal type		
Backlight Level	0%	
	10%	
	20%	
	30%	
	40%	
	50%	
	60%	
	70%	
	80%	Optimal Default, Failsafe Default
	90%	
100%		
Select backlight control level		
Backlight PWM Freq	100Hz	
	200Hz	
	220Hz	Optimal Default, Failsafe Default
	500Hz	
	1KHz	
	2.2KHz	
	6.5KHz	
Select PWM frequency of backlight control signal		



### 3.5.2 PCH-IO Configuration



Options Summary		
HD Audio	Enabled	Optimal Default, Failsafe Default
	Disabled	
Control Detection of the HD-Audio device. Disabled = HDA will be unconditionally disabled Enabled = HDA will be unconditionally enabled.		
Full-MiniCard Slot Function (CN11)	SATA	Optimal Default, Failsafe Default
	PCIe	
Select function enabled for Full-MiniCard (CN11) Slot		

## 3.6 Setup Submenu: Security

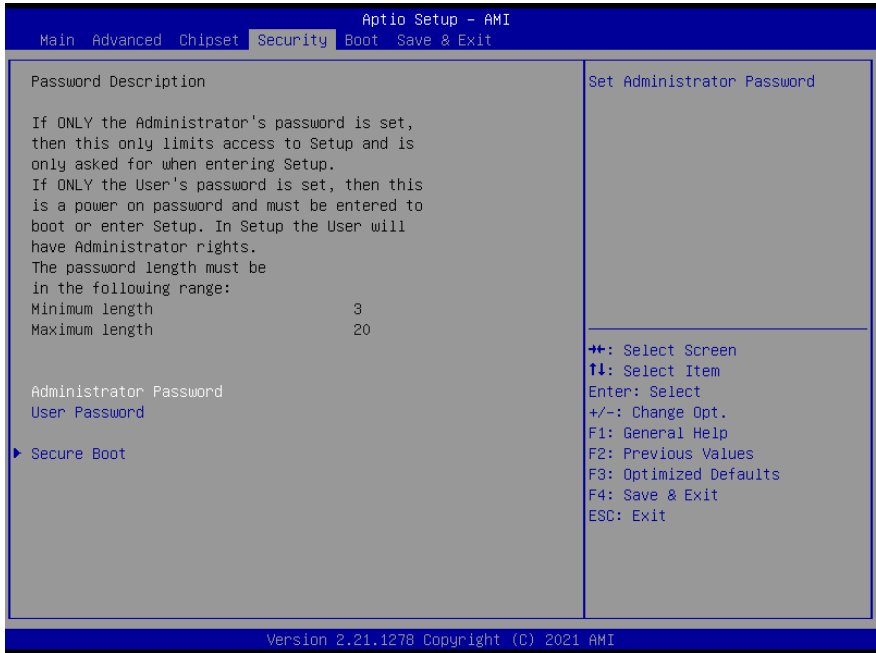

### Change User/Supervisor Password

You can install a Supervisor password, and if you install a supervisor password, you can then install a user password. A user password does not provide access to many of the features in the Setup utility.

If you highlight these items and press Enter, a dialog box appears which lets you enter a password. You can enter no more than six letters or numbers. Press Enter after you have typed in the password. A second dialog box asks you to retype the password for confirmation. Press Enter after you have retyped it correctly. The password is required at boot time, or when the user enters the Setup utility.

### Removing the Password

Highlight this item and type in the current password. At the next dialog box press Enter to disable password protection.

### 3.6.1 Secure Boot

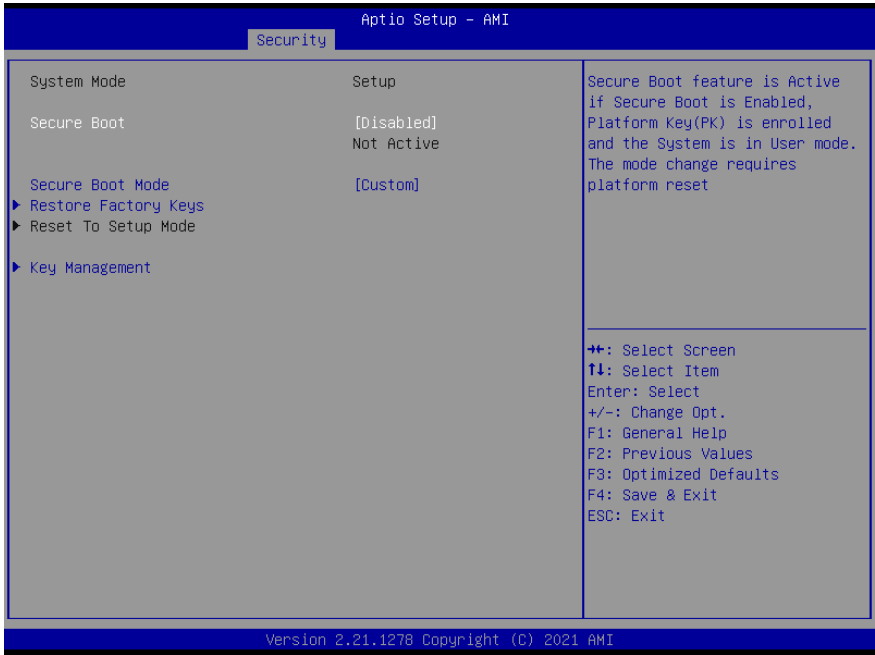

Options Summary		
Secure Boot	Disabled	Optimal Default, Failsafe Default
	Enabled	
Secure Boot feature is Active if Secure Boot is Enabled, Platform Key (PK) is enrolled and the System is in User mode. The mode change requires platform reset		
Secure Boot Mode	Standard	
	Custom	Optimal Default, Failsafe Default
Secure Boot mode options: Standard or Custom. In Custom mode, Secure Boot Policy variables can be configured by a physically present user without full authentication		
<b>Restore Factory Keys</b>		
Force System to User Mode. Install factory default Secure Boot key databases		
<b>Reset to Setup Mode</b>		
Delete all Secure Boot key databases from NVRAM		

### 3.6.1.1 Key Management

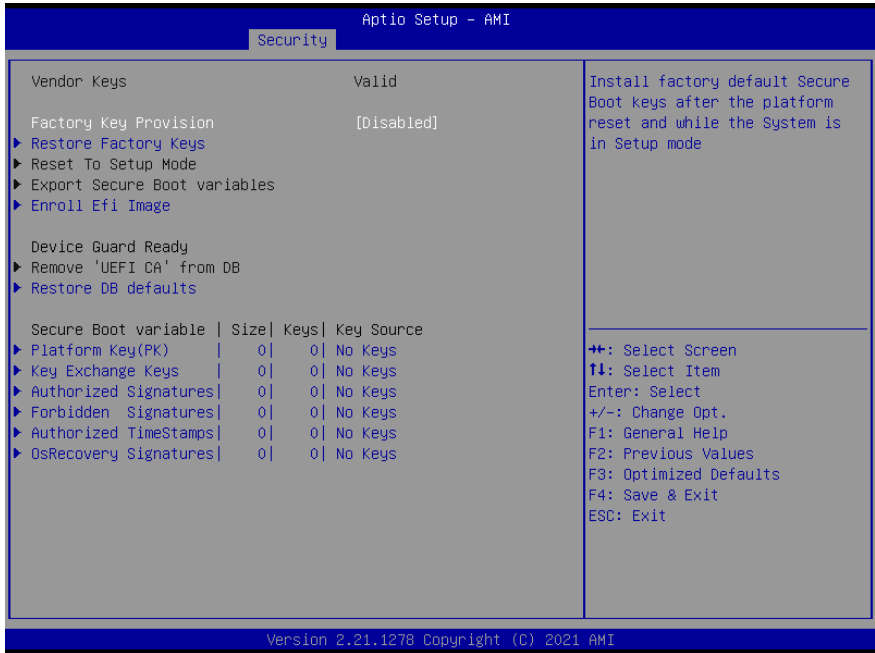

Options Summary		
<b>Factory Key Provision</b>	Disabled	Optimal Default, Failsafe Default
	Enabled	
Install factory default Secure Boot keys after the platform reset and while the System is in Setup mode		
<b>Restore Factory Keys</b>		
Force System to User Mode. Install factory default Secure Boot key databases		
<b>Reset To Setup Mode</b>		
Delete all Secure Boot key databases from NVRAM		
<b>Export Secure Boot variables</b>		
Copy NVRAM content of Secure Boot variables to files in a root folder on a file system device		
<b>Enroll Efi Image</b>		
Allow the image to run in Secure Boot mode. Enroll SHA256 Hash certificate of a PE image into Authorized Signature Database (db)		

Options Summary
<b>Remove 'UEFI CA' from DB</b>
Device Guard ready system must not list 'Microsoft UEFI CA' Certificate in Authorized Signature database (db)
<b>Restore DB defaults</b>
Restore DB variable to factory defaults

### Secure Boot Variables

Enroll Factory Defaults or load certificates from a file:

1. Public Key Certificate in:
  - a) EFI\_SIGNATURE\_LIST
  - b) EFI\_CERT\_X509 (DER encoded)
  - c) EFI\_CERT\_RSA2048 (bin)
  - d) EFI\_CERT\_SHAXXX
2. Authenticated UEFI Variable
3. EFI PE/COFF Image (SHA256)

### Key Source:

Default, External, Mixed

### 3.7 Setup Submenu: Boot

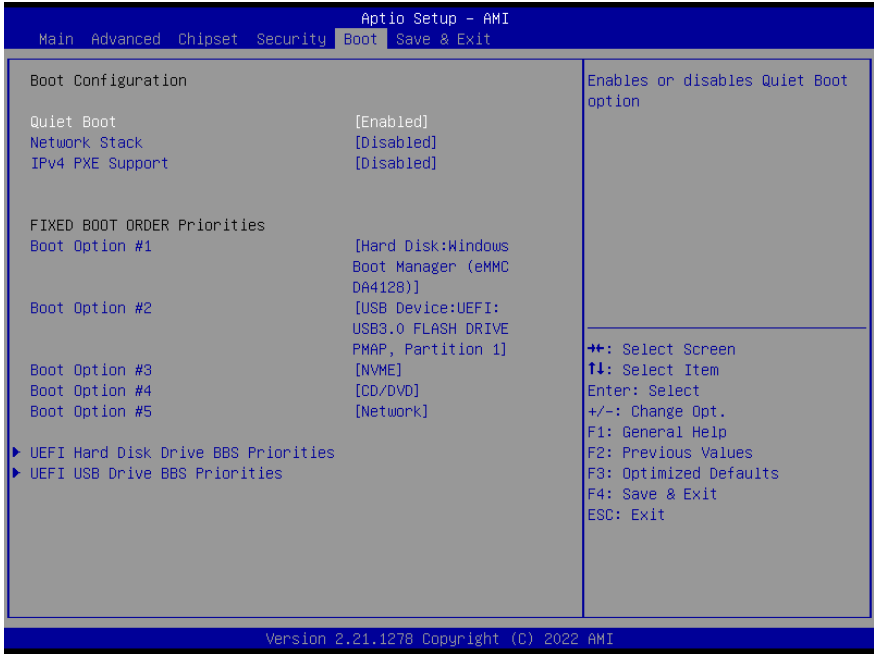

Options Summary		
Quiet Boot	Disabled	
	Enabled	Optimal Default, Failsafe Default
Enable or Disable Quiet Boot option.		
Network Stack	Disabled	Optimal Default, Failsafe Default
	Enabled	
Enable/Disable UEFI Network Stack.		
IPv4 PXE Support	Disabled	Optimal Default, Failsafe Default
	Enabled	
Enable/Disable IPv4 PXE boot support. If disabled, IPv4 PXE boot support will not be available.		
<b>FIXED BOOT ORDER Priorities</b>		
Sets the system boot order		

### 3.8 Setup Submenu: Save & Exit

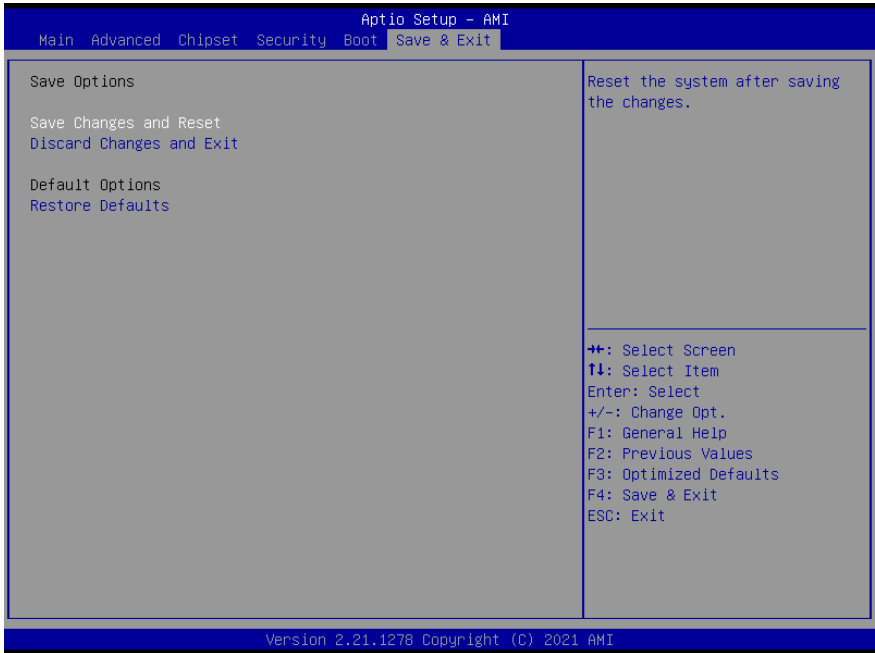

Options Summary	
Save Changes and Reset	Reset the system after saving the changes.
Discard Changes and Exit	Exit system setup without saving any changes.
Restore Defaults	Restore/Load Default values for all the setup options.

# Chapter 4

---

Drivers Installation



## 4.1 Drivers Download and Installation

---

Drivers for the PICO-EHL4-A11 can be downloaded from the product page on the AAEON website by following this link:

<https://www.aaeon.com/en/p/pico-itx-turnkit-pico-ehl4>

Download the driver(s) you need and follow the steps below to install them.

### Step 1 – Install Chipset Driver

1. Open the **Intel Chipset** folder.
2. Run the **SetupChipset.exe** file.
3. Follow the instructions
4. Drivers will be installed automatically

### Step 2 – Install Graphics Driver

1. Open the **Intel Graphics** folder.
2. Run the **igxpin.exe** file.
3. Follow the instructions
4. Driver will be installed automatically

### Step 3 – Install Serial IO Driver

1. Open the **Serial IO** folder.
2. Serial IO Driver .inf files will need to be installed manually.

#### Step 4 – Install ME Driver

1. Open the **ME** folder.
2. Run the **SetupME.exe** file
3. Follow the instructions
4. Driver will be installed automatically

#### Step 5 – Install LAN Driver

1. Open the **LAN** folder.
2. Run the **Install\_Win10\_10050\_08132021.exe** file
3. Follow the instructions
4. Driver will be installed automatically

#### Step 6 – Peripheral Drivers

1. Open the **Peripheral Drivers** folder.
2. Peripheral Drivers .inf files will need to be installed manually.

For Linux Peripheral Drivers, follow the instructions included in the file to download and install the relevant drivers.

# Appendix A

---

Mating Connectors

## A.1 List of Mating Connectors and Cables

The following table lists mating connectors and available cables.

Connector Label	Function	Mating Connector		Available Cable	AAEON Cable P/N
		Vendor	Model no		
CN1	RTC Battery	Molex	51021-0200	Battery Cable	175011301C
CN2	LVDS Back Light Inverter	SHR	WL1010H-6P Terminal: KB901-10T	LVDS Inverter Cable	170X000152
CN3	LVDS	I-PEX	20453-040T-11	LVDS Cable	170X000532
	EDP			EDP Cable	170X000531
CN6	SATA	Molex	887505318	SATA Cable	1709070500
CN7	SATA Power	JST	PHR-2	SATA Power Cable	1702150155
CN8	4-bit DIO Header	PINREX	633-92-03GB00	N/A	N/A
CN10	USB2.0 Header	ACES	50247-010H0H0-001	USB2.0 Cable	170010010D
CN13	CAN Bus Header	JCTC	HSG: 11002H00-7P TER: 11002TOP-2E	CAN Bus Cable	170X000316
CN15	COM Header	JST	SHDR-20V-S-B	COM Port Cable	170X000231
CN18	eSPI/SMBUS/I2C	JST	SHR-12V-S-B	LPC/eSPI Cable	1703120130
CN19	4-pin Smart FAN	Molex	51021-0400	N/A	N/A
CN20	Power Input	Molex	19211-0003	Power Cable	170204010R

Connector Label	Function	Mating Connector		Available Cable	AAEON Cable P/N
		Vendor	Model no		
CN21	Front Panel	ACES	50247-010H0H0-001	Front Panel Cable	1709100108
CN22	DC Jack Power Input	HUANG JI	5525C257-3T00-R1-7.5	Power Cable	1702041004

**Note 1:** eDP Test Panel: B173ZAN01.0-AUO & LVDS Test Panel: G121XN01V0-AUO.

**Note 2:** 170X000531 (TF)EDP Cable.40P.with AUO B173ZAN01.0.300mm.UC

Function.UC-W037.For PICO-EHL4 A1.1.

170X000532 (TF)LVDS Cable.40P.with AUO G121XN01V0.350mm.UC

Function.UC-W038.For PICO-EHL4 A1.1.

# Appendix B

---

I/O Information

## B.1 Direct Memory Access (DMA) Map

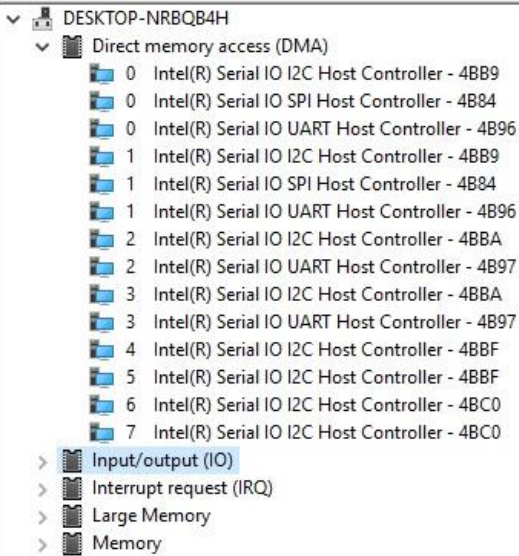
- 
- DESKTOP-NRBQB4H
    - Direct memory access (DMA)
      - 0 Intel(R) Serial IO I2C Host Controller - 4BB9
      - 0 Intel(R) Serial IO SPI Host Controller - 4B84
      - 0 Intel(R) Serial IO UART Host Controller - 4B96
      - 1 Intel(R) Serial IO I2C Host Controller - 4BB9
      - 1 Intel(R) Serial IO SPI Host Controller - 4B84
      - 1 Intel(R) Serial IO UART Host Controller - 4B96
      - 2 Intel(R) Serial IO I2C Host Controller - 4BBA
      - 2 Intel(R) Serial IO UART Host Controller - 4B97
      - 3 Intel(R) Serial IO I2C Host Controller - 4BBA
      - 3 Intel(R) Serial IO UART Host Controller - 4B97
      - 4 Intel(R) Serial IO I2C Host Controller - 4BBF
      - 5 Intel(R) Serial IO I2C Host Controller - 4BBF
      - 6 Intel(R) Serial IO I2C Host Controller - 4BC0
      - 7 Intel(R) Serial IO I2C Host Controller - 4BC0
    - Input/output (IO)
    - Interrupt request (IRQ)
    - Large Memory
    - Memory

## B.2 I/O Address Map











































Address Range	Device Name
[0000000000000000 - 000000000000CF7]	PCI Express Root Complex
[0000000000000020 - 0000000000000021]	Programmable interrupt controller
[0000000000000024 - 0000000000000025]	Programmable interrupt controller
[0000000000000028 - 0000000000000029]	Programmable interrupt controller
[000000000000002C - 000000000000002D]	Programmable interrupt controller
[000000000000002E - 000000000000002F]	Motherboard resources
[0000000000000030 - 0000000000000031]	Programmable interrupt controller
[0000000000000034 - 0000000000000035]	Programmable interrupt controller
[0000000000000038 - 0000000000000039]	Programmable interrupt controller
[000000000000003C - 000000000000003D]	Programmable interrupt controller
[0000000000000040 - 0000000000000043]	System timer
[000000000000004E - 000000000000004F]	Motherboard resources
[0000000000000050 - 0000000000000053]	System timer
[0000000000000061 - 0000000000000061]	Motherboard resources
[0000000000000063 - 0000000000000063]	Motherboard resources
[0000000000000065 - 0000000000000065]	Motherboard resources
[0000000000000067 - 0000000000000067]	Motherboard resources
[0000000000000070 - 0000000000000070]	Motherboard resources
[0000000000000080 - 0000000000000080]	Motherboard resources
[0000000000000092 - 0000000000000092]	Motherboard resources
[00000000000000A0 - 00000000000000A1]	Programmable interrupt controller
[00000000000000A4 - 00000000000000A5]	Programmable interrupt controller
[00000000000000A8 - 00000000000000A9]	Programmable interrupt controller
[00000000000000AC - 00000000000000AD]	Programmable interrupt controller
[00000000000000B0 - 00000000000000B1]	Programmable interrupt controller
[00000000000000B2 - 00000000000000B3]	Motherboard resources
[00000000000000B4 - 00000000000000B5]	Programmable interrupt controller
[00000000000000B8 - 00000000000000B9]	Programmable interrupt controller
[00000000000000BC - 00000000000000BD]	Programmable interrupt controller
[00000000000002F8 - 00000000000002FF]	Communications Port (COM2)
[00000000000003F8 - 00000000000003FF]	Communications Port (COM1)
[00000000000004D0 - 00000000000004D1]	Programmable interrupt controller
[0000000000000680 - 000000000000069F]	Motherboard resources
[0000000000000A00 - 0000000000000A0F]	Motherboard resources
[0000000000000A10 - 0000000000000A1F]	Motherboard resources
[0000000000000A20 - 0000000000000A2F]	Motherboard resources
[0000000000000D00 - 000000000000FFFF]	PCI Express Root Complex
[000000000000164E - 000000000000164F]	Motherboard resources
[0000000000001800 - 00000000000018FE]	Motherboard resources
[0000000000001854 - 0000000000001857]	Motherboard resources
[0000000000002000 - 00000000000020FE]	Motherboard resources

[0000000000003000 - 00000000000030FF]	Realtek PCIe GbE Family Controller
[0000000000003000 - 0000000000003FFF]	Intel(R) PCI Express Root Port #3 - 4B3B
[0000000000004000 - 00000000000040FF]	Realtek PCIe GbE Family Controller #2
[0000000000004000 - 0000000000004FFF]	Intel(R) PCI Express Root Port #0 - 4B38
[0000000000005000 - 000000000000503F]	Intel(R) UHD Graphics
[0000000000005060 - 000000000000507F]	Standard SATA AHCI Controller
[0000000000005080 - 0000000000005083]	Standard SATA AHCI Controller
[0000000000005090 - 0000000000005097]	Standard SATA AHCI Controller
[000000000000EFA0 - 000000000000EFBF]	Intel(R) SMBus Controller - 4B23













































## B.3 IRQ Mapping Chart

Icon	ISA Address	Device Name
	(ISA) 0x00000000 (00)	System timer
	(ISA) 0x00000003 (03)	Communications Port (COM2)
	(ISA) 0x00000004 (04)	Communications Port (COM1)
	(ISA) 0x0000000E (14)	Intel(R) Serial IO GPIO Host Controller - INTCT1020
	(ISA) 0x00000023 (35)	Unknown device
	(ISA) 0x00000024 (36)	Unknown device
	(ISA) 0x00000036 (54)	Microsoft ACPI-Compliant System
	(ISA) 0x00000037 (55)	Microsoft ACPI-Compliant System
	(ISA) 0x00000038 (56)	Microsoft ACPI-Compliant System
	(ISA) 0x00000039 (57)	Microsoft ACPI-Compliant System
	(ISA) 0x0000003A (58)	Microsoft ACPI-Compliant System
	(ISA) 0x0000003B (59)	Microsoft ACPI-Compliant System
	(ISA) 0x0000003C (60)	Microsoft ACPI-Compliant System
	(ISA) 0x0000003D (61)	Microsoft ACPI-Compliant System
	(ISA) 0x0000003E (62)	Microsoft ACPI-Compliant System
	(ISA) 0x0000003F (63)	Microsoft ACPI-Compliant System
	(ISA) 0x00000040 (64)	Microsoft ACPI-Compliant System
	(ISA) 0x00000041 (65)	Microsoft ACPI-Compliant System
	(ISA) 0x00000042 (66)	Microsoft ACPI-Compliant System
	(ISA) 0x00000043 (67)	Microsoft ACPI-Compliant System
	(ISA) 0x00000044 (68)	Microsoft ACPI-Compliant System
	(ISA) 0x00000045 (69)	Microsoft ACPI-Compliant System
	(ISA) 0x00000046 (70)	Microsoft ACPI-Compliant System
	(ISA) 0x00000047 (71)	Microsoft ACPI-Compliant System
	(ISA) 0x00000048 (72)	Microsoft ACPI-Compliant System
	(ISA) 0x00000049 (73)	Microsoft ACPI-Compliant System
	(ISA) 0x0000004A (74)	Microsoft ACPI-Compliant System
	(ISA) 0x0000004B (75)	Microsoft ACPI-Compliant System
	(ISA) 0x0000004C (76)	Microsoft ACPI-Compliant System
	(ISA) 0x0000004D (77)	Microsoft ACPI-Compliant System
	(ISA) 0x0000004E (78)	Microsoft ACPI-Compliant System
	(ISA) 0x0000004F (79)	Microsoft ACPI-Compliant System
	(ISA) 0x00000050 (80)	Microsoft ACPI-Compliant System
	(ISA) 0x00000051 (81)	Microsoft ACPI-Compliant System
	(ISA) 0x00000052 (82)	Microsoft ACPI-Compliant System
	(ISA) 0x00000053 (83)	Microsoft ACPI-Compliant System
	(ISA) 0x00000054 (84)	Microsoft ACPI-Compliant System
	(ISA) 0x00000055 (85)	Microsoft ACPI-Compliant System
	(ISA) 0x00000056 (86)	Microsoft ACPI-Compliant System
	(ISA) 0x00000057 (87)	Microsoft ACPI-Compliant System
	(ISA) 0x00000058 (88)	Microsoft ACPI-Compliant System











































 (ISA) 0x00000058 (88)	Microsoft ACPI-Compliant System
 (ISA) 0x00000059 (89)	Microsoft ACPI-Compliant System
 (ISA) 0x0000005A (90)	Microsoft ACPI-Compliant System
 (ISA) 0x0000005B (91)	Microsoft ACPI-Compliant System
 (ISA) 0x0000005C (92)	Microsoft ACPI-Compliant System
 (ISA) 0x0000005D (93)	Microsoft ACPI-Compliant System
 (ISA) 0x0000005E (94)	Microsoft ACPI-Compliant System
 (ISA) 0x0000005F (95)	Microsoft ACPI-Compliant System
 (ISA) 0x00000060 (96)	Microsoft ACPI-Compliant System
 (ISA) 0x00000061 (97)	Microsoft ACPI-Compliant System
 (ISA) 0x00000062 (98)	Microsoft ACPI-Compliant System
 (ISA) 0x00000063 (99)	Microsoft ACPI-Compliant System
 (ISA) 0x00000064 (100)	Microsoft ACPI-Compliant System
 (ISA) 0x00000065 (101)	Microsoft ACPI-Compliant System
 (ISA) 0x00000066 (102)	Microsoft ACPI-Compliant System
 (ISA) 0x00000067 (103)	Microsoft ACPI-Compliant System
 (ISA) 0x00000068 (104)	Microsoft ACPI-Compliant System
 (ISA) 0x00000069 (105)	Microsoft ACPI-Compliant System
 (ISA) 0x0000006A (106)	Microsoft ACPI-Compliant System
 (ISA) 0x0000006B (107)	Microsoft ACPI-Compliant System
 (ISA) 0x0000006C (108)	Microsoft ACPI-Compliant System
 (ISA) 0x0000006D (109)	Microsoft ACPI-Compliant System
 (ISA) 0x0000006E (110)	Microsoft ACPI-Compliant System
 (ISA) 0x0000006F (111)	Microsoft ACPI-Compliant System
 (ISA) 0x00000070 (112)	Microsoft ACPI-Compliant System
 (ISA) 0x00000071 (113)	Microsoft ACPI-Compliant System
 (ISA) 0x00000072 (114)	Microsoft ACPI-Compliant System
 (ISA) 0x00000073 (115)	Microsoft ACPI-Compliant System
 (ISA) 0x00000074 (116)	Microsoft ACPI-Compliant System
 (ISA) 0x00000075 (117)	Microsoft ACPI-Compliant System
 (ISA) 0x00000076 (118)	Microsoft ACPI-Compliant System
 (ISA) 0x00000077 (119)	Microsoft ACPI-Compliant System
 (ISA) 0x00000078 (120)	Microsoft ACPI-Compliant System
 (ISA) 0x00000079 (121)	Microsoft ACPI-Compliant System
 (ISA) 0x0000007A (122)	Microsoft ACPI-Compliant System
 (ISA) 0x0000007B (123)	Microsoft ACPI-Compliant System
 (ISA) 0x0000007C (124)	Microsoft ACPI-Compliant System
 (ISA) 0x0000007D (125)	Microsoft ACPI-Compliant System
 (ISA) 0x0000007E (126)	Microsoft ACPI-Compliant System
 (ISA) 0x0000007F (127)	Microsoft ACPI-Compliant System
 (ISA) 0x00000080 (128)	Microsoft ACPI-Compliant System
 (ISA) 0x00000081 (129)	Microsoft ACPI-Compliant System

---

 (ISA) 0x00000080 (128)	Microsoft ACPI-Compliant System
 (ISA) 0x00000081 (129)	Microsoft ACPI-Compliant System
 (ISA) 0x00000082 (130)	Microsoft ACPI-Compliant System
 (ISA) 0x00000083 (131)	Microsoft ACPI-Compliant System
 (ISA) 0x00000084 (132)	Microsoft ACPI-Compliant System
 (ISA) 0x00000085 (133)	Microsoft ACPI-Compliant System
 (ISA) 0x00000086 (134)	Microsoft ACPI-Compliant System
 (ISA) 0x00000087 (135)	Microsoft ACPI-Compliant System
 (ISA) 0x00000088 (136)	Microsoft ACPI-Compliant System
 (ISA) 0x00000089 (137)	Microsoft ACPI-Compliant System
 (ISA) 0x0000008A (138)	Microsoft ACPI-Compliant System
 (ISA) 0x0000008B (139)	Microsoft ACPI-Compliant System
 (ISA) 0x0000008C (140)	Microsoft ACPI-Compliant System
 (ISA) 0x0000008D (141)	Microsoft ACPI-Compliant System
 (ISA) 0x0000008E (142)	Microsoft ACPI-Compliant System
 (ISA) 0x0000008F (143)	Microsoft ACPI-Compliant System
 (ISA) 0x00000090 (144)	Microsoft ACPI-Compliant System
 (ISA) 0x00000091 (145)	Microsoft ACPI-Compliant System
 (ISA) 0x00000092 (146)	Microsoft ACPI-Compliant System
 (ISA) 0x00000093 (147)	Microsoft ACPI-Compliant System
 (ISA) 0x00000094 (148)	Microsoft ACPI-Compliant System
 (ISA) 0x00000095 (149)	Microsoft ACPI-Compliant System
 (ISA) 0x00000096 (150)	Microsoft ACPI-Compliant System
 (ISA) 0x00000097 (151)	Microsoft ACPI-Compliant System
 (ISA) 0x00000098 (152)	Microsoft ACPI-Compliant System
 (ISA) 0x00000099 (153)	Microsoft ACPI-Compliant System
 (ISA) 0x0000009A (154)	Microsoft ACPI-Compliant System
 (ISA) 0x0000009B (155)	Microsoft ACPI-Compliant System
 (ISA) 0x0000009C (156)	Microsoft ACPI-Compliant System
 (ISA) 0x0000009D (157)	Microsoft ACPI-Compliant System
 (ISA) 0x0000009E (158)	Microsoft ACPI-Compliant System
 (ISA) 0x0000009F (159)	Microsoft ACPI-Compliant System
 (ISA) 0x000000A0 (160)	Microsoft ACPI-Compliant System
 (ISA) 0x000000A1 (161)	Microsoft ACPI-Compliant System
 (ISA) 0x000000A2 (162)	Microsoft ACPI-Compliant System
 (ISA) 0x000000A3 (163)	Microsoft ACPI-Compliant System
 (ISA) 0x000000A4 (164)	Microsoft ACPI-Compliant System
 (ISA) 0x000000A5 (165)	Microsoft ACPI-Compliant System
 (ISA) 0x000000A6 (166)	Microsoft ACPI-Compliant System
 (ISA) 0x000000A7 (167)	Microsoft ACPI-Compliant System
 (ISA) 0x000000A8 (168)	Microsoft ACPI-Compliant System
 (ISA) 0x000000A9 (169)	Microsoft ACPI-Compliant System

---











































---

 (ISA) 0x000000A8 (168)	Microsoft ACPI-Compliant System
 (ISA) 0x000000A9 (169)	Microsoft ACPI-Compliant System
 (ISA) 0x000000AA (170)	Microsoft ACPI-Compliant System
 (ISA) 0x000000AB (171)	Microsoft ACPI-Compliant System
 (ISA) 0x000000AC (172)	Microsoft ACPI-Compliant System
 (ISA) 0x000000AD (173)	Microsoft ACPI-Compliant System
 (ISA) 0x000000AE (174)	Microsoft ACPI-Compliant System
 (ISA) 0x000000AF (175)	Microsoft ACPI-Compliant System
 (ISA) 0x000000B0 (176)	Microsoft ACPI-Compliant System
 (ISA) 0x000000B1 (177)	Microsoft ACPI-Compliant System
 (ISA) 0x000000B2 (178)	Microsoft ACPI-Compliant System
 (ISA) 0x000000B3 (179)	Microsoft ACPI-Compliant System
 (ISA) 0x000000B4 (180)	Microsoft ACPI-Compliant System
 (ISA) 0x000000B5 (181)	Microsoft ACPI-Compliant System
 (ISA) 0x000000B6 (182)	Microsoft ACPI-Compliant System
 (ISA) 0x000000B7 (183)	Microsoft ACPI-Compliant System
 (ISA) 0x000000B8 (184)	Microsoft ACPI-Compliant System
 (ISA) 0x000000B9 (185)	Microsoft ACPI-Compliant System
 (ISA) 0x000000BA (186)	Microsoft ACPI-Compliant System
 (ISA) 0x000000BB (187)	Microsoft ACPI-Compliant System
 (ISA) 0x000000BC (188)	Microsoft ACPI-Compliant System
 (ISA) 0x000000BD (189)	Microsoft ACPI-Compliant System
 (ISA) 0x000000BE (190)	Microsoft ACPI-Compliant System
 (ISA) 0x000000BF (191)	Microsoft ACPI-Compliant System
 (ISA) 0x000000C0 (192)	Microsoft ACPI-Compliant System
 (ISA) 0x000000C1 (193)	Microsoft ACPI-Compliant System
 (ISA) 0x000000C2 (194)	Microsoft ACPI-Compliant System
 (ISA) 0x000000C3 (195)	Microsoft ACPI-Compliant System
 (ISA) 0x000000C4 (196)	Microsoft ACPI-Compliant System
 (ISA) 0x000000C5 (197)	Microsoft ACPI-Compliant System
 (ISA) 0x000000C6 (198)	Microsoft ACPI-Compliant System
 (ISA) 0x000000C7 (199)	Microsoft ACPI-Compliant System
 (ISA) 0x000000C8 (200)	Microsoft ACPI-Compliant System
 (ISA) 0x000000C9 (201)	Microsoft ACPI-Compliant System
 (ISA) 0x000000CA (202)	Microsoft ACPI-Compliant System
 (ISA) 0x000000CB (203)	Microsoft ACPI-Compliant System
 (ISA) 0x000000CC (204)	Microsoft ACPI-Compliant System
 (ISA) 0x00000100 (256)	Microsoft ACPI-Compliant System
 (ISA) 0x00000101 (257)	Microsoft ACPI-Compliant System
 (ISA) 0x00000102 (258)	Microsoft ACPI-Compliant System
 (ISA) 0x00000103 (259)	Microsoft ACPI-Compliant System
 (ISA) 0x00000104 (260)	Microsoft ACPI-Compliant System

---













































---











































 (ISA) 0x00000103 (259)	Microsoft ACPI-Compliant System
 (ISA) 0x00000104 (260)	Microsoft ACPI-Compliant System
 (ISA) 0x00000105 (261)	Microsoft ACPI-Compliant System
 (ISA) 0x00000106 (262)	Microsoft ACPI-Compliant System
 (ISA) 0x00000107 (263)	Microsoft ACPI-Compliant System
 (ISA) 0x00000108 (264)	Microsoft ACPI-Compliant System
 (ISA) 0x00000109 (265)	Microsoft ACPI-Compliant System
 (ISA) 0x0000010A (266)	Microsoft ACPI-Compliant System
 (ISA) 0x0000010B (267)	Microsoft ACPI-Compliant System
 (ISA) 0x0000010C (268)	Microsoft ACPI-Compliant System
 (ISA) 0x0000010D (269)	Microsoft ACPI-Compliant System
 (ISA) 0x0000010E (270)	Microsoft ACPI-Compliant System
 (ISA) 0x0000010F (271)	Microsoft ACPI-Compliant System
 (ISA) 0x00000110 (272)	Microsoft ACPI-Compliant System
 (ISA) 0x00000111 (273)	Microsoft ACPI-Compliant System
 (ISA) 0x00000112 (274)	Microsoft ACPI-Compliant System
 (ISA) 0x00000113 (275)	Microsoft ACPI-Compliant System
 (ISA) 0x00000114 (276)	Microsoft ACPI-Compliant System
 (ISA) 0x00000115 (277)	Microsoft ACPI-Compliant System
 (ISA) 0x00000116 (278)	Microsoft ACPI-Compliant System
 (ISA) 0x00000117 (279)	Microsoft ACPI-Compliant System
 (ISA) 0x00000118 (280)	Microsoft ACPI-Compliant System
 (ISA) 0x00000119 (281)	Microsoft ACPI-Compliant System
 (ISA) 0x0000011A (282)	Microsoft ACPI-Compliant System
 (ISA) 0x0000011B (283)	Microsoft ACPI-Compliant System
 (ISA) 0x0000011C (284)	Microsoft ACPI-Compliant System
 (ISA) 0x0000011D (285)	Microsoft ACPI-Compliant System
 (ISA) 0x0000011E (286)	Microsoft ACPI-Compliant System
 (ISA) 0x0000011F (287)	Microsoft ACPI-Compliant System
 (ISA) 0x00000120 (288)	Microsoft ACPI-Compliant System
 (ISA) 0x00000121 (289)	Microsoft ACPI-Compliant System
 (ISA) 0x00000122 (290)	Microsoft ACPI-Compliant System
 (ISA) 0x00000123 (291)	Microsoft ACPI-Compliant System
 (ISA) 0x00000124 (292)	Microsoft ACPI-Compliant System
 (ISA) 0x00000125 (293)	Microsoft ACPI-Compliant System
 (ISA) 0x00000126 (294)	Microsoft ACPI-Compliant System
 (ISA) 0x00000127 (295)	Microsoft ACPI-Compliant System
 (ISA) 0x00000128 (296)	Microsoft ACPI-Compliant System
 (ISA) 0x00000129 (297)	Microsoft ACPI-Compliant System
 (ISA) 0x0000012A (298)	Microsoft ACPI-Compliant System
 (ISA) 0x0000012B (299)	Microsoft ACPI-Compliant System
 (ISA) 0x0000012C (300)	Microsoft ACPI-Compliant System

---

---











































 (ISA) 0x0000012C (300)	Microsoft ACPI-Compliant System
 (ISA) 0x0000012D (301)	Microsoft ACPI-Compliant System
 (ISA) 0x0000012E (302)	Microsoft ACPI-Compliant System
 (ISA) 0x0000012F (303)	Microsoft ACPI-Compliant System
 (ISA) 0x00000130 (304)	Microsoft ACPI-Compliant System
 (ISA) 0x00000131 (305)	Microsoft ACPI-Compliant System
 (ISA) 0x00000132 (306)	Microsoft ACPI-Compliant System
 (ISA) 0x00000133 (307)	Microsoft ACPI-Compliant System
 (ISA) 0x00000134 (308)	Microsoft ACPI-Compliant System
 (ISA) 0x00000135 (309)	Microsoft ACPI-Compliant System
 (ISA) 0x00000136 (310)	Microsoft ACPI-Compliant System
 (ISA) 0x00000137 (311)	Microsoft ACPI-Compliant System
 (ISA) 0x00000138 (312)	Microsoft ACPI-Compliant System
 (ISA) 0x00000139 (313)	Microsoft ACPI-Compliant System
 (ISA) 0x0000013A (314)	Microsoft ACPI-Compliant System
 (ISA) 0x0000013B (315)	Microsoft ACPI-Compliant System
 (ISA) 0x0000013C (316)	Microsoft ACPI-Compliant System
 (ISA) 0x0000013D (317)	Microsoft ACPI-Compliant System
 (ISA) 0x0000013E (318)	Microsoft ACPI-Compliant System
 (ISA) 0x0000013F (319)	Microsoft ACPI-Compliant System
 (ISA) 0x00000140 (320)	Microsoft ACPI-Compliant System
 (ISA) 0x00000141 (321)	Microsoft ACPI-Compliant System
 (ISA) 0x00000142 (322)	Microsoft ACPI-Compliant System
 (ISA) 0x00000143 (323)	Microsoft ACPI-Compliant System
 (ISA) 0x00000144 (324)	Microsoft ACPI-Compliant System
 (ISA) 0x00000145 (325)	Microsoft ACPI-Compliant System
 (ISA) 0x00000146 (326)	Microsoft ACPI-Compliant System
 (ISA) 0x00000147 (327)	Microsoft ACPI-Compliant System
 (ISA) 0x00000148 (328)	Microsoft ACPI-Compliant System
 (ISA) 0x00000149 (329)	Microsoft ACPI-Compliant System
 (ISA) 0x0000014A (330)	Microsoft ACPI-Compliant System
 (ISA) 0x0000014B (331)	Microsoft ACPI-Compliant System
 (ISA) 0x0000014C (332)	Microsoft ACPI-Compliant System
 (ISA) 0x0000014D (333)	Microsoft ACPI-Compliant System
 (ISA) 0x0000014E (334)	Microsoft ACPI-Compliant System
 (ISA) 0x0000014F (335)	Microsoft ACPI-Compliant System
 (ISA) 0x00000150 (336)	Microsoft ACPI-Compliant System
 (ISA) 0x00000151 (337)	Microsoft ACPI-Compliant System
 (ISA) 0x00000152 (338)	Microsoft ACPI-Compliant System
 (ISA) 0x00000153 (339)	Microsoft ACPI-Compliant System
 (ISA) 0x00000154 (340)	Microsoft ACPI-Compliant System
 (ISA) 0x00000155 (341)	Microsoft ACPI-Compliant System

---

	(ISA) 0x00000154 (340)	Microsoft ACPI-Compliant System
	(ISA) 0x00000155 (341)	Microsoft ACPI-Compliant System
	(ISA) 0x00000156 (342)	Microsoft ACPI-Compliant System
	(ISA) 0x00000157 (343)	Microsoft ACPI-Compliant System
	(ISA) 0x00000158 (344)	Microsoft ACPI-Compliant System
	(ISA) 0x00000159 (345)	Microsoft ACPI-Compliant System
	(ISA) 0x0000015A (346)	Microsoft ACPI-Compliant System
	(ISA) 0x0000015B (347)	Microsoft ACPI-Compliant System
	(ISA) 0x0000015C (348)	Microsoft ACPI-Compliant System
	(ISA) 0x0000015D (349)	Microsoft ACPI-Compliant System
	(ISA) 0x0000015E (350)	Microsoft ACPI-Compliant System
	(ISA) 0x0000015F (351)	Microsoft ACPI-Compliant System
	(ISA) 0x00000160 (352)	Microsoft ACPI-Compliant System
	(ISA) 0x00000161 (353)	Microsoft ACPI-Compliant System
	(ISA) 0x00000162 (354)	Microsoft ACPI-Compliant System
	(ISA) 0x00000163 (355)	Microsoft ACPI-Compliant System
	(ISA) 0x00000164 (356)	Microsoft ACPI-Compliant System
	(ISA) 0x00000165 (357)	Microsoft ACPI-Compliant System
	(ISA) 0x00000166 (358)	Microsoft ACPI-Compliant System
	(ISA) 0x00000167 (359)	Microsoft ACPI-Compliant System
	(ISA) 0x00000168 (360)	Microsoft ACPI-Compliant System
	(ISA) 0x00000169 (361)	Microsoft ACPI-Compliant System
	(ISA) 0x0000016A (362)	Microsoft ACPI-Compliant System
	(ISA) 0x0000016B (363)	Microsoft ACPI-Compliant System
	(ISA) 0x0000016C (364)	Microsoft ACPI-Compliant System
	(ISA) 0x0000016D (365)	Microsoft ACPI-Compliant System
	(ISA) 0x0000016E (366)	Microsoft ACPI-Compliant System
	(ISA) 0x0000016F (367)	Microsoft ACPI-Compliant System
	(ISA) 0x00000170 (368)	Microsoft ACPI-Compliant System
	(ISA) 0x00000171 (369)	Microsoft ACPI-Compliant System
	(ISA) 0x00000172 (370)	Microsoft ACPI-Compliant System
	(ISA) 0x00000173 (371)	Microsoft ACPI-Compliant System
	(ISA) 0x00000174 (372)	Microsoft ACPI-Compliant System
	(ISA) 0x00000175 (373)	Microsoft ACPI-Compliant System
	(ISA) 0x00000176 (374)	Microsoft ACPI-Compliant System
	(ISA) 0x00000177 (375)	Microsoft ACPI-Compliant System
	(ISA) 0x00000178 (376)	Microsoft ACPI-Compliant System
	(ISA) 0x00000179 (377)	Microsoft ACPI-Compliant System
	(ISA) 0x0000017A (378)	Microsoft ACPI-Compliant System
	(ISA) 0x0000017B (379)	Microsoft ACPI-Compliant System
	(ISA) 0x0000017C (380)	Microsoft ACPI-Compliant System
	(ISA) 0x0000017D (381)	Microsoft ACPI-Compliant System













































---











































 (ISA) 0x000017C (380)	Microsoft ACPI-Compliant System
 (ISA) 0x000017D (381)	Microsoft ACPI-Compliant System
 (ISA) 0x000017E (382)	Microsoft ACPI-Compliant System
 (ISA) 0x000017F (383)	Microsoft ACPI-Compliant System
 (ISA) 0x0000180 (384)	Microsoft ACPI-Compliant System
 (ISA) 0x0000181 (385)	Microsoft ACPI-Compliant System
 (ISA) 0x0000182 (386)	Microsoft ACPI-Compliant System
 (ISA) 0x0000183 (387)	Microsoft ACPI-Compliant System
 (ISA) 0x0000184 (388)	Microsoft ACPI-Compliant System
 (ISA) 0x0000185 (389)	Microsoft ACPI-Compliant System
 (ISA) 0x0000186 (390)	Microsoft ACPI-Compliant System
 (ISA) 0x0000187 (391)	Microsoft ACPI-Compliant System
 (ISA) 0x0000188 (392)	Microsoft ACPI-Compliant System
 (ISA) 0x0000189 (393)	Microsoft ACPI-Compliant System
 (ISA) 0x000018A (394)	Microsoft ACPI-Compliant System
 (ISA) 0x000018B (395)	Microsoft ACPI-Compliant System
 (ISA) 0x000018C (396)	Microsoft ACPI-Compliant System
 (ISA) 0x000018D (397)	Microsoft ACPI-Compliant System
 (ISA) 0x000018E (398)	Microsoft ACPI-Compliant System
 (ISA) 0x000018F (399)	Microsoft ACPI-Compliant System
 (ISA) 0x0000190 (400)	Microsoft ACPI-Compliant System
 (ISA) 0x0000191 (401)	Microsoft ACPI-Compliant System
 (ISA) 0x0000192 (402)	Microsoft ACPI-Compliant System
 (ISA) 0x0000193 (403)	Microsoft ACPI-Compliant System
 (ISA) 0x0000194 (404)	Microsoft ACPI-Compliant System
 (ISA) 0x0000195 (405)	Microsoft ACPI-Compliant System
 (ISA) 0x0000196 (406)	Microsoft ACPI-Compliant System
 (ISA) 0x0000197 (407)	Microsoft ACPI-Compliant System
 (ISA) 0x0000198 (408)	Microsoft ACPI-Compliant System
 (ISA) 0x0000199 (409)	Microsoft ACPI-Compliant System
 (ISA) 0x000019A (410)	Microsoft ACPI-Compliant System
 (ISA) 0x000019B (411)	Microsoft ACPI-Compliant System
 (ISA) 0x000019C (412)	Microsoft ACPI-Compliant System
 (ISA) 0x000019D (413)	Microsoft ACPI-Compliant System
 (ISA) 0x000019E (414)	Microsoft ACPI-Compliant System
 (ISA) 0x000019F (415)	Microsoft ACPI-Compliant System
 (ISA) 0x00001A0 (416)	Microsoft ACPI-Compliant System
 (ISA) 0x00001A1 (417)	Microsoft ACPI-Compliant System
 (ISA) 0x00001A2 (418)	Microsoft ACPI-Compliant System
 (ISA) 0x00001A3 (419)	Microsoft ACPI-Compliant System
 (ISA) 0x00001A4 (420)	Microsoft ACPI-Compliant System
 (ISA) 0x00001A5 (421)	Microsoft ACPI-Compliant System

---













































 (ISA) 0x000001A4 (420)	Microsoft ACPI-Compliant System
 (ISA) 0x000001A5 (421)	Microsoft ACPI-Compliant System
 (ISA) 0x000001A6 (422)	Microsoft ACPI-Compliant System
 (ISA) 0x000001A7 (423)	Microsoft ACPI-Compliant System
 (ISA) 0x000001A8 (424)	Microsoft ACPI-Compliant System
 (ISA) 0x000001A9 (425)	Microsoft ACPI-Compliant System
 (ISA) 0x000001AA (426)	Microsoft ACPI-Compliant System
 (ISA) 0x000001AB (427)	Microsoft ACPI-Compliant System
 (ISA) 0x000001AC (428)	Microsoft ACPI-Compliant System
 (ISA) 0x000001AD (429)	Microsoft ACPI-Compliant System
 (ISA) 0x000001AE (430)	Microsoft ACPI-Compliant System
 (ISA) 0x000001AF (431)	Microsoft ACPI-Compliant System
 (ISA) 0x000001B0 (432)	Microsoft ACPI-Compliant System
 (ISA) 0x000001B1 (433)	Microsoft ACPI-Compliant System
 (ISA) 0x000001B2 (434)	Microsoft ACPI-Compliant System
 (ISA) 0x000001B3 (435)	Microsoft ACPI-Compliant System
 (ISA) 0x000001B4 (436)	Microsoft ACPI-Compliant System
 (ISA) 0x000001B5 (437)	Microsoft ACPI-Compliant System
 (ISA) 0x000001B6 (438)	Microsoft ACPI-Compliant System
 (ISA) 0x000001B7 (439)	Microsoft ACPI-Compliant System
 (ISA) 0x000001B8 (440)	Microsoft ACPI-Compliant System
 (ISA) 0x000001B9 (441)	Microsoft ACPI-Compliant System
 (ISA) 0x000001BA (442)	Microsoft ACPI-Compliant System
 (ISA) 0x000001BB (443)	Microsoft ACPI-Compliant System
 (ISA) 0x000001BC (444)	Microsoft ACPI-Compliant System
 (ISA) 0x000001BD (445)	Microsoft ACPI-Compliant System
 (ISA) 0x000001BE (446)	Microsoft ACPI-Compliant System
 (ISA) 0x000001BF (447)	Microsoft ACPI-Compliant System
 (ISA) 0x000001C0 (448)	Microsoft ACPI-Compliant System
 (ISA) 0x000001C1 (449)	Microsoft ACPI-Compliant System
 (ISA) 0x000001C2 (450)	Microsoft ACPI-Compliant System
 (ISA) 0x000001C3 (451)	Microsoft ACPI-Compliant System
 (ISA) 0x000001C4 (452)	Microsoft ACPI-Compliant System
 (ISA) 0x000001C5 (453)	Microsoft ACPI-Compliant System
 (ISA) 0x000001C6 (454)	Microsoft ACPI-Compliant System
 (ISA) 0x000001C7 (455)	Microsoft ACPI-Compliant System
 (ISA) 0x000001C8 (456)	Microsoft ACPI-Compliant System
 (ISA) 0x000001C9 (457)	Microsoft ACPI-Compliant System
 (ISA) 0x000001CA (458)	Microsoft ACPI-Compliant System
 (ISA) 0x000001CB (459)	Microsoft ACPI-Compliant System
 (ISA) 0x000001CC (460)	Microsoft ACPI-Compliant System
 (ISA) 0x000001CD (461)	Microsoft ACPI-Compliant System

---

 (ISA) 0x000001CC (460)	Microsoft ACPI-Compliant System
 (ISA) 0x000001CD (461)	Microsoft ACPI-Compliant System
 (ISA) 0x000001CE (462)	Microsoft ACPI-Compliant System
 (ISA) 0x000001CF (463)	Microsoft ACPI-Compliant System
 (ISA) 0x000001D0 (464)	Microsoft ACPI-Compliant System
 (ISA) 0x000001D1 (465)	Microsoft ACPI-Compliant System
 (ISA) 0x000001D2 (466)	Microsoft ACPI-Compliant System
 (ISA) 0x000001D3 (467)	Microsoft ACPI-Compliant System
 (ISA) 0x000001D4 (468)	Microsoft ACPI-Compliant System
 (ISA) 0x000001D5 (469)	Microsoft ACPI-Compliant System
 (ISA) 0x000001D6 (470)	Microsoft ACPI-Compliant System
 (ISA) 0x000001D7 (471)	Microsoft ACPI-Compliant System
 (ISA) 0x000001D8 (472)	Microsoft ACPI-Compliant System
 (ISA) 0x000001D9 (473)	Microsoft ACPI-Compliant System
 (ISA) 0x000001DA (474)	Microsoft ACPI-Compliant System
 (ISA) 0x000001DB (475)	Microsoft ACPI-Compliant System
 (ISA) 0x000001DC (476)	Microsoft ACPI-Compliant System
 (ISA) 0x000001DD (477)	Microsoft ACPI-Compliant System
 (ISA) 0x000001DE (478)	Microsoft ACPI-Compliant System
 (ISA) 0x000001DF (479)	Microsoft ACPI-Compliant System
 (ISA) 0x000001E0 (480)	Microsoft ACPI-Compliant System
 (ISA) 0x000001E1 (481)	Microsoft ACPI-Compliant System
 (ISA) 0x000001E2 (482)	Microsoft ACPI-Compliant System
 (ISA) 0x000001E3 (483)	Microsoft ACPI-Compliant System
 (ISA) 0x000001E4 (484)	Microsoft ACPI-Compliant System
 (ISA) 0x000001E5 (485)	Microsoft ACPI-Compliant System
 (ISA) 0x000001E6 (486)	Microsoft ACPI-Compliant System
 (ISA) 0x000001E7 (487)	Microsoft ACPI-Compliant System
 (ISA) 0x000001E8 (488)	Microsoft ACPI-Compliant System
 (ISA) 0x000001E9 (489)	Microsoft ACPI-Compliant System
 (ISA) 0x000001EA (490)	Microsoft ACPI-Compliant System
 (ISA) 0x000001EB (491)	Microsoft ACPI-Compliant System
 (ISA) 0x000001EC (492)	Microsoft ACPI-Compliant System
 (ISA) 0x000001ED (493)	Microsoft ACPI-Compliant System
 (ISA) 0x000001EE (494)	Microsoft ACPI-Compliant System
 (ISA) 0x000001EF (495)	Microsoft ACPI-Compliant System
 (ISA) 0x000001F0 (496)	Microsoft ACPI-Compliant System
 (ISA) 0x000001F1 (497)	Microsoft ACPI-Compliant System
 (ISA) 0x000001F2 (498)	Microsoft ACPI-Compliant System
 (ISA) 0x000001F3 (499)	Microsoft ACPI-Compliant System
 (ISA) 0x000001F4 (500)	Microsoft ACPI-Compliant System
 (ISA) 0x000001F5 (501)	Microsoft ACPI-Compliant System

---

 (ISA) 0x00001EF (495)	Microsoft ACPI-Compliant System
 (ISA) 0x00001F0 (496)	Microsoft ACPI-Compliant System
 (ISA) 0x00001F1 (497)	Microsoft ACPI-Compliant System
 (ISA) 0x00001F2 (498)	Microsoft ACPI-Compliant System
 (ISA) 0x00001F3 (499)	Microsoft ACPI-Compliant System
 (ISA) 0x00001F4 (500)	Microsoft ACPI-Compliant System
 (ISA) 0x00001F5 (501)	Microsoft ACPI-Compliant System
 (ISA) 0x00001F6 (502)	Microsoft ACPI-Compliant System
 (ISA) 0x00001F7 (503)	Microsoft ACPI-Compliant System
 (ISA) 0x00001F8 (504)	Microsoft ACPI-Compliant System
 (ISA) 0x00001F9 (505)	Microsoft ACPI-Compliant System
 (ISA) 0x00001FA (506)	Microsoft ACPI-Compliant System
 (ISA) 0x00001FB (507)	Microsoft ACPI-Compliant System
 (ISA) 0x00001FC (508)	Microsoft ACPI-Compliant System
 (ISA) 0x00001FD (509)	Microsoft ACPI-Compliant System
 (ISA) 0x00001FE (510)	Microsoft ACPI-Compliant System
 (ISA) 0x00001FF (511)	Microsoft ACPI-Compliant System
 (PCI) 0x00000010 (16)	High Definition Audio Controller
 (PCI) 0x00000010 (16)	Intel SD Host Controller
 (PCI) 0x00000010 (16)	Intel(R) Serial IO I2C Host Controller - 4B44
 (PCI) 0x00000011 (17)	Intel(R) Serial IO I2C Host Controller - 4B45
 (PCI) 0xFFFFFEC (-20)	Intel(R) Serial IO I2C Host Controller - 4B8A
 (PCI) 0xFFFFFED (-19)	Intel(R) Serial IO I2C Host Controller - 4BB9
 (PCI) 0xFFFFFEE (-18)	Intel(R) Serial IO I2C Host Controller - 4BC0
 (PCI) 0xFFFFFEF (-17)	Intel(R) Management Engine Interface #1
 (PCI) 0xFFFFFFF0 (-16)	Intel(R) Serial IO I2C Host Controller - 4BBF
 (PCI) 0xFFFFFFF1 (-15)	Intel(R) Serial IO SPI Host Controller - 4B84
 (PCI) 0xFFFFFFF2 (-14)	Intel(R) Serial IO UART Host Controller - 4B97
 (PCI) 0xFFFFFFF3 (-13)	Intel(R) Serial IO UART Host Controller - 4B96
 (PCI) 0xFFFFFFF4 (-12)	Intel(R) Integrated Sensor Solution
 (PCI) 0xFFFFFFF5 (-11)	Intel(R) USB 3.10 eXtensible Host Controller - 1.20 (Microsoft)
 (PCI) 0xFFFFFFF6 (-10)	Intel(R) UHD Graphics
 (PCI) 0xFFFFFFF7 (-9)	Realtek PCIe GbE Family Controller #2
 (PCI) 0xFFFFFFF8 (-8)	Realtek PCIe GbE Family Controller
 (PCI) 0xFFFFFFF9 (-7)	Standard SATA AHCI Controller
 (PCI) 0xFFFFF0FA (-6)	Intel(R) PCI Express Root Port #6 - 4B3E
 (PCI) 0xFFFFF0FB (-5)	Intel(R) PCI Express Root Port #2 - 4B3A
 (PCI) 0xFFFFF0FC (-4)	Intel(R) PCI Express Root Port #1 - 4B39
 (PCI) 0xFFFFF0FD (-3)	Intel(R) PCI Express Root Port #3 - 4B3B
 (PCI) 0xFFFFF0FE (-2)	Intel(R) PCI Express Root Port #0 - 4B38
 Large Memory	
 Memory	

## B.4 Large Memory Map

---

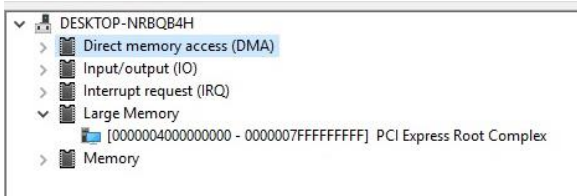



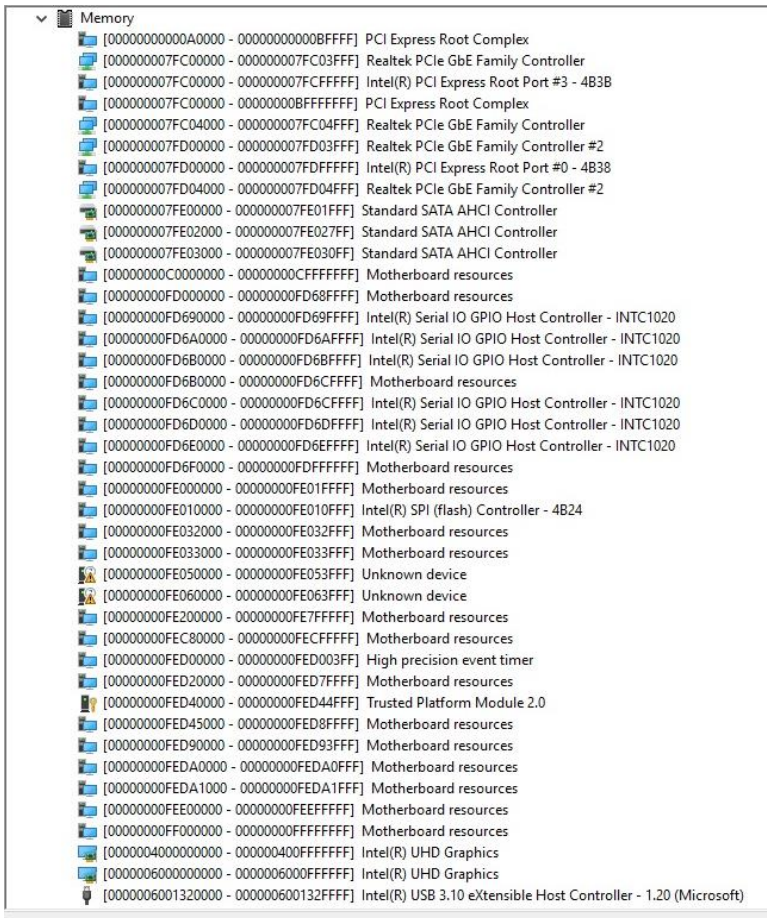







































## B.5 Memory Address Map



Address Range	Device Name
[0000000000A0000 - 0000000000BFFFF]	PCI Express Root Complex
[000000007FC00000 - 000000007FC03FFF]	Realtek PCIe GbE Family Controller
[000000007FC00000 - 000000007FCFFFFF]	Intel(R) PCI Express Root Port #3 - 4B3B
[000000007FC00000 - 00000000BFFFFFFF]	PCI Express Root Complex
[000000007FC04000 - 000000007FC04FFF]	Realtek PCIe GbE Family Controller
[000000007FD00000 - 000000007FD03FFF]	Realtek PCIe GbE Family Controller #2
[000000007FD00000 - 000000007FDFFFFFFF]	Intel(R) PCI Express Root Port #0 - 4B38
[000000007FD04000 - 000000007FD04FFF]	Realtek PCIe GbE Family Controller #2
[000000007FE00000 - 000000007FE01FFF]	Standard SATA AHCI Controller
[000000007FE02000 - 000000007FE027FF]	Standard SATA AHCI Controller
[000000007FE03000 - 000000007FE030FF]	Standard SATA AHCI Controller
[00000000C0000000 - 00000000CFFFFFFF]	Motherboard resources
[00000000FD000000 - 00000000FD68FFFFF]	Motherboard resources
[00000000FD690000 - 00000000FD69FFFFF]	Intel(R) Serial IO GPIO Host Controller - INTC1020
[00000000FD6A0000 - 00000000FD6AFFFFF]	Intel(R) Serial IO GPIO Host Controller - INTC1020
[00000000FD6B0000 - 00000000FD6BFFFFF]	Intel(R) Serial IO GPIO Host Controller - INTC1020
[00000000FD6B0000 - 00000000FD6CFFFFF]	Motherboard resources
[00000000FD6C0000 - 00000000FD6CFFFFF]	Intel(R) Serial IO GPIO Host Controller - INTC1020
[00000000FD6D0000 - 00000000FD6DFFFFF]	Intel(R) Serial IO GPIO Host Controller - INTC1020
[00000000FD6E0000 - 00000000FD6EFFFFF]	Intel(R) Serial IO GPIO Host Controller - INTC1020
[00000000FD6F0000 - 00000000FDFFFFFFF]	Motherboard resources
[00000000FE000000 - 00000000FE01FFFFF]	Motherboard resources
[00000000FE010000 - 00000000FE010FFF]	Intel(R) SPI (flash) Controller - 4B24
[00000000FE032000 - 00000000FE032FFF]	Motherboard resources
[00000000FE033000 - 00000000FE033FFF]	Motherboard resources
[00000000FE050000 - 00000000FE053FFF]	Unknown device
[00000000FE060000 - 00000000FE063FFF]	Unknown device
[00000000FE200000 - 00000000FE7FFFFFFF]	Motherboard resources
[00000000FEC80000 - 00000000FECFFFFFFF]	Motherboard resources
[00000000FED00000 - 00000000FED003FF]	High precision event timer
[00000000FED20000 - 00000000FED7FFFFF]	Motherboard resources
[00000000FED40000 - 00000000FED44FFF]	Trusted Platform Module 2.0
[00000000FED45000 - 00000000FED8FFFFF]	Motherboard resources
[00000000FED90000 - 00000000FED93FFF]	Motherboard resources
[00000000FEDA0000 - 00000000FEDA0FFF]	Motherboard resources
[00000000FEDA1000 - 00000000FEDA1FFF]	Motherboard resources
[00000000FEE00000 - 00000000FEEFFFFFFF]	Motherboard resources
[00000000FF000000 - 00000000FFFFFFF]	Motherboard resources
[0000000400000000 - 0000000400FFFFFFF]	Intel(R) UHD Graphics
[0000000600000000 - 0000000600FFFFFFF]	Intel(R) UHD Graphics
[00000006001320000 - 0000000600132FFFFF]	Intel(R) USB 3.10 eXtensible Host Controller - 1.20 (Microsoft)



---

	[00000000FD6A0000 - 00000000FD6AFFFF]	Intel(R) Serial IO GPIO Host Controller - INTC1020
	[00000000FD6B0000 - 00000000FD6BFFFF]	Intel(R) Serial IO GPIO Host Controller - INTC1020
	[00000000FD6B0000 - 00000000FD6CFFFF]	Motherboard resources
	[00000000FD6C0000 - 00000000FD6CFFFF]	Intel(R) Serial IO GPIO Host Controller - INTC1020
	[00000000FD6D0000 - 00000000FD6DFFFF]	Intel(R) Serial IO GPIO Host Controller - INTC1020
	[00000000FD6E0000 - 00000000FD6EFFFF]	Intel(R) Serial IO GPIO Host Controller - INTC1020
	[00000000FD6F0000 - 00000000FD6FFFFF]	Motherboard resources
	[00000000FE000000 - 00000000FE01FFFF]	Motherboard resources
	[00000000FE010000 - 00000000FE010FFF]	Intel(R) SPI (flash) Controller - 4B24
	[00000000FE032000 - 00000000FE032FFF]	Motherboard resources
	[00000000FE033000 - 00000000FE033FFF]	Motherboard resources
	[00000000FE050000 - 00000000FE053FFF]	Unknown device
	[00000000FE060000 - 00000000FE063FFF]	Unknown device
	[00000000FE200000 - 00000000FE7FFFFF]	Motherboard resources
	[00000000FEC80000 - 00000000FEC8FFFF]	Motherboard resources
	[00000000FED00000 - 00000000FED003FF]	High precision event timer
	[00000000FED20000 - 00000000FED7FFFF]	Motherboard resources
	[00000000FED40000 - 00000000FED44FFF]	Trusted Platform Module 2.0
	[00000000FED45000 - 00000000FED8FFFF]	Motherboard resources
	[00000000FED90000 - 00000000FED93FFF]	Motherboard resources
	[00000000FEDA0000 - 00000000FEDA0FFF]	Motherboard resources
	[00000000FEDA1000 - 00000000FEDA1FFF]	Motherboard resources
	[00000000FEE00000 - 00000000FEEFFFFF]	Motherboard resources
	[00000000FF000000 - 00000000FFFFFFFF]	Motherboard resources
	[0000004000000000 - 0000004000000000]	Intel(R) UHD Graphics
	[0000006000000000 - 0000006000000000]	Intel(R) UHD Graphics
	[0000006001320000 - 000000600132FFFF]	Intel(R) USB 3.10 eXtensible Host Controller - 1.20 (Microsoft)
	[0000006001346000 - 00000060013460FF]	Intel(R) SMBus Controller - 4B23
	[0000006001349000 - 0000006001349FFF]	Intel SD Host Controller
	[0000007FFFCEB000 - 0000007FFFCEBFFF]	Intel(R) Management Engine Interface #1
	[0000007FFFCEC000 - 0000007FFFCECFFF]	Intel(R) Serial IO I2C Host Controller - 4B45
	[0000007FFFCE0000 - 0000007FFFCE0FFF]	Intel(R) Serial IO I2C Host Controller - 4B44
	[0000007FFFCEE000 - 0000007FFFCEEFFF]	Intel(R) Serial IO I2C Host Controller - 4BBA
	[0000007FFFCE0000 - 0000007FFFCE1FFF]	Intel(R) Serial IO I2C Host Controller - 4BB9
	[0000007FFFCE2000 - 0000007FFFCE3FFF]	Intel(R) Serial IO I2C Host Controller - 4BC0
	[0000007FFFCE4000 - 0000007FFFCE5FFF]	Intel(R) Serial IO I2C Host Controller - 4BBF
	[0000007FFFCE6000 - 0000007FFFCE7FFF]	Intel(R) Serial IO SPI Host Controller - 4B84
	[0000007FFFCE8000 - 0000007FFFCE9FFF]	Intel(R) Serial IO UART Host Controller - 4B97
	[0000007FFFCEA000 - 0000007FFFCEBFFF]	Intel(R) Serial IO UART Host Controller - 4B96
	[0000007FFFCE0000 - 0000007FFFCEFFFF]	High Definition Audio Controller
	[0000007FFFCE0000 - 0000007FFFCEFFFF]	High Definition Audio Controller
	[0000007FFFE00000 - 0000007FFFEFFFFF]	Intel(R) Integrated Sensor Solution

---

# Appendix C

---

## Watchdog Timer Programming

## C.1 Introduction to Watchdog Timer

---

This section details how to set up and program the Watchdog Timer for your AAEON system or board. The watchdog timer is used to automatically detect malfunctions and recover the system. During normal operation, the system will regularly send a signal to reset the watchdog timer. If the system does not reset the watchdog timer, it will timeout and force the system into recovery and/or reboot.

The following sections refer to additional software used for programming your board, such as the AAEON Framework, AAEON SDK and AAEON Windows EAPI. If you need assistance with utilizing these tools, programming your Watchdog Timer, or would like additional documentation on these resources, contact your AAEON representative or visit our support page at <https://www.aaeon.com/en/support/>



## C.2 Programing the Watchdog Timer with AAEON SDK

---

If you have installed the AAEON Framework, you can program the Watchdog Timer using the AAEON SDK. Simply locate where the SDK is installed, and double click the icon. The following dialog box will appear:

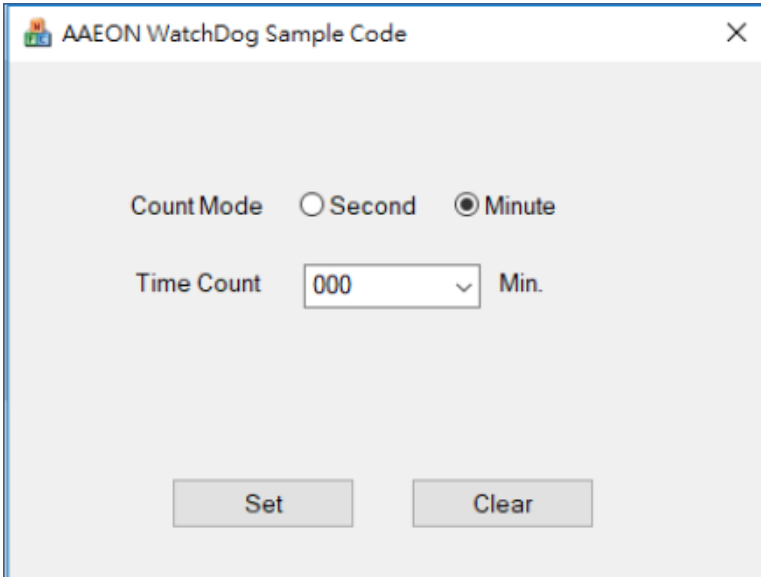

**Count Mode:** Set Watchdog Timer to count in minutes or seconds.

**Time Count:** The length of time (in minutes or seconds) before the Watchdog Timer will initiate a system recovery/ reboot.

**Set:** After selecting Count Mode and Time Count, this will save your changes and enable the Watchdog Timer function.

**Clear:** This will reset settings and disable the Watchdog Timer function.

### C.3 Programing Watchdog Timer with AAEON Windows EAPI

---

AAEON Framework (KMDF Driver) must be installed before calling these functions.

**EapiLibInitialize()** should be the first to call before calling other EAPI functions.

**EapiLibUnInitialize()** should be called to release resources before program exit.

When building C/C++ apps, Lib (Library, aaeonEAPI.lib) is needed.

aaeonEAPI.lib is needed for C/C++ based app, make sure the lib files and executable files are in the same folder.

The following shows how to build and run codes:

There are two scenarios to invoke Watchdog Timer functions:

#### 1. Use **EApiWDogStart**

After EAPIWDogStart

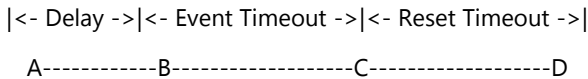

#### 2. Use **EApiWDogTrigger**

After EApiWDogTrigger

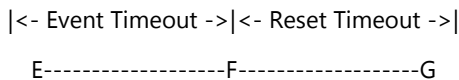

**Stage A:** Watchdog is started.

**Stage B:** Initial Delay Period.

**Stage C/F:** Event is triggered, NMI, IRQ, or PIN is Triggered. This allows for possible Software Recovery.

**Stage D/G:** System is reset.

**Stage E:** Watchdog is Triggered.

**EApiWDogStop** must be called before Stage C/F to prevent event from being generated.

EApiWDogStop must be called before Stage D/G to prevent system from being reset.

### C.3.1 Watchdog Timer Functions

#### C.3.1.1 EapiWDogGetCap()

Command Line:

```
EApiWDogGetCap(...)
    __OUTOPT uint32_t *pMaxDelay,
    __OUTOPT uint32_t *pMaxEventTimeout,
    __OUTOPT uint32_t *pMaxResetTimeout
)
```

Use this command to get maximum Supported Delay / Supported Event Timeout / Supported Reset Timeout of the watchdog timer.

Parameters	Function Parameters
*pMaxDelay	Maximum Supported Delay in milliseconds
*pMaxEvenTimeout	Maximum Supported Event Timeout in milliseconds; 0 = Unsupported
*pMaxResetTimeout	Maximum Supported Reset Timeout in milliseconds
Condition	Return Values
Library Uninitialized	EAPI_STATUS_NOT_INITIALIZED
pMaxDelay == NULL && pMaxResetTimeout == NULL && pMaxEventTimeout == NULL	EAPI_STATUS_INVALID_PARAMETER
Common Error	Common Error Code
Others	EAPI_STATUS_SUCCESS

### C.3.1.2 EApiWDogStart()

Command Line:

```
EApiWDogStart(  
    _IN uint32_t Delay,  
    _IN uint32_t Minute,  
    _IN uint32_t EventTimeout,  
    _IN uint32_t ResetTimeout  
)
```

Use this command to start the Watchdog Timer and set the timeout values.

To stop the Watchdog Timer, issue the command **EApiWDogStop**. After issuing EApiWDogStop, the command EApiWDogStart must be called again with new values to restart.

If the hardware implementation of the watchdog timer does not allow the user to select the exact time they want, the EAPI will select the next longer time setting available.

Parameters	Function Parameters
Delay	Delay in milliseconds
Minute	Control minutes or seconds
EventTimeout	Event Timeout in milliseconds
ResetTimeout	Reset Timeout in milliseconds
Condition	Return Values
Library Uninitialized	EAPI_STATUS_NOT_INITIALIZED
(Delay > gMaxDelay) (EventTimeout > gMaxEventTimeout) (ResetTimeout > gMaxResetTimeout)	EAPI_STATUS_INVALID_PARAMETER
Common Error	Common Error Code
Others	EAPI_STATUS_SUCCESS

### C.3.1.3 EapiWDogTrigger()

Command Line:

```
EapiWDogTrigger()
```

Use this command to trigger the Watchdog Timer.

Parameters	Function Parameters
None	
Condition	Return Values
Library Uninitialized	EAPI_STATUS_NOT_INITIALIZED
Watchdog Not Started	EAPI_STATUS_ERROR
Common Error	Common Error Code
Others	EAPI_STATUS_SUCCESS

### C.3.1.4 EapiWDogStop()

Command Line:

```
EapiWDogStop()
```

Use this command to close the Watchdog Instance. This will disable the Watchdog Timer and clear previous settings.

Parameters	Function Parameters
None	
Condition	Return Values
Library Uninitialized	EAPI_STATUS_NOT_INITIALIZED
Common Error	Common Error Code
Others	EAPI_STATUS_SUCCESS

### C.3.1.5 EapiWDogReloadTimer()

Command Line:

```
EapiWDogReloadTimer()
```

Use this command to reload the Timeout count

Parameters	Function Parameters
None	
Condition	Return Values
Library Uninitialized	EAPI_STATUS_NOT_INITIALIZED
Common Error	Common Error Code
Others	EAPI_STATUS_SUCCESS

### C.3.1.6 EapiWDogGetStatus()

Command Line:

```
EapiWDogGetStatus(
    _OUTOPT uint32_t *pwdtMinute,
    _OUTOPT uint32_t *pwdtCountTime,
    _OUTOPT uint32_t *pwdtReloadTime
)
```

Use this command to get the Watchdog Timer mode, time count value and reload timer.

Parameters	Function Parameters
*pwtMinute	Get the mode of minute or second
*pwtCountTime	Get WDT time count
*pwtReloadTime	Get WDT ReloadTime
Condition	Return Values
Library Uninitialized	EAPI_STATUS_NOT_INITIALIZED
Common Error	Common Error Code
Others	EAPI_STATUS_SUCCESS

### C.3.1.7 EapiWDogSetStatus()

Command Line:

```
EApiWDogSetStatus(  
    __IN uint32_t wdtMinute,  
    __IN uint32_t wdtCountTime,  
    __IN uint32_t wdtReloadTime  
)
```

Use this command to set Watchdog Timer mode, time count value and reload timer.

Parameters	Function Parameters
wdtMinute	Set the mode of minute or second
wdtCountTime	Set WDT time count
wdtReloadTime	Set WDT ReloadTime
Condition	Return Values
Library Uninitialized	EAPI_STATUS_NOT_INITIALIZED
Common Error	Common Error Code
Others	EAPI_STATUS_SUCCESS