

# PICO-BT01

---

Pico-ITX Board

User's Manual 10<sup>th</sup> Ed

## Copyright Notice

---

This document is copyrighted, 2019. All rights are reserved. The original manufacturer reserves the right to make improvements to the products described in this manual at any time without notice.

No part of this manual may be reproduced, copied, translated, or transmitted in any form or by any means without the prior written permission of the original manufacturer. Information provided in this manual is intended to be accurate and reliable. However, the original manufacturer assumes no responsibility for its use, or for any infringements upon the rights of third parties that may result from its use.

The material in this document is for product information only and is subject to change without notice. While reasonable efforts have been made in the preparation of this document to assure its accuracy, AAEMON assumes no liabilities resulting from errors or omissions in this document, or from the use of the information contained herein.

AAEMON reserves the right to make changes in the product design without notice to its users.

## Acknowledgement

---

All other products' name or trademarks are properties of their respective owners.

- Microsoft Windows® is a registered trademark of Microsoft Corp.
- ITE is a trademark of Integrated Technology Express, Inc.
- IBM, PC/AT, PS/2, and VGA are trademarks of International Business Machines Corporation.

All other product names or trademarks are properties of their respective owners.

## Packing List

---

Before setting up your product, please make sure the following items have been shipped:

Item	Quantity
● PICO-BT01	1
● Heat Spreader	1
● COM x2, Line-out Cable	1

If any of these items are missing or damaged, please contact your distributor or sales representative immediately.

## About this Document

---

This User's Manual contains all the essential information, such as detailed descriptions and explanations on the product's hardware and software features (if any), its specifications, dimensions, jumper/connector settings/definitions, and driver installation instructions (if any), to facilitate users in setting up their product.

Users may refer to the product page at [AAEON.com](http://AAEON.com) for the latest version of this document.

## Safety Precautions

---

Please read the following safety instructions carefully. It is advised that you keep this manual for future references

1. All cautions and warnings on the device should be noted.
2. Make sure the power source matches the power rating of the device.
3. Position the power cord so that people cannot step on it. Do not place anything over the power cord.
4. Always completely disconnect the power before working on the system's hardware.
5. No connections should be made when the system is powered as a sudden rush of power may damage sensitive electronic components.
6. If the device is not to be used for a long time, disconnect it from the power supply to avoid damage by transient over-voltage.
7. Always disconnect this device from any AC supply before cleaning.
8. While cleaning, use a damp cloth instead of liquid or spray detergents.
9. Make sure the device is installed near a power outlet and is easily accessible.
10. Keep this device away from humidity.
11. Place the device on a solid surface during installation to prevent falls
12. Do not cover the openings on the device to ensure optimal heat dissipation.
13. Watch out for high temperatures when the system is running.
14. Do not touch the heat sink or heat spreader when the system is running
15. Never pour any liquid into the openings. This could cause fire or electric shock.
16. As most electronic components are sensitive to static electrical charge, be sure to ground yourself to prevent static charge when installing the internal components. Use a grounding wrist strap and contain all electronic components in any static-shielded containers.

17. If any of the following situations arises, please the contact our service personnel:
  - i. Damaged power cord or plug
  - ii. Liquid intrusion to the device
  - iii. Exposure to moisture
  - iv. Device is not working as expected or in a manner as described in this manual
  - v. The device is dropped or damaged
  - vi. Any obvious signs of damage displayed on the device
  
18. **DO NOT LEAVE THIS DEVICE IN AN UNCONTROLLED ENVIRONMENT WHERE THE STORAGE TEMPERATURE IS BELOW -20° C (-4°F) OR ABOVE 60°C (140°F) TO PREVENT DAMAGE.**

### **Warning!**



This device complies with Part 15 FCC Rules. Operation is subject to the following two conditions: (1) this device may not cause harmful interference, and (2) this device must accept any interference received including interference that may cause undesired operation.

### **Caution:**

*There is a danger of explosion if the battery is incorrectly replaced. Replace only with the same or equivalent type recommended by the manufacturer. Dispose of used batteries according to the manufacturer's instructions and your local government's recycling or disposal directives.*

### **Attention:**

*Il y a un risque d'explosion si la batterie est remplacée de façon incorrecte. Ne la remplacer qu'avec le même modèle ou équivalent recommandé par le constructeur. Recycler les batteries usées en accord avec les instructions du fabricant et les directives gouvernementales de recyclage.*



## China RoHS Requirements (CN)

产品中有毒有害物质或元素名称及含量

AAEON Main Board/ Daughter Board/ Backplane

部件名称	有毒有害物质或元素					
	铅 (Pb)	汞 (Hg)	镉 (Cd)	六价铬 (Cr(VI))	多溴联苯 (PBB)	多溴二苯醚 (PBDE)
印刷电路板 及其电子组件	×	○	○	○	○	○
外部信号 连接器及线材	×	○	○	○	○	○
<p>○: 表示该有毒有害物质在该部件所有均质材料中的含量均在 SJ/T 11363-2006 标准规定的限量要求以下。</p> <p>X: 表示该有毒有害物质至少在该部件的某一均质材料中的含量超出 SJ/T 11363-2006 标准规定的限量要求。</p> <p>备注: 此产品所标示之环保使用期限, 系指在一般正常使用状况下。</p>						

## China RoHS Requirement (EN)

Poisonous or Hazardous Substances or Elements in Products

AAEON Main Board/ Daughter Board/ Backplane

Component	Poisonous or Hazardous Substances or Elements					
	Lead (Pb)	Mercury (Hg)	Cadmium (Cd)	Hexavalent Chromium (Cr(VI))	Polybrominated Biphenyls (PBB)	Polybrominated Diphenyl Ethers (PBDE)
PCB & Other Components	X	○	○	○	○	○
Wires & Connectors for External Connections	X	○	○	○	○	○
<p>O: The quantity of poisonous or hazardous substances or elements found in each of the component's parts is below the SJ/T 11363-2006-stipulated requirement.</p> <p>X: The quantity of poisonous or hazardous substances or elements found in at least one of the component's parts is beyond the SJ/T 11363-2006-stipulated requirement.</p> <p><b>Note:</b> The Environment Friendly Use Period as labeled on this product is applicable under normal usage only</p>						

## Table of Contents

---

<b>Chapter 1 - Product Specifications</b> .....	<b>1</b>
1.1 Specifications .....	2
<b>Chapter 2 – Hardware Information</b> .....	<b>5</b>
2.1 Dimensions .....	6
2.2 Jumpers and Connectors.....	11
2.3 List of Jumpers .....	13
2.3.1 Clear CMOS Jumper (JP1 1,3,5) .....	14
2.3.2 Auto Power Button Enable/Disable Selection (JP1 2,4,6) .....	14
2.3.3 LVDS Port Operating Voltage Selection (JP3) .....	14
2.3.4 LVDS Port Backlight Inverter Voltage Selection (JP4 1,3,5).....	14
2.3.5 LVDS Port Backlight Lightness Control Mode Selection (JP4,2,4,6).....	15
2.4 List of Connectors.....	16
2.4.1 Battery (CN1).....	17
2.4.2 DDR3L SO-DIMM Slot (CN2).....	17
2.4.3 VGA Port (CN3) .....	17
2.4.4 DP Port (CN4) .....	18
2.4.5 LVDS Port Inverter / Backlight Connector (CN5).....	19
2.4.6 LAN (RJ-45) Port (CN7).....	20
2.4.7 Digital IO Port (CN8) .....	21
2.4.8 MiniCard Slot (Full Size)/ Default mSATA (feature select by BOM) (CN9) .....	21
2.4.9 USB Ports 0 and 1 (CN10) .....	24
2.4.10 USB 2.0 Port 2 (CN11) .....	25
2.4.11 +5V Output for SATA HDD (CN14).....	26
2.4.12 SATA Port (CN15).....	26
2.4.13 LPC Port (CN18).....	27
2.4.14 Front Panel (CN19) .....	28

2.4.15	External +12V Input (CN20) .....	28
2.4.16	Buzzer Connector (CN21).....	29
2.4.17	BIO Connector (CN22).....	29
2.4.18	COM Port 1/2 & Line Out Connector (CN23).....	31
2.4.19	MiniCard Slot (Half-Mini Card) (CN24).....	33
2.4.20	LVDS Port (CN25).....	36
<b>Chapter 3 - AMI BIOS Setup .....</b>		<b>38</b>
3.1	System Test and Initialization .....	39
3.2	AMI BIOS Setup .....	40
3.3	Setup Submenu: Main.....	41
3.4	Setup Submenu: Advanced.....	42
3.4.1	Advanced: ACPI Settings .....	43
3.4.2	Advanced: F81801 Super IO Configuration .....	45
3.4.2.1	Super IO Configuration: Serial Port 1 Configuration .....	46
3.4.2.2	Super IO Configuration: Serial Port 2 Configuration .....	47
3.4.3	Advanced: Hardware Monitor .....	49
3.4.4	Advanced: CPU Configuration .....	50
3.4.4.1	CPU Configuration: Socket 0 CPU Information.....	51
3.4.5	Advanced: SATA Configuration .....	52
3.4.6	Advanced: Dynamic Digital IO Configuration .....	54
3.4.7	Advanced: USB Configuration.....	55
3.5	Setup submenu: Chipset.....	57
3.5.1	Chipset: North Bridge .....	58
3.5.2	Chipset: South Bridge.....	60
3.5.2.1	South Bridge: Azalia HD Audio .....	61
3.5.2.2	South Bridge: USB Configuration.....	62
3.5.2.3	South Bridge: PCI Express Configuration .....	63
3.6	Setup submenu: Security .....	64

3.7	Setup submenu: Boot.....	66
3.8	Setup submenu: Save & Exit.....	67
<b>Chapter 4 – Drivers Installation.....</b>		<b>68</b>
4.1	Driver Download/Installation.....	69
<b>Appendix A - Watchdog Timer Programming.....</b>		<b>71</b>
A.1	Watchdog Timer Registers.....	72
A.2	Watchdog Sample Program.....	73
<b>Appendix B - I/O Information.....</b>		<b>76</b>
B.1	I/O Address Map.....	77
B.2	Memory Address Map.....	78
B.3	IRQ Mapping Chart.....	79
<b>Appendix C – Electrical Specifications for I/O Ports.....</b>		<b>91</b>
C.1	Electrical Specifications for I/O Ports.....	92
<b>Appendix D – Mating Connectors.....</b>		<b>93</b>
D.1	List of Mating Connectors and Cables.....	94

# Chapter 1

---

Product Specifications

## 1.1 Specifications

---

### System

Form Factor	Pico-ITX
CPU	Onboard Intel® Atom™ E3845/ Celeron® J1900/N2807 Processor SoC
CPU Frequency	Up to 2.0 GHz
Chipset	Intel® E3845/J1900/N2807
Memory Type	204-pin DDR3L SODIMM x 1, DDR3L 1066/1333, Max. 8GB
Max. Memory Capacity	Up to 8GB
BIOS	AMI/SPI
Wake On LAN	Yes
Watchdog Timer	255 levels
Power Requirement	+12VDC
Power Supply Type	AT/ATX (default) optional lockable connector
Power Consumption (Typical)	Intel® Celeron® J1900 2.0GHz ,DDR3L 1333 MHz 8 GB 1.14A@+12V
System Cooling	Heat-spreader, heatsink or cooler optional
Dimension	3.94" x 2.84" (100mm x 72mm)
Gross Weight	0.88lb (0.4 kg)
Operating Temperature	32°F ~ 140°F (0°C ~ 60°C) or WiTAS 1 (-20°C ~ 70°C)

## System

Storage Temperature	-40°F ~ 176°F (-40°C ~ 80°C)
Operating Humidity	0% ~ 90% relative humidity, non-condensing
MTBF (Hours)	80,000
Certification	CE,FCC

## I/O

Storage/SSD	SATA 3.0Gb/s x 1, Mini-Card(Full size)/mSATA(default) x 1
Ethernet	Intel® Gigabit Ethernet, 10/100/1000Base-TX x 1 (Atom E series with I210IT, Celeron J/N series with I211AT)
USB Port	USB 3.0 x 1 Rear IO, USB 2.0 x 1 Rear IO and x 1 Pin header
Serial Port	RS-232 x 1, RS-232/422/485 x 1 (Ring /+5V/+12V)
Audio	Line-out x 1
DIO	4-bit (2-in, 2-out)
Expansion Slot	Mini-Card (Half-size) x 1, BIO x 1
SIM	Option by BIO Board
TPM	—
Touch	—



## Display

<b>Chipset</b>	Intel® E3845/J1900/N2807
<b>Resolution</b>	VGA up to 2048 x 1152 @60Hz or DP up to 2560 x 1400 @60Hz LVDS (18/24-bit) up to 1400 x 900 @60Hz
<b>LCD Interface</b>	18/24-bit Single LVDS

# Chapter 2

---

Hardware Information

## 2.1 Dimensions

### Component Side

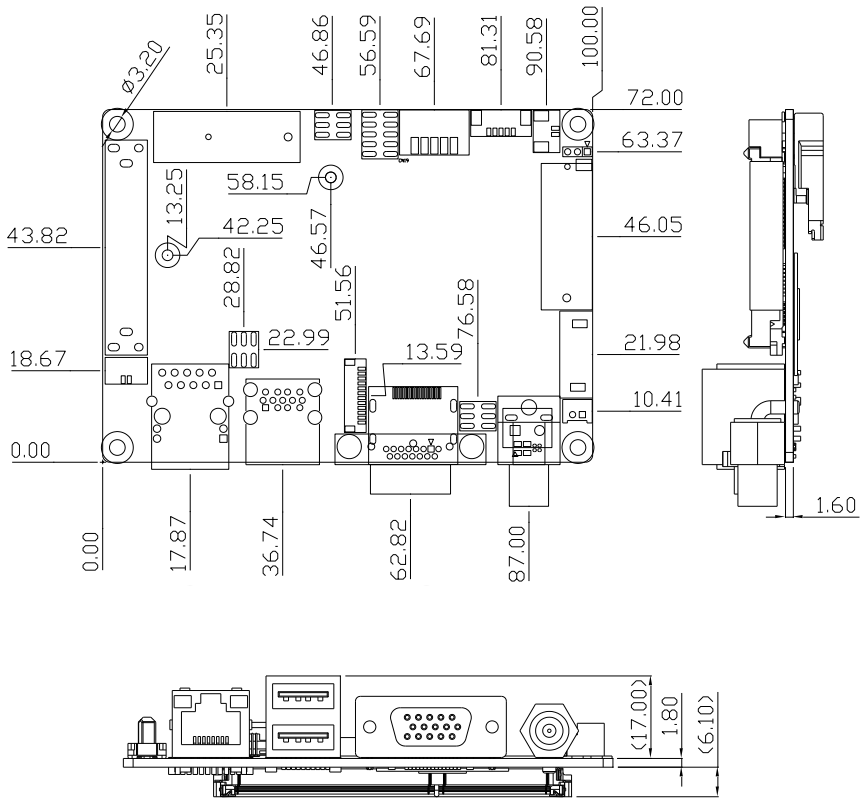

### Solder Side

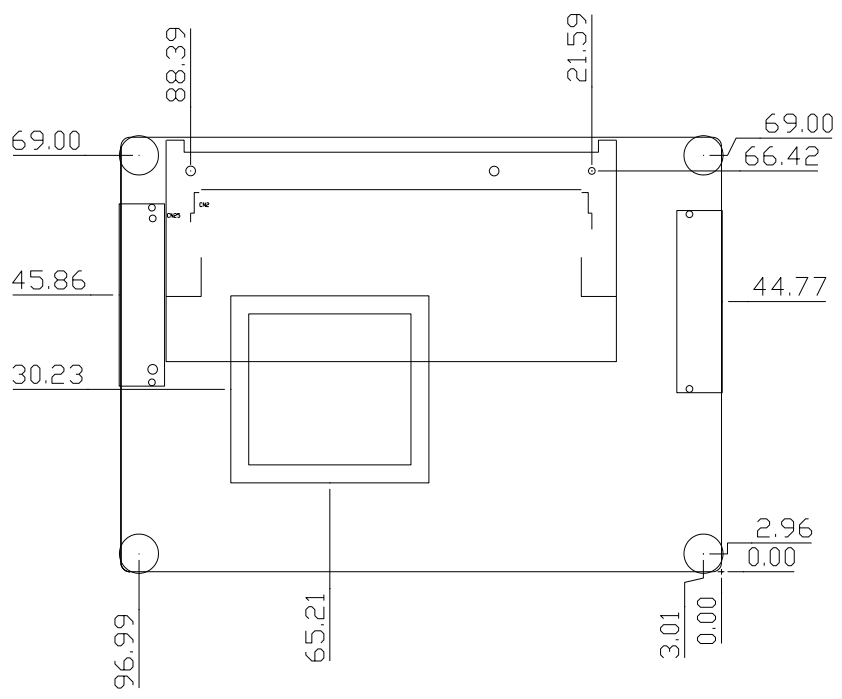

### Heat Spreader

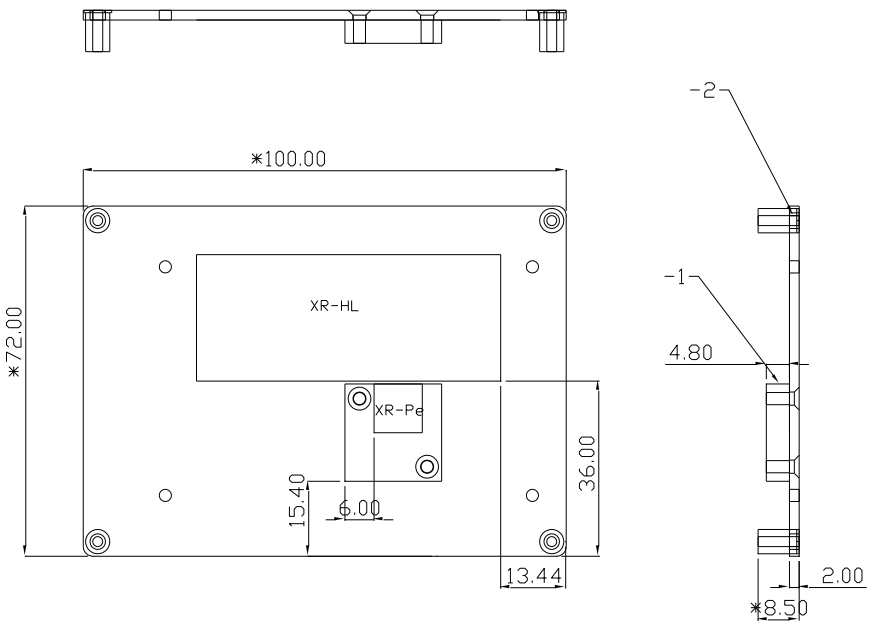

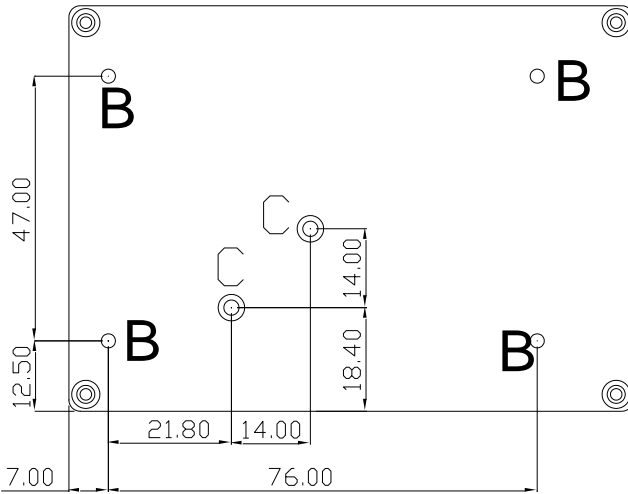
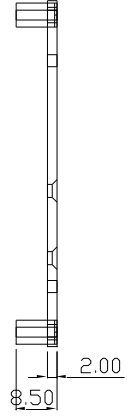
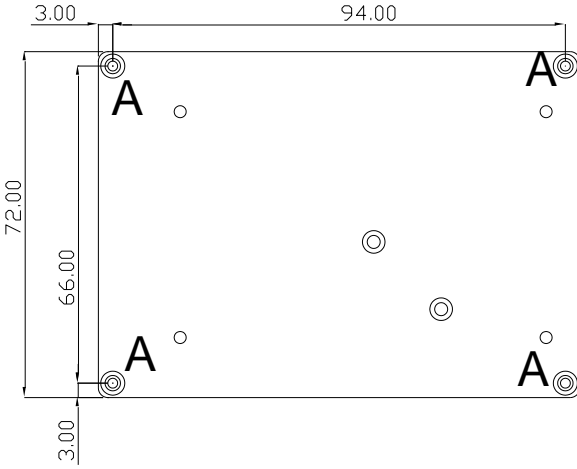

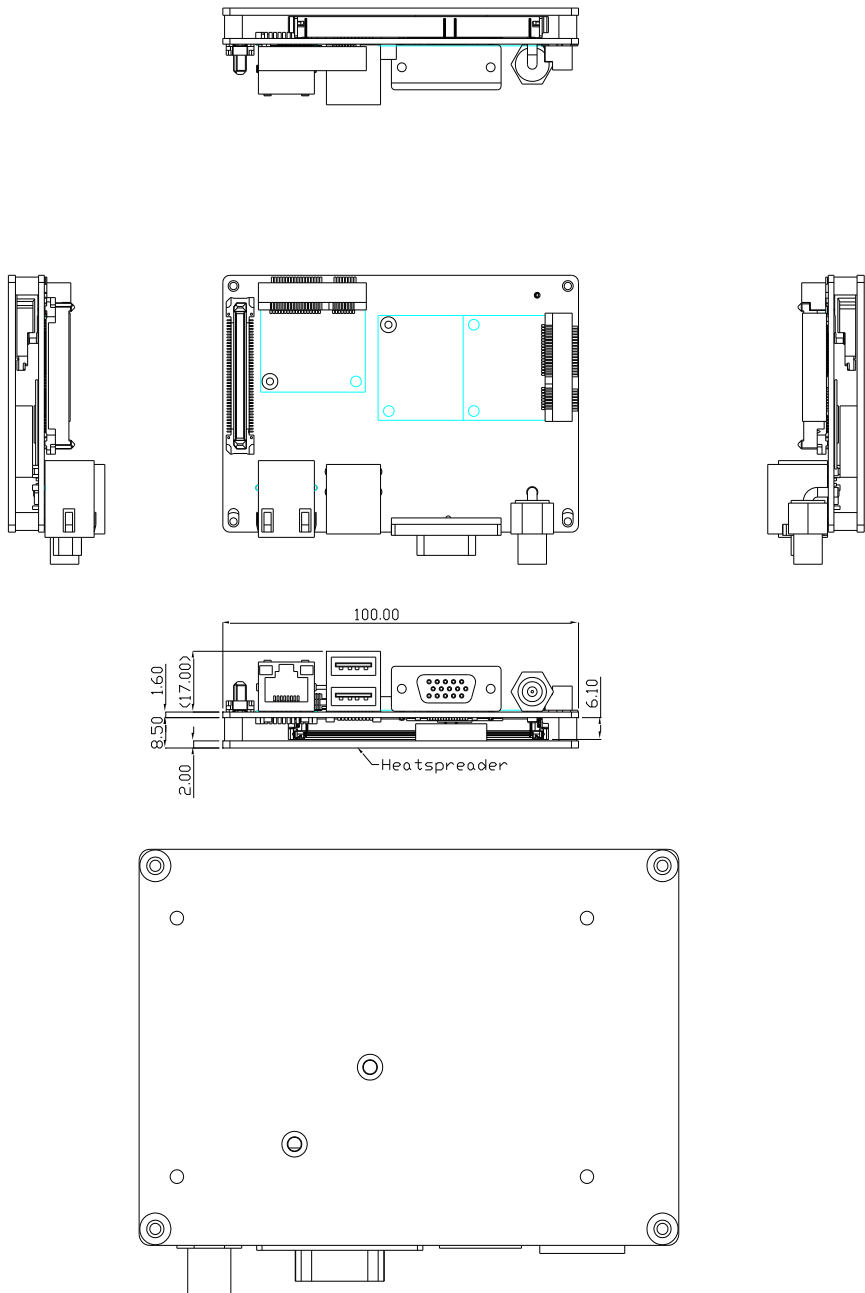

## 2.2 Jumpers and Connectors

### Component Side

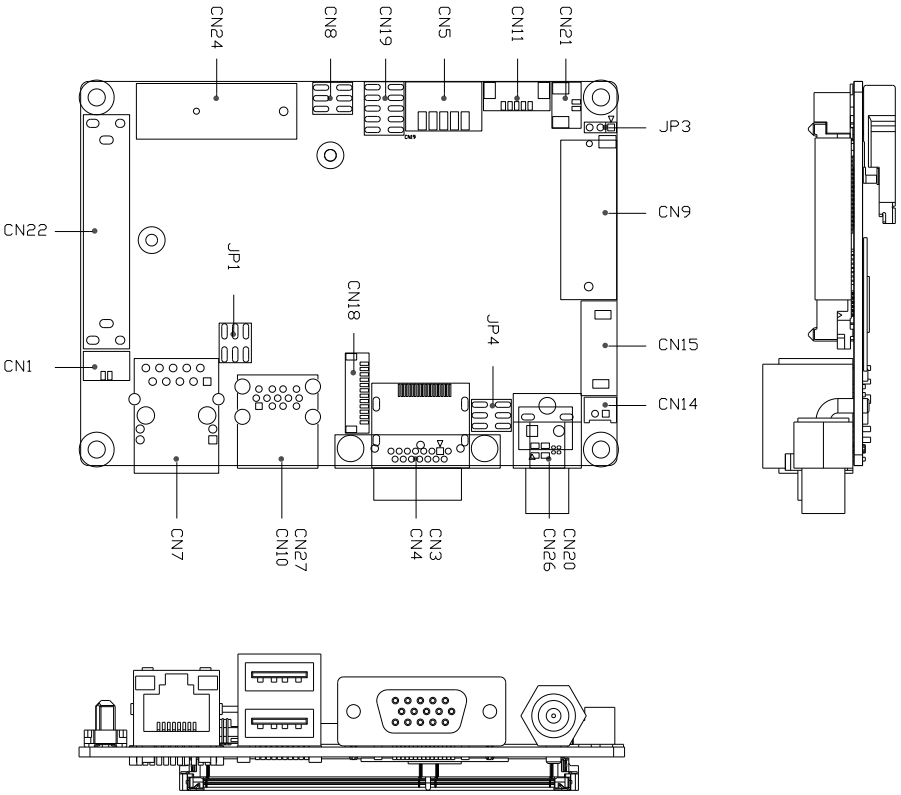



### Solder Side

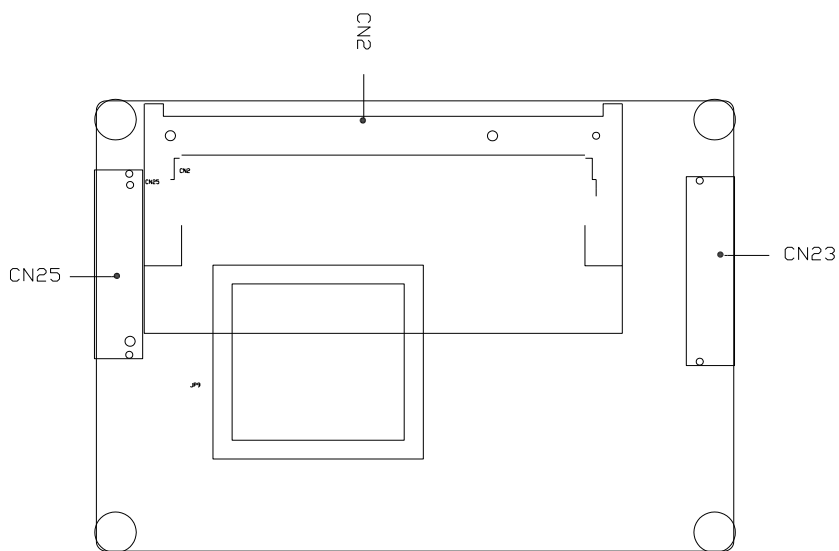

## 2.3 List of Jumpers

---

Please refer to the table below for all of the board's jumpers that you can configure for your application

Label	Function
JP1 (1,3,5)	Clear CMOS Jumper
JP1 (2,4,6)	Auto Power Button Enable/Disable Selection
JP3	LVDS Port Operating Voltage Selection
JP4 (1,3,5)	LVDS Port Backlight Inverter Voltage Selection
JP4 (2,4,6)	LVDS Port Backlight Lightness Control Mode Selection

### 2.3.1 Clear CMOS Jumper (JP1 1,3,5)

---

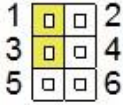

Normal (Default)

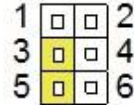

Clear CMOS

### 2.3.2 Auto Power Button Enable/Disable Selection (JP1 2,4,6)

---

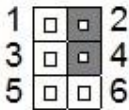

Enable (Default)

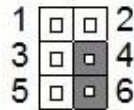

Disable

### 2.3.3 LVDS Port Operating Voltage Selection (JP3)

---

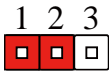

+5V

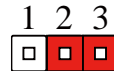

+3.3V (Default)

### 2.3.4 LVDS Port Backlight Inverter Voltage Selection (JP4 1,3,5)

---

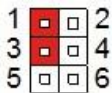

+12V

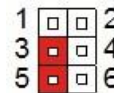

+5V (Default)

### 2.3.5 LVDS Port Backlight Lightness Control Mode Selection (JP4,2,4,6)

---

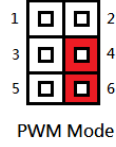
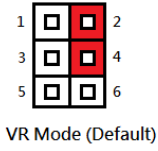

## 2.4 List of Connectors

Please refer to the table below for all of the board's connectors that you can configure for your application

Label	Function
CN1	Battery
CN2	DDR3L SO-DIMM Slot
CN3	VGA Port
CN4	DP port
CN5	LVDS Port Inverter / Backlight Connector
CN7	LAN (RJ-45) Port
CN8	Digital IO Port
CN9	MiniCard Slot (Full Size)/ Default mSATA (feature select by BOM)
CN10	USB Ports 0 and 1
CN11	USB 2.0 Port 2
CN14	+5V Output for SATA HDD
CN15	SATA Port
CN18	LPC Port
CN19	Front Panel
CN20	External +12V Input w/ lockable power-in connector (optional)
CN21	Buzzer connector
CN22	BIO connector
CN23	COM Port 1/2 & line out connector
CN24	Mini-Card Slot (Half-Mini Card)
CN25	LVDS Connector

### 2.4.1 Battery (CN1)

Pin	Pin Name	Signal Type	Signal Level
1	+3.3V	PWR	3.3V
2	GND	GND	

### 2.4.2 DDR3L SO-DIMM Slot (CN2)

Standard specification

### 2.4.3 VGA Port (CN3)

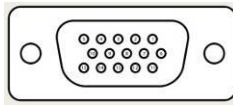

VGA			
Pin	Pin Name	Signal Type	Signal level
1	RED	OUT	
2	GREEN	OUT	
3	BLUE	OUT	
4	NC		
5	GND	GND	
6	RED_GND_RTN	GND	
7	GREEN_GND_RTN	GND	
8	BLUE_GND_RTN	GND	
9	+5V	PWR	+5V

## VGA

Pin	Pin Name	Signal Type	Signal level
10	GND	GND	
11	NC		
12	DDC_DATA	I/O	+5V
13	HSYNC	OUT	
14	VSYNC	OUT	
15	DDC_CLK	I/O	+5V

## 2.4.4 DP Port (CN4)

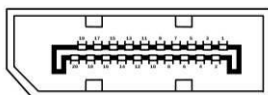

Pin	Pin Name	Signal Type	Signal level
1	DDIO_DP_D0_P	DIFF	
2	GND	GND	
3	DDIO_DP_D0_N	DIFF	
4	DDIO_DP_D1_P	DIFF	
5	GND	GND	
6	DDIO_DP_D1_N	DIFF	
7	DDIO_DP_D2_P	DIFF	
8	GND	GND	
9	DDIO_DP_D2_N	DIFF	

10	DDI0_DP_D3_P	DIFF	
11	GND	GND	
12	DDI0_DP_D3_N	DIFF	
13	GND		
14	GND		
15	DDI0_DP_AUX_P	I/O	+3.3V
16	GND		
17	DDI0_DP_AUX_N	I/O	+3.3V
18	HPLG_DETECT	IN	+1.8V
19	RTN_PWR		
20	PWR	IN	+3.3V

## 2.4.5 LVDS Port Inverter / Backlight Connector (CN5)

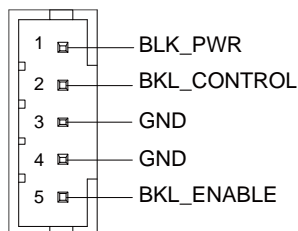

Pin	Pin Name	Signal Type	Signal Level
1	BKL_PWR	PWR	+5V / +12V
2	BKL_CONTROL	OUT	
3	GND	GND	



4	GND	GND	
5	BKL_ENABLE	OUT	+3.3V

\* LVDS2/BKL\_PWR can be set to +5V or +12V by JP4.

\* LVDS2/BKL\_CONTROL can be set by JP4.

\* The driving current supports up to 2A

## 2.4.6 LAN (RJ-45) Port (CN7)

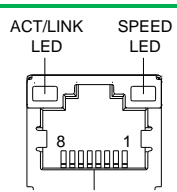

Pin	Pin Name	Signal Type	Signal Level
1	MDI0+	DIFF	
2	MDI0-	DIFF	
3	MDI1+	DIFF	
4	MDI2+	DIFF	
5	MDI2-	DIFF	
6	MDI1-	DIFF	
7	MDI3+	DIFF	
8	MDI3-	DIFF	

## 2.4.7 Digital IO Port (CN8)

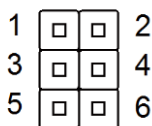

Pin	Pin Name	Signal Type	Signal Level
1	+5V	PWR	+5V
2	DIO0	I/O	+5V
3	DIO1	I/O	+5V
4	DIO2	I/O	+5V
5	DIO3	I/O	+5V
6	GND	GND	

## 2.4.8 MiniCard Slot (Full Size)/ Default mSATA (feature select by BOM) (CN9)

Pin	Pin Name	Signal Type	Signal level
1	PCIE_WAKE#	IN	
2	+3.3VSB/+3.3V	PWR	+3.3V
3	NC		
4	GND	GND	
5	NC		
6	+1.5V	PWR	+1.5V
7	PCIE_CLK_REQ#	IN	

Pin	Pin Name	Signal Type	Signal level
8	UIM_PWR	PWR	
9	GND	GND	
10	UIM_DATA	I/O	
11	PCIE_REF_CLK-	DIFF	
12	UIM_CLK	IN	
13	PCIE_REF_CLK+	DIFF	
14	UIM_RST	IN	
15	GND	GND	
16	UIM_VPP	PWR	
17	NC		
18	GND	GND	
19	NC		
20	W_DISABLE#	OUT	+3.3V
21	GND	GND	
22	PCIE_RST#	OUT	+3.3V
23	PCIE_RX-/mSATARX+	DIFF	
24	+3.3VSB/+3.3V	PWR	+3.3V
25	PCIE_RX+/mSATARX-	DIFF	
26	GND	GND	
27	GND	GND	
28	+1.5V	PWR	+1.5V

Pin	Pin Name	Signal Type	Signal level
29	GND	GND	
30	SMB_CLK	I/O	+3.3V
31	PCIE_TX-/mSATATX-	DIFF	
32	SMB_DATA	I/O	+3.3V
33	PCIE_TX+/mSATATX+	DIFF	
34	GND	GND	
35	GND	GND	
36	USB_D-	DIFF	
37	GND	GND	
38	USB_D+	DIFF	
39	+3.3VSB/+3.3V	PWR	+3.3V
40	GND	GND	
41	+3.3VSB/+3.3V	PWR	+3.3V
42	NC		
43	GND	GND	
44	NC		
45	NC		
46	NC		
47	NC		
48	+1.5V	PWR	+1.5V
49	NC		

Pin	Pin Name	Signal Type	Signal level
50	GND	GND	
51	NC		
52	+3.3VSB/+3.3V	PWR	+3.3V

### 2.4.9 USB Ports 0 and 1 (CN10)

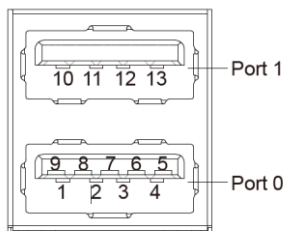

Pin	Pin Name	Signal Type	Signal level
1	+5VSB	PWR	+5V
2	USB0_D-	DIFF	
3	USB0_D+	DIFF	
4	GND	GND	
5	USB0_SSRX-	DIFF	
6	USB0_SSRX+	DIFF	
7	GND	GND	
8	USB0_SSTX-	DIFF	
9	USB0_SSTX+	DIFF	
10	+5VSB	PWR	+5V

Pin	Pin Name	Signal Type	Signal level
11	USB1_D-	DIFF	
12	USB1_D+	DIFF	
13	GND	GND	

\* Only Port 0 supports USB 3.0.

## 2.4.10 USB 2.0 Port 2 (CN11)

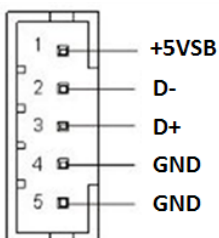

Pin	Pin Name	Signal Type	Signal Level
1	+5VSB	PWR	+5V
2	USB2_D-	DIFF	
3	USB2_D+	DIFF	
4	GND	GND	
5	GND	GND	

### 2.4.11 +5V Output for SATA HDD (CN14)

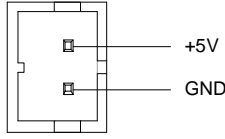

Pin	Pin Name	Signal Type	Signal Level
1	+5V	PWR	+5V
	GND	GND	

### 2.4.12 SATA Port (CN15)

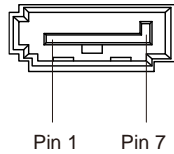

Pin	Pin Name	Signal Type	Signal Level
1	GND	GND	
2	SATA_TX1+	DIFF	
3	SATA_TX1-	DIFF	
4	GND	GND	
5	SATA_RX1-	DIFF	
6	SATA_RX1+	DIFF	
7	GND	GND	

## 2.4.13LPC Port (CN18)

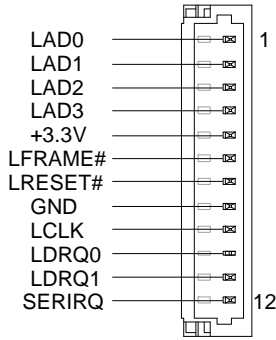

Pin	Pin Name	Signal Type	Signal Level
1	LAD0	I/O	+3.3V
2	LAD1	I/O	+3.3V
3	LAD2	I/O	+3.3V
4	LAD3	I/O	+3.3V
5	+3.3V	PWR	+3.3V
6	LFRAME#	IN	
7	LRESET#	OUT	+3.3V
8	GND	GND	
9	LCLK	OUT	
10	SMB_DATA [Default] / I2C_DATA	I/O	
11	SMB_CLK [Default] / I2C_CLK	IN	
12	SMB_ALERT [Default] / INT_SERIRQ	I/O	+3.3V



## 2.4.14 Front Panel (CN19)

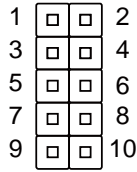

Pin	Pin Name	Pin	Pin Name
1	PWR_BTN-	2	PWR_BTN+
3	HDD_LED-	4	HDD_LED+
5	SPEAKER-	6	SPEAKER+
7	PWR_LED-	8	PWR_LED+
9	H/W RESET-	10	H/W RESET+

## 2.4.15 External +12V Input (CN20)

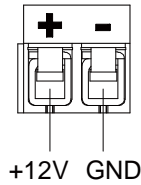

Pin	Pin Name	Signal Type	Signal Level
1	+12V	PWR	+12V
2	GND	GND	

## 2.4.16 Buzzer Connector (CN21)

Pin	Pin Name	Signal Type	Signal Level
1	+3.3V	PWR	3.3V
2	SPEAKER-		

## 2.4.17 BIO Connector (CN22)

Pin	Pin Name	Pin	Pin Name
1	+12VSB	2	GND
3	GND	4	PCIE_TXN0
5	PCIE_RXN0	6	PCIE_TXP0
7	PCIE_RXP0	8	GND
9	GND	10	NC
11	NC	12	NC
13	NC	14	GND
15	GND	16	PS_ON#
17	NC	18	NC
19	+5VSB	20	+5VSB
21	+5VSB	22	+5VSB
23	PCIE_REF_CLK0	24	RESET#
25	PCIE_REF_CLK0#	26	GND
27	GND	28	NC
29	NC	30	NC
31	NC	32	GND
33	GND	34	NC

Pin	Pin Name	Pin	Pin Name
35	NC	36	NC
37	NC	38	GND
39	GND	40	NC
41	NC	42	GND
43	NC	44	NC
45	GND	46	NC
47	USBN0	48	GND
49	USBP0	50	USBN1
51	GND	52	USBP2
53	I2C_CLK or SMB_CLK [Default]	54	GND
55	I2C_DATA or SMB_DATA [Default]	56	WAKE#
57	GND	58	USB_OC0#
59	+5V	60	USB_OC1#
61	+5V	62	+5V
63	+5V	64	+5V
65	LPC_AD0	66	LPC_FRAME#
67	LPC_AD1	68	SERIRQ
69	LPC_AD2	70	LPC_DRQ
71	LPC_AD3	72	PWR_OK/GPIO
73	GND	74	AGND
75	LPC_CLK	76	AUD_LINEOUT_L
77	PME#	78	AUD_LINEOUT_R
79	GND	80	GND

## 2.4.18COM Port 1/2 & Line Out Connector (CN23)

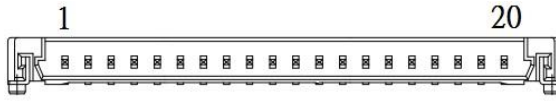

Pin	Pin Name	Signal Type	Signal Level
1	DCDB	IN	
2	DSRB	IN	
3	RXB	IN	
4	RTSB	OUT	±9V
5	TXB	OUT	±9V
6	CTSB	IN	
7	DTRB	OUT	±9V
8	RIB/+5V/+12V	IN/ PWR	+5V/+12V
9	DCDA	IN	
10	DSRA	IN	
11	RXA	IN	
12	RTSA	OUT	±9V
13	TXA	OUT	±9V
14	CTSA	IN	
15	DTRA	OUT	±9V
16	RIA	IN	

17	GND	GND
18	AGND	GND
19	LOUT_R	I/O
20	LOUT_L	I/O

## COM Port 2 RS-485

Pin	Pin Name	Signal Type	Signal level
1	RS485_D-	I/O	±5V
2	NC		
3	RS485_D+	I/O	±5V
4	NC		
5	NC		
6	NC		
7	NC		
8	NC/+5V/+12V	PWR	+5V/+12V
17	GND	IN	

## COM Port 2 RS-422

Pin	Pin Name	Signal Type	Signal level
1	RS422_TX-	OUT	±5V
2	NC		
3	RS422_TX+	OUT	±5V
4	NC		

Pin	Pin Name	Signal Type	Signal level
5	RS422_RX+	IN	
6	NC		
7	RS422_RX-	IN	
8	NC/+5V/+12V	PWR	+5V/+12V
17	GND	GND	

\* COM2 RS-232/422/485 can be set by BIOS setting. Default is RS-232.

\* COM2 RI/+5V/+12V function can be set by BOM(R524-RI/R521-/+12V/R526-/+5V)

#### 2.4.19 MiniCard Slot (Half-Mini Card) (CN24)

Pin	Pin Name	Signal Type	Signal Level
1	PCIE_WAKE#	IN	
2	+3.3VSB	PWR	+3.3V
3	NC		
4	GND	GND	
5	NC		
6	+1.5V	PWR	+1.5V
7	PCIE_CLK_REQ#	IN	
8	NC	PWR	
9	GND	GND	

Pin	Pin Name	Signal Type	Signal Level
10	NC	I/O	
11	PCIE_REF_CLK-	DIFF	
12	NC	IN	
13	PCIE_REF_CLK+	DIFF	
14	NC		
15	GND	GND	
16	NC	PWR	
17	NC		
18	GND	GND	
19	NC		
20	W_DISABLE#	OUT	+3.3V
21	GND	GND	
22	PCIE_RST#	OUT	+3.3V
23	PCIE_RX-	DIFF	
24	+3.3VSB	PWR	+3.3V
25	PCIE_RX+	DIFF	
26	GND	GND	
27	GND	GND	
28	+1.5V	PWR	+1.5V
29	GND	GND	

Pin	Pin Name	Signal Type	Signal Level
30	SMB_CLK	I/O	+3.3V
31	PCIE_TX-	DIFF	
32	SMB_DATA	I/O	+3.3V
33	PCIE_TX+	DIFF	
34	GND	GND	
35	GND	GND	
36	USB_D-	DIFF	
37	GND	GND	
38	USB_D+	DIFF	
39	+3.3VSB	PWR	+3.3V
40	GND	GND	
41	+3.3VSB	PWR	+3.3V
42	NC		
43	GND	GND	
44	NC		
45	NC		
46	NC		
47	NC		
48	+1.5V	PWR	+1.5V
49	NC		



Pin	Pin Name	Signal Type	Signal Level
50	GND	GND	
51	NC		
52	+3.3VSB	PWR	+3.3V

#### 2.4.20 LVDS Port (CN25)

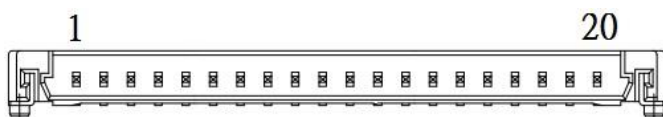

Pin	Pin Name	Signal Type	Signal Level
1	BKL_ENABLE	OUT	
2	BKL_CONTROL	OUT	
3	LCD_PWR	PWR	+3.3V/+5V
4	LVDS_A_CLK-	DIFF	
5	LVDS_A_CLK+	DIFF	
6	LCD_PWR	PWR	+3.3V/+5V
7	LVDS_DA0+	DIFF	
8	LVDS_DA0-	DIFF	
9	LCD_PWR	PWR	+3.3V/+5V
10	LVDS_DA1+	DIFF	

11	LVDS_DA1-	DIFF
12	GND	GND
13	LVDS_DA2+	DIFF
14	LVDS_DA2-	DIFF
15	GND	GND
16	LVDS_DA3+	DIFF
17	LVDS_DA3-	DIFF
18	GND	GND
19	DDC_DATA	I/O
20	DDC_CLK	I/O

# Chapter 3

---

AMI BIOS Setup

## 3.1 System Test and Initialization

---

The board uses certain routines to perform testing and initialization. If an error, fatal or non-fatal, is encountered, a few short beeps or an error message will be outputted. The board can usually continue the boot up sequence with non-fatal errors.

The system configuration verification routines check the current system configuration against the values stored in the CMOS memory. If they do not match, an error message will be outputted, in which case you will need to run the BIOS setup program to set the configuration information in memory.

There are three situations in which you will need to change the CMOS settings:

- You are starting your system for the first time
- You have changed your system's hardware
- The CMOS memory has lost power and the configuration information is erased

The system's CMOS memory uses a backup battery for data retention, which is to be replaced once emptied.

## 3.2 AMI BIOS Setup

---

The AMI BIOS ROM has a pre-installed Setup program that allows users to modify basic system configurations, which is stored in the battery-backed CMOS RAM and BIOS NVRAM so that the information is retained when the power is turned off.

To enter BIOS Setup, press <Del> or <F2> immediately while your computer is powering up.

The function for each interface can be found below.

**Main** – Date and time can be set here. Press <Tab> to switch between date elements

**Advanced** – Enable/ Disable boot option for legacy network devices

**Chipset** – For hosting bridge parameters

**Boot** – Enable/ Disable quiet Boot Option

**Security** – The setup administrator password can be set here

**Save & Exit** – Save your changes and exit the program

### 3.3 Setup Submenu: Main

Press "Delete" to enter Setup

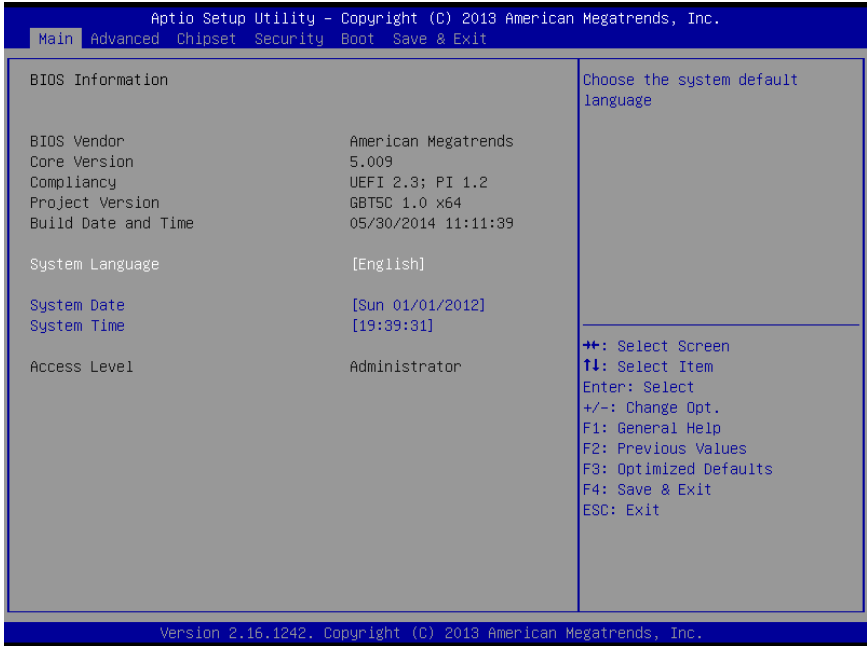

### 3.4 Setup Submenu: Advanced

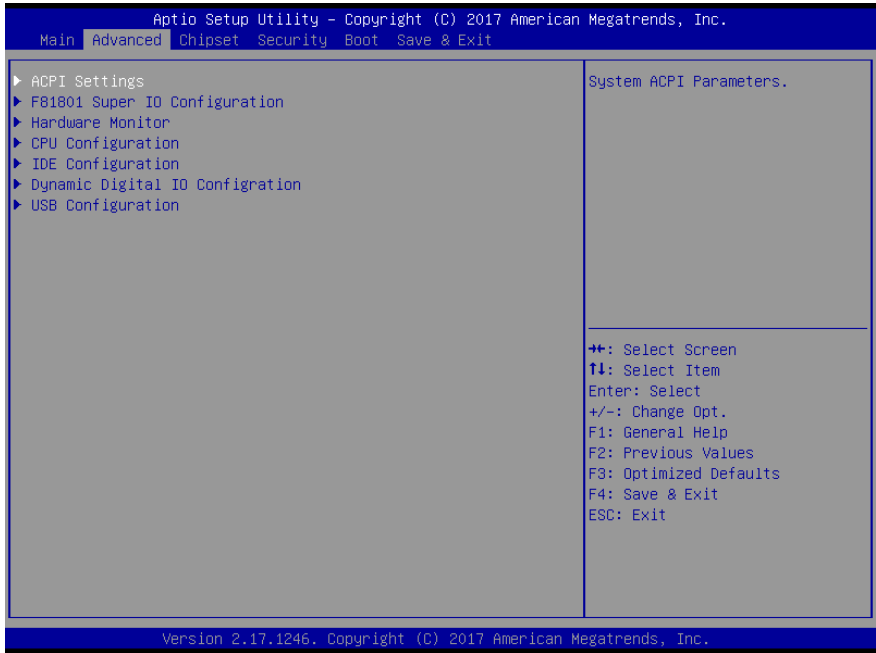

### 3.4.1 Advanced: ACPI Settings

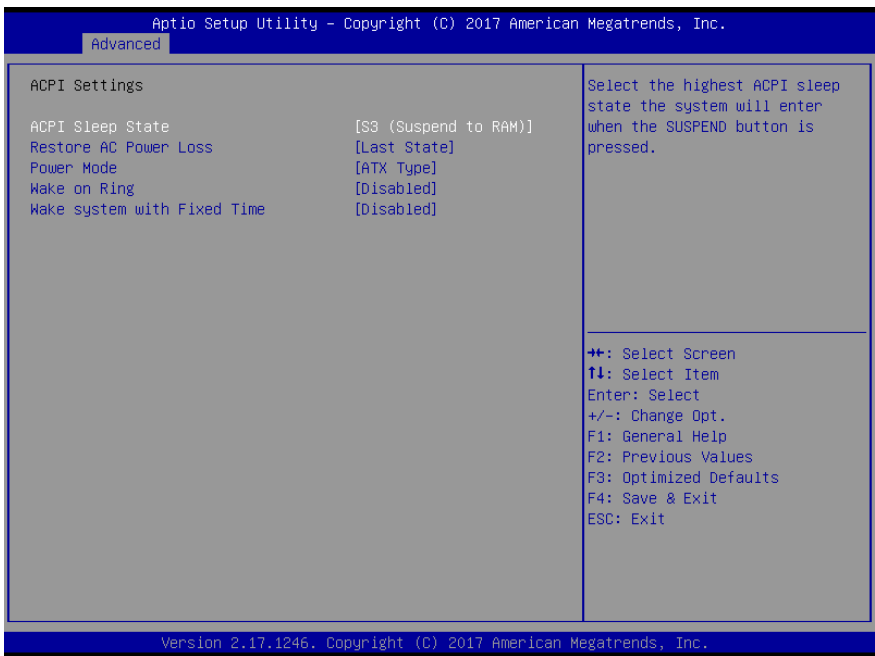

Options summary:

ACPI Sleep State	Suspend Disabled	Optimal Default, Failsafe Default
	S3 (suspend to RAM)	
Select the highest ACPI sleep state the system will enter when the SUSPEND button is pressed.		
Restore on Power Loss	Power Off	Optimal Default, Failsafe Default
	Power On	
	Last State	
Select power state when power is re-applied after a power failure.		
Power Mode	ATX Type	Optimal Default, Failsafe Default
	AT Type	
Select power supply mode.		



Wake on Ring	Disabled	Optimal Default, Failsafe Default
	Enabled	
Enable or disable System Wake on Ring		
RTC wake system from S5	Disabled	Optimal Default, Failsafe Default
	Fixed Time	
Enable or disable System wake on alarm event. When enabled, System will wake on the hr::min::sec specified		

### 3.4.2 Advanced: F81801 Super IO Configuration

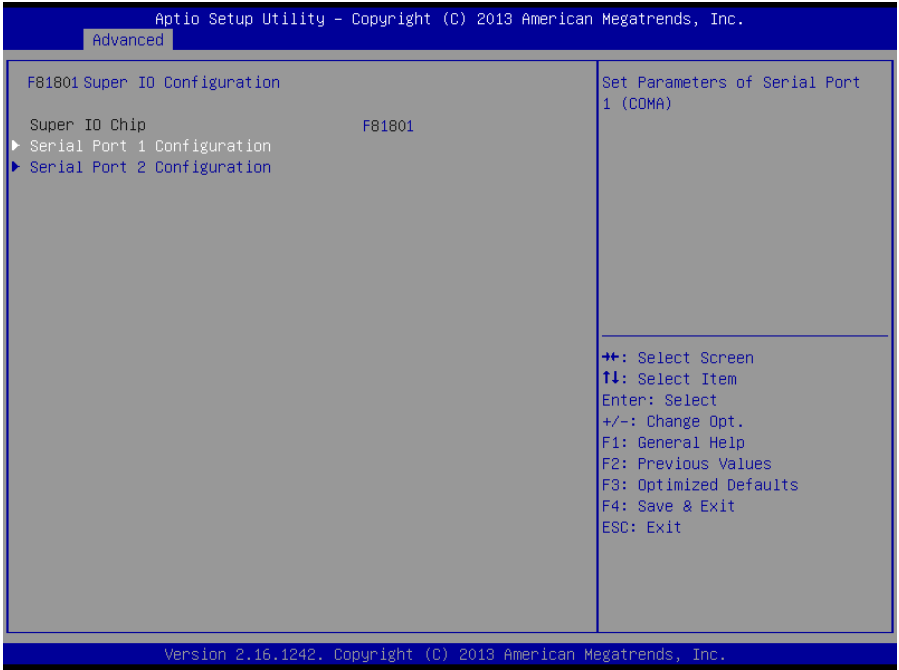

### 3.4.2.1 Super IO Configuration: Serial Port 1 Configuration

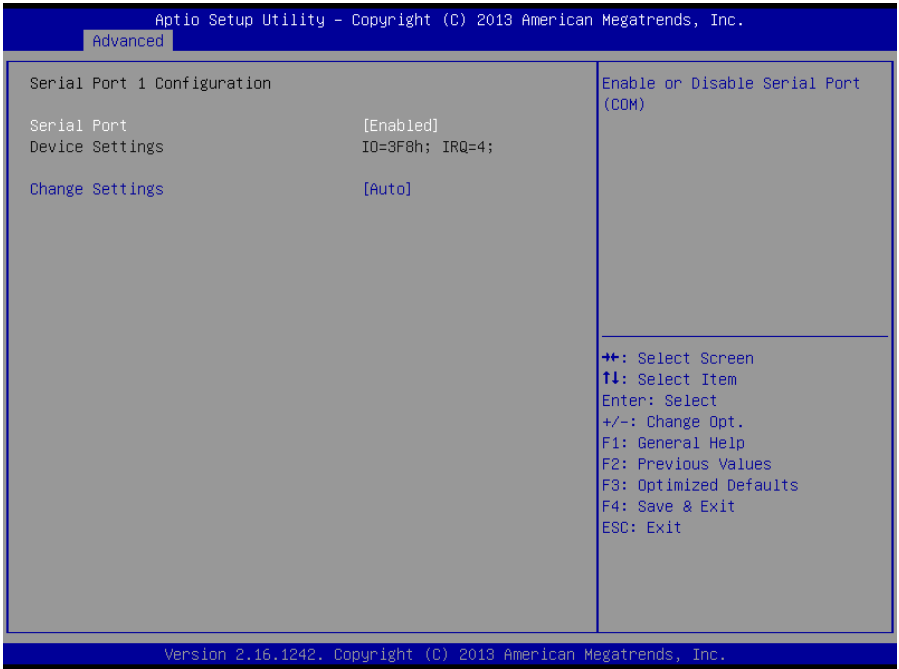

### 3.4.2.2 Super IO Configuration: Serial Port 2 Configuration

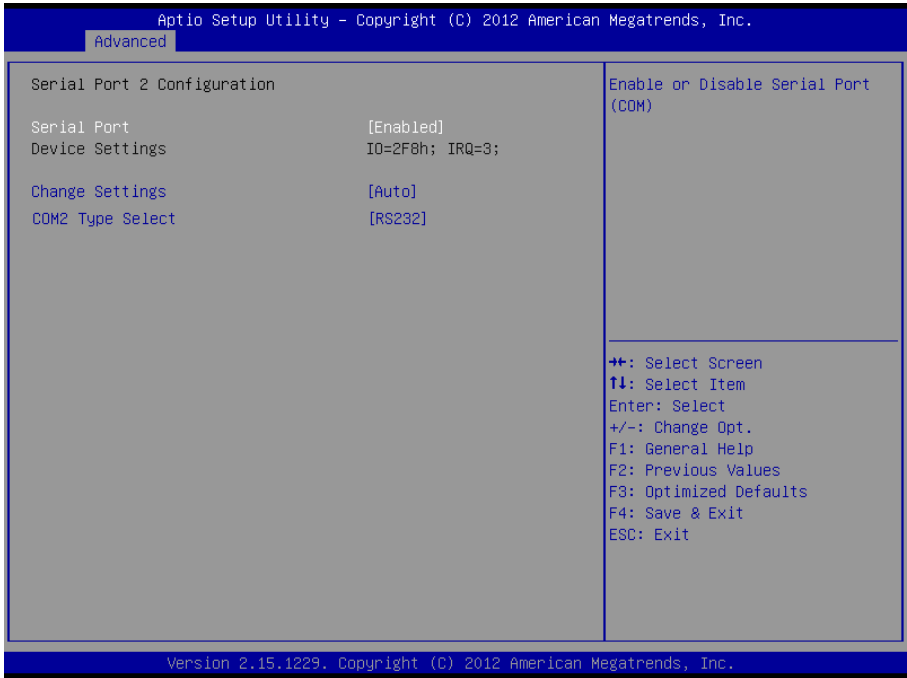

Options summary:

Serial Port	Disabled	
	Enabled	Default
Allows BIOS to En/Disable correspond serial port.		
Change Settings (Serial Port 1)	Auto	Default
	IO=3F8h; IRQ=4;	
	IO=3F8h; IRQ=3,4,5,6,7,9,10,11,12;	
	IO=2F8h; IRQ=3,4,5,6,7,9,10,11,12;	
	IO=2F8h; IRQ=3,4,5,6,7,9,10,11,12;	

	IO=3E8h; IRQ=3,4,5,6,7,9,10,11,12;		
	IO=2E8h; IRQ=3,4,5,6,7,9,10,11,12;		
Allows BIOS to Select Serial Port resource.			
Change Settings (Serial Port 2)	Auto IO=2F8h; IRQ=3; IO=3F8h; IRQ=3,4,5,6,7,9,10,11,12;	Default	
	IO=2F8h; IRQ=3,4,5,6,7,9,10,11,12;		
	IO=3E8h; IRQ=3,4,5,6,7,9,10,11,12;		
	IO=2E8h; IRQ=3,4,5,6,7,9,10,11,12;		
COM2 Type Select	RS232		Default
	RS422		
	RS485		
Select Working model			

### 3.4.3 Advanced: Hardware Monitor

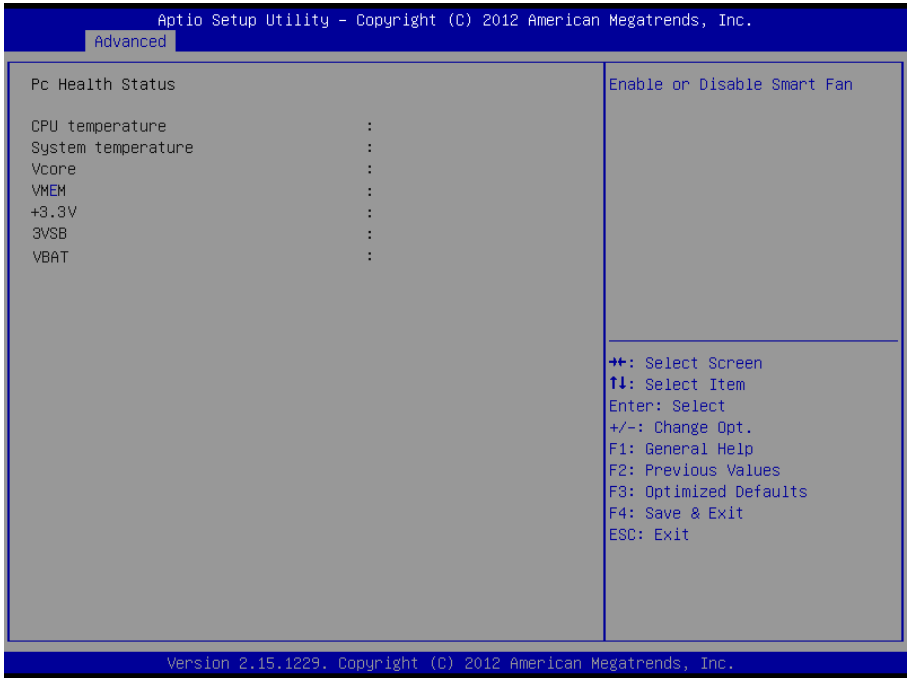

### 3.4.4 Advanced: CPU Configuration

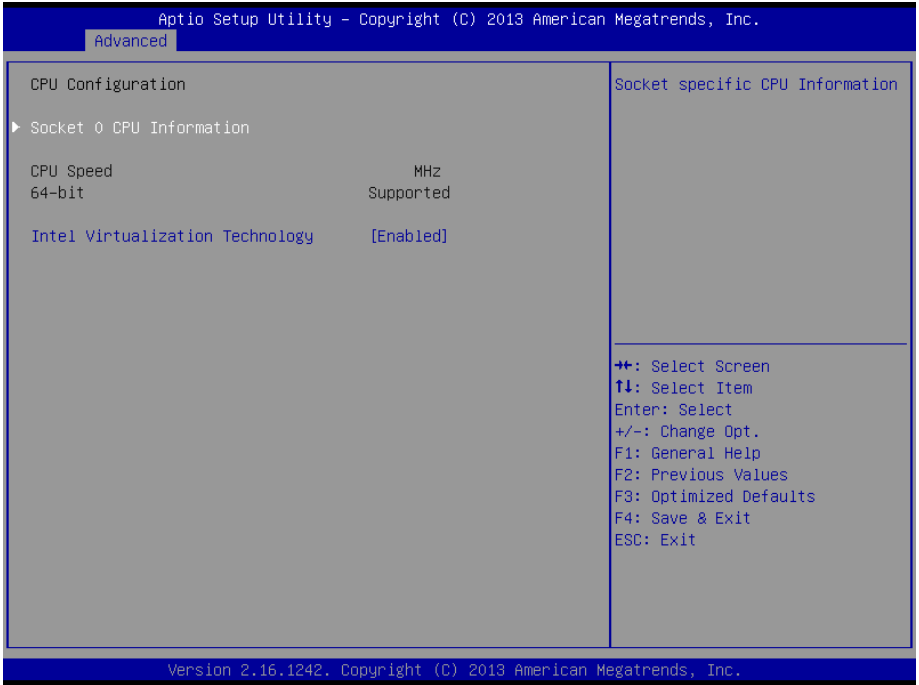

Options summary:

Intel Virtualization	Disabled	Optimal Default, Failsafe Default
Technology	Enabled	
When enabled, a VMM can utilize the additional hardware capabilities provided by Vander pool Technology		

### 3.4.4.1 CPU Configuration: Socket 0 CPU Information

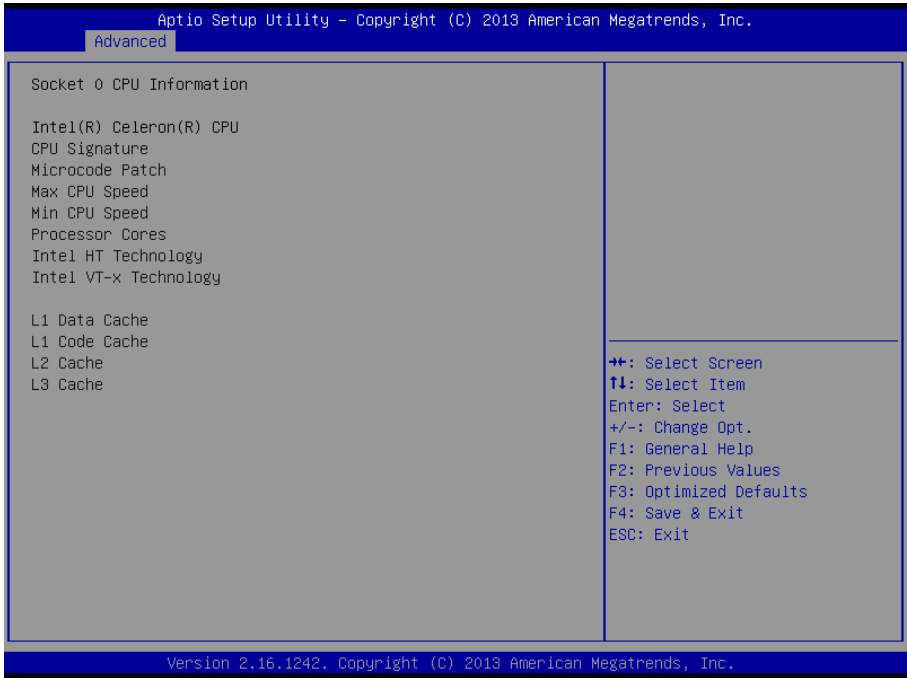



### 3.4.5 Advanced: SATA Configuration

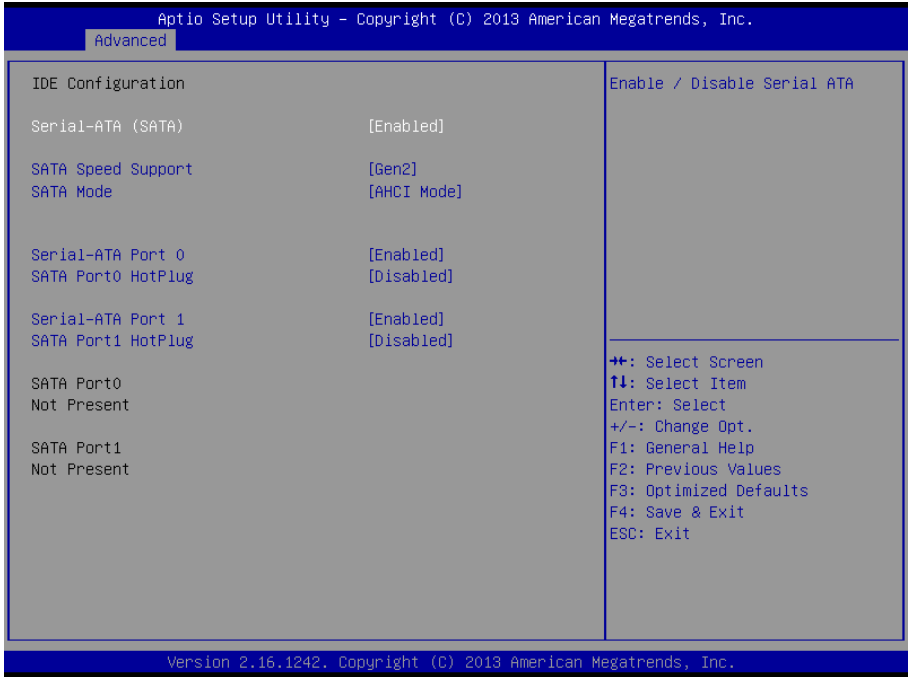

Options summary:

Serial-ATA (SATA)	Enabled	Default
	Disabled	
En/Disable SATA		
SATA Speed Support	Gen1	Default
	Gen2	
SATA Speed Support Gen1 or Gen2		
SATA Mode	IDE	Default
	AHCI	
IDE: Configure SATA controllers as legacy IDE		
AHCI: Configure SATA controllers to operate in AHCI mode		

Serial-ATA Port x	Enabled	Default
	Disabled	
En/Disable SATA Port		
SATA Port1 HotPlug	Enabled	
	Disabled	Default
En/Disable SATA Port Hotplug		

### 3.4.6 Advanced: Dynamic Digital IO Configuration

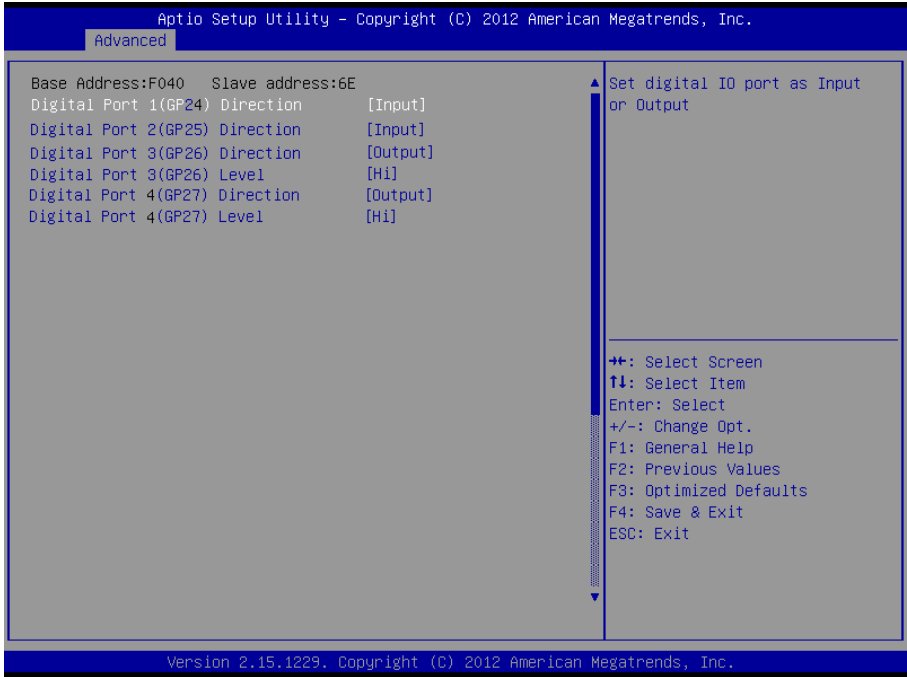

Digital Port X Direction	Input	
	Output	
Set DIO as input or Output		
Digital Port X Level	Hi	Default
	Low	
Set DIO Output port Hi or Low		

### 3.4.7 Advanced: USB Configuration

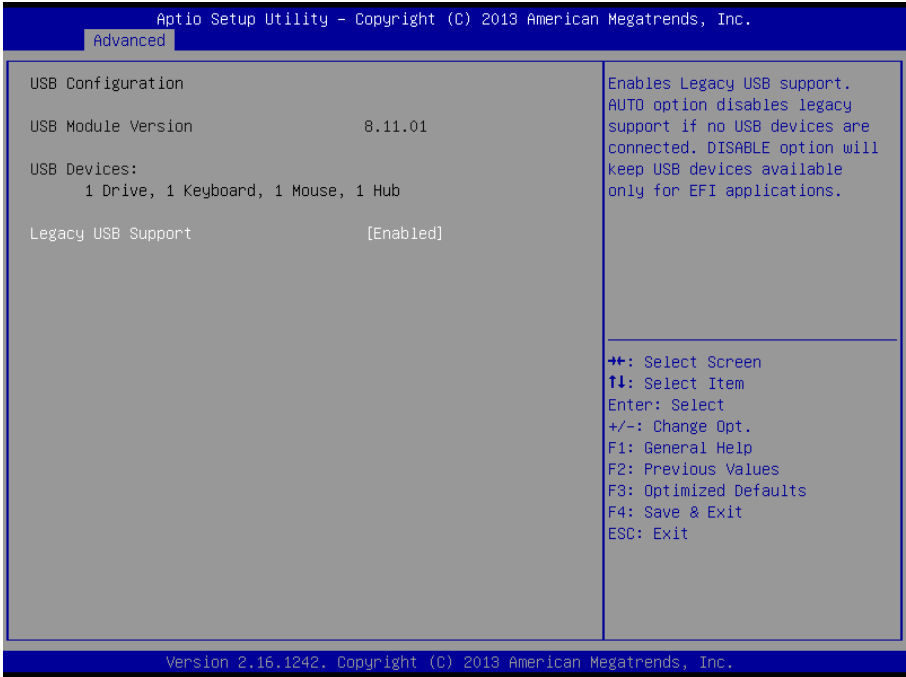

Options summary:

Legacy USB Support	Enabled	Optimal Default, Failsafe Default
	Disabled	
	Auto	
Enables BIOS Support for Legacy USB Support. When enabled, USB can be functional in legacy environment like DOS.		
AUTO option disables legacy support if no USB devices are connected		
Device Name (Emulation Type)	Auto	Optimal Default, Failsafe Default
	Floppy	
	Forced FDD	
	Hard Disk	

	CDROM
If Auto. USB devices less than 530MB will be emulated as Floppy and remaining as Floppy and remaining as hard drive. Forced FDD option can be used to force a HDD formatted drive to boot as FDD(Ex. ZIP drive)	

### 3.5 Setup submenu: Chipset

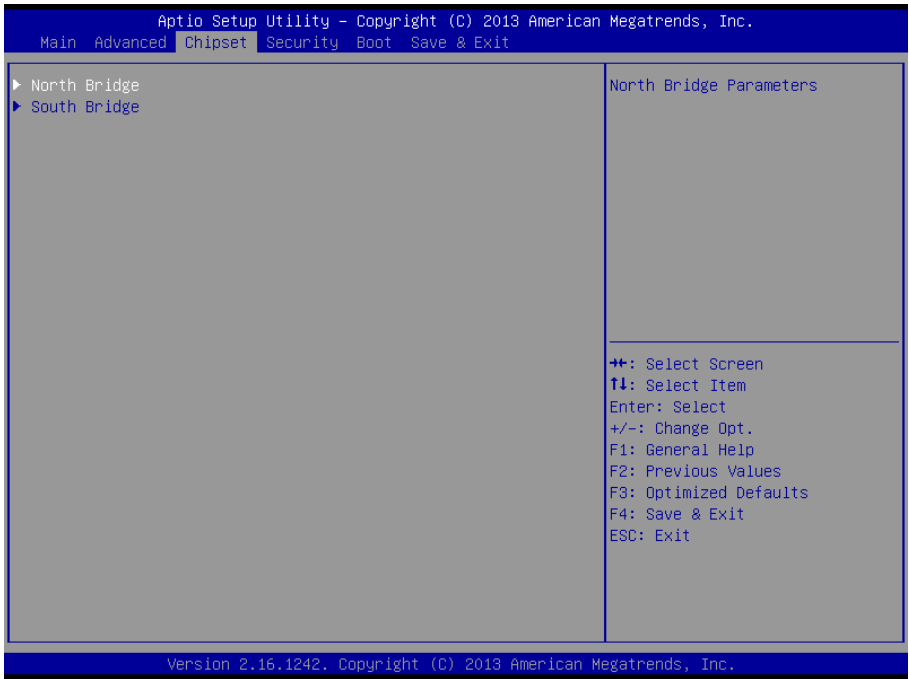

### 3.5.1 Chipset: North Bridge

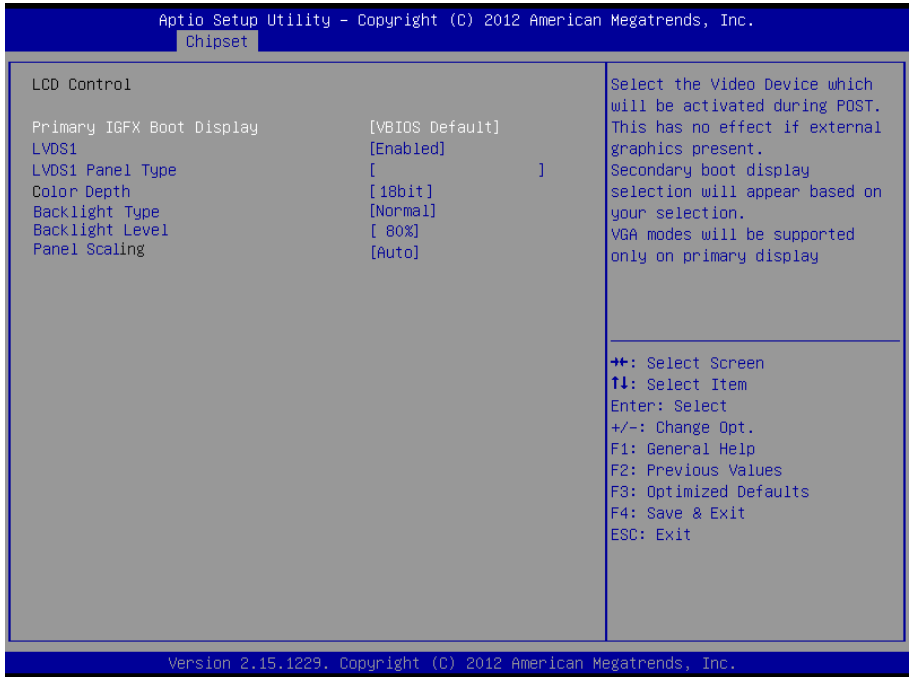

Options summary:

Primary IGFX Boot Display	VBIOS Default	Optimal Default, Failsafe Default
	CRT	
	DP	
	LVDS	
Select the Video device		
LVDS1	Disabled	Optimal Default, Failsafe Default
	Enabled	
En/Dis LVDS		
Panel Type	640x480	
	800x480	

	800x600	
	1024x600	
	1024x768	Optimal Default, Failsafe Default
	1280x768	
	1366x768	
	1440x900	
Select panel type		
Color Depth	18Bit	Optimal Default, Failsafe Default
	24Bit	
Set color depth		
Backlight Type	Normal	Optimal Default, Failsafe Default
	Inverted	
Select backlight control signal type		
Backlight Level	0-100%	
Select backlight control level		
Panel Scaling	Auto	Optimal Default, Failsafe Default
	Off	
	Force Scaling	
Select the LCD scaling option used by the internal graphics device.		



### 3.5.2 Chipset: South Bridge

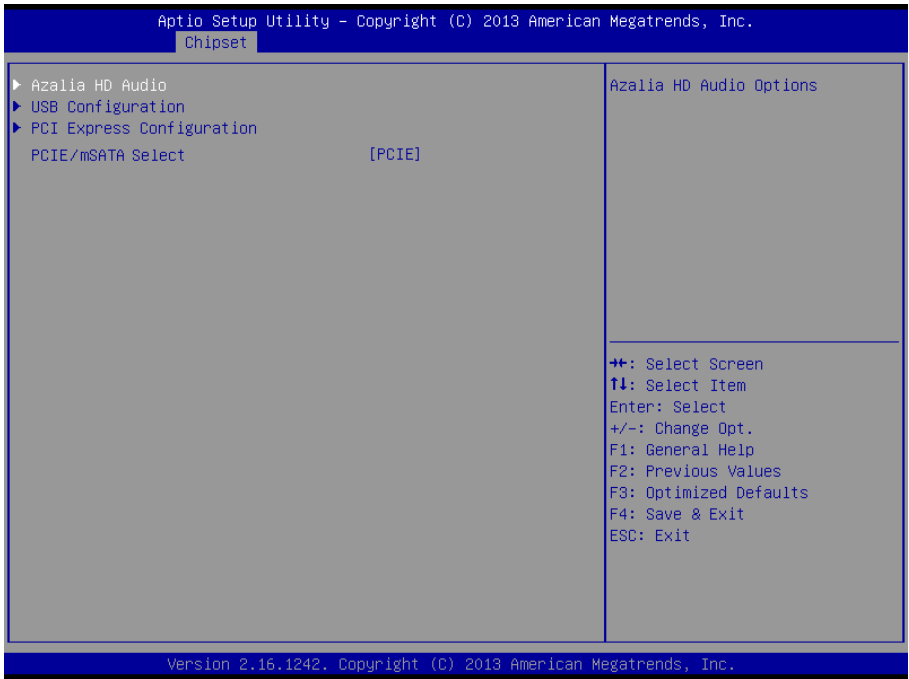

Options summary\*:

PCIE/mSATA Select	PCIE	Optimal Default, Failsafe Default
	mSATA	
PCIE/mSATA Select		

\* PCIE/mSATA Select is available only for A1.0 version and not available for A1.1 and / or later version.

### 3.5.2.1 South Bridge: Azalia HD Audio

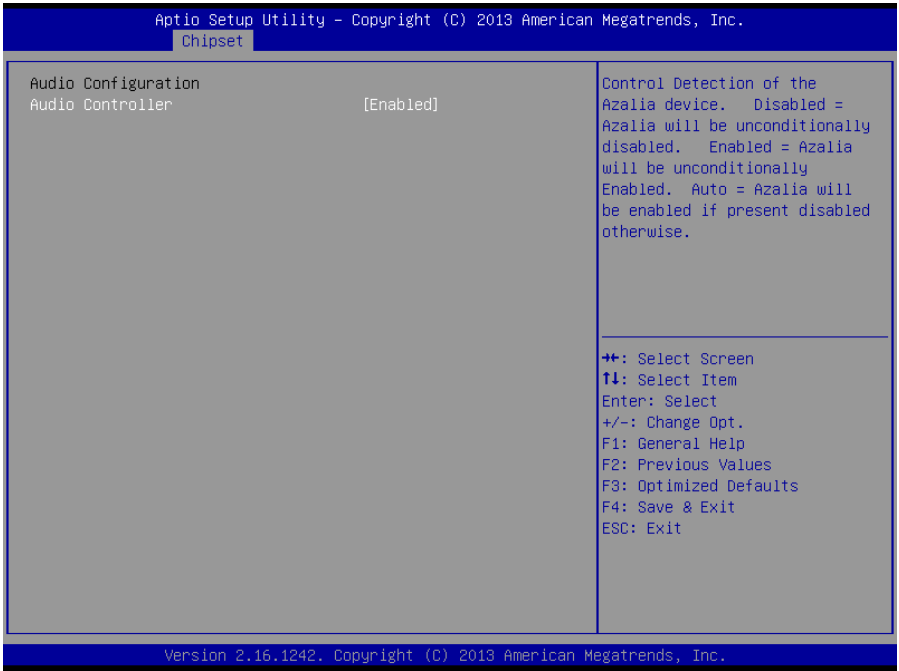

Azalia HD Audio	Disabled	Optimal Default, Failsafe Default
	Enabled	
Enabling/Disabling HD Audio controller.		

### 3.5.2.2 South Bridge: USB Configuration

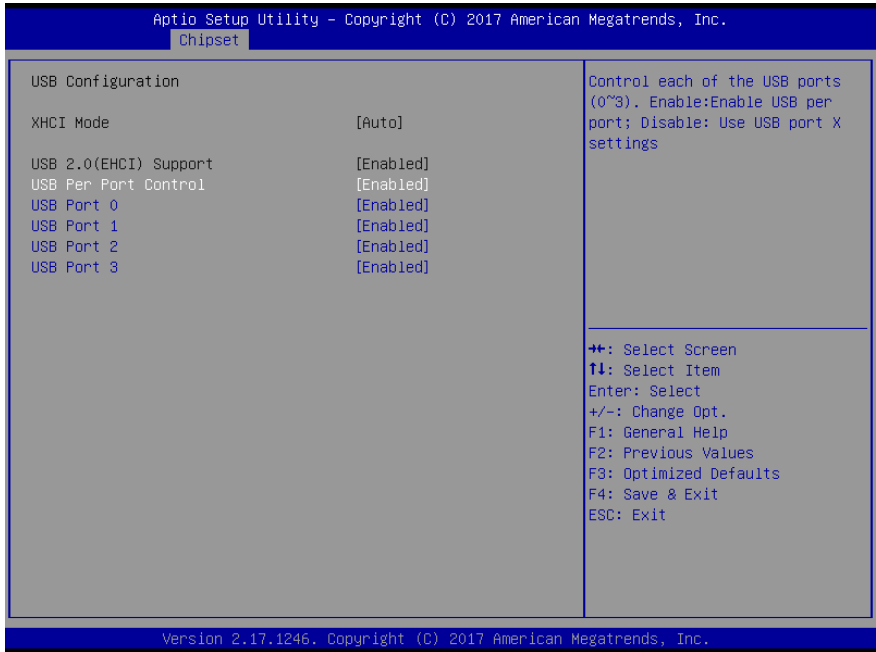

### 3.5.2.3 South Bridge: PCI Express Configuration

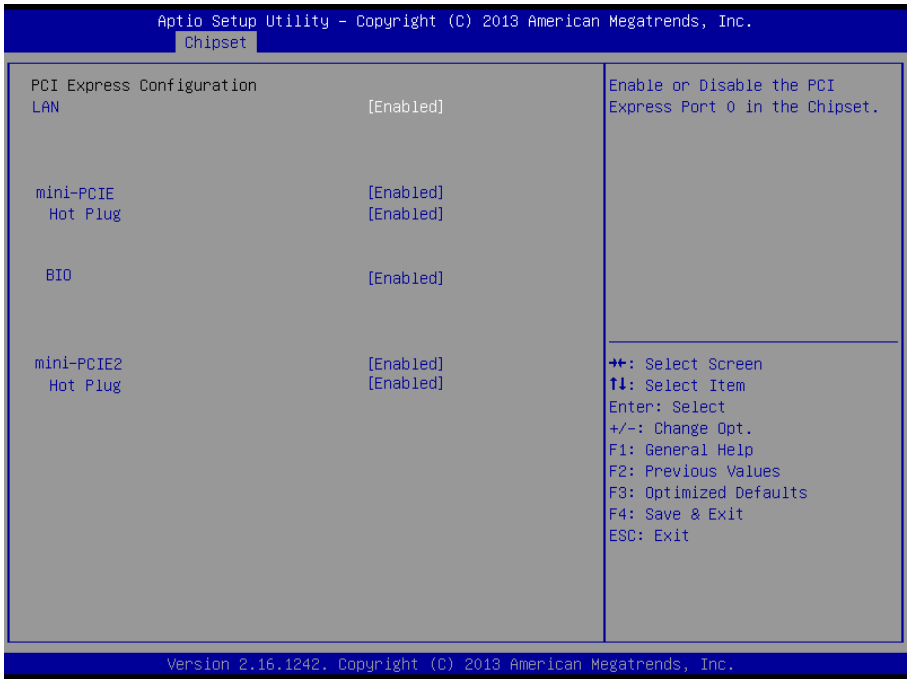

Options summary:

PCI Express Root Port x	Enabled	Optimal Default, Failsafe Default
	Disabled	
Enabling/Disabling PCI Express root ports		

### 3.6 Setup submenu: Security

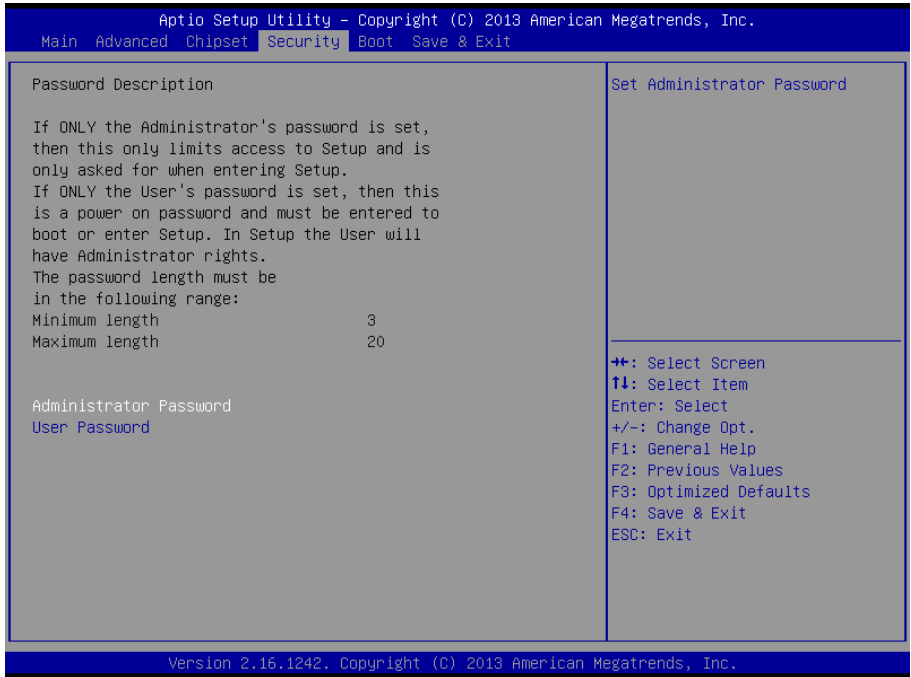

#### Change User/Administrator Password

You can set a User Password once an Administrator Password is set. The password will be required during boot up, or when the user enters the Setup utility. Please Note that a User Password does not provide access to many of the features in the Setup utility.

Select the password you wish to set, press Enter to open a dialog box to enter your password (you can enter no more than six letters or numbers). Press Enter to confirm your entry, after which you will be prompted to retype your password for a final confirmation. Press Enter again after you have retyped it correctly.

## Removing the Password

Highlight this item and type in the current password. At the next dialog box press Enter to disable password protection.

### 3.7 Setup submenu: Boot

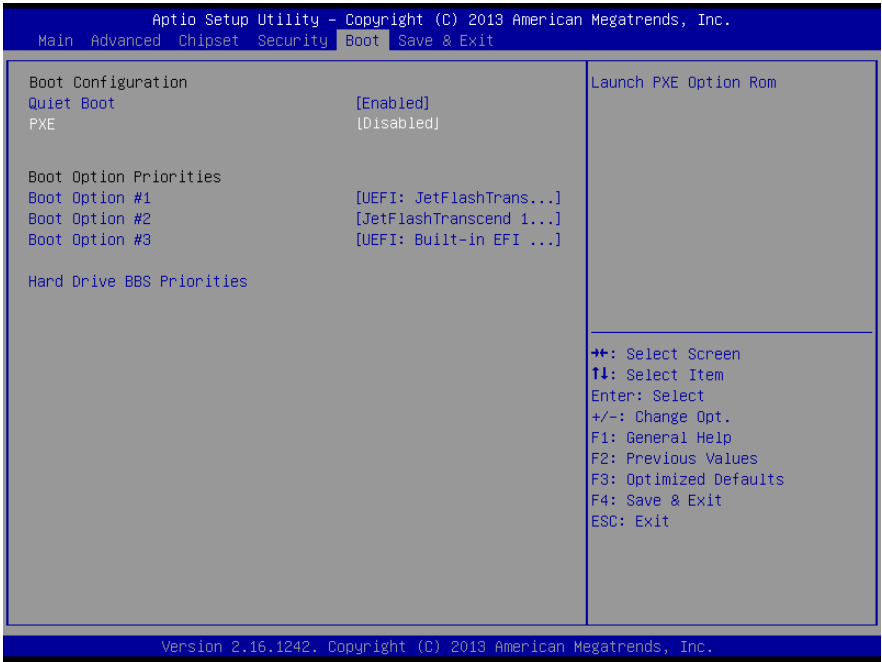

Options summary:

PXE	Disabled	Default
	Enabled	
En/Disable PXE boot for I211 LAN		
Quiet Boot	Disabled	Default
	Enabled	
En/Disable showing boot logo.		

### 3.8 Setup submenu: Save & Exit

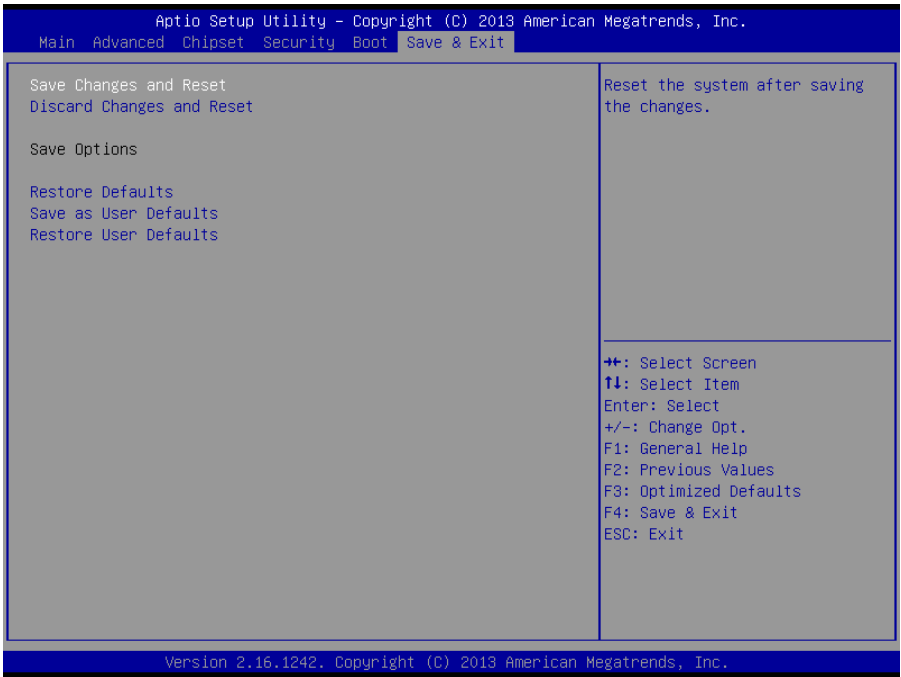



# Chapter 4

---

Drivers Installation

## 4.1 Driver Download/Installation

---

Drivers for the PICO-BT01 can be downloaded from the product page on the AAEON website by following this link:

<https://www.aaeon.com/en/p/pico-itx-boards-pico-bt01>

Download the driver(s) you need and follow the steps below to install them.

### Step 1 – Install Chipset Driver

1. Open the **Step1 - Chipset** folder and open the **SetupChipset.exe** file
2. Follow the instructions
3. Drivers will be installed automatically

### Step 2 – Install Graphics Driver

1. Open the **Step2 - Graphics** folder and select your OS
2. Open the **Setup.exe** file in the folder
3. Follow the instructions
4. Driver will be installed automatically

### Step 3 – Install LAN Driver

1. Open the **Step3 - LAN** folder followed by the **I211** folder
2. Select your OS
3. Open the **.exe** file in the folder
4. Follow the instructions
5. Driver will be installed automatically

#### Step 4 – Install Audio Driver

1. Open the **Step4 - Audio** folder and open the **Win7\_8-32\_64\_R273.exe** file
2. Follow the instructions
3. Driver will be installed automatically

#### Step 5 – Install USB3.0 Driver

1. Open the **Step5 - USB3.0** folder and open the **Setup.exe** file
2. Follow the instructions
3. Driver will be installed automatically

#### Step 6 – Install MBI Driver

1. Open the **Step7 - MBI** folder and open the **Setup.exe** file
2. Follow the instructions
3. Driver will be installed automatically

# Appendix A

---

## Watchdog Timer Programming

## A.1 Watchdog Timer Registers

Table 1 : Watch dog relative IO address		
	Default Value	Note
I/O Base Address	0xA00	I/O Base address for Watchdog operation. This address is assigned by SIO LDN7, register 0x60-0x61.

Table 2 : Watchdog relative register table				
Register	Offset	BitNum	Value	Note
Watchdog WDTRST# Enable	0x00	7	1	Enable/Disable time out output via WDTRST# 0: Disable 1: Enable
Pulse Width	0x05	0:1	01	Width of Pulse signal 00: 1ms (do not use) 01: 25ms 10: 125ms 11: 5s <b><i>Pulse width is must longer then 16ms.</i></b>
Signal Polarity	0x05	2	0	0: low active 1: high active <b><i>Must set this bit to 0</i></b>
Counting Unit	0x05	3	0	Select time unit. 0: second 1: minute
Output Signal Type	0x05	4	1	0: Level 1: Pulse <b><i>Must set this bit to 1</i></b>
Watchdog Timer Enable	0x05	5	1	0: Disable 1: Enable
Timeout Status	0x05	6	1	1: timeout occurred. Write a 1 to clear timeout status
Timer Counter	0x06			Time of watchdog timer (0~255)

## A.2 Watchdog Sample Program

```
*****
// WDT I/O operation relative definition (Please reference to Table 1)
#define WDTAddr    0xA00 // WDT I/O base address
Void  WDTWriteByte(byte Register, byte Value);
byte  WDTReadByte(byte Register);
Void  WDTSetReg(byte Register, byte Bit, byte Val);
// Watch Dog relative definition (Please reference to Table 2)
#define DevReg     0x00 // Device configuration register
    #define WDRstBit 0x80 // Watchdog WDTRST# (Bit7)
    #define WDRstVal 0x80 // Enabled WDTRST#
#define TimerReg   0x05 // Timer register
    #define PSWidthBit 0x00 // WDTRST# Pulse width (Bit0:1)
    #define PSWidthVal 0x01 // 25ms for WDTRST# pulse
    #define PolarityBit 0x02 // WDTRST# Signal polarity (Bit2)
    #define PolarityVal 0x00 // Low active for WDTRST#
    #define UnitBit    0x03 // Unit for timer (Bit3)
    #define ModeBit    0x04 // WDTRST# mode (Bit4)
    #define ModeVal    0x01 // 0:level 1: pulse
    #define EnableBit  0x05 // WDT timer enable (Bit5)
    #define EnableVal  0x01 // 1: enable
    #define StatusBit  0x06 // WDT timer status (Bit6)
#define CounterReg 0x06 // Timer counter register
*****

*****
VOID  Main(){
    // Procedure : AaeonWDTConfig
    // (byte)Timer : Counter of WDT timer.(0x00~0xFF)
    // (boolean)Unit : Select time unit(0: second, 1: minute).
    AaeonWDTConfig(Counter, Unit);

    // Procedure : AaeonWDTEnable
    // This procedure will enable the WDT counting.
    AaeonWDTEnable();
}
*****

*****
// Procedure : AaeonWDTEnable
```

```

VOID  AeonWDTEnable (){
    WDTEnableDisable(1);
}

// Procedure : AeonWDTConfig
VOID  AeonWDTConfig (byte Counter, BOOLEAN Unit){
    // Disable WDT counting
    WDTEnableDisable(0);
    // Clear Watchdog Timeout Status
    WDTClearTimeoutStatus();
    // WDT relative parameter setting
    WDTParameterSetting(Timer, Unit);
}

VOID  WDTEnableDisable(byte Value){
    If (Value == 1)
        WDTSetBit(TimerReg, EnableBit, 1);
    else
        WDTSetBit(TimerReg, EnableBit, 0);
}

VOID  WDTParameterSetting(byte Counter, BOOLEAN Unit){
    // Watchdog Timer counter setting
    WDTWriteByte(CounterReg, Counter);
    // WDT counting unit setting
    WDTSetBit(TimerReg, UnitBit, Unit);
    // WDT output mode set to pulse
    WDTSetBit(TimerReg, ModeBit, ModeVal);
    // WDT output mode set to active low
    WDTSetBit(TimerReg, PolarityBit, PolarityVal);
    // WDT output pulse width is 25ms
    WDTSetBit(TimerReg, PSWidthBit, PSWidthVal);
    // Watchdog WDTRST# Enable
    WDTSetBit(DevReg, WDTRstBit, WDTRstVal);
}

VOID  WDTClearTimeoutStatus(){
    WDTSetBit(TimerReg, StatusBit, 1);
}

*****
*****

```

```
VOID  WDTWriteByte(byte Register, byte Value){
    IOWriteByte(WDTAddr+Register, Value);
}

byte  WDTReadByte(byte Register){
    return IOReadByte(WDTAddr+Register);
}

VOID  WDTSetBit(byte Register, byte Bit, byte Val){
    byte TmpValue;

    TmpValue = WDTReadByte(Register);
    TmpValue &= ~(1 << Bit);
    TmpValue |= Val << Bit;
    WDTWriteByte(Register, TmpValue);
}
```

```
*****
```



# Appendix B

---

I/O Information

## B.1 I/O Address Map

4	Input/output (I/O)
	[00000000 - 0000006F] PCI Express Root Complex
	[00000020 - 00000021] Programmable interrupt controller
	[00000024 - 00000025] Programmable interrupt controller
	[00000028 - 00000029] Programmable interrupt controller
	[0000002C - 0000002D] Programmable interrupt controller
	[0000002E - 0000002F] Motherboard resources
	[00000030 - 00000031] Programmable interrupt controller
	[00000034 - 00000035] Programmable interrupt controller
	[00000038 - 00000039] Programmable interrupt controller
	[0000003C - 0000003D] Programmable interrupt controller
	[00000040 - 00000043] System timer
	[0000004E - 0000004F] Motherboard resources
	[00000050 - 00000053] System timer
	[00000060 - 00000060] Standard PS/2 Keyboard
	[00000061 - 00000061] Motherboard resources
	[00000063 - 00000063] Motherboard resources
	[00000064 - 00000064] Standard PS/2 Keyboard
	[00000065 - 00000065] Motherboard resources
	[00000067 - 00000067] Motherboard resources
	[00000070 - 00000070] Motherboard resources
	[00000070 - 00000077] System CMOS/real time clock
	[00000078 - 000000CF7] PCI Express Root Complex
	[00000080 - 0000008F] Motherboard resources
	[00000092 - 00000092] Motherboard resources
	[000000A0 - 000000A1] Programmable interrupt controller
	[000000A4 - 000000A5] Programmable interrupt controller
	[000000A8 - 000000A9] Programmable interrupt controller
	[000000AC - 000000AD] Programmable interrupt controller
	[000000B0 - 000000B1] Programmable interrupt controller
	[000000B2 - 000000B3] Motherboard resources
	[000000B4 - 000000B5] Programmable interrupt controller
	[000000B8 - 000000B9] Programmable interrupt controller
	[000000BC - 000000BD] Programmable interrupt controller
	[000002F8 - 000002FF] Communications Port (COM2)
	[000003B0 - 000003BB] Microsoft Basic Display Adapter
	[000003C0 - 000003DF] Microsoft Basic Display Adapter
	[000003F8 - 000003FF] Communications Port (COM1)
	[00000400 - 0000047F] Motherboard resources
	[000004D0 - 000004D1] Programmable interrupt controller
	[00000500 - 000005FE] Motherboard resources
	[00000600 - 0000061F] Motherboard resources
	[00000680 - 0000069F] Motherboard resources
	[00000A00 - 00000A0F] Motherboard resources
	[00000A10 - 00000A1F] Motherboard resources
	[00000D00 - 0000FFFF] PCI Express Root Complex
	[0000E000 - 0000EFFF] Intel(R) Atom(TM)/Celeron(R)/Pentium(R) Processor PCI Express - Root Port 1 - 0F48
	[0000F000 - 0000F01F] Intel(R) Atom(TM)/Celeron(R)/Pentium(R) Processor Platform Control Unit - SMBus Port - 0F12



































## B.2 Memory Address Map



































Pico-ITX Board



































PICO-BT01

Memory	
[000A0000 - 000BFFFF]	Microsoft Basic Display Adapter
[000A0000 - 000BFFFF]	PCI Express Root Complex
[000C0000 - 000DFFFF]	PCI Express Root Complex
[000E0000 - 000FFFFF]	PCI Express Root Complex
[C0000000 - CFFFFFFF]	Microsoft Basic Display Adapter
[C0000000 - D0716FFF]	PCI Express Root Complex
[D0000000 - D03FFFFF]	Microsoft Basic Display Adapter
[D0400000 - D04FFFFFFF]	Intel(R) Trusted Execution Engine Interface
[D0500000 - D05FFFFFFF]	Intel(R) Trusted Execution Engine Interface
[D0600000 - D061FFFF]	Intel(R) I211 Gigabit Network Connection
[D0600000 - D066FFFF]	Intel(R) Atom(TM)/Celeron(R)/Pentium(R) Processor PCI Express - Root Port 1 - 0F48
[D0620000 - D0623FFF]	Intel(R) I211 Gigabit Network Connection
[D0700000 - D070FFFF]	Intel(R) USB 3.0 eXtensible Host Controller - 0100 (Microsoft)
[D0710000 - D0713FFF]	High Definition Audio Controller
[D0714000 - D071401F]	Intel(R) Atom(TM)/Celeron(R)/Pentium(R) Processor Platform Control Unit - SMBus Port - 0F12
[D0716000 - D07167FF]	Intel(R) Atom(TM)/Celeron(R)/Pentium(R) Processor AHCI - 0F23
[E0000000 - EFFFFFFF]	Motherboard resources
[E00000D0 - E00000DB]	Intel(R) Sideband Fabric Device
[FED00000 - FED003FF]	High precision event timer
[FED01000 - FED01FFF]	Motherboard resources
[FED03000 - FED03FFF]	Motherboard resources
[FED04000 - FED04FFF]	Motherboard resources
[FED08000 - FED08FFF]	Motherboard resources
[FED0C000 - FED0FFFF]	Motherboard resources
[FED1C000 - FED1CFFF]	Motherboard resources
[FEE00000 - FEEFFFFFFF]	Motherboard resources
[FEF00000 - FEFFFFFFFF]	Motherboard resources
[FF000000 - FFFFFFFF]	Intel(R) 82802 Firmware Hub Device



































## B.3 IRQ Mapping Chart



































 Interrupt request (IRQ)	
 (ISA) 0x00000000 (00)	System timer
 (ISA) 0x00000001 (01)	Standard PS/2 Keyboard
 (ISA) 0x00000003 (03)	Communications Port (COM2)
 (ISA) 0x00000004 (04)	Communications Port (COM1)
 (ISA) 0x00000008 (08)	High precision event timer
 (ISA) 0x0000000C (12)	PS/2 Compatible Mouse
 (ISA) 0x00000051 (81)	Microsoft ACPI-Compliant System
 (ISA) 0x00000052 (82)	Microsoft ACPI-Compliant System
 (ISA) 0x00000053 (83)	Microsoft ACPI-Compliant System
 (ISA) 0x00000054 (84)	Microsoft ACPI-Compliant System
 (ISA) 0x00000055 (85)	Microsoft ACPI-Compliant System
 (ISA) 0x00000056 (86)	Microsoft ACPI-Compliant System
 (ISA) 0x00000057 (87)	Microsoft ACPI-Compliant System
 (ISA) 0x00000058 (88)	Microsoft ACPI-Compliant System
 (ISA) 0x00000059 (89)	Microsoft ACPI-Compliant System
 (ISA) 0x0000005A (90)	Microsoft ACPI-Compliant System
 (ISA) 0x0000005B (91)	Microsoft ACPI-Compliant System
 (ISA) 0x0000005C (92)	Microsoft ACPI-Compliant System
 (ISA) 0x0000005D (93)	Microsoft ACPI-Compliant System
 (ISA) 0x0000005E (94)	Microsoft ACPI-Compliant System
 (ISA) 0x0000005F (95)	Microsoft ACPI-Compliant System
 (ISA) 0x00000060 (96)	Microsoft ACPI-Compliant System
 (ISA) 0x00000061 (97)	Microsoft ACPI-Compliant System
 (ISA) 0x00000062 (98)	Microsoft ACPI-Compliant System
 (ISA) 0x00000063 (99)	Microsoft ACPI-Compliant System
 (ISA) 0x00000064 (100)	Microsoft ACPI-Compliant System
 (ISA) 0x00000065 (101)	Microsoft ACPI-Compliant System
 (ISA) 0x00000066 (102)	Microsoft ACPI-Compliant System
 (ISA) 0x00000067 (103)	Microsoft ACPI-Compliant System
 (ISA) 0x00000068 (104)	Microsoft ACPI-Compliant System
 (ISA) 0x00000069 (105)	Microsoft ACPI-Compliant System
 (ISA) 0x0000006A (106)	Microsoft ACPI-Compliant System
 (ISA) 0x0000006B (107)	Microsoft ACPI-Compliant System
 (ISA) 0x0000006C (108)	Microsoft ACPI-Compliant System

 (ISA) 0x0000006C (108)	Microsoft ACPI-Compliant System
 (ISA) 0x0000006D (109)	Microsoft ACPI-Compliant System
 (ISA) 0x0000006E (110)	Microsoft ACPI-Compliant System
 (ISA) 0x0000006F (111)	Microsoft ACPI-Compliant System
 (ISA) 0x00000070 (112)	Microsoft ACPI-Compliant System
 (ISA) 0x00000071 (113)	Microsoft ACPI-Compliant System
 (ISA) 0x00000072 (114)	Microsoft ACPI-Compliant System
 (ISA) 0x00000073 (115)	Microsoft ACPI-Compliant System
 (ISA) 0x00000074 (116)	Microsoft ACPI-Compliant System
 (ISA) 0x00000075 (117)	Microsoft ACPI-Compliant System
 (ISA) 0x00000076 (118)	Microsoft ACPI-Compliant System
 (ISA) 0x00000077 (119)	Microsoft ACPI-Compliant System
 (ISA) 0x00000078 (120)	Microsoft ACPI-Compliant System
 (ISA) 0x00000079 (121)	Microsoft ACPI-Compliant System
 (ISA) 0x0000007A (122)	Microsoft ACPI-Compliant System
 (ISA) 0x0000007B (123)	Microsoft ACPI-Compliant System
 (ISA) 0x0000007C (124)	Microsoft ACPI-Compliant System
 (ISA) 0x0000007D (125)	Microsoft ACPI-Compliant System
 (ISA) 0x0000007E (126)	Microsoft ACPI-Compliant System
 (ISA) 0x0000007F (127)	Microsoft ACPI-Compliant System
 (ISA) 0x00000080 (128)	Microsoft ACPI-Compliant System
 (ISA) 0x00000081 (129)	Microsoft ACPI-Compliant System
 (ISA) 0x00000082 (130)	Microsoft ACPI-Compliant System
 (ISA) 0x00000083 (131)	Microsoft ACPI-Compliant System
 (ISA) 0x00000084 (132)	Microsoft ACPI-Compliant System
 (ISA) 0x00000085 (133)	Microsoft ACPI-Compliant System
 (ISA) 0x00000086 (134)	Microsoft ACPI-Compliant System
 (ISA) 0x00000087 (135)	Microsoft ACPI-Compliant System
 (ISA) 0x00000088 (136)	Microsoft ACPI-Compliant System
 (ISA) 0x00000089 (137)	Microsoft ACPI-Compliant System
 (ISA) 0x0000008A (138)	Microsoft ACPI-Compliant System
 (ISA) 0x0000008B (139)	Microsoft ACPI-Compliant System
 (ISA) 0x0000008C (140)	Microsoft ACPI-Compliant System
 (ISA) 0x0000008D (141)	Microsoft ACPI-Compliant System
 (ISA) 0x0000008E (142)	Microsoft ACPI-Compliant System



































 (ISA) 0x0000008E (142)	Microsoft ACPI-Compliant System
 (ISA) 0x0000008F (143)	Microsoft ACPI-Compliant System
 (ISA) 0x00000090 (144)	Microsoft ACPI-Compliant System
 (ISA) 0x00000091 (145)	Microsoft ACPI-Compliant System
 (ISA) 0x00000092 (146)	Microsoft ACPI-Compliant System
 (ISA) 0x00000093 (147)	Microsoft ACPI-Compliant System
 (ISA) 0x00000094 (148)	Microsoft ACPI-Compliant System
 (ISA) 0x00000095 (149)	Microsoft ACPI-Compliant System
 (ISA) 0x00000096 (150)	Microsoft ACPI-Compliant System
 (ISA) 0x00000097 (151)	Microsoft ACPI-Compliant System
 (ISA) 0x00000098 (152)	Microsoft ACPI-Compliant System
 (ISA) 0x00000099 (153)	Microsoft ACPI-Compliant System
 (ISA) 0x0000009A (154)	Microsoft ACPI-Compliant System
 (ISA) 0x0000009B (155)	Microsoft ACPI-Compliant System
 (ISA) 0x0000009C (156)	Microsoft ACPI-Compliant System
 (ISA) 0x0000009D (157)	Microsoft ACPI-Compliant System
 (ISA) 0x0000009E (158)	Microsoft ACPI-Compliant System
 (ISA) 0x0000009F (159)	Microsoft ACPI-Compliant System
 (ISA) 0x000000A0 (160)	Microsoft ACPI-Compliant System
 (ISA) 0x000000A1 (161)	Microsoft ACPI-Compliant System
 (ISA) 0x000000A2 (162)	Microsoft ACPI-Compliant System
 (ISA) 0x000000A3 (163)	Microsoft ACPI-Compliant System
 (ISA) 0x000000A4 (164)	Microsoft ACPI-Compliant System
 (ISA) 0x000000A5 (165)	Microsoft ACPI-Compliant System
 (ISA) 0x000000A6 (166)	Microsoft ACPI-Compliant System
 (ISA) 0x000000A7 (167)	Microsoft ACPI-Compliant System
 (ISA) 0x000000A8 (168)	Microsoft ACPI-Compliant System
 (ISA) 0x000000A9 (169)	Microsoft ACPI-Compliant System
 (ISA) 0x000000AA (170)	Microsoft ACPI-Compliant System
 (ISA) 0x000000AB (171)	Microsoft ACPI-Compliant System
 (ISA) 0x000000AC (172)	Microsoft ACPI-Compliant System
 (ISA) 0x000000AD (173)	Microsoft ACPI-Compliant System
 (ISA) 0x000000AE (174)	Microsoft ACPI-Compliant System
 (ISA) 0x000000AF (175)	Microsoft ACPI-Compliant System
 (ISA) 0x000000B0 (176)	Microsoft ACPI-Compliant System



































---



































 (ISA) 0x000000B0 (176)	Microsoft ACPI-Compliant System
 (ISA) 0x000000B1 (177)	Microsoft ACPI-Compliant System
 (ISA) 0x000000B2 (178)	Microsoft ACPI-Compliant System
 (ISA) 0x000000B3 (179)	Microsoft ACPI-Compliant System
 (ISA) 0x000000B4 (180)	Microsoft ACPI-Compliant System
 (ISA) 0x000000B5 (181)	Microsoft ACPI-Compliant System
 (ISA) 0x000000B6 (182)	Microsoft ACPI-Compliant System
 (ISA) 0x000000B7 (183)	Microsoft ACPI-Compliant System
 (ISA) 0x000000B8 (184)	Microsoft ACPI-Compliant System
 (ISA) 0x000000B9 (185)	Microsoft ACPI-Compliant System
 (ISA) 0x000000BA (186)	Microsoft ACPI-Compliant System
 (ISA) 0x000000BB (187)	Microsoft ACPI-Compliant System
 (ISA) 0x000000BC (188)	Microsoft ACPI-Compliant System
 (ISA) 0x000000BD (189)	Microsoft ACPI-Compliant System
 (ISA) 0x000000BE (190)	Microsoft ACPI-Compliant System
 (ISA) 0x000000BF (191)	Microsoft ACPI-Compliant System
 (ISA) 0x00000100 (256)	Microsoft ACPI-Compliant System
 (ISA) 0x00000101 (257)	Microsoft ACPI-Compliant System
 (ISA) 0x00000102 (258)	Microsoft ACPI-Compliant System
 (ISA) 0x00000103 (259)	Microsoft ACPI-Compliant System
 (ISA) 0x00000104 (260)	Microsoft ACPI-Compliant System
 (ISA) 0x00000105 (261)	Microsoft ACPI-Compliant System
 (ISA) 0x00000106 (262)	Microsoft ACPI-Compliant System
 (ISA) 0x00000107 (263)	Microsoft ACPI-Compliant System
 (ISA) 0x00000108 (264)	Microsoft ACPI-Compliant System
 (ISA) 0x00000109 (265)	Microsoft ACPI-Compliant System
 (ISA) 0x0000010A (266)	Microsoft ACPI-Compliant System
 (ISA) 0x0000010B (267)	Microsoft ACPI-Compliant System
 (ISA) 0x0000010C (268)	Microsoft ACPI-Compliant System
 (ISA) 0x0000010D (269)	Microsoft ACPI-Compliant System
 (ISA) 0x0000010E (270)	Microsoft ACPI-Compliant System
 (ISA) 0x0000010F (271)	Microsoft ACPI-Compliant System
 (ISA) 0x00000110 (272)	Microsoft ACPI-Compliant System
 (ISA) 0x00000111 (273)	Microsoft ACPI-Compliant System
 (ISA) 0x00000112 (274)	Microsoft ACPI-Compliant System



































 (ISA) 0x00000111 (273)	Microsoft ACPI-Compliant System
 (ISA) 0x00000112 (274)	Microsoft ACPI-Compliant System
 (ISA) 0x00000113 (275)	Microsoft ACPI-Compliant System
 (ISA) 0x00000114 (276)	Microsoft ACPI-Compliant System
 (ISA) 0x00000115 (277)	Microsoft ACPI-Compliant System
 (ISA) 0x00000116 (278)	Microsoft ACPI-Compliant System
 (ISA) 0x00000117 (279)	Microsoft ACPI-Compliant System
 (ISA) 0x00000118 (280)	Microsoft ACPI-Compliant System
 (ISA) 0x00000119 (281)	Microsoft ACPI-Compliant System
 (ISA) 0x0000011A (282)	Microsoft ACPI-Compliant System
 (ISA) 0x0000011B (283)	Microsoft ACPI-Compliant System
 (ISA) 0x0000011C (284)	Microsoft ACPI-Compliant System
 (ISA) 0x0000011D (285)	Microsoft ACPI-Compliant System
 (ISA) 0x0000011E (286)	Microsoft ACPI-Compliant System
 (ISA) 0x0000011F (287)	Microsoft ACPI-Compliant System
 (ISA) 0x00000120 (288)	Microsoft ACPI-Compliant System
 (ISA) 0x00000121 (289)	Microsoft ACPI-Compliant System
 (ISA) 0x00000122 (290)	Microsoft ACPI-Compliant System
 (ISA) 0x00000123 (291)	Microsoft ACPI-Compliant System
 (ISA) 0x00000124 (292)	Microsoft ACPI-Compliant System
 (ISA) 0x00000125 (293)	Microsoft ACPI-Compliant System
 (ISA) 0x00000126 (294)	Microsoft ACPI-Compliant System
 (ISA) 0x00000127 (295)	Microsoft ACPI-Compliant System
 (ISA) 0x00000128 (296)	Microsoft ACPI-Compliant System
 (ISA) 0x00000129 (297)	Microsoft ACPI-Compliant System
 (ISA) 0x0000012A (298)	Microsoft ACPI-Compliant System
 (ISA) 0x0000012B (299)	Microsoft ACPI-Compliant System
 (ISA) 0x0000012C (300)	Microsoft ACPI-Compliant System
 (ISA) 0x0000012D (301)	Microsoft ACPI-Compliant System
 (ISA) 0x0000012E (302)	Microsoft ACPI-Compliant System
 (ISA) 0x0000012F (303)	Microsoft ACPI-Compliant System
 (ISA) 0x00000130 (304)	Microsoft ACPI-Compliant System
 (ISA) 0x00000131 (305)	Microsoft ACPI-Compliant System
 (ISA) 0x00000132 (306)	Microsoft ACPI-Compliant System
 (ISA) 0x00000133 (307)	Microsoft ACPI-Compliant System









































































 (ISA) 0x00000132 (306)	Microsoft ACPI-Compliant System
 (ISA) 0x00000133 (307)	Microsoft ACPI-Compliant System
 (ISA) 0x00000134 (308)	Microsoft ACPI-Compliant System
 (ISA) 0x00000135 (309)	Microsoft ACPI-Compliant System
 (ISA) 0x00000136 (310)	Microsoft ACPI-Compliant System
 (ISA) 0x00000137 (311)	Microsoft ACPI-Compliant System
 (ISA) 0x00000138 (312)	Microsoft ACPI-Compliant System
 (ISA) 0x00000139 (313)	Microsoft ACPI-Compliant System
 (ISA) 0x0000013A (314)	Microsoft ACPI-Compliant System
 (ISA) 0x0000013B (315)	Microsoft ACPI-Compliant System
 (ISA) 0x0000013C (316)	Microsoft ACPI-Compliant System
 (ISA) 0x0000013D (317)	Microsoft ACPI-Compliant System
 (ISA) 0x0000013E (318)	Microsoft ACPI-Compliant System
 (ISA) 0x0000013F (319)	Microsoft ACPI-Compliant System
 (ISA) 0x00000140 (320)	Microsoft ACPI-Compliant System
 (ISA) 0x00000141 (321)	Microsoft ACPI-Compliant System
 (ISA) 0x00000142 (322)	Microsoft ACPI-Compliant System
 (ISA) 0x00000143 (323)	Microsoft ACPI-Compliant System
 (ISA) 0x00000144 (324)	Microsoft ACPI-Compliant System
 (ISA) 0x00000145 (325)	Microsoft ACPI-Compliant System
 (ISA) 0x00000146 (326)	Microsoft ACPI-Compliant System
 (ISA) 0x00000147 (327)	Microsoft ACPI-Compliant System
 (ISA) 0x00000148 (328)	Microsoft ACPI-Compliant System
 (ISA) 0x00000149 (329)	Microsoft ACPI-Compliant System
 (ISA) 0x0000014A (330)	Microsoft ACPI-Compliant System
 (ISA) 0x0000014B (331)	Microsoft ACPI-Compliant System
 (ISA) 0x0000014C (332)	Microsoft ACPI-Compliant System
 (ISA) 0x0000014D (333)	Microsoft ACPI-Compliant System
 (ISA) 0x0000014E (334)	Microsoft ACPI-Compliant System
 (ISA) 0x0000014F (335)	Microsoft ACPI-Compliant System
 (ISA) 0x00000150 (336)	Microsoft ACPI-Compliant System
 (ISA) 0x00000151 (337)	Microsoft ACPI-Compliant System
 (ISA) 0x00000152 (338)	Microsoft ACPI-Compliant System
 (ISA) 0x00000153 (339)	Microsoft ACPI-Compliant System
 (ISA) 0x00000154 (340)	Microsoft ACPI-Compliant System



































 (ISA) 0x00000153 (339)	Microsoft ACPI-Compliant System
 (ISA) 0x00000154 (340)	Microsoft ACPI-Compliant System
 (ISA) 0x00000155 (341)	Microsoft ACPI-Compliant System
 (ISA) 0x00000156 (342)	Microsoft ACPI-Compliant System
 (ISA) 0x00000157 (343)	Microsoft ACPI-Compliant System
 (ISA) 0x00000158 (344)	Microsoft ACPI-Compliant System
 (ISA) 0x00000159 (345)	Microsoft ACPI-Compliant System
 (ISA) 0x0000015A (346)	Microsoft ACPI-Compliant System
 (ISA) 0x0000015B (347)	Microsoft ACPI-Compliant System
 (ISA) 0x0000015C (348)	Microsoft ACPI-Compliant System
 (ISA) 0x0000015D (349)	Microsoft ACPI-Compliant System
 (ISA) 0x0000015E (350)	Microsoft ACPI-Compliant System
 (ISA) 0x0000015F (351)	Microsoft ACPI-Compliant System
 (ISA) 0x00000160 (352)	Microsoft ACPI-Compliant System
 (ISA) 0x00000161 (353)	Microsoft ACPI-Compliant System
 (ISA) 0x00000162 (354)	Microsoft ACPI-Compliant System
 (ISA) 0x00000163 (355)	Microsoft ACPI-Compliant System
 (ISA) 0x00000164 (356)	Microsoft ACPI-Compliant System
 (ISA) 0x00000165 (357)	Microsoft ACPI-Compliant System
 (ISA) 0x00000166 (358)	Microsoft ACPI-Compliant System
 (ISA) 0x00000167 (359)	Microsoft ACPI-Compliant System
 (ISA) 0x00000168 (360)	Microsoft ACPI-Compliant System
 (ISA) 0x00000169 (361)	Microsoft ACPI-Compliant System
 (ISA) 0x0000016A (362)	Microsoft ACPI-Compliant System
 (ISA) 0x0000016B (363)	Microsoft ACPI-Compliant System
 (ISA) 0x0000016C (364)	Microsoft ACPI-Compliant System
 (ISA) 0x0000016D (365)	Microsoft ACPI-Compliant System
 (ISA) 0x0000016E (366)	Microsoft ACPI-Compliant System
 (ISA) 0x0000016F (367)	Microsoft ACPI-Compliant System
 (ISA) 0x00000170 (368)	Microsoft ACPI-Compliant System
 (ISA) 0x00000171 (369)	Microsoft ACPI-Compliant System
 (ISA) 0x00000172 (370)	Microsoft ACPI-Compliant System
 (ISA) 0x00000173 (371)	Microsoft ACPI-Compliant System
 (ISA) 0x00000174 (372)	Microsoft ACPI-Compliant System
 (ISA) 0x00000175 (373)	Microsoft ACPI-Compliant System

 (ISA) 0x00000174 (372)	Microsoft ACPI-Compliant System
 (ISA) 0x00000175 (373)	Microsoft ACPI-Compliant System
 (ISA) 0x00000176 (374)	Microsoft ACPI-Compliant System
 (ISA) 0x00000177 (375)	Microsoft ACPI-Compliant System
 (ISA) 0x00000178 (376)	Microsoft ACPI-Compliant System
 (ISA) 0x00000179 (377)	Microsoft ACPI-Compliant System
 (ISA) 0x0000017A (378)	Microsoft ACPI-Compliant System
 (ISA) 0x0000017B (379)	Microsoft ACPI-Compliant System
 (ISA) 0x0000017C (380)	Microsoft ACPI-Compliant System
 (ISA) 0x0000017D (381)	Microsoft ACPI-Compliant System
 (ISA) 0x0000017E (382)	Microsoft ACPI-Compliant System
 (ISA) 0x0000017F (383)	Microsoft ACPI-Compliant System
 (ISA) 0x00000180 (384)	Microsoft ACPI-Compliant System
 (ISA) 0x00000181 (385)	Microsoft ACPI-Compliant System
 (ISA) 0x00000182 (386)	Microsoft ACPI-Compliant System
 (ISA) 0x00000183 (387)	Microsoft ACPI-Compliant System
 (ISA) 0x00000184 (388)	Microsoft ACPI-Compliant System
 (ISA) 0x00000185 (389)	Microsoft ACPI-Compliant System
 (ISA) 0x00000186 (390)	Microsoft ACPI-Compliant System
 (ISA) 0x00000187 (391)	Microsoft ACPI-Compliant System
 (ISA) 0x00000188 (392)	Microsoft ACPI-Compliant System
 (ISA) 0x00000189 (393)	Microsoft ACPI-Compliant System
 (ISA) 0x0000018A (394)	Microsoft ACPI-Compliant System
 (ISA) 0x0000018B (395)	Microsoft ACPI-Compliant System
 (ISA) 0x0000018C (396)	Microsoft ACPI-Compliant System
 (ISA) 0x0000018D (397)	Microsoft ACPI-Compliant System
 (ISA) 0x0000018E (398)	Microsoft ACPI-Compliant System
 (ISA) 0x0000018F (399)	Microsoft ACPI-Compliant System
 (ISA) 0x00000190 (400)	Microsoft ACPI-Compliant System
 (ISA) 0x00000191 (401)	Microsoft ACPI-Compliant System
 (ISA) 0x00000192 (402)	Microsoft ACPI-Compliant System
 (ISA) 0x00000193 (403)	Microsoft ACPI-Compliant System
 (ISA) 0x00000194 (404)	Microsoft ACPI-Compliant System
 (ISA) 0x00000195 (405)	Microsoft ACPI-Compliant System
 (ISA) 0x00000196 (406)	Microsoft ACPI-Compliant System

 (ISA) 0x00000195 (405)	Microsoft ACPI-Compliant System
 (ISA) 0x00000196 (406)	Microsoft ACPI-Compliant System
 (ISA) 0x00000197 (407)	Microsoft ACPI-Compliant System
 (ISA) 0x00000198 (408)	Microsoft ACPI-Compliant System
 (ISA) 0x00000199 (409)	Microsoft ACPI-Compliant System
 (ISA) 0x0000019A (410)	Microsoft ACPI-Compliant System
 (ISA) 0x0000019B (411)	Microsoft ACPI-Compliant System
 (ISA) 0x0000019C (412)	Microsoft ACPI-Compliant System
 (ISA) 0x0000019D (413)	Microsoft ACPI-Compliant System
 (ISA) 0x0000019E (414)	Microsoft ACPI-Compliant System
 (ISA) 0x0000019F (415)	Microsoft ACPI-Compliant System
 (ISA) 0x000001A0 (416)	Microsoft ACPI-Compliant System
 (ISA) 0x000001A1 (417)	Microsoft ACPI-Compliant System
 (ISA) 0x000001A2 (418)	Microsoft ACPI-Compliant System
 (ISA) 0x000001A3 (419)	Microsoft ACPI-Compliant System
 (ISA) 0x000001A4 (420)	Microsoft ACPI-Compliant System
 (ISA) 0x000001A5 (421)	Microsoft ACPI-Compliant System
 (ISA) 0x000001A6 (422)	Microsoft ACPI-Compliant System
 (ISA) 0x000001A7 (423)	Microsoft ACPI-Compliant System
 (ISA) 0x000001A8 (424)	Microsoft ACPI-Compliant System
 (ISA) 0x000001A9 (425)	Microsoft ACPI-Compliant System
 (ISA) 0x000001AA (426)	Microsoft ACPI-Compliant System
 (ISA) 0x000001AB (427)	Microsoft ACPI-Compliant System
 (ISA) 0x000001AC (428)	Microsoft ACPI-Compliant System
 (ISA) 0x000001AD (429)	Microsoft ACPI-Compliant System
 (ISA) 0x000001AE (430)	Microsoft ACPI-Compliant System
 (ISA) 0x000001AF (431)	Microsoft ACPI-Compliant System
 (ISA) 0x000001B0 (432)	Microsoft ACPI-Compliant System
 (ISA) 0x000001B1 (433)	Microsoft ACPI-Compliant System
 (ISA) 0x000001B2 (434)	Microsoft ACPI-Compliant System
 (ISA) 0x000001B3 (435)	Microsoft ACPI-Compliant System
 (ISA) 0x000001B4 (436)	Microsoft ACPI-Compliant System
 (ISA) 0x000001B5 (437)	Microsoft ACPI-Compliant System
 (ISA) 0x000001B6 (438)	Microsoft ACPI-Compliant System
 (ISA) 0x000001B7 (439)	Microsoft ACPI-Compliant System

 (ISA) 0x000001B6 (438)	Microsoft ACPI-Compliant System
 (ISA) 0x000001B7 (439)	Microsoft ACPI-Compliant System
 (ISA) 0x000001B8 (440)	Microsoft ACPI-Compliant System
 (ISA) 0x000001B9 (441)	Microsoft ACPI-Compliant System
 (ISA) 0x000001BA (442)	Microsoft ACPI-Compliant System
 (ISA) 0x000001BB (443)	Microsoft ACPI-Compliant System
 (ISA) 0x000001BC (444)	Microsoft ACPI-Compliant System
 (ISA) 0x000001BD (445)	Microsoft ACPI-Compliant System
 (ISA) 0x000001BE (446)	Microsoft ACPI-Compliant System
 (ISA) 0x000001BF (447)	Microsoft ACPI-Compliant System
 (ISA) 0x000001C0 (448)	Microsoft ACPI-Compliant System
 (ISA) 0x000001C1 (449)	Microsoft ACPI-Compliant System
 (ISA) 0x000001C2 (450)	Microsoft ACPI-Compliant System
 (ISA) 0x000001C3 (451)	Microsoft ACPI-Compliant System
 (ISA) 0x000001C4 (452)	Microsoft ACPI-Compliant System
 (ISA) 0x000001C5 (453)	Microsoft ACPI-Compliant System
 (ISA) 0x000001C6 (454)	Microsoft ACPI-Compliant System
 (ISA) 0x000001C7 (455)	Microsoft ACPI-Compliant System
 (ISA) 0x000001C8 (456)	Microsoft ACPI-Compliant System
 (ISA) 0x000001C9 (457)	Microsoft ACPI-Compliant System
 (ISA) 0x000001CA (458)	Microsoft ACPI-Compliant System
 (ISA) 0x000001CB (459)	Microsoft ACPI-Compliant System
 (ISA) 0x000001CC (460)	Microsoft ACPI-Compliant System
 (ISA) 0x000001CD (461)	Microsoft ACPI-Compliant System
 (ISA) 0x000001CE (462)	Microsoft ACPI-Compliant System
 (ISA) 0x000001CF (463)	Microsoft ACPI-Compliant System
 (ISA) 0x000001D0 (464)	Microsoft ACPI-Compliant System
 (ISA) 0x000001D1 (465)	Microsoft ACPI-Compliant System
 (ISA) 0x000001D2 (466)	Microsoft ACPI-Compliant System
 (ISA) 0x000001D3 (467)	Microsoft ACPI-Compliant System
 (ISA) 0x000001D4 (468)	Microsoft ACPI-Compliant System
 (ISA) 0x000001D5 (469)	Microsoft ACPI-Compliant System
 (ISA) 0x000001D6 (470)	Microsoft ACPI-Compliant System
 (ISA) 0x000001D7 (471)	Microsoft ACPI-Compliant System
 (ISA) 0x000001D8 (472)	Microsoft ACPI-Compliant System

 (ISA) 0x000001D7 (471)	Microsoft ACPI-Compliant System
 (ISA) 0x000001D8 (472)	Microsoft ACPI-Compliant System
 (ISA) 0x000001D9 (473)	Microsoft ACPI-Compliant System
 (ISA) 0x000001DA (474)	Microsoft ACPI-Compliant System
 (ISA) 0x000001DB (475)	Microsoft ACPI-Compliant System
 (ISA) 0x000001DC (476)	Microsoft ACPI-Compliant System
 (ISA) 0x000001DD (477)	Microsoft ACPI-Compliant System
 (ISA) 0x000001DE (478)	Microsoft ACPI-Compliant System
 (ISA) 0x000001DF (479)	Microsoft ACPI-Compliant System
 (ISA) 0x000001E0 (480)	Microsoft ACPI-Compliant System
 (ISA) 0x000001E1 (481)	Microsoft ACPI-Compliant System
 (ISA) 0x000001E2 (482)	Microsoft ACPI-Compliant System
 (ISA) 0x000001E3 (483)	Microsoft ACPI-Compliant System
 (ISA) 0x000001E4 (484)	Microsoft ACPI-Compliant System
 (ISA) 0x000001E5 (485)	Microsoft ACPI-Compliant System
 (ISA) 0x000001E6 (486)	Microsoft ACPI-Compliant System
 (ISA) 0x000001E7 (487)	Microsoft ACPI-Compliant System
 (ISA) 0x000001E8 (488)	Microsoft ACPI-Compliant System
 (ISA) 0x000001E9 (489)	Microsoft ACPI-Compliant System
 (ISA) 0x000001EA (490)	Microsoft ACPI-Compliant System
 (ISA) 0x000001EB (491)	Microsoft ACPI-Compliant System
 (ISA) 0x000001EC (492)	Microsoft ACPI-Compliant System
 (ISA) 0x000001ED (493)	Microsoft ACPI-Compliant System
 (ISA) 0x000001EE (494)	Microsoft ACPI-Compliant System
 (ISA) 0x000001EF (495)	Microsoft ACPI-Compliant System
 (ISA) 0x000001F0 (496)	Microsoft ACPI-Compliant System
 (ISA) 0x000001F1 (497)	Microsoft ACPI-Compliant System
 (ISA) 0x000001F2 (498)	Microsoft ACPI-Compliant System
 (ISA) 0x000001F3 (499)	Microsoft ACPI-Compliant System
 (ISA) 0x000001F4 (500)	Microsoft ACPI-Compliant System
 (ISA) 0x000001F5 (501)	Microsoft ACPI-Compliant System
 (ISA) 0x000001F6 (502)	Microsoft ACPI-Compliant System
 (ISA) 0x000001F7 (503)	Microsoft ACPI-Compliant System
 (ISA) 0x000001F8 (504)	Microsoft ACPI-Compliant System
 (ISA) 0x000001F9 (505)	Microsoft ACPI-Compliant System

 (ISA) 0x000001EF (495)	Microsoft ACPI-Compliant System
 (ISA) 0x000001F0 (496)	Microsoft ACPI-Compliant System
 (ISA) 0x000001F1 (497)	Microsoft ACPI-Compliant System
 (ISA) 0x000001F2 (498)	Microsoft ACPI-Compliant System
 (ISA) 0x000001F3 (499)	Microsoft ACPI-Compliant System
 (ISA) 0x000001F4 (500)	Microsoft ACPI-Compliant System
 (ISA) 0x000001F5 (501)	Microsoft ACPI-Compliant System
 (ISA) 0x000001F6 (502)	Microsoft ACPI-Compliant System
 (ISA) 0x000001F7 (503)	Microsoft ACPI-Compliant System
 (ISA) 0x000001F8 (504)	Microsoft ACPI-Compliant System
 (ISA) 0x000001F9 (505)	Microsoft ACPI-Compliant System
 (ISA) 0x000001FA (506)	Microsoft ACPI-Compliant System
 (ISA) 0x000001FB (507)	Microsoft ACPI-Compliant System
 (ISA) 0x000001FC (508)	Microsoft ACPI-Compliant System
 (ISA) 0x000001FD (509)	Microsoft ACPI-Compliant System
 (ISA) 0x000001FE (510)	Microsoft ACPI-Compliant System
 (ISA) 0x000001FF (511)	Microsoft ACPI-Compliant System
 (PCI) 0x00000005 (05)	Intel(R) Atom(TM)/Celeron(R)/Pentium(R) Processor Platform Control Unit - SMBus Port - 0F12
 (PCI) 0x00000010 (16)	Intel(R) Atom(TM)/Celeron(R)/Pentium(R) Processor PCI Express - Root Port 1 - 0F48
 (PCI) 0x00000011 (17)	Intel(R) Atom(TM)/Celeron(R)/Pentium(R) Processor PCI Express - Root Port 2 - 0F4A
 (PCI) 0x00000012 (18)	Intel(R) Atom(TM)/Celeron(R)/Pentium(R) Processor PCI Express - Root Port 3 - 0F4C
 (PCI) 0x00000013 (19)	Intel(R) Atom(TM)/Celeron(R)/Pentium(R) Processor AHCI - 0F23
 (PCI) 0x00000013 (19)	Intel(R) Atom(TM)/Celeron(R)/Pentium(R) Processor PCI Express - Root Port 4 - 0F4E
 (PCI) 0x00000016 (22)	High Definition Audio Controller
 (PCI) 0xFFFFFFFF7 (-9)	Intel(R) Trusted Execution Engine Interface
 (PCI) 0xFFFFFFFF8 (-8)	Intel(R) I211 Gigabit Network Connection
 (PCI) 0xFFFFFFFF9 (-7)	Intel(R) I211 Gigabit Network Connection
 (PCI) 0xFFFFFFFFA (-6)	Intel(R) I211 Gigabit Network Connection
 (PCI) 0xFFFFFFFFB (-5)	Intel(R) I211 Gigabit Network Connection
 (PCI) 0xFFFFFFFFC (-4)	Intel(R) I211 Gigabit Network Connection
 (PCI) 0xFFFFFFFFD (-3)	Intel(R) I211 Gigabit Network Connection
 (PCI) 0xFFFFFFFFE (-2)	Intel(R) USB 3.0 eXtensible Host Controller - 0100 (Microsoft)
 Memory	
 [000A0000 - 000BFFFF] Microsoft Basic Display Adapter	
 [000A0000 - 000BFFFF] PCI Express Root Complex	

# Appendix C

---

Electrical Specifications for I/O Ports



## C.1 Electrical Specifications for I/O Ports

I/O	Reference	Signal Name	Rate Output
VGA	CN3	VGA: +5V	+5V/0.5A
LVDS Port Inverter / Backlight Connector	CN5	VDD	+5V/2A or +12V/2A
Digital IO Port	CN8	D0~D3	+5V/(Open drain)
Mini-Card Slot	CN9	+3.3VSB +1.5V	+3.3V/1.1A +1.5V/0.375A
USB 3.0 Port 1 & 2	CN10	+5VSB	+5VSB/1A (per channel)
USB 2.0 Port 3	CN11	+5VSB	+5VSB/0.5A
+5V Output for SATA HDD	CN14	+5V	+5V/1A
LPC Port	CN18	+3.3V	+3.3V/0.5A
COM Port 2	CN23	+5V/+12V	+5V/1A or +12V/1A
Mini-Card Slot	CN24	+3.3VSB +1.5V	+3.3V/1.1A +1.5V/0.375A
LVDS Port	CN25	VCC	+3.3V/2A or +5V/2A

# Appendix D

---

Mating Connectors

## D.1 List of Mating Connectors and Cables

The table notes mating connectors and available cables.

Connector Label	Function	Mating Connector		Available Cable	Cable P/N
		Vendor	Model no		
CN1	Battery	Molex	51021-0200	Battery Cable	175011901M
CN2	DDR3 204PIN SKT	Transcend	TS1GSK64W6H-I		NA
CN3	VGA Connector	SUNBOX	VGA Cable		NA
CN4	DPCconnector	Molex	0687830007		NA
CN5	LVDS Port Inverter / Backlight Connector	JST	PHR-5		NA
CN7	LAN Connector	Molex	44915-0001		NA
CN8	Digital IO Port	JCTC	12003HO0-23NPX		NA
CN9	Mini-Card Slot (Full-Mini Card)	Transcend	TS64GMSM360I		NA
CN10	USB 3.0 Connector	UGREEN	US128		NA
CN11	USB Connector	Molex	51021-0500	USB Cable	1700050207
CN14	+5V Output for SATA HDD	JST	PHR-2	SATA power cable	1702150155

Connector Label	Function	Mating Connector		Available Cable	Cable P/N
		Vendor	Model no		
CN15	SATA Port	Molex	887505318	SATA Cable	NA
CN18	LPC Port	JST	SHR-12V-S-B	AAEON LPC Cable	1703120130
CN19	Front Panel Connector	LTT	H820-2x05	Front Panel Cable	1701100156
CN20	External +12V Input	Molex	19211-0003	Power cable	170204010R
CN21	Buzzer connector	Molex	51021-0200	Buzzer Cable	170302010C
CN22	BIO connector	Hirose	FX18-80S-0.8SV20		N/A
CN23	COM Port 1/2 & line out connector	Hirose	DF14-20S-1.25C	COM Port 1/2 & line out cable	1703200153
CN24	Mini-Card Slot (Half-Mini Card)	Intel	7260HMW		NA
CN25	LVDS Port	Hirose	DF14-20S-1.25C	LVDS cable	170430015A