

# PICO-BSW1

---

Pico-ITX Board

User's Manual 7<sup>th</sup> Ed

## Copyright Notice

---

This document is copyrighted, 2020. All rights are reserved. The original manufacturer reserves the right to make improvements to the products described in this manual at any time without notice.

No part of this manual may be reproduced, copied, translated, or transmitted in any form or by any means without the prior written permission of the original manufacturer. Information provided in this manual is intended to be accurate and reliable. However, the original manufacturer assumes no responsibility for its use, or for any infringements upon the rights of third parties that may result from its use.

The material in this document is for product information only and is subject to change without notice. While reasonable efforts have been made in the preparation of this document to assure its accuracy, AAEMON assumes no liabilities resulting from errors or omissions in this document, or from the use of the information contained herein.

AAEMON reserves the right to make changes in the product design without notice to its users.

## Acknowledgement

---

All other products' name or trademarks are properties of their respective owners.

- Microsoft Windows® is a registered trademark of Microsoft Corp.
- Intel®, Pentium® and Celeron® are registered trademarks of Intel Corporation
- Intel Atom™ is a registered trademark of Intel Corporation
- ITE is a trademark of Integrated Technology Express, Inc.
- IBM, PC/AT, PS/2, and VGA are trademarks of International Business Machines Corporation.

All other product names or trademarks are properties of their respective owners.

## Packing List

---

Before setting up your product, please make sure the following items have been shipped:

Item	Quantity
● PICO-BSW1	1
● Heat Spreader	1
● COM + Line-out Cable	1

If any of these items are missing or damaged, please contact your distributor or sales representative immediately.

## About this Document

---

This User's Manual contains all the essential information, such as detailed descriptions and explanations on the product's hardware and software features (if any), its specifications, dimensions, jumper/connector settings/definitions, and driver installation instructions (if any), to facilitate users in setting up their product.

Users may refer to the product page on [AAEON.com](http://AAEON.com) for the latest version of this document.

## Safety Precautions

---

Please read the following safety instructions carefully. It is advised that you keep this manual for future references

1. All cautions and warnings on the device should be noted.
2. Make sure the power source matches the power rating of the device.
3. Position the power cord so that people cannot step on it. Do not place anything over the power cord.
4. Always completely disconnect the power before working on the system's hardware.
5. No connections should be made when the system is powered as a sudden rush of power may damage sensitive electronic components.
6. If the device is not to be used for a long time, disconnect it from the power supply to avoid damage by transient over-voltage.
7. Always disconnect this device from any AC supply before cleaning.
8. While cleaning, use a damp cloth instead of liquid or spray detergents.
9. Make sure the device is installed near a power outlet and is easily accessible.
10. Keep this device away from humidity.
11. Place the device on a solid surface during installation to prevent falls
12. Do not cover the openings on the device to ensure optimal heat dissipation.
13. Watch out for high temperatures when the system is running.
14. Do not touch the heat sink or heat spreader when the system is running
15. Never pour any liquid into the openings. This could cause fire or electric shock.
16. As most electronic components are sensitive to static electrical charge, be sure to ground yourself to prevent static charge when installing the internal components. Use a grounding wrist strap and contain all electronic components in any static-shielded containers.

17. If any of the following situations arises, please contact our service personnel:
  - i. Damaged power cord or plug
  - ii. Liquid intrusion to the device
  - iii. Exposure to moisture
  - iv. Device is not working as expected or in a manner as described in this manual
  - v. The device is dropped or damaged
  - vi. Any obvious signs of damage displayed on the device
18. **DO NOT LEAVE THIS DEVICE IN AN UNCONTROLLED ENVIRONMENT WHERE THE STORAGE TEMPERATURE IS BELOW -20° C (-4°F) OR ABOVE 60°C (140°F) TO PREVENT DAMAGE.**

### **Warning!**



This device complies with Part 15 FCC Rules. Operation is subject to the following two conditions: (1) this device may not cause harmful interference, and (2) this device must accept any interference received including interference that may cause undesired operation.

### **Caution:**

*There is a danger of explosion if the battery is incorrectly replaced. Replace only with the same or equivalent type recommended by the manufacturer. Dispose of used batteries according to the manufacturer's instructions and your local government's recycling or disposal directives.*

### **Attention:**

*Il y a un risque d'explosion si la batterie est remplacée de façon incorrecte. Ne la remplacer qu'avec le même modèle ou équivalent recommandé par le constructeur. Recycler les batteries usées en accord avec les instructions du fabricant et les directives gouvernementales de recyclage.*



## China RoHS Requirements (CN)

产品中有毒有害物质或元素名称及含量

AAEON Main Board/ Daughter Board/ Backplane

部件名称	有毒有害物质或元素					
	铅 (Pb)	汞 (Hg)	镉 (Cd)	六价铬 (Cr(VI))	多溴联苯 (PBB)	多溴二苯醚 (PBDE)
印刷电路板 及其电子组件	○	○	○	○	○	○
外部信号 连接器及线材	○	○	○	○	○	○
<p>O: 表示该有毒有害物质在该部件所有均质材料中的含量均在 SJ/T 11363-2006 标准规定的限量要求以下。</p> <p>X: 表示该有毒有害物质至少在该部件的某一均质材料中的含量超出 SJ/T 11363-2006 标准规定的限量要求。</p> <p>备注: 此产品所标示之环保使用期限, 系指在一般正常使用状况下。</p>						

## China RoHS Requirement (EN)

Poisonous or Hazardous Substances or Elements in Products

AAEON Main Board/ Daughter Board/ Backplane

Component	Poisonous or Hazardous Substances or Elements					
	Lead (Pb)	Mercury (Hg)	Cadmium (Cd)	Hexavalent Chromium (Cr(VI))	Polybrominated Biphenyls (PBB)	Polybrominated Diphenyl Ethers (PBDE)
PCB & Other Components	○	○	○	○	○	○
Wires & Connectors for External Connections	○	○	○	○	○	○
<p>O: The quantity of poisonous or hazardous substances or elements found in each of the component's parts is below the SJ/T 11363-2006-stipulated requirement.</p> <p>X: The quantity of poisonous or hazardous substances or elements found in at least one of the component's parts is beyond the SJ/T 11363-2006-stipulated requirement.</p> <p><b>Note:</b> The Environment Friendly Use Period as labeled on this product is applicable under normal usage only</p>						

# Table of Contents

---

<b>Chapter 1 - Product Specifications</b> .....	<b>1</b>
1.1 Specifications .....	2
<b>Chapter 2 – Hardware Information</b> .....	<b>5</b>
2.1 Dimensions .....	6
2.2 Jumpers and Connectors.....	10
2.3 List of Jumpers .....	12
2.3.1 Auto Power Button and Clear CMOS Jumper (JP1).....	13
2.3.2 LVDS Port VDD and Backlight Inverter VCC Selection (JP2).....	13
2.3.3 LVDS Port Backlight Control Mode Selection (JP3) .....	13
2.3.4 COM2 Pin8 Function Selection (JP4).....	13
2.4 List of Connectors.....	14
2.4.1 Front Panel Connector (JP16) .....	15
2.4.2 USB Ports 0 and 1 (CN1).....	15
2.4.3 RTC Battery (CN3) .....	16
2.4.4 LVDS Port Inverter / Backlight Connector (CN5) .....	17
2.4.5 LVDS Port (CN6).....	17
2.4.6 BIO Connector (CN8) .....	19
2.4.7 LAN (RJ-45) Port (CN9).....	21
2.4.8 Mini-Card Slot (Half-Mini Card) (CN10) .....	21
2.4.9 SATA Port (CN11).....	24
2.4.10 +5V Output for SATA HDD (CN12) .....	25
2.4.11 MiniCard Slot (Full-Mini Card) (CN13).....	25
2.4.12 Digital IO Port (CN18) .....	27
2.4.13 LPC Port (CN20).....	28
2.4.14 COM Port & Audio I/O Connector (CN21).....	30
2.4.15 External +12V Input (CN22).....	32

2.4.16	HDMI Port (CN24) .....	32
<b>Chapter 3 - AMI BIOS Setup .....</b>		<b>34</b>
3.1	System Test and Initialization .....	35
3.2	AMI BIOS Setup .....	36
3.3	Setup Submenu: Main .....	37
3.4	Setup Submenu: Advanced.....	38
3.4.1	Advanced: CPU configuration .....	40
3.4.2	Advanced: SATA Configuration.....	42
3.4.3	Advanced: USB Configuration .....	43
3.4.4	Advanced: SIO Configuration .....	44
3.4.4.1	SIO Configuration: Serial Port 1 / 2 Configuration .....	45
3.4.5	Advanced: Hardware Monitor .....	47
3.4.6	Advanced: CSM Configuration .....	48
3.4.7	Advanced: Power Management.....	50
3.4.8	Advanced: Digital IO Port Configuration.....	52
3.5	Setup submenu: Chipset.....	53
3.5.1	Chipset: North Bridge.....	54
3.5.1.1	North Bridge: LVDS Panel Configuration .....	56
3.5.2	Chipset: South Bridge.....	58
3.6	Setup submenu: Security .....	59
3.7	Setup submenu: Boot.....	60
3.7.1	Boot: BBS Priorities.....	61
3.8	Setup submenu: Save & Exit .....	62
<b>Chapter 4 – Drivers Installation.....</b>		<b>63</b>
4.1	Driver Download/Installation .....	64
<b>Appendix A - I/O Information.....</b>		<b>66</b>
A.1	I/O Address Map .....	67
A.2	Memory Address Map .....	70

A.3	IRQ Mapping Chart.....	71
<b>Appendix B – Electrical Specifications for I/O Ports .....</b>		<b>82</b>
B.1	Electrical Specifications for I/O Ports.....	83
<b>Appendix C – Mating Connectors .....</b>		<b>84</b>
C.1	List of Mating Connectors and Cables.....	85

# Chapter 1

---

Product Specifications

## 1.1 Specifications

---

### System

Form Factor	Pico-ITX
CPU	Intel® N3160 Quad Core 1.6GHz (6W), Intel® N3060 Dual Core 1.6GHz (6W), Intel® X5-E8000 Quad Core 1.04GHz (5W)
CPU Frequency	Up to 2.24 GHz
Chipset	Intel® N3160 Quad Core 1.6GHz (6W), Intel® N3060 Dual Core 1.6GHz (6W), Intel® X5-E8000 Quad Core 1.04GHz (5W)
Memory Type	204-pin DDR3L SODIMM x 1, DDR3L 1600, Max. 8GB
Max. Memory Capacity	Up to 8GB
BIOS	AMI/SPI
Wake On LAN	Yes
Watchdog Timer	255 Levels
Power Requirement	+12V DC
Power Supply Type	AT/ATX (default) optional lockable connector
Power Consumption (Typical)	Intel® Pentium® N3160@ DDR3L-1600MHz 8GB, 0.91A@+12V
System Cooling	Heat-spreader; Heat-sink & cooler (optional)
Dimension	3.94" x 2.84" (100mm x 72mm)
Gross Weight	0.44 lb (0.2 kg)

## System

Operating Temperature	32°F ~ 140°F (0°C ~ 60°C)
Storage Temperature	-40°F ~ 176°F (-40°C ~ 80°C)
Operating Humidity	0% ~ 90% relative humidity, non-condensing
MTBF (Hours)	100,000
Certification	CE,FCC

## Display

Chipset	Intel® N3160 Quad Core 1.6GHz (6W) Intel® N3060 Dual Core 1.6GHz (6W) Intel® X5-E8000 Quad Core 1.04GHz (5W)
Resolution	LVDS (18/24bit 2CH) 1920 x 1200 HDMI up to 3840 x 2160 (4K) DDI (optional by BIO board)
LCD Interface	18/24-bit 2CH LVDS

## I/O

Storage/SSD	SATA 6.0Gb/s x 1, mSATA/MiniCard (Full size) x 1
Ethernet	Realtek RTL 8111E, 10/100/1000Base-TX, RJ-45 x 1
USB Port	USB 3.0 x 2 Rear I/O
Serial Port	COM1: RS-232 x 1, COM2: RS-232/422/485 x 1 (Ring/ +5V/ +12V)
Audio	Line-out x 1



**I/O**

DIO	4-bit (2-in, 2-out)
Expansion Slot	Mini Card(Half-size) x 1, BIO x 1, I2C x 1 or Smbus x 1, LPC
SIM	—
TPM	—
Touch	—

# Chapter 2

---

Hardware Information

## 2.1 Dimensions

### Component Side

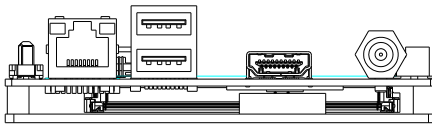
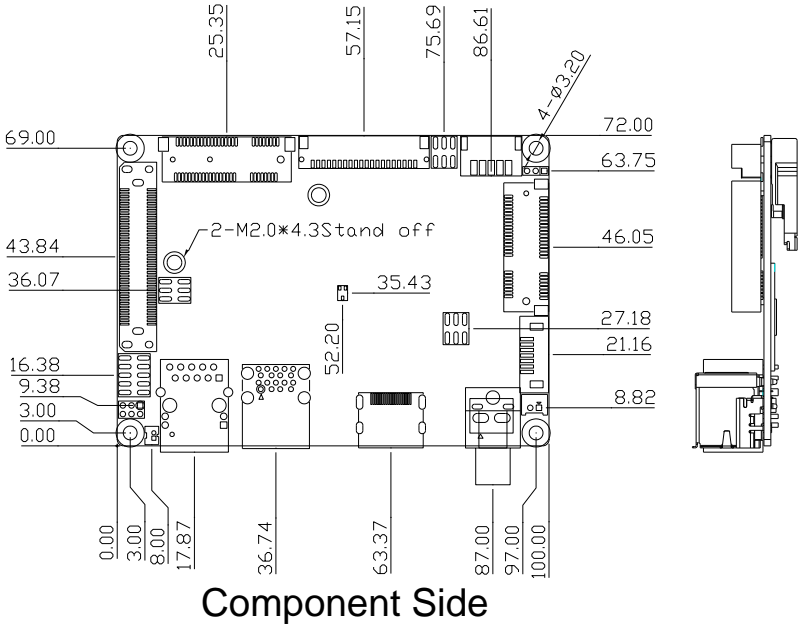

### Solder Side

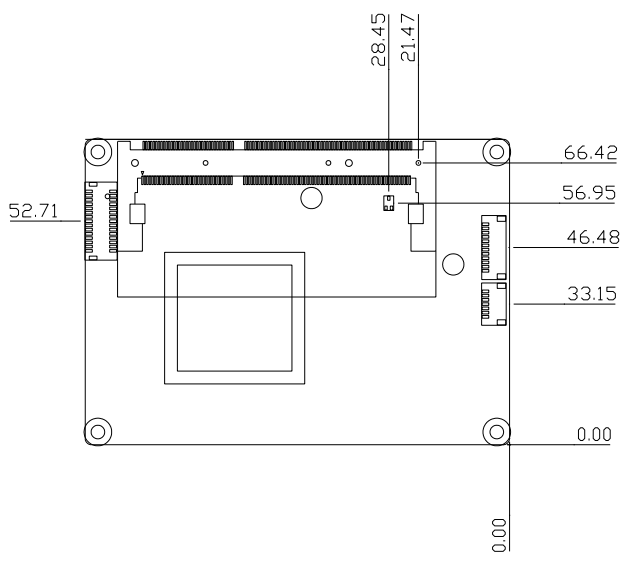

# Heat Spreader

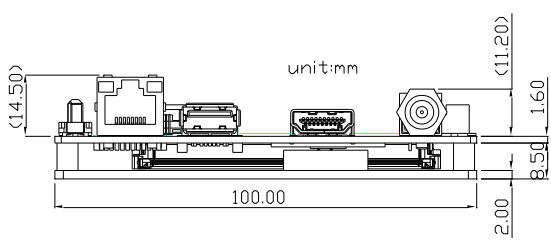
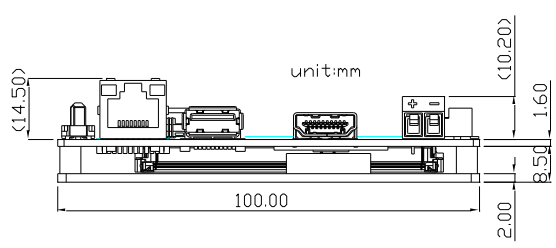
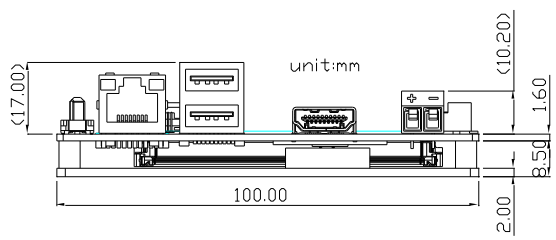
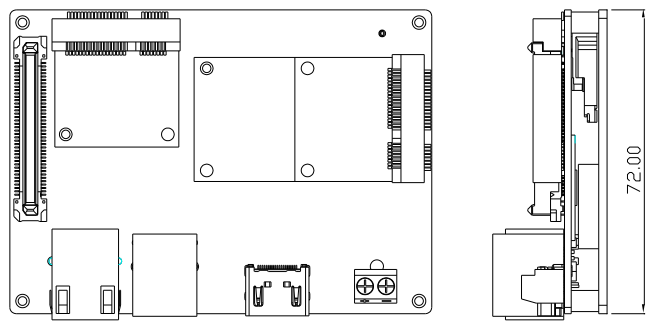

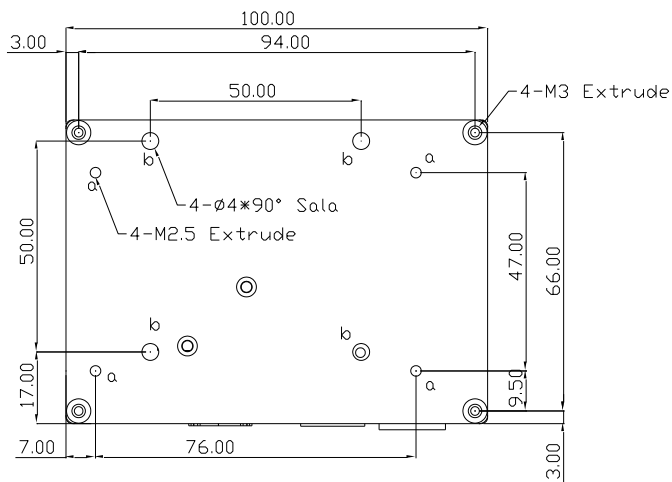
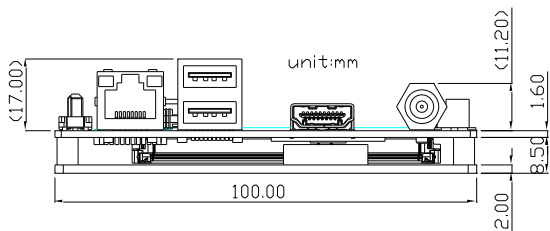

## 2.2 Jumpers and Connectors

### Component Side

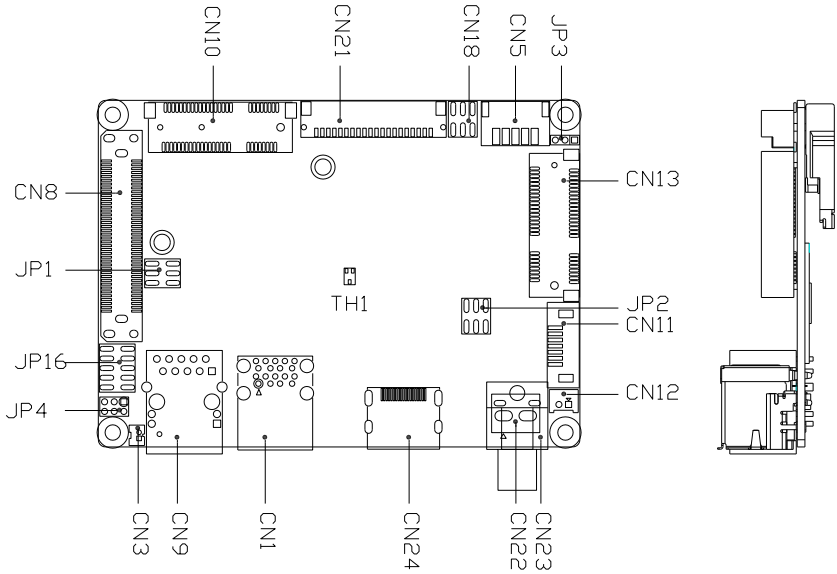

### Component Side

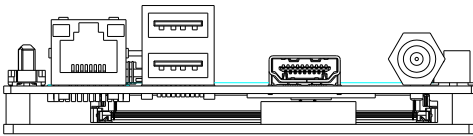

### Solder Side

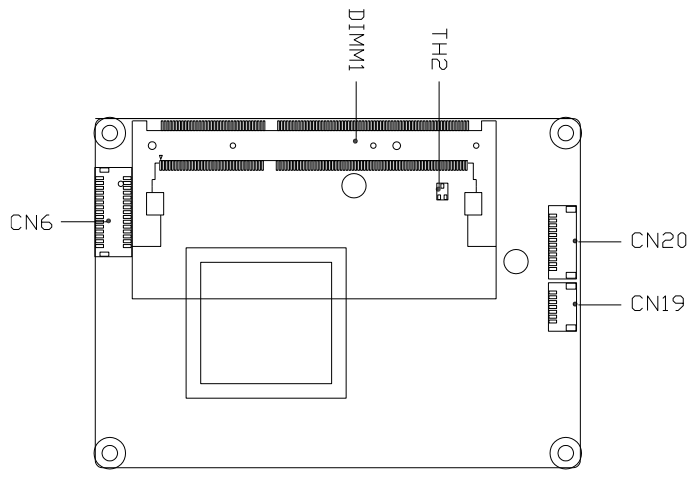



## 2.3 List of Jumpers

---

Please refer to the table below for all of the board's jumpers that you can configure for your application

Label	Function
JP1	Auto Power Button Selection and Clear CMOS Jumper
JP2	LVDS Port VDD and Backlight Inverter VCC Selection
JP3	LVDS Port Backlight Lightness Control Mode Selection
JP4	COM2 Pin8 Function Selection

### 2.3.1 Auto Power Button and Clear CMOS Jumper (JP1)

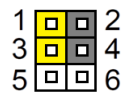

CMOS Normal (Default) (1-3)  
AT Mode (2-4)

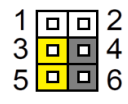

Clear CMOS (3-5)  
ATX Mode (4-6)

### 2.3.2 LVDS Port VDD and Backlight Inverter VCC Selection (JP2)

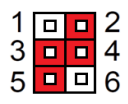

LVDS Port VDD +3.3V (Default) (3-5)  
Backlight Inverter VCC +5V (Default)  
(2-4)

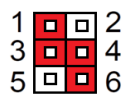

LVDS Port VDD +5V (1-3)  
Backlight Inverter VCC +12V (4-6)

### 2.3.3 LVDS Port Backlight Control Mode Selection (JP3)

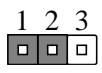

BKLT\_CTRL\_VR Mode(Default) (1-2)

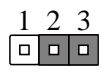

BKLT\_CTRL\_PWM Mode(2-3)

### 2.3.4 COM2 Pin8 Function Selection (JP4)

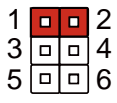

Reserved

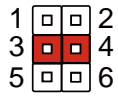

Ring(Default) (3-4)

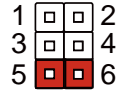

Reserved

## 2.4 List of Connectors

---

Please refer to the table below for all of the board's connectors that you can configure for your application

Label	Function
JP16	Front Panel Connector
CN1	USB Ports 0 and 1
CN3	RTC Battery
CN5	LVDS Port Inverter / Backlight Connector
CN6	LVDS Port
CN8	BIO (Board-Board Connector)
CN9	LAN (RJ-45)
CN10	Mini-Card Slot (Half-Mini Card)
CN11	SATA Port
CN12	+5V Output for SATA HDD
CN13	Mini-Card Slot (Full-Mini Card)
CN18	4bit DIO
CN20	LPC Port
CN21	COM Port (COM1 and COM2) and Audio I/O Port
CN22	External +12V Input
CN24	HDMI Port
TH1	Thermal Sensor (Near CPU)
TH2	Thermal Sensor (Near PCB)

### 2.4.1 Front Panel Connector (JP16)

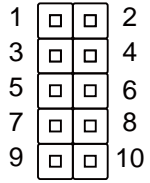

Pin	Pin Name	Pin	Pin Name
Pin 1	PWR_BTN-	Pin 2	PWR_BTN+
Pin 3	HDD_LED-	Pin 4	HDD_LED+
Pin 5	SPEAKER-	Pin 6	SPEAKER+
Pin 7	PWR_LED-	Pin 8	PWR_LED+
Pin 9	H/W RESET-	Pin 10	H/W RESET+

### 2.4.2 USB Ports 0 and 1 (CN1)

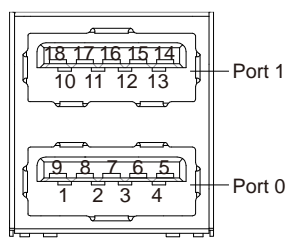

Pin	Pin Name	Signal Type	Signal level
1	+5VSB	PWR	+5V
2	USB0_D-	DIFF	
3	USB0_D+	DIFF	

Pin	Pin Name	Signal Type	Signal level
4	GND	GND	
5	USB0_SSRX-	DIFF	
6	USB0_SSRX+	DIFF	
7	GND	GND	
8	USB0_SSTX-	DIFF	
9	USB0_SSTX+	DIFF	
10	+5VSB	PWR	+5V
11	USB1_D-	DIFF	
12	USB1_D+	DIFF	
13	GND	GND	
14	USB1_SSRX-		
15	USB1_SSRX+		
16	GND	GND	
17	USB1_SSTX-		
18	USB1_SSTX+		

### 2.4.3 RTC Battery (CN3)

Pin	Pin Name	Signal Type	Signal level
1	+3.3V	PWR	3.3V
2	GND	GND	

### 2.4.4 LVDS Port Inverter / Backlight Connector (CN5)

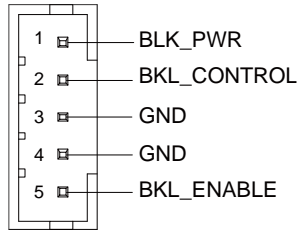

Pin	Pin Name	Signal Type	Signal Level
1	BKL_PWR	PWR	+5V / +12V
2	BKL_CONTROL	OUT	
3	GND	GND	
4	GND	GND	
5	BKL_ENABLE	OUT	+3.3V

### 2.4.5 LVDS Port (CN6)

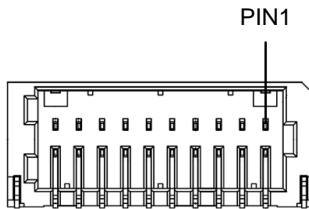

Pin	Pin Name	Signal Type	Signal Level
1	BKL_ENABLE	OUT	
2	BKL_CONTROL	OUT	
3	LCD_PWR	PWR	+3.3V/+5V

Pin	Pin Name	Signal Type	Signal Level
4	GND	GND	
5	LVDS_A_CLK-	DIFF	
6	LVDS_A_CLK+	DIFF	
7	LCD_PWR	PWR	+3.3V/+5V
8	GND	GND	
9	LVDS_DA0-	DIFF	
10	LVDS_DA0+	DIFF	
11	LVDS_DA1-	DIFF	
12	LVDS_DA1+	DIFF	
13	LVDS_DA2-	DIFF	
14	LVDS_DA2+	DIFF	
15	LVDS_DA3-	DIFF	
16	LVDS_DA3+	DIFF	
17	DDC_DATA	I/O	+3.3V
18	DDC_CLK	I/O	+3.3V
19	LVDS_DB0-	DIFF	
20	LVDS_DB0+	DIFF	
21	LVDS_DB1-	DIFF	
22	LVDS_DB1+	DIFF	
23	LVDS_DB2-	DIFF	

Pin	Pin Name	Signal Type	Signal Level
24	LVDS_DB2+	DIFF	
25	LVDS_DB3-	DIFF	
26	LVDS_DB3+	DIFF	
27	LCD_PWR	PWR	+3.3V/+5V
28	GND	GND	
29	LVDS_B_CLK-	DIFF	
30	LVDS_B_CLK+	DIFF	

#### 2.4.6 BIO Connector (CN8)

Pin	Pin Name	Pin	Pin Name
1		2	
3		4	
5		6	
7		8	
9		10	
11		12	
13		14	
15		16	
17	DDI_DDC_CLK	18	DDI_DDC_DAT
19		20	
21		22	
23		24	
25		26	



Pin	Pin Name	Pin	Pin Name
27		28	DP_TXN1
29	DP_TXN0	30	DP_TXP1
31	DP_TXP0	32	
33		34	DP_TXN3
35	DP_TXN2	36	DP_TXP3
37	DP_TXP2	38	
39		40	DP_HPLG_DET
41	DP_AUXN	42	
43	DP_AUXP	44	USB_TXN
45		46	USB_TXP
47		48	
49		50	USB_RXN
51		52	USB_RXP
53		54	
55		56	
57		58	
59		60	
61		62	
63		64	
65		66	
67		68	
69		70	NC
71		72	
73		74	
75		76	
77		78	

Pin	Pin Name	Pin	Pin Name
79	NC	80	

### 2.4.7 LAN (RJ-45) Port (CN9)

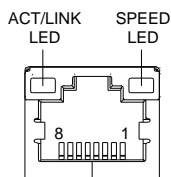

Pin	Pin Name	Signal Type	Signal Level
1	MDI0+	DIFF	
2	MDI0-	DIFF	
3	MDI1+	DIFF	
4	MDI2+	DIFF	
5	MDI2-	DIFF	
6	MDI1-	DIFF	
7	MDI3+	DIFF	
8	MDI3-	DIFF	

### 2.4.8 Mini-Card Slot (Half-Mini Card) (CN10)

Pin	Pin Name	Signal Type	Signal Level
1	PCIE_WAKE#	IN	
2	+3.3VSB	PWR	+3.3V
3	NC		
4	GND	GND	

Pin	Pin Name	Signal Type	Signal Level
5	NC		
6	+1.5V	PWR	+1.5V
7	PCIE_CLK_REQ#	IN	
8	NC	PWR	
9	GND	GND	
10	NC	I/O	
11	PCIE_REF_CLK-	DIFF	
12	NC	IN	
13	PCIE_REF_CLK+	DIFF	
14	NC		
15	GND	GND	
16	NC	PWR	
17	NC		
18	GND	GND	
19	NC		
20	W_DISABLE#	OUT	+3.3V
21	GND	GND	
22	PCIE_RST#	OUT	+3.3V
23	PCIE_RX-	DIFF	
24	+3.3VSB	PWR	+3.3V

Pin	Pin Name	Signal Type	Signal Level
25	PCIE_RX+	DIFF	
26	GND	GND	
27	GND	GND	
28	+1.5V	PWR	+1.5V
29	GND	GND	
30	SMB_CLK	I/O	+3.3V
31	PCIE_TX-	DIFF	
32	SMB_DATA	I/O	+3.3V
33	PCIE_TX+	DIFF	
34	GND	GND	
35	GND	GND	
36	USB_D-	DIFF	
37	GND	GND	
38	USB_D+	DIFF	
39	+3.3VSB	PWR	+3.3V
40	GND	GND	
41	+3.3VSB	PWR	+3.3V
42	NC		
43	GND	GND	
44	NC		

Pin	Pin Name	Signal Type	Signal Level
45	NC		
46	NC		
47	NC		
48	+1.5V	PWR	+1.5V
49	NC		
50	GND	GND	
51	NC		
52	+3.3VSB	PWR	+3.3V

### 2.4.9 SATA Port (CN11)

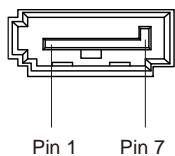

Pin	Pin Name	Signal Type	Signal Level
1	GND	GND	
2	SATA_TX1+	DIFF	
3	SATA_TX1-	DIFF	
4	GND	GND	
5	SATA_RX1-	DIFF	
6	SATA_RX1+	DIFF	
7	GND	GND	

## 2.4.10 +5V Output for SATA HDD (CN12)

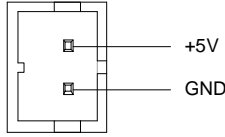

Pin	Pin Name	Signal Type	Signal Level
1	+5V	PWR	+5V
2	GND	GND	

## 2.4.11 MiniCard Slot (Full-Mini Card) (CN13)

Pin	Pin Name	Signal Type	Signal level
1	PCIE_WAKE#	IN	
2	+3.3VSB/+3.3V	PWR	+3.3V
3	NC		
4	GND	GND	
5	NC		
6	+1.5V	PWR	+1.5V
7	PCIE_CLK_REQ#	IN	
8	UIM_PWR	PWR	
9	GND	GND	
10	UIM_DATA	I/O	
11	PCIE_REF_CLK-	DIFF	

Pin	Pin Name	Signal Type	Signal level
12	UIM_CLK	IN	
13	PCIE_REF_CLK+	DIFF	
14	UIM_RST	IN	
15	GND	GND	
16	UIM_VPP	PWR	
17	NC		
18	GND	GND	
19	NC		
20	W_DISABLE#	OUT	+3.3V
21	GND	GND	
22	PCIE_RST#	OUT	+3.3V
23	PCIE_RX-/mSATARX+	DIFF	
24	+3.3VSB/+3.3V	PWR	+3.3V
25	PCIE_RX+/mSATARX-	DIFF	
26	GND	GND	
27	GND	GND	
28	+1.5V	PWR	+1.5V
29	GND	GND	
30	SMB_CLK	I/O	+3.3V
31	PCIE_TX-/mSATATX-	DIFF	
32	SMB_DATA	I/O	+3.3V

Pin	Pin Name	Signal Type	Signal level
33	PCIE_TX+/mSATATX+	DIFF	
34	GND	GND	
35	GND	GND	
36	USB_D-	DIFF	
37	GND	GND	
38	USB_D+	DIFF	
39	+3.3VSB/+3.3V	PWR	+3.3V
40	GND	GND	
41	+3.3VSB/+3.3V	PWR	+3.3V
42	NC		
43	GND	GND	
44	NC		
45	NC		
46	NC		
47	NC		
48	+1.5V	PWR	+1.5V
49	NC		
50	GND	GND	
51	NC		
52	+3.3VSB/+3.3V	PWR	+3.3V

#### 2.4.12 Digital IO Port (CN18)



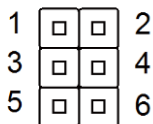

Pin	Pin Name	Signal Type	Signal Level
1	+5V	PWR	+5V
2	DIO0	I/O	+5V
3	DIO1	I/O	+5V
4	DIO2	I/O	+5V
5	DIO3	I/O	+5V
6	GND	GND	

### 2.4.13 LPC Port (CN20)

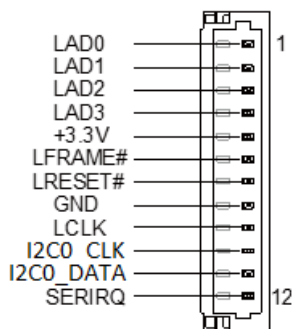

Pin	Pin Name	Signal Type	Signal Level
1	LAD0	I/O	+3.3V
2	LAD1	I/O	+3.3V
3	LAD2	I/O	+3.3V

Pin	Pin Name	Signal Type	Signal Level
4	LAD3	I/O	+3.3V
5	+3.3V	PWR	+3.3V
6	LFRAME#	IN	
7	LRESET#	OUT	+3.3V
8	GND	GND	
9	LCLK	OUT	
10	I2C0_CLK (Default)/SMBUS_CLK(Option)	I/O	+3.3V
11	I2C_DATA (Default) /SMBUS_DATA(Option)	I/O	+3.3V
12	SERIRQ	I/O	+3.3V

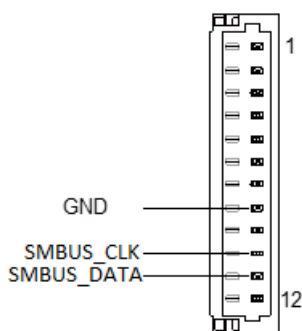

## SMBUS (Optional)

Pin	Pin Name	Signal Type	Signal Level
8	GND	GND	
10	SMBUS_CLK	I/O	+3.3V
11	SMBUS_DATA	I/O	+3.3V

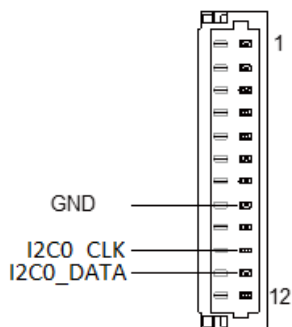

## I2C (Optional)

Pin	Pin Name	Signal Type	Signal Level
8	GND	GND	
10	I2C0_CLK	I/O	+3.3V
11	I2C0_DATA	I/O	+3.3V

## 2.4.14 COM Port &amp; Audio I/O Connector (CN21)

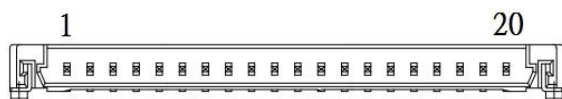

Pin	Pin Name	Signal Type	Signal Level
1	DCDB	IN	
2	DSRB	IN	
3	RXB	IN	
4	RTSB	OUT	±9V
5	TXB	OUT	±9V

Pin	Pin Name	Signal Type	Signal Level
6	CTSB	IN	
7	DTRB	OUT	±9V
8	RIB	IN	
9	DCDA	IN	
10	DSRA	IN	
11	RXA	IN	
12	RTSA	OUT	±9V
13	TXA	OUT	±9V
14	CTSA	IN	
15	DTRA	OUT	±9V
16	RIA	IN	
17	GND	GND	
18	AGND	GND	
19	LOUT_R	I/O	
20	LOUT_L	I/O	

### 2.4.15 External +12V Input (CN22)

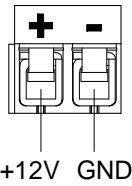

Pin	Pin Name	Signal Type	Signal Level
1	+12V	PWR	+12V
2	GND	GND	

### 2.4.16 HDMI Port (CN24)

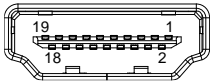

Pin	Pin Name	Signal Type	Signal Level
1	TMDS_DAT2+	DIFF	
2	GND	GND	
3	TMDS_DAT2-	DIFF	
4	TMDS_DAT1+	DIFF	
5	GND	GND	
6	TMDS_DAT1-	DIFF	
7	TMDS_DAT0+	DIFF	
8	GND	GND	
9	TMDS_DAT0-	DIFF	
10	TMDS_CLK+	DIFF	

Pin	Pin Name	Signal Type	Signal Level
11	GND	GND	
12	TMDS_CLK-	DIFF	
13	NC		
14	NC		
15	DDC_CLK	I/O	+5V
16	DDC_DATA	I/O	+5V
17	GND	GND	
18	+5V	I/O	+5V
19	HPLG_DETECT	IN	

# Chapter 3

---

AMI BIOS Setup

## 3.1 System Test and Initialization

---

The board uses certain routines to perform testing and initialization. If an error, fatal or non-fatal, is encountered, a few short beeps or an error message will be outputted. The board can usually continue the boot up sequence with non-fatal errors.

The system configuration verification routines check the current system configuration against the values stored in the CMOS memory. If they do not match, an error message will be outputted, in which case you will need to run the BIOS setup program to set the configuration information in memory.

There are three situations in which you will need to change the CMOS settings:

- You are starting your system for the first time
- You have changed your system's hardware
- The CMOS memory has lost power and the configuration information is erased

The system's CMOS memory uses a backup battery for data retention, which is to be replaced once emptied.



## 3.2 AMI BIOS Setup

---

The AMI BIOS ROM has a pre-installed Setup program that allows users to modify basic system configurations, which is stored in the battery-backed CMOS RAM and BIOS NVRAM so that the information is retained when the power is turned off.

To enter BIOS Setup, press <Del> or <F2> immediately while your computer is powering up.

The function for each interface can be found below.

**Main** – Date and time can be set here. Press <Tab> to switch between date elements

**Advanced** – Enable/ Disable boot option for legacy network devices

**Chipset** – For hosting bridge parameters

**Boot** – Enable/ Disable quiet Boot Option

**Security** – The setup administrator password can be set here

**Save & Exit** – Save your changes and exit the program

### 3.3 Setup Submenu: Main

Press "Delete" to enter Setup

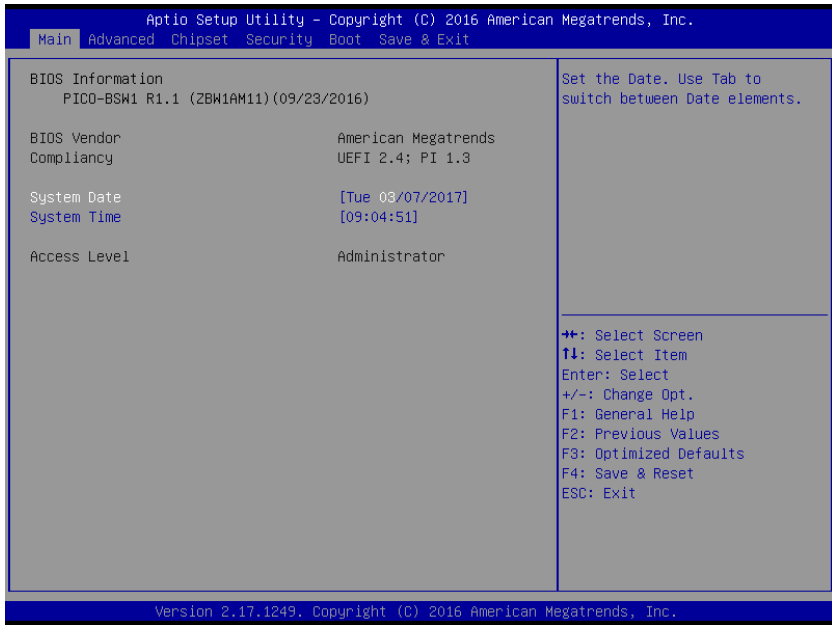

Options summary: (*default setting*)

System Date	Day MM:DD:YYYY	
Change the month, year and century. The 'Day' is changed automatically.		
System Time	HH : MM : SS	
Change the clock of the system.		

### 3.4 Setup Submenu: Advanced

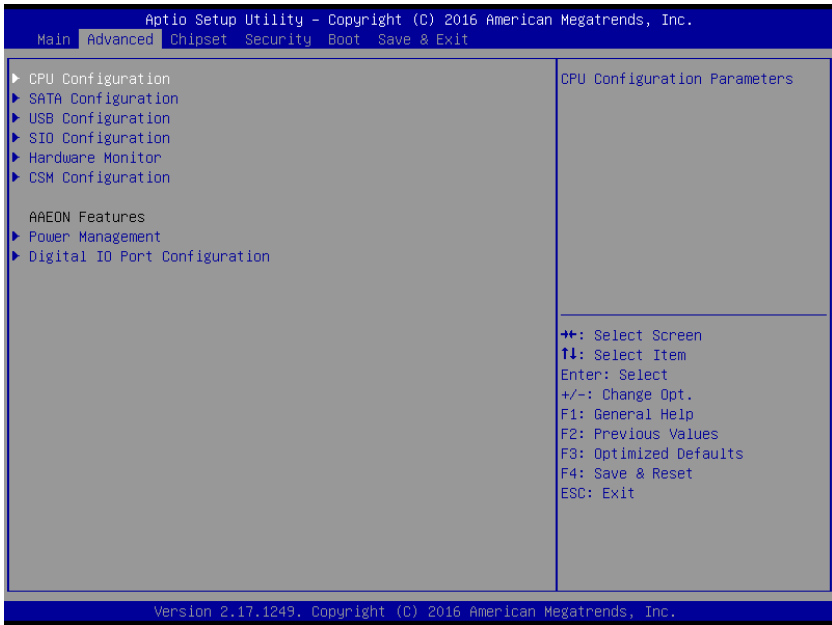

Options summary: (*default setting*)

CPU Configuration		
CPU Configuration Parameters		
SATA Configuration		
SATA Device Configuration		
USB Configuration		
USB Configuration Parameters		
SIO Configuration		
SIO Chip configuration .Enable or Disable SIO Logical Devices, Resources and Features settings, etc.		
Hardware Monitor		

Power Management		
System ACPI/Power Mode/Wake Event Configuration		
Digital IO Port Configuration		
Set Input/Output of digital Port Configuration		

### 3.4.1 Advanced: CPU configuration

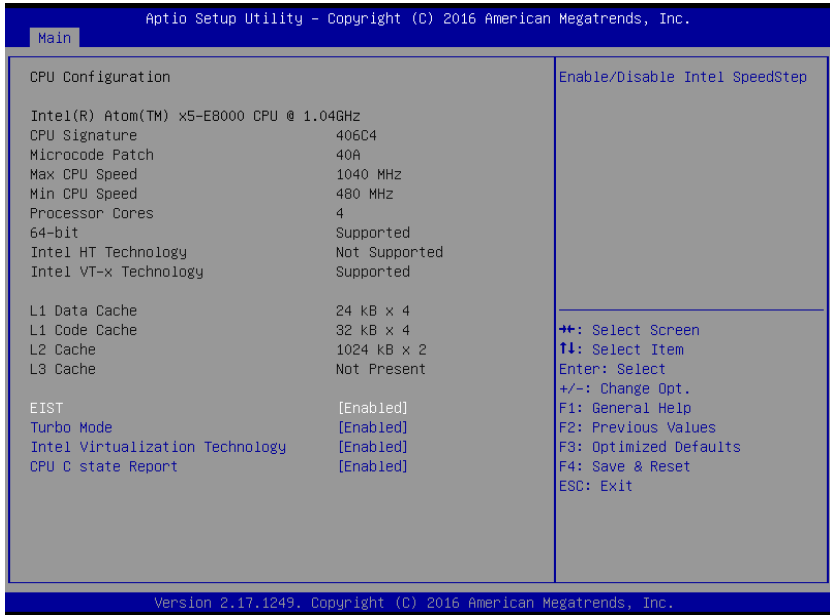

Options summary: (*default setting*)

EIST	<i>Enabled</i>	
	Disabled	
Enable/Disable Intel SpeedStep feature.		
Turbo Mode	<i>Enabled</i>	
	Disabled	
Turbo mode.		

Intel Virtualization Technology	<i>Enabled</i>	
	Disabled	
When enabled, a VMM can utilize the additional hardware capabilities provide by Vanderpool Technology		
CPU C state Report	<i>Enabled</i>	
	Disabled	
Enable/Disable CPU C state report to OS.		

### 3.4.2 Advanced: SATA Configuration

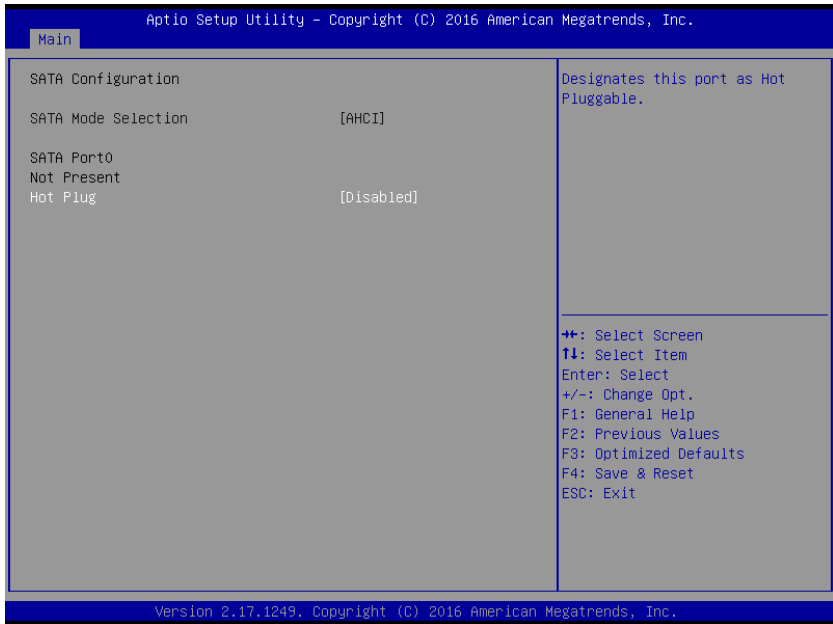

Options summary: (*default setting*)

SATA Mode	<i>AHCI Mode</i>	
Only AHCI mode support on this platform		
SATA Port0/Port1	Enabled	
HotPlug	<i>Disabled</i>	
Enabled/Disabled SATA Port0/Port1 HotPlug function		

### 3.4.3 Advanced: USB Configuration

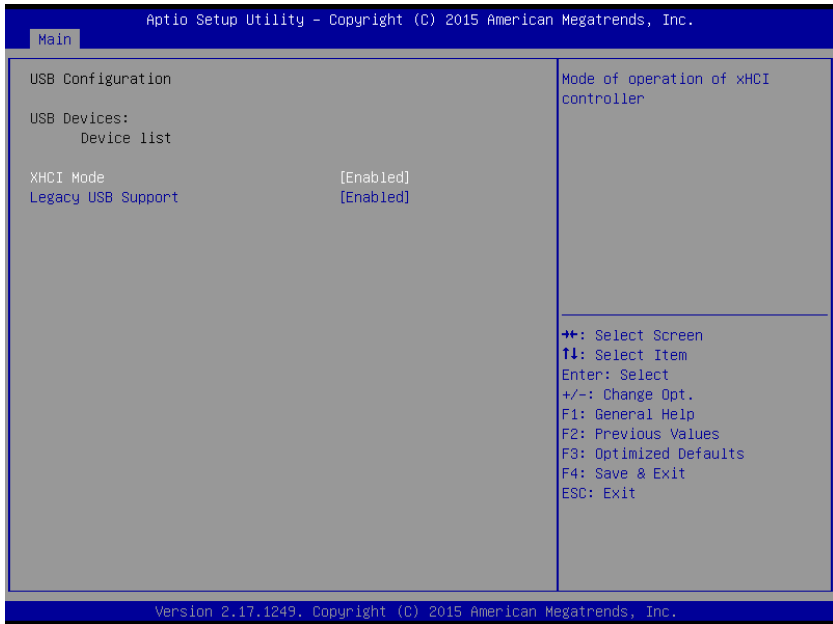

Options summary: (*default setting*)

XHCI Mode	<i>Enabled</i>	
	Disabled	
Mode of operation of xHCI controller		
Legacy USB Support	<i>Enabled</i>	
	Disabled	
	Auto	
<p>Enables BIOS Support for Legacy USB Support. When enabled, USB can be functional in legacy environment like DOS. AUTO option disables legacy support if no USB devices are connected. DISABLE option will keep USB devices available only for EFI application</p>		



### 3.4.4 Advanced: SIO Configuration

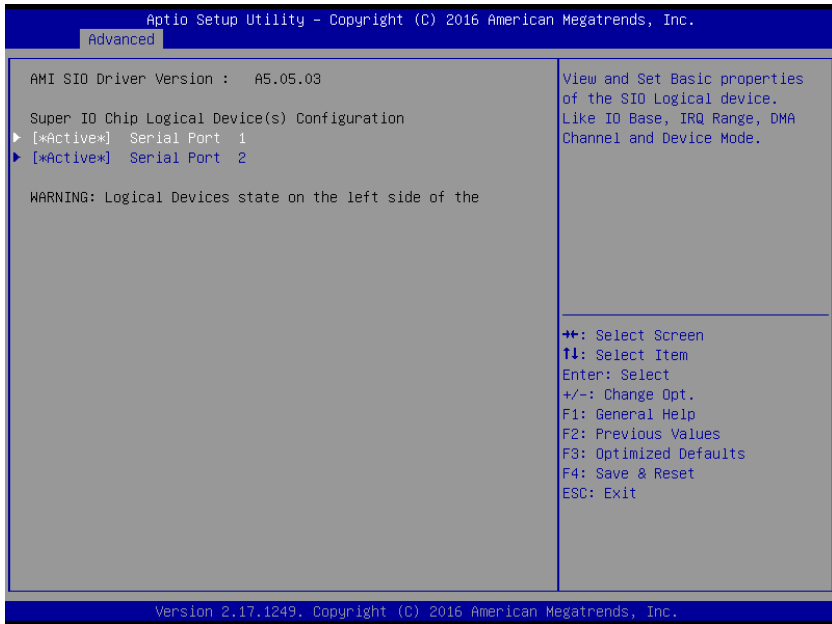

Options summary: (*default setting*)

Serial Port 1/2 Configuration		
View and Set Basic properties of the SIO Logical device. Like IO Base , IRQ Range , DMA Channel and Device Mode.		

### 3.4.4.1 SIO Configuration: Serial Port 1 / 2 Configuration

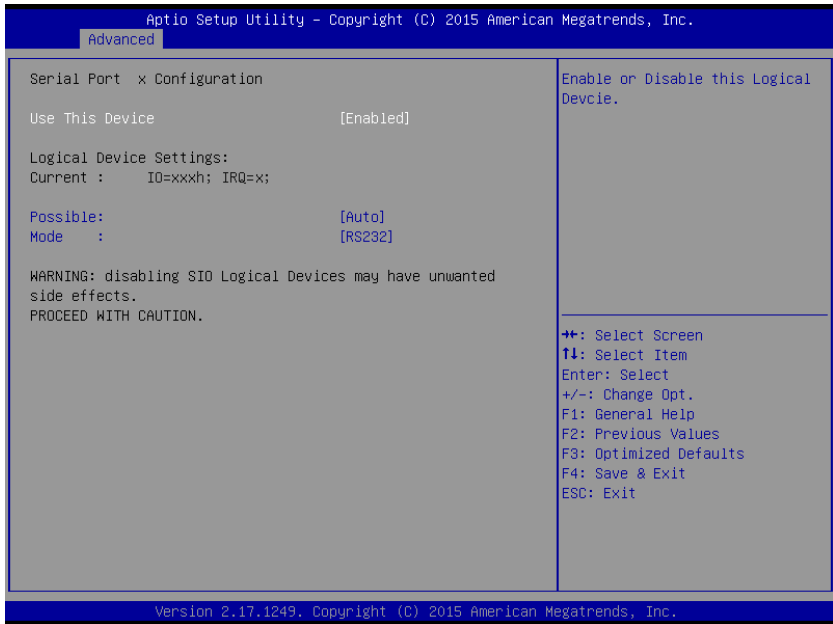

Options summary: (*default setting*)

Use This Device	Disabled	
	<i>Enabled</i>	
En/Disable specified serial port.		
Change Settings (COM1)	<i>Use Automatic Settings</i>	
	IO=3F8h; IRQ=4;	
	IO=2F8h; IRQ=3;	
Change Settings (COM2)	<i>Use Automatic Settings</i>	
	IO=2F8h; IRQ=3;	
	IO=3F8h; IRQ=4;	
Select a resource setting for Super IO device.		
Mode	<i>RS232</i>	

	RS422	
	RS485	
Configure COM operated as RS232, RS422 or RS485. Only COM2 support this function.		

### 3.4.5 Advanced: Hardware Monitor

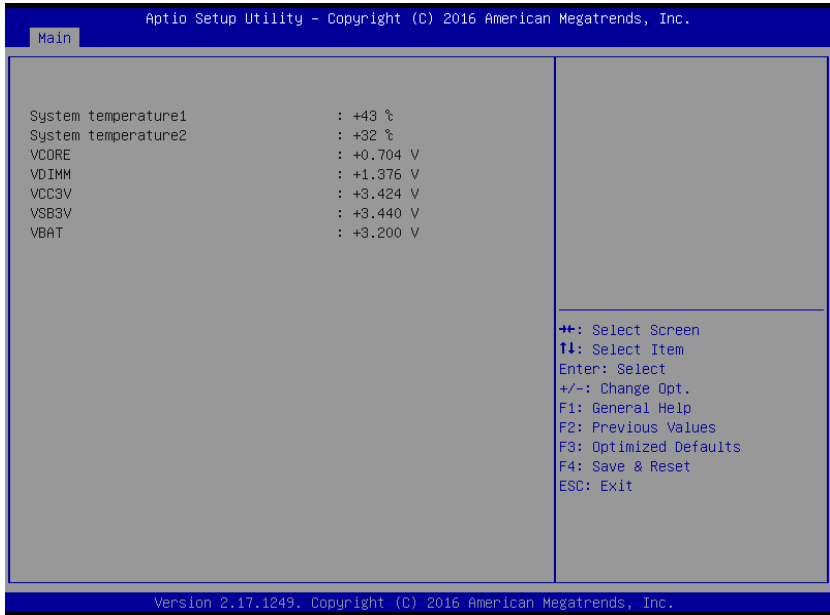

### 3.4.6 Advanced: CSM Configuration

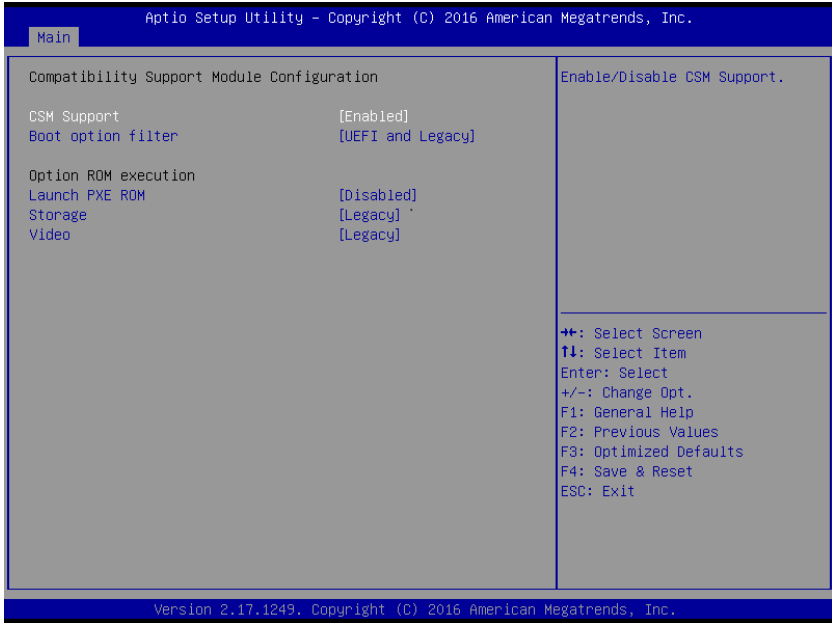

Options summary: (*default setting*)

CSM Support	<i>Enabled</i>	
	Disable	
Enable/Disable CSM Support.		
Boot option filter	<i>UEFI and Legacy</i>	
	Legacy only	
	UEFI only	
This option controls Legacy/UEFI ROMs priority		
Launch PXE ROM	<i>Disabled</i>	
	Enabled	
Controls the execution of UEFI and Legacy PXE OpROM		

Storage	Do not launch	
	UEFI	
	<i>Legacy</i>	
Controls the execution of UEFI and Legacy Storage OpROM.		
Video	Do not launch	
	UEFI	
	<i>Legacy</i>	
Controls the execution of UEFI and Legacy Video OpROM.		

### 3.4.7 Advanced: Power Management

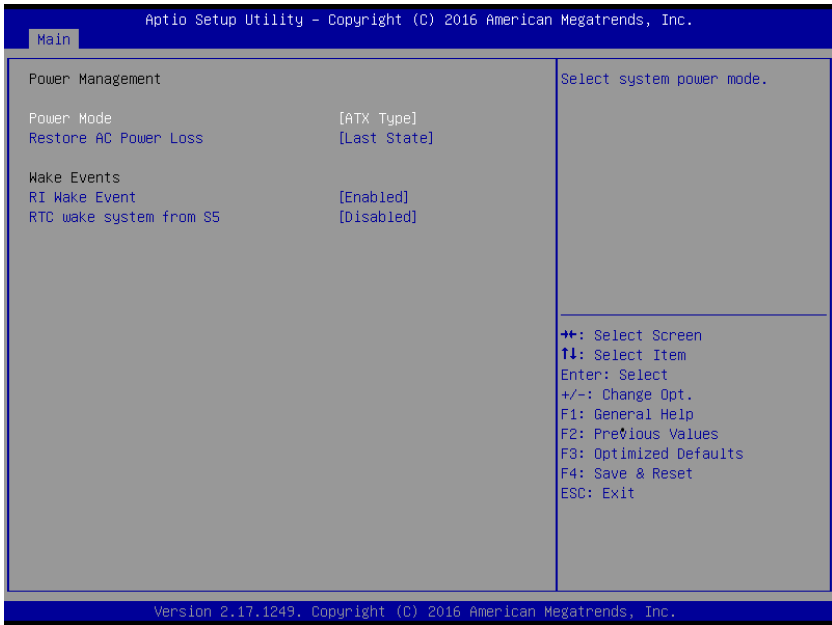

Options summary: (*default setting*)

Power Mode	<i>ATX Type</i>	
	AT Type	
Select system power mode		
Restore AC Power Loss	Power Off	
	Power on	
	<i>Late State</i>	
RI Wake Event	<i>Enabled</i>	
	Disabled	
Enabled or disabled wake on ring function.		

RTC wake system from S5	<i>Disabled</i>	
	Fixed Time	
	Dynamic Time	
Enable system to wake from S5 using RTC alarm.		
Wake up day	0-31	
Select 0 for daily system wake up 1-31 for which day of the month that you would like the system to wake up		
Wake up hour	0-23	
Wake up minute	0-59	
Wake up second	0-59	
Wake up minute increase	1-5	



### 3.4.8 Advanced: Digital IO Port Configuration

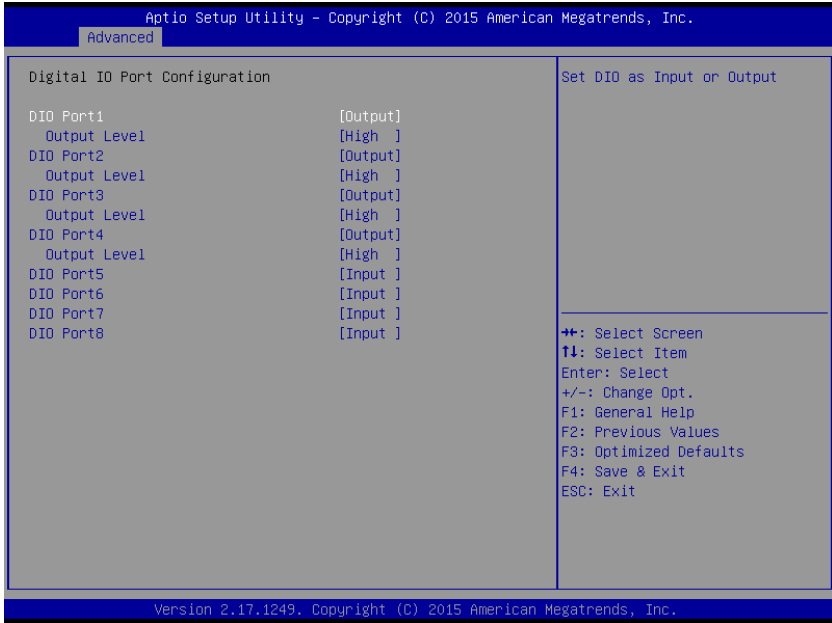

Options summary: (*default setting*)

DIO Port1/2/3/4	Input	
	<i>Output</i>	
Set DIO Port1/2/3/4 as Input or Output		
DIO Port5/6/7/8	<i>Input</i>	
	Output	
Set GPIO3/GPIO4 as Input or Output		
Output Level	Hi	
	<i>Low</i>	
Set GPIO Level when used as Output		

### 3.5 Setup submenu: Chipset

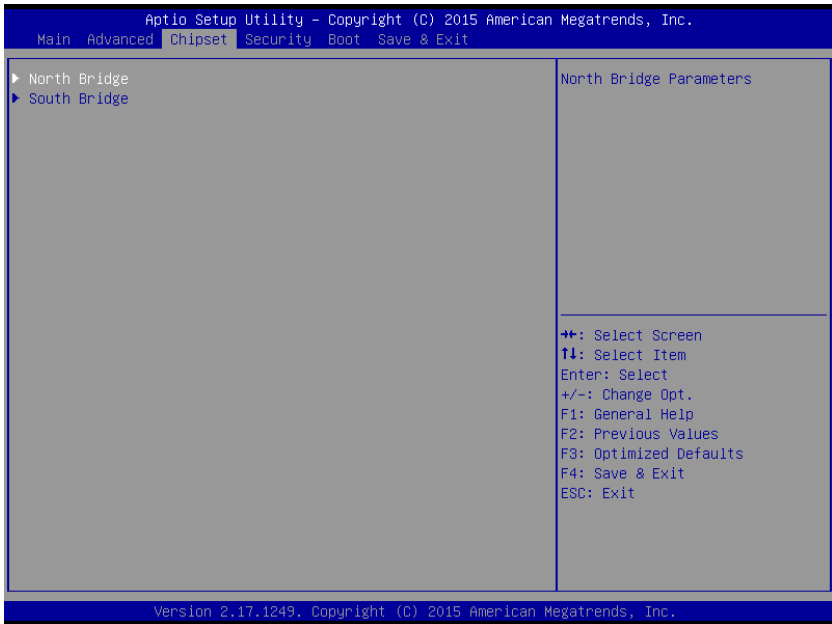

Options summary: (*default setting*)

North Bridge		
North Bridge Parameters.		
South Bridge		
South Bridge Parameters		

### 3.5.1 Chipset: North Bridge

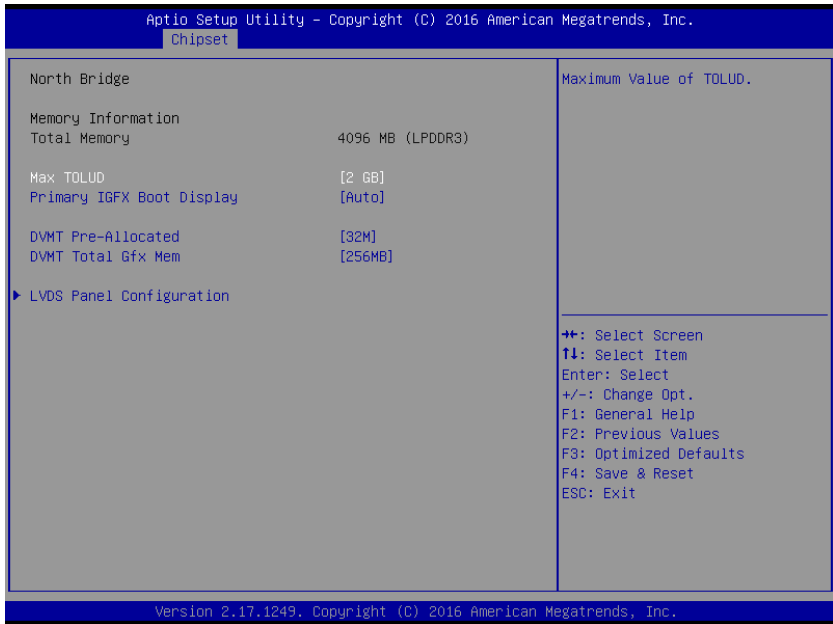

Options summary: (*default setting*)

Max TOLUD	<b>2GB</b>	Maximum Value of TOLUD.
	2.25 GB	
	2.5 GB	
	2.75 GB	
Maximum Value of TOLUD.		

Primary Boot Display	<b>Auto</b>	
	Extension Board	
	LVDS	
	HDMI	
<p>Select the Video Device which will be activated during POST. This has no effect if external graphics present.</p> <p>Secondary boot display Selection will appear based on your selection.</p> <p>VGA mode will be supported only on primary display.</p>		
Secondary Boot Display	<b>Disabled</b>	
	Extension Board	
	LVDS	
	HDMI	
Select Primary boot display device		
DVMT Pre-Allocated	<b>32MB</b>	
	32MB~512MB	
Select DVMT 5.0 Pre-Allocated (Fixed) Graphics Memory size used by the Internal Graphics Device.		
DVMT Total Gfx Mem	128MB	
	<b>256MB</b>	
	Max	
Select DVMT 5.0 Total Graphic Memory size used by the IGD.		
LVDS Panel Configuration		
Config LVDS panel parameters.		

### 3.5.1.1 North Bridge: LVDS Panel Configuration

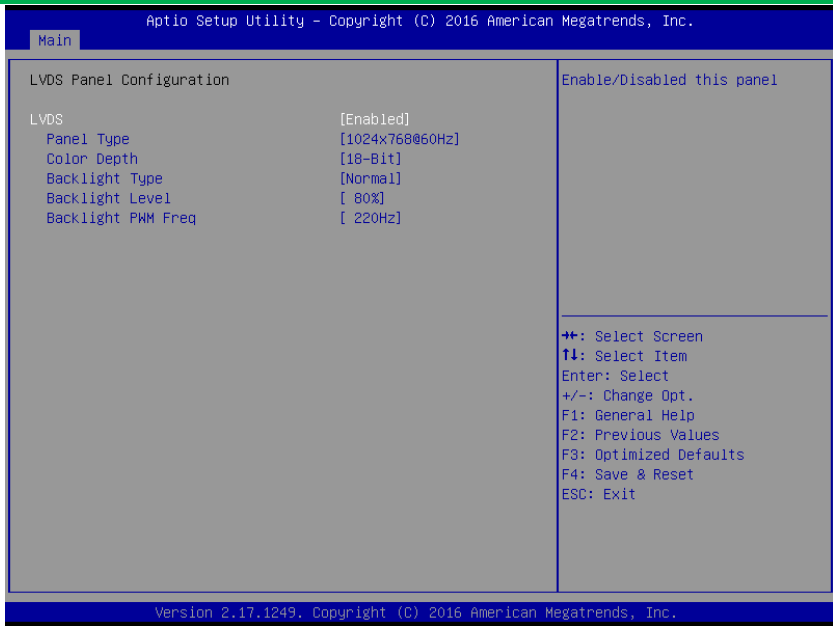

Options summary: (*default setting*)

LVDS	Disabled	
	<b>Enabled</b>	
Enable or Disable LVDS interface		
Panel Type	640x480	
	800x480	
	800x600	
	1024x600	
	<b>1024x768</b>	
	1280x768	
	1280x800	
	1280x1024	
	1366x768	

	1440x900	
	1600x1200	
	1920x1080	
	1920x1200	
Select panel resolution.		
Color Depth	<b>18-Bit</b>	
	24-Bit	
	36-Bit	
	48-Bit	
Select color depth of the panel		
Backlight Type	Inverted	
	<b>Normal</b>	
Select Backlight control type.		
Inverted: Brightest for low PWM duty cycle and low voltage.		
Normal: Brightest for high PWM duty cycle and high voltage.		
Backlight Level	100%	
	90%	
	<b>80%</b>	
	70%	
	60%	
	50%	
	40%	
	30%	
	20%	
	10%	
	0%	
Select Backlight Level		

### 3.5.2 Chipset: South Bridge

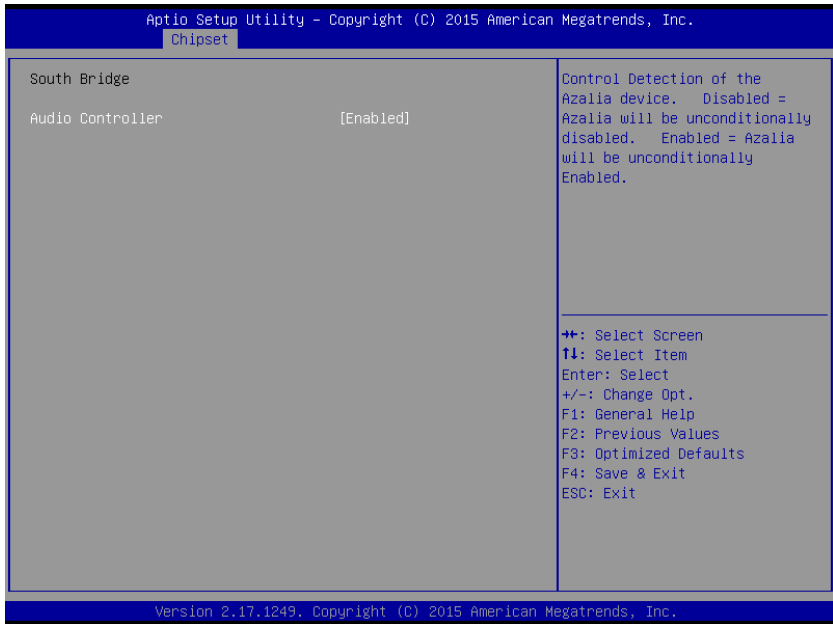

Options summary: (*default setting*)

Audio Controller	Disabled	
	<i>Enabled</i>	
Enable or disabled Azalia device for audio function.		

## 3.6 Setup submenu: Security

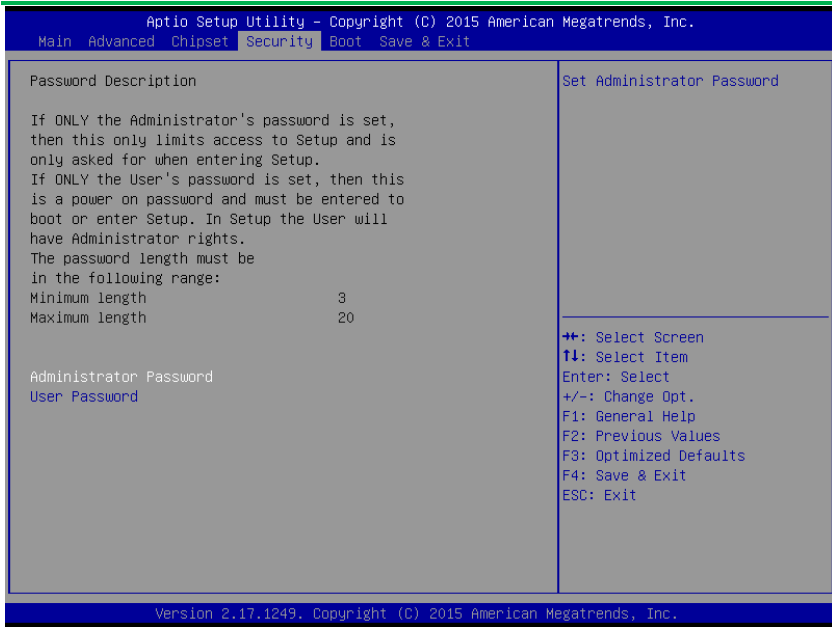

### Change User/Administrator Password

You can set a User Password once an Administrator Password is set. The password will be required during boot up, or when the user enters the Setup utility. Please Note that a User Password does not provide access to many of the features in the Setup utility.

Select the password you wish to set, press Enter to open a dialog box to enter your password (you can enter no more than six letters or numbers). Press Enter to confirm your entry, after which you will be prompted to retype your password for a final confirmation. Press Enter again after you have retyped it correctly.

### Removing the Password

Highlight this item and type in the current password. At the next dialog box press Enter to disable password protection.



### 3.7 Setup submenu: Boot

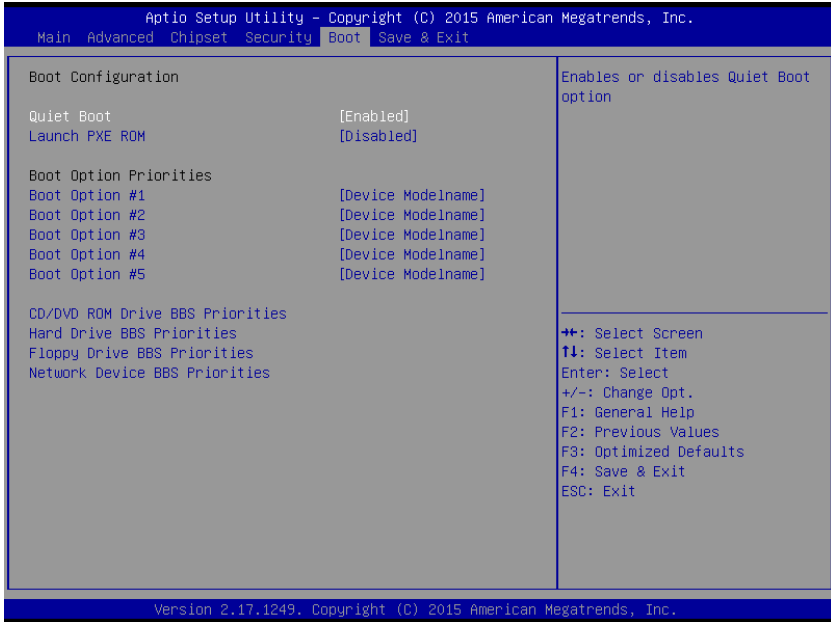

Options summary: (*default setting*)

Quiet Boot	Disabled	
	<i>Enabled</i>	
En/Disable showing boot logo.		
Launch PXE OpROM	<i>Disabled</i>	
	Enabled	
En/Disable network OpROM for legacy PXE boot		
Boot Option #X/		
XXXX Drive BBS Priorities		
The order of boot priorities.		

### 3.7.1 Boot: BBS Priorities

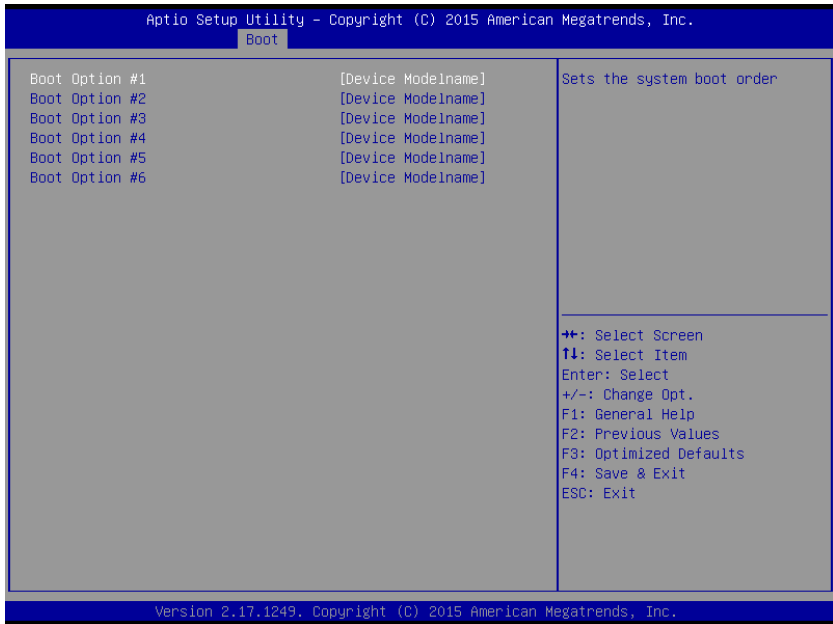

Options summary: (*default setting*)

Boot Option #x	Disabled	
	Device name	
Sets the system boot order		

### 3.8 Setup submenu: Save & Exit

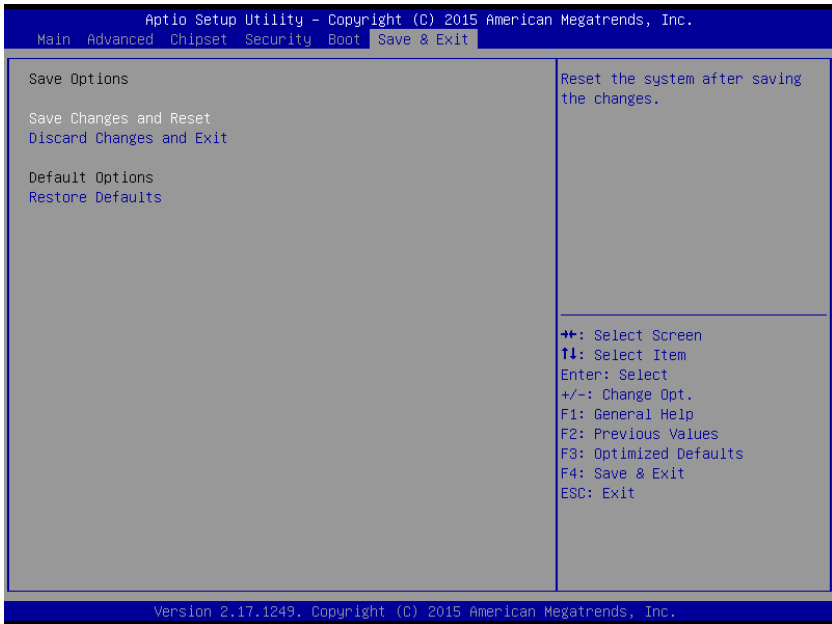

Options summary: (*default setting*)

Save Changes and Reset		
Reset the system after saving the changes		
Discard Changes and Exit		
Reset system setup without saving any changes		
Restore Defaults		
Restore/Load Default values for all the setup options.		

# Chapter 4

---

Drivers Installation

## 4.1 Driver Download/Installation

---

Drivers for the PICO-BSW1 can be downloaded from the product page on the AAEON website by following this link:

<https://www.aaeon.com/en/p/pico-itx-boards-pico-bsw1#downloads>

Download the driver(s) you need and follow the steps below to install them.

### Step 1 – Install Chipset Driver

1. Open the **Step1 - Chipset** folder and open the **SetupChipset.exe** file
2. Follow the instructions
3. Drivers will be installed automatically

### Step 2 – Install Graphic Driver

1. Open the **Step2 - Graphic** folder and select your OS
2. Open the **Setup.exe** file in the folder
3. Follow the instructions
4. Driver will be installed automatically

### Step 3 – Install LAN Driver

1. Open the **Step3 - LAN** folder and select your OS
2. Open the **Setup.exe** file in the folder
3. Follow the instructions
4. Driver will be installed automatically

#### Step 4 – Install Audio Driver

1. Open the **Step4 - Audio** folder and select your OS
2. Open the **Setup.exe** file in the folder
3. Follow the instructions
4. Driver will be installed automatically

#### Step 5 – Install TXE Driver

1. Open the **Step5 - TXE** folder and open the **Setup.exe** file
2. Follow the instructions
3. Driver will be installed automatically

#### Step 6 – Install USB3.0 Driver

1. Open the **Step6 - USB3.0** folder and open the **Setup.exe** file
2. Follow the instructions
3. Driver will be installed automatically

#### Step 7 – Install Serial Port Driver (Optional)

1. Open the **STEP7 - Serial Port Driver(Optional)** folder and open the **Setup.exe** file
2. Follow the instructions
3. Driver will be installed automatically

# Appendix A





































---

I/O Information

## A.1 I/O Address Map

Address Range	Device Name
[0000000000000000 - 000000000000006F]	PCI Express Root Complex
[0000000000000020 - 0000000000000021]	Programmable interrupt controller
[0000000000000020 - 0000000000000021]	Programmable interrupt controller
[0000000000000024 - 0000000000000025]	Programmable interrupt controller
[0000000000000024 - 0000000000000025]	Programmable interrupt controller
[0000000000000028 - 0000000000000029]	Programmable interrupt controller
[0000000000000028 - 0000000000000029]	Programmable interrupt controller
[000000000000002C - 000000000000002D]	Programmable interrupt controller
[000000000000002C - 000000000000002D]	Programmable interrupt controller
[0000000000000030 - 0000000000000031]	Programmable interrupt controller
[0000000000000030 - 0000000000000031]	Programmable interrupt controller
[0000000000000034 - 0000000000000035]	Programmable interrupt controller
[0000000000000034 - 0000000000000035]	Programmable interrupt controller
[0000000000000038 - 0000000000000039]	Programmable interrupt controller
[0000000000000038 - 0000000000000039]	Programmable interrupt controller
[000000000000003C - 000000000000003D]	Programmable interrupt controller
[000000000000003C - 000000000000003D]	Programmable interrupt controller
[0000000000000040 - 0000000000000043]	System timer
[0000000000000040 - 0000000000000043]	System timer
[000000000000004E - 000000000000004F]	Motherboard resources
[0000000000000050 - 0000000000000053]	System timer
[0000000000000050 - 0000000000000053]	System timer
[0000000000000060 - 0000000000000060]	Standard PS/2 Keyboard
[0000000000000061 - 0000000000000061]	Motherboard resources
[0000000000000063 - 0000000000000063]	Motherboard resources
[0000000000000064 - 0000000000000064]	Standard PS/2 Keyboard
[0000000000000065 - 0000000000000065]	Motherboard resources
[0000000000000067 - 0000000000000067]	Motherboard resources
[0000000000000070 - 0000000000000070]	Motherboard resources
[0000000000000070 - 0000000000000077]	System CMOS/real time clock
[0000000000000078 - 00000000000000CF]	PCI Express Root Complex
[0000000000000080 - 000000000000008F]	Motherboard resources
[0000000000000092 - 0000000000000092]	Motherboard resources



	[00000000000000A0 - 00000000000000A1]	Programmable interrupt controller
	[00000000000000A0 - 00000000000000A1]	Programmable interrupt controller
	[00000000000000A4 - 00000000000000A5]	Programmable interrupt controller
	[00000000000000A4 - 00000000000000A5]	Programmable interrupt controller
	[00000000000000A8 - 00000000000000A9]	Programmable interrupt controller
	[00000000000000A8 - 00000000000000A9]	Programmable interrupt controller
	[00000000000000AC - 00000000000000AD]	Programmable interrupt controller
	[00000000000000AC - 00000000000000AD]	Programmable interrupt controller
	[00000000000000B0 - 00000000000000B1]	Programmable interrupt controller
	[00000000000000B0 - 00000000000000B1]	Programmable interrupt controller
	[00000000000000B2 - 00000000000000B3]	Motherboard resources
	[00000000000000B4 - 00000000000000B5]	Programmable interrupt controller
	[00000000000000B4 - 00000000000000B5]	Programmable interrupt controller
	[00000000000000B8 - 00000000000000B9]	Programmable interrupt controller
	[00000000000000B8 - 00000000000000B9]	Programmable interrupt controller
	[00000000000000B8 - 00000000000000B9]	Programmable interrupt controller
	[00000000000000BC - 00000000000000BD]	Programmable interrupt controller
	[00000000000000BC - 00000000000000BD]	Programmable interrupt controller
	[00000000000002F8 - 00000000000002FF]	Communications Port (COM2)
	[00000000000003B0 - 00000000000003BB]	Intel(R) HD Graphics
	[00000000000003C0 - 00000000000003DF]	Intel(R) HD Graphics
	[00000000000003F8 - 00000000000003FF]	Communications Port (COM1)
	[0000000000000400 - 000000000000047F]	Motherboard resources
	[00000000000004D0 - 00000000000004D1]	Programmable interrupt controller
	[00000000000004D0 - 00000000000004D1]	Programmable interrupt controller
	[0000000000000500 - 00000000000005FE]	Motherboard resources
	[0000000000000680 - 000000000000069F]	Motherboard resources
	[0000000000000A00 - 0000000000000A0F]	Motherboard resources
	[0000000000000A10 - 0000000000000A1F]	Motherboard resources
	[0000000000000A20 - 0000000000000A2F]	Motherboard resources
	[0000000000000D00 - 0000000000000FFF]	PCI Express Root Complex
	[0000000000000C00 - 0000000000000CFF]	PCI-to-PCI Bridge
	[0000000000000D00 - 0000000000000DFF]	PCI-to-PCI Bridge
	[0000000000000E00 - 0000000000000E1F]	SM Bus Controller
	[0000000000000E00 - 0000000000000E0F]	Realtek PCIe GBE Family Controller #2
	[0000000000000E00 - 0000000000000E0F]	Realtek PCIe GBE Family Controller

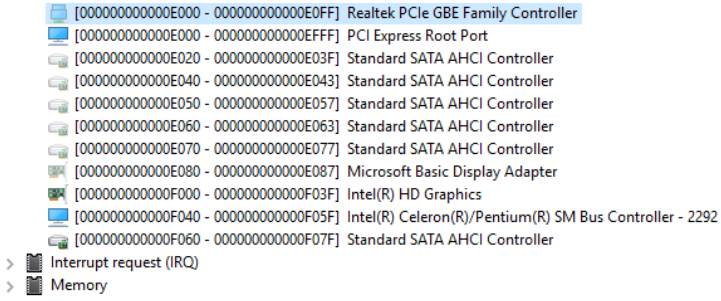

- 
- [000000000000E000 - 000000000000E0FF] Realtek PCIe GBE Family Controller
  - [000000000000E000 - 000000000000EFFF] PCI Express Root Port
  - [000000000000E020 - 000000000000E03F] Standard SATA AHCI Controller
  - [000000000000E040 - 000000000000E043] Standard SATA AHCI Controller
  - [000000000000E050 - 000000000000E057] Standard SATA AHCI Controller
  - [000000000000E060 - 000000000000E063] Standard SATA AHCI Controller
  - [000000000000E070 - 000000000000E077] Standard SATA AHCI Controller
  - [000000000000E080 - 000000000000E087] Microsoft Basic Display Adapter
  - [000000000000F000 - 000000000000F03F] Intel(R) HD Graphics
  - [000000000000F040 - 000000000000F05F] Intel(R) Celeron(R)/Pentium(R) SM Bus Controller - 2292
  - [000000000000F060 - 000000000000F07F] Standard SATA AHCI Controller
- > Interrupt request (IRQ)
  - > Memory

## A.2 Memory Address Map

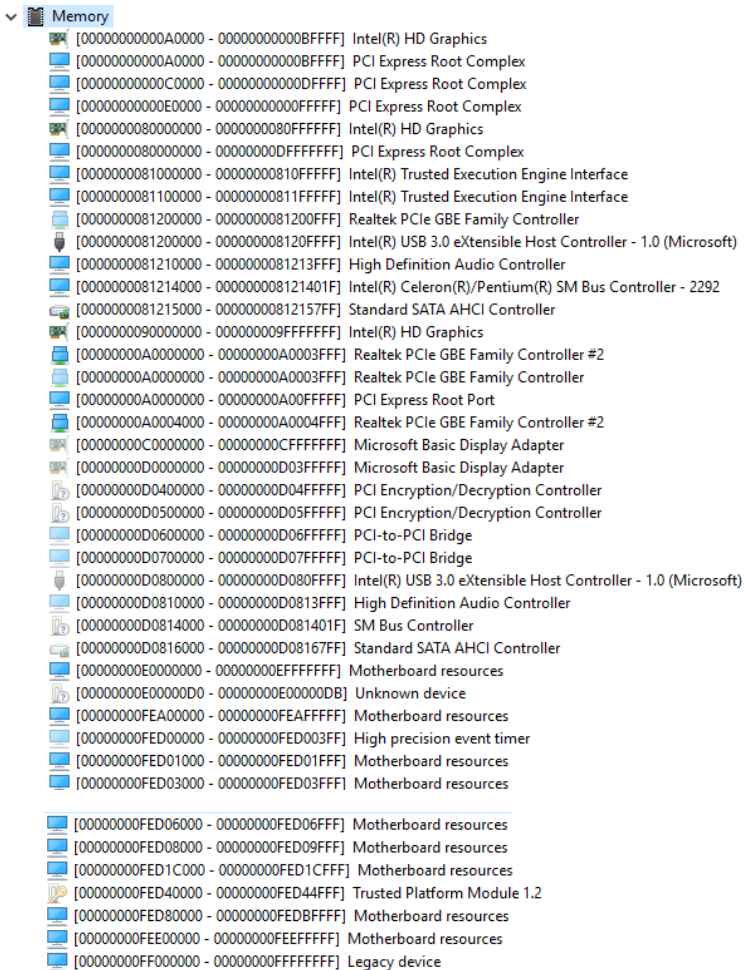



































The image shows a screenshot of the Windows System Information tool, specifically the 'Memory' section. The list displays memory addresses and their corresponding hardware components. The list is scrollable, with a vertical scrollbar on the right side. The entries are as follows:



































Memory Address Range	Hardware Component
[0000000000A0000 - 0000000000BFFFFF]	Intel(R) HD Graphics
[0000000000A0000 - 0000000000BFFFFF]	PCI Express Root Complex
[0000000000C0000 - 0000000000DFFFFF]	PCI Express Root Complex
[0000000000E0000 - 0000000000FFFFFF]	PCI Express Root Complex
[00000000080000000 - 00000000080FFFFFFF]	Intel(R) HD Graphics
[00000000080000000 - 000000000DFFFFFFF]	PCI Express Root Complex
[0000000081000000 - 00000000810FFFFFFF]	Intel(R) Trusted Execution Engine Interface
[0000000081100000 - 00000000811FFFFFFF]	Intel(R) Trusted Execution Engine Interface
[0000000081200000 - 0000000081200FFF]	Realtek PCIe GBE Family Controller
[0000000081200000 - 000000008120FFFFFF]	Intel(R) USB 3.0 eXtensible Host Controller - 1.0 (Microsoft)
[0000000081210000 - 0000000081213FFF]	High Definition Audio Controller
[0000000081214000 - 000000008121401F]	Intel(R) Celeron(R)/Pentium(R) SM Bus Controller - 2292
[0000000081215000 - 00000000812157FF]	Standard SATA AHCI Controller
[0000000090000000 - 000000009FFFFFFF]	Intel(R) HD Graphics
[00000000A0000000 - 00000000A0003FFF]	Realtek PCIe GBE Family Controller #2
[00000000A0000000 - 00000000A0003FFF]	Realtek PCIe GBE Family Controller
[00000000A0000000 - 00000000A000FFFF]	PCI Express Root Port
[00000000A0004000 - 00000000A0004FFF]	Realtek PCIe GBE Family Controller #2
[00000000C0000000 - 00000000CFFFFFFF]	Microsoft Basic Display Adapter
[00000000D0000000 - 00000000D03FFFFFFF]	Microsoft Basic Display Adapter
[00000000D0400000 - 00000000D04FFFFFFF]	PCI Encryption/Decryption Controller
[00000000D0500000 - 00000000D05FFFFFFF]	PCI Encryption/Decryption Controller
[00000000D0600000 - 00000000D06FFFFFFF]	PCI-to-PCI Bridge
[00000000D0700000 - 00000000D07FFFFFFF]	PCI-to-PCI Bridge
[00000000D0800000 - 00000000D080FFFF]	Intel(R) USB 3.0 eXtensible Host Controller - 1.0 (Microsoft)
[00000000D0810000 - 00000000D0813FFF]	High Definition Audio Controller
[00000000D0814000 - 00000000D081401F]	SM Bus Controller
[00000000D0816000 - 00000000D08167FF]	Standard SATA AHCI Controller
[00000000E0000000 - 00000000EFFFFFFF]	Motherboard resources
[00000000E00000D0 - 00000000E00000DB]	Unknown device
[00000000FEA00000 - 00000000FEAFFFFFFF]	Motherboard resources
[00000000FED00000 - 00000000FED003FF]	High precision event timer
[00000000FED01000 - 00000000FED01FFF]	Motherboard resources
[00000000FED03000 - 00000000FED03FFF]	Motherboard resources
[00000000FED06000 - 00000000FED06FFF]	Motherboard resources
[00000000FED08000 - 00000000FED09FFF]	Motherboard resources
[00000000FED1C000 - 00000000FED1CFFF]	Motherboard resources
[00000000FED40000 - 00000000FED44FFF]	Trusted Platform Module 1.2
[00000000FED80000 - 00000000FEDBFFFF]	Motherboard resources
[00000000FEE00000 - 00000000FEEFFFFFFF]	Motherboard resources
[00000000FF000000 - 00000000FFFFFFFF]	Legacy device

## A.3 IRQ Mapping Chart



































Device	IRQ
System timer	(ISA) 0x00000000 (00)
System timer	(ISA) 0x00000000 (00)
Standard PS/2 Keyboard	(ISA) 0x00000001 (01)
Communications Port (COM2)	(ISA) 0x00000003 (03)
PCI Encryption/Decryption Controller	(ISA) 0x00000003 (03)
Communications Port (COM1)	(ISA) 0x00000004 (04)
High Definition Audio Controller	(ISA) 0x00000004 (04)
Intel(R) USB 3.0 eXtensible Host Controller - 1.0 (Microsoft)	(ISA) 0x00000005 (05)
High precision event timer	(ISA) 0x00000008 (08)
PCI-to-PCI Bridge	(ISA) 0x0000000A (10)
PCI-to-PCI Bridge	(ISA) 0x0000000A (10)
SM Bus Controller	(ISA) 0x0000000A (10)
Standard SATA AHCI Controller	(ISA) 0x0000000A (10)
Microsoft Basic Display Adapter	(ISA) 0x0000000B (11)
PCI-to-PCI Bridge	(ISA) 0x0000000B (11)
PCI-to-PCI Bridge	(ISA) 0x0000000B (11)
Realtek PCIe GBE Family Controller	(ISA) 0x0000000B (11)
Microsoft PS/2 Mouse	(ISA) 0x0000000C (12)
Microsoft ACPI-Compliant System	(ISA) 0x00000036 (54)
Microsoft ACPI-Compliant System	(ISA) 0x00000037 (55)
Microsoft ACPI-Compliant System	(ISA) 0x00000038 (56)
Microsoft ACPI-Compliant System	(ISA) 0x00000039 (57)
Microsoft ACPI-Compliant System	(ISA) 0x0000003A (58)
Microsoft ACPI-Compliant System	(ISA) 0x0000003B (59)
Microsoft ACPI-Compliant System	(ISA) 0x0000003C (60)
Microsoft ACPI-Compliant System	(ISA) 0x0000003D (61)
Microsoft ACPI-Compliant System	(ISA) 0x0000003E (62)
Microsoft ACPI-Compliant System	(ISA) 0x0000003F (63)
Microsoft ACPI-Compliant System	(ISA) 0x00000040 (64)
Microsoft ACPI-Compliant System	(ISA) 0x00000041 (65)
Microsoft ACPI-Compliant System	(ISA) 0x00000042 (66)
Microsoft ACPI-Compliant System	(ISA) 0x00000043 (67)
Microsoft ACPI-Compliant System	(ISA) 0x00000044 (68)
Microsoft ACPI-Compliant System	(ISA) 0x00000045 (69)

	(ISA) 0x00000046 (70)	Microsoft ACPI-Compliant System
	(ISA) 0x00000047 (71)	Microsoft ACPI-Compliant System
	(ISA) 0x00000048 (72)	Microsoft ACPI-Compliant System
	(ISA) 0x00000049 (73)	Microsoft ACPI-Compliant System
	(ISA) 0x0000004A (74)	Microsoft ACPI-Compliant System
	(ISA) 0x0000004B (75)	Microsoft ACPI-Compliant System
	(ISA) 0x0000004C (76)	Microsoft ACPI-Compliant System
	(ISA) 0x0000004D (77)	Microsoft ACPI-Compliant System
	(ISA) 0x0000004E (78)	Microsoft ACPI-Compliant System
	(ISA) 0x0000004F (79)	Microsoft ACPI-Compliant System
	(ISA) 0x00000050 (80)	Microsoft ACPI-Compliant System
	(ISA) 0x00000051 (81)	Microsoft ACPI-Compliant System
	(ISA) 0x00000052 (82)	Microsoft ACPI-Compliant System
	(ISA) 0x00000053 (83)	Microsoft ACPI-Compliant System
	(ISA) 0x00000054 (84)	Microsoft ACPI-Compliant System
	(ISA) 0x00000055 (85)	Microsoft ACPI-Compliant System
	(ISA) 0x00000056 (86)	Microsoft ACPI-Compliant System
	(ISA) 0x00000057 (87)	Microsoft ACPI-Compliant System
	(ISA) 0x00000058 (88)	Microsoft ACPI-Compliant System
	(ISA) 0x00000059 (89)	Microsoft ACPI-Compliant System
	(ISA) 0x0000005A (90)	Microsoft ACPI-Compliant System
	(ISA) 0x0000005B (91)	Microsoft ACPI-Compliant System
	(ISA) 0x0000005C (92)	Microsoft ACPI-Compliant System
	(ISA) 0x0000005D (93)	Microsoft ACPI-Compliant System
	(ISA) 0x0000005E (94)	Microsoft ACPI-Compliant System
	(ISA) 0x0000005F (95)	Microsoft ACPI-Compliant System
	(ISA) 0x00000060 (96)	Microsoft ACPI-Compliant System
	(ISA) 0x00000061 (97)	Microsoft ACPI-Compliant System
	(ISA) 0x00000062 (98)	Microsoft ACPI-Compliant System
	(ISA) 0x00000063 (99)	Microsoft ACPI-Compliant System
	(ISA) 0x00000064 (100)	Microsoft ACPI-Compliant System
	(ISA) 0x00000065 (101)	Microsoft ACPI-Compliant System
	(ISA) 0x00000066 (102)	Microsoft ACPI-Compliant System
	(ISA) 0x00000067 (103)	Microsoft ACPI-Compliant System
	(ISA) 0x00000068 (104)	Microsoft ACPI-Compliant System





































 (ISA) 0x0000069 (105)	Microsoft ACPI-Compliant System
 (ISA) 0x000006A (106)	Microsoft ACPI-Compliant System
 (ISA) 0x000006B (107)	Microsoft ACPI-Compliant System
 (ISA) 0x000006C (108)	Microsoft ACPI-Compliant System
 (ISA) 0x000006D (109)	Microsoft ACPI-Compliant System
 (ISA) 0x000006E (110)	Microsoft ACPI-Compliant System
 (ISA) 0x000006F (111)	Microsoft ACPI-Compliant System
 (ISA) 0x0000070 (112)	Microsoft ACPI-Compliant System
 (ISA) 0x0000071 (113)	Microsoft ACPI-Compliant System
 (ISA) 0x0000072 (114)	Microsoft ACPI-Compliant System
 (ISA) 0x0000073 (115)	Microsoft ACPI-Compliant System
 (ISA) 0x0000074 (116)	Microsoft ACPI-Compliant System
 (ISA) 0x0000075 (117)	Microsoft ACPI-Compliant System
 (ISA) 0x0000076 (118)	Microsoft ACPI-Compliant System
 (ISA) 0x0000077 (119)	Microsoft ACPI-Compliant System
 (ISA) 0x0000078 (120)	Microsoft ACPI-Compliant System
 (ISA) 0x0000079 (121)	Microsoft ACPI-Compliant System
 (ISA) 0x000007A (122)	Microsoft ACPI-Compliant System
 (ISA) 0x000007B (123)	Microsoft ACPI-Compliant System
 (ISA) 0x000007C (124)	Microsoft ACPI-Compliant System
 (ISA) 0x000007D (125)	Microsoft ACPI-Compliant System
 (ISA) 0x000007E (126)	Microsoft ACPI-Compliant System
 (ISA) 0x000007F (127)	Microsoft ACPI-Compliant System
 (ISA) 0x0000080 (128)	Microsoft ACPI-Compliant System
 (ISA) 0x0000081 (129)	Microsoft ACPI-Compliant System
 (ISA) 0x0000082 (130)	Microsoft ACPI-Compliant System
 (ISA) 0x0000083 (131)	Microsoft ACPI-Compliant System
 (ISA) 0x0000084 (132)	Microsoft ACPI-Compliant System
 (ISA) 0x0000085 (133)	Microsoft ACPI-Compliant System
 (ISA) 0x0000086 (134)	Microsoft ACPI-Compliant System
 (ISA) 0x0000087 (135)	Microsoft ACPI-Compliant System
 (ISA) 0x0000088 (136)	Microsoft ACPI-Compliant System
 (ISA) 0x0000089 (137)	Microsoft ACPI-Compliant System
 (ISA) 0x000008A (138)	Microsoft ACPI-Compliant System
 (ISA) 0x000008B (139)	Microsoft ACPI-Compliant System





































	(ISA) 0x000000AF (175)	Microsoft ACPI-Compliant System
	(ISA) 0x000000B0 (176)	Microsoft ACPI-Compliant System
	(ISA) 0x000000B1 (177)	Microsoft ACPI-Compliant System
	(ISA) 0x000000B2 (178)	Microsoft ACPI-Compliant System
	(ISA) 0x000000B3 (179)	Microsoft ACPI-Compliant System
	(ISA) 0x000000B4 (180)	Microsoft ACPI-Compliant System
	(ISA) 0x000000B5 (181)	Microsoft ACPI-Compliant System
	(ISA) 0x000000B6 (182)	Microsoft ACPI-Compliant System
	(ISA) 0x000000B7 (183)	Microsoft ACPI-Compliant System
	(ISA) 0x000000B8 (184)	Microsoft ACPI-Compliant System
	(ISA) 0x000000B9 (185)	Microsoft ACPI-Compliant System
	(ISA) 0x000000BA (186)	Microsoft ACPI-Compliant System
	(ISA) 0x000000BB (187)	Microsoft ACPI-Compliant System
	(ISA) 0x000000BC (188)	Microsoft ACPI-Compliant System
	(ISA) 0x000000BD (189)	Microsoft ACPI-Compliant System
	(ISA) 0x000000BE (190)	Microsoft ACPI-Compliant System
	(ISA) 0x000000BF (191)	Microsoft ACPI-Compliant System
	(ISA) 0x000000C0 (192)	Microsoft ACPI-Compliant System
	(ISA) 0x000000C1 (193)	Microsoft ACPI-Compliant System
	(ISA) 0x000000C2 (194)	Microsoft ACPI-Compliant System
	(ISA) 0x000000C3 (195)	Microsoft ACPI-Compliant System
	(ISA) 0x000000C4 (196)	Microsoft ACPI-Compliant System
	(ISA) 0x000000C5 (197)	Microsoft ACPI-Compliant System
	(ISA) 0x000000C6 (198)	Microsoft ACPI-Compliant System
	(ISA) 0x000000C7 (199)	Microsoft ACPI-Compliant System
	(ISA) 0x000000C8 (200)	Microsoft ACPI-Compliant System
	(ISA) 0x000000C9 (201)	Microsoft ACPI-Compliant System
	(ISA) 0x000000CA (202)	Microsoft ACPI-Compliant System
	(ISA) 0x000000CB (203)	Microsoft ACPI-Compliant System
	(ISA) 0x000000CC (204)	Microsoft ACPI-Compliant System
	(ISA) 0x00000100 (256)	Microsoft ACPI-Compliant System
	(ISA) 0x00000101 (257)	Microsoft ACPI-Compliant System
	(ISA) 0x00000102 (258)	Microsoft ACPI-Compliant System
	(ISA) 0x00000103 (259)	Microsoft ACPI-Compliant System
	(ISA) 0x00000104 (260)	Microsoft ACPI-Compliant System





































 (ISA) 0x00000105 (261)	Microsoft ACPI-Compliant System
 (ISA) 0x00000106 (262)	Microsoft ACPI-Compliant System
 (ISA) 0x00000107 (263)	Microsoft ACPI-Compliant System
 (ISA) 0x00000108 (264)	Microsoft ACPI-Compliant System
 (ISA) 0x00000109 (265)	Microsoft ACPI-Compliant System
 (ISA) 0x0000010A (266)	Microsoft ACPI-Compliant System
 (ISA) 0x0000010B (267)	Microsoft ACPI-Compliant System
 (ISA) 0x0000010C (268)	Microsoft ACPI-Compliant System
 (ISA) 0x0000010D (269)	Microsoft ACPI-Compliant System
 (ISA) 0x0000010E (270)	Microsoft ACPI-Compliant System
 (ISA) 0x0000010F (271)	Microsoft ACPI-Compliant System
 (ISA) 0x00000110 (272)	Microsoft ACPI-Compliant System
 (ISA) 0x00000111 (273)	Microsoft ACPI-Compliant System
 (ISA) 0x00000112 (274)	Microsoft ACPI-Compliant System
 (ISA) 0x00000113 (275)	Microsoft ACPI-Compliant System
 (ISA) 0x00000114 (276)	Microsoft ACPI-Compliant System
 (ISA) 0x00000115 (277)	Microsoft ACPI-Compliant System
 (ISA) 0x00000116 (278)	Microsoft ACPI-Compliant System
 (ISA) 0x00000117 (279)	Microsoft ACPI-Compliant System
 (ISA) 0x00000118 (280)	Microsoft ACPI-Compliant System
 (ISA) 0x00000119 (281)	Microsoft ACPI-Compliant System
 (ISA) 0x0000011A (282)	Microsoft ACPI-Compliant System
 (ISA) 0x0000011B (283)	Microsoft ACPI-Compliant System
 (ISA) 0x0000011C (284)	Microsoft ACPI-Compliant System
 (ISA) 0x0000011D (285)	Microsoft ACPI-Compliant System
 (ISA) 0x0000011E (286)	Microsoft ACPI-Compliant System
 (ISA) 0x0000011F (287)	Microsoft ACPI-Compliant System
 (ISA) 0x00000120 (288)	Microsoft ACPI-Compliant System
 (ISA) 0x00000121 (289)	Microsoft ACPI-Compliant System
 (ISA) 0x00000122 (290)	Microsoft ACPI-Compliant System
 (ISA) 0x00000123 (291)	Microsoft ACPI-Compliant System
 (ISA) 0x00000124 (292)	Microsoft ACPI-Compliant System
 (ISA) 0x00000125 (293)	Microsoft ACPI-Compliant System
 (ISA) 0x00000126 (294)	Microsoft ACPI-Compliant System
 (ISA) 0x00000127 (295)	Microsoft ACPI-Compliant System







































	(ISA) 0x00000128 (296)	Microsoft ACPI-Compliant System
	(ISA) 0x00000129 (297)	Microsoft ACPI-Compliant System
	(ISA) 0x0000012A (298)	Microsoft ACPI-Compliant System
	(ISA) 0x0000012B (299)	Microsoft ACPI-Compliant System
	(ISA) 0x0000012C (300)	Microsoft ACPI-Compliant System
	(ISA) 0x0000012D (301)	Microsoft ACPI-Compliant System
	(ISA) 0x0000012E (302)	Microsoft ACPI-Compliant System
	(ISA) 0x0000012F (303)	Microsoft ACPI-Compliant System
	(ISA) 0x00000130 (304)	Microsoft ACPI-Compliant System
	(ISA) 0x00000131 (305)	Microsoft ACPI-Compliant System
	(ISA) 0x00000132 (306)	Microsoft ACPI-Compliant System
	(ISA) 0x00000133 (307)	Microsoft ACPI-Compliant System
	(ISA) 0x00000134 (308)	Microsoft ACPI-Compliant System
	(ISA) 0x00000135 (309)	Microsoft ACPI-Compliant System
	(ISA) 0x00000136 (310)	Microsoft ACPI-Compliant System
	(ISA) 0x00000137 (311)	Microsoft ACPI-Compliant System
	(ISA) 0x00000138 (312)	Microsoft ACPI-Compliant System
	(ISA) 0x00000139 (313)	Microsoft ACPI-Compliant System
	(ISA) 0x0000013A (314)	Microsoft ACPI-Compliant System
	(ISA) 0x0000013B (315)	Microsoft ACPI-Compliant System
	(ISA) 0x0000013C (316)	Microsoft ACPI-Compliant System
	(ISA) 0x0000013D (317)	Microsoft ACPI-Compliant System
	(ISA) 0x0000013E (318)	Microsoft ACPI-Compliant System
	(ISA) 0x0000013F (319)	Microsoft ACPI-Compliant System
	(ISA) 0x00000140 (320)	Microsoft ACPI-Compliant System
	(ISA) 0x00000141 (321)	Microsoft ACPI-Compliant System
	(ISA) 0x00000142 (322)	Microsoft ACPI-Compliant System
	(ISA) 0x00000143 (323)	Microsoft ACPI-Compliant System
	(ISA) 0x00000144 (324)	Microsoft ACPI-Compliant System
	(ISA) 0x00000145 (325)	Microsoft ACPI-Compliant System
	(ISA) 0x00000146 (326)	Microsoft ACPI-Compliant System
	(ISA) 0x00000147 (327)	Microsoft ACPI-Compliant System
	(ISA) 0x00000148 (328)	Microsoft ACPI-Compliant System
	(ISA) 0x00000149 (329)	Microsoft ACPI-Compliant System
	(ISA) 0x0000014A (330)	Microsoft ACPI-Compliant System





































	(ISA) 0x0000014B (331)	Microsoft ACPI-Compliant System
	(ISA) 0x0000014C (332)	Microsoft ACPI-Compliant System
	(ISA) 0x0000014D (333)	Microsoft ACPI-Compliant System
	(ISA) 0x0000014E (334)	Microsoft ACPI-Compliant System
	(ISA) 0x0000014F (335)	Microsoft ACPI-Compliant System
	(ISA) 0x00000150 (336)	Microsoft ACPI-Compliant System
	(ISA) 0x00000151 (337)	Microsoft ACPI-Compliant System
	(ISA) 0x00000152 (338)	Microsoft ACPI-Compliant System
	(ISA) 0x00000153 (339)	Microsoft ACPI-Compliant System
	(ISA) 0x00000154 (340)	Microsoft ACPI-Compliant System
	(ISA) 0x00000155 (341)	Microsoft ACPI-Compliant System
	(ISA) 0x00000156 (342)	Microsoft ACPI-Compliant System
	(ISA) 0x00000157 (343)	Microsoft ACPI-Compliant System
	(ISA) 0x00000158 (344)	Microsoft ACPI-Compliant System
	(ISA) 0x00000159 (345)	Microsoft ACPI-Compliant System
	(ISA) 0x0000015A (346)	Microsoft ACPI-Compliant System
	(ISA) 0x0000015B (347)	Microsoft ACPI-Compliant System
	(ISA) 0x0000015C (348)	Microsoft ACPI-Compliant System
	(ISA) 0x0000015D (349)	Microsoft ACPI-Compliant System
	(ISA) 0x0000015E (350)	Microsoft ACPI-Compliant System
	(ISA) 0x0000015F (351)	Microsoft ACPI-Compliant System
	(ISA) 0x00000160 (352)	Microsoft ACPI-Compliant System
	(ISA) 0x00000161 (353)	Microsoft ACPI-Compliant System
	(ISA) 0x00000162 (354)	Microsoft ACPI-Compliant System
	(ISA) 0x00000163 (355)	Microsoft ACPI-Compliant System
	(ISA) 0x00000164 (356)	Microsoft ACPI-Compliant System
	(ISA) 0x00000165 (357)	Microsoft ACPI-Compliant System
	(ISA) 0x00000166 (358)	Microsoft ACPI-Compliant System
	(ISA) 0x00000167 (359)	Microsoft ACPI-Compliant System
	(ISA) 0x00000168 (360)	Microsoft ACPI-Compliant System
	(ISA) 0x00000169 (361)	Microsoft ACPI-Compliant System
	(ISA) 0x0000016A (362)	Microsoft ACPI-Compliant System
	(ISA) 0x0000016B (363)	Microsoft ACPI-Compliant System
	(ISA) 0x0000016C (364)	Microsoft ACPI-Compliant System
	(ISA) 0x0000016D (365)	Microsoft ACPI-Compliant System





































 (ISA) 0x0000016E (366)	Microsoft ACPI-Compliant System
 (ISA) 0x0000016F (367)	Microsoft ACPI-Compliant System
 (ISA) 0x00000170 (368)	Microsoft ACPI-Compliant System
 (ISA) 0x00000171 (369)	Microsoft ACPI-Compliant System
 (ISA) 0x00000172 (370)	Microsoft ACPI-Compliant System
 (ISA) 0x00000173 (371)	Microsoft ACPI-Compliant System
 (ISA) 0x00000174 (372)	Microsoft ACPI-Compliant System
 (ISA) 0x00000175 (373)	Microsoft ACPI-Compliant System
 (ISA) 0x00000176 (374)	Microsoft ACPI-Compliant System
 (ISA) 0x00000177 (375)	Microsoft ACPI-Compliant System
 (ISA) 0x00000178 (376)	Microsoft ACPI-Compliant System
 (ISA) 0x00000179 (377)	Microsoft ACPI-Compliant System
 (ISA) 0x0000017A (378)	Microsoft ACPI-Compliant System
 (ISA) 0x0000017B (379)	Microsoft ACPI-Compliant System
 (ISA) 0x0000017C (380)	Microsoft ACPI-Compliant System
 (ISA) 0x0000017D (381)	Microsoft ACPI-Compliant System
 (ISA) 0x0000017E (382)	Microsoft ACPI-Compliant System
 (ISA) 0x0000017F (383)	Microsoft ACPI-Compliant System
 (ISA) 0x00000180 (384)	Microsoft ACPI-Compliant System
 (ISA) 0x00000181 (385)	Microsoft ACPI-Compliant System
 (ISA) 0x00000182 (386)	Microsoft ACPI-Compliant System
 (ISA) 0x00000183 (387)	Microsoft ACPI-Compliant System
 (ISA) 0x00000184 (388)	Microsoft ACPI-Compliant System
 (ISA) 0x00000185 (389)	Microsoft ACPI-Compliant System
 (ISA) 0x00000186 (390)	Microsoft ACPI-Compliant System
 (ISA) 0x00000187 (391)	Microsoft ACPI-Compliant System
 (ISA) 0x00000188 (392)	Microsoft ACPI-Compliant System
 (ISA) 0x00000189 (393)	Microsoft ACPI-Compliant System
 (ISA) 0x0000018A (394)	Microsoft ACPI-Compliant System
 (ISA) 0x0000018B (395)	Microsoft ACPI-Compliant System
 (ISA) 0x0000018C (396)	Microsoft ACPI-Compliant System
 (ISA) 0x0000018D (397)	Microsoft ACPI-Compliant System
 (ISA) 0x0000018E (398)	Microsoft ACPI-Compliant System
 (ISA) 0x0000018F (399)	Microsoft ACPI-Compliant System
 (ISA) 0x00000190 (400)	Microsoft ACPI-Compliant System





















































 (ISA) 0x00000191 (401)	Microsoft ACPI-Compliant System
 (ISA) 0x00000192 (402)	Microsoft ACPI-Compliant System
 (ISA) 0x00000193 (403)	Microsoft ACPI-Compliant System
 (ISA) 0x00000194 (404)	Microsoft ACPI-Compliant System
 (ISA) 0x00000195 (405)	Microsoft ACPI-Compliant System
 (ISA) 0x00000196 (406)	Microsoft ACPI-Compliant System
 (ISA) 0x00000197 (407)	Microsoft ACPI-Compliant System
 (ISA) 0x00000198 (408)	Microsoft ACPI-Compliant System
 (ISA) 0x00000199 (409)	Microsoft ACPI-Compliant System
 (ISA) 0x0000019A (410)	Microsoft ACPI-Compliant System
 (ISA) 0x0000019B (411)	Microsoft ACPI-Compliant System
 (ISA) 0x0000019C (412)	Microsoft ACPI-Compliant System
 (ISA) 0x0000019D (413)	Microsoft ACPI-Compliant System
 (ISA) 0x0000019E (414)	Microsoft ACPI-Compliant System
 (ISA) 0x0000019F (415)	Microsoft ACPI-Compliant System
 (ISA) 0x000001A0 (416)	Microsoft ACPI-Compliant System
 (ISA) 0x000001A1 (417)	Microsoft ACPI-Compliant System
 (ISA) 0x000001A2 (418)	Microsoft ACPI-Compliant System
 (ISA) 0x000001A3 (419)	Microsoft ACPI-Compliant System
 (ISA) 0x000001A4 (420)	Microsoft ACPI-Compliant System
 (ISA) 0x000001A5 (421)	Microsoft ACPI-Compliant System
 (ISA) 0x000001A6 (422)	Microsoft ACPI-Compliant System
 (ISA) 0x000001A7 (423)	Microsoft ACPI-Compliant System
 (ISA) 0x000001A8 (424)	Microsoft ACPI-Compliant System
 (ISA) 0x000001A9 (425)	Microsoft ACPI-Compliant System
 (ISA) 0x000001AA (426)	Microsoft ACPI-Compliant System
 (ISA) 0x000001AB (427)	Microsoft ACPI-Compliant System
 (ISA) 0x000001AC (428)	Microsoft ACPI-Compliant System
 (ISA) 0x000001AD (429)	Microsoft ACPI-Compliant System
 (ISA) 0x000001AE (430)	Microsoft ACPI-Compliant System
 (ISA) 0x000001AF (431)	Microsoft ACPI-Compliant System
 (ISA) 0x000001B0 (432)	Microsoft ACPI-Compliant System
 (ISA) 0x000001B1 (433)	Microsoft ACPI-Compliant System
 (ISA) 0x000001B2 (434)	Microsoft ACPI-Compliant System
 (ISA) 0x000001B3 (435)	Microsoft ACPI-Compliant System



	(ISA) 0x000001B4 (436)	Microsoft ACPI-Compliant System
	(ISA) 0x000001B5 (437)	Microsoft ACPI-Compliant System
	(ISA) 0x000001B6 (438)	Microsoft ACPI-Compliant System
	(ISA) 0x000001B7 (439)	Microsoft ACPI-Compliant System
	(ISA) 0x000001B8 (440)	Microsoft ACPI-Compliant System
	(ISA) 0x000001B9 (441)	Microsoft ACPI-Compliant System
	(ISA) 0x000001BA (442)	Microsoft ACPI-Compliant System
	(ISA) 0x000001BB (443)	Microsoft ACPI-Compliant System
	(ISA) 0x000001BC (444)	Microsoft ACPI-Compliant System
	(ISA) 0x000001BD (445)	Microsoft ACPI-Compliant System
	(ISA) 0x000001BE (446)	Microsoft ACPI-Compliant System
	(ISA) 0x000001BF (447)	Microsoft ACPI-Compliant System
	(ISA) 0x000001C0 (448)	Microsoft ACPI-Compliant System
	(ISA) 0x000001C1 (449)	Microsoft ACPI-Compliant System
	(ISA) 0x000001C2 (450)	Microsoft ACPI-Compliant System
	(ISA) 0x000001C3 (451)	Microsoft ACPI-Compliant System
	(ISA) 0x000001C4 (452)	Microsoft ACPI-Compliant System
	(ISA) 0x000001C5 (453)	Microsoft ACPI-Compliant System
	(ISA) 0x000001C6 (454)	Microsoft ACPI-Compliant System
	(ISA) 0x000001C7 (455)	Microsoft ACPI-Compliant System
	(ISA) 0x000001C8 (456)	Microsoft ACPI-Compliant System
	(ISA) 0x000001C9 (457)	Microsoft ACPI-Compliant System
	(ISA) 0x000001CA (458)	Microsoft ACPI-Compliant System
	(ISA) 0x000001CB (459)	Microsoft ACPI-Compliant System
	(ISA) 0x000001CC (460)	Microsoft ACPI-Compliant System
	(ISA) 0x000001CD (461)	Microsoft ACPI-Compliant System
	(ISA) 0x000001CE (462)	Microsoft ACPI-Compliant System
	(ISA) 0x000001CF (463)	Microsoft ACPI-Compliant System
	(ISA) 0x000001D0 (464)	Microsoft ACPI-Compliant System
	(ISA) 0x000001D1 (465)	Microsoft ACPI-Compliant System
	(ISA) 0x000001D2 (466)	Microsoft ACPI-Compliant System
	(ISA) 0x000001D3 (467)	Microsoft ACPI-Compliant System
	(ISA) 0x000001D4 (468)	Microsoft ACPI-Compliant System
	(ISA) 0x000001D5 (469)	Microsoft ACPI-Compliant System
	(ISA) 0x000001D6 (470)	Microsoft ACPI-Compliant System



	(ISA) 0x000001D7 (471)	Microsoft ACPI-Compliant System
	(ISA) 0x000001D8 (472)	Microsoft ACPI-Compliant System
	(ISA) 0x000001D9 (473)	Microsoft ACPI-Compliant System
	(ISA) 0x000001DA (474)	Microsoft ACPI-Compliant System
	(ISA) 0x000001DB (475)	Microsoft ACPI-Compliant System
	(ISA) 0x000001DC (476)	Microsoft ACPI-Compliant System
	(ISA) 0x000001DD (477)	Microsoft ACPI-Compliant System
	(ISA) 0x000001DE (478)	Microsoft ACPI-Compliant System
	(ISA) 0x000001DF (479)	Microsoft ACPI-Compliant System
	(ISA) 0x000001E0 (480)	Microsoft ACPI-Compliant System
	(ISA) 0x000001E1 (481)	Microsoft ACPI-Compliant System
	(ISA) 0x000001E2 (482)	Microsoft ACPI-Compliant System
	(ISA) 0x000001E3 (483)	Microsoft ACPI-Compliant System
	(ISA) 0x000001E4 (484)	Microsoft ACPI-Compliant System
	(ISA) 0x000001E5 (485)	Microsoft ACPI-Compliant System
	(ISA) 0x000001E6 (486)	Microsoft ACPI-Compliant System
	(ISA) 0x000001E7 (487)	Microsoft ACPI-Compliant System
	(ISA) 0x000001E8 (488)	Microsoft ACPI-Compliant System
	(ISA) 0x000001E9 (489)	Microsoft ACPI-Compliant System
	(ISA) 0x000001EA (490)	Microsoft ACPI-Compliant System
	(ISA) 0x000001EB (491)	Microsoft ACPI-Compliant System
	(ISA) 0x000001EC (492)	Microsoft ACPI-Compliant System
	(ISA) 0x000001ED (493)	Microsoft ACPI-Compliant System
	(ISA) 0x000001EE (494)	Microsoft ACPI-Compliant System
	(ISA) 0x000001EF (495)	Microsoft ACPI-Compliant System
	(ISA) 0x000001F0 (496)	Microsoft ACPI-Compliant System
	(ISA) 0x000001F1 (497)	Microsoft ACPI-Compliant System
	(ISA) 0x000001F2 (498)	Microsoft ACPI-Compliant System
	(ISA) 0x000001F3 (499)	Microsoft ACPI-Compliant System
	(ISA) 0x000001F4 (500)	Microsoft ACPI-Compliant System
	(ISA) 0x000001F5 (501)	Microsoft ACPI-Compliant System
	(ISA) 0x000001F6 (502)	Microsoft ACPI-Compliant System
	(ISA) 0x000001F7 (503)	Microsoft ACPI-Compliant System
	(ISA) 0x000001F8 (504)	Microsoft ACPI-Compliant System
	(ISA) 0x000001F9 (505)	Microsoft ACPI-Compliant System

	(ISA) 0x000001FA (506)	Microsoft ACPI-Compliant System
	(ISA) 0x000001FB (507)	Microsoft ACPI-Compliant System
	(ISA) 0x000001FC (508)	Microsoft ACPI-Compliant System
	(ISA) 0x000001FD (509)	Microsoft ACPI-Compliant System
	(ISA) 0x000001FE (510)	Microsoft ACPI-Compliant System
	(ISA) 0x000001FF (511)	Microsoft ACPI-Compliant System
	(PCI) 0x0000000A (10)	Intel(R) Celeron(R)/Pentium(R) SM Bus Controller - 2292
	(PCI) 0x00000016 (22)	High Definition Audio Controller
	(PCI) 0xFFFFFFF8 (-8)	Realtek PCIe GBE Family Controller #2
	(PCI) 0xFFFFFFF9 (-7)	Intel(R) USB 3.0 eXtensible Host Controller - 1.0 (Microsoft)
	(PCI) 0xFFFFF7FA (-6)	Intel(R) HD Graphics
	(PCI) 0xFFFFF7FB (-5)	Intel(R) Trusted Execution Engine Interface
	(PCI) 0xFFFFF7FC (-4)	Standard SATA AHCI Controller
	(PCI) 0xFFFFF7FD (-3)	PCI Express Root Port
	(PCI) 0xFFFFF7FE (-2)	PCI Express Root Port

# Appendix B

---

Electrical Specifications for I/O Ports

## B.1 Electrical Specifications for I/O Ports

I/O	Reference	Signal Name	Rate Output
USB 3.0 Ports 0 & 1	CN1	+5VSB	+5VSB/1A (per channel)
LVDS Port Inverter / Backlight Connector	CN5	VDD	+5V/2A or +12V/2A
LVDS Port	CN6	VCC	+3.3V/2A or +5V/2A
Mini-Card Slot (Half-Sized)	CN10	+3.3VSB +1.5V	+3.3V/1.1A +1.5V/0.375A
+5V Output for SATA HDD	CN11	+5V	+5V/1A
Mini-Card Slot (Full-Sized)	CN13	+3.3VSB +1.5V	+3.3V/1.1A +1.5V/0.375A
Digital IO Port	CN18	D0~D3	+5V/0.125A (per channel)
LPC Port	CN20	+3.3V	+3.3V/0.5A
COM Port 1/2 & Line out	CN21	+5V/+12V	+5V/1A or +12V/1A
HDMI	CN24	+5V	+5V/0.5A



# Appendix C

---

Mating Connectors

## C.1 List of Mating Connectors and Cables

The table notes mating connectors and available cables.

Connector Label	Function	Mating Connector		Available Cable	Cable P/N
		Vendor	Model no		
CN3	Battery	Molex	51021-0200	Battery Cable	175011301C
CN5	LVDS Port Inverter / Backlight Connector	JST	PHR-5		NA
CN6	LVDS Port	ACES	50247-030H0H0-001		N/A
CN8	BIO connector	Hirose	FX18-80S-0.8SV20		N/A
CN12	+5V Output for SATA HDD	JST	PHR-2	SATA power cable	1702150155
CN18	Digital IO Port	Molex	51110-0650		NA
CN20	LPC Port	JST	SHR-12V-S-B	AAEON LPC Cable	1703120130
CN21	COM Port 1/2 & line out connector	HRS	DF14-20S-1.25C	COM Port 1/2 & line out cable	1703200153
CN22	External +12V Input	Molex	19211-0003	Power cable	170204010R
JP16	Buzzer connector	Molex	51021-0200	Buzzer Cable	170302010C
JP16	Front Panel Connector	Molex	51110-1050	Front Panel Cable	1701100156