

PICO-ASL4 Rev.B

PICO-ITX Single Board Computer

User's Manual 1st Ed

Copyright Notice

This document is copyrighted, 2024. All rights are reserved. The original manufacturer reserves the right to make improvements to the products described in this manual at any time without notice.

No part of this manual may be reproduced, copied, translated, or transmitted in any form or by any means without the prior written permission of the original manufacturer. Information provided in this manual is intended to be accurate and reliable. However, the original manufacturer assumes no responsibility for its use, or for any infringements upon the rights of third parties that may result from its use.

The material in this document is for product information only and is subject to change without notice. While reasonable efforts have been made in the preparation of this document to assure its accuracy, AAEMON assumes no liabilities resulting from errors or omissions in this document, or from the use of the information contained herein.

AAEMON reserves the right to make changes in the product design without notice to its users.

Acknowledgement

All other products' name or trademarks are properties of their respective owners.

- Microsoft Windows® is a registered trademark of Microsoft Corp.
- Intel® and Atom® are registered trademarks of Intel Corporation
- ITE is a trademark of Integrated Technology Express, Inc.
- IBM, PC/AT, PS/2, and VGA are trademarks of International Business Machines Corporation.
- Ubuntu and Canonical are registered trademarks of Canonical Ltd.
- Linux® is the registered trademark of Linus Torvalds in the U.S. and other countries.
- Realtek is a trademark of Realtek Semiconductor Corporation

All other product names or trademarks are properties of their respective owners.

Omission of a product name from this list does not imply any claim to ownership by the publisher of this document.

Packing List

Before setting up your product, please make sure the following items have been shipped:

Item	Quantity
● PICO-ASL4 Rev.B	1

If any of these items are missing or damaged, please contact your distributor or sales representative immediately.

About this Document

This User's Manual contains all the essential information, such as detailed descriptions and explanations on the product's hardware and software features (if any), its specifications, dimensions, jumper/connector settings/definitions, and driver installation instructions (if any), to facilitate users in setting up their product.

Users may refer to the product page on AAEON.com for the latest version of this document.

Safety Precautions

Please read the following safety instructions carefully. It is advised that you keep this manual for future references

1. All cautions and warnings on the device should be noted.
2. Make sure the power source matches the power rating of the device.
3. Position the power cord so that people cannot step on it. Do not place anything over the power cord.
4. Always completely disconnect the power before working on the system's hardware.
5. No connections should be made when the system is powered as a sudden rush of power may damage sensitive electronic components.
6. If the device is not to be used for a long time, disconnect it from the power supply to avoid damage by transient over-voltage.
7. Always disconnect this device from any AC supply before cleaning.
8. While cleaning, use a damp cloth instead of liquid or spray detergents.
9. Make sure the device is installed near a power outlet and is easily accessible.
10. Keep this device away from humidity.
11. Place the device on a solid surface during installation to prevent falls
12. Do not cover the openings on the device to ensure optimal heat dissipation.
13. Watch out for high temperatures when the system is running.
14. Do not touch the heat sink or heat spreader when the system is running
15. Never pour any liquid into the openings. This could cause fire or electric shock.
16. As most electronic components are sensitive to static electrical charge, be sure to ground yourself to prevent static charge when installing the internal components. Use a grounding wrist strap and contain all electronic components in any static-shielded containers.

17. If any of the following situations arises, please the contact our service personnel:
 - i. Damaged power cord or plug
 - ii. Liquid intrusion to the device
 - iii. Exposure to moisture
 - iv. Device is not working as expected or in a manner as described in this manual
 - v. The device is dropped or damaged
 - vi. Any obvious signs of damage displayed on the device
18. **DO NOT LEAVE THIS DEVICE IN AN UNCONTROLLED ENVIRONMENT WHERE THE STORAGE TEMPERATURE IS BELOW -20° C (-4°F) OR ABOVE 60°C (140°F) TO PREVENT DAMAGE.**

Warning!



This device complies with Part 15 FCC Rules. Operation is subject to the following two conditions: (1) this device may not cause harmful interference, and (2) this device must accept any interference received including interference that may cause undesired operation.

Caution:

There is a danger of explosion if the battery is incorrectly replaced. Replace only with the same or equivalent type recommended by the manufacturer. Dispose of used batteries according to the manufacturer's instructions and your local government's recycling or disposal directives.

Attention:

Il y a un risque d'explosion si la batterie est remplacée de façon incorrecte. Ne la remplacer qu'avec le même modèle ou équivalent recommandé par le constructeur. Recycler les batteries usées en accord avec les instructions du fabricant et les directives gouvernementales de recyclage.

China RoHS Requirements (CN)

产品中有毒有害物质或元素名称及含量

AAEON Main Board/ Daughter Board/ Backplane

部件名称	有毒有害物质或元素					
	铅 (Pb)	汞 (Hg)	镉 (Cd)	六价铬 (Cr(VI))	多溴联苯 (PBB)	多溴二苯醚 (PBDE)
印刷电路板 及其电子组件	X	X	○	○	○	○
外部信号 连接器及线材	X	X	○	○	○	○
<p>○: 表示该有毒有害物质在该部件所有均质材料中的含量均在 SJ/T 11363-2006 标准规定的限量要求以下。</p> <p>X: 表示该有毒有害物质至少在该部件的某一均质材料中的含量超出 SJ/T 11363-2006 标准规定的限量要求。</p> <p>备注: 此产品所标示之环保使用期限, 系指在一般正常使用状况下。</p>						

China RoHS Requirement (EN)

Poisonous or Hazardous Substances or Elements in Products

AAEON Main Board/ Daughter Board/ Backplane

Component	Poisonous or Hazardous Substances or Elements					
	Lead (Pb)	Mercury (Hg)	Cadmium (Cd)	Hexavalent Chromium (Cr(VI))	Polybrominated Biphenyls (PBB)	Polybrominated Diphenyl Ethers (PBDE)
PCB & Other Components	X	X	O	O	O	O
Wires & Connectors for External Connections	X	X	O	O	O	O
<p>O: The quantity of poisonous or hazardous substances or elements found in each of the component's parts is below the SJ/T 11363-2006-stipulated requirement.</p> <p>X: The quantity of poisonous or hazardous substances or elements found in at least one of the component's parts is beyond the SJ/T 11363-2006-stipulated requirement.</p> <p>Note: The Environment Friendly Use Period as labeled on this product is applicable under normal usage only</p>						

Table of Contents

Chapter 1 - Product Specifications	1
1.1 Specifications.....	2
1.2 Function Block Diagram.....	5
Chapter 2 – Hardware Information	6
2.1 Dimensions.....	7
2.2 Jumpers and Connectors	8
2.3 List of Jumpers.....	10
2.3.1 Clear CMOS Jumper & Auto Power Button Enable/Disable (JP1).....	10
2.4 List of Connectors	11
2.4.1 RTC Battery Connector (CN1).....	12
2.4.2 HDMI (CN2).....	12
2.4.3 LVDS Back Light Inverter (CN3).....	13
2.4.4 LVDS/eDP (CN4).....	14
2.4.5 Dual RJ-45 LAN (CN5)	16
2.4.6 SATA Connector (CN6).....	17
2.4.7 SATA Power Connector (CN7).....	17
2.4.8 Mini Card/mSATA (CN9).....	18
2.4.9 Dual USB 3.2 Port (CN11)	20
2.4.10 Dual USB 2.0 Port (CN12)	21
2.4.11 SPI (For BIOS) (CN15).....	21
2.4.12 4-Pin Fan (CN16).....	22
2.4.13 I2C/SMBus (CN17)	23
2.4.14 eSPI Debug Connector (CN18).....	23
2.4.15 M.2 2230 E-Key (CN19).....	24
2.4.16 Front Panel (CN22).....	26
2.4.17 Power Input +12V (CN23).....	27

2.4.18	DC Jack Power Input [Reserved] (CN24).....	28
2.4.19	Vcore Programing Connector (CN25).....	28
2.4.20	Audio Connector (CN28).....	29
2.4.21	Dual USB 2.0 Connector (CN29).....	29
2.4.22	4-bit GPIO (CN31).....	30
2.4.23	COM 1 ~ 4 Connector (CN32).....	31
2.4.24	DDR5 SODIMM (DIMM1).....	32
2.5	Thermal Assembly Options.....	33
2.5.1	Fanless Heatsink.....	33
2.5.2	Active Cooler.....	34
Chapter 3 - AMI BIOS Setup.....		35
3.1	System Test and Initialization.....	36
3.2	AMI BIOS Setup.....	37
3.3	Setup Submenu: Main.....	38
3.4	Setup Submenu: Advanced.....	39
3.4.1	CPU Configuration.....	40
3.4.2	PCH-FW Configuration.....	41
3.4.2.1	Firmware Update Configuration.....	42
3.4.3	PTT Configuration.....	43
3.4.4	Trusted Computing.....	44
3.4.5	SATA Configuration.....	46
3.4.6	Hardware Monitor.....	47
3.4.6.1	Smart Fan Mode Configuration.....	48
3.4.7	SIO Configuration.....	49
3.4.7.1	Serial Port 1 Configuration.....	50
3.4.7.2	Serial Port 2 Configuration.....	51
3.4.7.3	Serial Port 3 Configuration.....	52
3.4.7.4	Serial Port 4 Configuration.....	53

3.4.7.5	Serial Port Console Redirection	54
3.4.7.6	Legacy Console Redirection Settings	55
3.4.8	AAEON BIOS Robot.....	56
3.4.8.1	Device Detecting Configuration	58
3.4.9	Power Management	64
3.4.10	GPIO Port Configuration.....	65
3.5	Setup Submenu: Chipset.....	66
3.5.1	System Agent (SA) Configuration	67
3.5.1.1	Memory Configuration	68
3.5.1.2	LVDS Panel Configuration.....	69
3.5.2	PCH-IO Configuration.....	71
3.6	Setup Submenu: Security	72
3.6.1	Secure Boot	73
3.6.1.1	Key Management	74
3.7	Setup Submenu: Boot	76
3.7.1	BBS Priorities.....	77
3.8	Setup Submenu: Save & Exit	78
Chapter 4	– Drivers Installation.....	79
4.1	Drivers Download and Installation	80
Appendix A	– Mating Connectors	83
A.1	List of Mating Connectors and Cables	84
Appendix B	- I/O Information	85
B.1	I/O Address Map.....	86
B.2	IRQ Mapping Chart	88
B.3	Memory Address Map	101

Chapter 1

Product Specifications

1.1 Specifications

System

Form Factor	PICO-ITX
CPU	Intel Atom® Processors x7000RE Series: Intel Atom® x7433RE Processor (4C, 1.5 GHz, 9W) Intel Atom® x7835RE Processor (8C, 1.3 GHz, 12W)
Chipset	Integrated with Intel® SoC
Memory Type	DDR5 4800, Single-Channel SODIMM x 1, Max 16GB, Non-ECC
BIOS	UEFI
Wake on LAN	Yes
Watchdog Timer	255 Levels
Security	TPM 2.0
RTC Battery	Lithium Battery 3V/240mAh
Dimension	3.94" x 2.84" (100mm x 72mm)
Gross Weight	0.18 lb. (0.08Kg)
OS Support	Windows 10 (64-bit) Ubuntu 22.04.2/Kernel 5.19

Power

Power Requirement	+12V (Optional: +9V ~ 36V via power adapter card)
Power Supply Type	AT/ATX
Connector	Phoenix 2-pin Connector (Default) Lockable DC Jack Connector (Colay)
Power Consumption	Intel Atom® x7835RE, DDR5 16GB, 3.06A @+12V (Typical) Intel Atom® x7835RE, DDR5 16GB, 4.21A @+12V (Max)

Display

Controller	Intel® UHD Graphics for 12th Gen Intel® Processors
LVDS/eDP	LVDS x 1 (18/24bit 2CH) 1920 x 1200 @60Hz eDP 1.4 x 1, 3840 x 2160 @60Hz (Optional)
Display Interface	HDMI 1.4 x 1, 3840 x 2160 @30Hz
Multiple Display	Up to 2 Simultaneous Displays

Audio

Codec	Realtek ALC256
Audio Interface	Line-out (Optional, audio function not available for WiTAS SKU)
Speaker	—

External I/O

Ethernet	Intel® Ethernet Controller I226, 2.5GbE, RJ-45 x 1 Realtek RTL8111H-CG, 1GbE, RJ-45 x 1
USB	USB 3.2 Gen 2 x 2
Serial Port	—
Video	HDMI 1.4 x 1

Internal I/O

USB	USB 2.0 x 4
Serial Port	COM 1~2 (RS-232/422/485, supports 5V/12V/RI) COM 3~4 (RS-232)
Video	LVDS/eDP x 1 (Default: LVDS) Inverter x 1 (12V/2A)
SATA	SATA 6Gb/s x 1 +5V SATA Power Connector x 1

Internal I/O

Audio	Line-out Header x 1 (Optional, audio function not available for WiTAS SKU)
DIO/GPIO	GPIO 4-bit
SMBus/I2C	SMBus/ I2C x 1 (Default: SMBus)
Fan	4pins Smart Fan x1
Front Panel	HDD LED, PWR LED, Power Button, Buzzer, Reset
Others	—

Expansion

Mini PCIe/mSATA	Full-size mSATA/mPCIe x 1 (default: mSATA, select with BIOS)
M.2	M.2 2230 E-Key x 1
Others	—

Environmental

Operating Temperature	WiTAS 2: -40°F ~ 185°F (-40°C ~ 85°C)
Storage Temperature	-40°F ~ 185°F (-40°C ~ 85°C)
Operating Humidity	0% ~ 90% relative humidity, non-condensing
MTBF (Hours)	2,219,397
EMC	CE/FCC Class A

1.2 Function Block Diagram

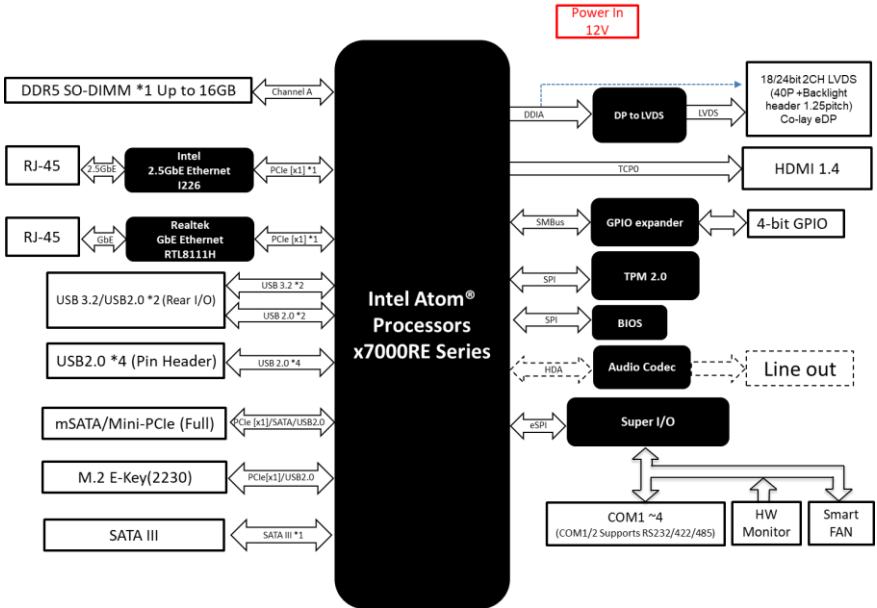

Chapter 2

Hardware Information

2.1 Dimensions

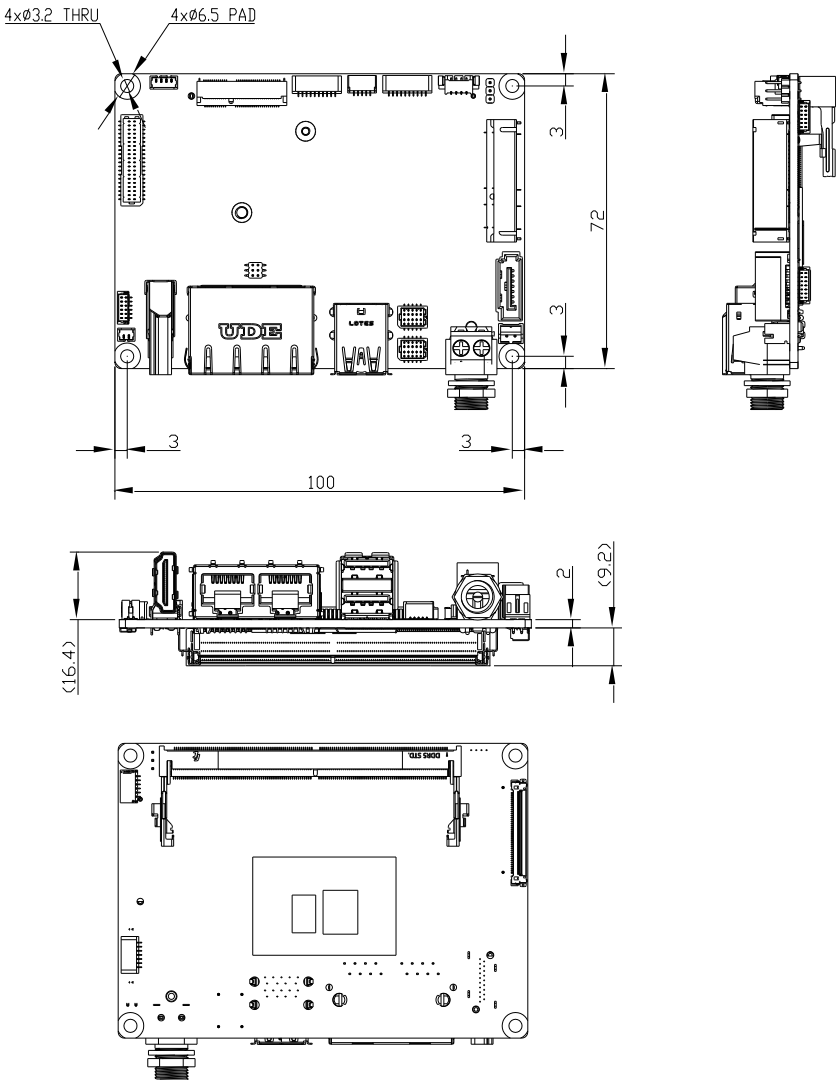

2.2 Jumpers and Connectors

Component Side

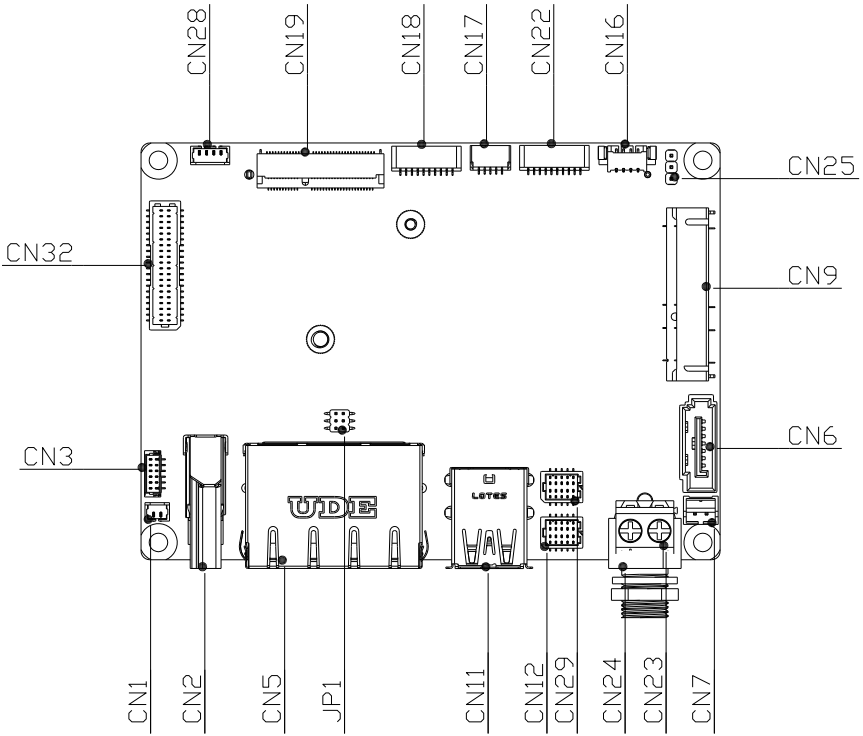

Solder Side

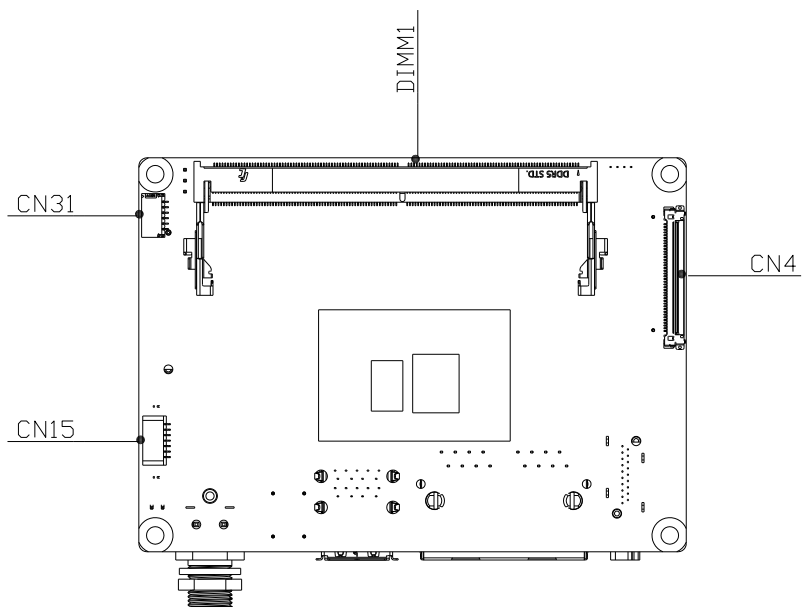

2.3 List of Jumpers

Jumpers allow users to manually customize system configurations to their suitable application needs.

Please refer to the table below for all of the board's jumpers that you can configure for your application

Label	Function
JP1	Clear CMOS Jumper & Auto Power Button Enable/Disable

2.3.1 Clear CMOS Jumper & Auto Power Button Enable/Disable (JP1)

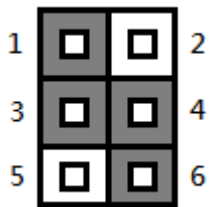

Clear CMOS Jumper	
Pin	Function
1-3	Save CMOS (Default)
3-5	Clear CMOS

Auto Power Button Enable/Disable	
Pin	Function
2-4	Disable
4-6	Enable (Default)

2.4 List of Connectors

Please refer to the table below for all of the board's connectors that you can configure for your application

Label	Function
CN1	RTC Battery Connector
CN2	HDMI
CN3	LVDS Back Light Inverter
CN4	LVDS/eDP
CN5	Dual RJ-45 LAN (Left I226-V/Right RTL8111H-CG)
CN6	SATA Connector
CN7	SATA Power Connector
CN9	Mini Card/mSATA
CN11	Dual USB 3.2 Port
CN12	Dual USB 2.0 Port
CN15	SPI (For BIOS)
CN16	4-Pin Fan
CN17	I2C/SMBus
CN18	eSPI Debug Connector
CN19	M.2 2230 E-Key
CN22	Front Panel
CN23	12V Power Input
CN24	DC Jack Power Input [Reserved]
CN25	Vcore Programing Connector
CN28	Audio Connector
CN29	Dual USB 2.0 Connector
CN31	4-bit GPIO
CN32	COM Connector (RS232/422/485 x 2, RS232 x 2)
DIMM1	DDR5 SODIMM

2.4.1 RTC Battery Connector (CN1)

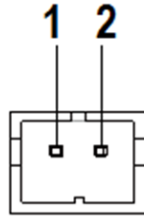

Pin	Pin Name	Signal Type	Signal Level
1	+3.3V	PWR	+3.3V
2	GND	GND	

2.4.2 HDMI (CN2)

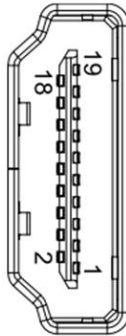

Pin	Pin Name	Signal Type	Signal Level
1	HDMI_TX2+	DIFF	
2	GND	GND	
3	HDMI_TX2-	DIFF	
4	HDMI_TX1+	DIFF	
5	GND	GND	
6	HDMI_TX1-	DIFF	
7	HDMI_TX0+	DIFF	
8	GND	GND	
9	HDMI_TX0-	DIFF	

Pin	Pin Name	Signal Type	Signal Level
10	HDMI_CLK+	DIFF	
11	GND	GND	
12	HDMI_CLK-	DIFF	
13	NC		
14	NC		
15	DDC_CLK	Signal	+5V
16	DDC_DATA	Signal	+5V
17	GND	GND	
18	+5V	PWR	+5V
19	HDMI_HPD		

2.4.3 LVDS Back Light Inverter (CN3)

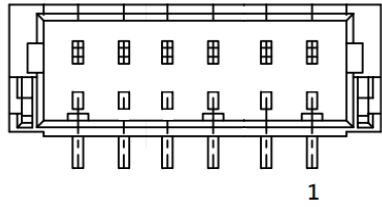

Pin	Pin Name	Signal Type	Signal Level
1	BLK_PWR	PWR	+12V (Default) / +5V
2	BLK_PWR	PWR	+12V (Default) / +5V
3	BKL_CONTROL	Signal	
4	GND	GND	
5	GND	GND	
6	BKL_ENABLE	Signal	

Note: Backlight power can be 12V or 5V by BOM. Stuff R307 for 12V and stuff R308 for 5V. [Default:12V].

Note: CN3 power current max: 2A.

2.4.4 LVDS/eDP (CN4)

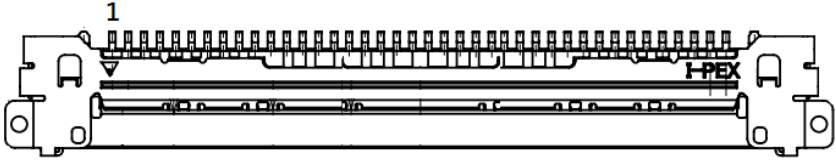

Pin	Pin Name	Signal Type	Signal Level
1	GND	GND	
2	LVD1_CB_3_DP	DIFF	
3	LVD1_CB_3_DN	DIFF	
4	GND	GND	
5	LVD1_CB_CLKP	DIFF	
6	LVD1_CB_CLKN	DIFF	
7	GND	GND	
8	LVD1_CB_2_DP	DIFF	
9	LVD1_CB_2_DN	DIFF	
10	GND	GND	
11	LVD1_CB_1_DP	DIFF	
12	LVD1_CB_1_DN	DIFF	
13	GND	GND	
14	LVD1_CB_0_DP	DIFF	
15	LVD1_CB_0_DN	DIFF	
16	GND	GND	
17	+V3P3S	PWR	+3.3V
18	LVD1_DDC_CLK/ DDIO_HPD	Signal	
19	LVD1_BKLTEN/ DDIO_BKLTEN	Signal	
20	LVD1_DDC_DATA	Signal	
21	LVD1_BKLCTL/ DDIO_BKLCTL	Signal	
22	GND	GND	
23	LVD1_CA_CLKP/ DDIO_AUX_DP	DIFF	

Pin	Pin Name	Signal Type	Signal Level
24	LVD1_CA_CLKN/ DDIO_AUX_DN	DIFF	
25	GND	GND	
26	LVD1_CA_3_DP/ DDIO_LANE3_DP	DIFF	
27	LVD1_CA_3_DN/ DDIO_LANE3_DN	DIFF	
28	GND	GND	
29	LVD1_CA_0_DP/ DDIO_LANE0_DP	DIFF	
30	LVD1_CA_0_DN/ DDIO_LANE0_DN	DIFF	
31	GND	GND	
32	LVD1_CA_1_DP/ DDIO_LANE1_DP	DIFF	
33	LVD1_CA_1_DN/ DDIO_LANE1_DN	DIFF	
34	GND	GND	
35	LVD1_CA_2_DP/ DDIO_LANE2_DP	DIFF	
36	LVD1_CA_2_DN/ DDIO_LANE2_DN	DIFF	
37	GND	GND	
38	+VDD	PWR	+3.3V
39	+VDD	PWR	+3.3V
40	+VDD	PWR	+3.3V

Note: CN4: VDD power current max: 1.5A.

2.4.5 Dual RJ-45 LAN (CN5)

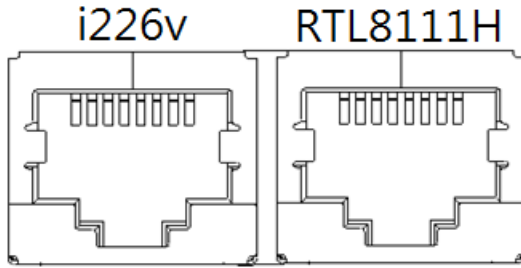

Pin	Pin Name	Pin	Pin Name
1P1	LAN2_MDIO_P	2P1	LAN1_MDIO_P
1P2	LAN2_MDIO_N	2P2	LAN1_MDIO_N
1P3	LAN2_MDI1_P	2P3	LAN1_MDI1_P
1P4	LAN2_MDI1_N	2P4	LAN1_MDI1_N
1P5	1CT5	2P5	2CT5
1P6	1CT6	2P6	2CT6
1P7	LAN2_MDI2_P	2P7	LAN1_MDI2_P
1P8	LAN2_MDI2_N	2P8	LAN1_MDI2_N
1P9	LAN2_MDI3_P	2P9	LAN1_MDI3_P
1P10	LAN2_MDI3_N	2P10	LAN1_MDI3_N

2.4.6 SATA Connector (CN6)

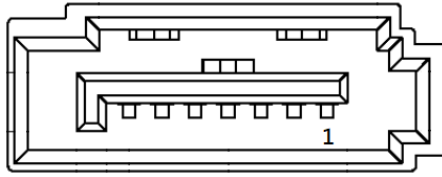

Pin	Pin Name	Signal Type	Signal Level
1	GND	GND	
2	SATA_1_TXP	DIFF	
3	SATA_1_TXN	DIFF	
4	GND	GND	
5	SATA_1_RXN	DIFF	
6	SATA_1_RXP	DIFF	
7	GND	GND	

2.4.7 SATA Power Connector (CN7)

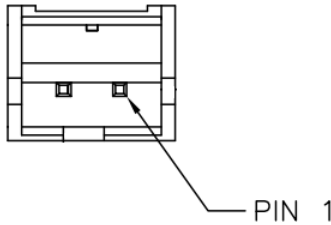

Pin	Pin Name	Signal Type	Signal Level
1	+VSS	VDD	5V
2	GND	GND	

Note: CN7 SATA power current max: 1.5A.

2.4.8 Mini Card/mSATA (CN9)

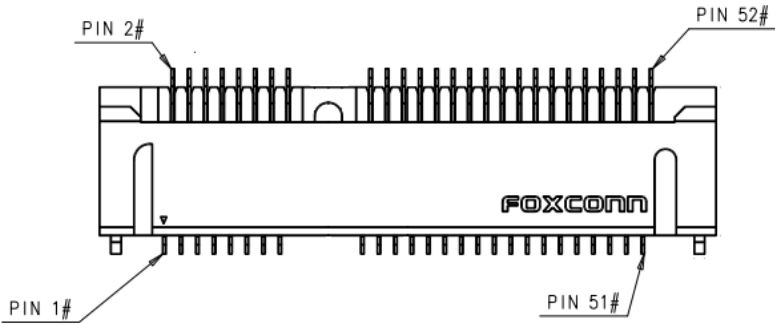

Pin	Pin Name	Signal Type	Signal Level
1	PCIE_WAKE#	Signal	
2	+3.3V	PWR	+3.3V
3	NC		
4	GND	GND	
5	NC		
6	+1.5V	PWR	+1.5V
7	PCIE_CLK_REQ#	Signal	
8	NC		
9	GND	GND	
10	NC		
11	PCIE_REF_CLK-	DIFF	
12	NC		
13	PCIE_REF_CLK+	DIFF	
14	NC		
15	GND	GND	
16	NC		
17	NC		
18	GND	GND	
19	NC		
20	W_DISABLE#	Signal	+3.3V

Pin	Pin Name	Signal Type	Signal Level
21	GND	GND	
22	PCIE_RST#	Signal	+3.3V
23	PCIE_RX-/SATA_RX+	DIFF	
24	+3.3V	PWR	+3.3V
25	PCIE_RX+/SATA_RX-	DIFF	
26	GND	GND	
27	GND	GND	
28	+1.5V	PWR	+1.5V
29	GND	GND	
30	SMB_CLK	Signal	+3.3V
31	PCIE_TX-/SATA_TX-	DIFF	
32	SMB_DATA	Signal	+3.3V
33	PCIE_TX+/SATA_TX+	DIFF	
34	GND	GND	
35	GND	GND	
36	USB_D-	DIFF	
37	GND	GND	
38	USB_D+	DIFF	
39	+3.3V	PWR	+3.3V
40	GND	GND	
41	+3.3V	PWR	+3.3V
42	NC		
43	GND	GND	
44	NC		
45	NC		
46	NC		

2.4.9 Dual USB 3.2 Port (CN11)

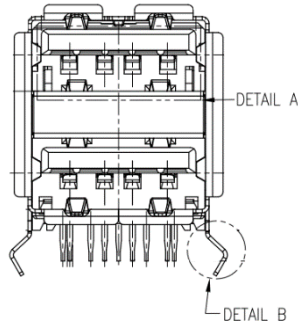

Pin	Pin Name	Signal Type	Signal Level
1	+V5A_USB12	PWR	+5V(0.9A)
2	USB2_0_DN	DIFF	
3	USB2_0_DP	DIFF	
4	GND	GND	
5	USB3_0_RXN	DIFF	
6	USB3_0_RXP	DIFF	
7	GND	GND	
8	USB3_0_TXN	DIFF	
9	USB3_0_TXP	DIFF	
10	+V5A_USB12	PWR	+5V(0.9A)
11	USB2_1_DN	DIFF	
12	USB2_1_DP	DIFF	
13	GND		
14	USB3_1_RXN	DIFF	
15	USB3_1_RXP	DIFF	
16	GND		
17	USB3_1_TXN	DIFF	
18	USB3_1_TXP	DIFF	

Note: USB 3.2 power current max: 0.9A.

2.4.10 Dual USB 2.0 Port (CN12)

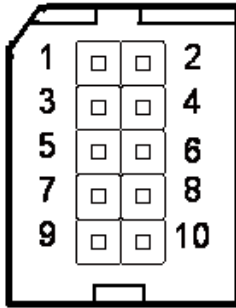

Pin	Pin Name	Signal Type	Signal Level
1	+5VSB(0.5A)	2	+5VSB(0.5A)
3	USB3_D-	4	USB4_D-
5	USB3_D+	6	USB4_D+
7	GND	8	GND
9	GND	10	GND

Note: USB 2.0 power current max: 0.5A.

2.4.11 SPI (For BIOS) (CN15)

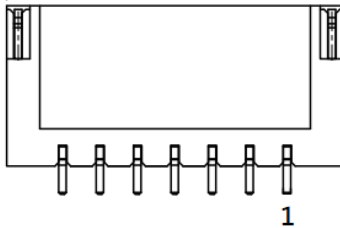

Pin	Pin Name	Signal Type	Signal Level
1	SPI_SO	Signal	
2	GND	GND	
3	SPI_CLK	Signal	
4	+V3P3A_SPI	PWR	3.3A

Pin	Pin Name	Signal Type	Signal Level
5	SPI_SI	Signal	
6	SPI_CS	Signal	
7	NC		

2.4.12 4-Pin Fan (CN16)

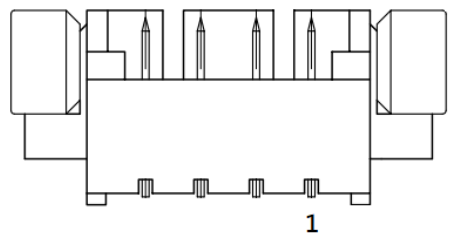

Pin	Pin Name	Signal Type	Signal Level
1	GND	GND	
2	+V12S	PWR	+12V
3	FAN_TAC	Signal	
4	FAN_CTL	Signal	

Note: CN16 Smart fan power current max: 1.0A.

2.4.13 I2C/SMBus (CN17)

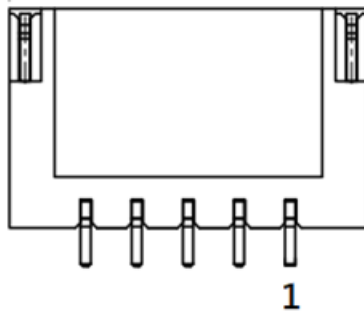

Pin	Pin Name	Signal Type	Signal Level
1	+V3P3A/+V3P3S	PWR	+3.3V
2	SMB_CLK/I2C_CLK	IN/OUT	+3.3V
3	SMB_DATA/I2C_DATA	OUT	+3.3V
4	SMBALERT#/INT _SERIRQ	IN	+3.3V
5	GND	PWR	+3.3V

2.4.14 eSPI Debug Connector (CN18)

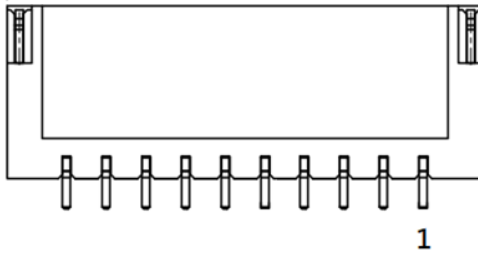

Pin	Pin Name	Signal Type	Signal Level
1	ESPI_IO0	Signal	+1.8V
2	ESPI_IO1	Signal	+1.8V
3	ESPI_IO2	Signal	+1.8V
4	ESPI_IO3	Signal	+1.8V
5	+V3.3S	PWR	+3.3V

Pin	Pin Name	Signal Type	Signal Level
6	ESPI_CS	Signal	
7	ESPI_RESET#	Signal	+1.8V
8	GND	GND	
9	ESPI_CLK	Signal	1.8V
10	+V3P3A	Signal	+3.3V

2.4.15 M.2 2230 E-Key (CN19)

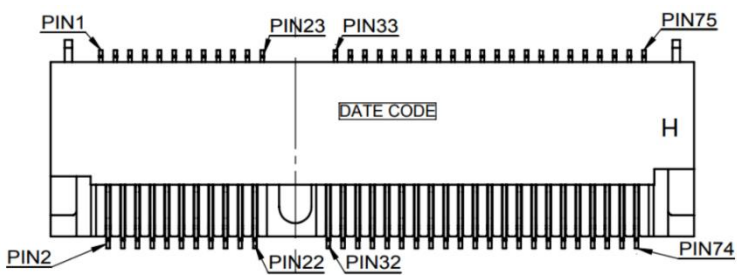

Pin	Pin Name	Signal Type	Signal Level
1	GND	GND	GND
2	+V3P3A	PWR	+3.3V
3	USB2_10_DP	DIFF	-
4	+V3P3A	PWR	+3.3V
5	USB2_10_DN	DIFF	-
6	NC	-	-
7	GND	GND	GND
8	NC	-	-
9	CNV_WR_D1_DN	DIFF	-
10	KEYE_CNV_RF_RST	IN	-
11	CNV_WR_D1_DP	DIFF	-
12	NC	-	-
13	GND	GND	GND
14	KEYE_CNV_CLKREQ	OUT	-
15	CNV_WR_D0_DN	DIFF	-

Pin	Pin Name	Signal Type	Signal Level
16	NC	-	-
17	CNV_WR_D0_DP	DIFF	-
18	GND	GND	GND
19	GND	GND	GND
20	KEYE_UART_WAKE_N	IN	-
21	CNV_WR_CLK_DN	DIFF	-
22	CNV_BRI_RSP	IN	-
23	CNV_WR_CLK_DP	DIFF	-
32	CNV_RGI_DT	IN	-
33	GND	GND	GND
34	CNV_RGI_RSP	OUT	-
35	PCIE_8_TXP	DIFF	-
36	CNV_BRI_DT	-	-
37	PCIE_8_TXN	DIFF	-
38	MLK_RST_N	IN	-
39	GND	GND	GND
40	MLK_DATA	IN/OUT	-
41	PCIE_8_RXP	DIFF	-
42	MLK_CLK	IN	-
43	PCIE_8_RXN	DIFF	-
44	NC	-	-
45	GND	GND	GND
46	NC	-	-
47	PCIE_3_CLK_DP	DIFF	-
48	NC	-	-
49	PCIE_3_CLK_DN	DIFF	-
50	SUS_CLK	IN	-
51	GND	GND	GND
52	BUF_PLT_RST#	IN	-
53	PCIE_CLKREQ#3	OUT	-
54	NC	-	-
55	PCIE_WAKE#	IN/OUT	-
56	NC	-	-

Pin	Pin Name	Signal Type	Signal Level
57	GND	GND	GND
58	NC	-	-
59	CNV_WT_D1_DN	DIFF	-
60	NC	-	-
61	CNV_WT_D1_DP	DIFF	-
62	NC	-	-
63	GND	GND	GND
64	NC	-	-
65	CNV_WT_D0_DN	DIFF	-
66	NC	-	-
67	CNV_WT_D0_DP	DIFF	-
68	NC	-	-
69	GND	GND	GND
70	NC	-	-
71	CNV_WT_CLK_DN	DIFF	-
72	+V3P3A	PWR	+3.3V
73	CNV_WT_CLK_DP	DIFF	-
74	+V3P3A	PWR	+3.3V
75	GND	GND	GND

2.4.16 Front Panel (CN22)

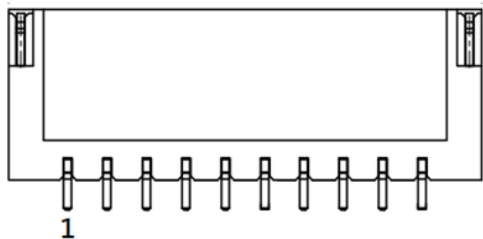

Pin	Pin Name	Signal Type	Signal Level
1	GND	GND	
2	EXT_PWRBTN#	Signal	
3	FP_IDELED#	Signal	

Pin	Pin Name	Signal Type	Signal Level
4	+V3P3S	PWR	+3.3V
5	FP_BUZZER	Signal	
6	+V5S	PWR	+5V
7	GND		
8	+V3P3S	PWR	+3.3V
9	GND		
10	HWRST#	Signal	

2.4.17 Power Input +12V (CN23)

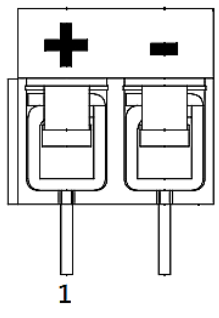

Pin	Pin Name	Signal Type	Signal Level
1	+V_IN	PWR	+12V
2	GND	GND	

2.4.18 DC Jack Power Input [Reserved] (CN24)

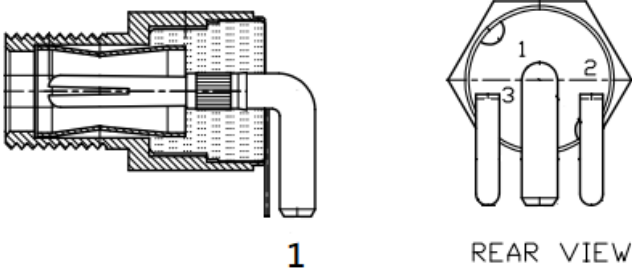

Pin	Pin Name	Signal Type	Signal Level
1	+V_IN	PWR	+12V
2	GND	GND	
3	GND	GND	

2.4.19 Vcore Programming Connector (CN25)

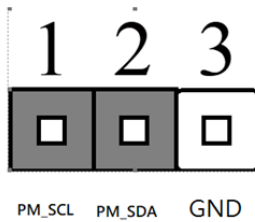

Pin	Pin Name	Signal Type	Signal Level
1	PM_SCL	IN/OUT	3.3V
2	PM_SDA	IN/OUT	3.3V
3	GND	GND	

2.4.20 Audio Connector (CN28)

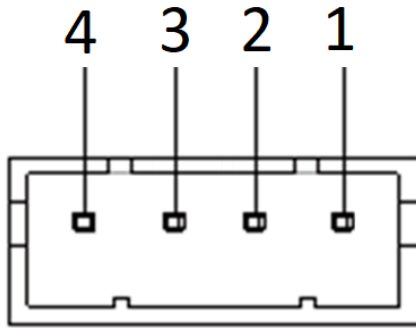

Pin	Pin Name	Signal Type	Signal Level
1	LOUT_R	Signal	
2	AUD_GND	GND	
3	LOUT_L	Signal	
4	AUD_GND	GND	

2.4.21 Dual USB 2.0 Connector (CN29)

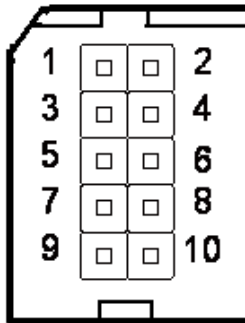

Pin	Pin Name	Signal Type	Signal Level
1	+5VSB(0.5A)	2	+5VSB(0.5A)
3	USB5_D-	4	USB6_D-
5	USB5_D+	6	USB6_D+

Pin	Pin Name	Signal Type	Signal Level
7	GND	8	GND
9	GND	10	GND

Note: USB 2.0 power current max: 0.5A.

2.4.22 4-bit GPIO (CN31)

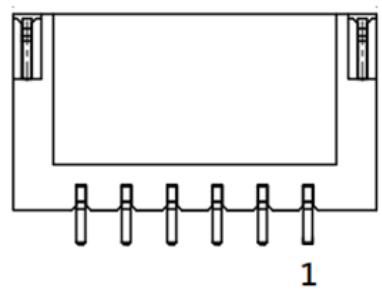

Pin	Pin Name	Signal Type	Signal Level
1	+V5S	VDD	5V
2	GPIO_0	Signal	
3	GPIO_1	Signal	
4	GPIO_2	Signal	
5	GPIO_3	Signal	
6	GND	GND	

Note: CN31 GPIO power current max: 0.5A.

2.4.23 COM 1 ~ 4 Connector (CN32)

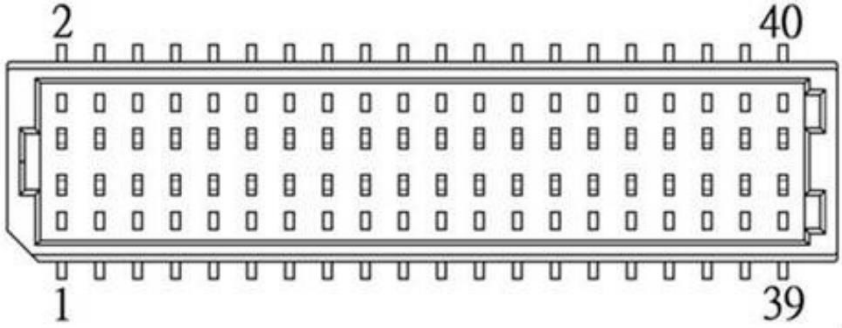

RS-232/422/485			
Pin	Pin Name	Signal Type	Signal Level
1	COM1: DCD/RS422_TX-/RS485_D-	IN / OUT	±5V
2	COM2: DCD/RS422_TX-/RS485_D-	IN / OUT	±5V
3	COM1: RX / RS422_TX+ / RS485_D+	IN / OUT	±5V
4	COM2: RX / RS422_TX+ / RS485_D+	IN / OUT	±5V
5	COM1: TX / RS422_RX+	OUT / IN	±5V
6	COM2: TX / RS422_RX+	OUT / IN	±5V
7	COM1: DTR / RS422_RX-	OUT / IN	±5V
8	COM2: DTR / RS422_RX-	OUT / IN	±5V
9	COM1: GND	GND	
10	COM2: GND	GND	
11	COM1: DSR	IN	
12	COM2: DSR	IN	
13	COM1: RTS	OUT	±5V
14	COM2: RTS	OUT	±5V
15	COM1: CTS	IN	
16	COM2: CTS	IN	
17	COM1: RI	IN/ PWR	+5V/+12V
18	COM2: RI/+5V/+12V	IN/ PWR	+5V/+12V
19	N.C	N.C	

RS-232/422/485			
Pin	Pin Name	Signal Type	Signal Level
20	N.C	N.C	
21	COM3: DCD / RS422_TX-/ RS485_D-	IN / OUT	±5V
22	COM4: DCD/ RS422_TX-/ RS485_D-	IN / OUT	±5V
23	COM3: RX / RS422_TX+ / RS485_D+	IN / OUT	±5V
24	COM4: RX / RS422_TX+ / RS485_D+	IN / OUT	±5V
25	COM3: TX / RS422_RX+	OUT / IN	±5V
26	COM4: TX / RS422_RX+	OUT / IN	±5V
27	COM3: DTR / RS422_RX-	OUT / IN	±5V
28	COM4: DTR / RS422_RX-	OUT / IN	±5V
29	COM3: GND	GND	
30	COM4: GND	GND	
31	COM3: DSR	IN	
32	COM4: DSR	IN	
33	COM3: RTS	OUT	±5V
34	COM4: RTS	OUT	±5V
35	COM3: CTS	IN	
36	COM4: CTS	IN	
37	COM3: RI/+5V/+12V	IN/ PWR	+5V/+12V
38	COM4: RI	IN/ PWR	+5V/+12V
39	N.C	N.C	
40	N.C	N.C	

2.4.24 DDR5 SODIMM (DIMM1)

Reverse specification.

2.5 Thermal Assembly Options

2.5.1 Fanless Heatsink

Heatsink, Part Number: PICO-ASL4-HSK01.

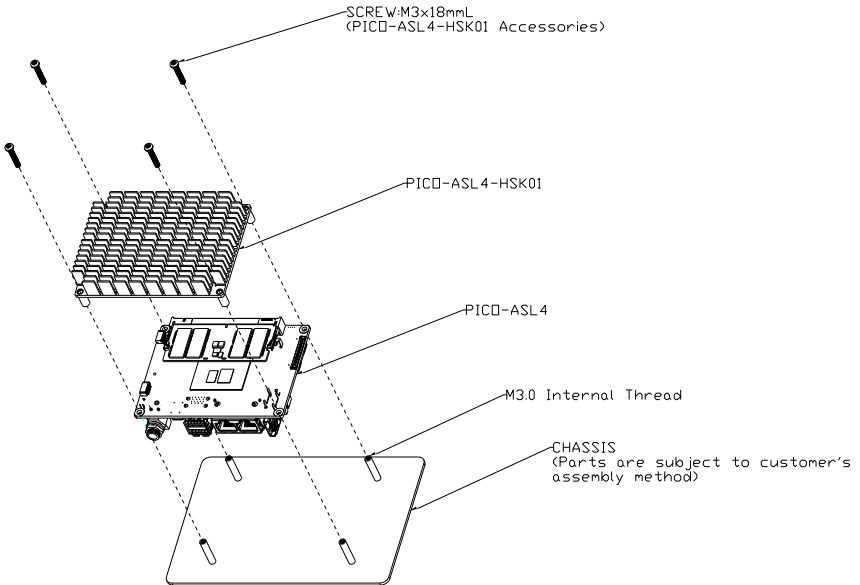

2.5.2 Active Cooler

Fan, Part Number: PICO-ASL4-FAN01.

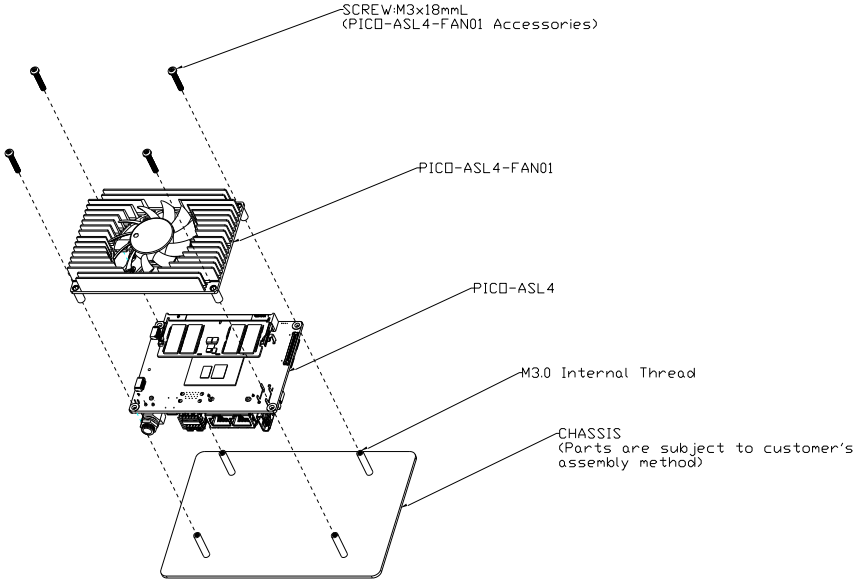

Chapter 3

AMI BIOS Setup

3.1 System Test and Initialization

These routines test and initialize board hardware. If the routines encounter an error during the tests, you will either hear a few short beeps or see an error message on the screen. There are two kinds of errors: fatal and non-fatal. The system can usually continue the boot up sequence with non-fatal errors.

System configuration verification

These routines check the current system configuration stored in the CMOS memory and BIOS NVRAM. If system configuration is not found or a system configuration data error is detected, the system will load optimized default and re-boot with this default system configuration automatically.

There are four situations in which you will need to setup system configuration:

1. You are starting your system for the first time
2. You have changed the hardware attached to your system
3. The system configuration is reset by Clear-CMOS jumper
4. The CMOS memory has lost power and the configuration information has been erased.

The PICO-ASL4 CMOS memory has an integral lithium battery backup for data retention. However, you will need to replace the complete unit when it finally runs down.

3.2 AMI BIOS Setup

AMI BIOS ROM has a built-in Setup program that allows users to modify the basic system configuration. This type of information is stored in battery-backed CMOS RAM and BIOS NVRAM so that it retains the Setup information when the power is turned off.

Entering Setup

Power on the computer and press or <ESC> immediately. This will allow you to enter Setup.

Main

Set the date, use tab to switch between date elements.

Advanced

Enable/disable feature configurations.

Chipset

Host bridge parameters.

Boot

Enables/disable quiet boot option.

Security

Set setup administrator password.

Save & Exit

Exit system setup after saving the changes.

3.3 Setup Submenu: Main

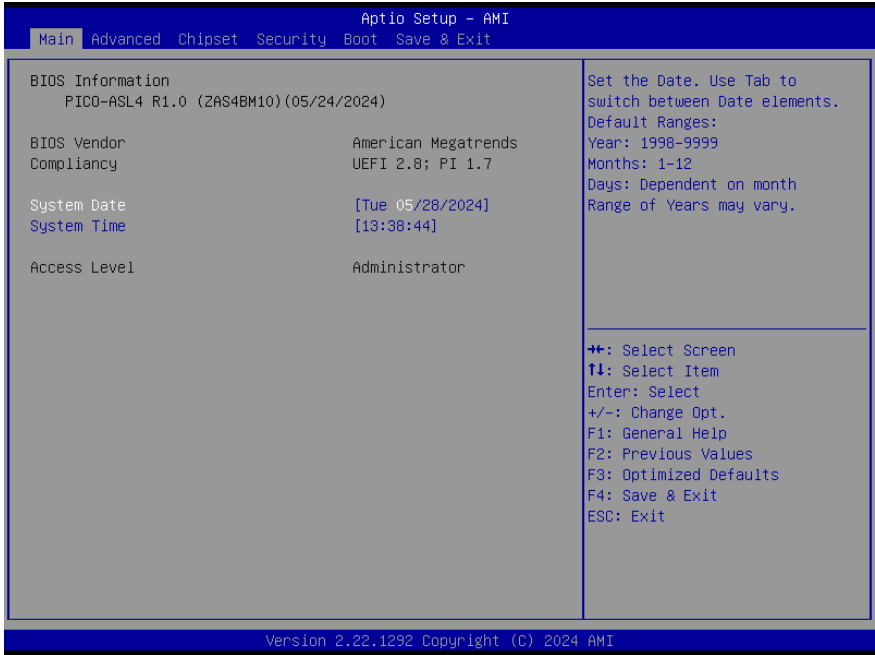

3.4 Setup Submenu: Advanced

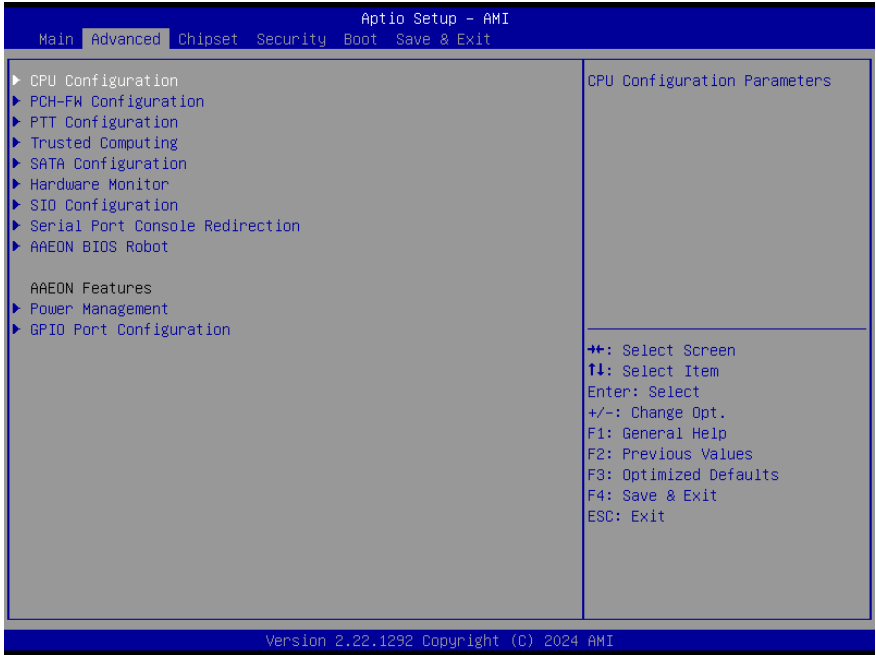

3.4.1 CPU Configuration

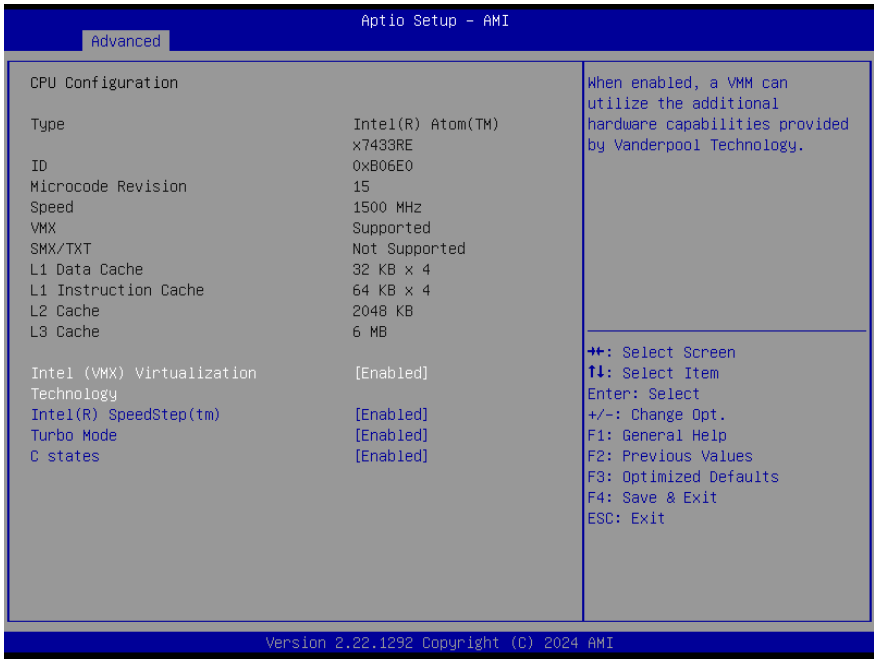

Options Summary		
Intel (VMX) Virtualization Technology	Disabled	
	Enabled	Optimal Default, Failsafe Default
When enabled, a VMM can utilize the additional hardware capabilities provided by Vanderpool Technology.		
Intel® SpeedStep™	Disabled	
	Enabled	Optimal Default, Failsafe Default
Allows more than two frequency ranges to be supported.		
Turbo Mode	Disabled	
	Enabled	Optimal Default, Failsafe Default
Enable or Disable processor Turbo Mode (requires EMTTM enable too). AUTO means enabled.		
C states	Disabled	
	Enabled	Optimal Default, Failsafe Default
Enable/Disable CPU Power Management. Allows CPU to go to C states when it's not 100 utilized.		

3.4.2 PCH-FW Configuration

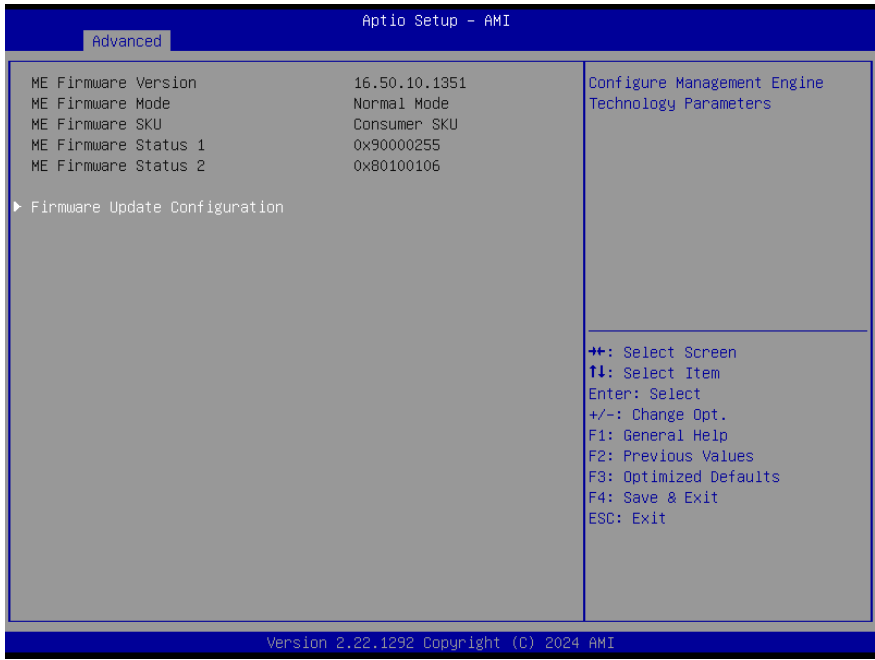

3.4.2.1 Firmware Update Configuration

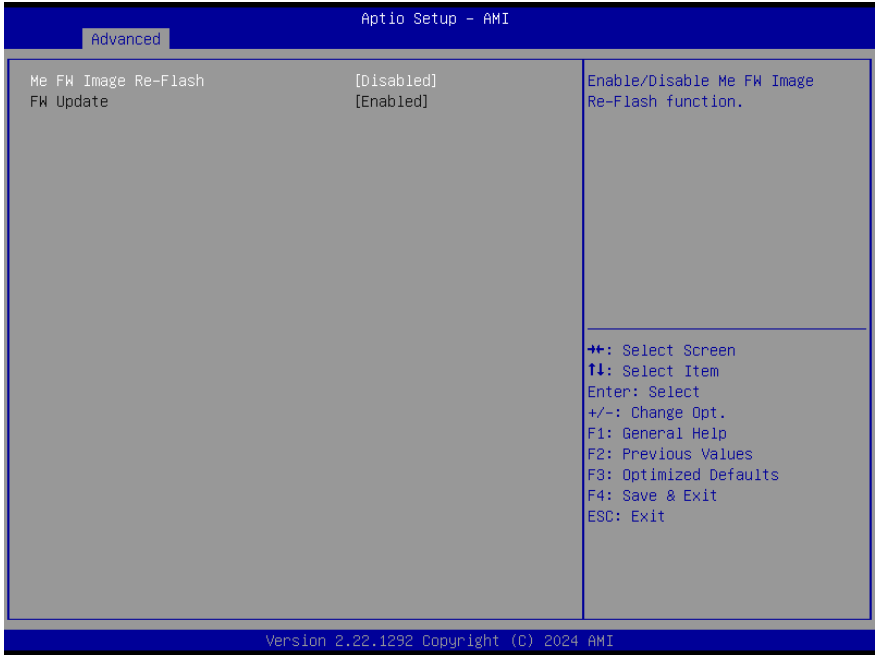

Options Summary		
Me FW Image Re-Flash	Enabled	
	Disabled	Optimal Default, Failsafe Default
Enable/Disable Me FW Image Re-Flash function.		
FW Update	Disabled	
	Enabled	Optimal Default, Failsafe Default
Enable/Disable ME FW Update function.		

3.4.3 PTT Configuration



Options Summary		
TPM Device Selection	dTPM	
	PTT	Optimal Default, Failsafe Default
Selects TPM device: PTT or discrete TPM. PTT - enables PTT in SkuMgr. dTPM - disables PTT in SkuMgr. Warning! PTT/dTPM will be disabled and all data saved on it will be lost.		

3.4.4 Trusted Computing

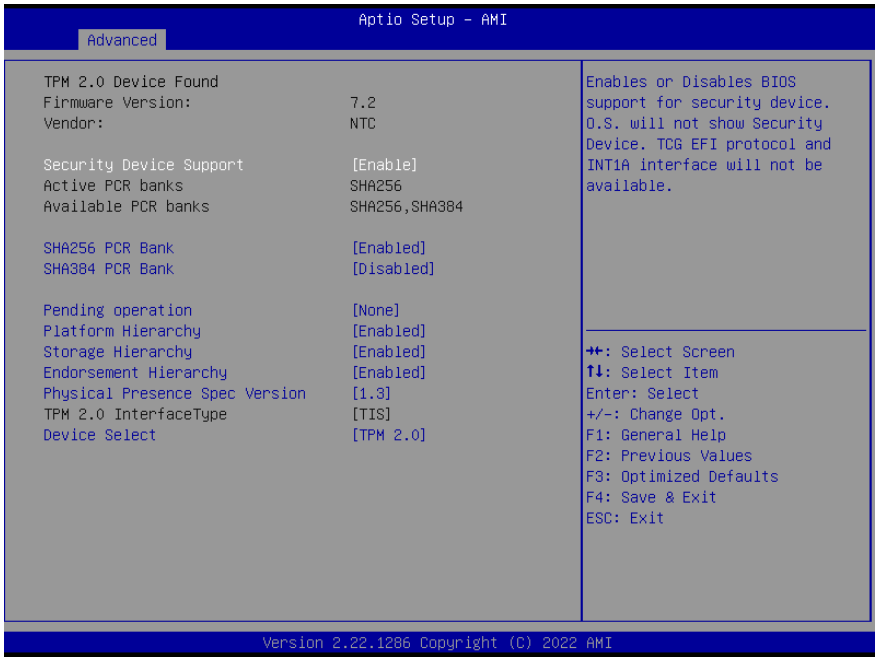

Options Summary		
Security Device Support	Enable	Optimal Default, Failsafe Default
	Disable	
Enables or Disables BIOS support for security device. O.S. will not show Security Device. TCG EFI protocol and INT1A interface will not be available.		
SHA256 PCR Bank	Enabled	Optimal Default, Failsafe Default
	Disabled	
Enable or Disable SHA256 PCR Bank.		
SHA384 PCR Bank	Enabled	Optimal Default, Failsafe Default
	Disabled	
Enable or Disable SHA384 PCR Bank.		
Pending operation	None	Optimal Default, Failsafe Default
	TPM Clear	
Schedule an Operation for the Security Device. NOTE: Your Computer will reboot during restart in order to change State of Security Device.		
Platform Hierarchy	Enabled	Optimal Default, Failsafe Default
	Disabled	
Enable or Disable Platform Hierarchy.		

Options Summary		
Storage Hierarchy	Enabled	Optimal Default, Failsafe Default
	Disabled	
Enable or Disable Storage Hierarchy.		
Endorsement Hierarchy	Enabled	Optimal Default, Failsafe Default
	Disabled	
Enable or Disable Endorsement Hierarchy.		
Physical Presence Spec Version	1.3	Optimal Default, Failsafe Default
	1.2	
Select to Tell O.S. to support PPI Spec Version 1.2 or 1.3. Note some HCK tests might not support 1.3.		
Device Select	Auto	
	TPM 1.2	
	TPM 2.0	Optimal Default, Failsafe Default
TPM 1.2 will restrict support to TPM 1.2 devices. TPM 2.0 will restrict support to TPM 2.0 devices. Auto will support both with the default set to TPM 2.0 devices if not found. TPM 1.2 devices will be enumerated.		

3.4.5 SATA Configuration

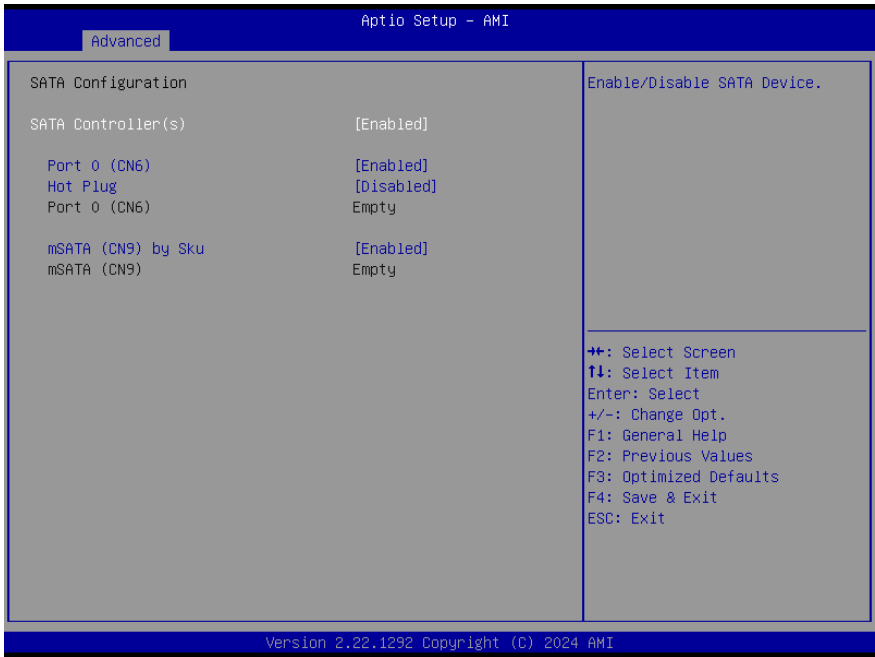

Options Summary		
SATA Controller(s)	Enabled	Optimal Default, Failsafe Default
	Disabled	
Enable/Disable SATA Device.		
Port 0 (CN10)	Enabled	Optimal Default, Failsafe Default
	Disabled	
Enable or Disable SATA Port.		
Port1(CN11)/mSATA (CN8)	Enabled	Optimal Default, Failsafe Default
	Disabled	
Enable or Disable SATA Port.		

3.4.6 Hardware Monitor

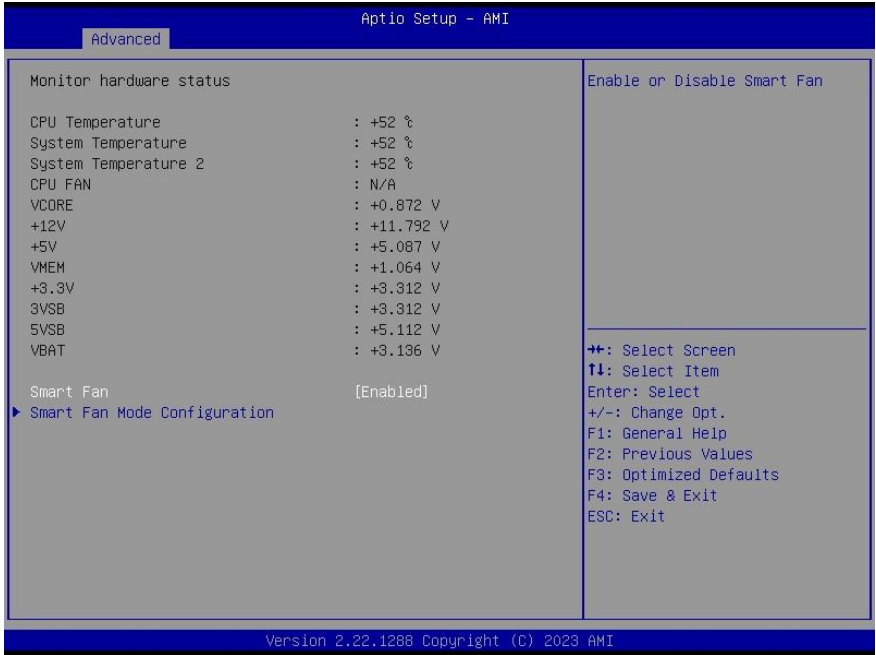

Options Summary		
Smart Fan	Disabled	
	Enabled	Optimal Default, Failsafe Default
Enables or Disables Smart Fan.		

3.4.6.1 Smart Fan Mode Configuration



Options Summary		
Fan 1 Smart Fan Control	Manual Duty Mode	
	Auto Duty-Cycle Mode	Optimal Default, Failsafe Default
Smart Fan Mode Select		
Temperature Source	CPU Temperature	
	System Temperature	Optimal Default, Failsafe Default
	System Temperature 2	
Select the monitored temperature source for this fan.		
Temperature 1	86	
Duty Cycle 1	100	
Auto fan speed control. Fan speed will follow different temperature by different duty cycle 1-100		

3.4.7 SIO Configuration



3.4.7.1 Serial Port 1 Configuration

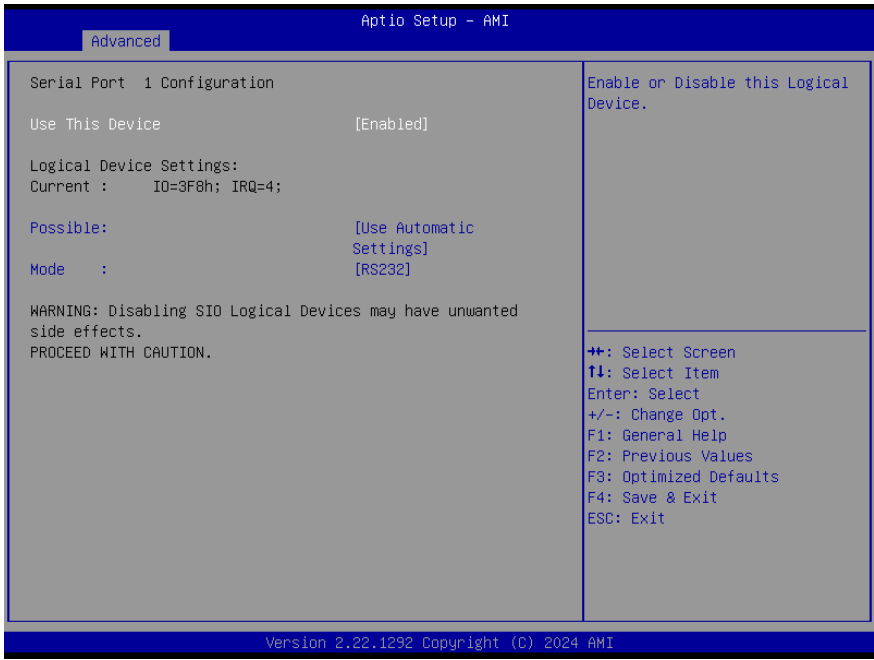

Options Summary		
Use This Device	Disable	
	Enable	Optimal Default, Failsafe Default
Enable or Disable this Logical Device.		
Possible:	Use Automatic Settings	Optimal Default, Failsafe Default
	IO=3F8h; IRQ=4	
	IO=2F8h; IRQ=3	
Allows user to change Device's Resource settings. New settings will be reflected on This Setup Page after System restarts.		
Mode:	RS232	Optimal Default, Failsafe Default
	RS422	
	RS485	
UART RS232, 422, 485 selection.		

3.4.7.2 Serial Port 2 Configuration

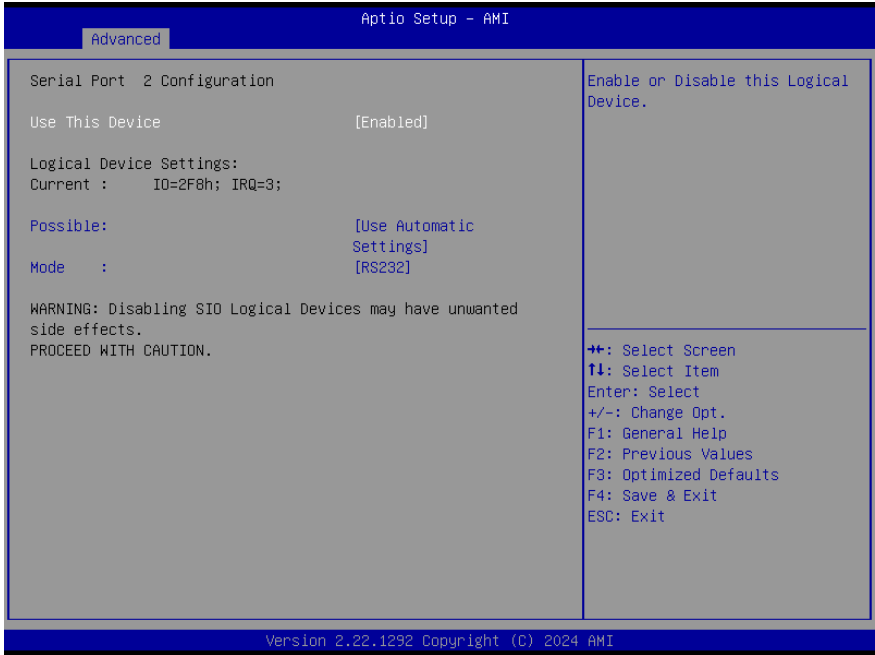

Options Summary		
Use This Device	Disable	
	Enable	Optimal Default, Failsafe Default
Enable or Disable this Logical Device.		
Possible:	Use Automatic Settings	Optimal Default, Failsafe Default
	IO=2F8h; IRQ=3	
	IO=3F8h; IRQ=4	
Allows user to change Device's Resource settings. New settings will be reflected on This Setup Page after System restarts.		
Mode:	RS232	Optimal Default, Failsafe Default
	RS422	
	RS485	
UART RS232, 422, 485 selection.		

3.4.7.3 Serial Port 3 Configuration

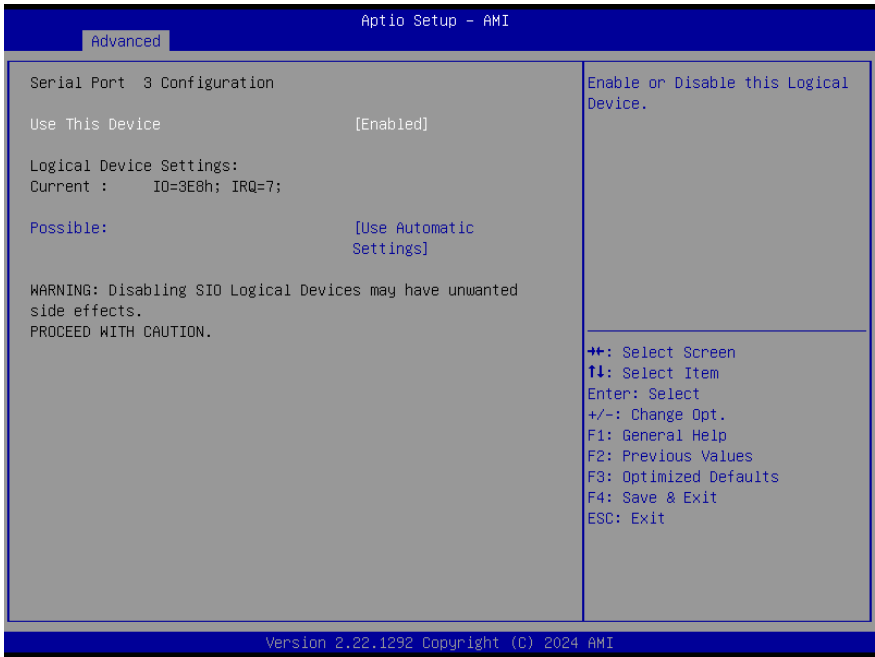

Options Summary		
Use This Device	Disable	
	Enable	Optimal Default, Failsafe Default
Enable or Disable this Logical Device.		
Possible:	Use Automatic Settings	Optimal Default, Failsafe Default
	IO=2F8h; IRQ=3	
	IO=3F8h; IRQ=4	
Allows user to change Device's Resource settings. New settings will be reflected on This Setup Page after System restarts.		
Mode:	RS232	Optimal Default, Failsafe Default
UART RS232 selection.		

3.4.7.4 Serial Port 4 Configuration

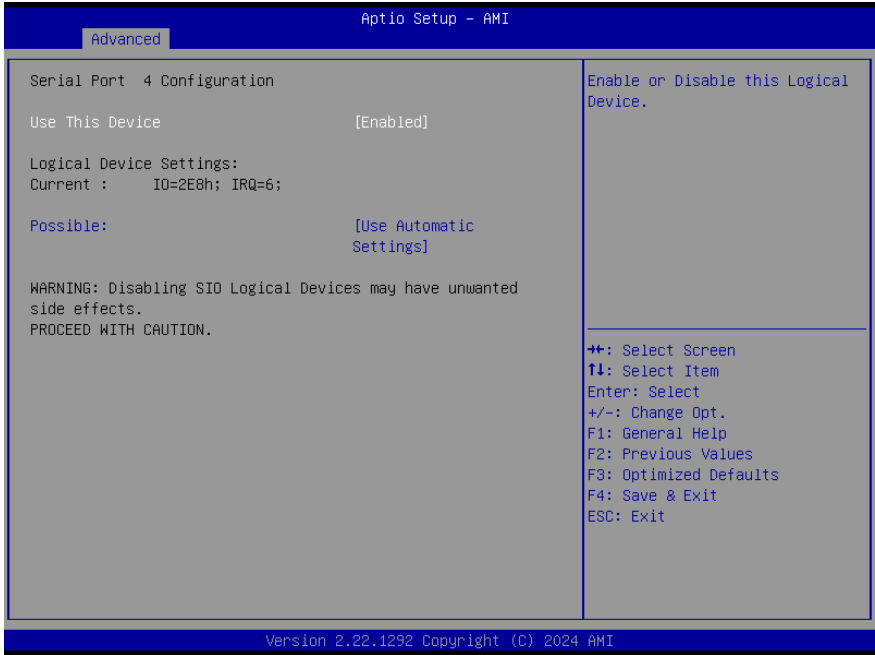

Options Summary		
Use This Device	Disable	
	Enable	Optimal Default, Failsafe Default
Enable or Disable this Logical Device.		
Possible:	Use Automatic Settings	Optimal Default, Failsafe Default
	IO=2F8h; IRQ=3	
	IO=3F8h; IRQ=4	
Allows user to change Device's Resource settings. New settings will be reflected on This Setup Page after System restarts.		
Mode:	RS232	Optimal Default, Failsafe Default
UART RS232 selection.		

3.4.7.5 Serial Port Console Redirection

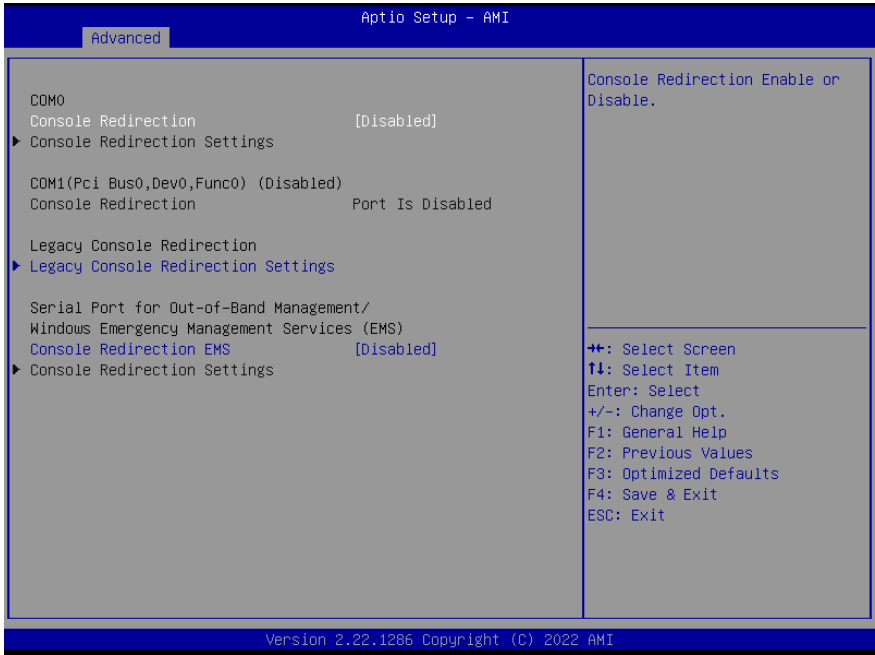

Options Summary		
Console Redirection	Disabled	
	Enabled	Optimal Default, Failsafe Default
Console Redirection Enable or Disable.		
Console Redirection EMS	Disabled	Optimal Default, Failsafe Default
	Enabled	
Console Redirection Enable or Disable.		

3.4.7.6 Legacy Console Redirection Settings

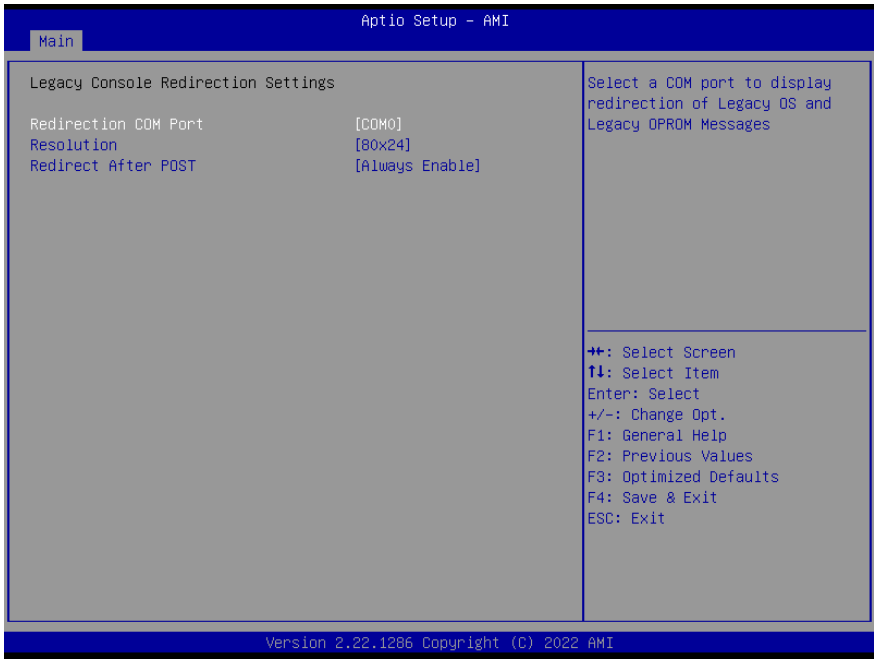

Options Summary		
Redirection COM port	COM0	Optimal Default, Failsafe Default
	COM1(Pci Bus0, Dev0, Func0) (Disabled)	
Select a COM Port to display redirection of Legacy OS and Legacy OPRM message.		
Resolution	80x24	Optimal Default, Failsafe Default
	80x25	
On Legacy OS, the number of Rows and Columns supported redirection.		
Redirect After POST	Always Enable	Optimal Default, Failsafe Default
	BootLoader	
When Bootloader is selected, then Legacy Console Redirection is disabled before booting to legacy OS.		
When Always Enable is selected, then Legacy Console Redirection is enabled for legacy OS.		
Default setting for this option is set to Always Enable.		

3.4.8 AAEON BIOS Robot

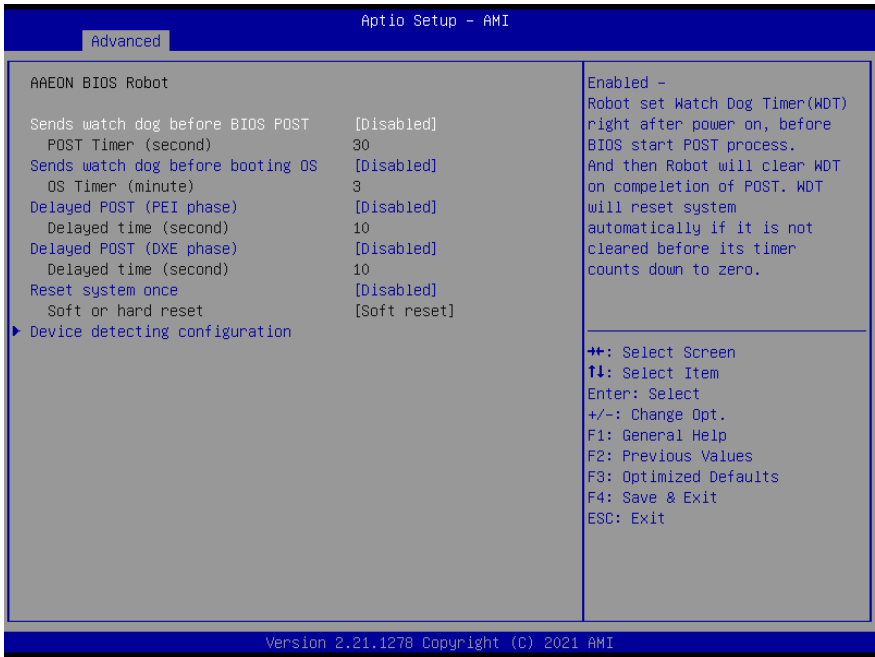

Options Summary		
Sends watch dog before BIOS POST	Disabled	Optimal Default, Failsafe Default
	Enabled	
Enabled - Robot set Watch Dog Timer (WDT) right after power on, before BIOS start POST process. And then Robot will clear WDT on completion of POST. WDT will reset system automatically if it is not cleared before its timer counts down to zero.		
POST Timer (second)	30	Optimal Default, Failsafe Default
Timer count set to Watch Dog Timer for POST. WARNING: Do not set to a value equal or shorter than normal POST time, otherwise system may never complete POST unless clearing BIOS settings. More than 2x normal POST time is suggested.		
Sends watch dog before booting OS	Disabled	Optimal Default, Failsafe Default
	Enabled	
Enabled - Robot set Watch Dog Timer (WDT) after POST completion, before BIOS transfer control to OS. WARNING: Before enabling this function, a program in OS must be in responsible for clearing WDT. Also, this function should be disabled if OS is going to update itself.		
OS Timer (minute)	3	Optimal Default, Failsafe Default
Timer count set to Watch Dog Timer for OS loading.		

Options Summary		
Delayed POST (PEI phase)	Disabled	Optimal Default, Failsafe Default
	Enabled	
Enabled - Robot holds BIOS from starting POST, right after power on. This allows BIOS POST to start with stable power or start after system is physically warmed-up. Note: Robot does this before 'Sends watch dog'.		
Delayed time (second)	10	Optimal Default, Failsafe Default
Period of time for Robot to hold BIOS from POST.		
Delayed POST (DXE phase)	Disabled	Optimal Default, Failsafe Default
	Enabled	
Enabled - Robot holds BIOS before POST completion. This allows BIOS POST to start with stable power or start after system is physically warmed-up. Note: Robot does this after 'Sends watch dog before BIOS POST'		
Delayed time (second)	10	Optimal Default, Failsafe Default
Period of time for Robot to hold BIOS from POST.		
Reset system once	Disabled	Optimal Default, Failsafe Default
	Enabled	
Enabled - Robot resets system for one time on each boot. This will send a soft or hard reset to onboard devices, thus puts devices to more stable state.		
Soft or hard reset	Soft reset	Optimal Default, Failsafe Default
	Hard reset	
Select reset type robot should send on each boot.		

3.4.8.1 Device Detecting Configuration



Options Summary		
Action	Reset System	Optimal Default, Failsafe Default
	Hold System	
Select action that robot should do.		
Soft or hard reset	Soft	Optimal Default, Failsafe Default
	Hard	
Select reset type robot should send on each boot.		
Retry-Count	30	Optimal Default, Failsafe Default
Fill retry counter here. Robot will reset system at most counter times, and then let system continue its POST.		
At time	After show logo	Optimal Default, Failsafe Default
	Before show logo	
Select robot action time: After show logo - Robot will do action after logo is displayed. System devices are almost ready. Before show logo - Robot will do action earlier before logo, but some devices may not be ready.		

3.4.8.1.1 Device #1 Detecting Configuration

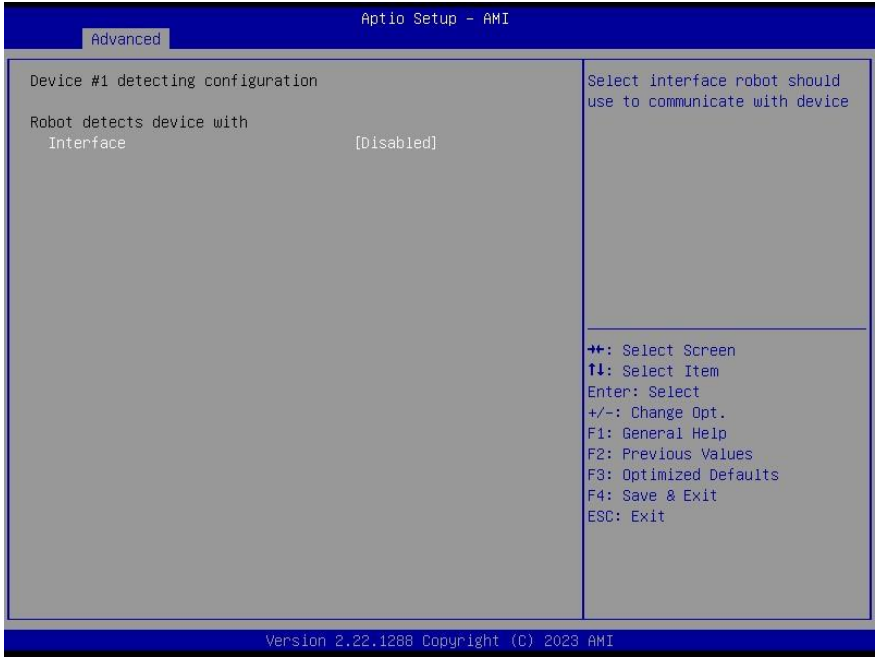

Options Summary		
Interface	Disable	Optimal Default, Failsafe Default
	PCI	
	DIO	
	SMBUS	
	Legacy I/O	
	Super I/O	
	MMIO	
Select interface robot should use to communicate with device.		

3.4.8.1.2 Device #2 Detecting Configuration

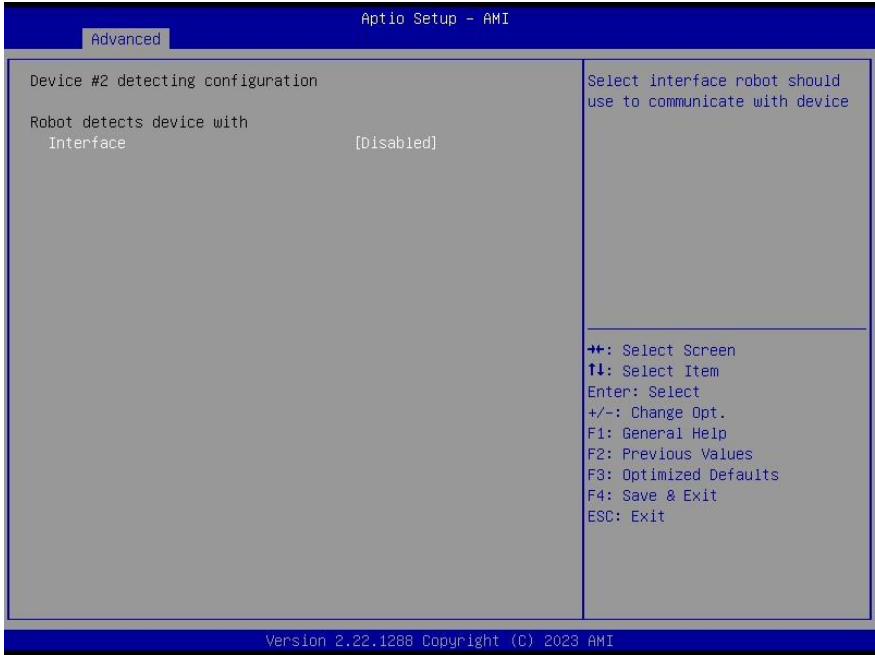

Options Summary		
Interface	Disable	Optimal Default, Failsafe Default
	PCI	
	DIO	
	SMBUS	
	Legacy I/O	
	Super I/O	
	MMIO	
Select interface robot should use to communicate with device.		

3.4.8.1.3 Device #3 Detecting Configuration

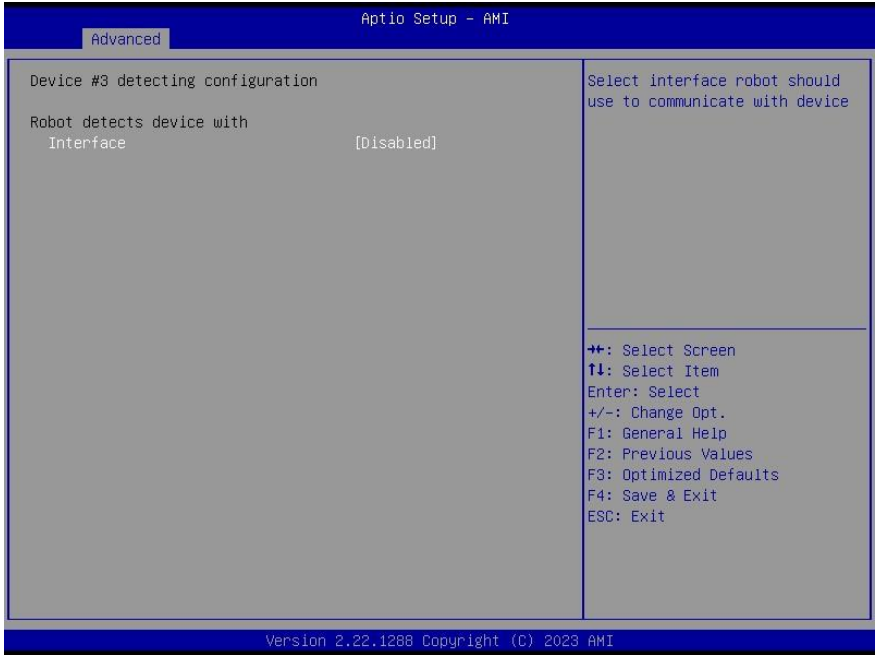

Options Summary		
Interface	Disable	Optimal Default, Failsafe Default
	PCI	
	DIO	
	SMBUS	
	Legacy I/O	
	Super I/O	
	MMIO	
Select interface robot should use to communicate with device.		

3.4.8.1.4 Device #4 Detecting Configuration

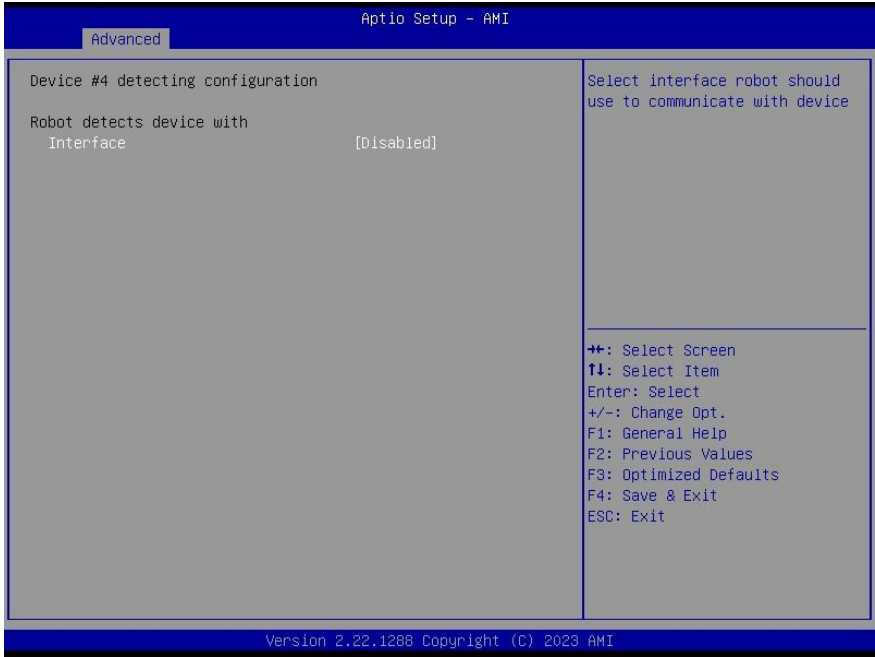

Options Summary		
Interface	Disable	Optimal Default, Failsafe Default
	PCI	
	DIO	
	SMBUS	
	Legacy I/O	
	Super I/O	
	MMIO	
Select interface robot should use to communicate with device.		

3.4.8.1.5 Device #5 Detecting Configuration

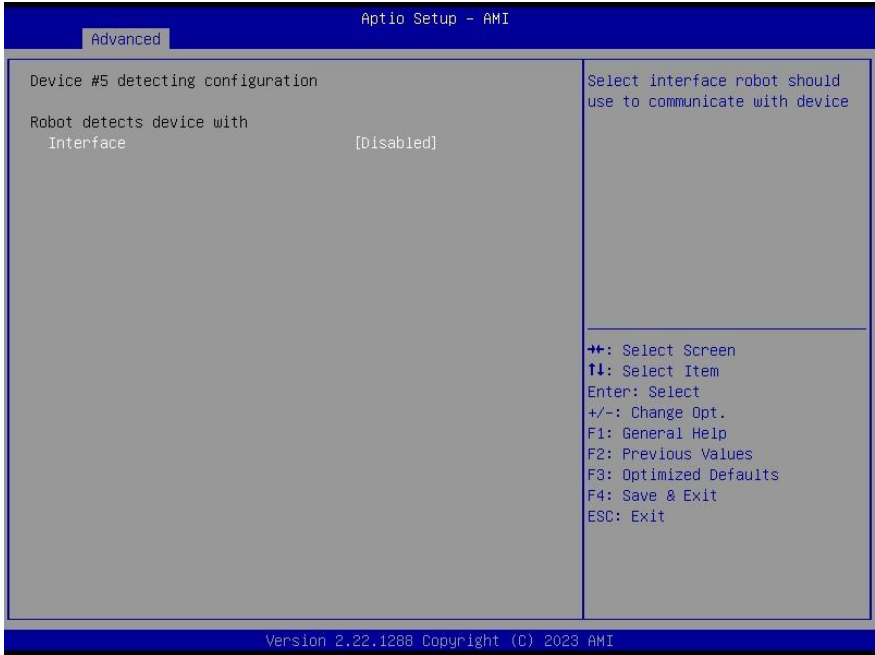

Options Summary		
Interface	Disable	Optimal Default, Failsafe Default
	PCI	
	DIO	
	SMBUS	
	Legacy I/O	
	Super I/O	
	MMIO	
Select interface robot should use to communicate with device.		

3.4.9 Power Management

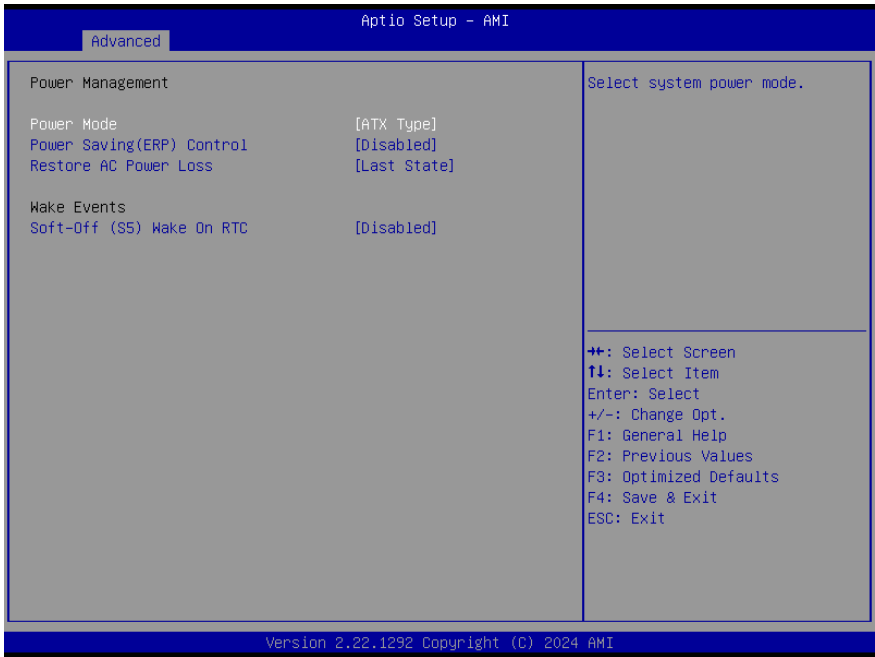

Options Summary		
Power Mode	ATX Type	Optimal Default, Failsafe Default
	AT Type	
Select power supply mode.		
Power Saving (ERP) Control	Disabled	Optimal Default, Failsafe Default
	Enabled	
Select Power saving control.		
Restore AC Power Loss	Last State	Optimal Default, Failsafe Default
	Always On	
	Always Off	
Select power state when power is re-applied after a power failure.		
Soft-Off (S5) Wake On RTC	Disable	Optimal Default, Failsafe Default
	By Date	
	By Weekday	
	Bypass	
By Date: System will wake on the with hr::min::sec specified. By Weekday: System will wake on the enabled weekday with hr::min::sec specified. Bypass: BIOS will not control RTC wake function.		

3.4.10 GPIO Port Configuration

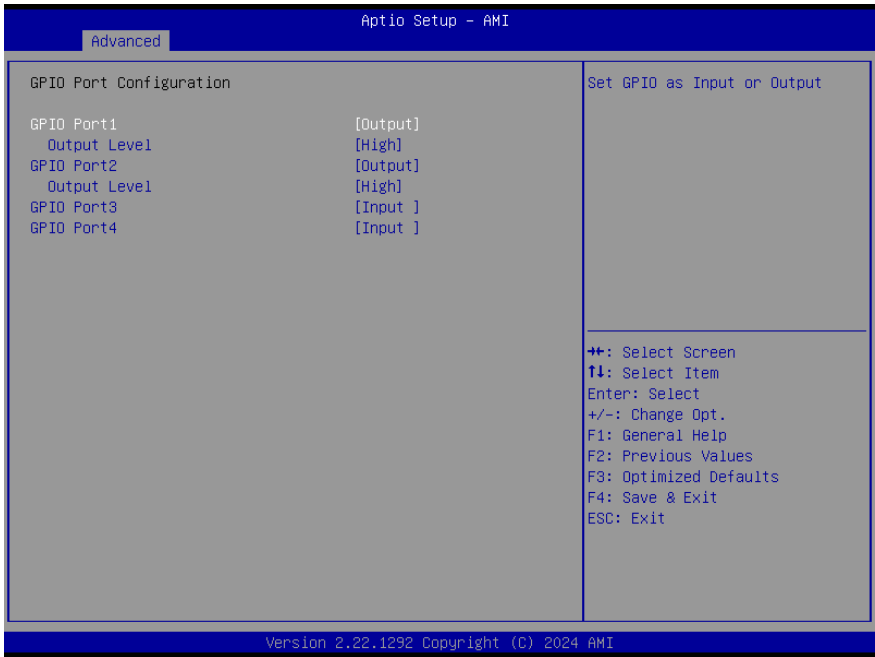

Options Summary		
GPIO Port*	Output	
	Input	
Set GPIO as Input or Output.		
Output Level	High	
	Low	
Set output level when GPIO pin is output.		

3.5 Setup Submenu: Chipset



3.5.1 System Agent (SA) Configuration

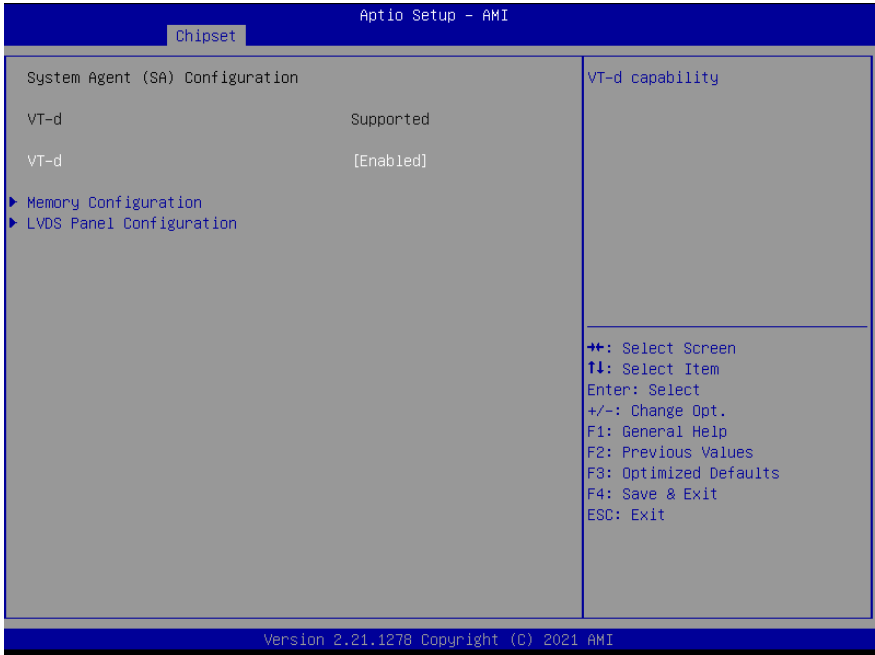

Options Summary		
VT-d	Disabled	Optimal Default, Failsafe Default
	Enabled	
VT-d capability.		

3.5.1.1 Memory Configuration

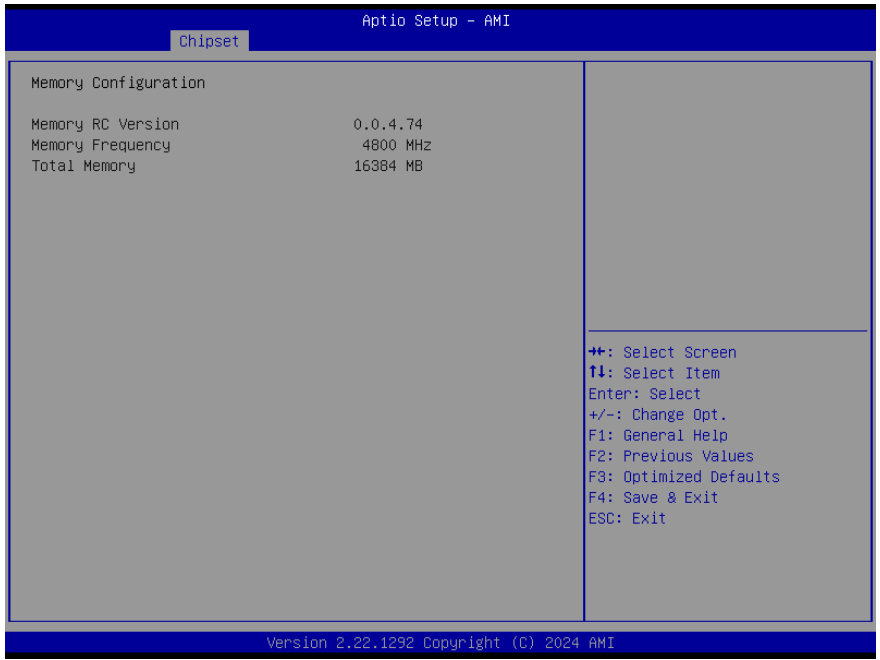

3.5.1.2 LVDS Panel Configuration

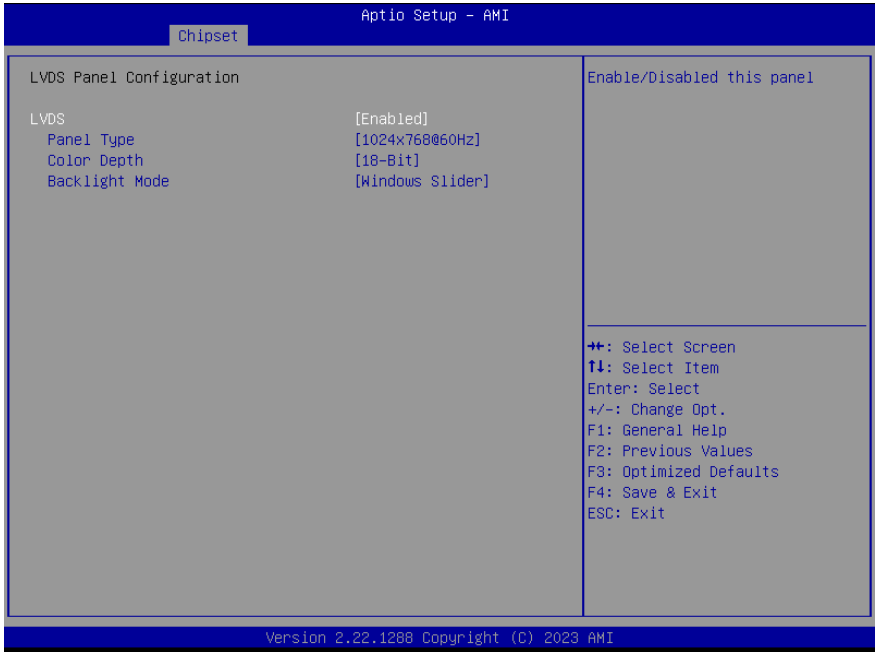

Options Summary		
LVDS	Disabled	
	Enabled	Optimal Default, Failsafe Default
Enable/Disable this panel.		
LVDS Panel Type	640x480,18bit,60Hz	
	800x480,18bit,60Hz	
	800x600,18bit,60Hz	
	1024x600,18bit,60Hz	
	1024x768,18bit,60Hz	
	1024x768,24bit,60Hz	Optimal Default, Failsafe Default
	1280x768,24bit,60Hz	
	1280x1024,48bit,60Hz	
	1366x768,24bit,60Hz	
	1440x900,48bit,60Hz	
	1600x1200,48bit,60Hz	
1920x1080,48bit,60Hz		
1920x1200,48bit,60Hz		
Select LCD panel used by Internal Graphics Device by selecting the appropriate setup item.		

Options Summary		
Color Depth	18-bit	Optimal Default, Failsafe Default
	24-bit	
	36-bit	
	48-bit	
Select panel type.		
Backlight Mode	BIOS & Application	
	Windows Slider	Optimal Default, Failsafe Default
Select backlight control signal type.		

3.5.2 PCH-IO Configuration



Options Summary		
HD Audio	Disabled	
	Enabled	Optimal Default, Failsafe Default
Control Detection of the HD-Audio device. Disable = HAD will be unconditionally disabled. Enable = HAD will be unconditionally enabled.		
Full-MiniCard Slot Function (CN9)	SATA	Optimal Default, Failsafe Default
	PCIe	
Select function enabled for Full-MiniCard (CN9) slot.		

3.6 Setup Submenu: Security

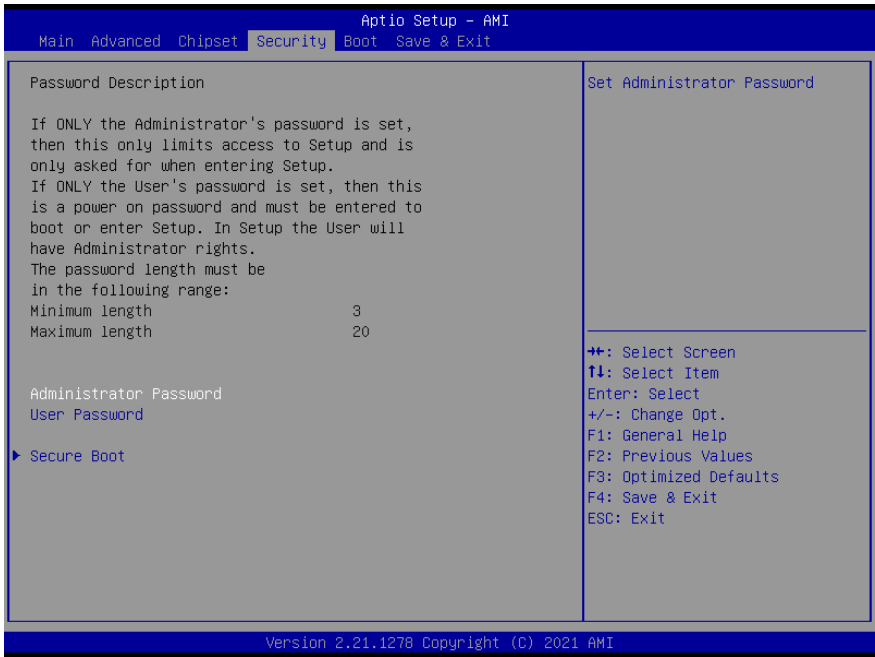

Change User/Supervisor Password

You can install a Supervisor password, and if you install a supervisor password, you can then install a user password. A user password does not provide access to many of the features in the Setup utility.

If you highlight these items and press Enter, a dialog box appears which lets you enter a password. You can enter no more than six letters or numbers. Press Enter after you have typed in the password. A second dialog box asks you to retype the password for confirmation. Press Enter after you have retyped it correctly. The password is required at boot time, or when the user enters the Setup utility.

Removing the Password

Highlight this item and type in the current password. At the next dialog box press Enter to disable password protection.

3.6.1 Secure Boot

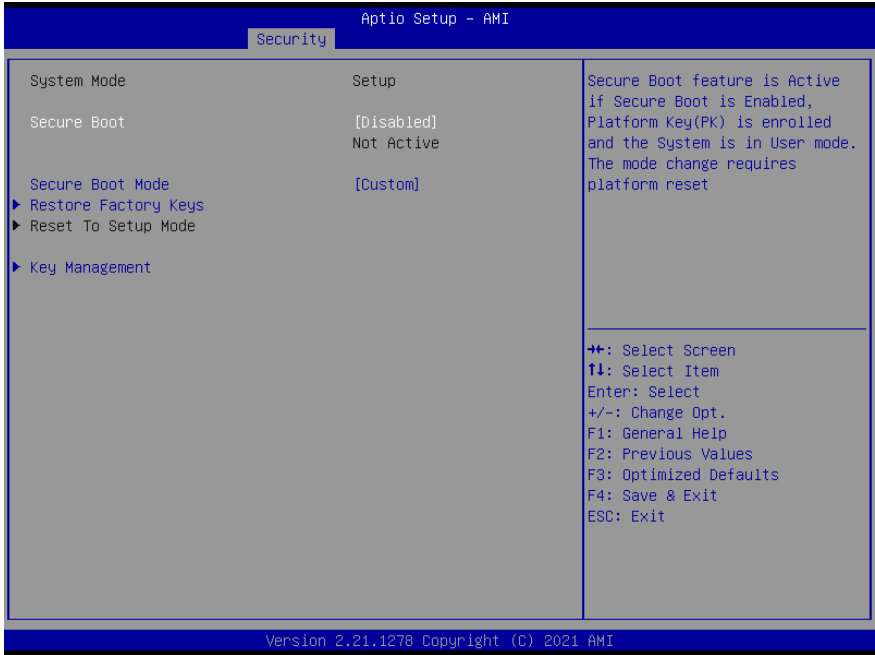

Options Summary		
Secure Boot	Disabled	Optimal Default, Failsafe Default
	Enabled	
Secure Boot feature is Active if Secure Boot is Enabled, Platform Key (PK) is enrolled and the System is in User mode. The mode change requires platform reset.		
Secure Boot Mode	Custom	Optimal Default, Failsafe Default
	Standard	
Secure Boot mode options: Standard or Custom. In Custom mode, Secure Boot Policy variables can be configured by a physically present user without full authentication.		
Restore Factory Keys		
Force System to User Mode. Install factory default Secure Boot key databases.		
Reset to Setup Mode		
Delete all Secure Boot key databases from NVRAM.		

Options Summary	
Device Guard ready system must not list 'Microsoft UEFI CA' Certificate in Authorized Signature database (db).	
Restore DB defaults	
Restore DB variable to factory defaults.	
Platform Key (PK)	Update
Key Exchange Keys	Update
	Append
Authorized Signatures	Update
	Append
Forbidden Signatures	Update
	Append
Authorized TimeStamps	Update
	Append
OsRecovery Signatures	Update
	Append
Enroll Factory Defaults or load certificates from a file:	
1.Public Key Certificate:	
a) EFI_SIGNATURE_LIST	
b) EFI_CERT_X509 (DER)	
c) EFI_CERT_RSA2048 (bin)	
d) EFI_CERT_SHAXXX	
2. Authenticated UEFI Variable	
3. EFI PE/COFF Image (SHA256)	
Key Source: Factory, External, Mixed	

3.7 Setup Submenu: Boot

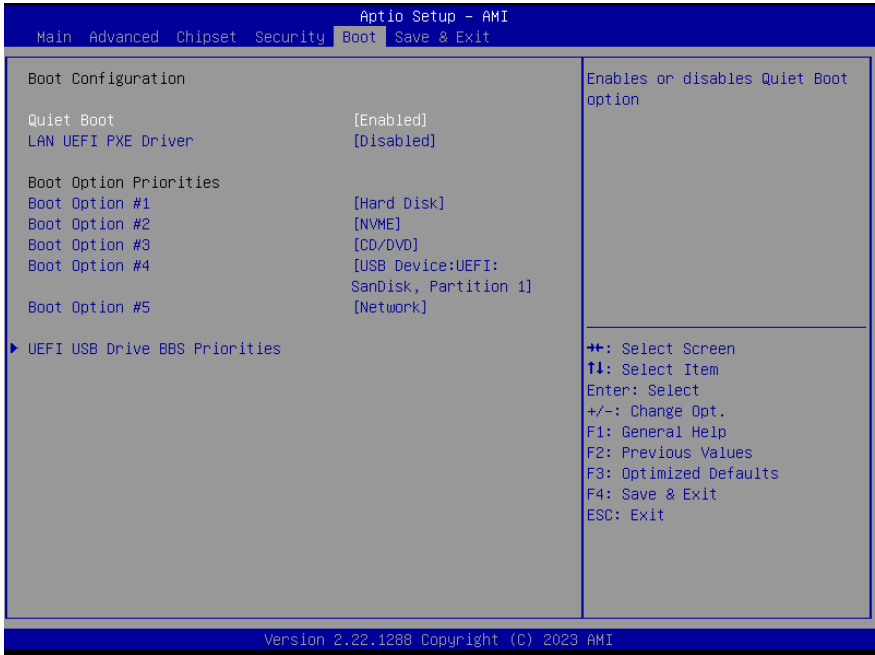

Options Summary		
Quiet Boot	Disabled	
	Enabled	Optimal Default, Failsafe Default
Enable or Disable Quiet Boot option.		
UEFI PXE Support	Disabled	Optimal Default, Failsafe Default
	Enabled	
Enable/Disable UEFI Network Stack.		
FIXED BOOT ORDER Priorities		
Sets the system boot order.		

3.7.1 BBS Priorities



3.8 Setup Submenu: Save & Exit

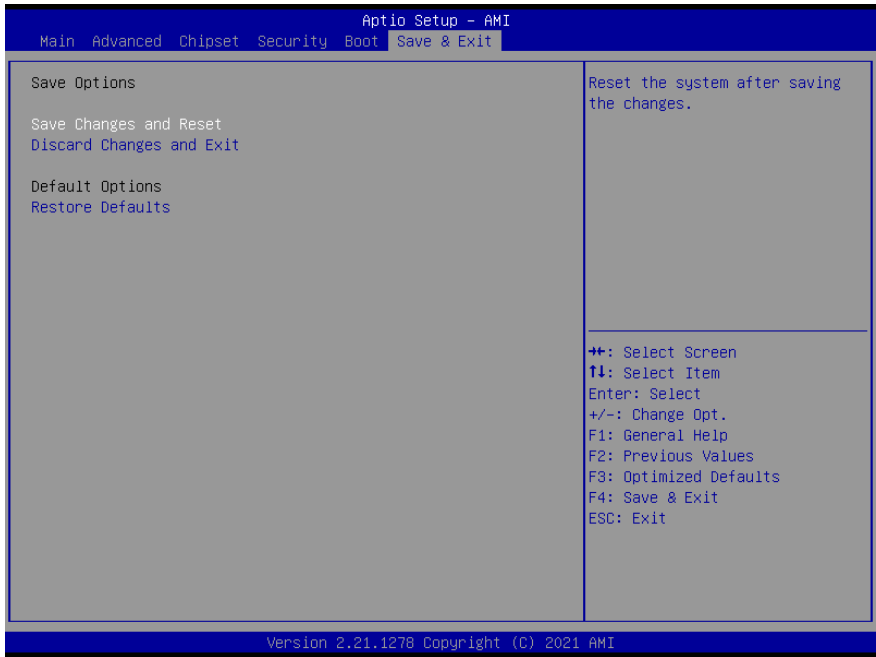

Options Summary	
Save Changes and Reset	Reset the system after saving the changes.
Discard Changes and Exit	Exit system setup without saving any changes.
Restore Defaults	Restore/Load Default values for all the setup options.

Chapter 4

Drivers Installation

4.1 Drivers Download and Installation

Drivers for the PICO-ASL4 Rev.B can be downloaded from the product page on the AAEON website by following this link:

<https://www.aaeon.com/>

Download the driver(s) you need and follow the steps below to install them.

Install Chipset Driver

1. Open the **Intel Chipset** folder.
2. Run the **SetupChipset.exe** file.
3. Follow the instructions
4. Drivers will be installed automatically

Install Graphics Driver

1. Open the **Intel Graphics** folder.
2. Run the **Installer.exe** file.
3. Follow the instructions
4. Driver will be installed automatically

Install LAN Drivers

- A. Realtek RTL8111H-CG LAN Driver
 1. Open the **LAN** folder.
 2. Run the **Install_Win10_10050_08132021.exe** file
 3. Follow the instructions
 4. Driver will be installed automatically
- B. Intel® I226 LAN Driver
 1. Open the **LAN** folder.

2. Run the **Setup.exe** file
3. Follow the instructions
4. Driver will be installed automatically

Install ME Driver

1. Open the **ME** folder.
2. Run the **SetupME.exe** file
3. Follow the instructions
4. Driver will be installed automatically

Install Peripheral Driver

1. Open the **Peripheral Driver** folder
2. Open the **SetupSerialO.exe** file
3. Follow the instructions
4. Drivers will be installed automatically

Install Intel Smart Sound Driver

1. Open the **Intel Smart Sound** folder
2. Navigate the folder as follows: **Production > Driver**, then follow the below instructions to install the BUS Driver (IntcAudioBus.inf) and OED Driver (IntcOED.inf).

Install BUS driver (IntcAudioBus.inf)

- a. Press Right Key -> Install

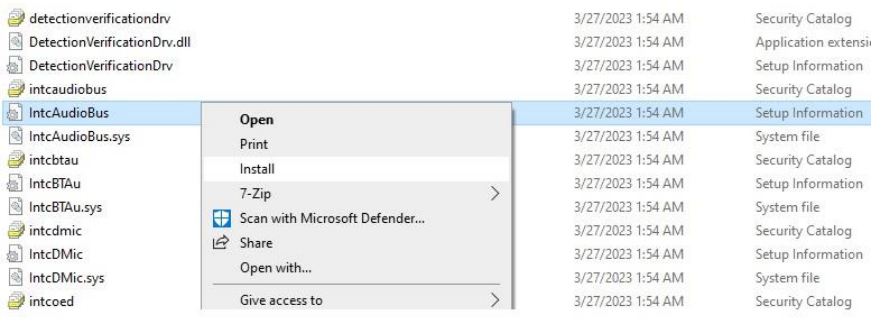

Install OED driver (IntcOED.inf)

b. Press Right Key -> Install

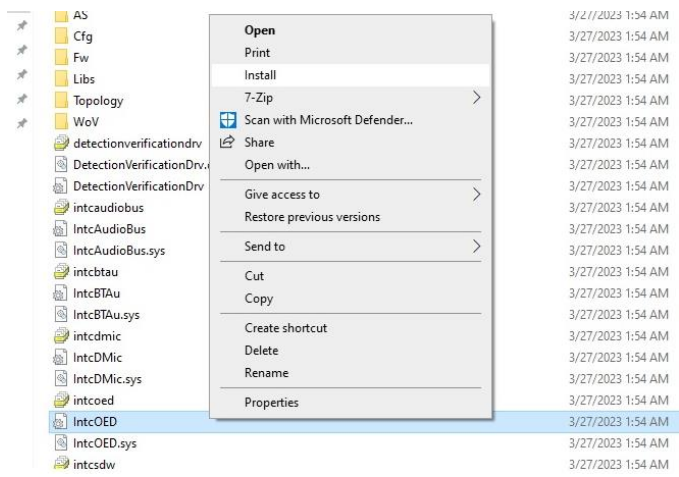

Install Windows Audio Driver

1. Open the **Windows Audio** folder followed by **Setup.exe**
2. Follow the instructions
3. Drivers will be installed automatically

Appendix A

Mating Connectors

A.1 List of Mating Connectors and Cables

The following table lists mating connectors and available cables.

Connector Label	Function	Mating Connector		Available Cable	AAEON Cable P/N
		Vendor	Model no		
CN1	RTC Battery	Molex	51021-0200	Battery Cable	175011301K
CN3	LVDS Back Light Inverter	JST	SHR-06V-S-B	LVDS Inverter Cable	170X000152
CN4	LVDS	I-PEX	20453-040T-11	LVDS Cable	N/A
	EDP			EDP Cable	N/A
CN6	SATA	Molex	887505318	SATA Cable	1709070500
CN7	SATA Power	JST	PHR-2	SATA Power Cable	1702150155
CN12	USB2.0 Header	ACES	50247-010H0H0-001	USB Wafer Cable	170010010D
CN16	4-pin Smart FAN	Molex	51021-0400	N/A	N/A
CN17	I2C/SMBUS Header	JST	SHR-05V-S-B	I2C/SMBUS Cable	170X000743
CN18	eSPI debug Header	JST	SHR-10V-S-B	eSPI debug Cable	1703100133
CN22	Front Panel	JST	SHR-10V-S-B	Front Panel Cable	170X000287
CN23	Power Input	Molex	19211-0003	Power Cable	170204010R
CN28	Audio	Molex	51021-0400	Audio cable	170X000779
CN29	USB2.0 Header	ACES	50247-010H0H0-001	USB Wafer Cable	170010010D
CN31	4-bit GPIO Header	ACES	50224-00601-001	N/A	N/A
CN32	COM Port 1~4 Conn	JST	SHDR-40V-S-B	COM Port Cable	170X000317

Appendix B

















I/O Information

B.1 I/O Address Map

The screenshot displays the Windows Device Manager window for a system named 'DESKTOP-F38H4EB'. The 'Input/output (IO)' category is expanded, showing a list of hardware devices with their corresponding I/O addresses and names. The devices listed include:

- PCI Express Root Complex
- Programmable interrupt controller
- Motherboard resources
- System timer
- Communications Port (COM4)
- Communications Port (COM2)
- Communications Port (COM3)
- Communications Port (COM1)

The list also includes numerous entries for 'Motherboard resources' and 'Programmable interrupt controller' with their respective hexadecimal addresses.

	[00000000000004D0 - 0000000000004D1]	Programmable interrupt controller
	[0000000000000680 - 000000000000069F]	Motherboard resources
	[0000000000000A00 - 0000000000000A0F]	Motherboard resources
	[0000000000000A10 - 0000000000000A1F]	Motherboard resources
	[0000000000000A20 - 0000000000000A2F]	Motherboard resources
	[0000000000000D00 - 000000000000FFFF]	PCI Express Root Complex
	[0000000000000164E - 0000000000000164F]	Motherboard resources
	[00000000000001854 - 00000000000001857]	Motherboard resources
	[00000000000002000 - 000000000000020FE]	Motherboard resources
	[00000000000003000 - 000000000000030FF]	Realtek PCIe GbE Family Controller
	[00000000000003000 - 00000000000003FFF]	PCI Express Root Port #9 - 54B0
	[00000000000004000 - 0000000000000403F]	Intel(R) UHD Graphics
	[00000000000004060 - 0000000000000407F]	Standard SATA AHCI Controller
	[00000000000004080 - 00000000000004083]	Standard SATA AHCI Controller
	[00000000000004090 - 00000000000004097]	Standard SATA AHCI Controller
	[0000000000000EFA0 - 000000000000EFBF]	SMBus - 54A3

B.2 IRQ Mapping Chart

Device Manager

File Action View Help

DESKTOP-F38H4EB

- Input/output (IO)
 - Interrupt request (IRQ)
 - (ISA) 0x00000000 (00) System timer
 - (ISA) 0x00000003 (03) Communications Port (COM2)
 - (ISA) 0x00000004 (04) Communications Port (COM1)
 - (ISA) 0x00000006 (06) Communications Port (COM4)
 - (ISA) 0x00000007 (07) Communications Port (COM3)
 - (ISA) 0x0000000E (14) Intel(R) Serial IO GPIO Host Controller - INTC1057
 - (ISA) 0x00000037 (55) Microsoft ACPI-Compliant System
 - (ISA) 0x00000038 (56) Microsoft ACPI-Compliant System
 - (ISA) 0x00000039 (57) Microsoft ACPI-Compliant System
 - (ISA) 0x0000003A (58) Microsoft ACPI-Compliant System
 - (ISA) 0x0000003B (59) Microsoft ACPI-Compliant System
 - (ISA) 0x0000003C (60) Microsoft ACPI-Compliant System
 - (ISA) 0x0000003D (61) Microsoft ACPI-Compliant System
 - (ISA) 0x0000003E (62) Microsoft ACPI-Compliant System
 - (ISA) 0x0000003F (63) Microsoft ACPI-Compliant System
 - (ISA) 0x00000040 (64) Microsoft ACPI-Compliant System
 - (ISA) 0x00000041 (65) Microsoft ACPI-Compliant System
 - (ISA) 0x00000042 (66) Microsoft ACPI-Compliant System
 - (ISA) 0x00000043 (67) Microsoft ACPI-Compliant System
 - (ISA) 0x00000044 (68) Microsoft ACPI-Compliant System
 - (ISA) 0x00000045 (69) Microsoft ACPI-Compliant System
 - (ISA) 0x00000046 (70) Microsoft ACPI-Compliant System
 - (ISA) 0x00000047 (71) Microsoft ACPI-Compliant System
 - (ISA) 0x00000048 (72) Microsoft ACPI-Compliant System
 - (ISA) 0x00000049 (73) Microsoft ACPI-Compliant System
 - (ISA) 0x0000004A (74) Microsoft ACPI-Compliant System
 - (ISA) 0x0000004B (75) Microsoft ACPI-Compliant System
 - (ISA) 0x0000004C (76) Microsoft ACPI-Compliant System
 - (ISA) 0x0000004D (77) Microsoft ACPI-Compliant System
 - (ISA) 0x0000004E (78) Microsoft ACPI-Compliant System
 - (ISA) 0x0000004F (79) Microsoft ACPI-Compliant System
 - (ISA) 0x00000050 (80) Microsoft ACPI-Compliant System

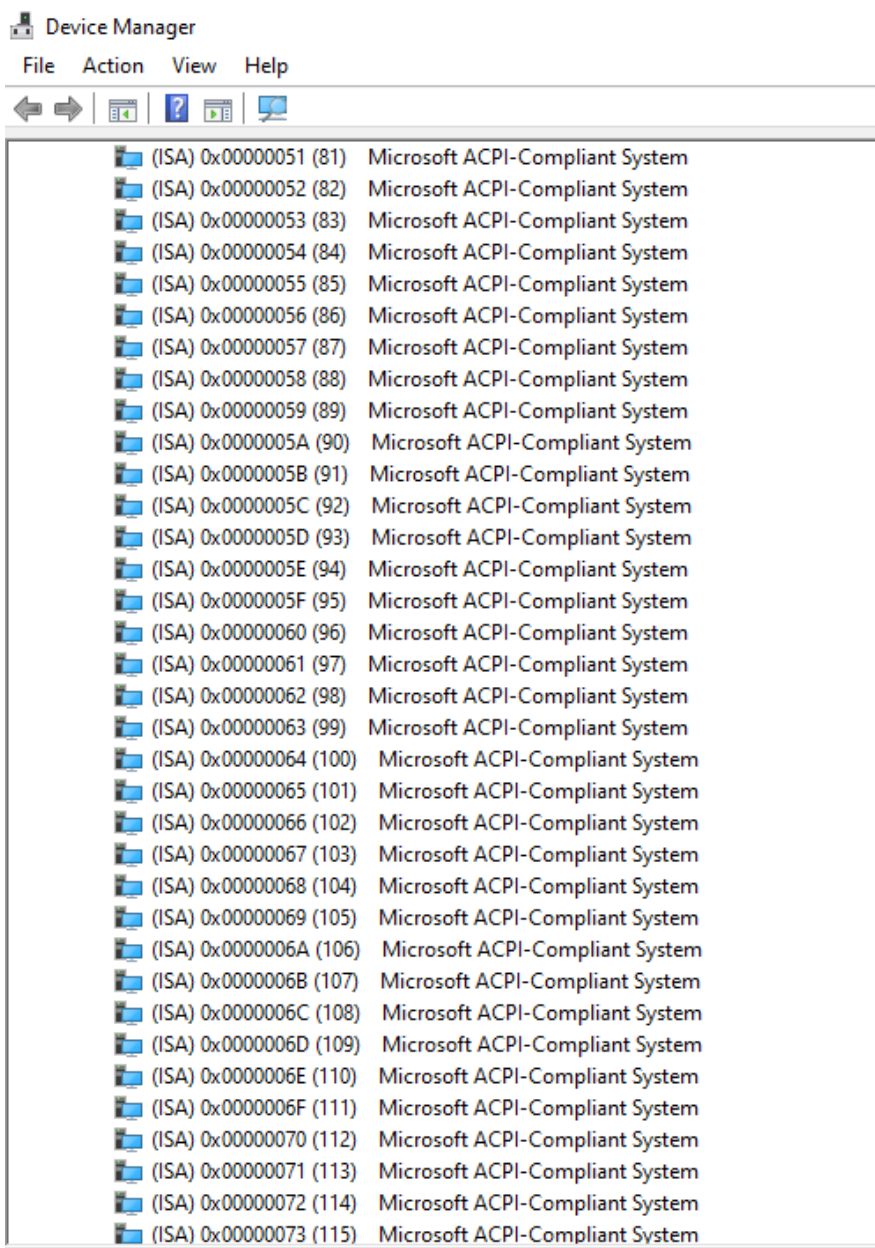

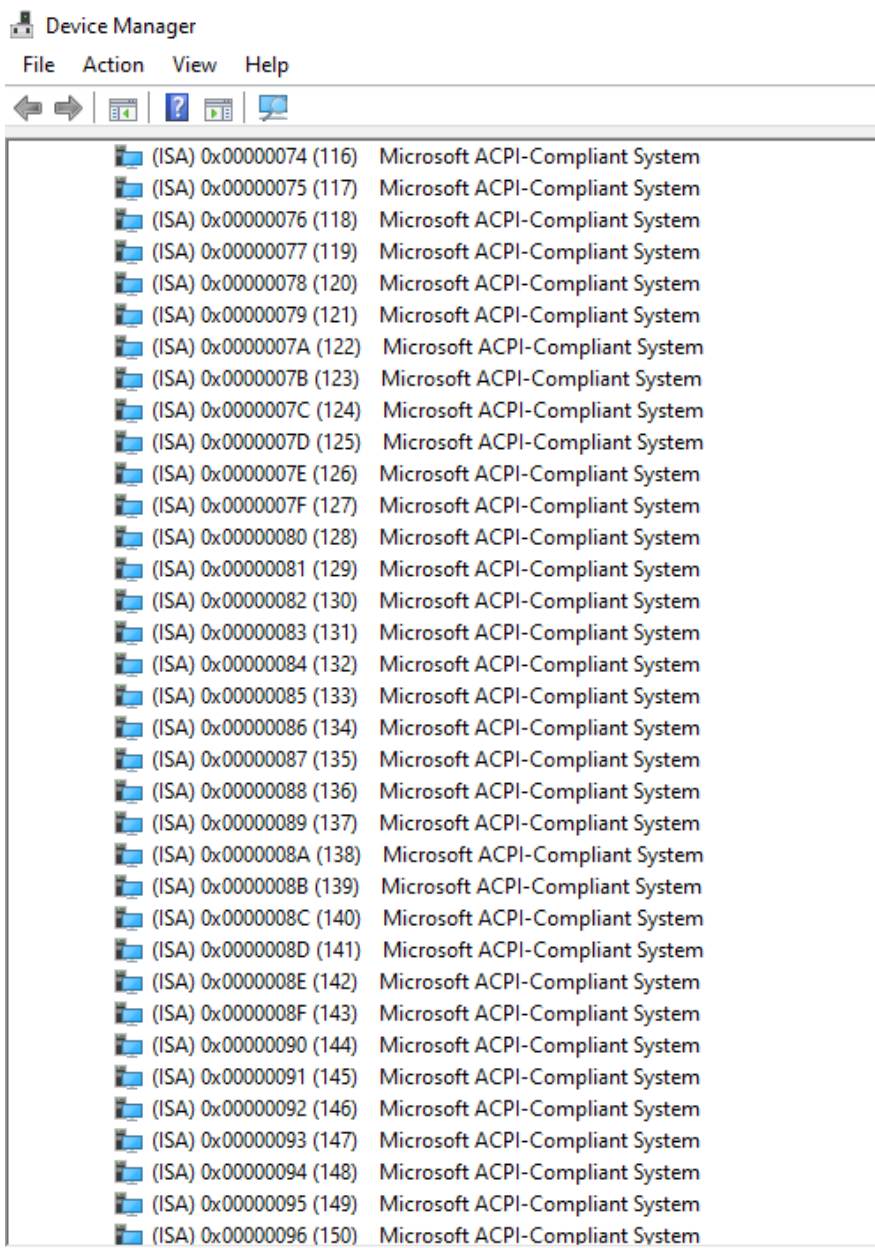

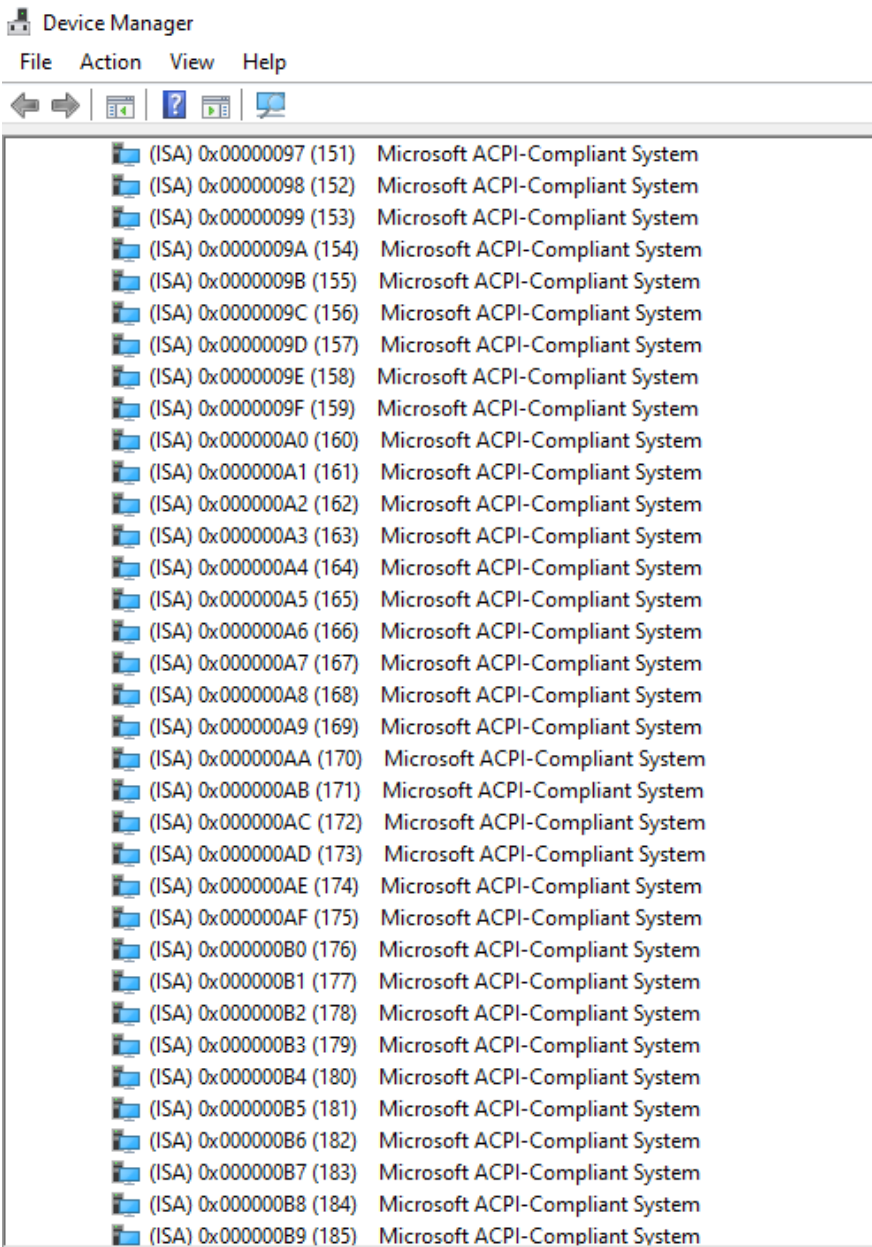

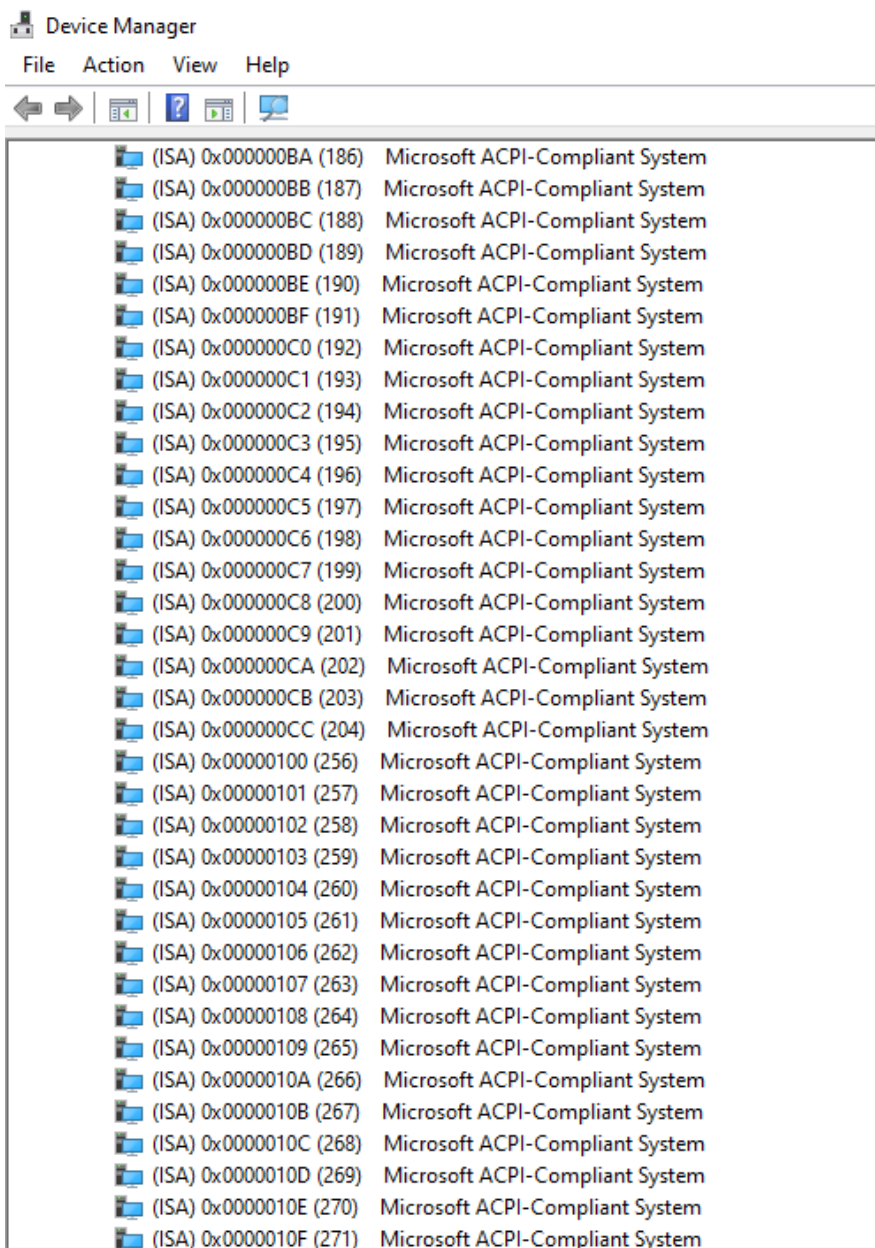

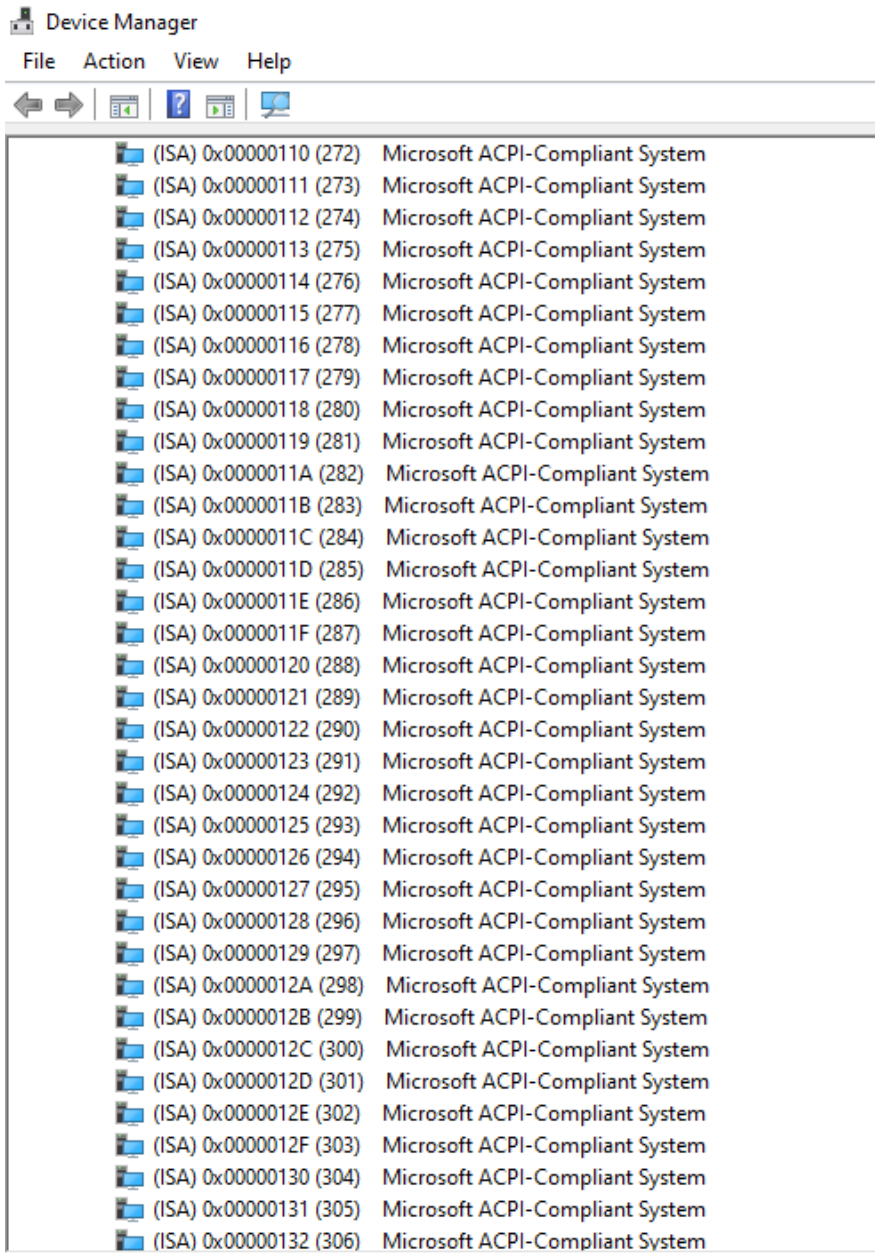

Device Manager

File Action View Help

← → [Refresh] [Help] [Details] [Monitor]

	(ISA) 0x00000133 (307)	Microsoft ACPI-Compliant System
	(ISA) 0x00000134 (308)	Microsoft ACPI-Compliant System
	(ISA) 0x00000135 (309)	Microsoft ACPI-Compliant System
	(ISA) 0x00000136 (310)	Microsoft ACPI-Compliant System
	(ISA) 0x00000137 (311)	Microsoft ACPI-Compliant System
	(ISA) 0x00000138 (312)	Microsoft ACPI-Compliant System
	(ISA) 0x00000139 (313)	Microsoft ACPI-Compliant System
	(ISA) 0x0000013A (314)	Microsoft ACPI-Compliant System
	(ISA) 0x0000013B (315)	Microsoft ACPI-Compliant System
	(ISA) 0x0000013C (316)	Microsoft ACPI-Compliant System
	(ISA) 0x0000013D (317)	Microsoft ACPI-Compliant System
	(ISA) 0x0000013E (318)	Microsoft ACPI-Compliant System
	(ISA) 0x0000013F (319)	Microsoft ACPI-Compliant System
	(ISA) 0x00000140 (320)	Microsoft ACPI-Compliant System
	(ISA) 0x00000141 (321)	Microsoft ACPI-Compliant System
	(ISA) 0x00000142 (322)	Microsoft ACPI-Compliant System
	(ISA) 0x00000143 (323)	Microsoft ACPI-Compliant System
	(ISA) 0x00000144 (324)	Microsoft ACPI-Compliant System
	(ISA) 0x00000145 (325)	Microsoft ACPI-Compliant System
	(ISA) 0x00000146 (326)	Microsoft ACPI-Compliant System
	(ISA) 0x00000147 (327)	Microsoft ACPI-Compliant System
	(ISA) 0x00000148 (328)	Microsoft ACPI-Compliant System
	(ISA) 0x00000149 (329)	Microsoft ACPI-Compliant System
	(ISA) 0x0000014A (330)	Microsoft ACPI-Compliant System
	(ISA) 0x0000014B (331)	Microsoft ACPI-Compliant System
	(ISA) 0x0000014C (332)	Microsoft ACPI-Compliant System
	(ISA) 0x0000014D (333)	Microsoft ACPI-Compliant System
	(ISA) 0x0000014E (334)	Microsoft ACPI-Compliant System
	(ISA) 0x0000014F (335)	Microsoft ACPI-Compliant System
	(ISA) 0x00000150 (336)	Microsoft ACPI-Compliant System
	(ISA) 0x00000151 (337)	Microsoft ACPI-Compliant System
	(ISA) 0x00000152 (338)	Microsoft ACPI-Compliant System
	(ISA) 0x00000153 (339)	Microsoft ACPI-Compliant System
	(ISA) 0x00000154 (340)	Microsoft ACPI-Compliant System
	(ISA) 0x00000155 (341)	Microsoft ACPI-Compliant System

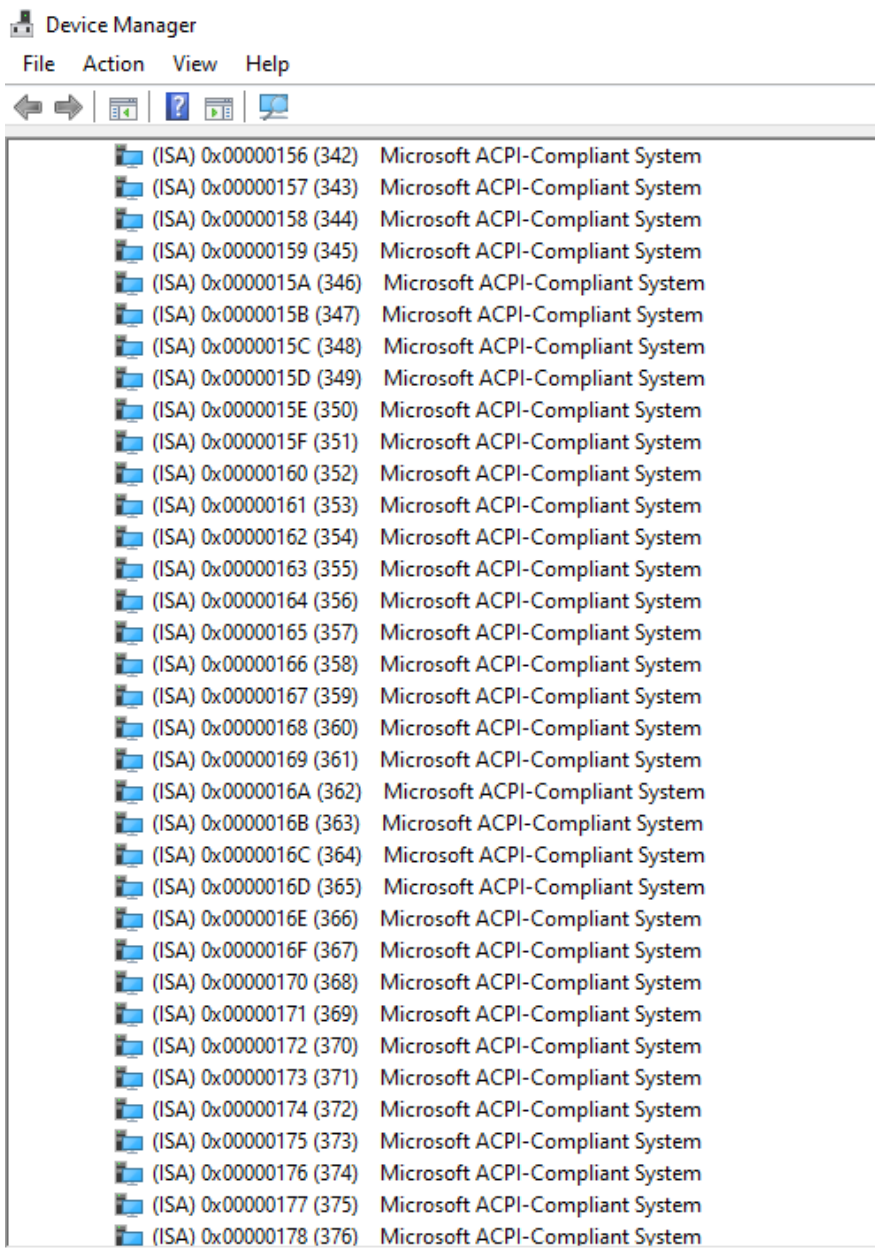

Device Manager

File Action View Help

← → [Grid] [Help] [Refresh] [Monitor]

	(ISA) 0x00000179 (377)	Microsoft ACPI-Compliant System
	(ISA) 0x0000017A (378)	Microsoft ACPI-Compliant System
	(ISA) 0x0000017B (379)	Microsoft ACPI-Compliant System
	(ISA) 0x0000017C (380)	Microsoft ACPI-Compliant System
	(ISA) 0x0000017D (381)	Microsoft ACPI-Compliant System
	(ISA) 0x0000017E (382)	Microsoft ACPI-Compliant System
	(ISA) 0x0000017F (383)	Microsoft ACPI-Compliant System
	(ISA) 0x00000180 (384)	Microsoft ACPI-Compliant System
	(ISA) 0x00000181 (385)	Microsoft ACPI-Compliant System
	(ISA) 0x00000182 (386)	Microsoft ACPI-Compliant System
	(ISA) 0x00000183 (387)	Microsoft ACPI-Compliant System
	(ISA) 0x00000184 (388)	Microsoft ACPI-Compliant System
	(ISA) 0x00000185 (389)	Microsoft ACPI-Compliant System
	(ISA) 0x00000186 (390)	Microsoft ACPI-Compliant System
	(ISA) 0x00000187 (391)	Microsoft ACPI-Compliant System
	(ISA) 0x00000188 (392)	Microsoft ACPI-Compliant System
	(ISA) 0x00000189 (393)	Microsoft ACPI-Compliant System
	(ISA) 0x0000018A (394)	Microsoft ACPI-Compliant System
	(ISA) 0x0000018B (395)	Microsoft ACPI-Compliant System
	(ISA) 0x0000018C (396)	Microsoft ACPI-Compliant System
	(ISA) 0x0000018D (397)	Microsoft ACPI-Compliant System
	(ISA) 0x0000018E (398)	Microsoft ACPI-Compliant System
	(ISA) 0x0000018F (399)	Microsoft ACPI-Compliant System
	(ISA) 0x00000190 (400)	Microsoft ACPI-Compliant System
	(ISA) 0x00000191 (401)	Microsoft ACPI-Compliant System
	(ISA) 0x00000192 (402)	Microsoft ACPI-Compliant System
	(ISA) 0x00000193 (403)	Microsoft ACPI-Compliant System
	(ISA) 0x00000194 (404)	Microsoft ACPI-Compliant System
	(ISA) 0x00000195 (405)	Microsoft ACPI-Compliant System
	(ISA) 0x00000196 (406)	Microsoft ACPI-Compliant System
	(ISA) 0x00000197 (407)	Microsoft ACPI-Compliant System
	(ISA) 0x00000198 (408)	Microsoft ACPI-Compliant System
	(ISA) 0x00000199 (409)	Microsoft ACPI-Compliant System
	(ISA) 0x0000019A (410)	Microsoft ACPI-Compliant System
	(ISA) 0x0000019B (411)	Microsoft ACPI-Compliant System

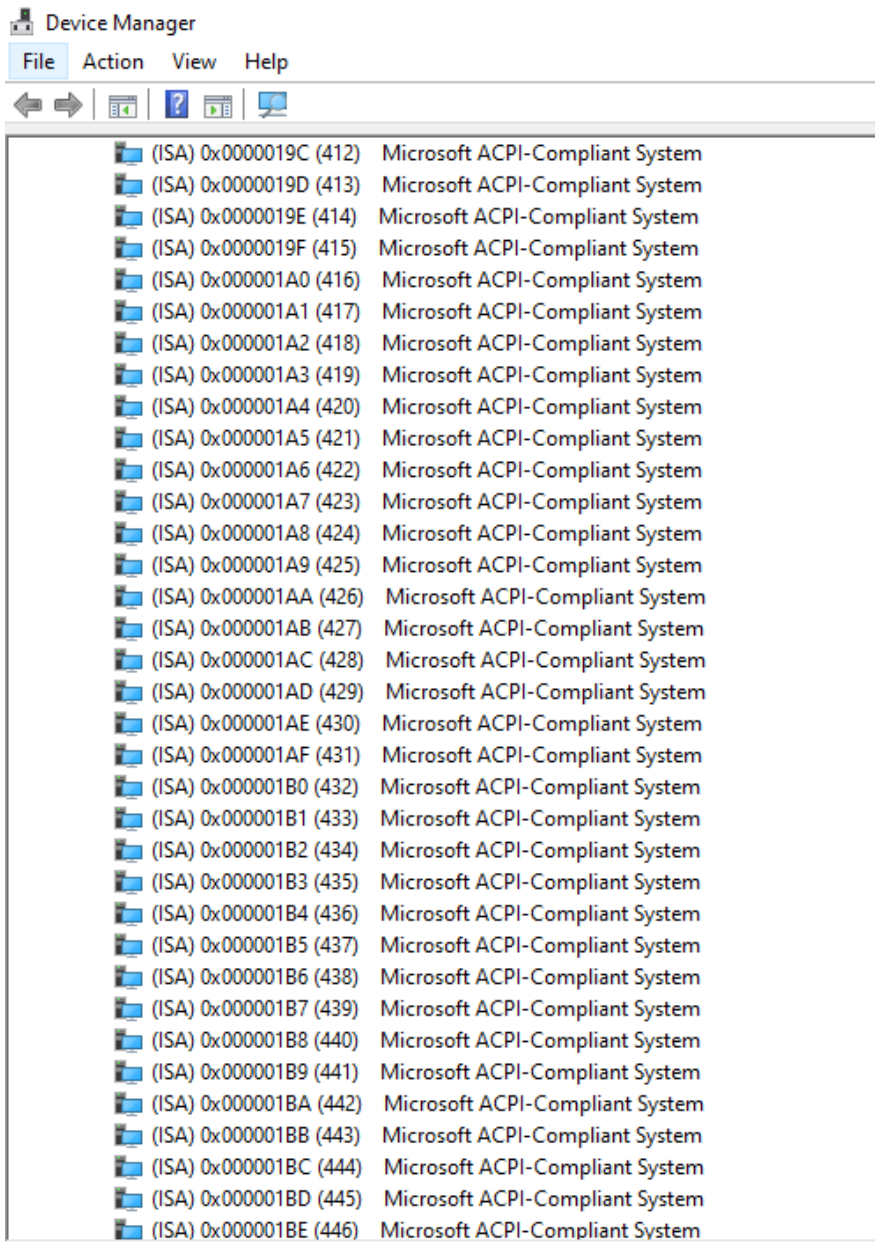

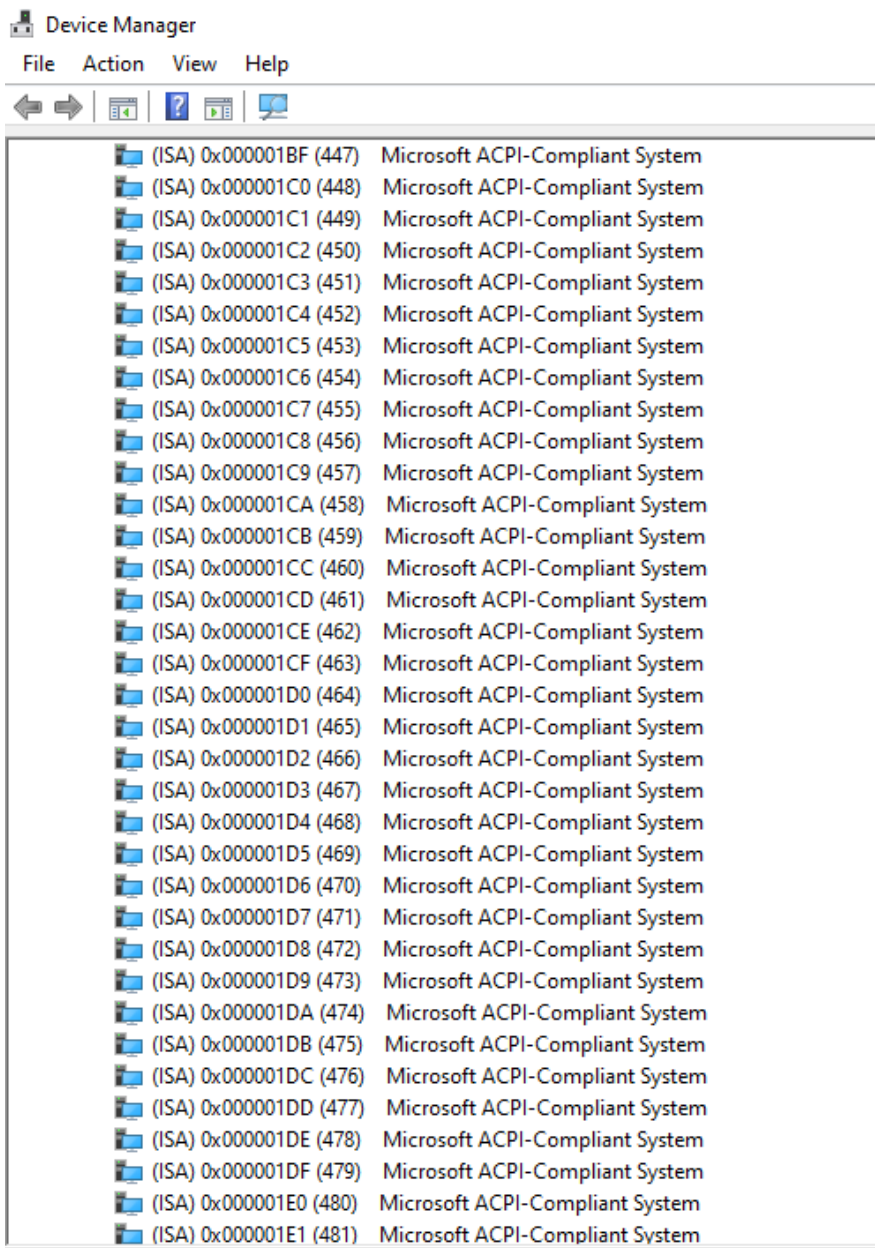

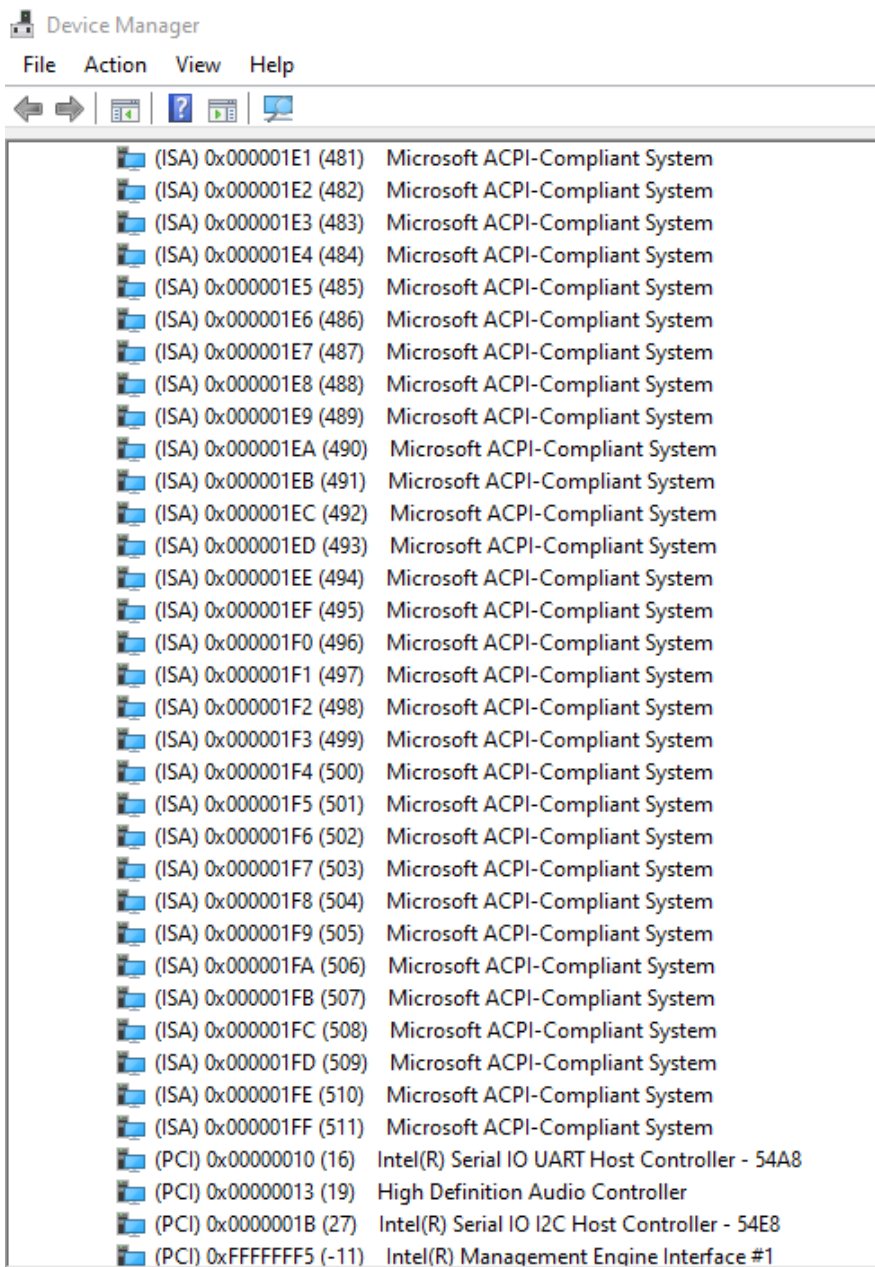

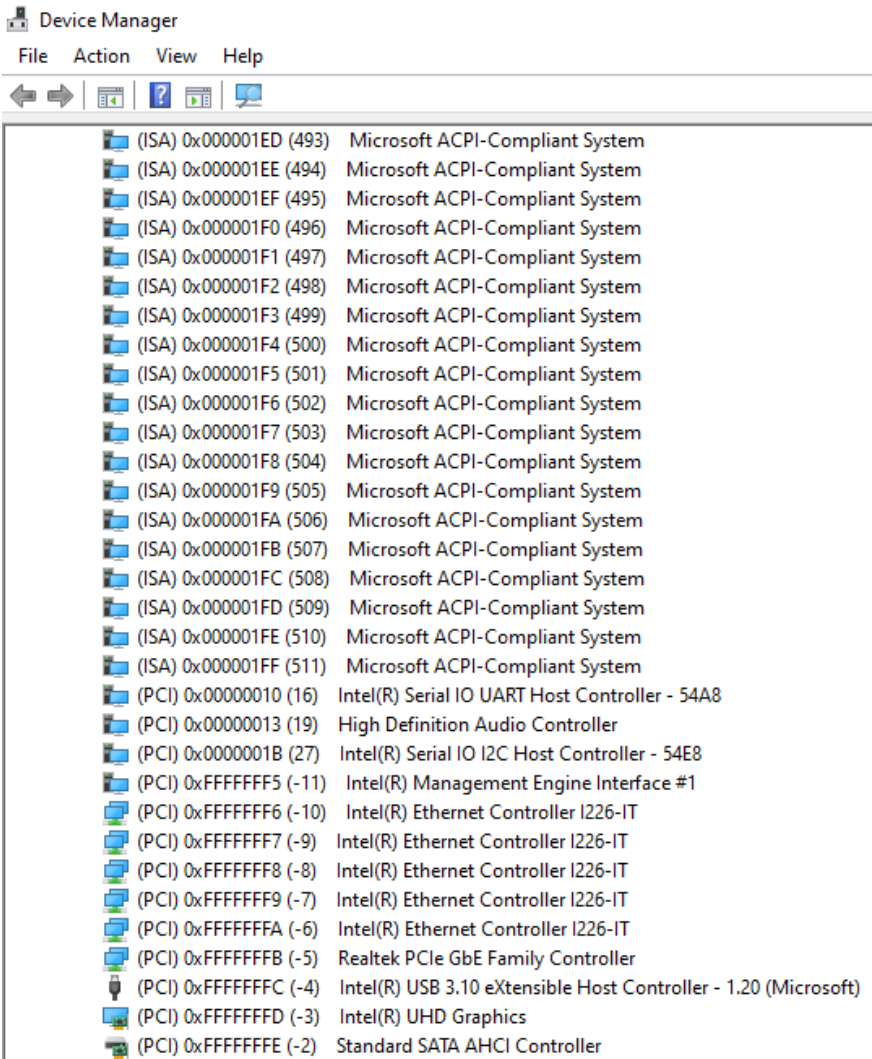

B.3 Memory Address Map

The screenshot displays the Windows Device Manager window, showing a list of hardware devices categorized under 'Large Memory' and 'Memory'. Each device entry includes a memory address range in hexadecimal format and the device name.

Category	Memory Address Range	Device Name
Large Memory	[0000004000000000 - 0000007FFFFFFF]	PCI Express Root Complex
Memory	[0000000000A0000 - 0000000000BFFFF]	PCI Express Root Complex
Memory	[0000000080400000 - 00000000804FFFFFF]	Intel(R) Ethernet Controller I226-IT
Memory	[0000000080400000 - 00000000805FFFFFF]	PCI Express Root Port #7 - 54BE
Memory	[0000000080400000 - 00000000BFFFFFF]	PCI Express Root Complex
Memory	[0000000080500000 - 0000000080503FFF]	Intel(R) Ethernet Controller I226-IT
Memory	[0000000080600000 - 0000000080603FFF]	Realtek PCIe GbE Family Controller
Memory	[0000000080600000 - 00000000806FFFFFF]	PCI Express Root Port #9 - 54B0
Memory	[0000000080604000 - 0000000080604FFF]	Realtek PCIe GbE Family Controller
Memory	[0000000080700000 - 0000000080701FFF]	Standard SATA AHCI Controller
Memory	[0000000080702000 - 00000000807027FF]	Standard SATA AHCI Controller
Memory	[0000000080703000 - 00000000807030FF]	Standard SATA AHCI Controller
Memory	[00000000C0000000 - 00000000CFFFFFF]	Motherboard resources
Memory	[00000000FD690000 - 00000000FD69FFFF]	Intel(R) Serial IO GPIO Host Controller - INTC1057
Memory	[00000000FD6A0000 - 00000000FD6AFFFF]	Intel(R) Serial IO GPIO Host Controller - INTC1057
Memory	[00000000FD6D0000 - 00000000FD6DFFFF]	Intel(R) Serial IO GPIO Host Controller - INTC1057
Memory	[00000000FD6E0000 - 00000000FD6EFFFF]	Intel(R) Serial IO GPIO Host Controller - INTC1057
Memory	[00000000FE010000 - 00000000FE010FFF]	SPI (flash) Controller - 54A4
Memory	[00000000FED00000 - 00000000FED003FF]	High precision event timer
Memory	[00000000FED20000 - 00000000FED7FFFF]	Motherboard resources
Memory	[00000000FED40000 - 00000000FED44FFF]	Trusted Platform Module 2.0
Memory	[00000000FED45000 - 00000000FED8FFFF]	Motherboard resources
Memory	[00000000FED90000 - 00000000FED93FFF]	Motherboard resources
Memory	[00000000FEDA0000 - 00000000FEDA0FFF]	Motherboard resources
Memory	[00000000FEDA1000 - 00000000FEDA1FFF]	Motherboard resources
Memory	[00000000FEDC0000 - 00000000FEDC7FFF]	Motherboard resources
Memory	[00000000FEE00000 - 00000000FEEFFFFF]	Motherboard resources
Memory	[0000004000000000 - 000000400FFFFFF]	Intel(R) UHD Graphics
Memory	[0000006000000000 - 0000006000FFFFFF]	Intel(R) UHD Graphics
Memory	[0000006001100000 - 000000600110FFFF]	Intel(R) USB 3.10 eXtensible Host Controller - 1.20 (Microsoft)
Memory	[0000006001100000 - 0000006001177FFF]	Performance Monitor
Memory	[0000006001128000 - 00000060011280FF]	SMBus - 54A3
Memory	[0000007FFFEF9000 - 0000007FFFEF9FFF]	Intel(R) Management Engine Interface #1
Memory	[0000007FFFEFA000 - 0000007FFFEFAFFF]	Intel(R) Serial IO I2C Host Controller - 54E8
Memory	[0000007FFFEFB000 - 0000007FFFEFBFFF]	Intel(R) Serial IO UART Host Controller - 54A8
Memory	[0000007FFFEFC000 - 0000007FFFEFCFFF]	High Definition Audio Controller
Memory	[0000007FFFEFD0000 - 0000007FFFEFDFFF]	High Definition Audio Controller