

PICO-APL2

PICO-ITX Board

User's Manual 2nd Ed

Copyright Notice

This document is copyrighted, 2024. All rights are reserved. The original manufacturer reserves the right to make improvements to the products described in this manual at any time without notice.

No part of this manual may be reproduced, copied, translated, or transmitted in any form or by any means without the prior written permission of the original manufacturer. Information provided in this manual is intended to be accurate and reliable. However, the original manufacturer assumes no responsibility for its use, or for any infringements upon the rights of third parties that may result from its use.

The material in this document is for product information only and is subject to change without notice. While reasonable efforts have been made in the preparation of this document to assure its accuracy, AAEMON assumes no liabilities resulting from errors or omissions in this document, or from the use of the information contained herein.

AAEMON reserves the right to make changes in the product design without notice to its users.

Acknowledgement

All other products' name or trademarks are properties of their respective owners.

- Microsoft Windows® is a registered trademark of Microsoft Corp.
- ITE is a trademark of Integrated Technology Express, Inc.
- IBM, PC/AT, PS/2, and VGA are trademarks of International Business Machines Corporation.
- Intel®, Atom®, Celeron®, and Pentium® are registered trademarks of Intel Corporation.
- Ubuntu is a trademark of Canonical Ltd.

All other product names or trademarks are properties of their respective owners. Ownership is not implied nor claimed by the publisher of this document for any product or product names not herein listed.

Packing List

Before setting up your product, please make sure the following items have been shipped:

Item	Quantity
● PICO-APL2	1

If any of these items are missing or damaged, please contact your distributor or sales representative immediately.

About this Document

This User's Manual contains all the essential information, such as detailed descriptions and explanations on the product's hardware and software features (if any), its specifications, dimensions, jumper/connector settings/definitions, and driver installation instructions (if any), to facilitate users in setting up their product.

Users may refer to the product page at AAEON.com for the latest version of this document.

Safety Precautions

Please read the following safety instructions carefully. It is advised that you keep this manual for future references

1. All cautions and warnings on the device should be noted.
2. Make sure the power source matches the power rating of the device.
3. Position the power cord so that people cannot step on it. Do not place anything over the power cord.
4. Always completely disconnect the power before working on the system's hardware.
5. No connections should be made when the system is powered as a sudden rush of power may damage sensitive electronic components.
6. If the device is not to be used for a long time, disconnect it from the power supply to avoid damage by transient over-voltage.
7. Always disconnect this device from any AC supply before cleaning.
8. While cleaning, use a damp cloth instead of liquid or spray detergents.
9. Make sure the device is installed near a power outlet and is easily accessible.
10. Keep this device away from humidity.
11. Place the device on a solid surface during installation to prevent falls
12. Do not cover the openings on the device to ensure optimal heat dissipation.
13. Watch out for high temperatures when the system is running.
14. Do not touch the heat sink or heat spreader when the system is running
15. Never pour any liquid into the openings. This could cause fire or electric shock.
16. As most electronic components are sensitive to static electrical charge, be sure to ground yourself to prevent static charge when installing the internal components. Use a grounding wrist strap and contain all electronic components in any static-shielded containers.

17. If any of the following situations arises, please the contact our service personnel:
 - i. Damaged power cord or plug
 - ii. Liquid intrusion to the device
 - iii. Exposure to moisture
 - iv. Device is not working as expected or in a manner as described in this manual
 - v. The device is dropped or damaged
 - vi. Any obvious signs of damage displayed on the device

18. **DO NOT LEAVE THIS DEVICE IN AN UNCONTROLLED ENVIRONMENT WHERE THE STORAGE TEMPERATURE IS BELOW -20° C (-4°F) OR ABOVE 60°C (140°F) TO PREVENT DAMAGE.**

Warning!



This device complies with Part 15 FCC Rules. Operation is subject to the following two conditions: (1) this device may not cause harmful interference, and (2) this device must accept any interference received including interference that may cause undesired operation.

Caution:

There is a danger of explosion if the battery is incorrectly replaced. Replace only with the same or equivalent type recommended by the manufacturer. Dispose of used batteries according to the manufacturer's instructions and your local government's recycling or disposal directives.

Attention:

Il y a un risque d'explosion si la batterie est remplacée de façon incorrecte. Ne la remplacer qu'avec le même modèle ou équivalent recommandé par le constructeur. Recycler les batteries usées en accord avec les instructions du fabricant et les directives gouvernementales de recyclage.

China RoHS Requirements (CN)

产品中有毒有害物质或元素名称及含量

AAEON Main Board/ Daughter Board/ Backplane

部件名称	有毒有害物质或元素					
	铅 (Pb)	汞 (Hg)	镉 (Cd)	六价铬 (Cr(VI))	多溴联苯 (PBB)	多溴二苯醚 (PBDE)
印刷电路板 及其电子组件	X	X	○	○	○	○
外部信号 连接器及线材	X	X	○	○	○	○
<p>○: 表示该有毒有害物质在该部件所有均质材料中的含量均在 SJ/T 11363-2006 标准规定的限量要求以下。</p> <p>X: 表示该有毒有害物质至少在该部件的某一均质材料中的含量超出 SJ/T 11363-2006 标准规定的限量要求。</p> <p>备注: 此产品所标示之环保使用期限, 系指在一般正常使用状况下。</p>						

China RoHS Requirement (EN)

Poisonous or Hazardous Substances or Elements in Products
 AAEON Main Board/ Daughter Board/ Backplane

Component	Poisonous or Hazardous Substances or Elements					
	Lead (Pb)	Mercury (Hg)	Cadmium (Cd)	Hexavalent Chromium (Cr(VI))	Polybrominated Biphenyls (PBB)	Polybrominated Diphenyl Ethers (PBDE)
PCB & Other Components	X	X	O	O	O	O
Wires & Connectors for External Connections	X	X	O	O	O	O
<p>O: The quantity of poisonous or hazardous substances or elements found in each of the component's parts is below the SJ/T 11363-2006-stipulated requirement.</p> <p>X: The quantity of poisonous or hazardous substances or elements found in at least one of the component's parts is beyond the SJ/T 11363-2006-stipulated requirement.</p> <p>Note: The Environment Friendly Use Period as labeled on this product is applicable under normal usage only</p>						

Table of Contents

Chapter 1 - Product Specifications	1
1.1 Specifications	2
1.2 Function Block.....	6
Chapter 2 – Hardware Information	7
2.1 Dimensions	8
2.2 Jumpers and Connectors.....	9
2.3 List of Jumpers	11
2.3.1 Clear CMOS Jumper (JP1 Pins 1, 3, 5).....	12
2.3.2 Auto Power Button Enable/Disable (JP1 Pins 2, 4, 6)	12
2.3.3 LVDS Port Operating Voltage Selection (JP2 Pins 1,3,5)	12
2.3.4 LVDS Port Backlight Inverter Voltage Selection (JP2 2,4,6).....	13
2.3.5 LVDS Port Backlight Lightness Control Mode (JP3).....	13
2.4 List of Connectors.....	14
2.4.1 Digital IO Port (CN1).....	15
2.4.2 LVDS Port Inverter/Backlight Connector (CN2).....	15
2.4.3 Front Panel (CN3)	16
2.4.4 Half-size Mini Card Slot (CN4).....	16
2.4.5 SPI Programming Header (CN5).....	18
2.4.6 Full-size Mini Card Slot/mSATA (By BOM) (CN6)	18
2.4.7 BIO Connector (CN7).....	20
2.4.8 SATA Port (CN8)	22
2.4.9 Battery (CN9).....	22
2.4.10 Dual USB 3.2 Gen 1 (CN11).....	22
2.4.11 +5V Output for SATA HDD (CN12).....	23
2.4.12 HDMI Port (CN13).....	24
2.4.13 External +12V Input (CN14).....	25

2.4.14	DDR3L SODIMM Slot (CN15).....	25
2.4.15	LVDS Connector (CN16)	25
2.4.16	COM Port 1/Port 2 & Line-Out Connector (CN17)	26
2.4.17	LPC Connector (CN18).....	28
2.4.18	USB 2.0 Port 1 (CN19).....	29
2.4.19	RJ-45 LAN Port (CN20)	30
2.4.20	RJ-45 LAN LED Port (CN21).....	30
2.5	Thermal Solutions.....	31
Chapter 3 - AMI BIOS Setup		32
3.1	System Test and Initialization	33
3.2	AMI BIOS Setup	34
3.3	Setup Submenu: Main.....	35
3.4	Setup Submenu: Advanced.....	36
3.4.1	CPU Configuration	37
3.4.2	SATA Configuration	38
3.4.3	Hardware Monitor	39
3.4.4	SIO Configuration.....	40
3.4.4.1	Serial Port Configuration	41
3.4.5	DIO Configuration	42
3.4.6	Trusted Computing.....	43
3.4.7	TPM Configuration	45
3.4.8	Power Management.....	46
3.5	Setup Submenu: Chipset	47
3.5.1	North Bridge.....	48
3.5.1.1	LVDS Panel Configuration	49
3.5.2	South Bridge.....	51
3.6	Setup Submenu: Security.....	52
3.6.1	Secure Boot.....	53

3.6.1.1	Key Management.....	54
3.7	Setup Submenu: Boot.....	56
3.7.1	BBS Priorities.....	57
3.8	Setup Submenu: Save & Exit.....	58
Chapter 4	– Drivers Installation.....	59
4.1	Driver Download/Installation.....	60
Appendix A	- I/O Information.....	62
A.1	I/O Address Map.....	63
A.2	Memory Address Map.....	64
A.3	IRQ Mapping Chart.....	65
Appendix B	– Mating Connectors.....	66
B.1	List of Mating Connectors and Cables.....	67

Chapter 1

Product Specifications

1.1 Specifications

System

Form Factor	Pico-ITX
CPU	Intel Atom® x7-E3950 (4C, 1.6 GHz, up to 2 GHz, TDP 12W) Intel Atom® x5-E3940 (4C, 1.6GHz, up to 1.8 GHz, TDP 9.5W) Intel® Pentium® Processor N4200 (4C, 1.1 GHz, up to 2.5 GHz, TDP 6W) Intel® Celeron® Processor N3350 (2C, 1.1GHz, up to 2.4GHz, TDP 6W)
Chipset	Intel Atom® E3900/Pentium® N4200/Celeron® N3350 Processor SoC
Memory Type	DDR3L 1600MHz SODIMM x 1, up to 8GB
BIOS	AMI/SPI
Wake on LAN	Yes
Watchdog Timer	255 Levels
Security	—
RTC Battery	Lithium Battery 3V/240mAh
Dimension	3.94" x 2.84" (100mm x 72mm)
Gross Weight	0.18 lb. (0.08Kg)
OS Support	Windows® 10 (64-bit) Ubuntu 20.04.4/5.13.0

Power

Power Requirement	+12V
Power Supply Type	AT/ATX
Connector	2-Pin Connector
Power Consumption	Intel® Pentium® Processor N4200, DDR3L 8GB, 2.16A @+12V (Typical) Intel® Pentium® Processor N4200, DDR3L 8GB, 2.28A @+12V (Max)

Display

Controller	Intel® HD Graphics 500/505
LVDS/eDP	LVDS (18/24-bit 2CH)
Display Interface	HDMI 1.4 x 1 (Pin Header, 2K @30Hz) DDI (BIO, Optional)
Multiple Display	Up to 2 Simultaneous Displays

Audio

CODEC	Realtek ALC888/897
Audio Interface	Line Out
Speaker	—

External I/O

Ethernet	Intel® Ethernet Controller I210-AT/I210-IT, GbE x 1 (Pin Header) *LED via Separate Pin-Header
USB	USB 3.2 Gen 1 x 2
Video	HDMI 1.4 x 1 (2K @30Hz) (Pin header type) DDI (BIO, Optional)

Internal I/O

USB	USB 2.0 x 1
Serial Port	COM x 2 (RS-232 x 1, RS-232/422/485, Ring/+5V/+12V x 1)
Video	—
SATA	SATA 6Gb/s x 1 +5 SATA Power Connector x 1
Audio	Line-Out x 1
DIO/GPIO	4-bit
SMBus/I2C	SMBus/I2C x 1 (SMBus as default, I2C selected by HW BOM)
Touch	—
FAN	—
SIM	—
Front Panel	HDD LED, PWR LED, Power Button, Buzzer, Reset
Others	—

Expansion

Mini PCI-E/mSATA	Full-size mPCIe/mSATA or USB 2.0 x 1 (SATA as default, PCIe selected by HW BOM) Half-size Mini Card x 1 (mPCIe as default)
M.2	—
Others	BIO x 1 (Optional)

Environment

Operating Temperature	32°F ~ 140°F (0°C ~ 60°C)
Storage Temperature	-40°F ~ 176°F (-40°C ~ 80°C)
Operating Humidity	0% ~ 90% relative humidity, non-condensing
MTBF (Hours)	525,137
EMC	CE/FCC Class A

1.2 Function Block

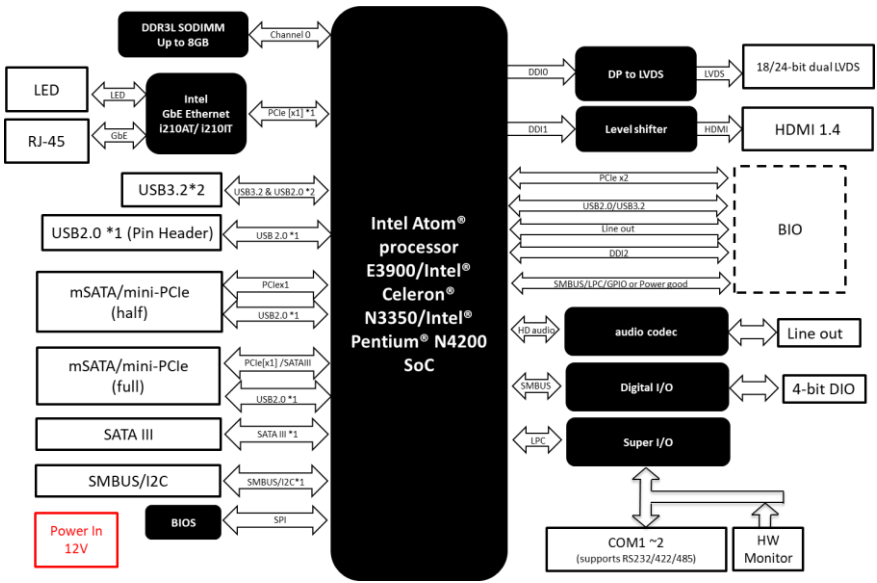

Chapter 2

Hardware Information

2.1 Dimensions

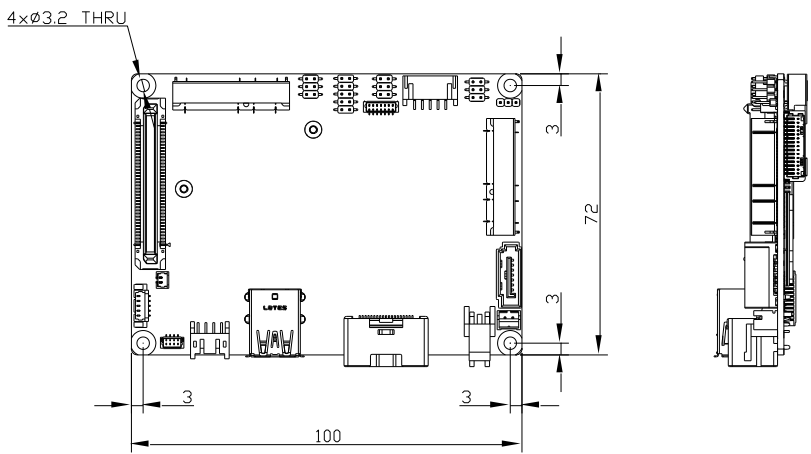

Component Side

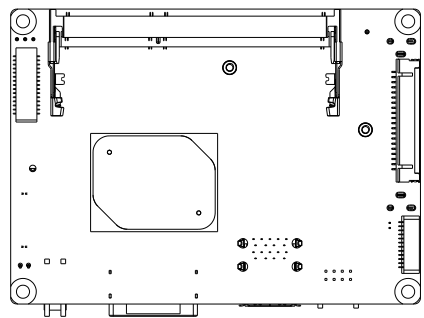
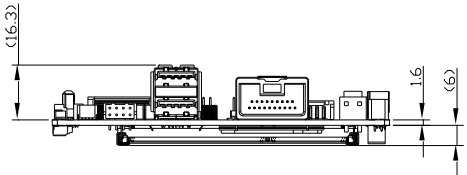

Solder Side

2.2 Jumpers and Connectors

Component Side

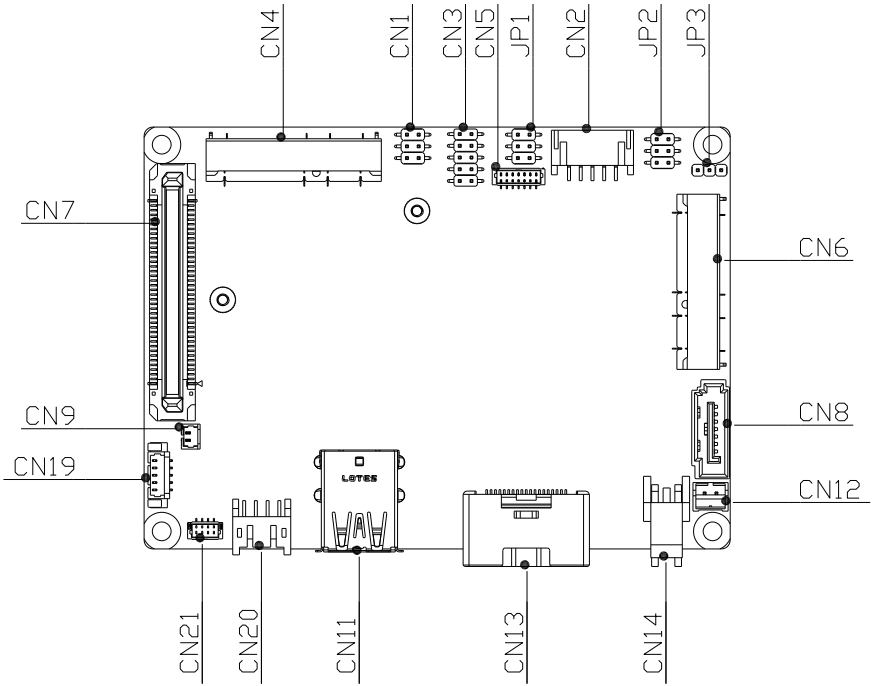

Solder Side

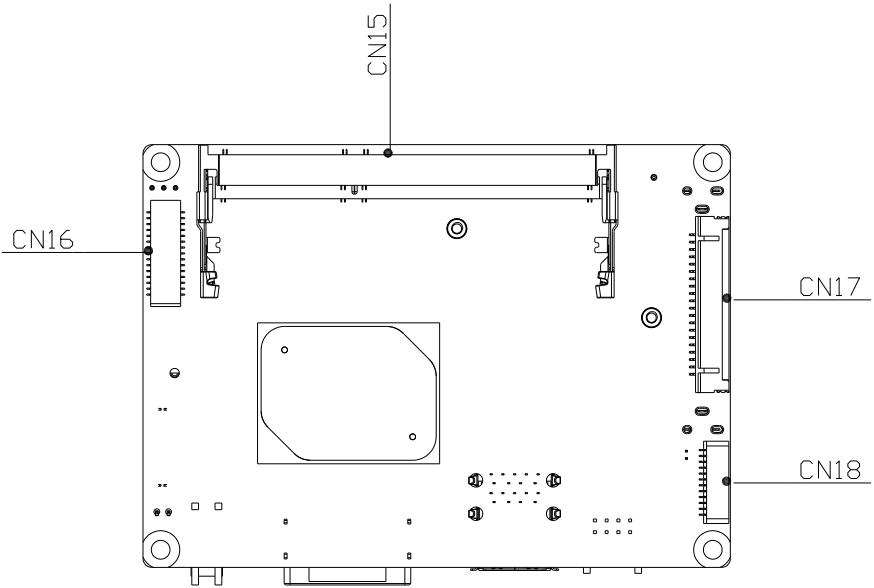

2.3 List of Jumpers

Please refer to the table below for all of the board's jumpers that you can configure for your application

Label	Function
JP1 (Pins 1,3,5)	Clear CMOS Jumper
JP1 (Pins 2,4,6)	Auto Power Button Enable/Disable Selection
JP2 (Pins 1,3,5)	LVDS Port Operating Voltage Selection
JP2 (Pins 2,4,6)	LVDS Port Backlight Inverter Voltage Selection
JP3	LVDS Port Backlight Lightness Control Mode Selection

2.3.1 Clear CMOS Jumper (JP1 Pins 1, 3, 5)

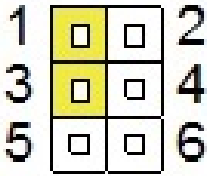

Normal (Default)

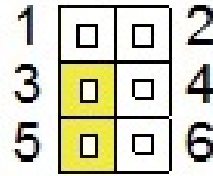

Clear CMOS

2.3.2 Auto Power Button Enable/Disable (JP1 Pins 2, 4, 6)

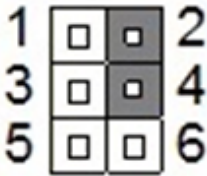

Enable (Default)

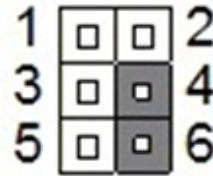

Disable

2.3.3 LVDS Port Operating Voltage Selection (JP2 Pins 1,3,5)

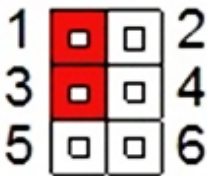

+5V

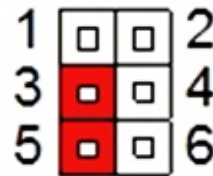

+3.3V (Default)

2.3.4 LVDS Port Backlight Inverter Voltage Selection (JP2 2,4,6)

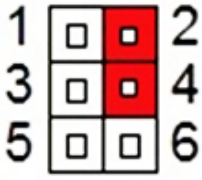

+12V

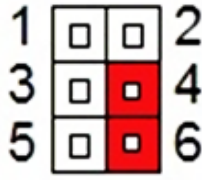

+5V (Default)

2.3.5 LVDS Port Backlight Lightness Control Mode (JP3)

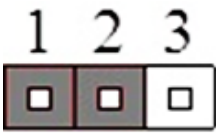

VR Mode (Default)

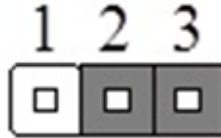

PWM Mode

2.4 List of Connectors

Please refer to the table below for all of the board's connectors that you can configure for your application

Label	Function
CN1	Digital IO Port
CN2	LVDS Port Inverter/Backlight Connector
CN3	Front Panel
CN4	Half-size Mini Card Slot
CN5	SPI Programming Header
CN6	Full-size Mini Card Slot/mSATA (By BOM)
CN7	BIO Connector
CN8	SATA Connector
CN9	Battery
CN11	Dual USB 3.2 Gen 1
CN12	+5V Output for SATA HDD
CN13	HDMI Port
CN14	External +12V Input
CN15	DDR3L SODIMM Slot
CN16	LVDS Connector
CN17	COM Port 1/Port 2 & Line-Out Connector
CN18	LPC Connector
CN19	USB 2.0 Port 1
CN20	RJ-45 LAN Port
CN21	RJ-45 LAN LED Port

2.4.1 Digital IO Port (CN1)

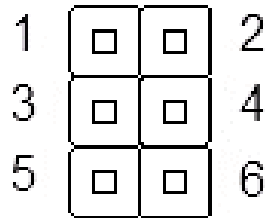

Pin	Pin Name	Signal Type	Signal Level
1	+5V	PWR	+5V
2	DIO0	I/O	+5V
3	DIO1	I/O	+5V
4	DIO2	I/O	+5V
5	DIO3	I/O	+5V
6	GND	GND	-

2.4.2 LVDS Port Inverter/Backlight Connector (CN2)

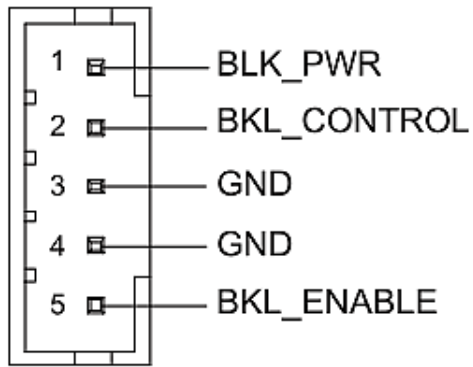

Pin	Pin Name	Signal Type	Signal Level
1	BLK_PWR	PWR	+5V / +12V
2	BKL_CONTROL	OUT	-
3	GND	GND	-

Pin	Pin Name	Signal Type	Signal Level
4	GND	GND	-
5	BKL_ENABLE	OUT	+3.3V

Note: LVDS/BKL_PWR can be set to +5V or +12V by JP2.

Note: LVDS/BKL_CONTROL can be set by JP3.

Note: The driving current supports up to 2A.

2.4.3 Front Panel (CN3)

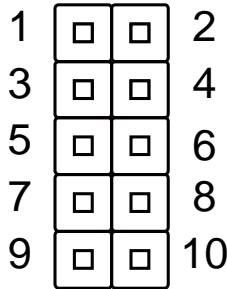

Pin	Pin Name	Pin	Pin Name
1	PWR_BTN-	2	PWR_BTN+
3	HDD_LED-	4	HDD_LED+
5	BUZZER-	6	BUZZER+
7	PWR_LED-	8	PWR_LED+
9	H/W RESET-	10	H/W RESET+

2.4.4 Half-size Mini Card Slot (CN4)

Pin	Pin Name	Signal Type	Signal Level
1	PCIE_WAKE#	IN	-
2	+3.3VSB	PWR	+3.3V
3	NC	-	-
4	GND	GND	-

Pin	Pin Name	Signal Type	Signal Level
5	NC	-	-
6	+1.5V	PWR	+1.5V
7	PCIE_CLK_REQ#	IN	-
8	NC	-	-
9	GND	GND	-
10	NC	-	-
11	PCIE_REF_CLK-	DIFF	-
12	NC	-	-
13	PCIE_REF_CLK+	DIFF	-
14	NC	-	-
15	GND	GND	-
16	NC	-	-
17	NC	-	-
18	GND	GND	-
19	NC	-	-
20	W_DISABLE#	OUT	+3.3V
21	GND	GND	-
22	PCIE_RST#	OUT	+3.3V
23	PCIE_RX-	DIFF	-
24	+3.3VSB	PWR	+3.3V
25	PCIE_RX+	DIFF	-
26	GND	GND	-
27	GND	GND	-
28	+1.5V	PWR	+1.5V
29	GND	GND	-
30	SMB_CLK	I/O	+3.3V
31	PCIE_TX-	DIFF	-
32	SMB_DATA	I/O	+3.3V
33	PCIE_TX+	DIFF	-
34	GND	GND	-
35	GND	GND	-
36	USB_D-	DIFF	-
37	GND	GND	-

Pin	Pin Name	Signal Type	Signal Level
38	USB_D+	DIFF	-
39	+3.3VSB	PWR	+3.3V
40	GND	GND	-
41	+3.3VSB	PWR	+3.3V
42	NC	-	-
43	GND	GND	-
44	NC	-	-
45	NC	-	-
46	NC	-	-
47	NC	-	-
48	+1.5V	PWR	+1.5V
49	NC	-	-
50	GND	GND	-
51	NC	-	-
52	+3.3VSB	PWR	+3.3V

2.4.5 SPI Programming Header (CN5)

Pin	Pin Name	Signal Type	Signal Level
1	SPI_SO	Signal	-
2	GND	GND	-
3	SPI_CLK	Signal	-
4	+V3P3A_SPI	PWR	3.3A
5	SPI_SI	Signal	-
6	SPI_CS	Signal	-
7	NC	-	-

2.4.6 Full-size Mini Card Slot/mSATA (By BOM) (CN6)

Pin	Pin Name	Signal Type	Signal Level
1	PCIE_WAKE#	IN	-
2	+3.3VSB/+3.3V	PWR	+3.3V

Pin	Pin Name	Signal Type	Signal Level
3	NC	-	-
4	GND	GND	-
5	NC	-	-
6	+1.5V	PWR	+1.5V
7	PCIE_CLK_REQ#	IN	-
8	UIM_PWR	PWR	-
9	GND	GND	-
10	UIM_DATA	I/O	-
11	PCIE_REF_CLK-	DIFF	-
12	UIM_CLK	IN	-
13	PCIE_REF_CLK+	DIFF	-
14	UIM_RST	IN	-
15	GND	GND	-
16	UIM_VPP	PWR	-
17	NC	-	-
18	GND	GND	-
19	NC	-	-
20	W_DISABLE#	OUT	+3.3V
21	GND	GND	-
22	PCIE_RST#	OUT	+3.3V
23	PCIE_RX-/mSATARX+	DIFF	-
24	+3.3VSB/+3.3V	PWR	+3.3V
25	PCIE_RX+/mSATARX-	DIFF	-
26	GND	GND	-
27	GND	GND	-
28	+1.5V	PWR	+1.5V
29	GND	GND	-
30	SMB_CLK	I/O	+3.3V
31	PCIE_TX-/mSATATX-	DIFF	-
32	SMB_DATA	I/O	+3.3V
33	PCIE_TX+/mSATATX+	DIFF	-
34	GND	GND	-
35	GND	GND	-

Pin	Pin Name	Signal Type	Signal Level
36	USB_D-	DIFF	-
37	GND	GND	-
38	USB_D+	DIFF	-
39	+3.3VSB/+3.3V	PWR	+3.3V
40	GND	GND	-
41	+3.3VSB/+3.3V	PWR	+3.3V
42	NC	-	-
43	GND	GND	-
44	NC	-	-
45	NC	-	-
46	NC	-	-
47	NC	-	-
48	+1.5V	PWR	+1.5V
49	NC	-	-
50	GND	GND	-
51	NC	-	-
52	+3.3VSB/+3.3V	PWR	+3.3V

2.4.7 BIO Connector (CN7)

Pin	Pin Name	Pin	Pin Name
1	+12VSB	2	GND
3	GND	4	PCIE_TXN0
5	PCIE_RXN0	6	PCIE_TXP0
7	PCIE_RXP0	8	GND
9	GND	10	PCIE_TXN4
11	PCIE_RXN4	12	PCIE_TXP4
13	PCIE_RXP4	14	GND
15	GND	16	PS_ON#
17	DDIO_DDCCLK_3P3	18	DDIO_DDCDATA_3P3
19	+5VSB	20	+5VSB
21	+5VSB	22	+5VSB
23	PCIE_REF_CLK0	24	RESET#

Pin	Pin Name	Pin	Pin Name
25	PCIE_REF_CLK0#	26	GND
27	GND	28	DDIO_TXN1
29	DDIO_TXN0	30	DDIO_TXP1
31	DDIO_TXP0	32	GND
33	GND	34	DDIO_TXN3
35	DDIO_TXN2	36	DDIO_TXP3
37	DDIO_TXP2	38	GND
39	GND	40	BIO_DDIO_HPD
41	DDIO_AUXN	42	GND
43	DDIO_AUXP	44	USB3_TX2_N
45	GND	46	USB3_TX2_P
47	USBN4	48	GND
49	USBP4	50	USB3_RX2_N
51	GND	52	USB3_RX2_P
53	SMB_CLK	54	GND
55	SMB_DATA	56	WAKE#
57	GND	58	USB_OC0#
59	+V5	60	USB_OC1#
61	+V5	62	+5V
63	+V5	64	+5V
65	LPC_AD0	66	LPC_FRAME#
67	LPC_AD1	68	SERIRQ
69	LPC_AD2	70	LPC_DRQ
71	LPC_AD3	72	GPIO0/BIO-POWEROK
73	GND	74	AGND
75	LPC_CLK	76	AUD_LINEOUT_L
77	PME#	78	AUD_LINEOUT_R
79	GND	80	GND

2.4.8 SATA Port (CN8)

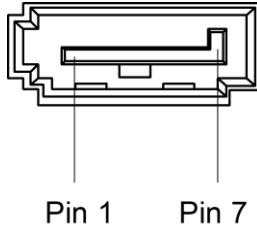

Pin	Pin Name	Signal Type	Signal Level
1	GND	GND	
2	SATA_TX1+	DIFF	
3	SATA_TX1-	DIFF	
4	GND	GND	
5	SATA_RX1-	DIFF	
6	SATA_RX1+	DIFF	
7	GND	GND	

2.4.9 Battery (CN9)

Pin	Pin Name	Signal Type	Signal Level
1	+3.3V	PWR	3.3V
2	GND	GND	

2.4.10 Dual USB 3.2 Gen 1 (CN11)

Pin	Pin Name	Signal Type	Signal Level
1	+5VSB	PWR	+5V
2	USB0_D-	DIFF	
3	USB0_D+	DIFF	
4	GND	GND	
5	USB0_SSRX-	DIFF	
6	USB0_SSRX+	DIFF	

Pin	Pin Name	Signal Type	Signal Level
7	GND	GND	
8	USB0_SSTX-	DIFF	
9	USB0_SSTX+	DIFF	
10	+5VSB	PWR	+5V
11	USB1_D-	DIFF	
12	USB1_D+	DIFF	
13	GND	GND	
14	USB1_SSRX-	DIFF	
15	USB1_SSRX+	DIFF	
16	GND	GND	
17	USB1_SSTX-	DIFF	
18	USB1_SSTX+	DIFF	

2.4.11 +5V Output for SATA HDD (CN12)

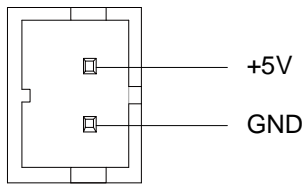

Pin	Pin Name	Signal Type	Signal Level
1	+5V	PWR	+5V
2	GND	GND	

2.4.12 HDMI Port (CN13)

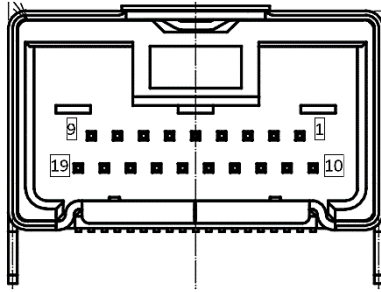

Pin	Pin Name	Signal Type	Signal Level
1	GND	GND	-
2	TMDS_DAT1+	DIFF	-
3	TMDS_DAT1-	DIFF	-
4	GND	GND	-
5	TMDS_CLK+	DIFF	-
6	TMDS_CLK-	DIFF	-
7	NC	-	-
8	DDC_DATA	I/O	+5V
9	+5V	PWR	+5V
10	TMDS_DAT2+	DIFF	-
11	TMDS_DAT2-	DIFF	-
12	GND	GND	-
13	TMDS_DAT0+	DIFF	-
14	TMDS_DAT0-	DIFF	-
15	GND	GND	-
16	NC	-	-
17	DDC_CLK	I/O	+5V
18	GND	GND	-
19	HPLG_DETECT	IN	-

2.4.13 External +12V Input (CN14)

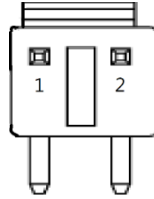

Pin	Pin Name	Signal Type	Signal Level
1	+12V	PWR	+12V
2	GND	GND	

2.4.14 DDR3L SODIMM Slot (CN15)

Standard specifications.

2.4.15 LVDS Connector (CN16)

Pin	Pin Name	Signal Type	Signal Level
1	BKL_ENABLE	OUT	-
2	BKL_CONTROL	OUT	-
3	LCD_PWR	PWR	+3.3V/+5V
4	GND	GND	-
5	LVDS_A_CLK-	DIFF	-
6	LVDS_A_CLK+	DIFF	-
7	LCD_PWR	PWR	+3.3V/+5V
8	GND	GND	-
9	LVDS_DA0-	DIFF	-
10	LVDS_DA0+	DIFF	-
11	LVDS_DA1-	DIFF	-
12	LVDS_DA1+	DIFF	-
13	LVDS_DA2-	DIFF	-
14	LVDS_DA2+	DIFF	-

Pin	Pin Name	Signal Type	Signal Level
15	LVDS_DA3-	DIFF	-
16	LVDS_DA3+	DIFF	-
17	DDC_DATA	I/O	+3.3V
18	DDC_CLK	I/O	+3.3V
19	LVDS_DB0-	DIFF	-
20	LVDS_DB0+	DIFF	-
21	LVDS_DB1-	DIFF	-
22	LVDS_DB1+	DIFF	-
23	LVDS_DB2-	DIFF	-
24	LVDS_DB2+	DIFF	-
25	LVDS_DB3-	DIFF	-
26	LVDS_DB3+	DIFF	-
27	LCD_PWR	PWR	+3.3V/+5V
28	GND	GND	-
29	LVDS_B_CLK-	DIFF	-
30	LVDS_B_CLK+	DIFF	-

Note 1: LVDS LCD_PWR can be set to +3.3V or +5V by JP2.

Note 2: The max. driving current is 2A.

2.4.16 COM Port 1/Port 2 & Line-Out Connector (CN17)

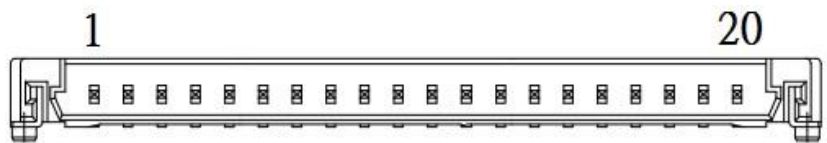

Pin	Pin Name	Signal Type	Signal Level
1	DCD2	IN	-
2	DSR2	IN	-
3	RX2	IN	-
4	RTS2	OUT	+9V

Pin	Pin Name	Signal Type	Signal Level
5	TX2	OUT	+9V
6	CTS2	IN	-
7	DTR2	OUT	+9V
8	RI2/+5V/+12V	IN/ PWR	+5V/+12V
9	DCD1	IN	-
10	DSR1	IN	-
11	RX1	IN	-
12	RTS1	OUT	+9V
13	TX1	OUT	+9V
14	CTS1	IN	-
15	DTR1	OUT	+9V
16	RI1	IN	-
17	GND	GND	-
18	AGND	GND	-
19	LOUT_R	I/O	-
20	LOUT_L	I/O	-

COM Port 2 RS-485

Pin	Pin Name	Signal Type	Signal Level
1	RS485_D-	I/O	+5V
2	NC	-	-
3	RS485_D+	I/O	+5V
4	NC	-	-
5	NC	-	-
6	NC	-	-
7	NC	-	-
8	NC/+5V/+12V	PWR	+5V/+12V
17	GND	GND	-

COM Port 2 RS-422			
Pin	Pin Name	Signal Type	Signal Level
1	RS422_TX-	OUT	±5V
2	NC		
3	RS422_TX+	OUT	±5V
4	NC		
5	RS422_RX+	IN	
6	NC		-
7	RS422_RX-	IN	
8	NC/+5V/+12V	PWR	+5V/+12V
17	GND	GND	

Note 1: COM2 RS-232/422/485 can be set by BIOS setting. Default is RS-232.

Note 2: COM2 RI/+5V/+12V function can be set by BOM (R248-RI/ R256-+12V/ R250-+5V).

2.4.17 LPC Connector (CN18)

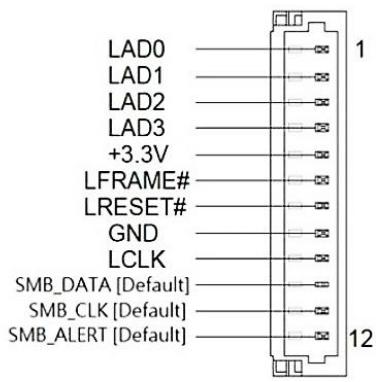

Pin	Pin Name	Signal Type	Signal Level
1	LAD0	I/O	+3.3V
2	LAD1	I/O	+3.3V
3	LAD2	I/O	+3.3V

Pin	Pin Name	Signal Type	Signal Level
4	LAD3	I/O	+3.3V
5	+3.3V	PWR	+3.3V
6	LFRAME#	IN	-
7	LRESET#	OUT	+3.3V
8	GND	GND	-
9	LCLK	OUT	-
10	SMB_DATA [Default]/I2C_DATA	I/O	+3.3V
11	SMB_CLK [Default]/I2C_CLK	OUT	+3.3V
12	SMB_ALERT [Default]/INT_SERIRQ	I/O	+3.3V

2.4.18 USB 2.0 Port 1 (CN19)

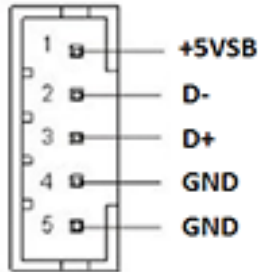

Pin	Pin Name	Signal Type	Signal Level
1	+5VSB	PWR	+5V
2	USBD5-	DIFF	-
3	USBD5+	DIFF	-
4	GND	GND	-
5	GND	GND	-

2.4.19 RJ-45 LAN Port (CN20)

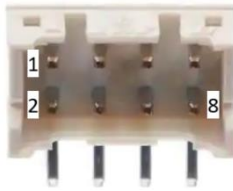

Pin	Pin Name	Signal Type
1	MDI3+	DIFF
2	MDI3-	DIFF
3	MDI2+	DIFF
4	MDI2-	DIFF
5	MDI1+	DIFF
6	MDI1-	DIFF
7	MDI0+	DIFF
8	MDI0-	DIFF

2.4.20 RJ-45 LAN LED Port (CN21)

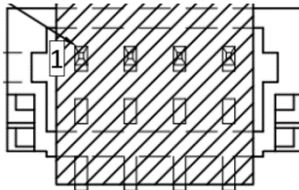

Pin	Pin Name	Signal Type	Signal Level
1	+3.3V	PWR	+3.3V
2	LAN_1000#	Signal	-
3	LAN_ACT	Signal	-
4	LAN_100#	Signal	-

2.5 Thermal Solutions

Heatspreader Assembly – Part no. PICO-APL2-HSK01.

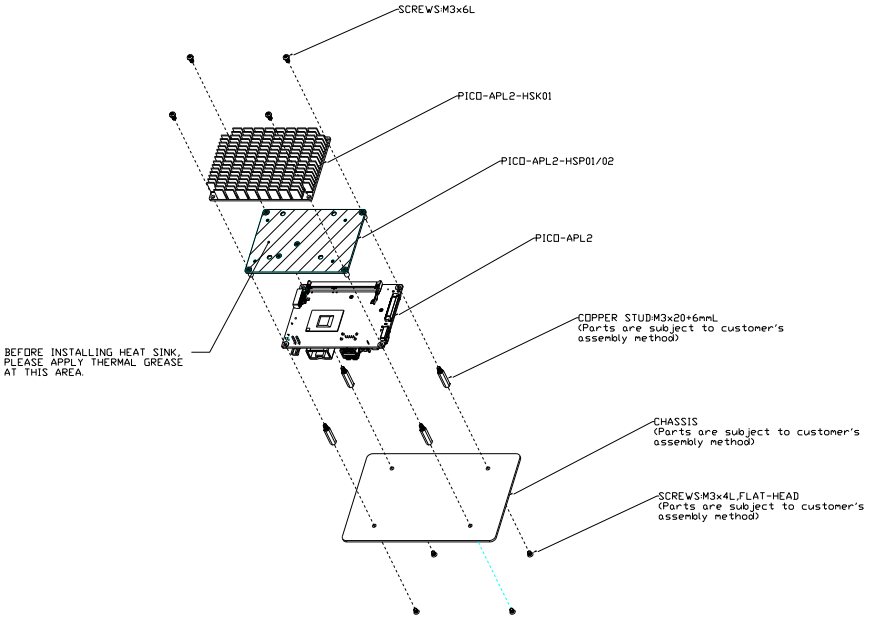

Chapter 3

AMI BIOS Setup

3.1 System Test and Initialization

The system uses certain routines to perform testing and initialization during the boot up sequence. If an error, fatal or non-fatal, is encountered, the system will output a few short beeps or display an error message. The system can usually continue the boot up sequence with non-fatal errors.

The system configuration verification routines check the current system configuration against the values stored in the CMOS memory and BIOS NVRAM. If a system configuration is not found or an error is detected, the system will load the default configuration and reboot automatically.

There are four situations in which you will need to setup system configuration:

1. You are starting your system for the first time
2. You have changed the hardware attached to your system
3. The system configuration was reset by the Clear-CMOS jumper
4. The CMOS memory has lost power and the configuration information has been erased.

The system CMOS memory has an integral lithium battery backup for data retention. However, you will need to replace the battery unit when it runs down.

3.2 AMI BIOS Setup

AMI BIOS ROM has a built-in Setup program that allows users to modify the basic system configuration. This type of information is stored in battery-backed CMOS RAM and BIOS NVRAM so that it retains the Setup information when the power is turned off.

Entering Setup

Power on the computer and press or <ESC> immediately. This will allow you to enter Setup.

Main

Set the date, use tab to switch between date elements.

Advanced

Enable/disable boot option for legacy network devices.

Chipset

Host bridge parameters.

Security

Set setup administrator password.

Boot

Enables/disable quiet boot option.

Save & Exit

Save changes and exit setup.

3.3 Setup Submenu: Main

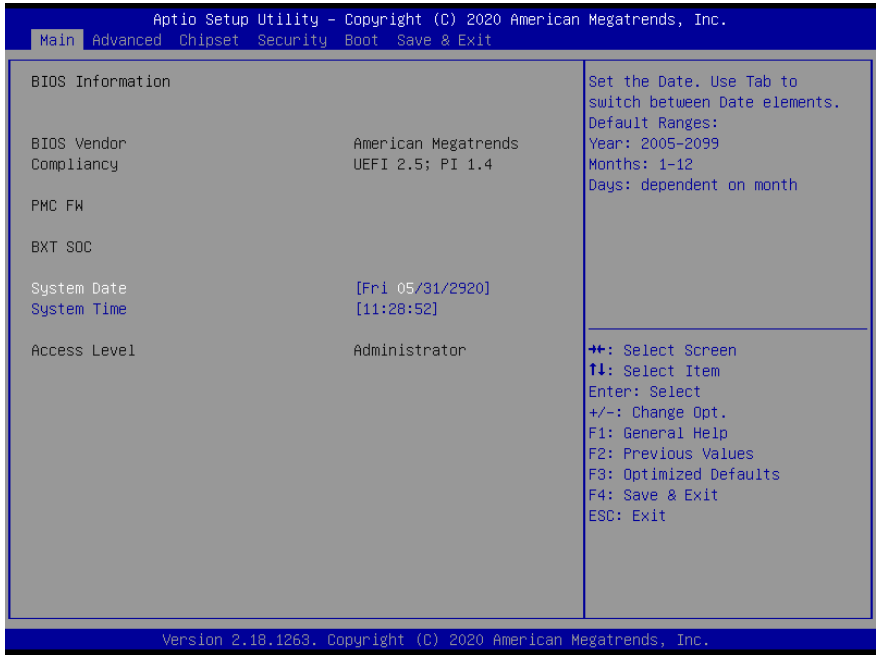

Options Summary		
System Date	Day MM:DD:YYYY	
Change the month, year and century. The 'Day' is changed automatically.		
System Time	HH : MM : SS	
Change the clock of the system.		

3.4 Setup Submenu: Advanced

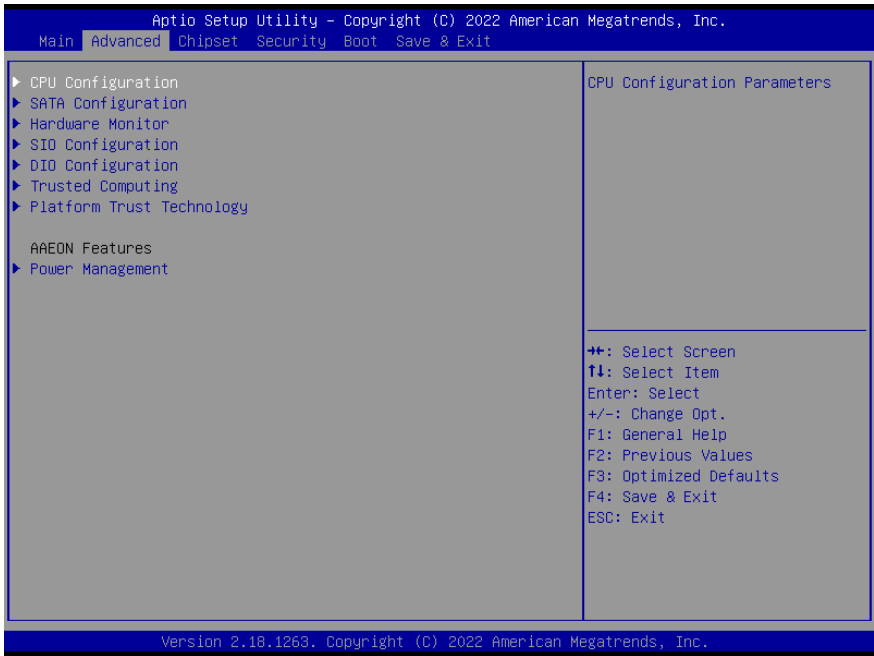

Options Summary	
CPU Configuration	Menu for CPU Configuration Parameters.
SATA Configuration	Menu for SATA Device Configuration.
Hardware Monitor	Display system hardware status (CPU temperature, etc.)
SIO Configuration	SIO Chip configuration. Enable or Disable SIO Logical Devices, Resources and Features settings, etc.
DIO Configuration	Set Input/ Output of Digital Port Configuration.
Trusted Computing	Set Security Device Support Parameters.
Platform Trust Technology	Set Platform Trust Technology Parameters.
Power Management	System ACPI/ Power Mode/ Wake Event Configuration.

3.4.1 CPU Configuration

Aptio Setup Utility - Copyright (C) 2020 American Megatrends, Inc.

Advanced

<p>CPU Configuration</p> <p>Intel(R) Celeron(R) CPU N3350 @ 1.10GHz CPU Signature 506C9 Microcode Patch 40 Max CPU Speed 1100 MHz Min CPU Speed 800 MHz Processor Cores 2 64-bit Supported Intel HT Technology Not Supported Intel VT-x Technology Supported</p> <p>L1 Data Cache 24 kB x 2 L1 Code Cache 32 kB x 2 L2 Cache 1024 kB x 2 L3 Cache Not Present</p> <p>C-States [Enabled] EIST [Enabled] Turbo Mode [Enabled] Intel Virtualization Technology [Enabled] VT-d [Disabled] Power Limit 1 Enable [Disabled]</p>	<p>Enable/Disable C States</p> <p>++: Select Screen !: Select Item Enter: Select +/-: Change Opt. F1: General Help F2: Previous Values F3: Optimized Defaults F4: Save & Exit ESC: Exit</p>
--	--

Version 2.18.1263, Copyright (C) 2020 American Megatrends, Inc.

Options Summary		
C-States	Disabled	
	Enabled	Optimal Default, Failsafe Default
Enable/Disable C States.		
EIST™	Disabled	
	Enabled	Optimal Default, Failsafe Default
Enable/Disable Intel SpeedStep.		
Turbo Mode	Disabled	
	Enabled	Optimal Default, Failsafe Default
Turbo mode.		
Intel Virtualization Technology	Disabled	
	Enabled	Optimal Default, Failsafe Default
When enabled, a VMM can utilize the additional hardware capabilities provided by Vanderpool Technology.		
VT-d	Disabled	Optimal Default, Failsafe Default
	Enabled	

Options Summary		
Enable/Disable CPU VT-d.		
Power Limit 1 Enable	Disabled	Optimal Default, Failsafe Default
	Enabled	
Enable/Disable Power Limit 1.		

3.4.2 SATA Configuration

Aprio Setup Utility - Copyright (C) 2020 American Megatrends, Inc.

Advanced

SATA GEN SPEED	[Auto]	SATA GEN SPEED SELECTION
Port 0	[Enabled]	
SATA Port 0	ST3250410AS (250.0GB)	
mSATA port	[Enabled]	
mSATA Port	[Not Installed]	

++: Select Screen
 T1: Select Item
 Enter: Select
 +/-: Change Opt.
 F1: General Help
 F2: Previous Values
 F3: Optimized Defaults
 F4: Save & Exit
 ESC: Exit

Version 2.18.1263. Copyright (C) 2020 American Megatrends, Inc.

Options Summary		
SATA GEN SPEED	AUTO	Optimal Default, Failsafe Default
	GEN1	
	GEN2	
	GEN3	
SATA GEN SPEED selection.		
Port 0/ mSATA port	Disabled	Optimal Default, Failsafe Default
	Enabled	
Enable/ Disable SATA port.		

3.4.3 Hardware Monitor

Aptio Setup Utility - Copyright (C) 2017 American Megatrends, Inc.

Advanced

CPU Temperature	: +55 °C
CPU(external) Temperature	: +48 °C
System Temperature	: +40 °C
VCORE	: +0.712 V
VMEM	: +1.352 V
+3.3V	: +3.152 V
VBAT	: +2.960 V

++: Select Screen
↑: Select Item
Enter: Select
+/-: Change Opt.
F1: General Help
F2: Previous Values
F3: Optimized Defaults
F4: Save & Exit
ESC: Exit

Version 2.18.1263. Copyright (C) 2017 American Megatrends, Inc.

3.4.4 SIO Configuration

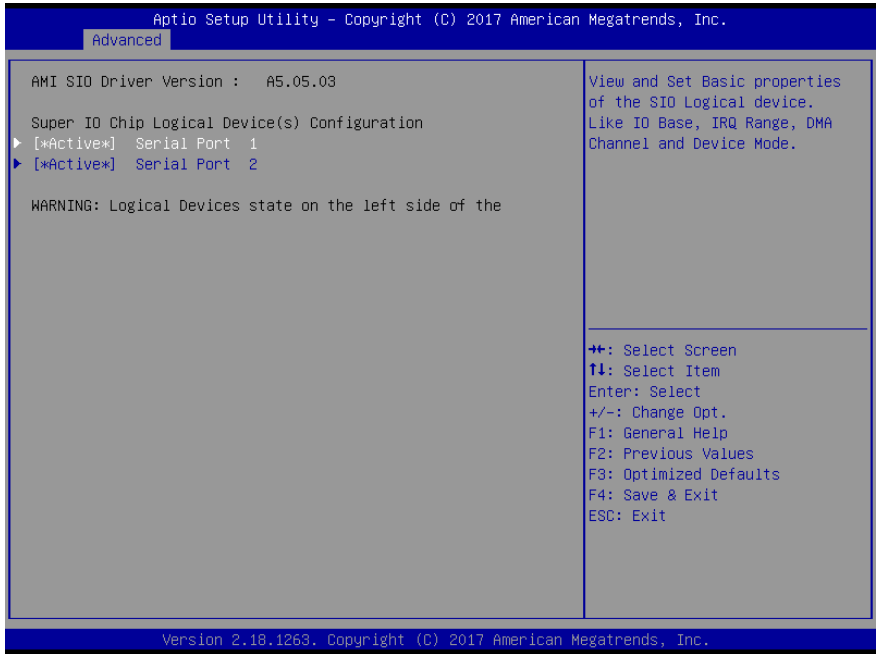

Options Summary	
Serial Port 1/2 Configuration	
View and Set Basic properties of the SIO Logical device. Like IO Base , IRQ Range , DMA Channel and Device Mode.	

3.4.4.1 Serial Port Configuration

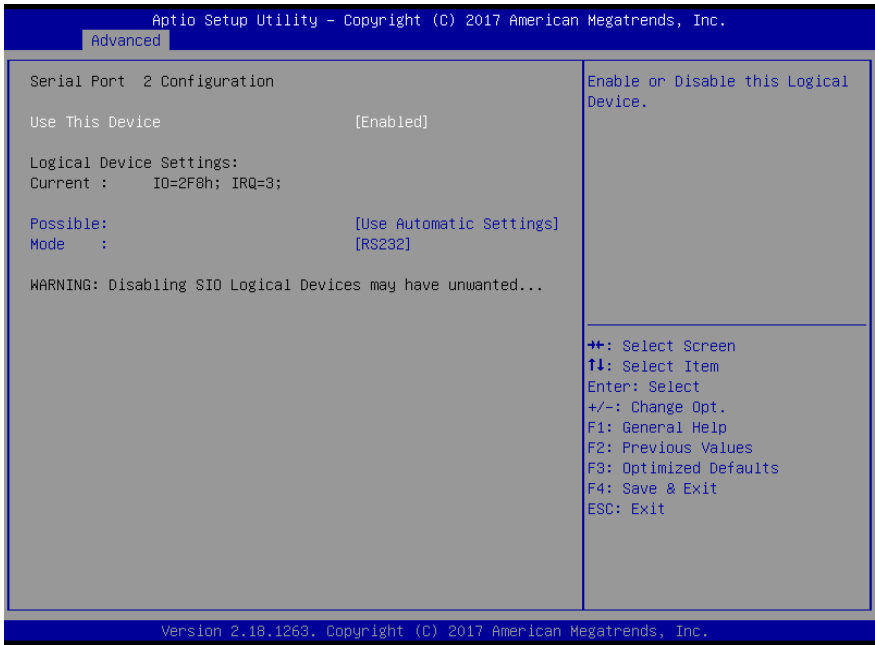

Options Summary		
Use This Device	Disable	
	Enable	Optimal Default, Failsafe Default
Enable or Disable this Logical Device.		
Possible:	Use Automatic Settings	Optimal Default, Failsafe Default
	IO=2F8h; IRQ=3	
	IO=3F8h; IRQ=4	
Allows user to change Device's Resource settings. New settings will be reflected on This Setup Page after System restarts.		
Mode:	RS232	Optimal Default, Failsafe Default
	RS422	
	RS485	
UART RS232, 422, 485 selection.		

3.4.5 DIO Configuration

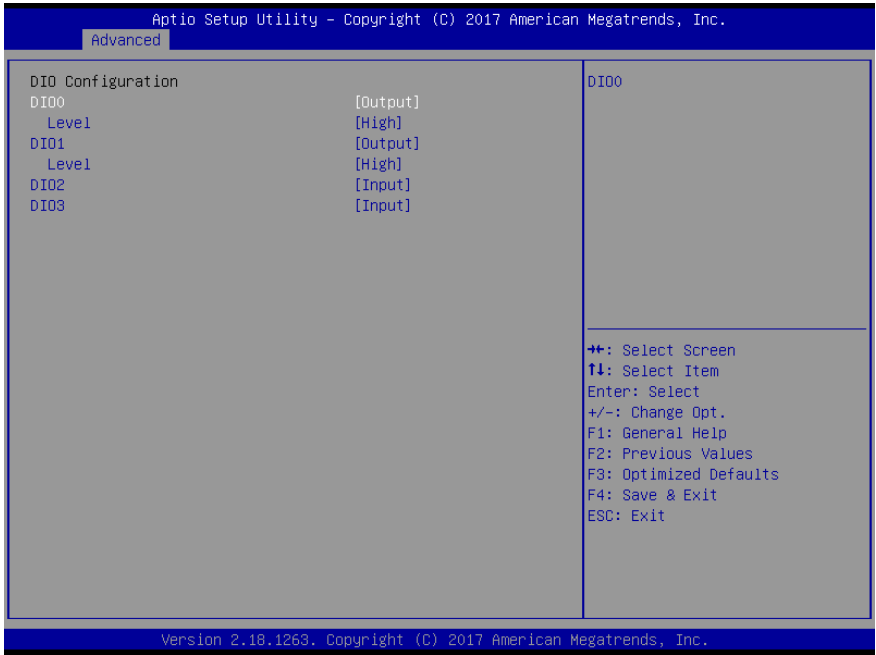

Options Summary		
DIO *	Output	
	Input	
Set DIO as Input or Output.		
Level	High	Optimal Default, Failsafe Default
	Low	
Set output level when DIO pin is output.		

3.4.6 Trusted Computing

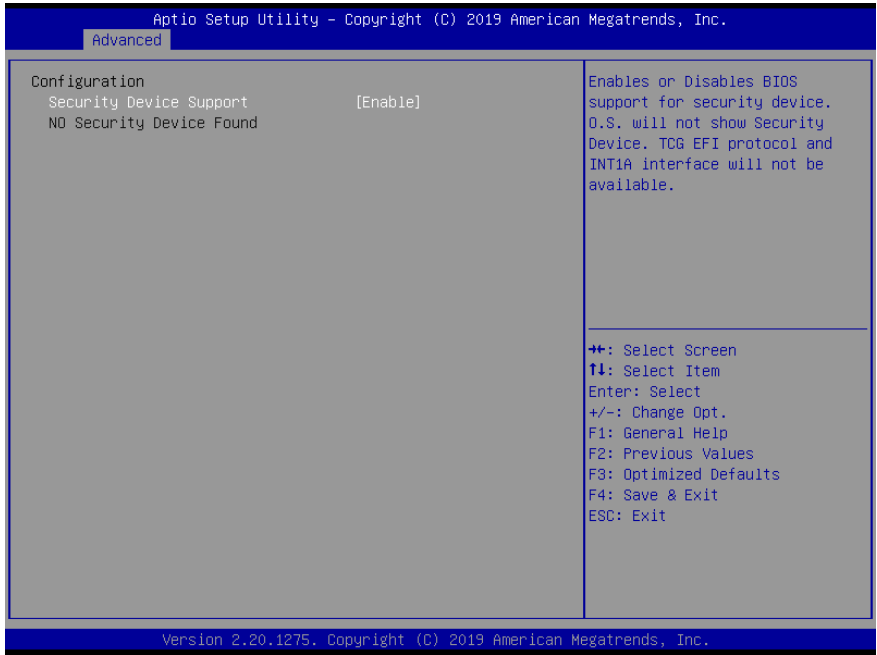

Options Summary		
Security Device Support	Disable	
	Enable	Optimal Default, Failsafe Default
Enables or Disables BIOS support for security device. O.S. will not show Security Device. TCG EFI protocol and INT1A interface will not be available.		
SHA-1 PCR Bank	Disable	
	Enable	Optimal Default, Failsafe Default
Enable or Disable SHA-1 PCR Bank.		
SHA256 PCR Bank	Disable	
	Enable	Optimal Default, Failsafe Default
Enable or Disable SHA256 PCR Bank.		
Pending Operation	None	Optimal Default, Failsafe Default
	TPM Clear	
Schedule an Operation for the Security Device. NOTE: Your Computer will reboot during restart in order to change State of Security Device.		

Options Summary		
Platform Hierarchy	Disabled	
	Enabled	Optimal Default, Failsafe Default
Enable or disable Platform Hierarchy.		
Storage Hierarchy	Disabled	
	Enabled	Optimal Default, Failsafe Default
Enable or Disable Storage Hierarchy.		
Endorsement Hierarchy	Disabled	
	Enabled	Optimal Default, Failsafe Default
Enable or Disable Endorsement Hierarchy.		
TPM2.0 UEFI Spec Version	TCG_1_2	
	TCG_2	Optimal Default, Failsafe Default
Select the TCG2 Spec Version Support, TCG_1_2: The compatible mode for Win8/Win10. TCG_2: Support new TCG2 protocol and event format for Win10 or later.		
Physical Presence Spec Version	1.2	
	1.3	Optimal Default, Failsafe Default
Select to Tell O.S. to support PPI Spec Version 1.2 or 1.3. Note some HCK tests might not support 1.3.		

3.4.7 TPM Configuration



Options Summary		
fTPM	Enabled	Optimal Default, Failsafe Default
	Disabled	
Enable\Disable fTPM support.		

3.4.8 Power Management

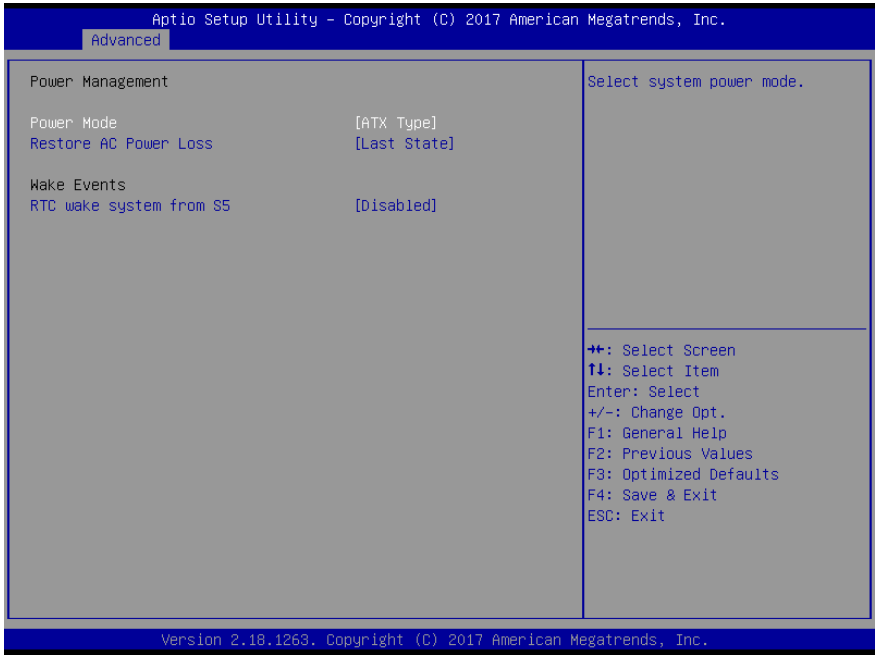

Options Summary		
Power Mode	ATX Type	Optimal Default, Failsafe Default
	AT Type	
Select system power mode.		
Restore AC Power Loss	Last State	Optimal Default, Failsafe Default
	Always On	
	Always Off	
Determine if the system turns on or off after AC resume from G3 to S5 state.		
RTC wake system from S5	Disable	Optimal Default, Failsafe Default
	Fixed Time	
RTC wake.		

3.5 Setup Submenu: Chipset

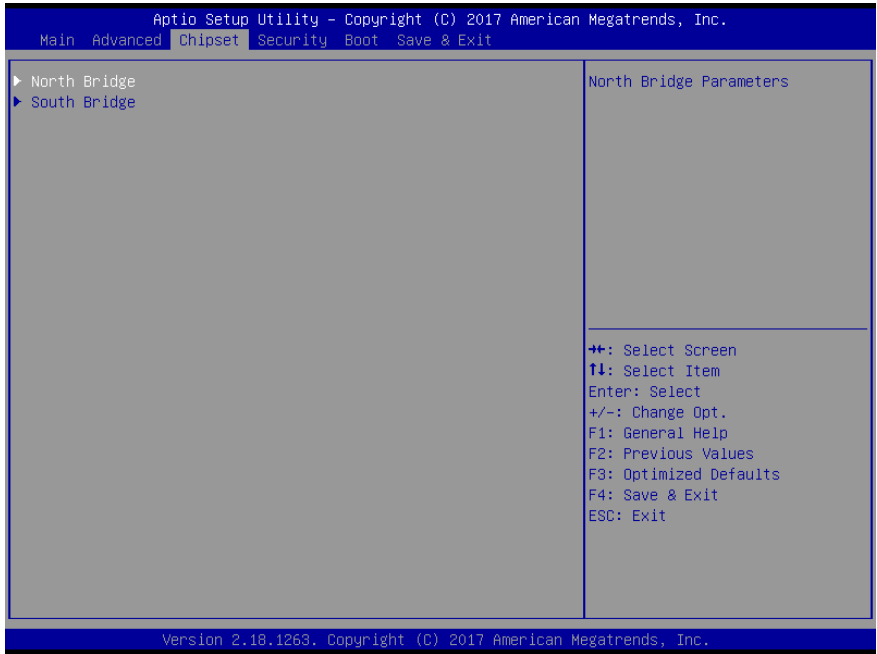

3.5.1 North Bridge

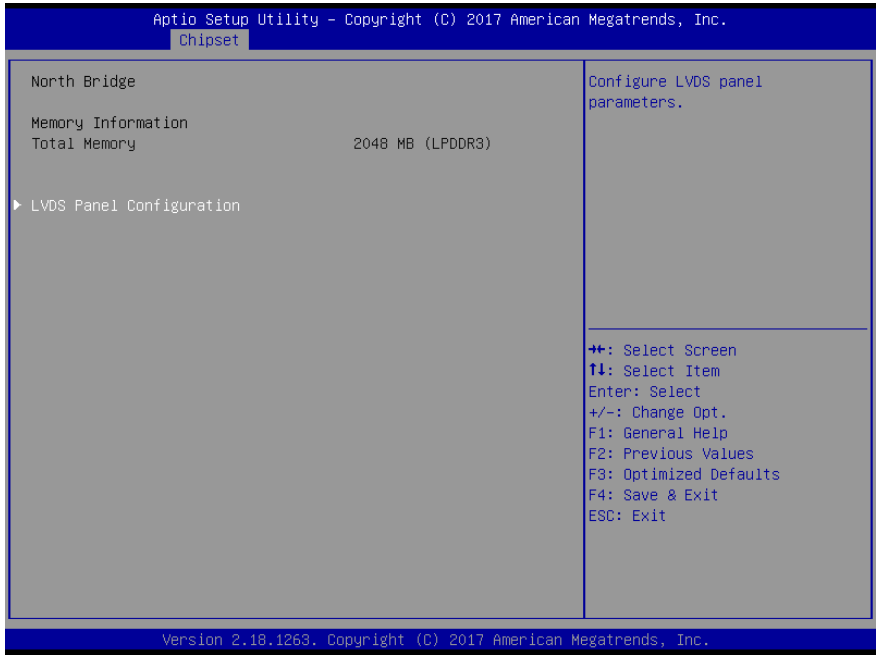

3.5.1.1 LVDS Panel Configuration

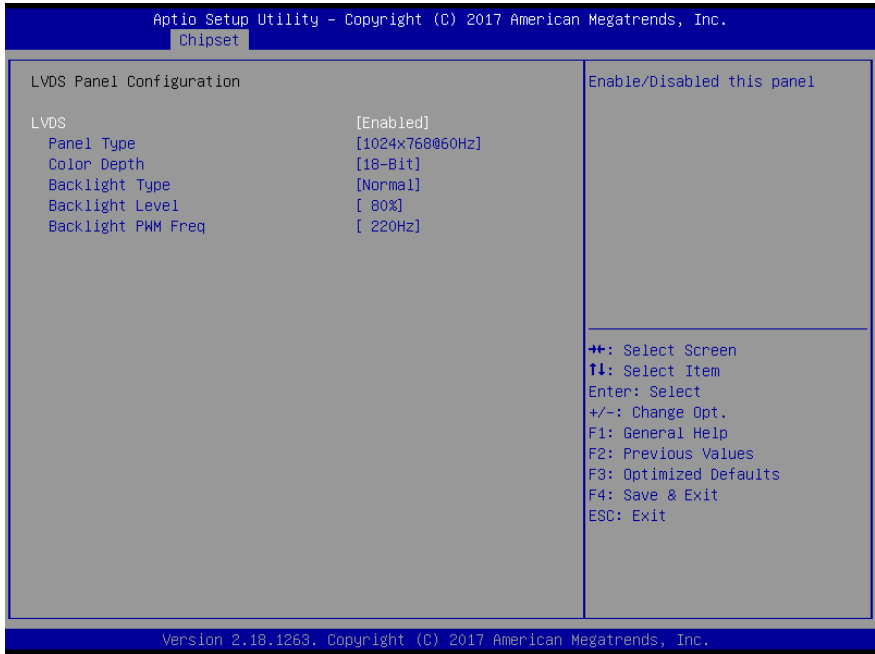

Options Summary		
LVDS	Disabled	
	Enabled	Optimal Default, Failsafe Default
Enable/Disabled this panel.		
LVDS Panel Type	640X480@60HZ	
	800X480@60HZ	
	800X600@60HZ	
	1024X600@60HZ	
	1024X768@60HZ	Optimal Default, Failsafe Default
	1280X768@60HZ	
	1280X800@60HZ	
	1280X1024@60HZ	
	1366X768@60HZ	
	1440X900@60HZ	
	1600X1200@60HZ	
	1920X1080@60HZ	

Options Summary		
LVDS Panel Type (Cont.)	1920X1200@60HZ	
Select LCD panel used by Internal Graphics Device by selecting the appropriate setup item.		
Color Depth	18-bit	Optimal Default, Failsafe Default
	24-bit	
	36-bit	
	48-bit	
Select panel depth.		
Backlight Type	Normal	Optimal Default, Failsafe Default
	Inverted	
Select backlight control signal type.		
Backlight Level	0%	
	10%	
	20%	
	30%	
	40%	
	50%	
	60%	
	70%	
	80%	Optimal Default, Failsafe Default
	90%	
100%		
Select backlight control level.		
Backlight PWM Freq	100Hz	
	200Hz	
	220Hz	Optimal Default, Failsafe Default
	500Hz	
	1.1KHz	
	2.2KHz	
	6.5KHz	
Select PWM frequency of backlight control signal.		

3.5.2 South Bridge

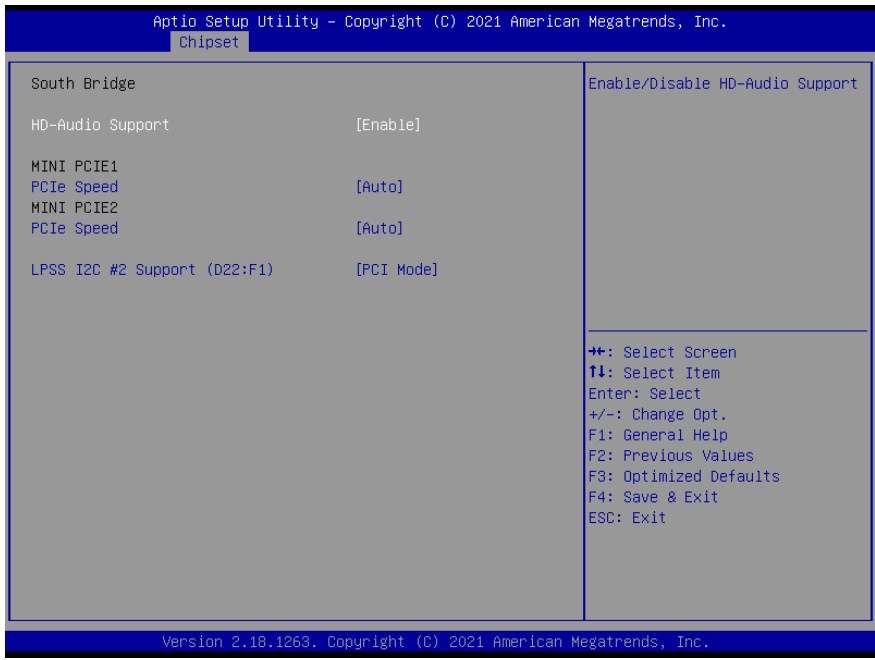

Options Summary		
HD-Audio Support	Disabled	
	Enabled	Optimal Default, Failsafe Default
Enable/ Disabled HD audio.		
PCIe Speed	Auto	Optimal Default, Failsafe Default
	Gen1	
	Gen2	
Configure PCIe Speed.		
LPSS I2C #2 Support (D22:F1)	Disable	
	PCI Mode	Optimal Default, Failsafe Default
	ACPI Mode	
Enable/Disable LPSS I2C #2 Support.		

3.6 Setup Submenu: Security

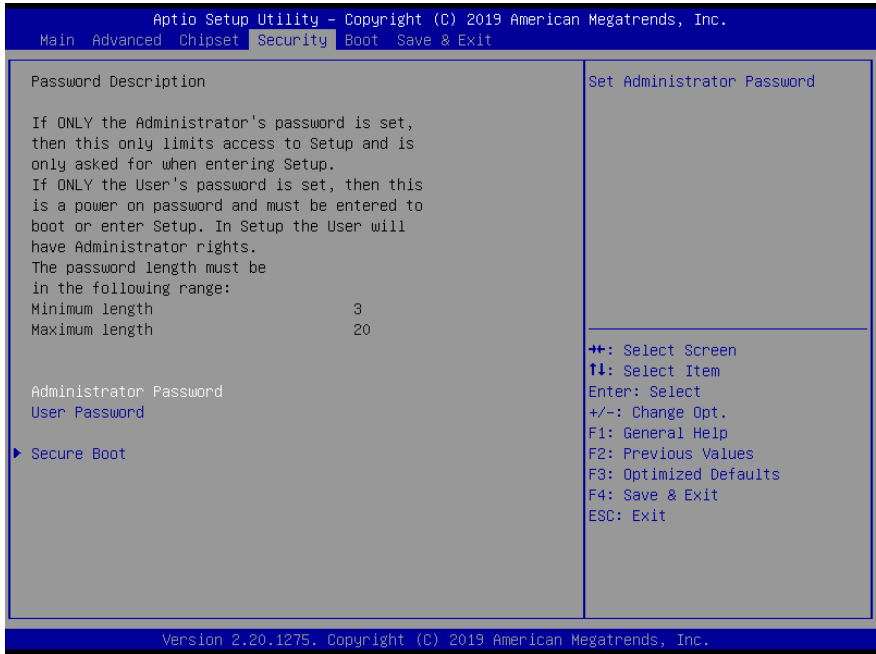

Change User/Administrator Password

You can set an Administrator Password or User Password. An Administrator Password must be set before you can set a User Password. The password will be required during boot up, or when the user enters the Setup utility. A User Password does not provide access to many of the features in the Setup utility.

Select the password you wish to set, and press Enter. In the dialog box, enter your password (must be between 3 and 20 letters or numbers). Press Enter and retype your password to confirm. Press Enter again to set the password.

Removing the Password

Select the password you want to remove and enter the current password. At the next dialog box press Enter to disable password protection.

3.6.1 Secure Boot

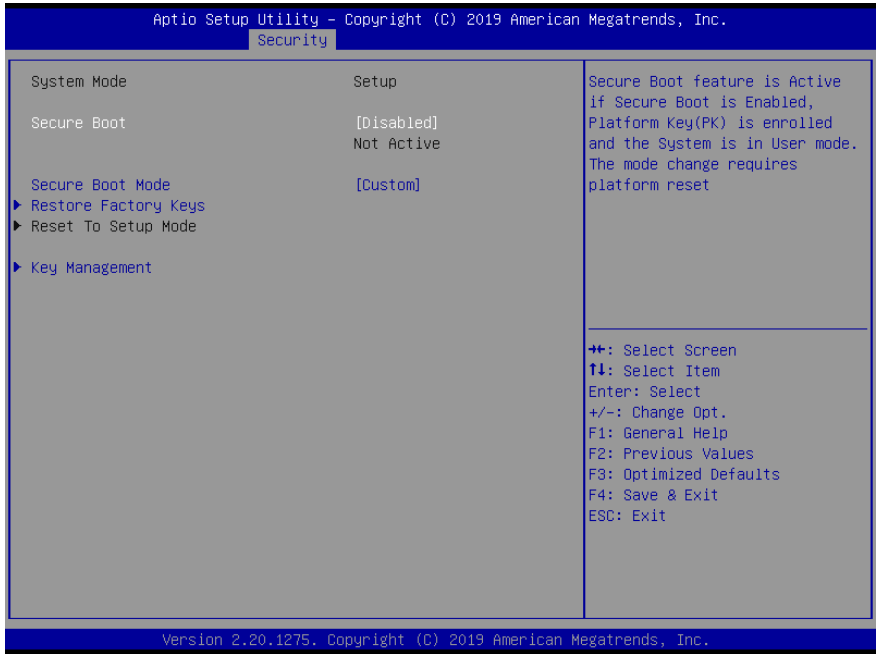

Options Summary		
Secure Boot	Disabled	Optimal Default, Failsafe Default
	Enabled	
Secure Boot feature is Active if Secure Boot is Enabled, Platform Key (PK) is enrolled and the System is in User mode. The mode change requires platform reset.		
Secure Boot Mode	Custom	Optimal Default, Failsafe Default
	Standard	
Secure Boot mode options: Standard or Custom. In Custom mode, Secure Boot Policy variables can be configured by a physically present user without full authentication.		
Restore Factory Keys		
Force System to User Mode. Install factory default Secure Boot key databases.		
Reset to Setup Mode		
Delete all Secure Boot key databases from NVRAM.		

3.6.1.1 Key Management

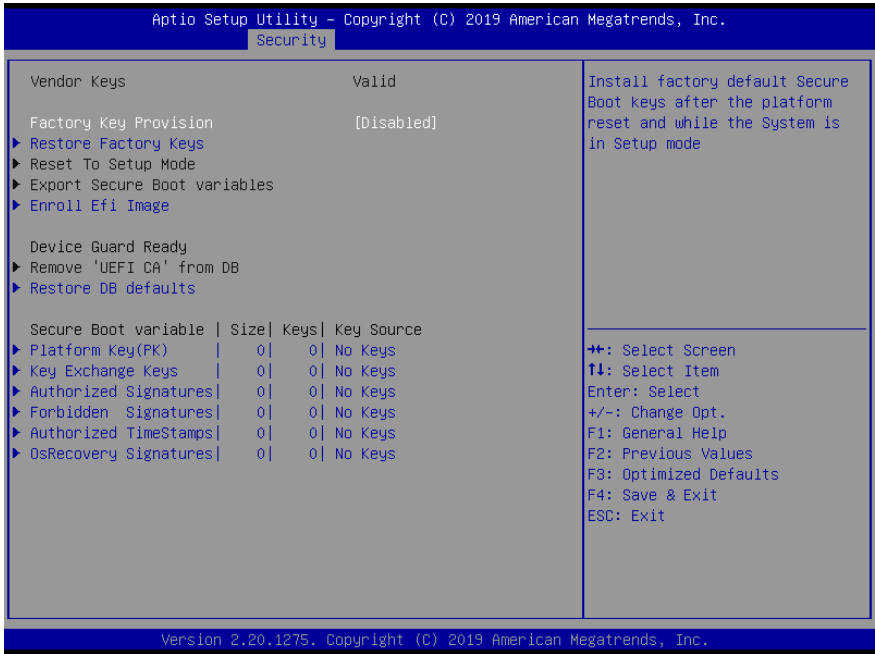

Options Summary		
Factory Key Provision	Disabled	Optimal Default, Failsafe Default
	Enabled	
Secure Boot feature is Active if Secure Boot is Enabled, Platform Key (PK) is enrolled and the System is in User mode. The mode change requires platform reset.		
Restore Factory Keys		
Force System to User Mode. Install factory default Secure Boot key databases.		
Reset to Setup Mode		
Delete all Secure Boot key databases from NVRAM.		
Export Secure Boot variables		
Copy NVRAM content of Secure Boot variables to files in a root folder on a file system device.		
Enroll Efi Image		
Allow the image to run in Secure Boot mode. Enroll SHA256 Hash certificate of a PE image into Authorized Signature Database (db).		
Remove 'UEFI CA' from DB		

Options Summary	
Device Guard ready system must not list 'Microsoft UEFI CA' Certificate in Authorized Signature database (db).	
Restore DB defaults	
Restore DB variable to factory defaults.	
Platform Key (PK)	Details
	Export
	Update
	Delete
Key Exchange Keys	Details
	Export
	Update
	Delete
Authorized Signatures	Details
	Export
	Update
	Delete
Forbidden Signatures	Details
	Export
	Update
	Delete
Authorized TimeStamps	Update
	Append
OsRecovery Signatures	Update
	Append
Enroll Factory Defaults or load certificates from a file:	
1. Public Key Certificate:	
a) EFI_SIGNATURE_LIST	
b) EFI_CERT_X509 (DER)	
c) EFI_CERT_RSA2048 (bin)	
d) EFI_CERT_SHAXXX	
2. Authenticated UEFI Variable	
3. EFI PE/COFF Image (SHA256)	
Key Source: Factory, External, Mixed	

3.7 Setup Submenu: Boot

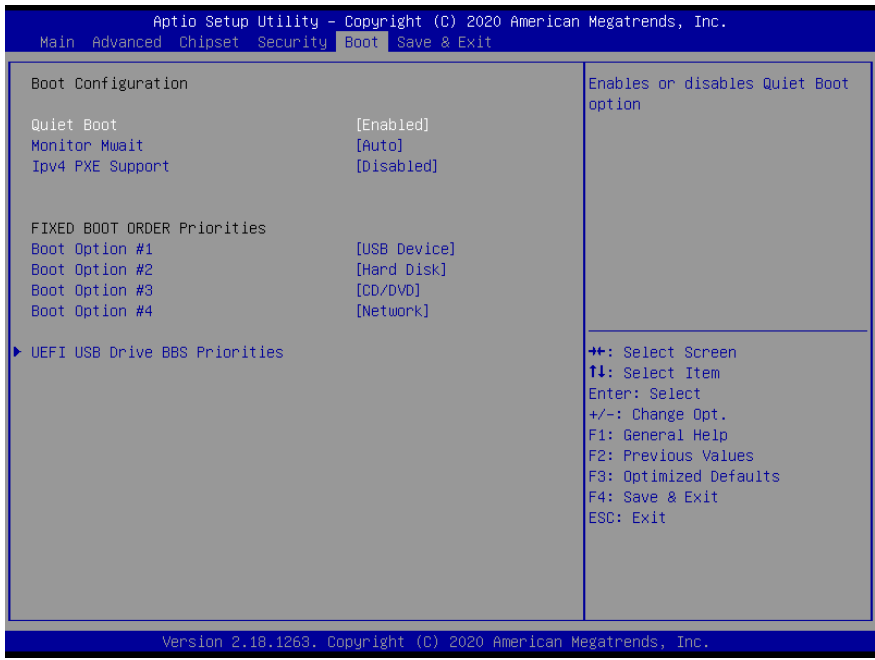

Options Summary		
Quiet Boot	Disabled	
	Enabled	Optimal Default, Failsafe Default
Enable/Disable showing boot logo.		
Monitor Mwait	Disable	
	Enabled	
	Auto	Optimal Default, Failsafe Default
Enable/Disable Monitor Mwait. To install Linux OS, please set this item to disable.		
IPv4 PXE Support	Disabled	Optimal Default, Failsafe Default
	Enabled	
Enable IPv4 PXE Boot Support. If disabled IPV4 PXE boot option will not be created.		

3.7.1 BBS Priorities

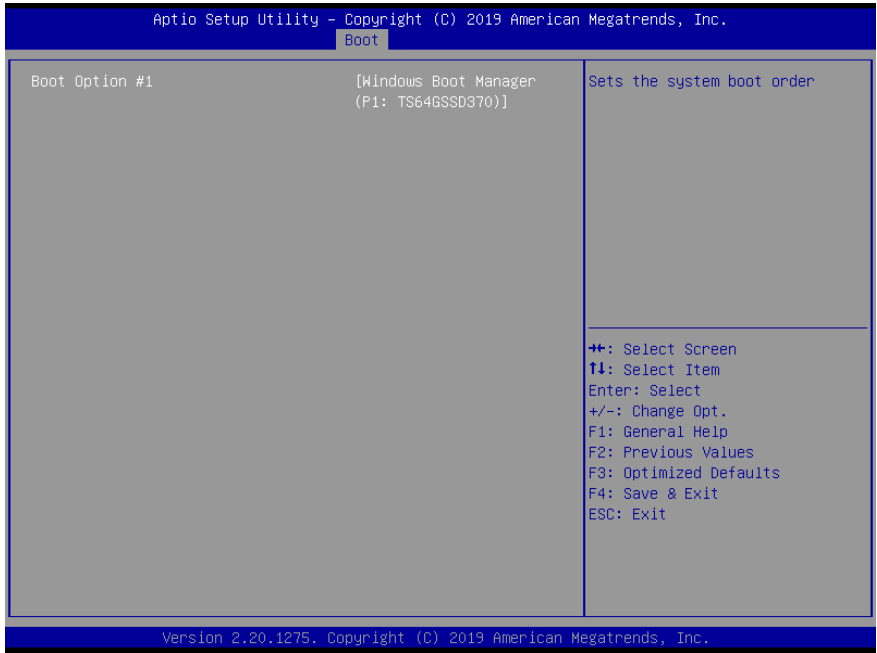

3.8 Setup Submenu: Save & Exit

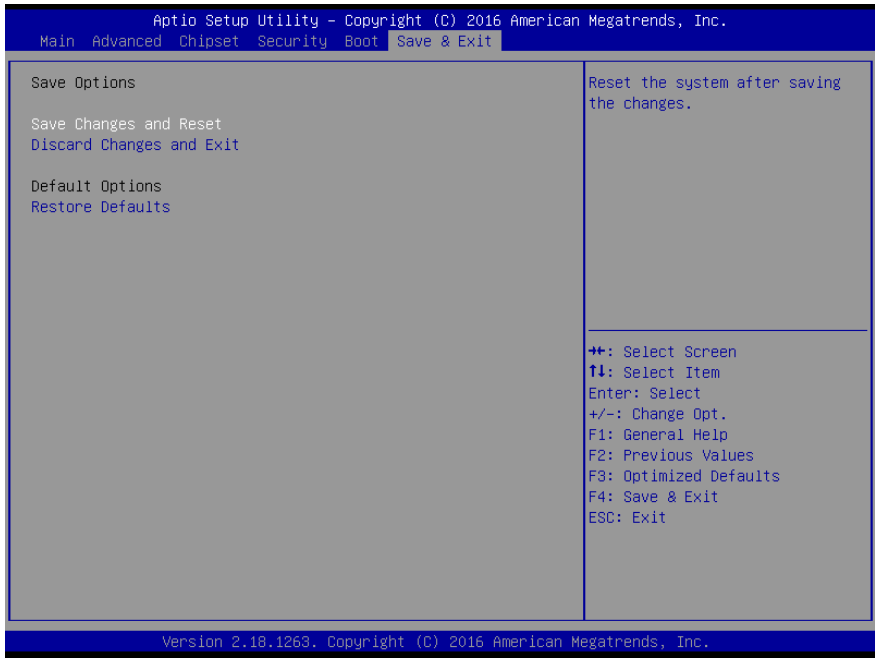

Chapter 4

Drivers Installation

4.1 Driver Download/Installation

Drivers for the PICO-APL2 can be downloaded from the product page on the AAEON website by following this link:

<https://www.aaeon.com/en/p/pico-itx-board-pico-apl2>

Download the driver(s) you need and follow the steps below to install them.

Step 1 – Install Chipset Driver

1. Open the **Chipset** folder and open the **SetupChipset.exe** file
2. Follow the instructions
3. Drivers will be installed automatically

Step 2 – Install Graphics Driver

1. Open the **Graphics Driver** folder and open the **Setup.exe** file
2. Follow the instructions
3. Driver will be installed automatically

Step 3 – Install LAN Driver

1. Open the **LAN** folder and select your OS
2. Open the **.exe** file in the folder
3. Follow the instructions
4. Driver will be installed automatically

Step 4 – Install Audio Driver

1. Open the **Audio** folder and open the **Setup.exe** file
2. Follow the instructions
3. Driver will be installed automatically

Step 5 – Install TXE Driver

1. Open the **TXE** folder and open the **SetupTXE.exe** file
2. Follow the instructions
3. Driver will be installed automatically

Step 6 – Install FintekSerial_Patch_T4R8 Driver

1. Open the **COM port Driver** folder and open the **FintekSerial.exe** file
2. Follow the instructions
3. Driver will be installed automatically

Step 7 – Install Peripheral Drivers

1. Open the **Linux Driver-Peripheral** folder and follow the instructions provided to manually install drivers.

Appendix A

I/O Information

A.1 I/O Address Map

Pico-ITX Board

PICO-APL2

Address Range	Device Name
[0000000000000000 - 000000000000006F]	PCI Express Root Complex
[0000000000000020 - 0000000000000021]	Programmable interrupt controller
[0000000000000024 - 0000000000000025]	Programmable interrupt controller
[0000000000000028 - 0000000000000029]	Programmable interrupt controller
[000000000000002C - 000000000000002D]	Programmable interrupt controller
[000000000000002E - 000000000000002F]	Motherboard resources
[0000000000000030 - 0000000000000031]	Programmable interrupt controller
[0000000000000034 - 0000000000000035]	Programmable interrupt controller
[0000000000000038 - 0000000000000039]	Programmable interrupt controller
[000000000000003C - 000000000000003D]	Programmable interrupt controller
[0000000000000040 - 0000000000000043]	System timer
[000000000000004E - 000000000000004F]	Motherboard resources
[0000000000000050 - 0000000000000053]	System timer
[0000000000000060 - 0000000000000060]	Standard PS/2 Keyboard
[0000000000000061 - 0000000000000061]	Motherboard resources
[0000000000000063 - 0000000000000063]	Motherboard resources
[0000000000000064 - 0000000000000064]	Standard PS/2 Keyboard
[0000000000000065 - 0000000000000065]	Motherboard resources
[0000000000000067 - 0000000000000067]	Motherboard resources
[0000000000000070 - 0000000000000070]	Motherboard resources
[0000000000000070 - 0000000000000077]	System CMOS/real time clock
[0000000000000078 - 00000000000000CF7]	PCI Express Root Complex
[0000000000000080 - 000000000000008F]	Motherboard resources
[0000000000000092 - 0000000000000092]	Motherboard resources
[00000000000000A0 - 00000000000000A1]	Programmable interrupt controller
[00000000000000A4 - 00000000000000A5]	Programmable interrupt controller
[00000000000000A8 - 00000000000000A9]	Programmable interrupt controller
[00000000000000AC - 00000000000000AD]	Programmable interrupt controller
[00000000000000B0 - 00000000000000B1]	Programmable interrupt controller
[00000000000000B2 - 00000000000000B3]	Motherboard resources
[00000000000000B4 - 00000000000000B5]	Programmable interrupt controller
[00000000000000B8 - 00000000000000B9]	Programmable interrupt controller
[00000000000000BC - 00000000000000BD]	Programmable interrupt controller
[00000000000002F8 - 00000000000002FF]	Communications Port (COM2)
[00000000000003F8 - 00000000000003FF]	Communications Port (COM1)
[0000000000000400 - 000000000000047F]	Motherboard resources
[00000000000004D0 - 00000000000004D1]	Programmable interrupt controller
[0000000000000500 - 00000000000005FE]	Motherboard resources
[0000000000000680 - 000000000000069F]	Motherboard resources
[0000000000000A00 - 0000000000000A0F]	Motherboard resources
[0000000000000A10 - 0000000000000A1F]	Motherboard resources
[0000000000000D00 - 0000000000000FFF]	PCI Express Root Complex
[0000000000000E00 - 0000000000000FFF]	Intel(R) Celeron(R)/Pentium(R) Processor PCI Express Root Port - 5AD8
[000000000000F000 - 000000000000F03F]	Intel(R) HD Graphics
[000000000000F040 - 000000000000F05F]	Intel(R) Celeron(R)/Pentium(R) Processor SMBUS - 5AD4
[000000000000F060 - 000000000000F07F]	Standard SATA AHCI Controller
[000000000000F080 - 000000000000F083]	Standard SATA AHCI Controller
[000000000000F090 - 000000000000F097]	Standard SATA AHCI Controller

































A.2 Memory Address Map

Pico-ITX Board

PICO-APL2

Address Range	Device Name
[0000000000A0000 - 0000000000BFFFF]	PCI Express Root Complex
[0000000000C0000 - 0000000000DFFFF]	PCI Express Root Complex
[0000000000E0000 - 0000000000FFFFFF]	PCI Express Root Complex
[000000007B800001 - 000000007BFFFFFF]	PCI Express Root Complex
[000000007C000001 - 000000007FFFFFFF]	PCI Express Root Complex
[0000000080000000 - 000000008FFFFFFF]	Intel(R) HD Graphics
[0000000080000000 - 00000000CFFFFFFF]	PCI Express Root Complex
[0000000090000000 - 0000000090FFFFFF]	Intel(R) HD Graphics
[0000000091000000 - 00000000910FFFFFF]	High Definition Audio Controller
[0000000091100000 - 00000000911FFFFFF]	Intel(R) I210 Gigabit Network Connection
[0000000091100000 - 00000000911FFFFFF]	Intel(R) Celeron(R)/Pentium(R) Processor PCI Express Root Port - 5AD8
[0000000091120000 - 0000000091123FFF]	Intel(R) I210 Gigabit Network Connection
[0000000091200000 - 000000009120FFFF]	Intel(R) USB 3.0 eXtensible Host Controller - 1.0 (Microsoft)
[0000000091210000 - 0000000091213FFF]	High Definition Audio Controller
[0000000091214000 - 0000000091215FFF]	Standard SATA AHCI Controller
[0000000091218000 - 00000000912180FF]	Intel(R) Celeron(R)/Pentium(R) Processor SMBUS - 5AD4
[0000000091219000 - 00000000912197FF]	Standard SATA AHCI Controller
[000000009121A000 - 000000009121A0FF]	Standard SATA AHCI Controller
[000000009121E000 - 000000009121EFFF]	Intel(R) Trusted Execution Engine Interface
[00000000D0C00000 - 00000000D0C00653]	Intel(R) Serial IO GPIO Host Controller - INT3452
[00000000D0C40000 - 00000000D0C40763]	Intel(R) Serial IO GPIO Host Controller - INT3452
[00000000D0C50000 - 00000000D0C5076B]	Intel(R) Serial IO GPIO Host Controller - INT3452
[00000000D0C70000 - 00000000D0C70673]	Intel(R) Serial IO GPIO Host Controller - INT3452
[00000000E0000000 - 00000000EFFFFFFF]	Motherboard resources
[00000000E0000000 - 00000000EFFFFFFF]	PCI Express Root Complex
[00000000FEA00000 - 00000000FEAFFFFFFF]	Motherboard resources
[00000000FED00000 - 00000000FED003FF]	High precision event timer
[00000000FED01000 - 00000000FED01FFF]	Motherboard resources
[00000000FED03000 - 00000000FED03FFF]	Motherboard resources
[00000000FED06000 - 00000000FED06FFF]	Motherboard resources
[00000000FED08000 - 00000000FED09FFF]	Motherboard resources
[00000000FED1C000 - 00000000FED1CFFF]	Motherboard resources
[00000000FED80000 - 00000000FEDBFFFF]	Motherboard resources
[00000000FEE00000 - 00000000FEEFFFFFFF]	Motherboard resources

A.3 IRQ Mapping Chart

- ▼  **Interrupt request (IRQ)**
-  (ISA) 0x00000000 (00) System timer
-  (ISA) 0x00000001 (01) Standard PS/2 Keyboard
-  (ISA) 0x00000003 (03) Communications Port (COM2)
-  (ISA) 0x00000004 (04) Communications Port (COM1)
-  (ISA) 0x00000008 (08) High precision event timer
-  (ISA) 0x0000000C (12) PS/2 Compatible Mouse
-  (ISA) 0x0000000E (14) Intel(R) Serial IO GPIO Host Controller - INT3452
-  (ISA) 0x0000000E (14) Intel(R) Serial IO GPIO Host Controller - INT3452
-  (ISA) 0x0000000E (14) Intel(R) Serial IO GPIO Host Controller - INT3452
-  (ISA) 0x0000000E (14) Intel(R) Serial IO GPIO Host Controller - INT3452
-  (ISA) 0x00000036 (54) Microsoft ACPI-Compliant System
-  (ISA) 0x00000037 (55) Microsoft ACPI-Compliant System
-  (ISA) 0x00000038 (56) Microsoft ACPI-Compliant System
-  (ISA) 0x00000039 (57) Microsoft ACPI-Compliant System
-  (ISA) 0x0000003A (58) Microsoft ACPI-Compliant System
-  (ISA) 0x0000003B (59) Microsoft ACPI-Compliant System
-  (ISA) 0x0000003C (60) Microsoft ACPI-Compliant System
-  (ISA) 0x000001FF (511) Microsoft ACPI-Compliant System
-  (PCI) 0x00000019 (25) High Definition Audio Controller
-  (PCI) 0xFFFFFFF3 (-13) Intel(R) USB 3.0 eXtensible Host Controller - 1.0 (Microsoft)
-  (PCI) 0xFFFFFFF4 (-12) Intel(R) I210 Gigabit Network Connection
-  (PCI) 0xFFFFFFF5 (-11) Intel(R) I210 Gigabit Network Connection
-  (PCI) 0xFFFFFFF6 (-10) Intel(R) I210 Gigabit Network Connection
-  (PCI) 0xFFFFFFF7 (-9) Intel(R) I210 Gigabit Network Connection
-  (PCI) 0xFFFFFFF8 (-8) Intel(R) I210 Gigabit Network Connection
-  (PCI) 0xFFFFFFF9 (-7) Intel(R) I210 Gigabit Network Connection
-  (PCI) 0xFFFFFFFA (-6) Intel(R) Trusted Execution Engine Interface
-  (PCI) 0xFFFFFFF8 (-5) Intel(R) HD Graphics
-  (PCI) 0xFFFFFFF4 (-4) Standard SATA AHCI Controller
-  (PCI) 0xFFFFFFF3 (-3) Intel(R) Celeron(R)/Pentium(R) Processor PCI Express Root Port - 5AD6
-  (PCI) 0xFFFFFFF2 (-2) Intel(R) Celeron(R)/Pentium(R) Processor PCI Express Root Port - 5AD8

Appendix B

Mating Connectors

B.1 List of Mating Connectors and Cables

The table notes mating connectors and available cables.

Connector Label	Function	Mating Connector		Available Cable	Cable P/N
		Vendor	Model no		
CN1	Digital IO Port	Molex	51110-0650	N/A	N/A
CN2	LVDS Port Inverter / Backlight Connector	JST	PHR-5	N/A	N/A
CN3	Front Panel	Molex	51110-1050	Front Panel Cable	1701100156
CN7	BIO connector	HRS	FX18-80S-0.8SV20	N/A	N/A
CN8	SATA Port	Molex	887505318	SATA Cable	1709070500
CN9	Battery	Molex	51021-0200	Battery Cable	175011301C
CN12	+5V Output for SATA HDD	JST	PHR-2	SATA power cable	1702150155
CN13	HDMI Port	HRS	GT32B-19DP-0.75H		
CN14	External +12V Input	JST	JST.S2P-VH(LF)(SN)		
CN16	LVDS Port	ACES	50247-030H0H0-001	LVDS Cable	1704300030
CN17	COM Port 1, Port 2 and Line-Out Connector	HRS	DF14-20S-1.25C	COM Port 1/2 & line out cable	1703200153
CN18	LPC Port	JST	SHR-12V-S-B	AAEON LPC Cable	1703120130
CN19	USB2.0 Port 1	Molex	51021-0500	USB Cable	1700050207
CN20	LAN (RJ-45) Port	JST	JST.S8B-PHDSS(LF)(SN)		
CN21	LAN (RJ-45) LED Port	PINREX	710-73-04TWEO		