

PICO-AM62

PICO-ITX Single Board Computer

User's Manual 1st Ed

Copyright Notice

This document is copyrighted, 2024. All rights are reserved. The original manufacturer reserves the right to make improvements to the products described in this manual at any time without notice.

No part of this manual may be reproduced, copied, translated, or transmitted in any form or by any means without the prior written permission of the original manufacturer. Information provided in this manual is intended to be accurate and reliable. However, the original manufacturer assumes no responsibility for its use, or for any infringements upon the rights of third parties that may result from its use.

The material in this document is for product information only and is subject to change without notice. While reasonable efforts have been made in the preparation of this document to assure its accuracy, AAEMON assumes no liabilities resulting from errors or omissions in this document, or from the use of the information contained herein.

AAEMON reserves the right to make changes in the product design without notice to its users.

Acknowledgement

All other products' name or trademarks are properties of their respective owners.

- Microsoft Windows® is a registered trademark of Microsoft Corp.
- Texas Instruments™ and Sitara™ are trademarks of Texas Instruments
- Arm® and Cortex® are registered trademarks of Arm Limited (or its subsidiaries)
- ITE is a trademark of Integrated Technology Express, Inc.
- IBM and VGA are trademarks of International Business Machines Corporation.
- Debian is a registered trademark owned by Software in the Public Interest, Inc.
- Realtek is a trademark of Realtek Semiconductor Corporation

All other product names or trademarks are properties of their respective owners.

Omission of a product name from this list does not imply any claim to ownership by the publisher of this document.

Packing List

Before setting up your product, please make sure the following items have been shipped:

Item	Quantity
● PICO-AM62	1
● 2-pin 3.81mm Power Terminal Block w/lock	1
● 14-pin 2.54mm Phoenix plug in Connector/lock	1

If any of these items are missing or damaged, please contact your distributor or sales representative immediately.

About this Document

This User's Manual contains all the essential information, such as detailed descriptions and explanations on the product's hardware and software features (if any), its specifications, dimensions, jumper/connector settings/definitions, and driver installation instructions (if any), to facilitate users in setting up their product.

Users may refer to the product page on AAEON.com for the latest version of this document.

Safety Precautions

Please read the following safety instructions carefully. It is advised that you keep this manual for future references

1. All cautions and warnings on the device should be noted.
2. Make sure the power source matches the power rating of the device.
3. Position the power cord so that people cannot step on it. Do not place anything over the power cord.
4. Always completely disconnect the power before working on the system's hardware.
5. No connections should be made when the system is powered as a sudden rush of power may damage sensitive electronic components.
6. If the device is not to be used for a long time, disconnect it from the power supply to avoid damage by transient over-voltage.
7. Always disconnect this device from any AC supply before cleaning.
8. While cleaning, use a damp cloth instead of liquid or spray detergents.
9. Make sure the device is installed near a power outlet and is easily accessible.
10. Keep this device away from humidity.
11. Place the device on a solid surface during installation to prevent falls
12. Do not cover the openings on the device to ensure optimal heat dissipation.
13. Watch out for high temperatures when the system is running.
14. Do not touch the heat sink or heat spreader when the system is running
15. Never pour any liquid into the openings. This could cause fire or electric shock.
16. As most electronic components are sensitive to static electrical charge, be sure to ground yourself to prevent static charge when installing the internal components. Use a grounding wrist strap and contain all electronic components in any static-shielded containers.

17. If any of the following situations arises, please the contact our service personnel:
 - i. Damaged power cord or plug
 - ii. Liquid intrusion to the device
 - iii. Exposure to moisture
 - iv. Device is not working as expected or in a manner as described in this manual
 - v. The device is dropped or damaged
 - vi. Any obvious signs of damage displayed on the device
18. **DO NOT LEAVE THIS DEVICE IN AN UNCONTROLLED ENVIRONMENT WHERE THE STORAGE TEMPERATURE IS BELOW -40°C (-40°F) OR ABOVE 85°C (185°F) TO PREVENT DAMAGE.**

Warning!



This device complies with Part 15 FCC Rules. Operation is subject to the following two conditions: (1) this device may not cause harmful interference, and (2) this device must accept any interference received including interference that may cause undesired operation.

Caution:

There is a danger of explosion if the battery is incorrectly replaced. Replace only with the same or equivalent type recommended by the manufacturer. Dispose of used batteries according to the manufacturer's instructions and your local government's recycling or disposal directives.

Attention:

Il y a un risque d'explosion si la batterie est remplacée de façon incorrecte. Ne la remplacer qu'avec le même modèle ou équivalent recommandé par le constructeur. Recycler les batteries usées en accord avec les instructions du fabricant et les directives gouvernementales de recyclage.

China RoHS Requirements (CN)

产品中有毒有害物质或元素名称及含量

AAEON Main Board/ Daughter Board/ Backplane

部件名称	有毒有害物质或元素					
	铅 (Pb)	汞 (Hg)	镉 (Cd)	六价铬 (Cr(VI))	多溴联苯 (PBB)	多溴二苯醚 (PBDE)
印刷电路板 及其电子组件	X	X	○	○	○	○
外部信号 连接器及线材	X	X	○	○	○	○
<p>○: 表示该有毒有害物质在该部件所有均质材料中的含量均在 SJ/T 11363-2006 标准规定的限量要求以下。</p> <p>X: 表示该有毒有害物质至少在该部件的某一均质材料中的含量超出 SJ/T 11363-2006 标准规定的限量要求。</p> <p>备注: 此产品所标示之环保使用期限, 系指在一般正常使用状况下。</p>						

China RoHS Requirement (EN)

Poisonous or Hazardous Substances or Elements in Products

AAEON Main Board/ Daughter Board/ Backplane

Component	Poisonous or Hazardous Substances or Elements					
	Lead (Pb)	Mercury (Hg)	Cadmium (Cd)	Hexavalent Chromium (Cr(VI))	Polybrominated Biphenyls (PBB)	Polybrominated Diphenyl Ethers (PBDE)
PCB & Other Components	X	X	O	O	O	O
Wires & Connectors for External Connections	X	X	O	O	O	O
<p>O: The quantity of poisonous or hazardous substances or elements found in each of the component's parts is below the SJ/T 11363-2006-stipulated requirement.</p> <p>X: The quantity of poisonous or hazardous substances or elements found in at least one of the component's parts is beyond the SJ/T 11363-2006-stipulated requirement.</p> <p>Note: The Environment Friendly Use Period as labeled on this product is applicable under normal usage only</p>						

Table of Contents

Chapter 1 - Product Specifications	1
1.1 Specifications.....	2
1.2 Function Block Diagram.....	5
Chapter 2 – Hardware Information	6
2.1 Dimensions.....	7
2.2 Jumpers and Connectors	8
2.3 List of Jumpers.....	10
2.3.1 LVDS VDD Power Selection (JP5 Pins 1, 3, 5).....	10
2.3.2 LVDS Backlight Power Selection (JP5 Pins 2, 4, 6).....	10
2.3.3 Boot Selection (JP6 Pins 2, 4, 6).....	11
2.4 List of Connectors	12
2.4.1 DC Power (CN1)	13
2.4.2 SPI/I2C/GPIO Connector (CN4)	13
2.4.3 Full-size Mini Card Slot (CN12)	14
2.4.4 Half-size Mini Card Slot (CN13).....	17
2.4.5 RTC Battery Connector (CN14).....	19
2.4.6 Micro SD Slot (CN16)	20
2.4.7 LVDS Port Inverter/Backlight Connector (CN25).....	20
2.4.8 LVDS Connector (CN26)	21
2.4.9 Audio Port (CN27).....	22
2.4.10 Debug Port (CN30).....	23
2.4.11 COM Port 1/Port 2 (RS-232/422/485) (CN70).....	24
2.4.12 COM Port 3 (RS-232/422/485) (CN71).....	26
2.4.13 COM Port 4 (RS-232/422/485) (CN72).....	26
2.4.14 Internal USB 2.0 Port (CN94)	27
2.4.15 HDMI Port (CN141).....	28

- 2.4.16 USB 2.0 Port 1/Port 2 (CN142) 29
- 2.4.17 RJ-45 LAN Port 1/Port 2 (CN145)..... 30
- Chapter 3 - Product Setup and Configuration..... 31**
- 3.1 System Account Management 32
 - 3.1.1 Debug Console 32
 - 3.1.2 Log In..... 37
- 3.2 I/O Control Command and Example 37
 - 3.2.1 CN70: COM 1~COM 6 RS-232/422/485 & CAN FD 1~2..... 37
 - 3.2.2 CAN FD..... 37
 - 3.2.3 COM 1~COM 4 RS-232/422/485 & COM 5-COM 6 TTL 39
 - 3.2.3.1 Mode Setting Table 39
 - 3.2.3.2 Device Name Table 40
 - 3.2.3.3 RTS/CTS Function Table 40
 - 3.2.3.4 COM 1 to COM 2 Using RS-485 Mode (Python) 40
 - 3.2.4 CN71/CN72 RS-232/422/485 41
 - 3.2.5 Audio Settings..... 41
 - 3.2.5.1 Cautions..... 42
 - 3.2.6 Custom Button..... 43
 - 3.2.7 I2C/SPI/GPIO interface (CN4)..... 43
 - 3.2.7.1 CN4 Pin Definition..... 43
 - 3.2.7.2 I2C Command Example 43
 - 3.2.7.3 SPI Command Example..... 44
 - 3.2.7.4 GPIO Command Example (gpio1_16) 44
 - 3.2.8 RTC (External and CPU Internal)..... 44
 - 3.2.8.1 External RTC 44
 - 3.2.8.2 CPU Internal RTC 45
 - 3.2.8.3 System Time 45
 - 3.2.9 TPM (NPCT75x)..... 46

3.2.10	USB0 Host/Device Mode Switch	47
3.2.10.1	USB Hot Mode	47
3.2.10.2	USB Device Mode.....	47
3.2.10.3	USB Storage.....	47
3.2.11	LVDS Panel Enable/Disable	48
3.2.11.1	Enable LVDS Panel.....	48
3.2.11.2	Disable LVDS Panel.....	48
3.2.12	LED Control	48
3.2.13	Watchdog Control (TPS3431SDRBR)	49
3.2.13.1	Feed Dog Example Code.....	49
3.2.13.2	Enable/disable watchdog	49
3.3	Wireless Control Command and Example	50
3.3.1	CN12 4G SIM Card Module (EG25-G).....	50
3.3.2	CN13 Mini Card Bluetooth (WPET-239ACN(BT)).....	51
3.3.3	CN13 Mini Card Wi-Fi (WPET-239ACN(BT))	54
3.3.4	CN12 & CN13 Mini Card Power On/Off Pin Control.....	56
3.3.5	CN12 & CN13 Pin 22 PERST# High/Low Pin Control	56
3.4	OS Installation.....	57
3.4.1	Flash SD Card.....	57
3.4.2	SD Card/EMMC Boot Mode	58
3.4.3	Check OS Version.....	59
Appendix A – Mating Connectors		60
A.1	List of Mating Connectors and Cables	61

Chapter 1

Product Specifications

1.1 Specifications

System

Form Factor	PICO ITX, 2.5" SBC
Processor	Texas Instruments™ AM625/AM623 Sitara™ 64-bit Quad-Core Arm® Cortex® -A53, 1.4 GHz
Memory	Onboard DDR4, up to 4GB
Storage	eMMC 5.1, 16GB (Optional 32GB/64GB/128GB) Micro SD Card x 1
Real Time Clock	RTC x 1
Security	TPM 2.0 (Optional)
Indicator	Programmable LED Control x 3
Cellular	Full-size Mini Card Connector x 1 (USB Signal, power control available by software)
Wireless LAN	Half-size Mini Card Connector x 1 (USB Signal, power control available by software)
Operating System	Debian 12 (Default, GUI is optional) Android™ 14
Support Protocol	—

I/O

Serial Port	RS-232/422/485 x 4 (by Phoenix Connector x 2, Pin Header x 2)
Ethernet	Gigabit Ethernet x 2 (integrated RGMII)
USB	USB 2.0 x 1 Host/Device by Image option, default: Host USB 2.0 Host x 1 USB 2.0 x 1 (Pin Header)
ADC	—

I/O

Audio	Line in/Line Out/Mic (optional)
DI/DO	—
CANBus	CAN 2.0 FD x 2 (Optional)
Display	HDMI 1.4b x 1 18/24-bit Dual-Channel LVDS x 1, up to 1920 x 1080
Power Connector	2-Pin 2.54mm Pitch Phoenix Connector
Debug Port	Micro USB x 1
Expansion	Half-size Mini Card x 1 (USB 2.0) Full-size Mini Card x 1 (USB 2.0) SPI x 4 (optional) I2C x 2 (optional) UART x 2 (optional)
Other	GPIO x 1 I2C x 1 SPI x 1 (CSx2)

Power Supply

Power Requirement	DC 9V ~ 36V (Optional: 12V)
Power Consumption	5.76W (Full Loading)
MTBF	1,279,408 Hours

Environmental

Dimension	3.94" x 2.83" (100mm x 72mm)
Weight	0.18lb (0.083kg)
Mounting	—
Operating Temperature	-40°F ~ 185°F (-40°C ~ 85°C) Optional: 32°F ~ 140°F (0°C ~ 60°C)

Environmental

Storage Temperature	-40°F ~ 185°F (-40°C ~ 85°C)
Operating Humidity	0% ~ 95% relative humidity, non-condensing
Certification	CE/FCC Class A

1.2 Function Block Diagram

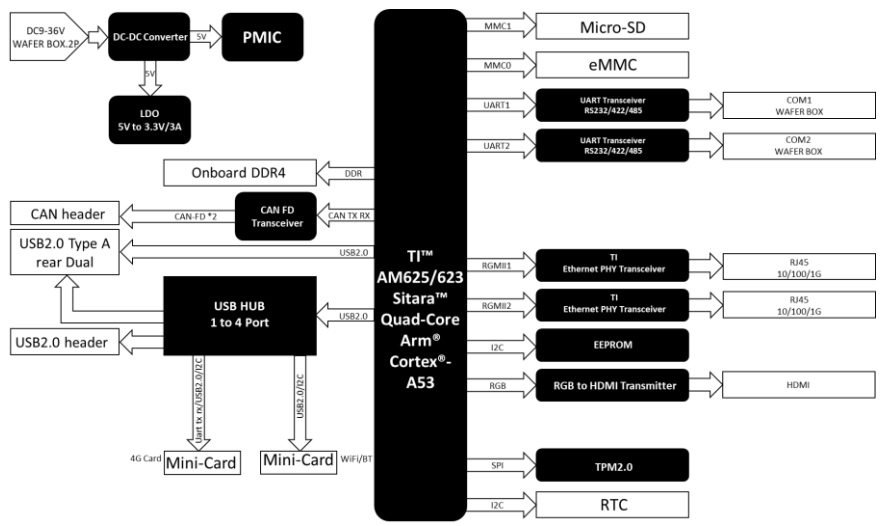

Chapter 2

Hardware Information

2.1 Dimensions

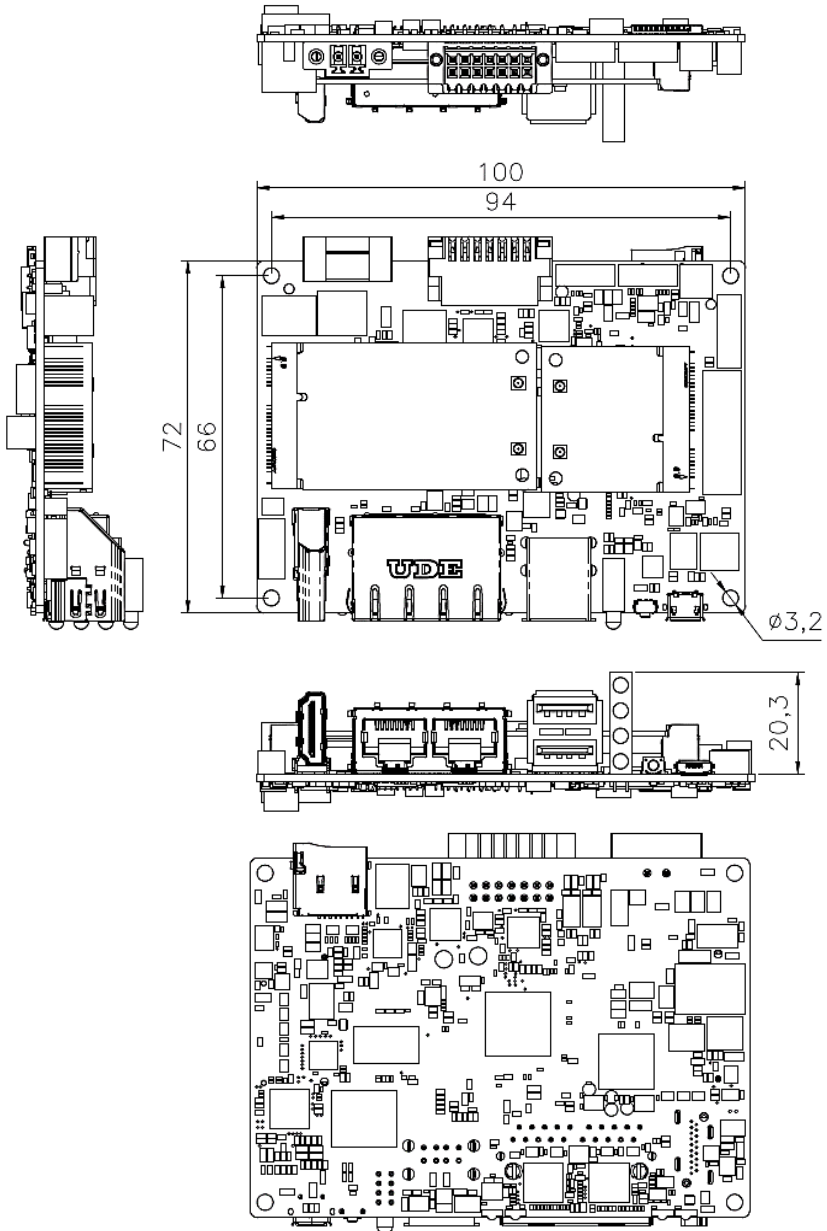

2.2 Jumpers and Connectors

Component Side

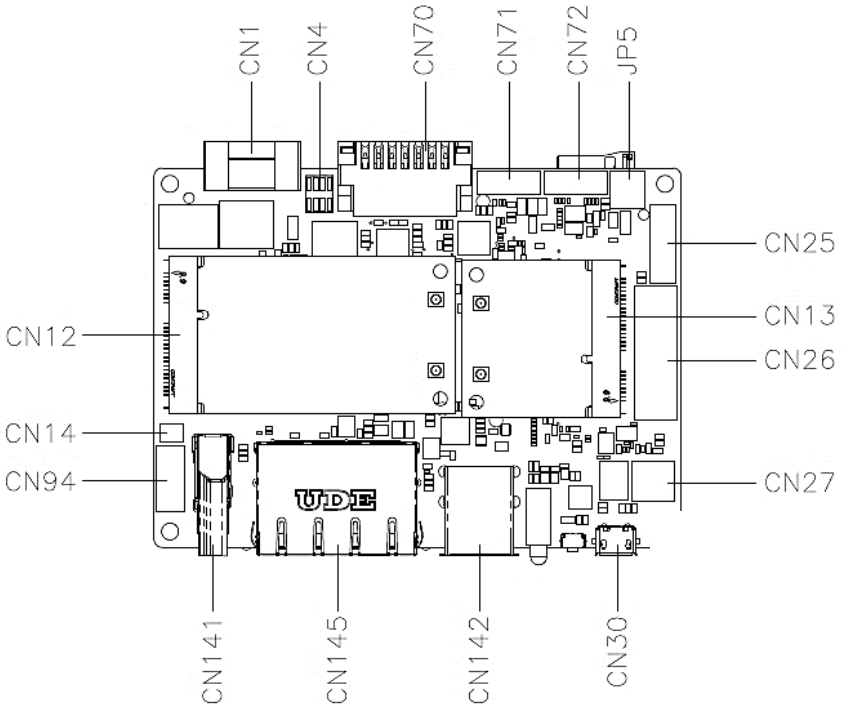

Solder Side

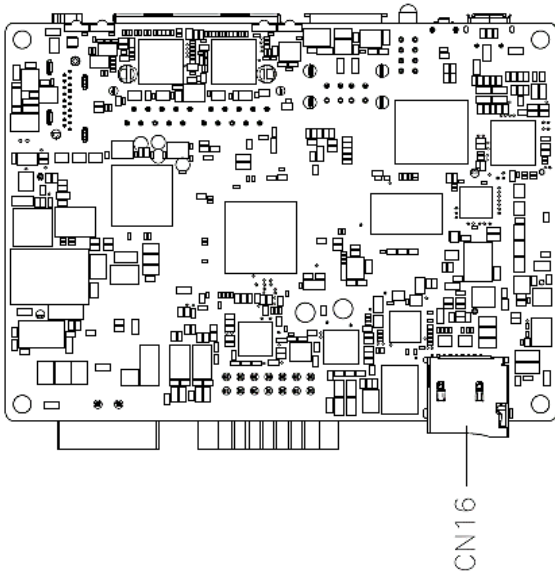

2.3 List of Jumpers

Jumpers allow users to manually customize system configurations to their suitable application needs.

Please refer to the table below for all of the board's jumpers that you can configure for your application

Label	Function
JP5 (Pins 1, 3, 5)	LVDS VDD Power Selection
JP5 (Pins 2, 4, 6)	LVDS Backlight Power Selection
JP6 (Pins 2, 4, 6)	Boot Selection

2.3.1 LVDS VDD Power Selection (JP5 Pins 1, 3, 5)

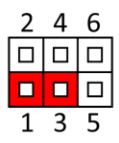

LVDS VDD = 5V

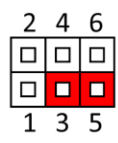

LVDS VDD = 3.3V (Default)

2.3.2 LVDS Backlight Power Selection (JP5 Pins 2, 4, 6)

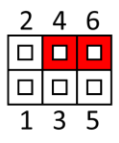

LVDS Backlight = 5V

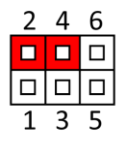

LVDS Backlight = 12V (Default)

Note: To prevent damage to the system or unwanted operation, do not use any other configuration for JP5 than what is shown in Ch2.3.1 and Ch2.3.2

2.3.3 Boot Selection (JP6 Pins 2, 4, 6)

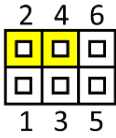

SD Card Mode

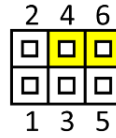

eMMC Mode (Default)

Note: To prevent damage to the system or unwanted operation, do not use any other configuration for JP5 than what is shown in Ch2.3.1 and Ch2.3.2.

2.4 List of Connectors

Please refer to the table below for all of the board's connectors that you can configure for your application

Label	Function
CN1	DC Power
CN4	SPI/I2C/GPIO Connector
CN12	Full-size Mini Card Slot
CN13	Half-size Mini Card Slot
CN14	RTC Battery Connector
CN16	Micro SD Slot
CN25	LVDS Port Inverter/Backlight Connector
CN26	LVDS Connector
CN27	Audio Port
CN30	Debug Port
CN70	COM Port 1/Port 2 (RS-232/422/485)
CN71	COM Port 3 (RS-232/422/485)
CN72	COM Port 4 (RS-232/422/485)
CN94	Internal USB 2.0 Port
CN141	HDMI Port
CN142	USB 2.0 Port 1/Port 2
CN145	RJ-45 LAN Port 1/Port 2

2.4.1 DC Power (CN1)

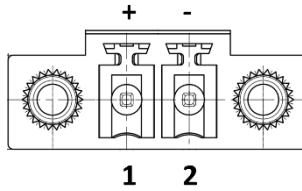

Pin	Pin Name	Signal Type	Signal Level
1	DC_IN	PWR	+9~36V / +12V
2	GND	GND	

Note 1: Wide range input voltage from +9V to +36V or +12V for specified version.

Note 2: Please check the input voltage description on product label before inserting power.

2.4.2 SPI/I2C/GPIO Connector (CN4)

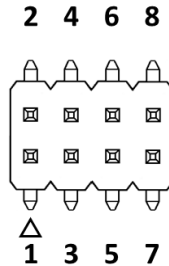

Pin	Pin Name	Signal Type	Signal Level
1	SPI_CLK	I/O	+3.3V
2	SPI_CS1	I/O	+3.3V
3	SPI_D0	I/O	+3.3V
4	I2C_SCL	I/O	+3.3V
5	SPI_D1	I/O	+3.3V
6	I2C_SDA	I/O	+3.3V

Pin	Pin Name	Signal Type	Signal Level
7	SPI0_CS0	I/O	+3.3V
8	GPIO_16	I/O	+3.3V

Note: Pitch = 1.27mm.

2.4.3 Full-size Mini Card Slot (CN12)

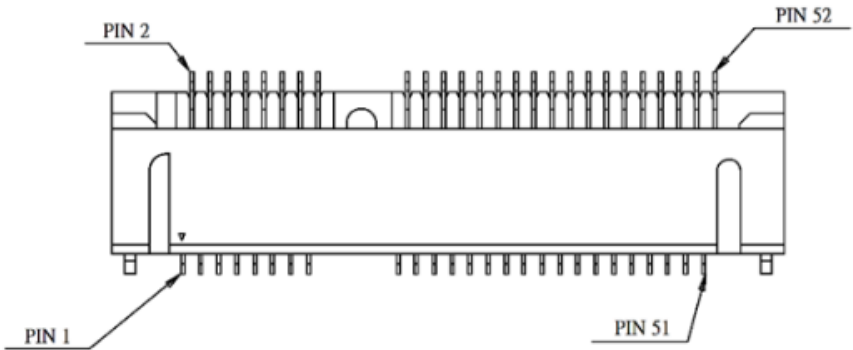

Pin	Pin Name	Signal Type	Signal Level
1	NC		
2	+3.3VSB	PWR	+3.3V
3	NC		
4	GND	GND	
5	NC		
6	NC		
7	NC	NC	
8	NC		
9	GND	GND	
10	NC		
11	NC		
12	NC		
13	NC		

Pin	Pin Name	Signal Type	Signal Level
14	NC		
15	GND	GND	
16	NC		
17	NC		
18	GND	GND	
19	NC		
20	W_DISABLE1# (Note 1)	OUT	+3.3V
21	GND	GND	
22	PERST1#	OUT	+3.3V
23	UART_TX	OUT	+3.3V
24	+3.3VSB	PWR	+3.3V
25	NC		
26	GND	GND	
27	GND	GND	
28	NC		
29	GND	GND	
30	SMB1_CLK (Note 1)	OUT	+3.3V
31	UART_RX	IN	+3.3V
32	SMB1_DATA (Note 1)	I/O	+3.3V
33	NC		
34	GND	GND	
35	GND	GND	
36	USB1_D-	DIFF	
37	GND	GND	
38	USB1_D+	DIFF	
39	+3.3VSB	PWR	+3.3V
40	GND	GND	
41	+3.3VSB	PWR	+3.3V
42	NC		
43	NC		
44	NC		
45	NC		
46	NC		

Pin	Pin Name	Signal Type	Signal Level
47	NC		
48	NC		
49	NC		
50	GND	GND	
51	NC		
52	+3.3VSB	PWR	+3.3V

Note 1: The function is disabled by unmounted 0ohm jumper.

W_DISABLE1#: R3232, SMB1_CLK: R328, SMB1_DATA: R326.

Note 2: The driving current supports up to 2A.

Note 3: For 4G full-size mini card.

2.4.4 Half-size Mini Card Slot (CN13)

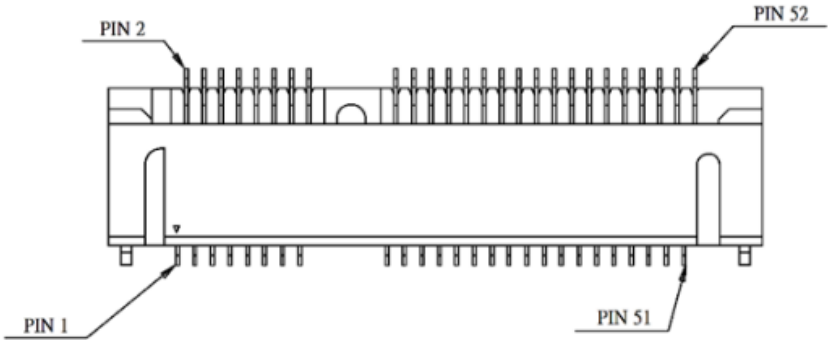

Pin	Pin Name	Signal Type	Signal Level
1	NC		
2	+3.3VSB	PWR	+3.3V
3	NC		
4	GND	GND	
5	NC		
6	NC		
7	NC		
8	NC		
9	GND	GND	
10	NC		
11	NC		
12	NC		
13	NC		
14	NC		
15	GND	GND	
16	NC		
17	NC		
18	GND	GND	
19	NC		
20	W_DISABLE2# (Note 1)	OUT	+3.3V
21	GND	GND	

Pin	Pin Name	Signal Type	Signal Level
22	PERST2#	OUT	+3.3V
23	NC		
24	+3.3VSB	PWR	+3.3V
25	NC		
26	GND	GND	
27	GND	GND	
28	NC		
29	GND	GND	
30	SMB2_CLK (Note 1)	OUT	+3.3V
31	NC		
32	SMB2_DATA (Note 1)	I/O	+3.3V
33	NC		
34	GND	GND	
35	GND	GND	
36	USB2_D-	DIFF	
37	GND	GND	
38	USB2_D+	DIFF	
39	+3.3VSB	PWR	+3.3V
40	GND	GND	
41	+3.3VSB	PWR	+3.3V
42	NC		
43	NC		
44	NC		
45	NC		
46	NC		
47	NC		
48	NC		
49	NC		
50	GND	GND	
51	NC		
52	+3.3VSB	PWR	+3.3V

Note 1: The function is disabled by unmount 0ohm jumper.

W_DISABLE2#: R334, SMB2_CLK: R9237, SMB2_DATA: R9236

Note 2: The driving current supports up to 2A.

Note 3: For WIFI / BT half-size mini card.

2.4.5 RTC Battery Connector (CN14)

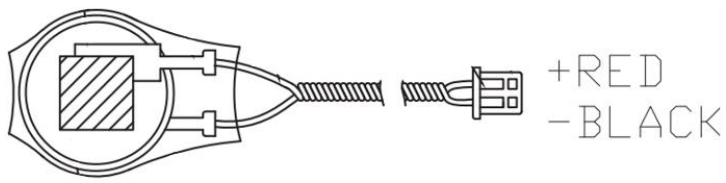
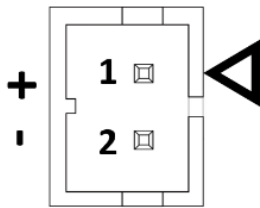

Pin	Pin Name	Signal Type	Signal Level
1	+3.3V	PWR	+3.3V
2	GND	GND	

2.4.6 Micro SD Slot (CN16)



Pin	Pin Name	Signal Type	Signal Level
1	SD_DAT2	I/O	+3.3V
2	SD_DAT3	I/O	+3.3V
3	SD_CMD	OUT	+3.3V
4	SD_VDD	PWR	+3.3V
5	SD_CLK	OUT	+3.3V
6	SD_VSS	GND	
7	SD_DAT0	I/O	+3.3V
8	SD_DAT1	I/O	+3.3V

2.4.7 LVDS Port Inverter/Backlight Connector (CN25)

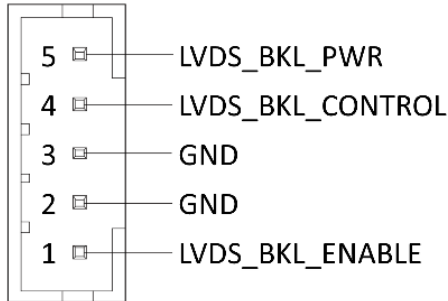

Pin	Pin Name	Signal Type	Signal Level
1	LVDS_BKL_ENABLE	OUT	+3.3V
2	GND	GND	
3	GND	GND	
4	LVDS_BKL_CONTROL	OUT	
5	LVDS_BKL_PWR	PWR	+5V / +12V

Note 1: LVDS/ LVDS_BLK_PWR can be set to +5V or +12V by JP5.

Note 2: The driving current supports up to 2A.

2.4.8 LVDS Connector (CN26)

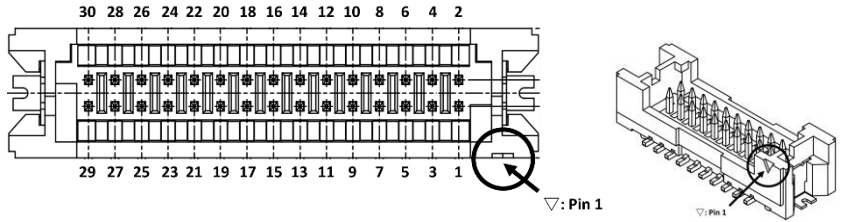

Pin	Pin Name	Signal Type	Signal Level
1	LVDS_BLK_ENABLE	OUT	
2	LVDS_BKL_CONTROL	OUT	
3	LVDS_VDD	PWR	+3.3V / +5V
4	GND	GND	
5	LVDS_A_CLK-	DIFF	
6	LVDS_A_CLK+	DIFF	
7	LVDS_VDD	PWR	+3.3V / +5V
8	GND	GND	
9	LVDS_DA0-	DIFF	
10	LVDS_DA0+	DIFF	
11	LVDS_DA1-	DIFF	
12	LVDS_DA1+	DIFF	
13	LVDS_DA2-	DIFF	
14	LVDS_DA2+	DIFF	
15	LVDS_DA3-	DIFF	
16	LVDS_DA3+	DIFF	
17	DDC_DATA	I/O	+3.3V
18	DDC_CLK	I/O	+3.3V
19	LVDS_DB0-	DIFF	

Pin	Pin Name	Signal Type	Signal Level
20	LVDS_DB0+	DIFF	
21	LVDS_DB1-	DIFF	
22	LVDS_DB1+	DIFF	
23	LVDS_DB2-	DIFF	
24	LVDS_DB2+	DIFF	
25	LVDS_DB3-	DIFF	
26	LVDS_DB3+	DIFF	
27	LVDS_VDD	PWR	+3.3V / +5V
28	GND	GND	
29	LVDS_B_CLK-	DIFF	
30	LVDS_B_CLK+	DIFF	

Note 1: LVDS/ LVDS_VDD can be set to +3.3V or +5V by JP5.

Note 2: The driving current supports up to 2A.

2.4.9 Audio Port (CN27)

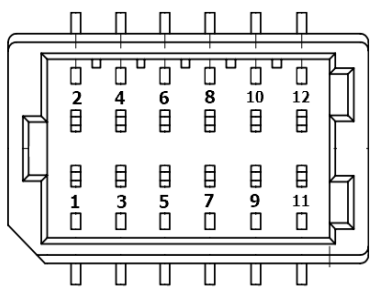

Pin	Pin Name	Signal Type	Signal Level
1	LINE_R_OUT	OUT	+3.3V
2	MIC_R	IN	+3.3V
3	LINE_L_OUT	OUT	+3.3V
4	MIC_L	IN	+3.3V
5	NC		
6	NC		

Pin	Pin Name	Signal Type	Signal Level
7	GND_AUDIO	GND	
8	GND_AUDIO	GND	
9	NC		
10	LINE_R_IN	IN	+3.3V
11	+VDD_AUDIO	PWR	+3.3V
12	LINE_L_IN	IN	+3.3V

2.4.10 Debug Port (CN30)

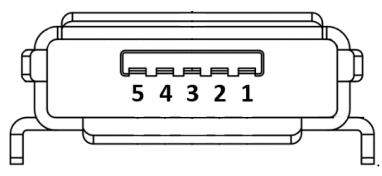

Pin	Pin Name	Signal Type	Signal Level
1	+5VSB	PWR	5V
2	USB0_DN	DIFF	
3	USB0_DP	DIFF	
4	USB0_ID	IN	3.3V
5	GND	GND	

Note: USB to UART (XR21V1410) debug port.

2.4.11 COM Port 1/Port 2 (RS-232/422/485) (CN70)

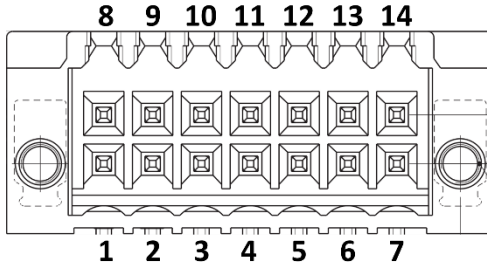

Pin	Pin Name	Signal Type	Signal Level
1	TX1	OUT	±9V / ±5V
2	RX1	IN	±9V / ±5V
3	DCD1	IN	±9V / ±5V
4	DTR1	OUT	±9V / ±5V
5	GND	GND	
6	CAN1_H / RST1	DIFF / OUT	DIFF / ±9V / ±5V
7	CAN1_L / CTS1	DIFF / IN	DIFF / ±9V / ±5V
8	TX2	OUT	±9V / ±5V
9	RX2	IN	±9V / ±5V
10	DCD2	IN	±9V / ±5V
11	DTR2	OUT	±9V / ±5V
12	GND	GND	
13	CAN2_H / RTS2	DIFF / OUT	DIFF / ±9V / ±5V
14	CAN2_L / CTS2	DIFF / IN	DIFF / ±9V / ±5V

COM Port 1 RS-422

Pin	Pin Name	Signal Type	Signal Level
5	GND	GND	
3	RS422_TX-	OUT	±9V / ±5V
2	RS422_TX+	OUT	±9V / ±5V
1	RS422_RX+	IN	±9V / ±5V
4	RS422_RX-	IN	±9V / ±5V

COM Port 1 RS-485			
Pin	Pin Name	Signal Type	Signal Level
5	GND	GND	
3	RS485_D-	I/O	$\pm 9V / \pm 5V$
2	RS485_D+	I/O	$\pm 9V / \pm 5V$

COM Port 2 RS-422			
Pin	Pin Name	Signal Type	Signal Level
12	GND	GND	
10	RS422_TX-	OUT	$\pm 9V / \pm 5V$
9	RS422_TX+	OUT	$\pm 9V / \pm 5V$
8	RS422_RX+	IN	$\pm 9V / \pm 5V$
11	RS422_RX-	IN	$\pm 9V / \pm 5V$

COM Port 2 RS-485			
Pin	Pin Name	Signal Type	Signal Level
12	GND	GND	
10	RS485_D-	I/O	$\pm 9V / \pm 5V$
9	RS485_D+	I/O	$\pm 9V / \pm 5V$

Note 1: COM1/ 2 RS-232/422/485 can be set by setting and the default is RS-232.

Note 2: Set signal level $\pm 9V / \pm 5V$ by PSP5 / PSP6 short.

Note 3: The function can be set by mounting 0ohm jumper.

CAN1_H (default): R9330 / RST1: R9329, CAN1_L(default): R9332 / CTS1: R9331,

CAN2_H(default): R9333 / RTS2: R9334, CAN2_L(default): R9335 / CTS2: R9336.

2.4.12 COM Port 3 (RS-232/422/485) (CN71)

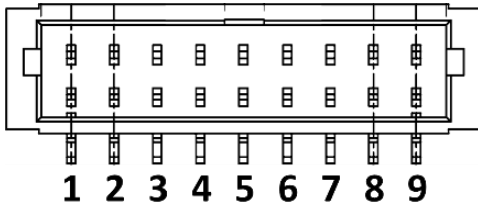

Pin	Pin Name	Signal Type	Signal Level
1	DCD3	IN	±9V / ±5V
2	RX3	IN	±9V / ±5V
3	TX3	OUT	±9V / ±5V
4	DTR3	OUT	±9V / ±5V
5	GND	GND	
6	DSR3	IN	±9V / ±5V
7	RTS3	OUT	±9V / ±5V
8	CTS3	IN	±9V / ±5V
9	RI3	IN	±9V / ±5V

2.4.13 COM Port 4 (RS-232/422/485) (CN72)

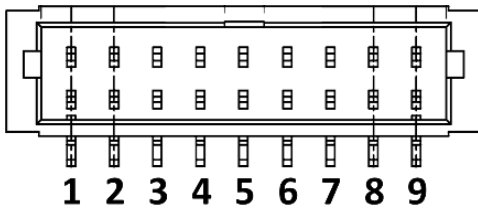

Pin	Pin Name	Signal Type	Signal Level
1	DCD4	IN	±9V / ±5V
2	RX4	IN	±9V / ±5V
3	TX4	OUT	±9V / ±5V
4	DTR4	OUT	±9V / ±5V

Pin	Pin Name	Signal Type	Signal Level
5	GND	DGND	
6	DSR4	IN	±9V / ±5V
7	RTS4	OUT	±9V / ±5V
8	CTS4	IN	±9V / ±5V
9	RI4	IN	±9V / ±5V

2.4.14 Internal USB 2.0 Port (CN94)

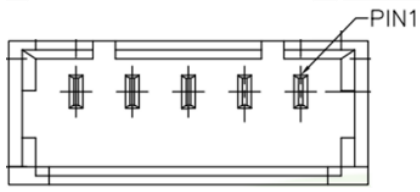

Pin	Pin Name	Signal Type	Signal Level
1	+5VSB	PWR	+5V
2	USB3_DN	DIFF	
3	USB3_DP	DIFF	
4	GND	GND	
5	GND	GND	

Note: The driving current supports up to 2A..

2.4.15 HDMI Port (CN141)

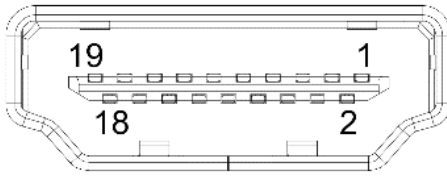

Pin	Pin Name	Signal Type	Signal Level
1	HDMI_TX2+	DIFF	
2	GND	GND	
3	HDMI_TX2-	DIFF	
4	HDMI_TX1+	DIFF	
5	GND	GND	
6	HDMI_TX1-	DIFF	
7	HDMI_TX0+	DIFF	
8	GND	GND	
9	HDMI_TX0-	DIFF	
10	HDMI_CLK+	DIFF	
11	GND	GND	
12	HDMI_CLK-	DIFF	
13	HDMI_CEC	OUT	+3.3V
14	HDMI_Utility	OUT	+1.8V
15	DDC_CLK	I/O	+5V
16	DDC_DATA	I/O	+5V
17	GND	GND	
18	+V5S	PWR	+5V
19	HDMI_HPD	OUT	+1.8V

2.4.16 USB 2.0 Port 1/Port 2 (CN142)

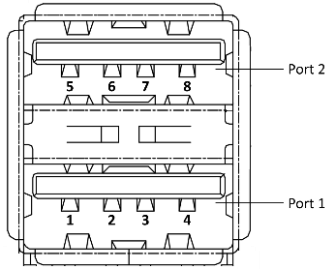

Pin	Pin Name	Signal Type	Signal Level
1	+5VSB	PWR	+5V
2	USB1_DN	DIFF	
3	USB1_DP	DIFF	
4	GND	GND	
5	+5VSB	PWR	+5V
6	USB2_DN	DIFF	
7	USB2_DP	DIFF	
8	GND	GND	

Note 1: The driving current supports up to 2A.

2.4.17 RJ-45 LAN Port 1/Port 2 (CN145)

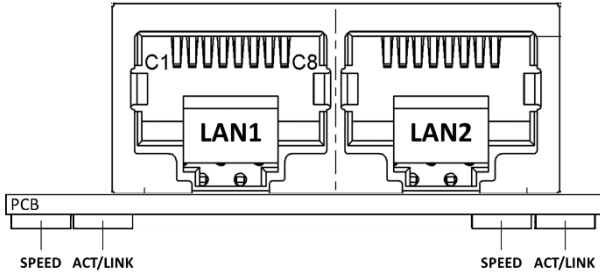

Pin	Pin Name	Signal Type	Signal Level
L_1	LAN1_MDI0_P	DIFF	
L_2	LAN1_MDI0_N	DIFF	
L_3	LAN1_MDI1_P	DIFF	
L_4	LAN1_MDI1_N	DIFF	
L_5	GND	GND	
L_6	GND	GND	
L_7	LAN1_MDI2_P	DIFF	
L_8	LAN1_MDI2_N	DIFF	
L_9	LAN1_MDI3_P	DIFF	
L_10	LAN1_MDI3_N	DIFF	
R_1	LAN2_MDI0_P	DIFF	
R_2	LAN2_MDI0_N	DIFF	
R_3	LAN2_MDI1_P	DIFF	
R_4	LAN2_MDI1_N	DIFF	
R_5	GND	GND	
R_6	GND	GND	
R_7	LAN2_MDI2_P	DIFF	
R_8	LAN2_MDI2_N	DIFF	
R_9	LAN2_MDI3_P	DIFF	
R_10	LAN2_MDI3_N	DIFF	

Note: External ACTIVE/LINK & SPEED LEDs.

Chapter 3

Product Setup and Configuration

3.1 System Account Management

3.1.1 Debug Console

When connecting a PC or laptop to the SRG/PICO-AM62, using PuTTY with Windows 10 is recommended. Users can download the software from the PuTTY website:

Step 1: Download the PuTTY tools: <https://www.putty.org/>.

Step 2: Set jumper (JP5) to 3-5 2-6 (default settings).

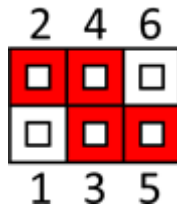

Step 3: Set jumper (JP6) to 4-6 (default settings).

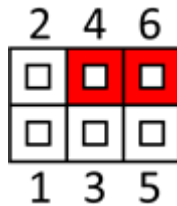

Step 4: Use micro USB(CN30) connect debug port and your computer.

Step 5: Power On (CN1).

Step 6: Download xr21v1410 windows driver:

<https://www.maxlinear.com/product/interface/uarts/usb-uarts/xr21v1410>

XR21V1410		ACTIVE					Order Now
Overview	Documentation & Design Tools	Quality & RoHS	Parts & Purchasing	Packaging	Notifications	FAQs & Support	Videos
Software: GUIs & Utilities	Android Application				1C	November 2015	476.6 KB
Software: GUIs & Utilities	XR21V141x Linux EEPROM Programming Utility				2.0.0	April 2013	2.2 KB
Software: GUIs & Utilities	XR21V141x Windows EEPROM Programming Utility				1.0.0.7A	December 2012	963.9 KB
Product Flyers	Full-Speed USB UART Family				1.1	November 2020	605.3 KB
Product Brochures	Interface Brochure					November 2023	3.7 MB
Software: Drivers	Windows 10 and newer				2.7.0.0	January 2023	169.2 KB
Software: Drivers	Linux 3.6.x and Newer				1D	September 2021	29.9 KB
Software: Drivers	Windows 7, 8				2.6.0.0	December 2019	145.7 KB
Software: Drivers	XRUSB1 for Win XP SP3 and newer				2.2.5.0	March 2016	1 MB
Software: Drivers	Linux 2.6.18 to 3.4.x				1A	January 2015	19.1 KB
Software: Drivers	Mac				1.0.4	October 2013	171.3 KB
Schematics & Design Files	XR21V1410H_0C/ER_Evaluation_Board_Schematics_&_Design_Files					December 2020	409.8 KB

Step 7: Open Device Manager and install xr21v1410 driver.

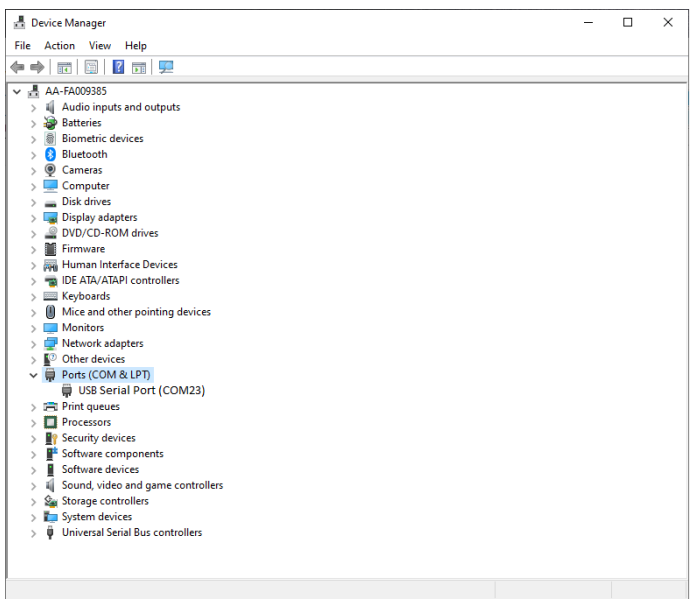

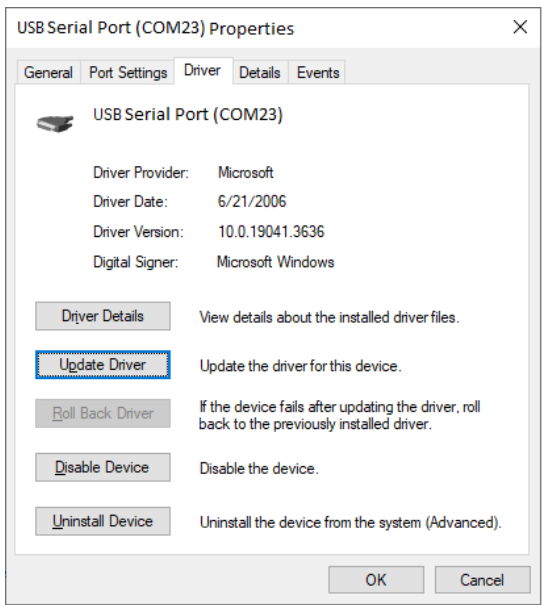

×

← Update Drivers - USB Serial Port (COM23)

How do you want to search for drivers?

→ Search automatically for drivers
Windows will search your computer for the best available driver and install it on your device.

→ Browse my computer for drivers
Locate and install a driver manually.

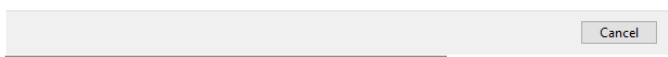

Update Drivers - USB Serial Port (COM23)

Browse for drivers on your computer

Search for drivers in this location:

PICO\Debug_driver\xr21x_win10_v2.7.0.0\XR21_Win10_V2.7.0.0\x64

Include subfolders

Let me pick from a list of available drivers on my computer
This list will show available drivers compatible with the device, and all drivers in the same category as the device.

Next Cancel

Close

Update Drivers - XR21V1410 USB UART (COM23)

Windows has successfully updated your drivers

Windows has finished installing the drivers for this device:

XR21V1410 USB UART

Close

Step 8: Reboot your Windows PC and check COM port name.

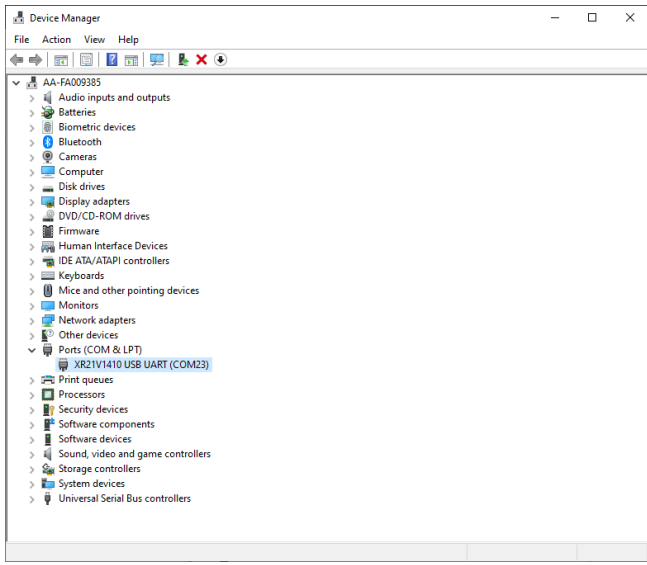

Step 9: Open PuTTY on pc and set COM port info

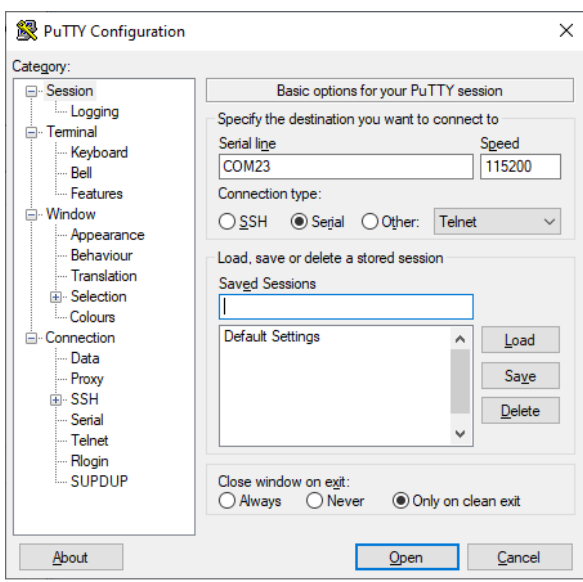

3.1.2 Log In

Log into the system using the below credentials.

Login Settings	
Username	root
Password	Pw#12345

3.2 I/O Control Command and Example

3.2.1 CN70: COM 1~COM 6 RS-232/422/485 & CAN FD 1~2

Please refer to section 2.4.11 COM Port 1/Port 2 (RS 232/422/485) (CN70).

3.2.2 CAN FD

Set GPIO pins:

```
gpioset 1 13=0
```

```
gpioset 1 14=0
```

Configure and bring up can0:

```
ip link set can0 down
```

```
ip link set can0 type can bitrate 1000000
```

```
ip link set can0 up
```

Configure and bring up can1

```
ip link set can1 down
```

```
ip link set can1 type can bitrate 1000000
```

```
ip link set can1 up
```

Start dumping can1

```
candump can1 &
```

Send CAN message from can0

```
cansend can0 111#1122334455667788
```

Result:

```
COM8 - PuTTY
root@am62xx:~# gpio set 1 13=0
root@am62xx:~# gpio set 1 14=0
root@am62xx:~# ip link set can0 down
root@am62xx:~# ip link set can0 type can bitrate 1000000
root@am62xx:~# ip link set can0 up
[ 55.292815] IPv6: ADDRCONF(NETDEV_CHANGE): can0: link becomes ready
root@am62xx:~# ip link set can1 down
root@am62xx:~# ip link set can1 type can bitrate 1000000
root@am62xx:~# ip link set can1 up
[ 63.969710] IPv6: ADDRCONF(NETDEV_CHANGE): can1: link becomes ready
root@am62xx:~# candump can1 &
[1] 798
root@am62xx:~# [ 67.241848] can: controller area network core
[ 67.246438] NET: Registered PF_CAN protocol family
[ 67.476330] can: raw protocol

root@am62xx:~# cansend can0 111#1122334455667788
can1 111 [8] 11 22 33 44 55 66 77 88
root@am62xx:~# █
```

3.2.3 COM 1~COM 4 RS-232/422/485 & COM 5-COM 6 TTL

3.2.3.1 Mode Setting Table

For COM 1 ~ COM 4 to work on F81439 (TTL to RS-232/422/485 transceiver), it must be set as follows:

gpio high/low to switch signal modes.

	RS232	RS422	RS485 no termination resistor tx enable(rts) high active	RS485 termination resistor tx enable(rts) low active
Mode Pin 1	0	0	0	1
Mode Pin 2	0	0	1	1
Mode Pin 3	1	0	0	0

	COM 1	COM 2	COM 3	COM 4
Mode Pin 1	gpioset 1 43=0/1	gpioset 1 38=0/1	gpioset 0 23=0/1	gpioset 2 22=0/1
Mode Pin 2	gpioset 1 41=0/1	gpioset 1 40=0/1	gpioset 1 33=0/1	gpioset 2 30=0/1
Mode Pin 3	gpioset 1 42=0/1	gpioset 1 36=0/1	gpioset 1 39=0/1	gpioset 2 49=0/1

Command example to switch COM 1 and COM 2's mode to RS-485 mode:

```
root@am62xx:~# gpioset 1 43=0
root@am62xx:~# gpioset 1 41=1
root@am62xx:~# gpioset 1 42=1
root@am62xx:~# gpioset 1 38=0
root@am62xx:~# gpioset 1 40=1
root@am62xx:~# gpioset 1 36=1
root@am62xx:~#
```

3.2.3.2 Device Name Table

COM 1	COM 2	COM 3	COM 4	COM 5	COM 6
/dev/ttyS3	/dev/ttyS7	/dev/ttyS1	/dev/ttyS0	/dev/ttyS6	/dev/ttyS8

3.2.3.3 RTS/CTS Function Table

	RS-232	RS-422	RS-485
RTS Pin	Option	/	Low receiver High sender -> Need
CTS Pin	Option	/	/

3.2.3.4 COM 1 to COM 2 Using RS-485 Mode (Python)

Command:

```
python3
import serial
comA = serial.Serial("/dev/ttyS3", 115200, timeout=1)
comB = serial.Serial("/dev/ttyS7", 115200, timeout=1)
comA.setRTS(0) # sender
comB.setRTS(1) # receiver
data_len = comA.write(b'test string')
data = comB.read(data_len)
print(data)
comA.close()
comB.close()
```

```
root@am62xx:~# python3
Python 3.11.2 (main, Mar 13 2023, 12:18:29) [GCC 12.2.0] on linux
Type "help", "copyright", "credits" or "license" for more information.
>>> import serial
>>> comA = serial.Serial("/dev/ttyS3", 115200, timeout=1)
>>> comB = serial.Serial("/dev/ttyS7", 115200, timeout=1)
>>> comA.setRTS(0)
>>> comB.setRTS(1)
>>> data_len = comA.write(b'test string')
>>> data = comB.read(data_len)
>>> print(data)
b'test string'
>>> comA.close()
>>> comB.close()
>>> █
```

3.2.4 CN71/CN72 RS-232/422/485

	Pin 1	Pin 2	Pin 3	Pin 4	Pin 5	Pin 6	Pin 7	Pin 8	Pin 9
CN71 (COM3)	DCD	RXDR	TXD	DTR	GND	DSR	RTS	CTS	RI
CN72 (COM4)	DCD	RXDR	TXD	DTR	GND	DSR	RTS	CTS	RI

CN71/CN72 corresponds to COM 3 and COM 4, both use F81439. Please refer to the information in Chapter 3.2.3 for usage.

3.2.5 Audio Settings

Step 1: Open PulseAudio Volume Control app.



Step 2: To switch the output to CN27 Audio or HDMI Audio, use the list on the right side of the music playback item.

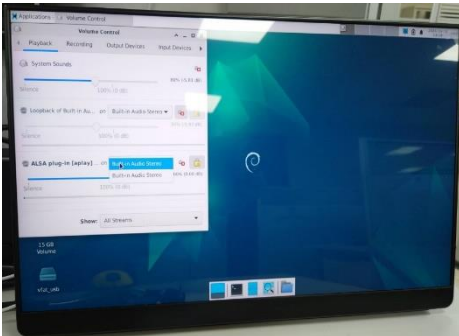

The audio loopback function On/Off button allows you to loopback line in/mic in to line out.

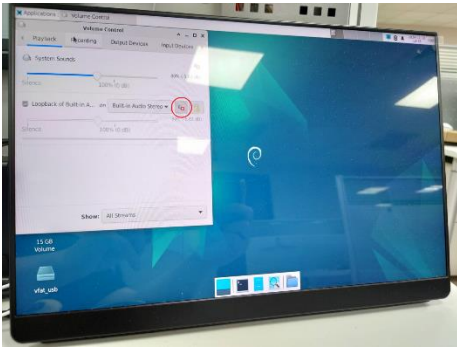

3.2.5.1 Cautions

You must initialize the graphics at boot time if you want to use the GUI interface software.

If you connect the AM62 platform to the screen using an HDMI cable after it has already booted, you will have missed the initialization opportunity, and you won't see any GUI on the screen.

If using GUI software, please follow these steps:

Step 1: Use an HDMI cable to connect the AM62 platform to the screen.

Step 2: Turn on the power.

Step 3: After waiting for some time, you will see the GUI on the screen.

3.2.6 Custom Button

Default function: Press SW2 for 5 seconds and the machine will reboot. You can edit the following script file to modify the functionality of this button.

```
/usr/sbin/sw_gpio.sh
```



3.2.7 I2C/SPI/GPIO interface (CN4)

3.2.7.1 CN4 Pin Definition

Please refer to section 2.4.2 SPI/I2C/GPIO Connector (CN4).

3.2.7.2 I2C Command Example

Please check the I2C device slave address on the bus (0x68).

Command:

```
i2cdetect -y -r 2
```

```
root@AM62:~# i2cdetect -r -y 2
   0  1  2  3  4  5  6  7  8  9  a  b  c  d  e  f
00: -- -- -- -- -- -- -- -- -- -- -- -- -- -- --
10: -- -- -- -- -- -- -- -- -- -- -- -- -- -- --
20: -- -- -- -- -- -- -- -- -- -- -- -- -- -- --
30: -- -- -- -- -- -- -- -- -- -- -- -- -- -- --
40: -- -- -- -- -- -- -- -- -- -- -- -- -- -- --
50: -- -- -- -- -- -- -- 57 -- -- -- -- -- -- --
60: -- -- -- -- -- -- -- 68 -- -- -- -- -- -- --
70: -- -- -- -- -- -- -- -- -- -- -- -- -- -- --
root@AM62:~# █
```

3.2.7.3 SPI Command Example

Please make sure to use version S-pipe - 1.0.2 to support switching SPI mode.

```
root@AM62:~# spi-pipe -v
spi-pipe - 1.0.2
Copyright (c) 2014-2021 Christophe Blaess. (license GPLv2)
This is free software. You are free to change and redistribute it.
There is NO WARRANTY, to the extent permitted by law.
```

Send `\x90\x00\x00\x00\xff\xff` to the SPI device with CS0.

Command:

```
printf '\x90\x00\x00\x00\xff\xff' | spi-pipe -d /dev/spidev1.0 -s
24000000 -b 6 -n 1 |hexdump -C
```

3.2.7.4 GPIO Command Example (gpio1_16)

Command:

```
gpiowrite 2 16=1 #high 3.3V
gpiowrite 2 16=0 #low 0V
```

3.2.8 RTC (External and CPU Internal)

3.2.8.1 External RTC

Command:

```
hwclock -f /dev/rtc0
```

Result:

```
root@AM62:~# hwclock -f /dev/rtc0
2024-06-12 13:36:54.674315+08:00
```

3.2.8.2 CPU Internal RTC

Command:

```
hwclock -f /dev/rtc1
```

Result:

```
root@AM62:~# hwclock -f /dev/rtc1
2024-06-12 13:38:44.687275+08:00
```

3.2.8.3 System Time

Command:

```
date
```

Result:

```
root@AM62:~# date
Wed Jun 12 13:41:23 CST 2024
```

3.2.9 TPM (NPCT75x)

Command:

```
tpm2_selftest
tpm2_getcap properties-fixed
```

Result:

```
COM8 - PuTTY
root@am62xx:~# tpm2_selftest
root@am62xx:~# tpm2_getcap properties-fixed
TPM2_PT_FAMILY_INDICATOR:
  raw: 0x322E3000
  value: "2.0"
TPM2_PT_LEVEL:
  raw: 0
TPM2_PT_REVISION:
  raw: 0x9A
  value: 1.38
TPM2_PT_DAY_OF_YEAR:
  raw: 0x12F
TPM2_PT_YEAR:
  raw: 0x7E3
TPM2_PT_MANUFACTURER:
  raw: 0x4E544300
  value: "NFC"
TPM2_PT_VENDOR_STRING_1:
  raw: 0x4E544354
  value: "NPCT"
TPM2_PT_VENDOR_STRING_2:
  raw: 0x37357800
  value: "75x"
TPM2_PT_VENDOR_STRING_3:
  raw: 0x2212134
  value: "114"
TPM2_PT_VENDOR_STRING_4:
  raw: 0x726C7300
  value: "r1s"
TPM2_PT_VENDOR_TPM_TYPE:
  raw: 0x0
TPM2_PT_FIRMWARE_VERSION_1:
  raw: 0x70002
TPM2_PT_FIRMWARE_VERSION_2:
  raw: 0x20000
TPM2_PT_INPUT_BUFFER:
  raw: 0x400
TPM2_PT_HR_TRANSIENT_MIN:
  raw: 0x5
TPM2_PT_HR_PERSISTENT_MIN:
  raw: 0x7
TPM2_PT_HR_LOADED_MIN:
  raw: 0x5
TPM2_PT_ACTIVE_SESSIONS_MAX:
  raw: 0x40
TPM2_PT_PCR_COUNT:
  raw: 0x18
TPM2_PT_PCR_SELECT_MIN:
  raw: 0x3
TPM2_PT_CONTEXT_GAP_MAX:
  raw: 0xFF
TPM2_PT_NV_COUNTERS_MAX:
  raw: 0x0
TPM2_PT_NV_INDEX_MAX:
  raw: 0x800
TPM2_PT_MEMORY:
  raw: 0x5
TPM2_PT_CHECK_UPDATE:
  raw: 0x400000
TPM2_PT_CONTEXT_HASH:
  raw: 0xC
TPM2_PT_CONTEXT_SYM:
  raw: 0x5
TPM2_PT_CONTEXT_SYM_SIZE:
  raw: 0x100
TPM2_PT_ORDERLY_COUNT:
  raw: 0xFF
TPM2_PT_MAX_COMMAND_SIZE:
  raw: 0x8000
TPM2_PT_MAX_RESPONSE_SIZE:
  raw: 0x8000
TPM2_PT_MAX_DIGEST:
```

```
raw: 0x30
TPM2_PT_MAX_OBJECT_CONTEXT:
  raw: 0x714
TPM2_PT_MAX_SESSION_CONTEXT:
  raw: 0x148
TPM2_PT_PS_FAMILY_INDICATOR:
  raw: 0x1
TPM2_PT_PS_LEVEL:
  raw: 0x0
TPM2_PT_PS_REVISION:
  raw: 0x104
TPM2_PT_PS_DAY_OF_YEAR:
  raw: 0x0
TPM2_PT_PS_YEAR:
  raw: 0x0
TPM2_PT_SPLIT_MAX:
  raw: 0x80
TPM2_PT_TOTAL_COMMANDS:
  raw: 0x71
TPM2_PT_LIBRARY_COMMANDS:
  raw: 0x68
TPM2_PT_VENDOR_COMMANDS:
  raw: 0x9
TPM2_PT_NV_BUFFER_MAX:
  raw: 0x400
TPM2_PT_MODES:
  raw: 0x1
  value: TPMA_MODES_FIPS_140_2
root@am62xx:~#
```

3.2.10 USB0 Host/Device Mode Switch

3.2.10.1 USB Hot Mode

Command:

```
set_usb0_host_mode.sh
reboot
```

3.2.10.2 USB Device Mode

Command:

```
set_usb0_device_mode.sh
reboot
```

3.2.10.3 USB Storage

Allow the target storage device to be a USB storage device on the host PC.

Command:

```
modprobe g_mass_storage file=/dev/mmcblk0
#connet USB0 to the host PC USB port
```

Result:

(PICO-AM62)

```
root@am62xx:~# modprobe g_mass_storage file=/dev/mmcblk0
[ 47.660875] Mass Storage Function, version: 2009/09/11
[ 47.667655] LUN: removable file: (no medium)
[ 47.672459] LUN: file: /dev/mmcblk0
[ 47.676185] Number of LUNs=1
[ 47.679432] g_mass_storage gadget.0: Mass Storage Gadget, version: 2009/09/11
[ 47.686585] g_mass_storage gadget.0: userspace failed to provide iSerialNumber
[ 47.693837] g_mass_storage gadget.0: g_mass_storage ready
root@am62xx:~# █
```

(Host PC)

```
andrew@andrew-GENESYS-CML5:~$ lsblk
NAME        MAJ:MIN RM   SIZE RO TYPE MOUNTPOINT
sdd         8:48  0 29.1G  0 disk
└─sdd1      8:49  0 300M  0 part /media/andrew/8DF9-290B
└─sdd2      8:50  0 28.8G  0 part /media/andrew/leb0aab7-72b8-47e8-a241-39619222b168
andrew@andrew-GENESYS-CML5:~$ █
```

3.2.11 LVDS Panel Enable/Disable

3.2.11.1 Enable LVDS Panel

Command:

```
set_lvds_to_156_inches_panel.sh
reboot
```

Result:

```
root@AM62:~# set_lvds_disable.sh
[ 708.946649] FAT-fs (mmcblk0p1): Volume was not properly unmounted. Some data may be corrupt. Please run fsck.
Please power off and connect the correct LVDS screen.
root@AM62:~# reboot
root@AM62:~#
```

3.2.11.2 Disable LVDS Panel

Command:

```
set_lvds_disable.sh
reboot
```

Result:

```
root@AM62:~# set_lvds_to_156_inches_panel.sh
[ 697.733243] FAT-fs (mmcblk0p1): Volume was not properly unmounted. Some data may be corrupt. Please run fsck.
Please power off and connect the correct LVDS screen.
root@AM62:~# reboot
root@AM62:~#
```

3.2.12 LED Control



LED	Command
LED1	Power
LED2	gpioset 1 3=1/0
LED3	gpioset 1 4=1/0
LED4	gpioset 1 5=1/0

3.2.13 Watchdog Control (TPS3431SDRBR)

3.2.13.1 Feed Dog Example Code

This code runs automatically at boot. If the dog is not fed within 77 seconds, the product will reset.

Code path: `/usr/sbin/hw_wdt_gpio.sh`

```
#!/bin/bash

gpioset 600000.gpio 44=0
count=1
while true
do
    date=`date`
    gpioset 600000.gpio 44=1
    sleep 0.1
    gpioset 600000.gpio 44=0

    count=$((count+1))
    sleep 4.0
done
```

3.2.13.2 Enable/disable watchdog

Enable	Disable (Default)
<code>gpioset 0 19=1</code>	<code>gpioset 0 19=0</code>

3.3 Wireless Control Command and Example

3.3.1 CN12 4G SIM Card Module (EG25-G)

Power on Mini Card (default: on)

Command:

```
gpioset 2 25=0
```

Result:

```
root@am62xx:~# gpioset 2 25=0
root@am62xx:~# | 44.023611| usb 2-1.2: new high-speed USB device number 4 using xhci-hcd
[ 44.301375] Bluetooth: Core ver 2.22
[ 44.310366] NET: Registered PF_BLUETOOTH protocol family
[ 44.314004] cfg80211: Loading compiled-in X.509 certificates for regulatory database
[ 44.320975] Bluetooth: HCI device and connection manager initialized
[ 44.330734] Bluetooth: HCI socket layer initialized
[ 44.335796] Bluetooth: L2CAP socket layer initialized
[ 44.341016] Bluetooth: SCO socket layer initialized
[ 44.364933] cfg80211: Loaded X.509 cert 'sforshee: 00b28ddf47aef9cea7'
[ 44.376745] cfg80211: loaded regulatory.db is malformed or signature is missing/invalid
[ 44.389206] usbcore: registered new interface driver btusb
[ 44.414002] Bluetooth: hci0: RTL: examining hci_ver=0a hci_rev=000c lmp_ver=0a lmp_subver=8822
[ 44.424909] Bluetooth: hci0: RTL: rom version status=0 version=3
[ 44.431091] Bluetooth: hci0: RTL: loading rtl_bt/rtl8822cu_fw.bin
[ 44.456563] Bluetooth: hci0: RTL: loading rtl_bt/rtl8822cu_config.bin
[ 44.464368] Bluetooth: hci0: RTL: cfg sz 6, total sz 35990
[ 44.646812] Bluetooth: hci0: RTL: fw version 0x0cc6d2e3
[ 45.013367] usbcore: registered new interface driver rtl88x2cu
[ 45.407327] Bluetooth: MGMT ver 1.22
[ 45.438624] NET: Registered PF_ALG protocol family
```

Open wwan0

Command:

```
/usr/sbin/quectel-cm/quectel-CM &
```

Result:

```
root@am62xx:~# /usr/sbin/quectel-cm/quectel-CM &
[1] 912
[01-27 05:50:24:172] Quectel_QConnectManager Linux V1.6.0.24
root@am62xx:~# [01-27 05:50:24:179] Find /sys/bus/usb/devices/2-1.1.idVendor=0x2c7c idProduct=0x1255, bus=0x002, dev=0
803
[01-27 05:50:24:191] Auto find qmichannel = /dev/cdc-wdm0
[01-27 05:50:24:191] Auto find usbnet_adapter = wwan0
[01-27 05:50:24:191] netcard driver = qmi_wwan, driver version = 6.1.33
[01-27 05:50:24:191] Modem works in QMI mode
[01-27 05:50:24:208] /proc/781/rd/7 -> /dev/cdc-wdm0
[01-27 05:50:24:208] /proc/781/exe -> /usr/libexec/qmi-proxy
[01-27 05:50:24:210] cdc_wdm_fd = 7
[01-27 05:50:26:362] Get clientWDS = 17
[01-27 05:50:26:394] Get clientMNC = 1
[01-27 05:50:26:426] Get clientMNS = 2
[01-27 05:50:26:458] Get clientUIM = 1
[01-27 05:50:26:490] Get clientMNR = 1
[01-27 05:50:26:522] requestBasebandVersion EG25GGBR07A07M2G
[01-27 05:50:26:654] requestGetSIMSStatus SIMSStatus: SIM_READY
[01-27 05:50:26:682] requestGetProfile[1] internet//0
[01-27 05:50:26:714] requestRegistrationStatus MCC: 466, MNC: 1, PS: Attached, DataCap: LTE
[01-27 05:50:26:746] requestQueryDataCall IPv4ConnectionStatus: DISCONNECTED
[01-27 05:50:26:747] ifconfig wwan0 0.0.0.0
[01-27 05:50:26:767] ifconfig wwan0 down
[01-27 05:50:26:810] requestSetupDataCall_WdsConnectionIPv4Handle: 0xB72ef880
[01-27 05:50:26:939] ifconfig wwan0 up
[01-27 05:50:26:964] No default-script found, it should be in '/usr/share/udhpcp/' or '/etc/udhpcp/' depend on your u
dhpcp version!
[01-27 05:50:26:965] busybox udhpcp -f -n -q -t 5 -i wwan0
udhpcp started, 0.35.0
udhpcp: broadcasting discover
udhpcp: broadcasting select for 10.24.10.180, server 10.24.10.181
udhpcp: lease of 10.24.10.180 obtained from 10.24.10.181, lease time 7200
[01-27 05:50:27:104] ip -4 address flush dev wwan0
[01-27 05:50:27:123] ip -4 address add 10.24.10.180/29 dev wwan0
[01-27 05:50:27:139] ip -4 route add default via 10.24.10.181 dev wwan0
```

3.3.2 CN13 Mini Card Bluetooth (WPET-239ACN(BT))

Power on Mini Card (default: on)

Command:

```
gpiocet 2 25=0
```

Result:

```
root@am62xx:~# gpiocet 2 25=0
root@am62xx:~# [ 44.023611] usb 2-1.2: new high-speed USB device number 4 using xhci-hcd
[ 44.301375] Bluetooth: Core ver 2.22
[ 44.310366] NET: Registered PF_BLUETOOTH protocol family
[ 44.314004] cfg80211: Loading compiled-in X.509 certificates for regulatory database
[ 44.320975] Bluetooth: HCI device and connection manager initialized
[ 44.330734] Bluetooth: HCI socket layer initialized
[ 44.335796] Bluetooth: L2CAP socket layer initialized
[ 44.341016] Bluetooth: SCO socket layer initialized
[ 44.364933] cfg80211: Loaded X.509 cert 'sforshee: 00b28ddf47aef9cea7'
[ 44.376745] cfg80211: loaded regulatory.db is malformed or signature is missing/invalid
[ 44.389206] usbcore: registered new interface driver btusb
[ 44.414002] Bluetooth: hci0: RTL: examining hci_ver=0a hci_rev=000c lmp_ver=0a lmp_subver=8822
[ 44.424909] Bluetooth: hci0: RTL: rom_version status=0 version=3
[ 44.431091] Bluetooth: hci0: RTL: loading rtl_bt/rtl8822cu_fw.bin
[ 44.456563] Bluetooth: hci0: RTL: loading rtl_bt/rtl8822cu_config.bin
[ 44.464368] Bluetooth: hci0: RTL: cfg_sz 6, total sz 35990
[ 44.646812] Bluetooth: hci0: RTL: fw version 0x0cc6d2e3
[ 45.013367] usbcore: registered new interface driver rtl88x2cu
[ 45.407327] Bluetooth: MGMT ver 1.22
[ 45.438624] NET: Registered PF_ALG protocol family
```

Command to pair, connect

Command:

```
bluetoothctl
power on
agent off
agent NoInputNoOutput
default-agent
pairable on
```

```
root@am62xx:~# bluetoothctl
Agent registered
[CHG] Controller 00:0E:8E:C6:88:A1 Pairable: yes
[bluetooth]# power on
Changing power on succeeded
[bluetooth]# agent off
Agent unregistered
[CHG] Controller 00:0E:8E:C6:88:A1 Pairable: no
[bluetooth]# agent NoInputNoOutput
Agent registered
[CHG] Controller 00:0E:8E:C6:88:A1 Pairable: yes
[bluetooth]# default-agent
Default agent request successful
[bluetooth]# pairable on
Changing pairable on succeeded
[bluetooth]# █
```

Scan on

```
[bluetooth]# scan on
Discovery started
[CHG] Controller 00:0E:8E:C6:88:A1 Discovering: yes
[NEW] Device 4A:E7:F2:04:11:36 4A-E7-F2-04-11-36
[NEW] Device 77:27:87:12:F6:11 77-27-87-12-F6-11
[NEW] Device 4A:83:D9:65:4B:3B 4A-83-D9-65-4B-3B
[NEW] Device 40:0B:72:3F:B4:E1 40-0B-72-3F-B4-E1
[NEW] Device 48:2C:8E:97:47:E4 48-2C-8E-97-47-E4
[CHG] Device F4:73:35:75:CF:7B LegacyPairing: yes
[CHG] Device F4:73:35:75:CF:7B RSSI: -81
[NEW] Device 76:AE:37:3E:DB:91 76-AE-37-3E-DB-91
[NEW] Device 5C:3B:EF:52:3C:1E 5C-3B-EF-52-3C-1E
[CHG] Device 4A:83:D9:65:4B:3B RSSI: -103
[CHG] Device 4A:83:D9:65:4B:3B ManufacturerData Key: 0x004c
[CHG] Device 4A:83:D9:65:4B:3B ManufacturerData Value:
  10 07 38 1f 5c da 47 16 68          ..8.\.G.h
[CHG] Device 4A:83:D9:65:4B:3B ManufacturerData Key: 0x004c
[CHG] Device 4A:83:D9:65:4B:3B ManufacturerData Value:
  01 00 00 00 00 00 00 00 00 00 00 40 00 00 00 00  .....e....
  00
[NEW] Device 65:A2:03:16:49:FD 65-A2-03-16-49-FD
[NEW] Device 5F:B2:1C:8D:E3:30 5F-B2-1C-8D-E3-30
[CHG] Device 4A:83:D9:65:4B:3B ManufacturerData Key: 0x004c
[CHG] Device 4A:83:D9:65:4B:3B ManufacturerData Value:
  10 07 38 1f 5c da 47 16 68          ..8.\.G.h
[CHG] Device 4A:83:D9:65:4B:3B ManufacturerData Key: 0x004c
[CHG] Device 4A:83:D9:65:4B:3B ManufacturerData Value:
  01 00 00 00 00 00 00 00 00 00 00 40 00 00 00 00  .....e....
  00
```

Please find the MAC address of the device to connect to in the log after scanning

Pair <mac>

Command:

```
pair F4:73:35:75:CF:7B
```

```
[NEW] Device F4:73:35:75:CF:7B Keyboard K380
[bluetooth]# pair F4:73:35:75:CF:7B
Attempting to pair with F4:73:35:75:CF:7B
[CHG] Device F4:73:35:75:CF:7B Connected: yes
[CHG] Device F4:73:35:75:CF:7B Bonded: yes
[CHG] Device F4:73:35:75:CF:7B Modalias: usb:v046DpB342d4201
[CHG] Device F4:73:35:75:CF:7B UUIIDs: 00001000-0000-1000-8000-00805f9b34fb
[CHG] Device F4:73:35:75:CF:7B UUIIDs: 00001124-0000-1000-8000-00805f9b34fb
[CHG] Device F4:73:35:75:CF:7B UUIIDs: 00001200-0000-1000-8000-00805f9b34fb
[CHG] Device F4:73:35:75:CF:7B ServicesResolved: yes
[CHG] Device F4:73:35:75:CF:7B Paired: yes
Pairing successful
```

Connect <mac>

Command:

```
pair F4:73:35:75:CF:7B
```

```
[bluetooth]# connect F4:73:35:75:CF:7B
Attempting to connect to F4:73:35:75:CF:7B
[bluetooth]# [ 2482.602573] Bluetooth: HIDP (Human Interface Emulation) ver 1.2
[ 2482.614268] Bluetooth: HIDP socket layer initialized
[CHG] Device F4:73:35:75:CF:7B Connected: yes
Connection successful
[Keyboard K380]# [ 2483.153209] hid-generic 0005:046D:B342.0001: unknown main item tag 0x0
[ 2483.163276] input: Keyboard K380 Keyboard as /devices/platform/bus@f0000/f910000.dwc3-usb/31100000.usb/xhci-hcd.3.
auto/usb2/2-1/2-1.2/2-1.2:1.0/bluetooth/hci0/hci0:2/0005:046D:B342.0001/input/input0
[ 2483.192500] hid-generic 0005:046D:B342.0001: input: BLUETOOTH HID v42.01 Keyboard [Keyboard K380] on 00:0e:8e:c6:8
3:a1
[CHG] Device F4:73:35:75:CF:7B ServicesResolved: yes
[Keyboard K380]#
```

Command:

```
trust F4:73:35:75:CF:7B
```

```
exit
```

```
[Keyboard K380]# trust F4:73:35:75:CF:7B
[CHG] Device F4:73:35:75:CF:7B Trusted: yes
Changing F4:73:35:75:CF:7B trust succeeded
[Keyboard K380]# exit
root@am62xx:~#
```

3.3.3 CN13 Mini Card Wi-Fi (WPET-239ACN(BT))

Power on Mini Card (default: on)

Command:

```
gpiocet 2 25=0
```

Result:

```
root@am62xx:~# gpiocet 2 25=0
root@am62xx:~# [ 44.023611] usb 2-1.2: new high-speed USB device number 4 using xhci-hcd
[ 44.301375] Bluetooth: Core ver 2.22
[ 44.310366] NET: Registered PF_BLUETOOTH protocol family
[ 44.314004] cfg80211: Loading compiled-in X.509 certificates for regulatory database
[ 44.320975] Bluetooth: HCI device and connection manager initialized
[ 44.330734] Bluetooth: HCI socket layer initialized
[ 44.335796] Bluetooth: L2CAP socket layer initialized
[ 44.341016] Bluetooth: SCO socket layer initialized
[ 44.364933] cfg80211: Loaded X.509 cert 'sforshee: 00b28ddf47aef9cea7'
[ 44.376745] cfg80211: loaded regulatory.db is malformed or signature is missing/invalid
[ 44.389206] usbcore: registered new interface driver btusb
[ 44.414002] Bluetooth: hci0: RTL: examining hci_ver=0a hci_rev=000c lmp_ver=0a lmp_subver=8822
[ 44.424909] Bluetooth: hci0: RTL: rom_version status=0 version=3
[ 44.431091] Bluetooth: hci0: RTL: loading rtl_bt/rtl8822cu_fw.bin
[ 44.456563] Bluetooth: hci0: RTL: loading rtl_bt/rtl8822cu_config.bin
[ 44.464368] Bluetooth: hci0: RTL: cfg_sz 6, total sz 35990
[ 44.646812] Bluetooth: hci0: RTL: fw version 0x0cc6d2e3
[ 45.013367] usbcore: registered new interface driver rtl88x2cu
[ 45.407327] Bluetooth: MGMT ver 1.22
[ 45.438624] NET: Registered PF_ALG protocol family
```

Open wlan0

Command:

```
ifconfig wlan0 up
```

Result:

```
root@am62xx:~# ifconfig wlan0 up
[ 287.096517] start addr=(0x20000), end addr=(0x40000), buffer size=(0x20000), smp number max=(16384)
```

Scan Wi-Fi name

Command:

```
iw wlan0 scan | grep 'AAEON-Wireless'(your WiFi name)
```

Result:

```
root@am62xx:~# iw wlan0 scan | grep 'AAEON-Wireless'
    SSID: AAEON-Wireless
    SSID: AAEON-Wireless-PEAP
    SSID: AAEON-Wireless
    SSID: AAEON-Wireless
    SSID: AAEON-Wireless-PEAP
root@am62xx:~#
```

Save Wi-Fi name/password

Command:

```
wpa_passphrase AAEON-Wireless >> /tmp/wpa_wifi.conf
```

Result:

```
root@am62xx:~# wpa_passphrase AAEON-Wireless >> /tmp/wpa_wifi.conf
# reading passphrase from stdin
input password
root@am62xx:~#
```

Initial Wi-Fi configuration

Command:

```
wpa_supplicant -B -i wlan0 -c /tmp/wpa_wifi.conf root
```

Result:

```
root@am62xx:~# wpa_supplicant -B -i wlan0 -c /tmp/wpa_wifi.conf root
Successfully initialized wpa supplicant
root@am62xx:~# [ 1373.011567] IPv6: ADDRCONF (NETDEV_CHANGE): wlan0: link becomes ready
```

Link Wi-Fi

Command:

```
iw wlan0 link
dhclient wlan0
```

Result:

```
root@am62xx:~# iw wlan0 link
Connected to 24:81:3b:2b:5d:4e (on wlan0)
    SSID: AAEON-Wireless
    freq: 5200
    RX: 927 bytes (5 packets)
    TX: 3554 bytes (23 packets)
    signal: -80 dBm
    rx bitrate: 6.0 MBit/s
    tx bitrate: 39.0 MBit/s VHT-MCS 2 VHT-NSS 2
root@am62xx:~# dhclient wlan0
```

3.3.4 CN12 & CN13 Mini Card Power On/Off Pin Control

Power On	Power Off
gpioset 2 25=0	gpioset 2 25=1

3.3.5 CN12 & CN13 Pin 22 PERST# High/Low Pin Control

Connector	PERST# High	PERST# Low
CN12	gpioset 1 6=1	gpioset 1 6=0
CN13	gpioset 1 7=1	gpioset 1 7=0

3.4 OS Installation

3.4.1 Flash SD Card

Step 1: Use balenaEtcher to flash boot image to SD card.

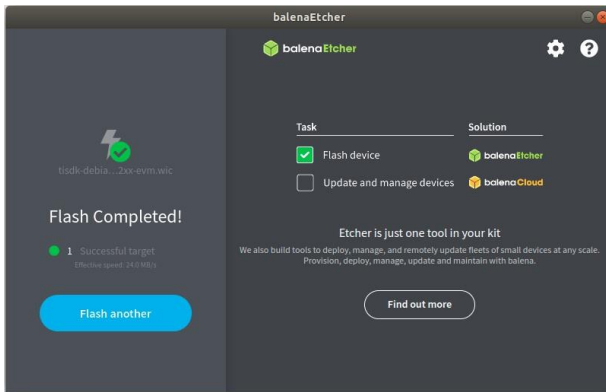
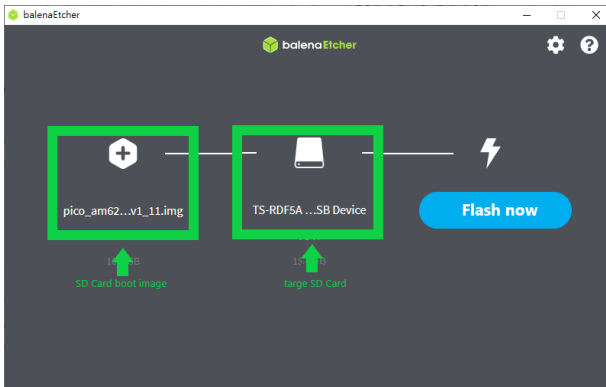

Step 2: Press SW2 and connect the power supply to start up the SD Card boot.

Step 3: Flash eMMC Card - After booting with the SD Card, use the following commands to flash the image to the eMMC.

Command:

```
am625_emmc_flasher.sh
```

Result:

```

root@am62xx:~# am625_emmc_flasher.sh
-----
rootfs drive: mmcblk1p2
-----
=====] 511%
[ 45.726705] mmcblk0: p1 p2 ] 38%
[ 45.734759] mmcblk0: p1 p2
mke2fs 1.47.0 (5-Feb-2023)
=====] 2269%
[-----> ] 30%
[ 46.957114] EXT4-fs (mmcblk0p2): mounted filesystem with ordered data mode. Quota mode: none.
[ 248.384103] EXT4-fs (mmcblk0p2): unmounting filesystem. ] 77%
[-----> ] 77%

This script has now completed it's task
-----
Note: Actually unpower the board, a reset [sudo reboot] is not enough.
-----
root@am62xx:~# █
    
```

Please power up the PICO-AM62 again and boot using eMMC mode.

3.4.2 SD Card/EMMC Boot Mode

Use SW2 status to choose SD Card/EMMC boot mode.

SD Card Boot Mode	eMMC Boot Mode
Press SW2	Do not press SW2

3.4.3 Check OS Version

Command:

```
cat /etc/aaeon-release
```

Result:

```
root@am62xx:~# cat /etc/aaeon-release
PRETTY_NAME="Debian GNU/Linux 12 (bookworm)"
NAME="Debian GNU/Linux"
VERSION_ID="12"
VERSION="12 (bookworm)"
VERSION_CODENAME=bookworm
ID=debian
HOME_URL="https://www.debian.org/"
SUPPORT_URL="https://www.debian.org/support"
BUG_REPORT_URL="https://bugs.debian.org/"
IMAGE_VERSION="PICO-AM62-V1.11"
HW_INFO="PICO-AM62 A02 AM6232"
CREATE_DATE="2024/05/10"

root@am62xx:~# █
```

Appendix A

Mating Connectors

A.1 List of Mating Connectors and Cables

The following table lists mating connectors and available cables.

Conn Label	Function	Mating Connector		Available Cable	Cable P/N
		Vendor	Model No.		
CN1	DC Power	DINKLE	ECH381RM-02P-BK	N/A	N/A
CN4	SPI/I2C/GPIO Connector	PINREX	232-92-04GBEM	N/A	N/A
CN12	4G Full-Size Mini Card Slot	Quectel	Quectel.EG-25G	4G Module Card	9686EG25G0
CN13	WiFi/BT Half-Size Mini Card Slot	Intel	7260HMW	N/A	N/A
CN14	RTC Battery Connector	Molex	51021-0200	RTC Battery Cable	175011301K
CN16	Micro SD Slot	Transcend	TS16GUSD300S-A	N/A	N/A
CN25	LVDS Port Inverter/Backlight Connector	JST	PHR-5	N/A	N/A
CN26	LVDS Port	ACES	50247-030H0H0-001	LVDS Cable	1704300030 (LVDS panel: AUO G185XW01)
CN27	Audio Port	ACES	50247-012H0 H0-001	Audio Port Cable	170X000156
CN30	Debug Port	UGREEN	US289	USB 2.0 Micro B Cable	N/A
CN70	RS-232/422/485 COM Port 1, Port 2	DINKLE	0156-1718-BK	N/A	N/A
CN71	RS-232/422/485 COM Port 3	PINREX	710-73-09TW01	N/A	N/A
CN72	RS-232/422/485 COM Port 4	PINREX	710-73-09TW01	N/A	N/A
CN94	Internal USB 2.0 Port	PINREX	712-91-055W60	N/A	N/A
CN141	HDMI Port	Molex	88768-9900	HDMI Cable	N/A
CN142	USB 2.0 Port 1, Port 2	UGREEN	US128	USB 3.2 Cable	N/A
CN145	LAN (RJ-45) Port 1, Port 2	Molex	44915-0001	N/A	N/A