

PCM-6897/L

Socket 370 based Tualatin/

Pentium® III / Celeron®

Comopact Board

W/LCD, Ethernet, Audio, & CFD

PCM-6897/L Rev. A Manual

Oct. 2003

Copyright Notice

This document is copyrighted, 2003. All rights are reserved. The original manufacturer reserves the right to make improvements to the products described in this manual at any time without notice.

No part of this manual may be reproduced, copied, translated, or transmitted in any form or by any means without the prior written permission of the original manufacturer. Information provided in this manual is intended to be accurate and reliable. However, the original manufacturer assumes no responsibility for its use, or for any infringements upon the rights of third parties which may result from its use.

The material in this document is for product information only and is subject to change without notice. While reasonable efforts have been made in the preparation of this document to assure its accuracy, AAEON, assumes no liabilities resulting from errors or omissions in this document, or from the use of the information contained herein.

AAEON reserves the right to make changes in the product design without notice to its users.

Acknowledgments

All other product names or trademarks are properties of their respective owners.

Award is a trademark of Award Software International, Inc.

CompactFlash™ is a trademark of the Compact Flash Association.

IBM, PC/AT, PS/2, and VGA are trademarks of International Business Machines Corporation.

Intel and Pentium III are trademarks of Intel Corporation.

ITE is a trademark of Integrated Technology Express, Inc.

Microsoft Windows® is a registered trademark of Microsoft Corp.

SMI is a trademark of Silicon Motion, Inc.

SoundBlaster is a trademark of Creative Labs, Inc.

Packing List

Before you begin installing your card, please make sure that the following materials have been packed:

- 1 PCM-6897/L Compact board
- 1 Quick Installation Guide
- 1 CD-ROM for manual (in PDF format) and drivers
- 1 TV-out cable (for PCM-6897)
- Jumper kit
- Short copper and support

The PCM-6897/L requires several cables for operation. You can make them yourself or purchase an optional cable kit, PCM-10689-1.

If any of these items should be missing or damaged, contact your distributor or sales representative immediately.

Contents

Chapter 1 General Information

1.1 Introduction.....	1-2
1.2 Features.....	1-4
1.3 Specifications.....	1-5

Chapter 2 Quick Installation Guide

2.1 Safety Precautions.....	2-2
2.2 Location of Connectors and Jumpers.....	2-3
2.3 Mechanical Drawing.....	2-5
2.4 List of Jumpers.....	2-7
2.5 List of Connectors.....	2-8
2.6 Setting Jumpers.....	2-9
2.7 Audio Out Selection (JP1)	2-10
2.8 PCI-104 I/O Voltage Selection (JP2).....	2-10
2.9 COM2 RS232/422/485 Selection (JP3/5)	2-10
2.10 COM2 Ring/+5V/+12V Selection (JP4).....	2-11
2.11 Clear CMOS (JP6).....	2-11
2.12 LCD Voltage Selection (JP7).....	2-11
2.13 TTL-LCD Clock Selection (JP8).....	2-12
2.14 ATX Power Connector (CN1)	2-12
2.15 AT Power Connector (CN2).....	2-12
2.16 Audio Connector (CN3).....	2-13
2.17 Floppy Connector (CN4).....	2-13
2.18 LAN LED Connector (CN5).....	2-15

2.19 LPT Port Connector (CN6).....	2-15
2.20 IrDA Connector (CN7).....	2-16
2.21 USB Connectors (CN8/CN9).....	2-17
2.22 GPIO Connector (CN10).....	2-18
2.23 Serial Port Connector (CN11).....	2-18
2.24 Optional PME Connector (CN12).....	2-19
2.25 PS2 Keyboard/Mouse Connector (CN13).....	2-19
2.26 VGA Display Connector (CN14).....	2-20
2.27 TTL_LCD Connector (CN15).....	2-20
2.28 LVDS Connector (CN17).....	2-21
2.29 TV_Out Connector (CN18).....	2-21
2.30 Fan Connectors (CN19/20).....	2-22
2.31 Front Panel Connector (CN21).....	2-22
2.32 EIDE Connector (IDE1).....	2-22
2.33 10/100Base-Tx Ethernet Connector (LAN1).....	2-24

Chapter 3 Award BIOS Setup

3.1 System Test and Initialization.....	3-2
3.2 Award BIOS Setup.....	3-3
3.3 Standard CMOS Features.....	3-6
3.4 Advanced BIOS Features.....	3-7
3.5 Advanced Chipset Features.....	3-8
3.6 Integrated peripherals.....	3-9
3.7 Power Management Setup.....	3-10
3.8 PnP/PCI Configurations.....	3-11

3.9 PC Health Status.....	3-12
3.10 Frequency/Voltage Control.....	3-13
3.11 Load Fail-safe Defaults.....	3-14
3.12 Load Optimized Defaults.....	3-14
3.13 Set Supervisor/User Password.....	3-14
3.14 Save and Exit Setup.....	3-15
3.15 Exit without saving.....	3-15

Chapter 4 Driver Installation

4.1 Installation 1.....	4-2
4.2 Installation 2.....	4-3
4.3 Installation 3.....	4-4

Appendix A Programming the Watchdog Timer

A.1 Watchdog timer of PCM-6897/L.....	A-2
A.2 Configuring Sequence Description.....	A-2
A.3 IT8712 initial watchdog timer program.....	A-5

Appendix B Optional Extras

B.1 PCM-10689-1 Wiring Kit.....	B-2
---------------------------------	-----

Chapter

1

**General
Information**

1.1 Introduction

AAEON new compact size board PCM-6897/L targets high-end multimedia and networking applications. Easy Upgrading allows you to take full advantage of Intel® Development of even-higher speed Tualatin, Pentium® III and Celeron® processors. This is a perfect choice for embedded applications that require cost-effective, high computing performance features.

PCM-6897 and PCM-6897L differs in the display support to fit your different system requirement. For VGA or non-display application, PCM-6897L would be a more cost-effective solution. However, targeting to serve high-end multimedia markets, PCM-6897 is equipped with SMI 722 graphic controller to offer you excellent visual performance.

PCM-6897/L features power management to minimize power consumption. It complies with the ACPI standard and supports power-saving features which is Suspend modes. The board watchdog timer automatically resets the system or generates an interrupt in case the system stops due to a program bug or EMI.

The onboard Compact Flash will offer a larger memory bank for data storage of all types. CompactFlash requires a fraction of power used to drive floppy disk or CD-ROMs, also no battery is required to save the data when the computer powers down.

The onboard 10/100BaseTx Ethernet interface and Sound Blaster-compatible audio opens up worlds of possibilities for kiosks, gaming systems, POS systems, medical and educational products. The Fast Ethernet controller provides a tenfold increase in Network capability, and is fully compatible with traditional 10Mbps network facilities.

PCM-6897/L also includes four high-speed serial ports (three RS-232, one RS-232/422/485), one multimode (ECP/EPP/SPP) parallel port, 2 floppy drives, four USB ports, an Ultra DMA/100 enhanced IDE controller supporting up to two devices with data transfer rate up to 100MB per second, and a keyboard/PS/2 mouse interface. This AAEON embedded PC includes almost everything you need for fast, worry-free embedded PC performance.

The addition of PCI-104 connector allows a wide selection of accessory cards to be added to the PCM-6897/L. Such accessories as Ultra Wide 2 SCSI, fax modem, vehicle power supply, extra DiskOnChip, PCMCIA module, etc.

1.2 Features

- Supports socket 370 based Intel® Tualatin, Pentium® III, and Celeron® processors
- High Speed AGP 2X for VGA display
- On board SM 722 Controller supports up to 24-bit TTL/LVDS TFT/DSTN panels (for PCM-6897)
- One 10/100Base-T Fast Ethernet
- Supports H/W status monitoring
- Integrated AC-97 2.1 SoundBlaster compatible 3D Audio
- Supports CompactFlash memory storage
- Four USB Ports
- Digital I/O

1.3 Specifications

System

- CPU: Socket 370 based Intel® Tualatin® (.13 μ)/Pentium® III(.18 μ)/Celeron® (.18 μ) Processor up to 1.4GHz
- Memory: SDRAM DIMM Socket x 1, Max 512MB (PC-100/133 supported)
- Chipset: Intel 815E + ICH2
- BIOS: Award 2 Mb FLASH BIOS
- Audio: ALC201 Codec AC97, Mic in, Line in, Line out, CD Audio in, Speaker out
- SSD: One Type II CompactFlash Card
- Watchdog timer: Can generate a system reset
- DMA: 7 DMA channels (8237 equivalent)
- Interrupt: 15 interrupt levels (8259 equivalent)
- Ethernet: Intel 815E, 10/100MB Fast Ethernet Chip, RJ45 connector x 1
- Expansion Interface: PCI-104 x 1, PCI slot x 1
- H/W status monitoring: Power supply voltages and temperatures monitoring functions are built into ITE 8712 chip
- Battery: Lithium battery for data retention,

DIP Type.

- Power supply voltage: +3.3V, $\pm 5V$, $\pm 12V$, ATX or AT power supply
- Operating temperature: 32 to 140 °F (0 to 60 °C)
- Board size/Weight: 8" (L) x 5.75" (W) (203 mm x 146 mm); 1.2lb(0.5Kg)

Display

PCM-6897

- Chipset: SMI 722
- Memory size: 4MB integrated
- Resolution: Up to 1600 X 1200 colors for CRT;
Up to 1024 X 768 for TFT & DSTN
- LCD Interface: Up to 24-bit TTL/DSTN LCD
- TV out: Support NTSC/PAL standard

PCM-6897L

- Chipset: Intel 815E, AGP 2X, 133MHz
- Memory size: UMA up to 4MB
- Resolution: Up to 1600 X 1200@24bit colors
- LCD Interface: None

I/O

- MIO: EIDE (Ultra DMA100) x 1, FDD x 1, RS-232/422/485 x 1, RS-232 x 3, LPT x 1, Keyboard/Mouse

- Digital I/O: Connector x 1,
Support 4 general purpose I/O each
with TTL level interface
- IR interface: One IrDA Tx/Rx header
- USB: Two 5x2 pin headers support 4 USB
ports

Chapter

2

Quick Installation Guide

Notice:

The Quick Installation Guide is derived from Chapter 2 of user manual. For other chapters and further installation instructions, please refer to the user manual CD-ROM that came with the product.



2.1 Safety Precautions

Warning!

Always completely disconnect the power cord from your board whenever you are working on it. Do not make connections while the power is on, because a sudden rush of power can damage sensitive electronic components.

Caution!

Always ground yourself to remove any static charge before touching the board. Modern electronic devices are very sensitive to static electric charges. Use a grounding wrist strap at all times. Place all electronic components on a static-dissipative surface or in a static-shielded bag when they are not in the chassis

2.2 Location of Connectors and Jumpers

Locating connectors and jumpers (component side)

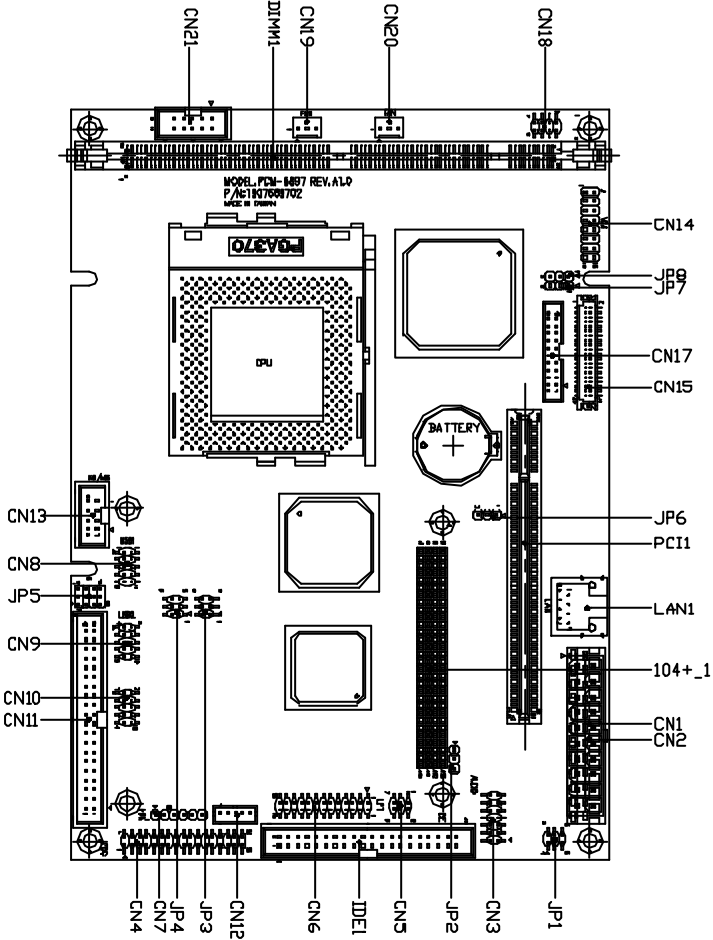

Locating connector (solder side)

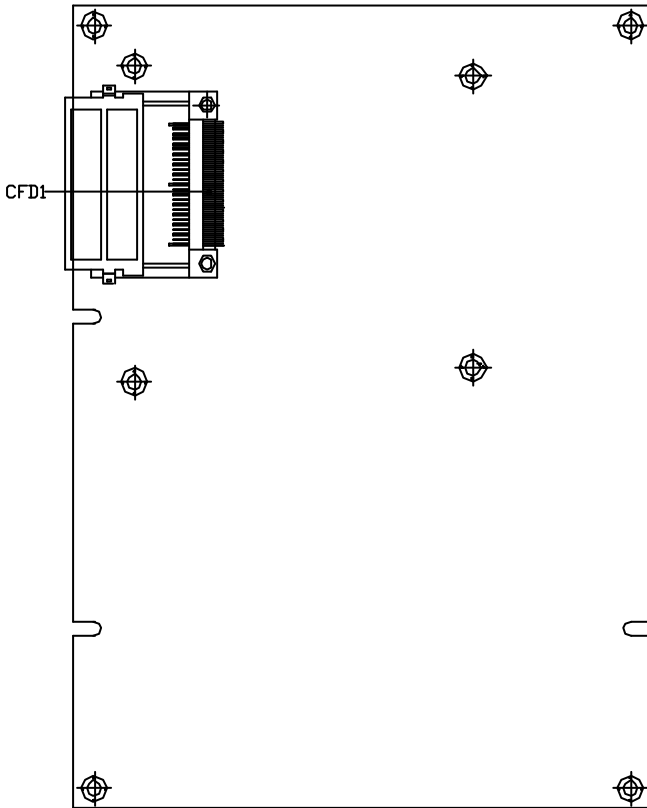

2.3 Mechanical Drawing

Mechanical drawing (component side)

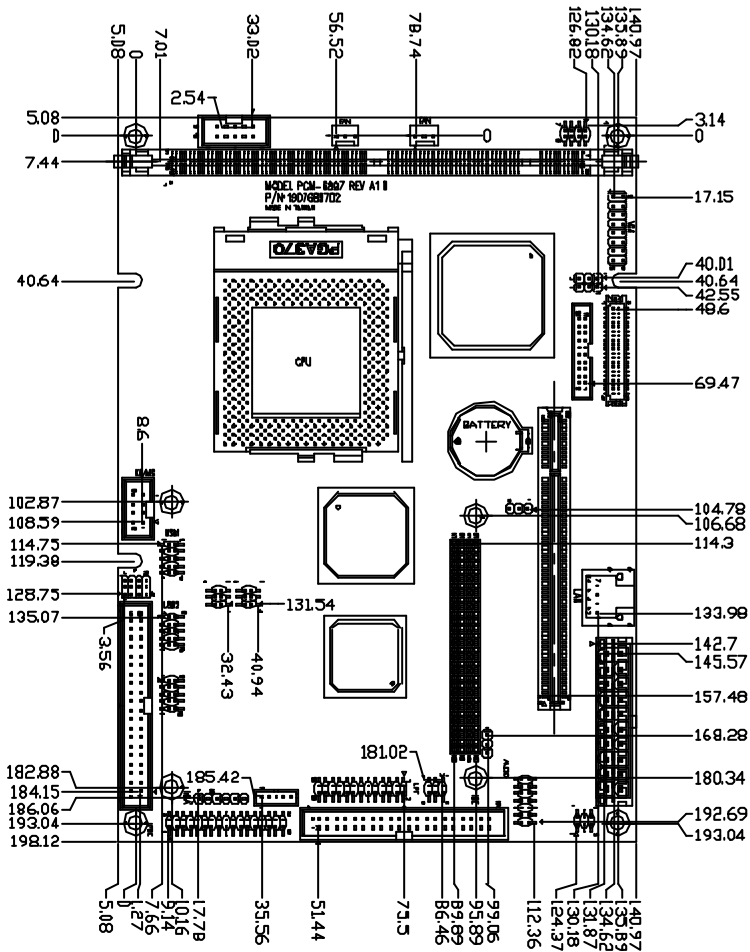

Mechanical Drawing (solder side)

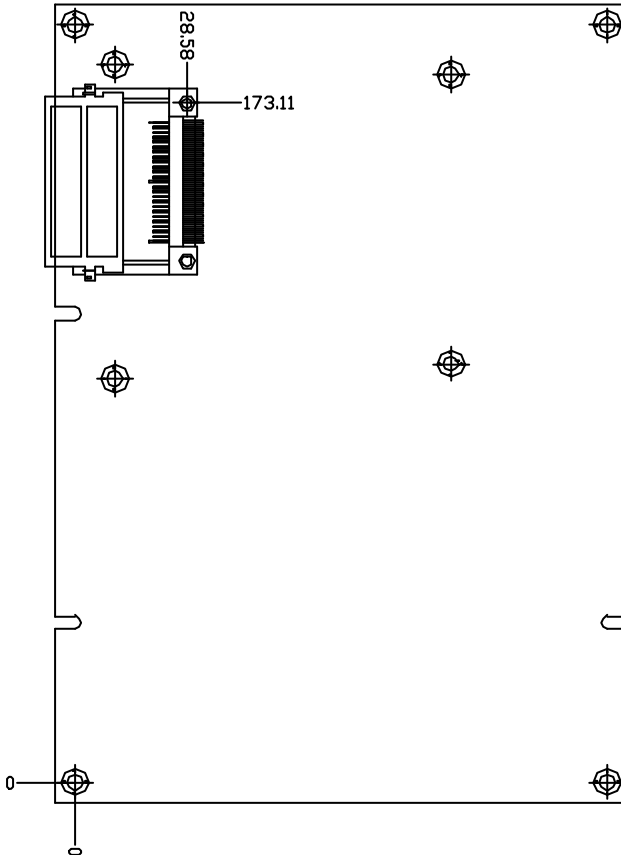

2.4 List of Jumpers

The board has a number of jumpers that allow you to configure your system to suit your application.

The table below shows the function of each of the jumpers of the board:

Jumpers

Label	Function
JP1	Audio Out Selection
JP2	PCI-104 I/O Voltage Selection
JP3	COM2 RS-232/422/485 Selection
JP4	COM2 Ring/+5V/+12V Selection
JP5	COM2 RS-232/422/485 Selection
JP6	Clear CMOS
JP7	LCD Voltage Selection
JP8	TTL-LCD Clock Selection

2.5 List of Connectors

The board has a number of connectors that allow you to configure your system to suit your application.

The table below shows the function of each of the connectors of the board:

Connectors

Label	Function
CN1	ATX Power Connector *
CN2	AT Power Connector *
CN3	Audio Connector
CN4	Floppy Connector
CN5	LAN LED Connector
CN6	LPT Port Connector
CN7	IrDA Connector
CN8	USB1/2 Connector
CN9	USB3/4 Connector
CN10	GPIO Connector
CN11	Serial Port Connector
CN12	Optional PME Connector
CN13	PS2 Keyboard/Mouse Connector
CN14	VGA Display Connector
CN15	TTL_LCD Connector
CN17	LVDS Connector
CN18	TV_Out Connector
CN19	Fan1 Connector
CN20	Fan2 Connector
CN21	Front Panel Connector
104+_1	PCI-104 Connector
DIMM1	DIMM Slot

IDE1	EIDE Connector
LAN1	10/100 Base-Tx Ethernet Connector
PCI1	PCI Slot
CFD1	CompactFlash Slot

* AT and ATX power connectors occupy the same location on the board. You may select either ATX or AT type power connector to fit your application.

2.6 Setting Jumpers

You configure your card to match the needs of your application by setting jumpers. A jumper is the simplest kind of electric switch. It consists of two metal pins and a small metal clip (often protected by a plastic cover) that slides over the pins to connect them. To “close” a jumper you connect the pins with the clip.

To “open” a jumper you remove the clip. Sometimes a jumper will have three pins, labeled 1, 2 and 3. In this case you would connect either pins 1 and 2 or 2 and 3.

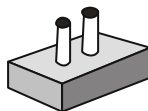

Open

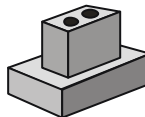

Closed

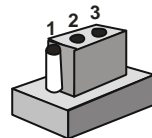

Closed 2-3

A pair of needle-nose pliers may be helpful when working with jumpers.

If you have any doubt about the best hardware configuration for your application, contact your local distributor or sales representative before you make any change.

Generally, you simply need a standard cable to make most connections.

2.7 Audio Out Selection (JP1)

JP1	Function
1-3, 2-4	W/O Amplifier
3-5, 4-6	W/Amplifier (Default)

2.8 PCI-104 I/O Voltage Selection (JP2)

JP2	Function
1-2	5 V(Default)
2-3	3.3V

2.9 COM2 RS-232/422/485 Selection (JP3/JP5)

The COM2 port can be selected as RS-232, RS-422 or RS-485 by setting both JP3 and JP5. The following chart shows the jumper setting.

JP3	JP5	Function
1-2	1-2, 4-5, 7-8, 10-11	RS-232 (Default)
3-4	2-3, 5-6, 8-9, 11-12	RS-422
5-6	2-3, 5-6, 8-9, 11-12	RS-485

2.10 COM2 Ring/+5V/+12V Selection (JP4)

JP4	Function
1-2	+12V
3-4	+5V
5-6	Ring(Default)

2.11 Clear CMOS (JP6)

Warning:

To avoid damaging the computer, always turn off the power supply before setting "Clear CMOS." Before turning on the power supply, set the jumper back to "Protected"

JP6	Function
1-2	Protected(Default)
2-3	Clear CMOS

2.12 LCD Voltage Selection (JP7)

You can select the LCD voltage situation by setting JP7. The following chart shows the available options.

JP7	Function
1-2	+3.3V (Default)
2-3	+5V

2.13 TTL-LCD Clock Selection (JP8)

You can select the LCD clock situation by setting JP8. The following chart shows the available options.

JP8	Function
1-2	Clock (Default)
2-3	Reverse Clock

2.14 ATX Power Connector(CN1)

Pin	Signal	Pin	Signal
1	+3.3V	11	+3.3V
2	+3.3V	12	-12V
3	GND	13	GND
4	+5V	14	PS_ON
5	GND	15	GND
6	+5V	16	GND
7	GND	17	GND
8	POWER OK	18	-5V
9	+5VSB	19	+5V
10	+12V	20	+5V

2.15 AT Power Connector(CN2)

Pin	Signal
1	N.C
2	+5V

3	+12V
4	-12V
5	GND
6	GND
7	GND
8	GND
9	-5V
10	+5V
11	+5V
12	+5V

2.16 Audio Connector(CN3)

The PCM-6897/L provides all major audio signals on a 14-pin flat-cable connector, CN3. Attach the Mic In, Line In, and Audio Out to the corresponding pins as shown in the following table.

Pin	Signal	Pin	Signal
1	MIC_IN	2	MIC_+2.5V
3	LINE_IN_GND	4	CD_GND
5	LINE_IN_L	6	CD_IN_L
7	LINE_IN_R	8	CD_GND
9	LINE_IN_GND	10	CD_IN_R
11	LINE_OUT_L	12	LINE_OUT_R
13	LINE_OUT_GND	14	LINE_OUT_GND

2.17 Floppy Connector(CN4)

With support of different types of floppy, you can simply adopt any of the combinations of 5.25" (360 KB and 1.2 MB) and/or 3.5" (720 KB, 1.44 MB, and 2.88 MB) drives onto the mainboard.

A 34-pin daisy-chain drive connector cable is required for a dual-drive system. On one end of the cable is a 34-pin flat-cable

connector. On the other end are two sets of floppy disk drive connectors. Each set consists of a 34-pin flat-cable connector (usually used for 3.5" drives) and a printed-circuit board connector (usually used for 5.25" drives). Wire number 1 on the cable is normally red or blue, and the other wires are usually gray.

Connecting the floppy drive

1. Plug the 34-pin flat-cable connector into CN4. Make sure that the red or blue wire corresponds to pin 1 on the connector.
2. Attach the appropriate connector on the other end of the cable to the floppy drive(s). You can use only one connector in the set. The set on the end (after the twist in the cable) connects to A: drive. The set in the middle connects to B: drive.
3. If you are connecting a 5.25" floppy drive, line up the slot in the printed circuit board with the blocked-off part of the cable connector.

If you are connecting a 3.5" floppy drive, you may have trouble determining which pin is pin number 1. Look for a number printed on the circuit board indicating pin number 1. Also, the connector on the floppy drive connector may have a slot. When the slot is up, pin number 1 should be on the right. Check the documentation that came with the drive for more information.

Pin	Signal	Pin	Signal
1	GND	2	REDWC
3	GND	4	N.C.
5	GND	6	DS1
7	GND	8	INDEX
9	GND	10	MOTOR A
11	GND	12	DRIVE SELECT B
13	GND	14	DRIVE SELECT A
15	GND	16	MOTOR B

17	GND	18	DIR
19	GND	20	STEP
21	GND	22	WRITE DATA
23	GND	24	WRITE GATE
25	GND	26	TRACK0
27	GND	28	WRITE PROTECT
29	GND	30	READ DATA
31	GND	32	SIDE1
33	GND	34	DISK CHANGE

2.18 LAN LED Connector(CN5)

The PCM-6897/L supports three sets of LED connector for external LED indicators.

Ethernet active signal LED

Flashing Tx or Rx LEDs indicate that the PCM-6897/L is transmitting or receiving data.

Ethernet link signal LED

A continuously lit LED indicates good linkage between the PCM-6897/L and its supporting hub.

Ethernet speed signal LED

Flashing LED indicates the transfer speed (10Base-T or 100Base-Tx) of the network.

Pin	Signal	Pin	Signal
1	+3.3V	2	Active LED
3	+3.3V	4	Link LED
5	+3.3V	6	Speed LED

2.19 LPT Port Connector(CN6)

Normally, the parallel port is used to connect the board to a printer. The PCM-6897/L includes a multi-mode (ECP/EPP/SPP) parallel port. It is accessed via CN6 with a 26-pin flat-cable connector.

You will need an adapter cable if you use a traditional DB-25 connector. The adapter cable should have a 26-pin connector on one end and a DB-25 connector on the other end.

Pin	Signal	Pin	Signal
1	STROBE	2	AFD
3	PTD0	4	ERROR
5	PTD1	6	INIT
7	PTD2	8	SLIN
9	PTD3	10	GND
11	PTD4	12	GND
13	PTD5	14	GND
15	PTD6	16	GND
17	PTD7	18	GND
19	ACK	20	GND
21	BUSY	22	GND
23	PE	24	GND
25	SELECT	26	NC

2.20 IrDA Connector(CN7)

The IrDA connector (CN7) can be configured to support wireless infrared module, with this module and application software such as laplink or Win95 Direct Cable connection, user can transfer files to or from laptops, notebooks, PDA and printers. Install infrared module onto IrDA connector and enable infrared function from BIOS setup. Make sure to have correct orientation when you plug onto IrDA connector CN7.

Pin	Signal
-----	--------

1	+5V
2	CIRTX
3	IRRX
4	GND
5	IRTX
6	CIRTX

2.21 USB Connectors(CN8/CN9)

The PCM-6897/L board provides four USB (Universal Serial Bus) interfaces supporting up to 4 USB ports. The USB interfaces comply with USB specification rev. 1.1 and are fuse protected.

The USB interfaces are accessed through two 10-pin flat-cable connectors, CN8 & CN9. The adapter cable has a 10-pin connector on one end and two USB connectors on the bracket on the other end.

USB1 Connector (CN8)

Pin	Signal	Pin	Signal
1	+5V	2	GND
3	USBD1-	4	GND
5	USBD1+	6	USBD2+
7	GND	8	USBD2-
9	GND	10	+5V

USB2 Connector (CN9)

Pin	Signal	Pin	Signal
1	+5V	2	GND
3	USBD3-	4	GND
5	USBD3+	6	USBD4+

7	GND	8	USBD4-
9	GND	10	+5V

2.22 GPIO Connector(CN10)

PCM-6897/L offers 4-pair of digital I/O functions. With the input and output consisting of the following: Input 801H; GPI20 [bit0], GPI21 [bit1], GPI22 [bit2], GPI23 [bit3] and Output 801H; GPO24 [bit4], GPO25 [bit5], GPO26 [bit6], GPO27 [bit7]. The pin definitions are illustrated below:

Pin	Signal	Pin	Signal
1	IN1	2	IN2
3	IN3	4	IN4
5	OUT1	6	OUT2
7	OUT3	8	OUT4
9	+5V	10	GND

2.23 Serial Port Connector(CN11)

Pin	Signal	Pin	Signal
1	DCD1	2	DSR1
3	RXD1	4	RTS1
5	TXD1	6	CTS1
7	DTR1	8	RI1
9	GND	10	N.C
11	DCD2(422TXD-/485DATA)	12	DSR2
13	RXD2(422RXD+)	14	RTS2
15	TXD2(422TXD+/485DATA)	16	CTS2
17	DTR2(422RXD-)	18	RI2
19	GND	20	N.C
21	DCD3	22	DSR3

23	RXD3	24	RTS3
25	TXD3	26	CTS3
27	DTR3	28	RI3
29	GND	30	N.C
31	DCD4	32	DSR4
33	RXD4	34	RTS4
35	TXD4	36	CTS4
37	DTR4	38	RI4
39	GND	40	N.C

2.24 Optional PME Connector(CN12)

Pin	Signal
1	+5VSB
2	GND
3	#PME
4	SMB_DATA
5	SMB_CLK

2.25 PS2 Keyboard/Mouse Connector(CN13)

The PCM-6897/L board provides a pin header keyboard/Mouse connector, which supports both a keyboard and a PS/2 style mouse.

Pin	Signal
1	KB_DATA
2	KB_CLK
3	GND
4	+5V
5	MS_DATA

6	MS_CLK
---	--------

2.26 VGA Display Connector(CN14)

Pin	Signal	Pin	Signal
1	RED	2	+5V
3	GREEN	4	GND
5	BLUE	6	N.C
7	N.C	8	DDCDAT
9	GND	10	HSYNC
11	GND	12	VSYNC
13	GND	14	DDCCLK
15	GND	16	GND

2.27 TTL_LCD Connector(CN15)

Pin	Signal	Pin	Signal
1	+5V	2	+5V
3	GND	4	GND
5	+3.3V	6	+3.3V
7	ENBKL	8	GND
9	BLUE0	10	BLUE1
11	BLUE2	12	BLUE3
13	BLUE4	14	BLUE5
15	BLUE6	16	BLUE7
17	GREEN0	18	GREEN1

19	GREEN2	20	GREEN3
21	GREEN4	22	GREEN5
23	GREEN6	24	GREEN7
25	RED0	26	RED1
27	RED2	28	RED3
29	RED4	30	RED5
31	RED6	32	RED7
33	GND	34	GND
35	DOT_CLOCK	36	VSYNC
37	DE	38	HSYNC
39	N.C	40	ENAVEE

2.28 LVDS Connector(CN17)

Pin	Signal	Pin	Signal
1	LVDS_TX1+	2	LVDS_TX1-
3	GND	4	GND
5	LVDS_TXCLK+	6	LVDS_TXCLK-
7	GND	8	PPVCC
9	PPVCC	10	PPVCC
11	LVDS_TX2+	12	LVDS_TX2-
13	GND	14	GND
15	LVDS_TX0+	16	LVDS_TX0-
17	LVDS_TX3+	18	LVDS_TX3-
19	ENBKL	20	N.C

2.29 TV_Out Connector(CN18)

Pin	Signal	Pin	Signal
-----	--------	-----	--------

1	Y	2	CVBS
3	GND	4	GND
5	C	6	N.C
7	GND	8	N.C

2.30 Fan Connectors(CN19/CN20)

You can attach two coolers on the CPU and the chassis respectively to diffuse heat more efficiently. The pin assignments of the two fan connectors are identical. See the following table for details.

Pin	Signal
1	GND
2	+12V
3	Speed Sense

2.31 Front Panel Connector(CN21)

Pin	Signal	Pin	Signal
1	Power On Button (-)	2	Power On Button (+)
3	IDE LED (-)	4	IDE LED (+)
5	External Buzzer (-)	6	External Buzzer (+)
7	Power LED (-)	8	Power LED (+)
9	Reset Switch (-)	10	Reset Switch (+)

2.32 EIDE Connector(IDE1)

You can attach up to two Enhanced Integrated Device Electronics hard disk drives to IDE1. The IDE controller of PCM-6897/L uses a PCI local bus interface. This advanced interface supports faster data transfer.

Connecting the hard drive

Wire number 1 on the cable is normally red or blue, and the other wires are usually gray.

1. Connect one end of the cable to IDE1. Make sure that the red wire corresponds to pin 1 on the connector
2. Plug the other end of the cable to the Enhanced IDE hard drive, with pin 1 on the cable corresponding to pin 1 on the hard drives. (See your hard drive's documentation for the location of the connector).

Connect a second drive with another connector on the cable as described above.

Pin	Signal	Pin	Signal
1	IDE RESET	2	GND
3	DATA7	4	DATA8
5	DATA6	6	DATA9
7	DATA5	8	DATA10
9	DATA4	10	DATA11
11	DATA3	12	DATA12
13	DATA2	14	DATA13
15	DATA1	16	DATA14
17	DATA0	18	DATA15
19	GND	20	N.C.
21	REQ	22	GND
23	IO WRITE	24	GND
25	IO READ	26	GND
27	IO READY	28	GND
29	DACK	30	GND
31	IRQ14	32	N.C.
33	ADDR1	34	UDMA DETECT
35	ADDR0	36	ADDR2

37	CS#1	38	CS#3
39	LED	40	GND

2.33 10/100Base-Tx Ethernet Connector(LAN1)

This 10/100Base-T Ethernet connector is a standard RJ-45 connector. The onboard Intel 815E Fast Ethernet controller supports 10Mb/s and 100 Mb/s N-way auto-negotiation operations.

Pin	Signal	Pin	Signal
1	TX+	2	TX-
3	RX+	4	Temp_GND
5	Temp_GND	6	RX-
7	Temp_GND	8	Temp_GND

Chapter

3

**Award
BIOS Setup**

3.1 System Test and Initialization

These routines test and initialize board hardware. If the routines encounter an error during the tests, you will either hear a few short beeps or see an error message on the screen. There are two kinds of errors: fatal and non-fatal. The system can usually continue the boot up sequence with non-fatal errors. Non-fatal error messages usually appear on the screen along with the following instructions:

Press <F1> to RESUME

Write down the message and press the F1 key to continue the boot up sequence.

System configuration verification

These routines check the current system configuration against the values stored in the CMOS memory. If they do not match, the program outputs an error message. You will then need to run the BIOS setup program to set the configuration information in memory.

There are three situations in which you will need to change the CMOS settings:

1. You are starting your system for the first time
2. You have changed the hardware attached to your system
3. The CMOS memory has lost power and the configuration information has been erased.

The PCM-6897/L CMOS memory has an integral lithium battery backup for data retention. However, you will need to replace the complete unit when it finally runs down.

3.2 Award BIOS Setup

Awards BIOS ROM has a built-in Setup program that allows users to modify the basic system configuration. This type of information is stored in battery-backed CMOS RAM so that it retains the Setup information when the power is turned off.

Entering setup

Power on the computer and press immediately. This will allow you to enter Setup.

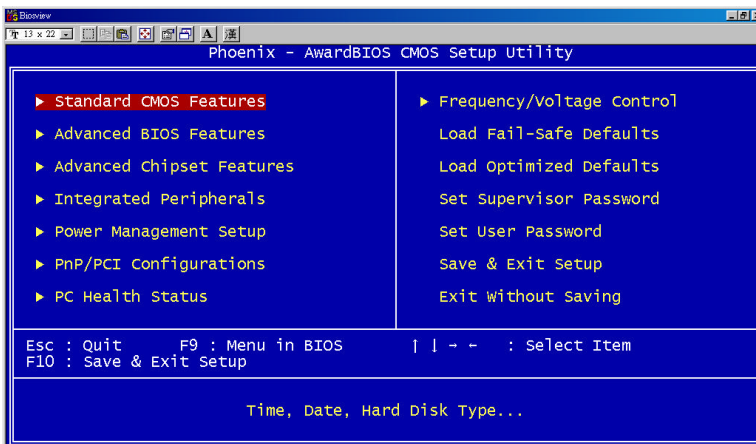

Standard CMOS Features

Use this menu for basic system configuration. (Date, time, IDE, etc.)

Advanced BIOS Features

Use this menu to set the advanced features available on your system.

Advanced Chipset Features

Use this menu to change the values in the chipset registers and optimize your system performance.

Integrated Peripherals

Use this menu to specify your settings for integrated peripherals. (Primary slave, secondary slave, keyboard, mouse etc.)

Power Management Setup

Use this menu to specify your settings for power management. (HDD power down, power on by ring, KB wake up, etc.)

PnP/PCI Configurations

This entry appears if your system supports PnP/PCI.

PC Health Status

This menu allows you to set the shutdown temperature for your system.

Frequency/Voltage Control

Use this menu to specify your settings for frequency/ voltage control.

Load Fail-Safe Defaults

Use this menu to load the BIOS default values for the minimal/stable performance for your system to operate.

Load Optimized Defaults

Use this menu to load the BIOS default values that are factory settings for optimal performance system operations. While AWARD has designated the custom BIOS to maximize performance, the factory has the right to change these defaults to meet their needs.

Set Supervisor/User Password

Use this menu to set Supervisor/User Passwords.

Save and Exit Setup

Save CMOS value changes to CMOS and exit setup.

Exit Without Saving

Abandon all CMOS value changes and exit setup.

3.3 Standard CMOS Features

When you choose the Standard CMOS Features option from the INITIAL SETUP SCREEN menu, the screen shown below is displayed. This standard Setup Menu allows users to configure system components such as date, time, hard disk drive, floppy drive and display. Once a field is highlighted, on-line help information is displayed in the right box of the Menu screen. Please note that PCM-6897 and PCM-6897 L differs in the display setting sections. The **LCD&CRT, Panel, TV Mode**, won't be shown in the bios of PCM-6897L.

PCM-6897

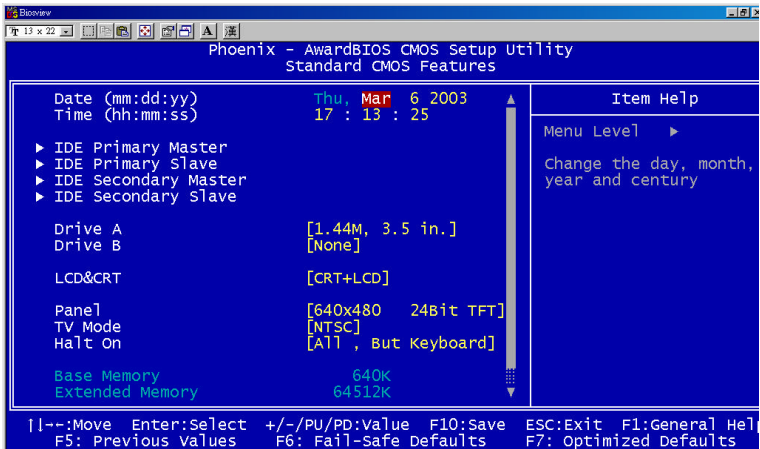

PCM-6897L

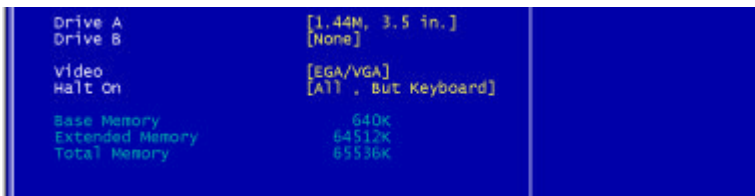

3.4 Advanced BIOS Features

By choosing the Advanced BIOS Features option from the INITIAL SETUP SCREEN menu, the screen below is displayed. This sample screen contains the manufacturer's default values for the PCM-6897/L.

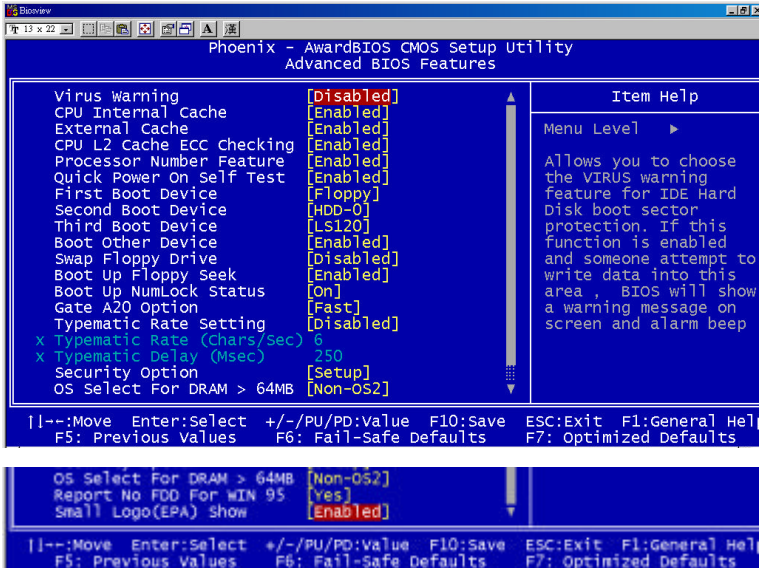

3.5 Advanced Chipset Features

By choosing the Advanced Chipset Features option from the INITIAL SETUP SCREEN menu, the screen below is displayed. This sample screen contains the manufacturer's default values for the PCM-6897/L.

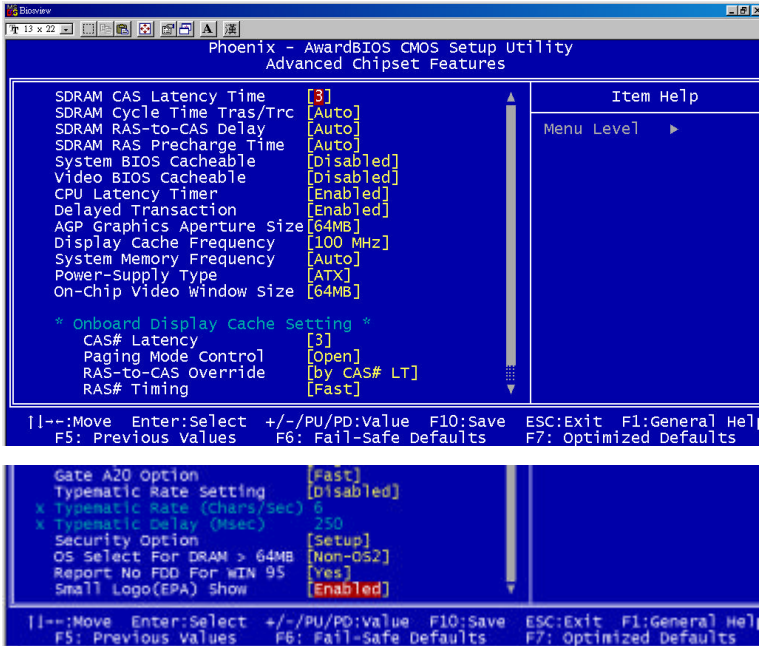

3.6 Integrated Peripherals

By choosing the Integrated Peripherals from the INITIAL SETUP SCREEN menu, the screen below is displayed. This sample screen contains the manufacturer's default values for the PCM-6897/L.

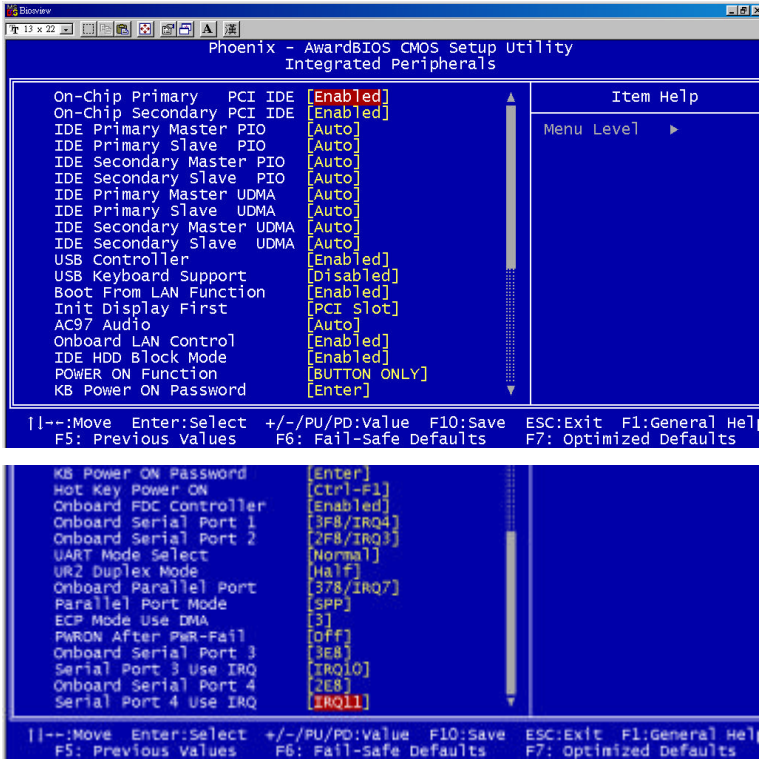

3.7 Power Management Setup

By choosing the Power Management Setup from the INITIAL SETUP SCREEN menu, the screen below is displayed. This sample screen contains the manufacturer's default values for the PCM-6897/L.

```

Phoenix - AwardBIOS CMOS Setup Utility
Power Management Setup

ACPI Function          [Enabled]
Power Management      [User Define]
Video Off Method      [DPMS]
Video Off In Suspend [Yes]
Suspend Type         [Stop Grant]
MODEM Use IRQ        [NA]
Suspend Mode         [Disabled]
HDD Power Down       [Disabled]
Soft-Off by PWR-BTTN [Instant-Off]
Wake-Up by PCI card  [Disabled]
Power On by Ring     [Enabled]
Resume by Alarm      [Disabled]
x Date(of Month) Alarm 0
x Time(hh:mm:ss) Alarm 0 : 0 : 0

** Reload Global Timer Events **
Primary IDE 0         [Disabled]
Primary IDE 1         [Disabled]
Secondary IDE 0       [Disabled]

[ ]--:Move Enter:Select +/-/PU/PD:Value F10:Save ESC:Exit F1:General Help
F5: Previous Values F6: Fail-Safe Defaults F7: Optimized Defaults
  
```

```

** Reload Global Timer Events **
Primary IDE 0         [Disabled]
Primary IDE 1         [Disabled]
Secondary IDE 0       [Disabled]
Secondary IDE 1       [Disabled]
FDD, COM, LPT Port    [Disabled]
PCI PIRQ[A-D]#       [Disabled]

[ ]--:Move Enter:Select +/-/PU/PD:Value F10:Save ESC:Exit F1:General Help
F5: Previous Values F6: Fail-Safe Defaults F7: Optimized Defaults
  
```

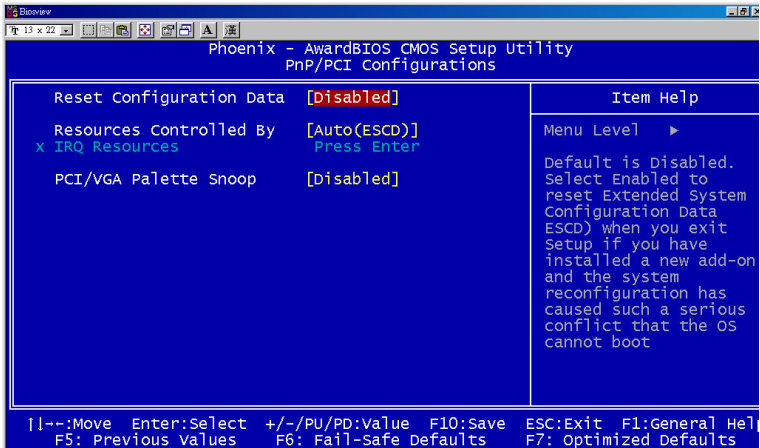

3.8 PnP/PCI Configurations

By choosing the PnP/PCI configurations from the Initial Setup Screen menu, the screen below is displayed. This sample screen contains the manufacturer's default values for the PCM-6897/L.

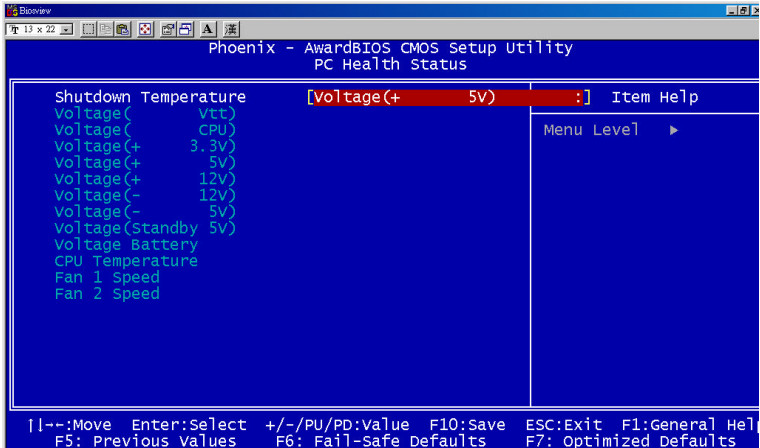

3.9 PC Health Status

By choosing the PC Health Status from the Initial Setup Screen menu, the screen below is displayed. This sample screen contains the manufacturer's default values for the PCM-6897/L.



3.10 Frequency/Voltage Control

By choosing the Frequency/Voltage Control from the Initial Setup Screen menu, the screen below is displayed. This sample screen contains the manufacturer's default values for the PCM-6897/L.

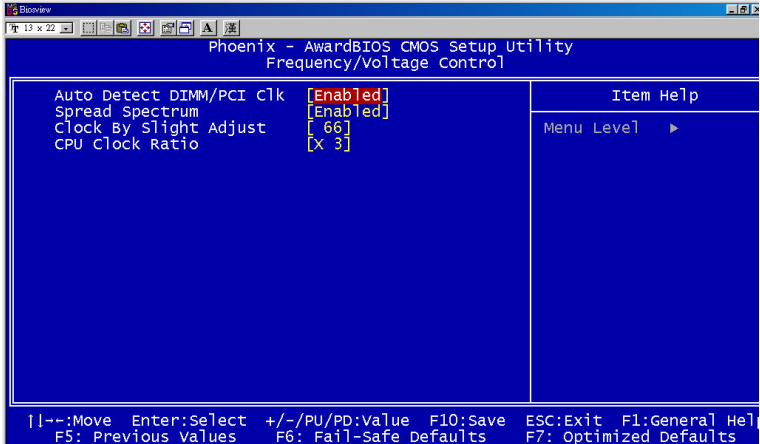

3.11 Load Fail-Safe Defaults

When you press <Enter> on this item you get a confirmation dialog box with a message similar to:

Load Fail-Safe Default (Y/N)?

Pressing "Y" loads the BIOS default values for the most stable, minimal performance system operations.

3.12 Load Optimized Defaults

When you press <Enter> on this item you get a confirmation dialog box with a message similar to:

Load Optimized Defaults (Y/N)?

Pressing "Y" loads the default values that are manufacturer's settings for optimal performance system operations.

3.13 Set Supervisor/User Password

You can set either SUPERVISOR or USER PASSWORD, or both of them. The difference between the two is that the supervisor password allows unrestricted access to enter and change the options of the setup menus, while the user password only allows entry to the program, but not modify options.

To abort the process at any time, press Esc.

In the Security Option item in the BIOS Features Setup screen, select System or Setup:

System Enter a password each time the system boots and whenever you enter Setup.

Setup Enter a password whenever you enter Setup.

NOTE: To clear the password, simply press Enter when asked to enter a password. Then the password function is disabled.

3.14 Save & Exit Setup

If you select this option and press <Enter>, the values entered in the setup utilities will be recorded in the chipset's CMOS memory. The microprocessor will check this every time you turn on your system and compare this to what it finds as it checks the system. This record is required for the system to operate.

3.15 Exit without saving

Selecting this option and pressing <Enter> lets you exit the Setup program without recording any new values or changing old ones.

Chapter

4

**Driver
Installation**

PCM-6897/L comes with a CD-ROM which contains most of drivers and utilities you will need.

There is several installation ways depends on the driver package under different Operating System application.

We recommend that the system driver installation procedure must be performed first.

If you utilize Windows NT series OS, you are strongly recommended to download the latest version Windows NT Service Pack from Microsoft website and install it before installing any driver.

4.1 Installation 1:

Applicable for Windows 9x/ME/NT 4.0

1. Insert the PCM-6897/L CD-ROM into the CD-ROM Drive.
2. From the CD-ROM, select the desired component Driver folder, select the desired Operation System folder to double click on the Setup.exe icon. A driver installation screen will appear.
(Notice: take VGA driver installation under Windows 98 for example, choose the corresponding folder depending on your OS)
3. A driver installation screen will appear, please follow the onscreen instructions to install the driver in sequence and click on the Next button.
(Notice: In some cases the system will ask you to insert Windows 98 CD ROM and key in its path. Then click on the OK button to key in path.)
4. Click on the **Finish** button to finish installation process. And allow the system to reboot.

4.2 Installation 2:

Applicable for Windows 9x/ME

1. Insert the **PCM-6897/L CD-ROM** into the CD-ROM Drive.
2. Click on **Start** button, select the **Settings**, then click on the **Control Panel** icon.
3. Double click on the **Add/Remove Hardware** icon and **Add New Hardware Wizard** will appear. Click on the **Next** button.
4. Select **Search for the best driver for your device (Recommended)** and click on the **Next** button.
5. Select **Specify a location**, click on **Have Disk** button then key in the CD-ROM path and specify component drivers and OS folders. Then click on the **Next** button.
6. The Wizard shows that Windows driver file search for the device. Click on the **Next** button.
7. The system will ask you to insert Windows 98 CD-ROM. Click on the **OK** button to insert CD-ROM and key in path.
8. Click on the **OK** button.
9. Click on the **Finish** button to finish installation process. And allow the system to reboot.

4.3 Installation 3:

Applicable for Windows NT 4.0

1. Insert the **PCM-6897/L CD-ROM** into the CD-ROM Drive.
2. Start system with Windows NT 4.0 installed.
IMPORTANT: When the "Please select the operating system to start..." message is displayed, select "Windows NT Workstation Version 4.00 [VGA mode]".
3. From **Start**, select the **Settings group**, then click on the **Control Panel** icon.
4. In the **Control Panel**, select the desired device and click on the icon.
5. Follow the step-by-step instruction and click on **OK** button.
6. Click on the **Have Disk...** button.
7. Key in CD-ROM path and specify component drivers, then click on the **OK** button.
8. From the list of displayed devices, select your desired device.
9. If a message appears stating the driver is already installed on the system, and asks if you want to use the current or new drivers, be sure to select the **New** button.
10. If prompted for the driver diskette a second time, click on the **Continue** button.
(Notice: In some cases the system will ask you to insert Windows NT CD-ROM. Follow its instructions to complete the setup procedures.)
11. When the message "**The drivers were successfully installed**" is displayed, remove the display driver diskette, then click on the **OK** button.
12. Reboot the system.

Appendix

A

Programming the Watchdog Timer

A.1 Watchdog timer of PCM-6897/L

PCM-6897/L utilizes ITE 8712 chipset as its watchdog timer controller. Below are the procedures to complete its configuration and the AAeon initial watchdog timer program is also attached based on which you can develop customized program to fit your application.

A.2 Configuring sequence description

After the hardware reset or power-on reset, the ITE 8712 enters the normal mode with all logical devices disabled except KBC. The initial state (enable bit) of this logical device (KBC) is determined by the state of pin 121 (DTR1#) at the falling edge of the system reset during power-on reset.

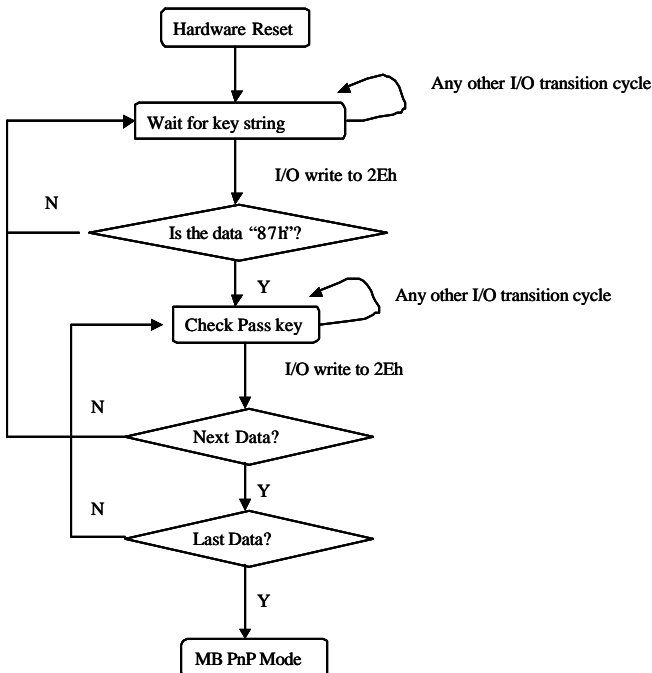

There are three steps to complete the configuration setup: **(1) Enter the MB PnP Mode; (2) Modify the data of configuration registers; (3) Exit the MB PnP Mode.** Undesired result may occur if the MB PnP Mode is not exited normally.

(1) Enter the MB PnP Mode

To enter the MB PnP Mode, four special I/O write operations are to be performed during Wait for Key state. To ensure the initial state of the key-check logic, it is necessary to perform four write operations to the Special Address port (2EH). Two different enter keys are provided to select configuration ports (2Eh/2Fh) of the next step.

	Address Port	Data Port
87h, 01h, 55h, 55h:	2Eh	2Fh

(2) Modify the Data of the Registers

All configuration registers can be accessed after entering the MB PnP Mode. Before accessing a selected register, the content of Index 07h must be changed to the LDN to which the register belongs, except some Global registers.

(3) Exit the MB PnP Mode

Set bit 1 of the configure control register (Index=02h) to **1** to exit the MB PnP Mode.

WatchDog Timer Configuration Registers

LDN	Index	R/W	Reset	Configuration Register or Action
All	02H	W	N/A	Configure Control
07H	71H	R/W	00H	WatchDog Timer Control Register
07H	72H	R/W	00H	WatchDog Timer Configuration Register
07H	73H	R/W	00H	WatchDog Timer Time-out Value Register

Configure Control (Index=02h)

This register is write only. Its values are not sticky; that is to say, a hardware reset will automatically clear the bits, and does not require the software to clear them.

Bit	Description
7-2	Reserved
1	Returns to the Wait for Key state. This bit is used when the configuration sequence is completed
0	Resets all logical devices and restores configuration registers to their power-on states.

WatchDog Timer Control Register (Index=71h, Default=00h)

Bit	Description
7	WDT is reset upon a CIR interrupt
6	WDT is reset upon a KBC (mouse) interrupt
5	WDT is reset upon a KBC (keyboard) interrupt
4	WDT is reset upon a read or a write to the Game Port base address
3-2	Reserved
1	Force Time-out. This bit is self-clearing
0	WDT Status 1: WDT value reaches 0. 0: WDT value is not 0

WatchDog Timer Configuration Register (Index=72h, Default=00h)

Bit	Description
7	WDT Time-out value select 1: Second 0: Minute

- 6 WDT output through KRST (pulse) enable
- 5-4 Reserved
- 3-0 Select the interrupt level^{Note} for WDT

WatchDog Timer Time-out Value Register (Index=73h, Default=00h)

Bit	Description
7-0	WDT Time-out value 7-0

A.3 IT8712 initial WatchDog timer program

```
MODEL SMALL
```

```
.CODE
```

Main:

```
CALL Enter_Configuration_mode
```

```
CALL Check_Chip
```

```
mov cl, 7
```

```
call Set_Logic_Device
```

```
;time setting
```

```
mov cl, 10 ; 10 Sec
```

```
dec al
```

Watch_Dog_Setting:

```
;Timer setting
```

```
mov al, cl
```

```
mov cl, 73h
```

```
call    Superio_Set_Reg

;Clear by keyboard or mouse interrupt
mov    al, 0f0h
mov    cl, 71h
call    Superio_Set_Reg
;unit is second.

mov    al, 0C0H
mov    cl, 72h
call    Superio_Set_Reg

; game port enable
mov    cl, 9
call    Set_Logic_Device

Initial_OK:
CALL    Exit_Configuration_mode
MOV    AH, 4Ch
INT    21h

Enter_Configuration_Mode PROC NEAR
MOV    SI, WORD PTR CS:[Offset Cfg_Port]
```

```
MOV    DX,02Eh
MOV    CX,04h
Init_1:
MOV    AL,BYTE PTR CS:[SI]
OUT    DX,AL
INC    SI
LOOP   Init_1
RET

Enter_Configuration_Mode  ENDP
Exit_Configuration_Mode  PROC  NEAR
MOV    AX,0202h
CALL   Write_Configuration_Data
RET

Exit_Configuration_Mode  ENDP

Check_Chip PROC  NEAR

MOV    AL,20h
CALL   Read_Configuration_Data
CMP    AL,87h
JNE    Not_Initial

MOV    AL,21h
CALL   Read_Configuration_Data
```

CMP AL,12h

JNE Not_Initial

Need_Initial:

STC

RET

Not_Initial:

CLC

RET

Check_Chip ENDP

Read_Configuration_Data PROC NEAR

MOV DX,WORD PTR CS:[Cfg_Port+04h]

OUT DX,AL

MOV DX,WORD PTR CS:[Cfg_Port+06h]

IN AL,DX

RET

Read_Configuration_Data ENDP

Write_Configuration_Data PROC NEAR

MOV DX,WORD PTR CS:[Cfg_Port+04h]

OUT DX,AL

XCHG AL,AH

MOV DX,WORD PTR CS:[Cfg_Port+06h]

```
OUT    DX,AL
RET
Write_Configuration_Data  ENDP
Superio_Set_Reg  proc    near
push   ax
MOV    DX,WORD PTR CS:[Cfg_Port+04h]
mov    al,cl
out    dx,al
pop    ax
inc    dx
out    dx,al
ret
Superio_Set_Reg  endp
Set_Logic_Device    proc    near
push   ax
push   cx
xchg  al,cl
mov   cl,07h
call  Superio_Set_Reg
pop   cx
pop   ax
ret
Set_Logic_Device    endp
```

;Select 02Eh->Index Port, 02Fh->Data Port

Cfg_Port DB 087h,001h,055h,055h

DW 02Eh,02Fh

END Main

Note: Interrupt level mapping

0Fh-Dh: not valid

0Ch: IRQ12

.

.

.

03h: IRQ3

02h: not valid

01h: IRQ1

00h: no interrupt selected

Appendix

B

Optional Extras

B.1 PCM-10689-1 Wiring Kit

The cable kit PCM-10689-1 includes the following cables:

P/N	Description	Termination Connector
1701400453	3.5" IDE cable	2.54mm/40-PIN
1701340600	Dual Floppy cable, 3.5" and 5.25"	2.00mm/34-PIN
1701400180	Serial Port cable	2.54mm/40-PIN
1701260308	Parallel Port cable	2.00mm/25-PIN to 26-PIN
1701160152	VGA CRT cable	2.54mm/15-PIN to 16-PIN
1700080204	Keyboard and Mouse cable	2.54mm, two 6-PIN mini DIN Header
1700140510	Audio cable	2.00mm/14-PIN
1709100201	USB cable	2.00mm/10-PIN