

**Compact Board**

**PCM-6892 Rev.B**

**PCM-6892 Rev.B**

Intel® ULV Celeron®

400 / 650 MHz Processor

Compact Board

With LCD, Ethernet, TV-Out,

Mini PCI, Speaker out

## Copyright Notice

This document is copyrighted, 2005. All rights are reserved. The original manufacturer reserves the right to make improvements to the products described in this manual at any time without notice.

No part of this manual may be reproduced, copied, translated, or transmitted in any form or by any means without the prior written permission of the original manufacturer. Information provided in this manual is intended to be accurate and reliable. However, the original manufacturer assumes no responsibility for its use, or for any infringements upon the rights of third parties that may result from its use.

The material in this document is for product information only and is subject to change without notice. While reasonable efforts have been made in the preparation of this document to assure its accuracy, AAEON assumes no liabilities resulting from errors or omissions in this document, or from the use of the information contained herein.

AAEON reserves the right to make changes in the product design without notice to its users.

## Acknowledgments

All other product s' name or trademarks are properties of their respective owners.

- Award is a trademark of Award Software International, Inc.
- CompactFlash™ is a trademark of the Compact Flash Association.
- Intel®, Pentium® and Celeron® are trademarks of Intel® Corporation.
- Microsoft Windows® is a registered trademark of Microsoft Corp.
- ITE is a trademark of Integrated Technology Express, Inc.
- IBM, PC/AT, PS/2, and VGA are trademarks of International Business Machines Corporation.
- SoundBlaster is a trademark of Creative Labs, Inc.

## Packing List

Before you begin installing your card, please make sure that the following materials have been shipped:

- 1 PCM-6892 Rev. B CPU Card
- 1 Jumper cap
- 1 Quick Installation Guide
- 1 CD-ROM for manual (in PDF format) and drivers

If any of these items should be missing or damaged, please contact your distributor or sales representative immediately.

# Contents

## Chapter 1 General Information

1.1 Introduction .....	1-2
1.2 Features .....	1-4
1.3 Specifications .....	1-5

## Chapter 2 Quick Installation Guide

2.1 Safety Precautions .....	2-2
2.2 Location of Connectors and Jumpers .....	2-3
2.3 Mechanical Drawing.....	2-5
2.4 List of Jumpers .....	2-7
2.5 List of Connectors .....	2-8
2.6 Setting Jumpers.....	2-10
2.7 Audio Out Selection (JP1) .....	2-11
2.8 LCD Voltage Selection (JP2) .....	2-11
2.9 TTL_LCD Clock Selection (JP3) .....	2-11
2.10 Clear CMOS (JP4) .....	2-12
2.11 COM2 Ring / +5V / +12V Selection (JP5) .....	2-12
2.12 TV-Out Connector (CN1) .....	2-12
2.13 TTL_LCD Connector (CN2) .....	2-13
2.14 VGA Display Connector (CN4) .....	2-14
2.15 ATX Power Connector (CN5) .....	2-14
2.16 TTL_LCD Connector(CN6) .....	2-15
2.17 LVDS Connector (CN7) .....	2-16

2.18 LAN1 LED Connector(CN8) .....	2-16
2.19 LAN2 LED Connector (CN9) .....	2-17
2.20 Audio Connector (CN10).....	2-17
2.21 COM1~4 Connector (CN11) .....	2-18
2.22 USB Connector (CN12) .....	2-19
2.23 IrDA Connector (CN14) .....	2-19
2.24 Fan Connector (CN15).....	2-20
2.25 PS/2 Keyboard & Mouse Connector (CN16) .....	2-20
2.26 Front Panel Connector(CN17) .....	2-20

## Chapter 3 Award BIOS Setup

3.1 System Test and Initialization. ....	3-2
3.2 Award BIOS Setup.....	3-3
3.3 Standard CMOS Features .....	3-6
3.4 Advanced BIOS Features .....	3-7
3.5 Advanced Chipset Features .....	3-8
3.6 Integrated Peripherals .....	3-9
3.7 Power management Setup.....	3-11
3.8 PnP/PCI configuration .....	3-12
3.9 PC Health Status.....	3-13
3.10 Frequency / Voltage control.....	3-14
3.11 Load Fail-Safe Defaults .....	3-15
3.12 Load Optimized Defaults.....	3-16
3.13 Set Supervisor / User Password .....	3-17
3.14 Save & Exit Setup.....	3-18
3.15 Exit without saving .....	3-19

## Chapter 4 Driver Installation

4.1 Step 1 – Install VIA 4 in 1 Driver .....	4-3
4.2 Step 2 – Install Graphic Driver.....	4-3
4.3 Step 3 – Install Audio Driver .....	4-3
4.4 Step 4 – Install Ethernet Driver .....	4-4
4.5 Step 5 – Install PCMCIA Driver (Win 98 only) .....	4-4

## Appendix A I/O Information

A.1 I/O Address Map .....	A-2
A.2 1 <sup>st</sup> MB Memory Address Map .....	A-2
A.3 IRQ Mapping Chart .....	A-3
A.4 DMA Channel Assignments .....	A-3

## Appendix B Programming The Watchdog Timer

B.1 Programming the Watchdog Timer .....	B-2
--	-----

**Chapter**

**1**

**General  
Information**



## **1.1 Introduction**

---

PCM-6892 Rev. B is the extension of PCM-6892 Rev. A. This model possess all features in Rev. A but the only difference Intel® Ultra Low Voltage Celeron® 400/650MHz processor was introduced into Rev. B. With the processor, PCM-6892 Rev. B will own more excellent performance and lower power consumption than PCM-6892 Rev. A.

### **More options for your extension**

Compared with PCM-6892 Rev. A, the new PCM-6892 Rev. B owns Mini PCI slot. Mini PCI has the excellent ability for extension in your application. Therefore, Mini PCI can go with the extension devices such as Gigabit LAN, USB 2.0 or IEEE 1394 to pander the diverse applications.

### **Marvelous Graphic Accelerator**

VIA VT8606 built in 2D / 3D Graphic Accelerator can offer the high-resolution display quality and support 18/36 bit TTL or LVDS LCD Display, TV out. VIA VT8606 is a superior chipset with all kinds of integrations. Besides, the model is also integrated few functions such as Dual Ethernet, Audio, USB, Serial port, Parallel port and etc. Mentioned above is sufficient for your application. With 2 slots PCMCIA and Mini PCI plug, you can make a choice depend on your application and need.

### **High performance and Low power consumption**

Overall, PCM-6892 Rev. B provides an operating environment with low power consumption and multi-functions. The compact size and flexible

expand interface will be the best choice for the embedded application which has the severe condition for the space and environment.

## 1.2 Features

---

- Intel® Ultra Low Voltage Celeron 400 / 650 CPU onboard
- Support 18 / 36 bit TTL/LVDS TFT Panel
- Mini PCI Slot
- Support Type II PCMCIA Slot (Optional)
- 4 COMs / 4USB / CFD

### 1.3 Specifications

---

#### System

- CPU: Onboard Intel® Ultra Low Voltage Celeron® 400 /650MHz Processor
- Memory: Onboard one 168-pin DIMM socket support up to 512MB SDRAM
- Chipset: VIA VT8606 / VT82C686B
- BIOS: Award 256KB Flash BIOS
- Enhanced IDE: Supports up to two IDE devices. Support Ultra DMA100 mode with transfer rate up to 100MB / sec.
- FDD Interface: Support up to two floppy disk drives, 5.25 inch (360KB and 1.2 MB) and/or 3.5 inch (720KB, 1.44MB and 2.88MB)
- Parallel Port: One bi-directional parallel port. Support SPP, ECP and EPP modes.
- Serial Port: Three RS-232 serial ports and one RS-232 /422 / 485 serial ports. Ports can be configured as COM1, COM2, COM3, COM4 or disable individually. (16C550 equivalent)
- IrDA port: Support one IrDA Tx /Rx header
- KB / Mouse connector:

- USB connector: Support four USB 1.1 ports
- Battery: Lithium battery for data retention
- Watchdog timer: Can generate a system reset.
- Power Management: Support ATX or AT power supply.  
Support power saving standby modes.

## Display

Support CRT and LCD simultaneous/Independent display

- Chipset: VIA VT8606
- Memory size: Shared system memory up to 32 MB
- Resolutions: Up to 1600 X 1200 @ 16bpp for CRT
- Display Type: Support 18 / 36 bit TTL / dual channel LVDS TFT LCD. Can display CRT and flat panel simultaneously.
- TV-Out Interface: VIA 1621 support NTSC / PAL composite outputs

## I/O

- MIO: IDE (UDMA33) x 1, FDD x 1, KB + Mouse x 1, RS-232 x 3,

- IrDA: RS-232/422/485 x 1, Parallel x 1  
One IrDA Tx/Rx header
- Audio: VIA VT82C686B with AC-97 2.0  
compliant audio codec VT1612
- USB: Two 5x2 pin headers support 4 USB  
1.1 ports

## Chapter

# 2

## Quick Installation Guide

*Notice:*

*The Quick Installation Guide is derived from Chapter 2 of user manual. For other chapters and further installation instructions, please refer to the user manual CD-ROM that came with the product.*



## 2.1 Safety Precautions

---

**Warning!**

*Always completely disconnect the power cord from your board whenever you are working on it. Do not make connections while the power is on, because a sudden rush of power can damage sensitive electronic components.*

**Caution!**

*Always ground yourself to remove any static charge before touching the board. Modern electronic devices are very sensitive to static electric charges. Use a grounding wrist strap at all times. Place all electronic components on a static-dissipative surface or in a static-shielded bag when they are not in the chassis*



## 2.2 Location of Connectors and Jumpers

### Component Side

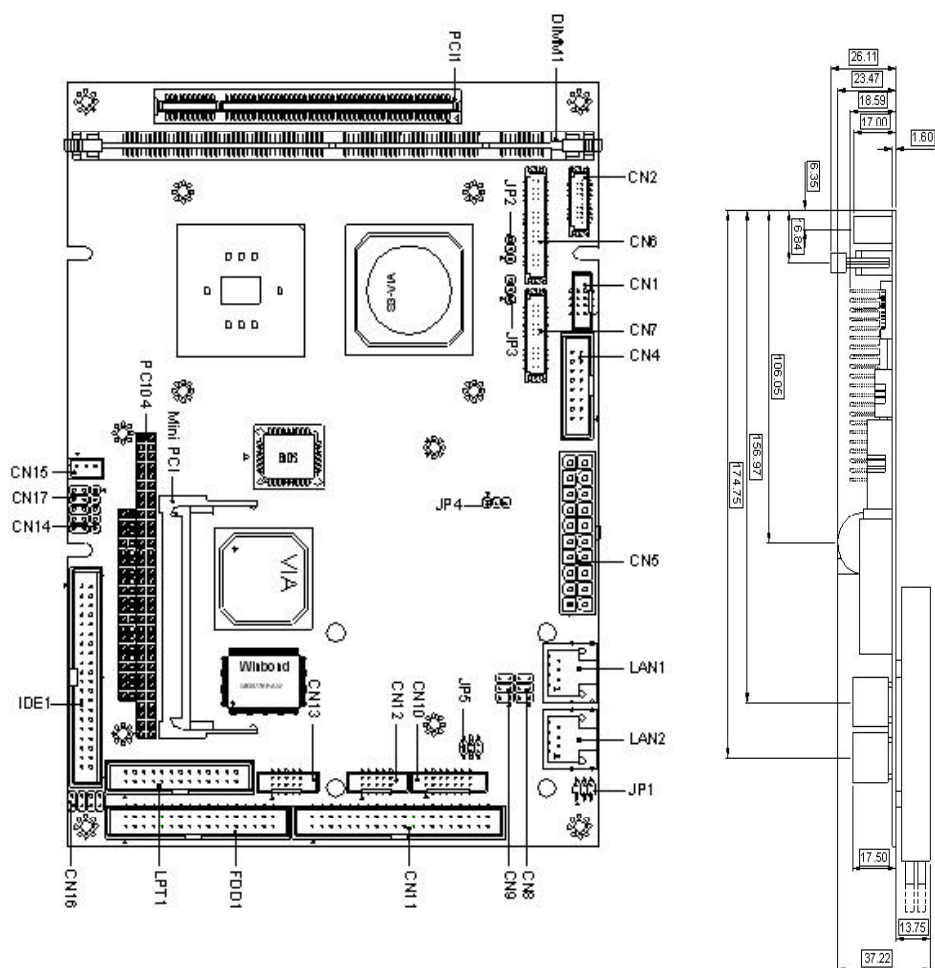

## Solder Side

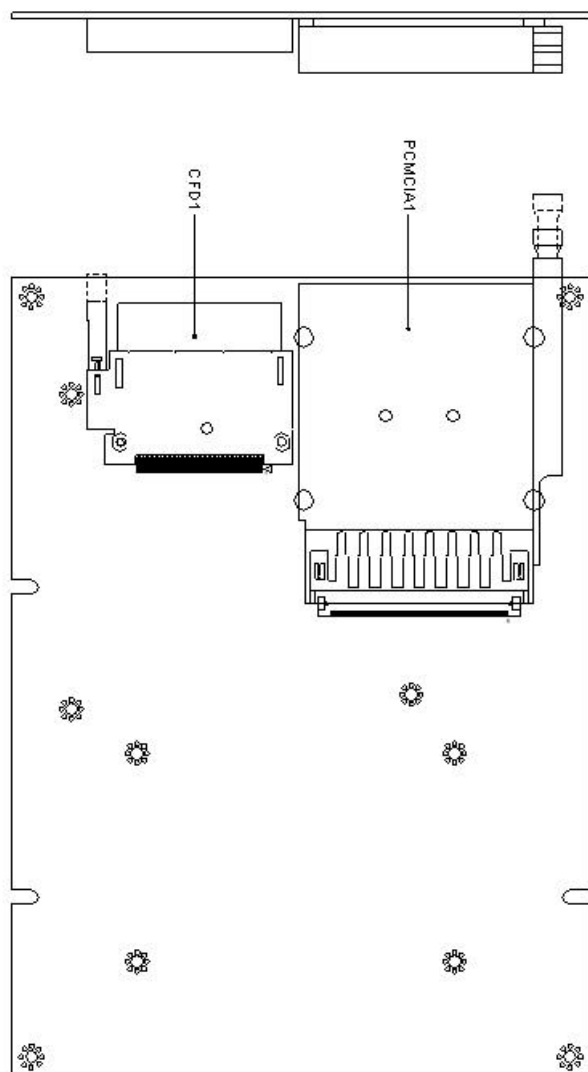



## Solder Side

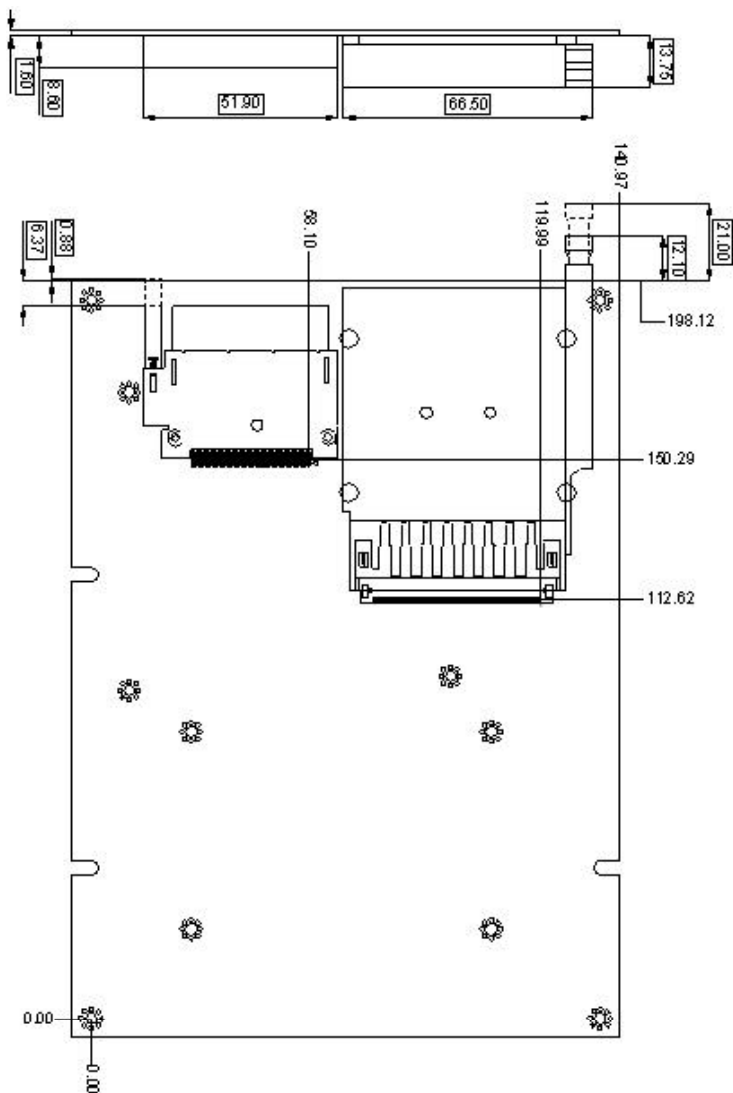

## 2.4 List of Jumpers

---

There are a number of jumpers in the board that allow you to configure your system to suit your application.

The table below shows the function of each jumper in the board:

### Jumpers

<b>Label</b>	<b>Function</b>
JP1	Audio Out Selection
JP2	LCD Voltage Selection
JP3	TTL-LCD Clock Selection
JP4	Clear CMOS
JP5	COM2 Ring/+5V/+12V Selection

## 2.5 List of Connectors

---

There are a number of connectors in the board that allow you to configure your system to suit your application. The table below shows the function of each connector in the board:

### Connectors

Label	Function
CN1	TV_Out Connector
CN2	TTL_LCD Connector (DF-13 10 x 2)
CN4	VGA Display Connector
CN5	ATX Power Connector
CN6	TTL_LCD Connector (DF-13 20 x 2)
CN7	LVDS_LCD Connector (DF-13 15 x 2)
CN8	LAN1 LED Connector
CN9	LAN2 LED Connector
CN10	Audio Connector
CN11	COM1-4 Connector
CN12	USB0/1 Connector
CN13	USB2/3 Connector
CN14	IrDA Connector
CN15	Fan Connector
CN16	PS/2 Keyboard/Mouse Connector
CN17	Front Panel Connector
FDD-1	Floppy Connector

---

IDE1	EIDE Connector
LPT1	LPT Port Connector
LAN1	10/100 or 100/1000Base-Tx Ethernet Connector
LAN2	10/100 or 100/1000Base-Tx Ethernet Connector
PCI1	PCI Slot
MPCI1	Mini PCI Slot
PCMCIA1	PCMCIA Slot
CFD1	CompactFlash Slot
P104-AB	PC/104 Connector
P104-CD	PC-104 Connector
DIMM1	DIMM Slot

---

## 2.6 Setting Jumpers

---

You configure your card to match the needs of your application by setting jumpers. A jumper is the simplest kind of electric switch. It consists of two metal pins and a small metal clip (often protected by a plastic cover) that slides over the pins to connect them. To “close” a jumper you connect the pins with the clip.

To “open” a jumper you remove the clip. Sometimes a jumper will have three pins, labeled 1, 2 and 3. In this case you would connect either pins 1 and 2 or 2 and 3.

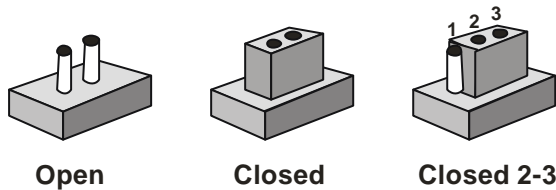

A pair of needle-nose pliers may be helpful when working with jumpers.

If you have any doubts about the best hardware configuration for your application, contact your local distributor or sales representative before you make any change.

Generally, you simply need a standard cable to make most connections.



## 2.7 Audio Out Selection (JP1)

---

JP1	Function
1-3, 2-4	W/O Amplifier
3-5, 4-6	W/ Amplifier (Default)

---

## 2.8 LCD Voltage Selection (JP2)

---

JP2	Function
1-2	+5V
2-3	+3.3V (Default)

---

## 2.9 TTL-LCD Clock Selection (JP3)

---

JP3	Function
1-2	CLK (Default)
2-3	Reverse CLK

---

## 2.10 Clear CMOS (JP4)

---

JP4	Function
1-2	Protected (Default)
2-3	Clear

## 2.11 COM2 Ring/+5V/+12V Selection (JP5)

---

JP5	Function
1-2	+12V
3-4	+5V
5-6	Ring (Default)

## 2.12 TV-Out Connector (CN1)

---

Pin	Signal	Pin	Signal
1	Y	2	CVBS
3	GND	4	GND
5	C	6	N.C.
7	GND	8	N.C.

### 2.13 TTL\_LCD Connector (CN2)

---

Pin	Signal	Pin	Signal
1	GND	2	GND
3	BLUE10	4	BLUE11
5	BLUE12	6	BLUE13
7	BLUE14	8	BLUE15
9	GREEN10	10	GREEN11
11	GREEN12	12	GREEN13
13	GREEN14	14	GREEN15
15	RED10	16	RED11
17	RED12	18	RED13
19	RED14	20	RED15

## 2.14 VGA Display Connector (CN4)

---

Pin	Signal	Pin	Signal
1	RED	2	VGAVCC
3	GREEN	4	GND
5	BLUE	6	N.C.
7	N.C.	8	SDATA
9	GND	10	H
11	GND	12	V
13	GND	14	SCLK
15	GND	16	N.C.

## 2.15 ATX Power Connector (CN5)

---

Pin	Signal	Pin	Signal
1	+3.3V	11	+3.3V
2	+3.3V	12	-12V
3	GND	13	GND
4	+5V	14	PS_ON
5	GND	15	GND
6	+5V	16	GND
7	GND	17	GND
8	POWER OK	18	-5V
9	+5VSB	19	+5V
10	+12V	20	+5V

## 2.16 TTL\_LCD Connector (CN6)

---

Pin	Signal	Pin	Signal
1	+5V	2	+5V
3	GND	4	GND
5	+3.3V	6	+3.3V
7	ENBKL	8	GND
9	BLUE0	10	BLUE1
11	BLUE2	12	BLUE3
13	BLUE4	14	BLUE5
15	BLUE6	16	BLUE7
17	GREEN0	18	GREEN1
19	GREEN2	20	GREEN3
21	GREEN4	22	GREEN5
23	GREEN6	24	GREEN7
25	RED0	26	RED1
27	RED2	28	RED3
29	RED4	30	RED5
31	RED6	32	RED7
33	GND	34	GND
35	DOT_CLOCK	36	VSYNC
37	DE	38	HSYNC
39	N.C.	40	ENAE

## 2.17 LVDS Connector (CN7)

---

Pin	Signal	Pin	Signal
1	ENBKL	2	BKLCTL
3	PPVCC	4	GND
5	LVDS_CH1_TXCLK-	6	LVDS_CH1_TXCLK+
7	PPVCC	8	GND
9	LVDS_CH1_TX0-	10	LVDS_CH1_TX0+
11	LVDS_CH1_TX1-	12	LVDS_CH1_TX1+
13	LVDS_CH1_TX2-	14	LVDS_CH1_TX2+
15	N.C.	16	N.C.
17	I2C_DATA	18	I2C_CLK
19	LVDS_CH2_TX0-	20	LVDS_CH2_TX0+
21	LVDS_CH2_TX1-	22	LVDS_CH2_TX1+
23	LVDS_CH2_TX2-	24	LVDS_CH2_TX2+
25	N.C.	26	N.C.
27	PPVCC	28	GND
29	LVDS_CH2_TXCLK-	30	LVDS_CH2_TXCLK+

## 2.18 LAN1 LED Connector (CN8)

---

Pin	Signal	Pin	Signal
1	RX LED	2	+3.3V
3	Link LED	4	+3.3V
5	TX LED	6	+3.3V

## 2.19 LAN2 LED Connector (CN9)

---

Pin	Signal	Pin	Signal
1	RX LED	2	+3.3V
3	Link LED	4	+3.3V
5	TX LED	6	+3.3V

## 2.20 Audio Connector (CN10)

---

Pin	Signal	Pin	Signal
1	MIC_IN	2	MIC_+2.5V
3	LINE_IN_GND	4	CD_GND
5	LINE_IN_L	6	CD_IN_L
7	LINE_IN_R	8	CD_GND
9	LINE_IN_GND	10	CD_IN_R
11	LINE_OUT_L	12	LINE_OUT_R
13	LINE_OUT_GND	14	LINE_OUT_GND

## 2.21 COM1~4 Connector (CN11)

---

Pin	Signal	Pin	Signal
1	DCD1	2	DSR1
3	RXD1	4	RTS1
5	TXD1	6	CTS1
7	DTR1	8	RI1
9	COMGND	10	N.C.
11	DCD2	12	DSR2
13	RXD2	14	RTS2
15	TXD2	16	CTS2
17	DTR2	18	RI2
19	COMGND	20	N.C.
21	DCD3	22	DSR3
23	RXD3	24	RTS3
25	TXD3	26	CTS3
27	DTR3	28	RI3
29	COMGND	30	N.C.
31	DCD4	32	DSR4
33	RXD4	34	RTS4
35	TXD4	36	CTS4
37	DTR4	38	RI4
39	COMGND	40	N.C.



## 2.22 USB Connector (CN12)

---

Pin	Signal	Pin	Signal
1	+5V	2	GND
3	USBD0-	4	GND
5	USBD0+	6	USBD1+
7	GND	8	USBD1-
9	GND	10	+5V

Pin	Signal	Pin	Signal
1	+5V	2	GND
3	USBD2-	4	GND
5	USBD2+	6	USBD3+
7	GND	8	USBD3-
9	GND	10	+5V

## 2.23 IrDA Connector (CN14)

---

Pin	Signal
1	+5V
2	N.C.
3	IRRX
4	GND
5	IRTX

## 2.24 Fan Connector (CN15)

---

Pin	Signal
1	Speed Sense
2	+5V
3	GND

## 2.25 PS/2 Keyboard & Mouse Connector (CN16)

---

Pin	Signal	Pin	Signal
1	Keyboard DATA	2	Keyboard CLOCK
3	Keyboard GND	4	Keyboard VCC
5	Mouse DATA	6	Mouse CLOCK
7	N.C.	8	N.C.

## 2.26 Front Panel Connector (CN17)

---

Pin	Signal	Pin	Signal
1	Power On Button (-)	2	Power On Button (+)
3	IDE LED (-)	4	IDE LED (+)
5	External Buzzer (-)	6	External Buzzer (+)
7	Power LED (-)	8	Power LED (+)
9	Reset Switch (-)	10	Reset Switch (+)

**Chapter**

**3**

**Award  
BIOS Setup**

### 3.1 System test and initialization

---

These routines test and initialize board hardware. If the routines encounter an error during the tests, you will either hear a few short beeps or see an error message on the screen. There are two kinds of errors: fatal and non-fatal. The system can usually continue the boot up sequence with non-fatal errors. Non-fatal error messages usually appear on the screen along with the following instructions:

Press <F1> to RESUME

Write down the message and press the F1 key to continue the boot up sequence.

#### System configuration verification

These routines check the current system configuration against the values stored in the CMOS memory. If they do not match, the program outputs an error message. You will then need to run the BIOS setup program to set the configuration information in memory.

There are three situations in which you will need to change the CMOS settings:

1. You are starting your system for the first time
2. You have changed the hardware attached to your system
3. The CMOS memory has lost power and the configuration information has been erased.

The PCM-6892 REV.B CMOS memory has an integral lithium battery backup for data retention. However, you will need to replace the complete unit when it finally runs down.

## 3.2 Award BIOS Setup

---

Awards BIOS ROM has a built-in Setup program that allows users to modify the basic system configuration. This type of information is stored in battery-backed CMOS RAM so that it retains the Setup information when the power is turned off.

### Entering setup

Power on the computer and press <Del> immediately. This will allow you to enter Setup.

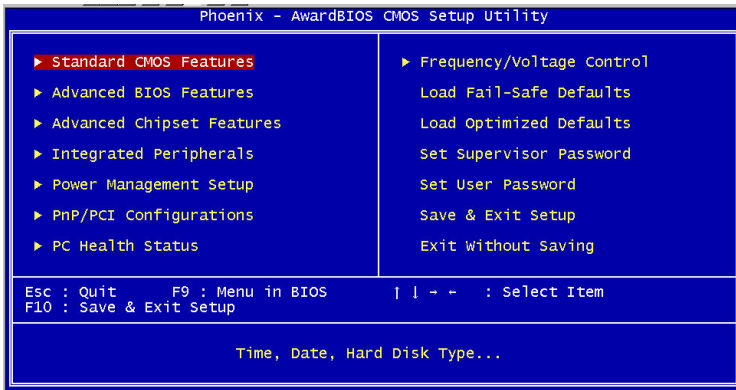

### Standard CMOS Features

Use this menu for basic system configuration. (Date, time, IDE, etc.)

### Advanced BIOS Features

Use this menu to set the advanced features available on your system.

### Advanced Chipset Features

Use this menu to change the values in the chipset registers and optimize your system performance.

## **Integrated Peripherals**

Use this menu to specify your settings for integrated peripherals. (Primary slave, secondary slave, keyboard, mouse etc.)

## **Power Management Setup**

Use this menu to specify your settings for power management. (HDD power down, power on by ring etc.)

## **PnP/PCI Configurations**

This entry appears if your system supports PnP/PCI.

## **PC Health Status**

This menu shows you the status of PC.

## **Frequency/Voltage Control**

This menu shows you the display of frequency/Voltage Control.

## **Load Fail-Safe Defaults**

Use this menu to load the BIOS default values for the minimal/stable performance for your system to operate.

## **Load Optimized Defaults**

Use this menu to load the BIOS default values that are factory settings for optimal performance system operations. While AWARD has designated the custom BIOS to maximize performance, the factory has the right to change these defaults to meet their needs.

## **Set Supervisor/User Password**

Use this menu to set Supervisor/User Passwords.

## **Save and Exit Setup**

Save CMOS value changes to CMOS and exit setup.

## **Exit Without Saving**

Abandon all CMOS value changes and exit setup.

### 3.3 Standard CMOS Features

When you choose the Standard CMOS Features option from the INITIAL SETUP SCREEN menu, the screen shown below is displayed. This standard Setup Menu allows users to configure system components such as date, time, hard disk drive, floppy drive and display. Once a field is highlighted, on-line help information is displayed in the right box of the Menu screen.

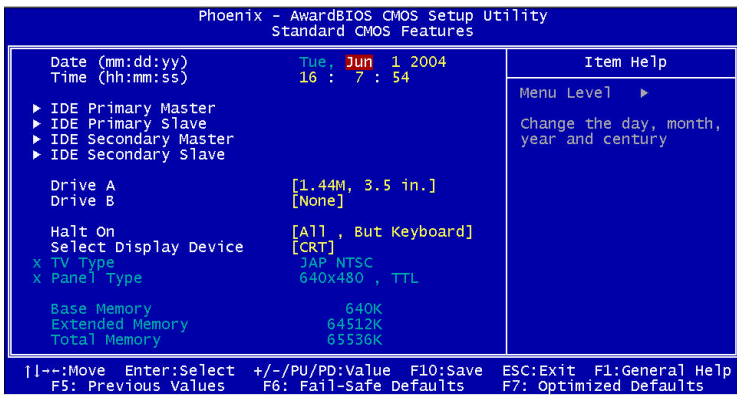



### 3.4 Advanced BIOS Features

By choosing the Advanced BIOS Features option from the INITIAL SETUP SCREEN menu, the screen below is displayed. This sample screen contains the manufacturer's default values for the PCM-6892 REV.B

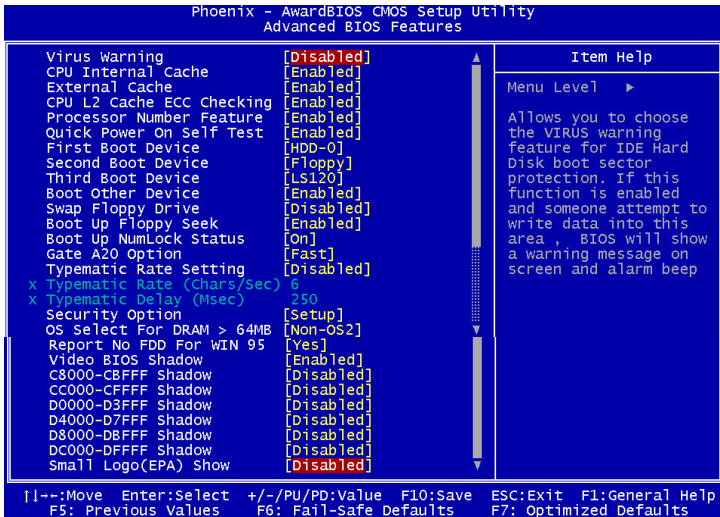

### 3.5 Advanced Chipset Features

By choosing the Advanced Chipset Features option from the INITIAL SETUP SCREEN menu, the screen below is displayed. This sample screen contains the manufacturer's default values for the PCM-6892 REV.B.

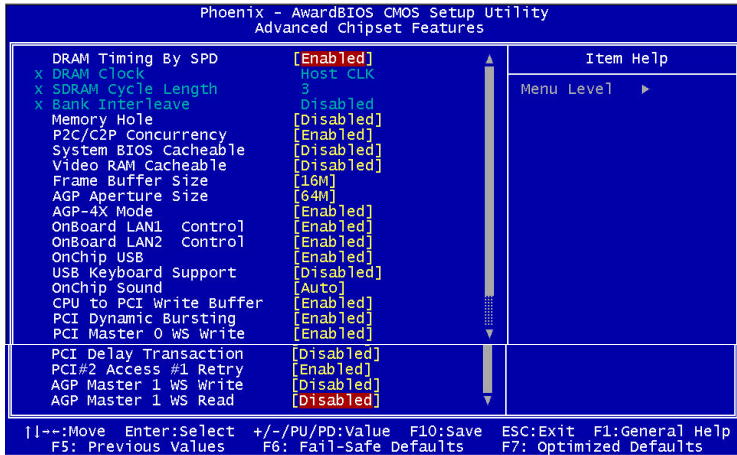

### 3.6 Integrated Peripherals

By choosing the Integrated Peripherals from the INITIAL SETUP SCREEN menu, the screen below is displayed. This sample screen contains the manufacturer's default values for the PCM-6892 REV.B.

Phoenix - AwardBIOS CMOS Setup Utility			Item Help
Integrated Peripherals			Menu Level ▶
OnChip IDE Channel0	[Enabled]		
OnChip IDE Channel1	[Enabled]		
IDE Prefetch Mode	[Enabled]		
Primary Master PIO	[Auto]		
Primary Slave PIO	[Auto]		
Secondary Master PIO	[Auto]		
Secondary Slave PIO	[Auto]		
Primary Master UDMA	[Auto]		
Primary Slave UDMA	[Auto]		
Secondary Master UDMA	[Auto]		
Secondary Slave UDMA	[Auto]		
Init Display First	[PCI Slot]		
PCMCIA SERIRQ	[Disabled]		
IDE HDD Block Mode	[Enabled]		
Onboard FDD Controller	[Enabled]		
Onboard Serial Port 1	[3F8/IRQ4]		
Onboard Serial Port 2	[2F8/IRQ3]		
COM2 Mode	[RS232]		
UART 2 Mode	[Standard]		
* IR Function Duplex	Half		Menu Level ▶
* IR.RK inverting enable	No. Yes		
Onboard Parallel Port	[378/IRQ7]		
Onboard Parallel Mode	[Normal]		
ECP Mode Use DMA	[3]		
Parallel Port EPP Type	[EPP1.9]		
Onboard Serial Port 3	[3E8]		
Serial Port 3 Use IRQ	[IRQ10]		
Onboard Serial Port 4	[2E8]		
Serial Port 4 Use IRQ	[IRQ11]		
Onboard Legacy Audio	[Enabled]		
Sound Blaster	[Disabled]		
SB I/O Base Address	[220H]		
SB IRQ Select	[IRQ 5]		
SB DMA Select	[DMA 1]		
MPU-401	[Disabled]		
MPU-401 I/O Address	[330-333H]		

↑↓←→: Move Enter: Select +/-/PU/PD: Value F10: Save ESC: Exit F1: General  
 F5: Previous Values F6: Fail-Safe Defaults F7: Optimized Defaults

### PCMCIA Card Support Limitation List of PCM-6892 Rev.B

COM 3 and 4 need to be disabled for supporting 16bit PCMCIA Card under Windows 98 SE and Windows 2000 at both ACPI and APM mode

To disable COM3 and COM4 for supporting 16bit PCMCIA cards, please enable the PCMCIA SERIRQ option in CMOS setting.

Power mode	OS	COM 3, 4	16 bit PCMCIA	32 bit PCMCIA
APM (5V only or AT)	Win 98	Enable	<b>F</b>	<b>O</b>
		Disable	<b>O</b>	<b>O</b>
	Win 2K	Enable	<b>F</b>	<b>O</b>
		Disable	<b>O</b>	<b>O</b>
	Win XP	Enable	<b>O</b>	<b>O</b>
		Disable	<b>O</b>	<b>O</b>
ACPI (ATX)	Win 98	Enable	<b>F</b>	<b>O</b>
		Disable	<b>O (*2)</b>	<b>O (*2)</b>
	Win 2K	Enable	<b>F</b>	<b>O</b>
		Disable	<b>O</b>	<b>O</b>
	Win XP	Enable	<b>O</b>	<b>O</b>
		Disable	<b>O</b>	<b>O</b>

**Remark:**

\*1. "F" means Failed to support. "O" means OK.

\*2. Special AAEON driver is required for support PCMCIA Card under Windows 98 at ACPI model (see chapter 4)

### 3.7 Power management Setup

By choosing the Power Management Setup from the INITIAL SETUP SCREEN menu, the screen below is displayed. This sample screen contains the manufacturer's default values for the PCM-6892 REV.B.

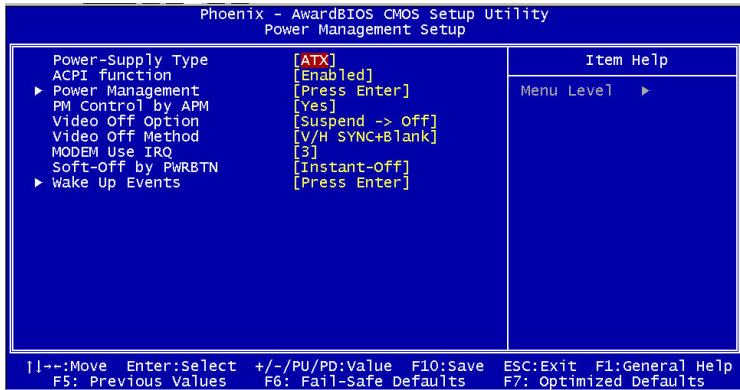

### 3.8 PnP/PCI configuration

By choosing the PnP/PCI configurations from the Initial Setup Screen menu, the screen below is displayed. This sample screen contains the manufacturer's default values for the PCM-6892 REV.B.

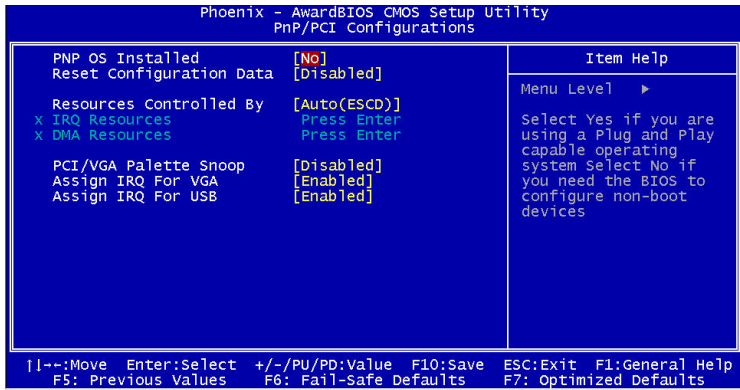

### 3.9 PC Health Status

---

By choosing the PC Health Status from the Initial Setup Screen menu, the screen below is displayed. This sample screen contains the manufacturer's default values for the PCM-6892 REV.B.

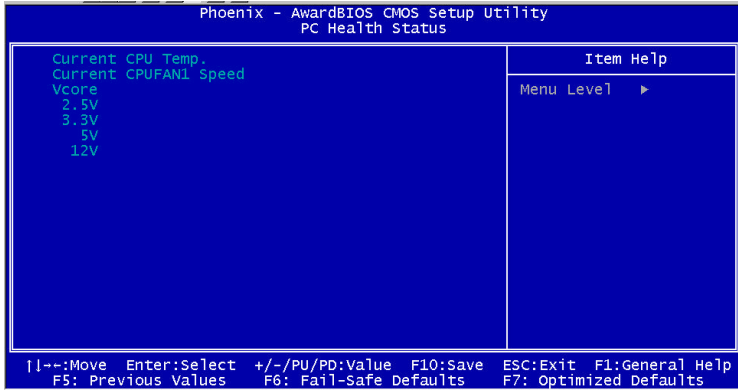

### 3.10 Frequency/Voltage control

---

By choosing the Frequency/Voltage Control from the Initial Setup Screen menu, the screen below is displayed. This sample screen contains the manufacturer's default values for the PCM-6892 REV.B.

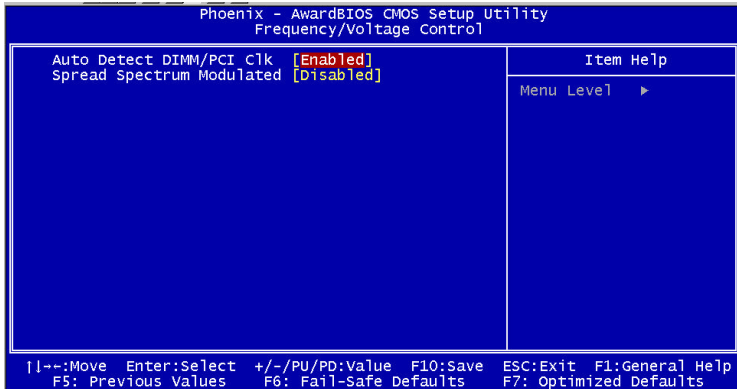



### 3.11 Load Fail-Safe Defaults

When you press <Enter> on this item you get a confirmation dialog box with a message similar to:

Load Fail-Safe Default (Y/N)?

Pressing "Y" loads the BIOS default values for the most stable, minimal performance system operations.

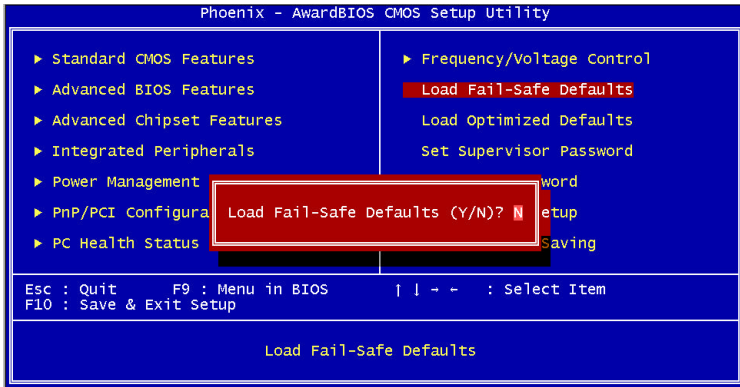

### 3.12 Load Optimized Defaults

When you press <Enter> on this item you get a confirmation dialog box with a message similar to:

Load Optimized Defaults (Y/N)?

Pressing "Y" loads the default values that are manufacturer's settings for optimal performance system operations.

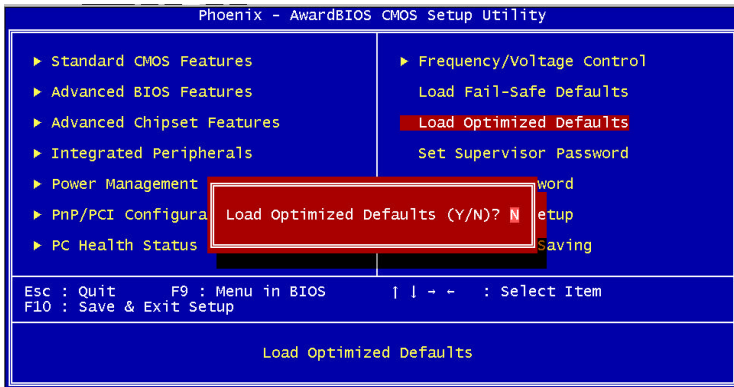

### 3.13 Set Supervisor/User Password

You can set either SUPERVISOR or USER PASSWORD, or both of them. The difference between the two is that the supervisor password allows unrestricted access to enter and change the options of the setup menus, while the user password only allows entry to the program, but not modify options.

To abort the process at any time, press Esc.

In the Security Option item in the BIOS Features Setup screen, select System or Setup:

**System** Enter a password each time the system boots and whenever you enter Setup.

**Setup** Enter a password whenever you enter Setup.

*NOTE: To clear the password, simply press Enter when asked to enter a password. Then the password function is disabled.*

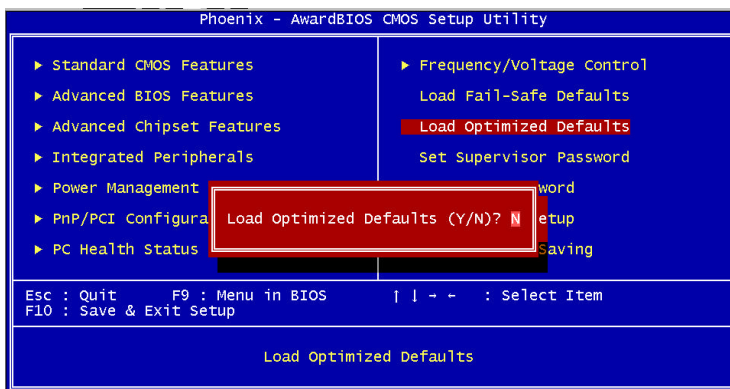

### 3.14 Save & Exit Setup

If you select this option and press <Enter>, the values entered in the setup utilities will be recorded in the chipset's CMOS memory. The microprocessor will check this every time you turn on your system and compare this to what it finds as it checks the system. This record is required for the system to operate.

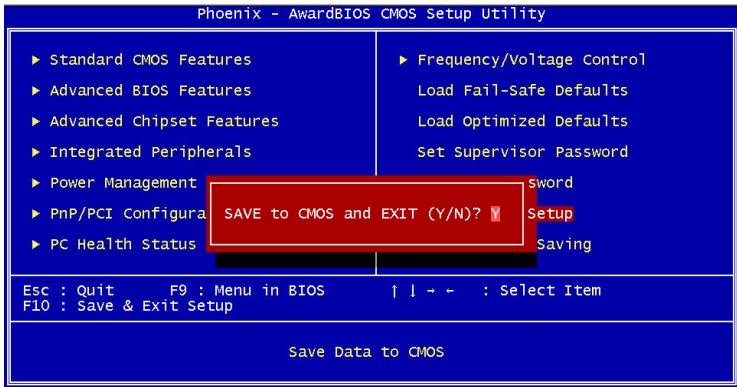

### 3.15 Exit without saving

Selecting this option and pressing <Enter> allows you to exit the Setup program without recording any new value or changing old one.

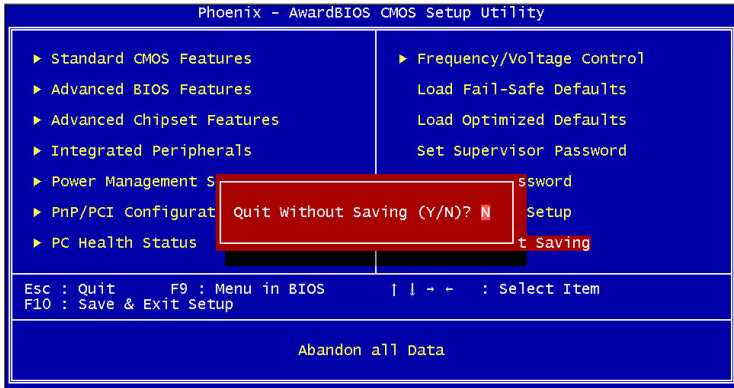

**Chapter**

**4**

**Driver  
Installation**

The PCM-6892 Rev.B comes with a CD-ROM that contains all drivers and utilities that you need for setup the system.

**Follow the sequence below to install the drivers:**

**Step 1 – Install VIA 4 in 1 driver**

**Step 2 – Install Graphic Driver**

**Step 3 – Install Audio Driver**

**Step 4 – Install Ethernet Driver**

**Step 5 – Install PCMCIA Driver (Win98 only)**

Please read instructions below for further detailed installations.

Insert the PCM-6892 Rev.B CD-ROM into the CD-ROM Drive.  
And install the drivers from Step 1 to Step 4 (5) in order.

#### **4.1 Step 1 – Install VIA 4 in 1 for Windows 98SE/2000/XP**

1. Double click on the “.exe” file.
2. Follow the instructions that the window will show you.
3. The system will help you install the driver automatically.

#### **4.2 Step 2 – Install Graphic Driver for Windows 98SE/2000/XP**

1. Choose the folder according to the OS you used and then double click on the “Setup.exe” file.
2. Follow the instructions that the window will show you.
3. The system will help you install the driver automatically.
4. Please re-start your computer.

#### **4.3 Step 3 – Install Audio Driver for Windows 98SE /2000/XP**

1. Double click on the “Setup.exe” file.
2. Follow the instructions that the window will show you.
3. The system will help you install the driver automatically.
4. Please re-start your computer.



---

**4.4 Step 4 – Install Ethernet Driver for Windows 98SE /2000/XP**

---

1. Double click on the “**Setup.exe**” file.
2. Follow the instructions that the window will show you.
3. The system will help you install the driver automatically.

---

**4.5 Step 5 – Install AAEON PCMCIA Driver for Windows 98SE**

---

1. Double click on the “**TiSetup.exe**” file.
2. Follow the instructions that the window will show you.
3. The system will help you install the driver automatically.

**Appendix**

**A**

**I/O Information**

## A.1 I/O Address Map

Address	Description	User Address
000-01F	DMA Controller #1	000-000F
020-03F	Interrupt Controller #1, Master	020-021
040-05F	System Time	040-043
060-06F	8042 (Keyboard Controller)	060-064
070-07F	Real time Clock, NMI (non-maskable Interrupt) Mask	070-073
080-09F	DMA Page Register	080-08F
0A0-0BF	Interrupt Controller #2	0A0-0A1
0C0-0DF	DMA Controller #2	0C0-0DF
0F0-0FF	Math Coprpcessor	0F0-0FF
170-177	Secondary IDE Channel	170-177
1F0-1F7	Primary IDE Channel	1F0-1F7
278-27F	Parallel Printer Port 2 (LPT3)	278-27F
2E8-2EF	Serial Port 4	2E8-2EF
2F8-2FF	Serial Port 2	2F8-2FF
378-37F	Parallel Printer Port 1 (LPT2)	378-37F
3B0-3BF	Monochrome Display and Printer Adapter (LPT1)	3B0-3BF
3D0-3DF	EGA / VGA card	3D0-3DF
3E8-3EF	Serial Port 3	3E8-3EF
3F0-3F7	Diskette Controller	3F2-3F7
3F8-3FF	Serial Port 1	3F8-3FF

## A.2 1<sup>st</sup> MB Memory Address Map

Memory Address	Description
00000-9FFFF	System memory
A0000-BFFFF	VGA buffer
C0000-CFFFF	VGA BIOS
E0000-FFFFF	System BIOS

### A.3 IRQ Mapping Chart

IRQ0	System Timer	IRQ8	System CMOS / Real time clock
IRQ1	Keyboard	IRQ9	Microsoft ACPI – Compliant system
IRQ2	Cascade to IRQ Controller	IRQ10	COM3
IRQ3	COM2	IRQ11	COM4
IRQ4	COM1	IRQ12	PS/2 mouse
IRQ5	Unused	IRQ13	FPU
IRQ6	Floppy Disk Controller	IRQ14	Primary IDE
IRQ7	Printer	IRQ15	Secondary IDE

### A.4 DMA Channel Assignments

DMA Channel	Function
0	Available
1	Available
2	Standard Floppy Disk Controller
3	Available
4	Direct Memory Access Controller
5	Available
6	Available
7	Available

**Appendix**

**B**

**Programming the  
Watchdog Timer**

## **B.1 Programming the Watchdog Timer**

---

PCM-6892 contains a watchdog timer reset pin. (GP16)

All reference material can be found on the following pages.

```

=====**
** Title : WatchDog Timer Setup Utility (for W83977 GP16) **
** Company : AAEON Technology Inc. **
** Compiler : Borland C ++ Version 3.0 **
**=====
=====*/
#include <dos.h>
#include <io.h>
#include <bios.h>
#include <stdio.h>
#include <stdlib.h>
#include <conio.h>

/* Set I/O Address : 370/371 or 3F0/3F1 */
#define IO_INDEX_PORT 0x370
#define IO_DATA_PORT 0x371

/* Set Watchdog reset pin : 12/13/16 */
#define watch_dog_output_GP 16
#define UNLOCK_DATA 0x87
#define LOCK_DATA 0xAA
#define DEVICE_REGISTER 0x07

void EnterConfigMode()
{
    outportb(IO_INDEX_PORT, UNLOCK_DATA);
    outportb(IO_INDEX_PORT, UNLOCK_DATA);
}

```

```
void ExitConfigMode()
{
    outportb(IO_INDEX_PORT, LOCK_DATA);
}

void SelectDevice(unsigned char device)
{
    outportb(IO_INDEX_PORT, DEVICE_REGISTER);
    outportb(IO_DATA_PORT, device);
}

unsigned char ReadAData(short int reg)
{
    outportb(IO_INDEX_PORT, reg);
    return (inportb(IO_DATA_PORT));
}

void WriteAData(unsigned char reg, unsigned char data)
{
    outportb(IO_INDEX_PORT, reg);
    outportb(IO_DATA_PORT, data);
}

void SetWatchDogTime(unsigned char time_val)
{
    EnterConfigMode();
    SelectDevice(8);
    //Set Register F2
    //Set Watch-Dog Timer 1~ 256
```



```
WriteAData(0xF2, time_val);
// set counter counts in second (or minute)
// Register F4 Bit 6 = 0/1 (minutes/seconds)
// For w83977EF only
WriteAData(0xF4, 0x40);
ExitConfigMode();
    }

void init_w83977tf_aw_watchdog()
{
short int value;
//Enter W83977 Configure Mode
EnterConfigMode();
//Select Device 7
SelectDevice(7);
//Set Device Active
WriteAData(0x30, 0x01);
//caution:skip this step will be a mistake!!
if (watch_dog_output_GP==12)
{
//Set Register E2 to define GP12
WriteAData(0xE2, 0x0A);
}
else if(watch_dog_output_GP==13)
{
//Set Register E3 to define GP13
```

```
WriteAData(0xE3, 0x0A);
}
else if(watch_dog_output_GP==16)
{
//Set Register E6 to define GP16
WriteAData(0xE6, 0x0A);
}
//Select Device 8
SelectDevice(8);
//Set Register F3
//keyboard and mouse interrupt reset Enable
//When Watch-Dog Time -out occurs,Enable POWER LED
output
    WriteAData(0xF3, 0x0E);

//caution:skip this step will be a mistake!!
if (watch_dog_output_GP==12)
{
//Set Register 2A (PIN 57) Bit 7 = 0/1 (KBLOCK/GP12)
//set to GP12 for WD Rst
WriteAData(0x2A,ReadAData(0x2A)|0x80);
}
else if(watch_dog_output_GP==13)
{
//Set Register 2B (PIN 58) Bit 0 = 0/1 (KBLOCK/GP13)
//set to GP13 for WD Rst
```

```
WriteAData(0x2B,ReadAData(0x2B)|0x01);
}
else if(watch_dog_output_GP==16)
{
//Set Register 2C (PIN 119) Bit 5-4 = 01 (GP16)
//set to GP16 for WD Rst
WriteAData(0x2C,ReadAData(0x2C)|0x10);
}
//Exit W83977 Configure mode
ExitConfigMode();
}
void main(int argc, char* argv[])
{
int time_value=0;
char *ptr;
printf( inBond 83977 WatchDog Timer Setup Utility w
Version 1.0\n" );
printf( copyright (c) 2000 AAEON Technology Inc.\n");C
printf( this version only for W83977 that using GP%d to T
Reset System.\n",watch_dog_output_GP);

if (argc == 1)
{
printf( n Syntax: WATCHDOG [time] \n" );\
printf(" time range : 1 ~ 256 \n\n" );
return ;
```

```
}  
if (argc > 1)  
{  
ptr = argv[1];  
time_value = atoi(ptr);  
}  
if (time_value > 0 && time_value < 256)  
{  
SetWatchDogTime((unsigned char) time_value);  
init_w83977f_aw_watchdog();  
printf( atch Dog Timer set up : %d\n",time_value);W  
}  
}
```