

PC-3200

VIA Eden Processor-based
Fanless Panel PC with
12.1" TFT-LCD

Copyright Notice

This document is copyrighted, 2003. All rights are reserved. The original manufacturer reserves the right to make improvements to the products described in this manual at any time without notice.

No part of this manual may be reproduced, copied, translated, or transmitted in any form or by any means without the prior written permission of the original manufacturer. Information provided in this manual is intended to be accurate and reliable. However, the original manufacturer assumes no responsibility for its use, nor for any infringements upon the rights of third parties, which may result from its use.

The material in this document is for product information only and is subject to change without notice. While reasonable efforts have been made in the preparation of this document to assure its accuracy, AAEON, assumes no liabilities resulting from errors or omissions in this document, or from the use of the information contained herein.

AAEON reserves the right to make changes in the product design without notice to its users.

Acknowledgments

Award is a trademark of Award Software International, Inc.

VIA is a trademark of VIA Technologies, Inc.

IBM, PC/AT, PS/2 and VGA are trademarks of International Business Machines Corporation.

Intel and Pentium are trademarks of Intel Corporation.

Microsoft Windows ® is a registered trademark of Microsoft Corporation.

RTL is a trademark of Realtek Semi-Conductor Co., Ltd.

ESS is a trademark of ESS Technology, Inc.

UMC is a trademark of United Microelectronics Corporation.

SMI is a trademark of Silicon Motion, Inc.

Creative is a trademark of Creative Technology LTD.

All other product names or trademarks are properties of their respective owners.

FCC Class B

This device complies with Part 15 FCC Rules. Operation is subject to the following two conditions: (1) This device may not cause harmful interference. (2) This device must accept any interference received including interference that may cause undesired operation.

This equipment has been tested and found to comply with the limits for a Class B digital device, pursuant to Part 15 of the FCC Rules. These limits are designed to provide reasonable protection against harmful interference when the equipment is operated in a residential environment. This equipment generates, uses and can radiate radio frequency energy. If not installed and used in accordance with this user's manual, it may cause harmful interference to radio communications. Note that even when this equipment is installed and used in accordance with this user's manual, there is still no guarantee that interference will not occur. If this equipment is believed to be causing harmful interference to radio or television reception, this can be determined by turning the equipment on and off. If interference is occurring, the user is encouraged to try to correct the interference by one or more of the following measures:

- Reorient or relocate the receiving antenna
- Increase the separation between the equipment and the receiver
- Connect the equipment to a power outlet on a circuit different from that to which the receiver is connected
- Consult the dealer or an experienced radio/TV technician for help

Warning!



Any changes or modifications made to the equipment which are not expressly approved by the relevant standards authority could void your authority to operate the equipment.

Packing List

Before you begin installing your card, please make sure that the following materials have been shipped:

- PC-3200 series Panel PC
- CD-ROM
 - Contains User's Manual, Drivers and Utilities
- Accessories
 - Y-shaped adapter for PS/2 mouse and Keyboard
 - Power cord: USA type
 - Power cord connector (change USA to Germany Type)
 - AC/DC power adapter
 - DC plug-in housing (female)
 - Mounting kits and packet of screws
 - Battery Pack (optional)

If any of these items are missing or damaged, contact your distributor or sales representative immediately.

Warning!



1. Input voltage rated 18 V ~ 25 Vdc, 3.5 A max
2. Use a 3 V @ 195 mA lithium battery
3. Packing: please carry the unit with both hands, handle with care

4. Maintenance: to properly maintain and clean the surfaces, use only approved products or clean with a dry applicator
5. CompactFlash: Turn off power before inserting or removing CompactFlash storage card.

Safety & Warranty

1. Read these safety instructions carefully.
2. Keep this user's manual for later reference.
3. Disconnect this equipment from any AC outlet before cleaning. Do not use liquid or spray detergents for cleaning. Use a damp cloth.
4. For plug-in equipment, the power outlet must be installed near the equipment and must be easily accessible.
5. Keep this equipment away from humidity.
6. Put this equipment on a reliable surface during installation. Dropping it or letting it fall may cause damage.
7. The openings on the enclosure are for air convection. Protect the equipment from overheating. **DO NOT COVER THE OPENINGS.**
8. Make sure the voltage of the power source is correct before connecting the equipment to the power outlet.
9. Position the power cord so that people cannot step on it. Do not place anything over the power cord.
10. All cautions and warnings on the equipment should be noted.
11. If the equipment is not used for a long time, disconnect it from the power source to avoid damage by transient over voltage.
12. Never pour any liquid into an opening. This may cause fire or electrical shock.
13. Never open the equipment. For safety reasons, the equipment should be opened only by qualified service personnel.

14. If one of the following situations arises, get the equipment checked by service personnel:
 - a. The power cord or plug is damaged.
 - b. Liquid has penetrated into the equipment.
 - c. The equipment has been exposed to moisture.
 - d. The equipment does not work well, or you cannot get it to work according to the users manual.
 - e. The equipment has been dropped and damaged.
 - f. The equipment has obvious signs of breakage.
15. **DO NOT LEAVE THIS EQUIPMENT IN AN UNCONTROLLED ENVIRONMENT WHERE THE STORAGE TEMPERATURE IS BELOW -20° C (-4°F) OR ABOVE 60° C (140° F). IT MAY DAMAGE THE EQUIPMENT.**
16. **CAUTION: DANGER OF EXPLOSION IF BATTERY IS INCORRECTLY REPLACED. REPLACE ONLY WITH THE SAME OR EQUIVALENT TYPE RECOMMENDED BY THE MANUFACTURER, DISCARD USED BATTERIES ACCORDING TO THE MANUFACTURER'S INSTRUCTIONS.**

The sound pressure level at the operator's position according to IEC 704-1:1982 is no more than 70 dB (A).

DISCLAIMER: This set of instructions is given according to IEC 704-1.

AAEON disclaims all responsibility for the accuracy of any statements contained herein.

Contents

Copyright Notice.....	2
Acknowledgments.....	3
FCC Class B.....	4
Packing List	5
Safety & Warranty.....	7
General Information.....	11
Introductions	12
General Specifications:	13
LCD Specifications	17
Dimensions	18
System Setup.....	19
A Quick Tour of the Panel PC.....	20
Installation Procedures.....	22
Running the BIOS Setup Program.....	23
Installing System Software	24
Hardware Installation and Upgrading.....	27
Introduction.....	28
Installing the 2.5" Hard Disk Drive (HDD).....	28
Installing the battery pack.....	33
Panel Mounting Installation.....	34
Jumper Settings and Connectors.....	35
Jumpers and Connectors	36
Jumpers and switch.....	37
Locating jumpers and switch	38

Connectors	39
CMOS Clear for External RTC (J5).....	41
COM-port interface (J2, J3, J4)	42
VGA interface	45
Watchdog Timer Configuration (J4)	45
Wake on LAN select (J1)	46
BIOS Installation	47
Award BIOS setup	50
Standard CMOS Features setup	51
Advanced BIOS Features setup	52
Advanced Chipset Features setup	53
Integrated Peripherals	54
Power Management Setup	55
PnP/PCI Configurations.....	56
PC Health Status	57
Frequency/Voltage Control	58
Load Optimized Defaults	59
Set Password	60
Save & Exit Setup.....	62
Exit Without Saving.....	62
Drivers Installation.....	63

Chapter

1

**General
Information**

Introductions

The PC-3200 panel PC is a VIA low-power Eden processor computer that is designed to serve as a human machine interface (HMI) and as a multimedia computer. It is a PC-based system with 12.1" color TFT LCD display, on-board PCI Ethernet controller, multi-COM port interfaces and an audio controller. With a built-in internal IDE connectors, the PC-3200 is as compact and user friendly as a multi-function computer. In addition, its "fit anywhere" design makes it very flexible and able to be used in many different kinds of installations. It can be wall mounted, panel mounted or stood upright on a desktop.

For system integrators, this simple, complete, compact and highly integrated multimedia system let you easily build a panel PC into your applications. Common industrial applications include factory automation systems, precision machinery, and production process control. It is also suitable for many non-industrial applications, including interactive kiosk systems, entertainment management, and car park automation. Our panel PC is a reliable, cost-effective solution to your application's processing requirements.

General Specifications:

General

- **Dimensions (W x H x D):** 340.5 x 269.3 x 70.5 mm
- **Weight:** 3.25 kg
- **Power supply:** 63 watts, ATX type
Input Voltage: +5 V @ 6 A, +3.3 V @ 6 A, +12 V @ 2 A,
-12 V @ 0.5 A, -5 V @ 0.5 A, 5 VSB @ 1 A
- **Power adaptor: AC/DC**
Input voltage: 100 ~ 240 V_{AC}
Output voltage: 19 V @ 3.79 A
- **Disk drive housing:** Space for one 2.5" HDD, One slim type CD-ROM

Standard PC functions

- **CPU:** Onboard VIA Eden 667 MHz (or above) processor
- **BIOS:** Award 256 KB Flash BIOS, supports Plug & Play, APM
- **System Chipset:** VIA PN 133T Chipset (TwisterT) & VT82C686B
- **Front side bus:** 133 MHz
- **2nd level cache:** 128 KB L1 and 64 KB L2 cache memory on processor
- **System Memory:** Two 168-pin DIMM sockets, accept up to 1 GB SDRAM
- **PCI bus master IDE interface:** Supports two connectors. Each connector has one channel and supports two IDE devices. Each channel supports PIO modes 0 ~ 4, DMA mode 0 ~ 2, and Ultra DMA 33/66/100 simultaneously. The secondary connector is designated for the CD-ROM drive or CompactFlash card. BIOS supports IDE CDROM bootup

- **Keyboard/mouse connector:** Supports standard AT Keyboard and a PS/2 Mouse
- **Parallel port:** One parallel port, supports SPP/EPP/ECP parallel mode.
- **Serial ports:** Four serial ports with three RS-232 ports (COM 1,3, and 4), one RS-232/422/485 port (COM2). All ports are compatible with 16C550 UARTs, +5V/+12V power supply selectable
- **Universal serial bus (USB) port:** Supports up to two USB ports, USB v1.1 and Intel UHCI v1.1 compatible
- **Solid State Disk:** Supports one 50-pin socket for CompactFlash type I/II (True IDE mode) and IBM MicroDrive HDD
- **Watchdog timer:** 62-level timer intervals automatically generate system reset or IRQ11 when the system stops due to a program error or EMI. Jumperless selection and software enabled/disabled
- **Battery:** 3.0 V @ 195 mA lithium battery (optional)
- **Power management:** Supports power saving modes including Normal/Standby/Suspend modes. APM 1.2 compliant

VGA/LCD Interface

- **Chipset:** VIA Twister chip w/ integrated Savage4 2D/3D/Video Accelerator
- **Frame buffer:** Supports 8/16/32 MB frame buffer w/ system memory
- **Interface:** 4X AGP VGA/LCD interface, Support for 9, 12, 15, 18, 24, 36 bit TFT and optional 16- or 24-bit DSTN panel

- **Display mode:** CRT Modes: 1600 x 1200 @ 16bpp (60 Hz), 1024 x768 @ 32bpp (85 Hz); LCD/Simultaneous Modes: 1280 x 1024 @16bpp (60 Hz), 1024 x 768 @16bpp (60 Hz)
- **Chipset:** VIA 82C686 South Bridge
- **Audio controller:** AC97 Ver. 2.0 compliant interface, Multi stream Direct sound and Direct Sound 3D acceleration
- **Stereo sound:** 18-bit full-duplex codec
- **Audio interface:** Microphone in, Line in, CD audio in; Line out, Speaker L, Speaker R

PCI bus Ethernet interface

- **Chipset:** Realtek RTL 8139C PCI local bus Ethernet controller
- **Ethernet interface:** Full compliance with IEEE 802.3u 100Base-T and 10 Base-T specifications. Includes software drivers and boot ROM
- **100/10Base-T auto-sensing capability**
- **Wake-on-LAN:** Supports Wake-on-LAN function with ATX power control

Touchscreen (Optional)

Type	Analog Resistive
Resolution	Continuous
Light Transmission	75%
Controller	RS232 interface (users COM4)
Power Consumption	<5 V@ 100mA
Software Driver	Supports Windows NT/98 /2000/ME/XP

Lifetime	1 million activations
-----------------	-----------------------

Note: The panel PC with the optionally installed touchscreen will share the COM4 port. Once the touchscreen is installed, COM4 cannot be used for other purposes.

Optional modules

- **Memory:** 64/128/256/512 MB SDRAM
- **HDD:** 2.5" HDD
- **Operating System:** Microsoft® DOS, Windows 98, NT, 2000, XP
- **Touchscreen:** Analog resistive
- **Battery pack:** Rechargeable Li-ion 3S2P 11.1V 4000mAh

Environmental Specification

- **Operating temperature:** 0°C to 40°C (30 ~ 104°F)
- **Storage temperature:** -20°C to 60°C (-4 ~ 149°F)
- **Relative humidity:** 10 ~ 95% @ 40° C (non-condensing)
- **Shock:** 10 G peak acceleration (11 msec duration)
- **Certification:** **EMC:** CE Class A/ FCC Class B/; Safety: UL1950
- **Vibration:** 1G/5~500Hz/Random vibration

LCD Specifications

- **Display type:** 12.1" TFT LCD
- **Max. Resolution:** 800x 600
- **Colors:** 262 K
- **Dot size (mm):** 0.3075 x 0.3075
- **Viewing angle:** 90° (minimum)
- **Luminance:** 200 cd/m²
- **Temperature:** 0 ~ 50° C
- ***VR control:** Brightness
- **LCD MTBF:** 50,000 hours
- **Backlight lifetime:** 20,000 hours

* The VR control is defined by hot key in DOS or BIOS mode as below: Ctrl-Alt-F3, Ctrl-Alt-F4.

Note: All AAEON's LCD products are manufactured with High precision technology. However, in all LCD panels there maybe a small number of defective pixels that do not change color. This is a normal occurrence for all LCD displays from all manufacturers and should not be noticeable or objectionable under normal operation. AAEON qualify the LCD panel following industry standard: total 7 dead pixels on a screen or if there are 3 within 1 inch square area of each other on the display.

Dimensions

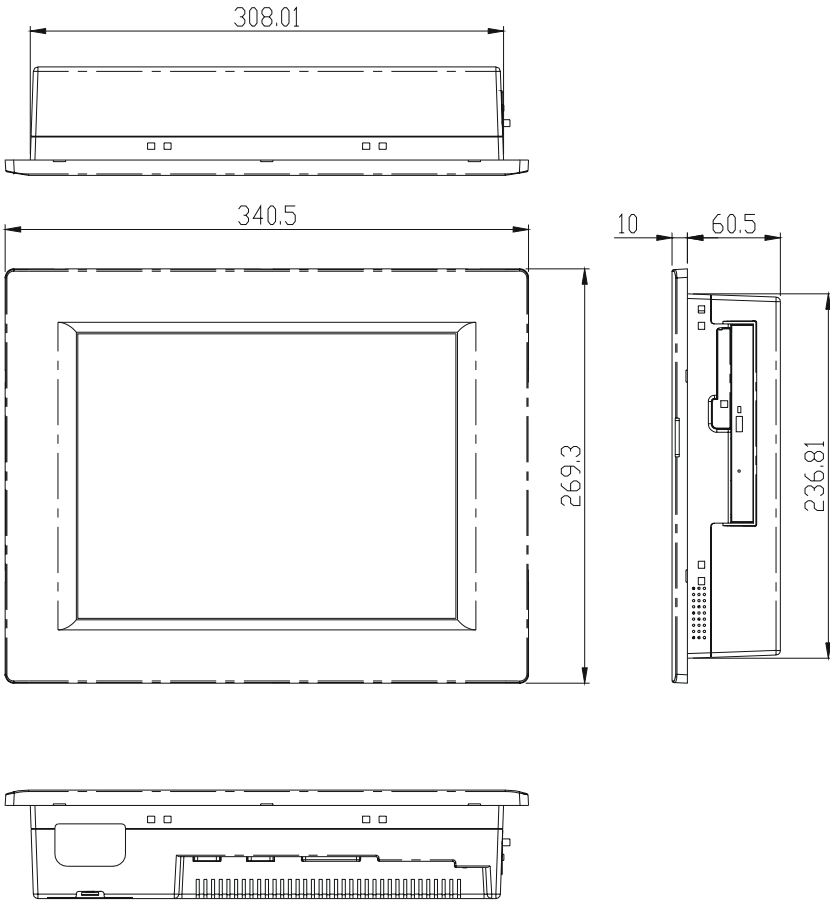

Chapter

2

**System
Setup**

A Quick Tour of the Panel PC

Before you start to set up the panel PC, take a moment to become familiar with the locations and purposes of the controls, drives, connectors and ports, which are illustrated in the figures below.

When you place the panel PC upright on the desktop, its front panel appears as shown in Figure 2-1.



Figure 2.1: Front view of PC-3200 panel PC

When you turn the panel PC around and look at its rear cover, you will find the I/O section as shown in Fig. 2-2. (The I/O section includes various I/O ports, including serial ports, parallel port, the Ethernet port, USB ports, the Line-in/Line-out jack, and so on.) The battery door cover is at the bottom of the panel PC, as shown in Fig. 2-4.

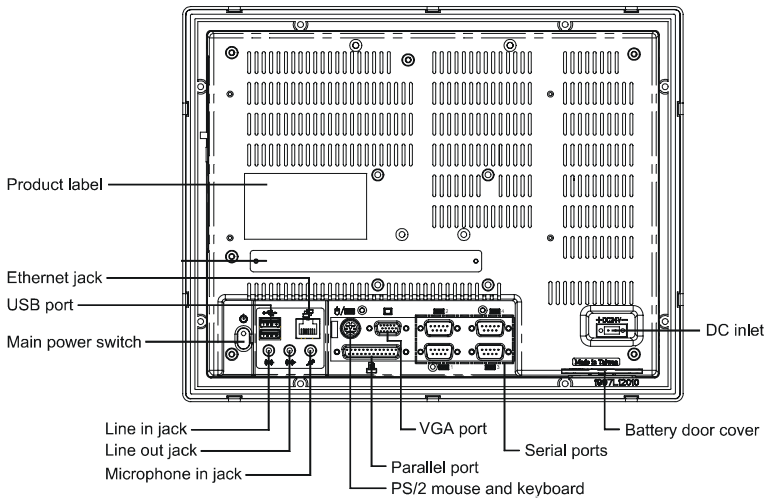

Figure 2.2: Rear view of the panel PC

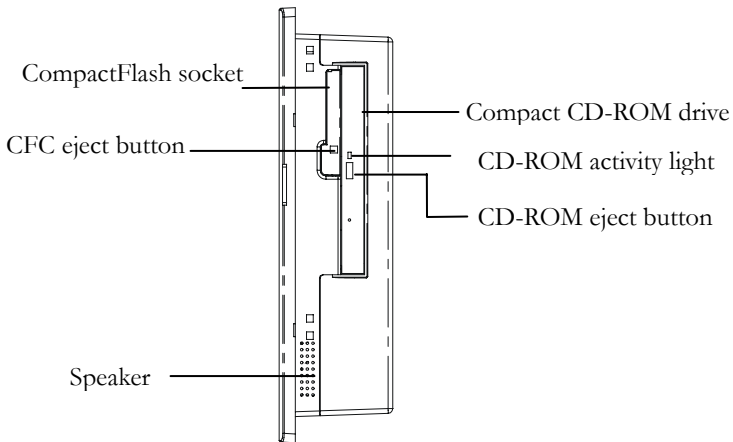

Figure 2.3: Side view of the panel PC



Figure 2.4: Bottom view of the panel PC

Installation Procedures

Connecting the power cord

The panel PC can only be powered by a DC electrical outlet. Be sure to always handle the power cords by holding the plug ends only. Please follow the Figure 2-5 to connect the male plug of the power cord to the DC inlet of the panel PC.

Connecting the keyboard or mouse

Before you start the computer, please connect the Y-shaped adaptor to the PS/2 mouse and keyboard port on the I/O section of the panel PC, then connect the necessary mouse or keyboard to the Y-shaped adapter or serial ports.

Switching on the power

When you look at the rear side of the panel PC, you will see the power switch as shown in Figure 2-2.

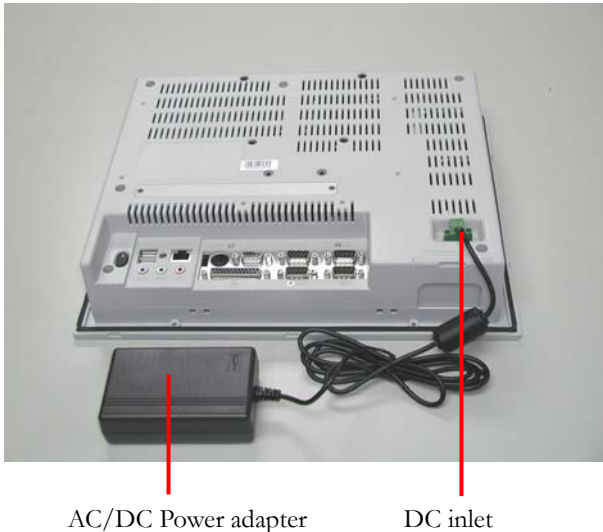

Figure 2.5: Connect the power cord to the DC inlet

Running the BIOS Setup Program

Your panel PC is likely to have been properly set up and configured by your dealer prior to delivery. You may still find it necessary to use the panel PC's BIOS (Basic Input-Output System) setup program to change system configuration information, such as the current date and time or your type of hard drive. The setup program is stored in read-only memory (ROM). It can be accessed either when you turn on or reset the panel PC, by pressing the "Del" key on your keyboard immediately after powering on the computer.

The settings you specify with the setup program are recorded in a special area of memory called CMOS RAM. This memory is backed up by a battery so that it will not be erased when you turn off or reset the system.

Whenever you turn on the power, the system reads the settings stored in CMOS RAM and compares them to the equipment check conducted during the power on self-test (POST). If an error occurs, an error message will be displayed on screen, and you will be prompted to run the setup program.

If you want to change the setup of BIOS, refer to Chapter 9 for more detailed information.

Installing System Software

Recent releases of operating systems from major vendors include setup programs, which load automatically and guide you through hard disk preparation and operating system installation. The guidelines below will help you determine the steps necessary to install your operating system on the panel PC hard drive.

Note: Some distributors and system integrators may have already pre-installed system software prior to shipment of your panel PC.

Installing software requires an installed HDD. Software can be loaded in the PC-3200 using any of four methods:

Method 1: Use the Ethernet

You can use the Ethernet port to download software to the HDD.

Method 2: Use the COM or parallel port

You can use Lap Link 6 or similar transmission software. Connect another PC to the PC-3200 with an appropriate cable and transmit the software to the PC-3200.

Method 3: Use a CD-ROM

If required, insert your operating system's installation or setup diskette into the diskette drive until the release button pops out.

The BIOS of the panel PC supports system boot-up directly from the CD-ROM drive. You may also insert your system installation CD-ROM into the CD-ROM drive.

Power on your panel PC or reset the system by pressing the "Ctrl"+"Alt"+"Del" keys simultaneously. The panel PC will automatically load the operating system from the diskette or CD-ROM.

If you are presented with the opening screen of a setup or installation program, follow the instructions on screen. The setup program will guide you through preparation of your hard drive, and installation of the operating system. If you are presented with an operating system command prompt, such as A:\>, then you must partition and format your hard drive, and manually copy the operating system files to it. Refer to your operating system user's manual for instructions on partitioning and formatting a hard drive.

Installing the Drivers

After installing your system software, you will be able to set up the Ethernet, SVGA, audio, and touch screen functions. All drivers are stored in a CD-ROM disc entitled "Drivers and Utilities" which can be found in your accessory box.

The standard procedures for installing the drivers are described in Chapters 5, 6, 7, 8 respectively.

The various drivers and utilities in the CD-ROM disc have their own text files which help users install the drivers and understand their functions. These files are a very useful supplement to the information in this manual.

Chapter

3

Hardware Installation and Upgrading

Introduction

The panel PC consists of a PC-based computer that is housed in a plastic rear panel and a metal shielding case. You can install HDD, SDRAM and battery pack by removing the rear panel and shielding case. Any maintenance or hardware upgrades can be easily completed after removing the rear panel and shielding case.

If you are a systems integrator and need to know how to completely disassemble the panel PC, you can find more useful information in Appendix C.

Warning!



Do not remove the plastic rear cover until you have verified that no power is flowing within the panel PC. Power must be switched off and the power cord must be unplugged. Every time you service the panel PC, you should be aware of this.

Installing the 2.5" Hard Disk Drive (HDD)

You can attach one enhanced Integrated Device Electronics (IDE) hard disk drive to the panel PC's internal controller which uses a PCI local-bus interface. The advanced IDE controller supports faster data transfer and allows the IDE hard drive to exceed 528 MB. The following are instructions for installation:

1. Detach and remove the plastic rear cover.
2. There is a metal plate, which holds the HDD to the upper left-hand side of the metal shielding case. (See Figure 3.1)

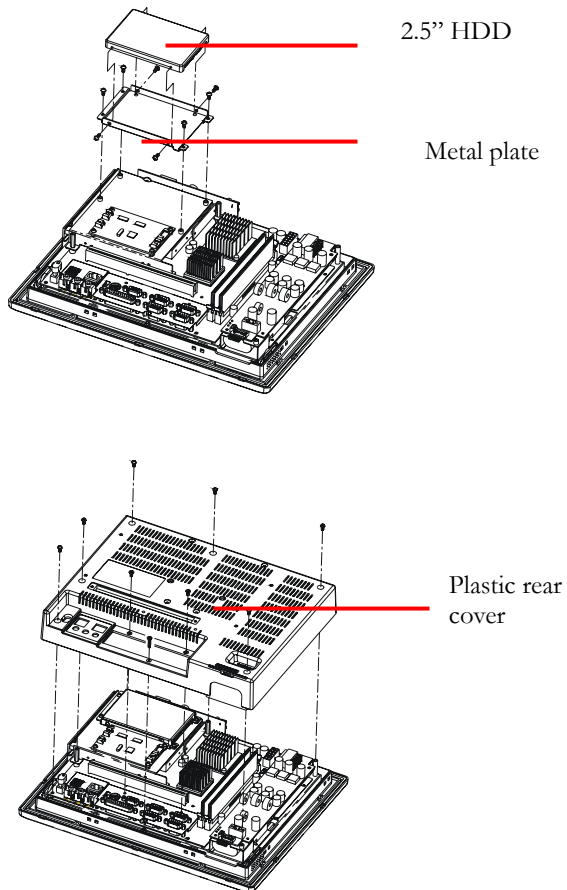
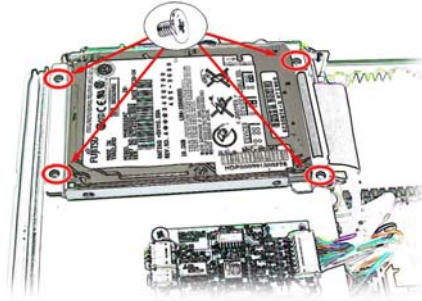

Figure 3.1: Installing primary 2.5'' HDD

3. Place the HDD on the metal plate, and tighten the screws.



4. The HDD cable (1 x 44-pin to 1 x 44-pin) is next to the metal plate. Connect the HDD cable to the HDD. Another end of the HDD cable is connected to the PC board (CN21). Make sure that the red/blue wire corresponds to Pin 1 on the connector, which is labeled on the board. Plug the other end of the cable into the IDE hard drive, with Pin 1 on the cable corresponding to Pin 1 on the hard drive.

Note: To avoid the IDE cable being discounted by the CD-ROM cable, please arrange the CD-ROM cable first before connect the IDE cable.

- Put the plastic rear cover on and tighten the screws.

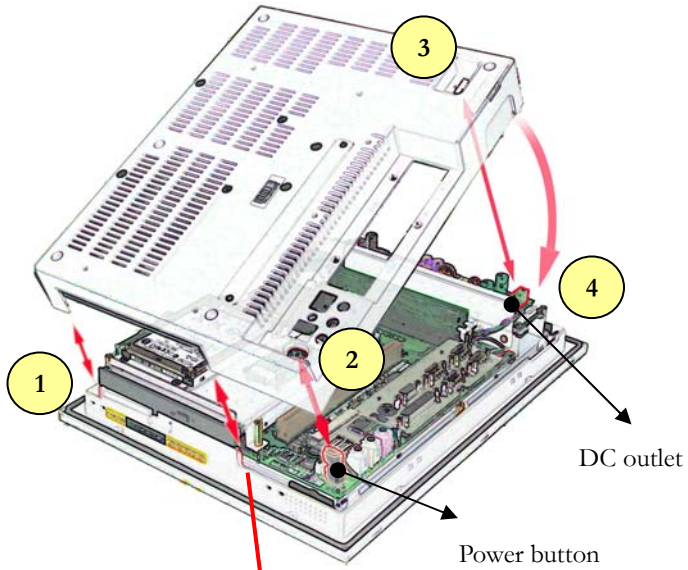

The inner edge

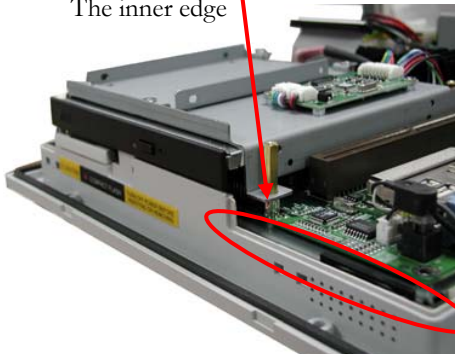

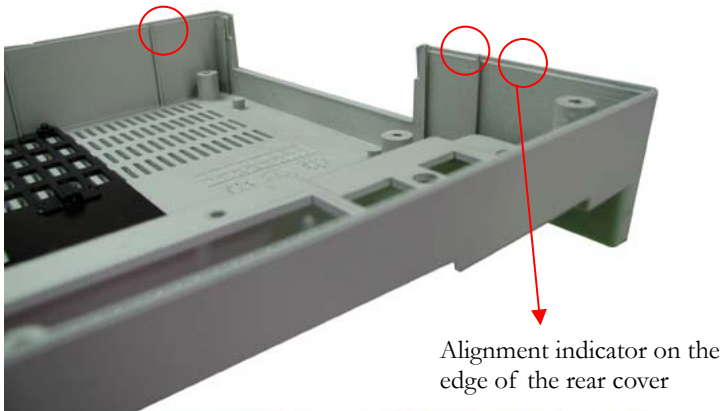

- 1) Lodge the alignment indicator of the plastic rear cover in the inner edge.
- 2) Cross the power button over the rear cover hole.
- 3) Cross the DC plug-in housing (female) over the rear cover hole.
- 4) Make sure the entire alignment indicator lodge in the inner edge.

Installing the battery pack

1. Pull up the battery door cover on the right bottom of PC-3200
2. Put the battery pack in, and then connect the battery cable to battery connector in the PC-3200. Make sure the red wire corresponds to Pin 1 on the connector.
3. Close the battery door cover.

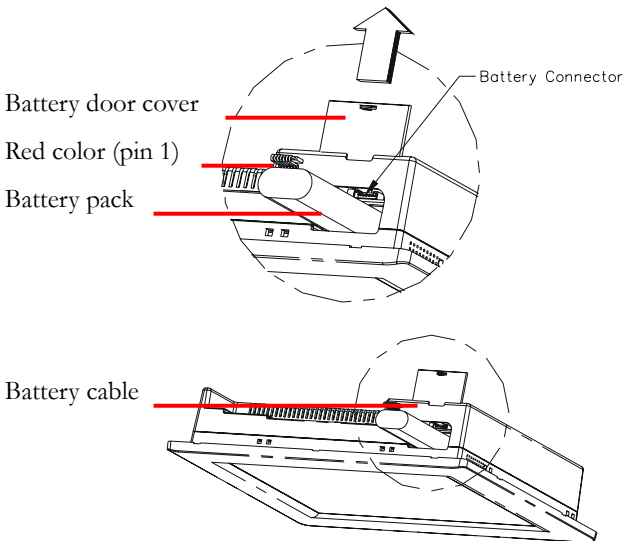

Figure 3.2: Installing the battery pack

Panel Mounting Installation

The display panel can be mounted into the wall. You will need the screws along with the mounting brackets, which be packed in the accessory box. Follow the steps below:

Before you start to follow the instructions, please place the display panel into the wall.

1. Plug the mounting brackets into the hole around the display (see the following illustration on the left).
2. Push the mounting brackets forward to make it fixed.
3. Fix the brackets with screws until the display panel is firmly mounted in the wall.

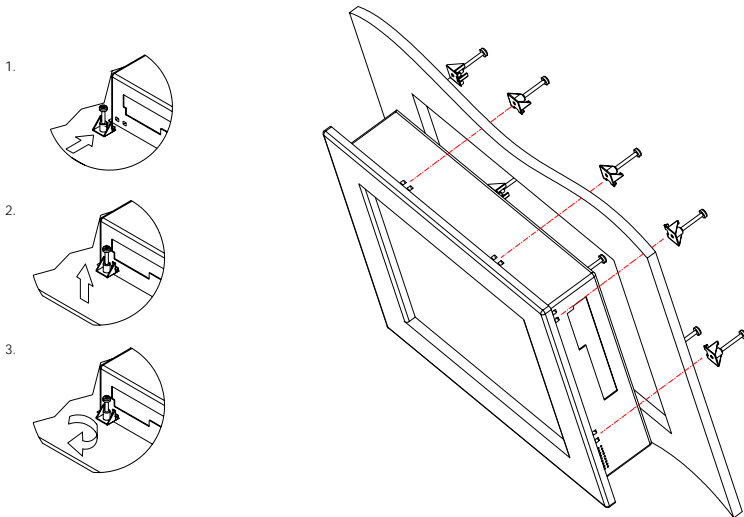

Chapter

4

Jumper Settings and Connectors

Jumpers and Connectors

Setting jumpers

You can configure your panel pc to match the needs of your application by setting jumpers. A jumper is the simplest kind of electric switch. It consists of two metal pins and a small metal clip (often protected by a plastic cover) that slides over the pins to connect them.

To “close” a jumper you connect the pins with the clip. To “open” a jumper you remove the clip. Sometimes a jumper will have three pins, labeled 1, 2 and 3. In this case you would connect either pins 1 and 2 or 2 and 3.

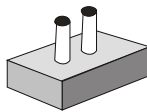

Open
Open

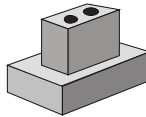

Closed
Closed

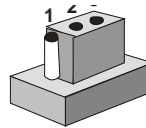

Closed 2-3
Closed 2-3

The jumper settings are schematically depicted in this manual as follows:

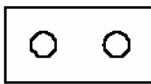

Open



Closed

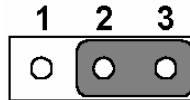

Closed 2-3

A pair of needle-nose pliers may be helpful when working with jumpers.

If you have any doubts about the best hardware configuration for your application, contact your local distributor or sales representative before you make any changes.

Generally, you simply need a standard cable to make most connections

Jumpers and switch

The motherboard of the PC-3200 has a number of jumpers that allow you to configure your system to suit your applications. The table below lists the function of each of the board's jumpers.

Table 4.1: Jumpers and their functions

Label	Function
J1	LAN power type select
J2	COM2 RS-232/422/485 setting
J3	COM1/COM2/COM3/COM4 Pin 9 output type setting
J4	Watchdog timer configuration
J5	CMOS clear for external RTC
SW2	Panel type setting (Reserved)

Locating jumpers and switch

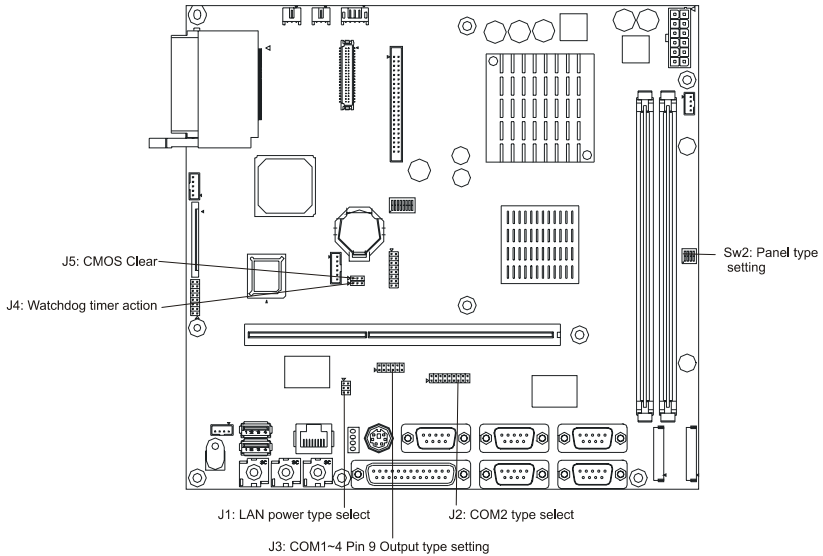

Figure 4.1: Jumpers on the PC-3200 motherboard

Connectors

Onboard connectors link the PC-3200 to external devices such as external hard disk drives or floppy drives. The table below lists the function of each of the board's connectors.

Table 4.2: Connectors on the PC-3200 motherboard

Label	Function
CN1	ATX power connector
CN3	LVDS channel-1 connector
CN4	Inverter power connector
CN5	LVDS channel-2 connector
CN8	Internal speaker connector (Reserved)
CN12	Floppy drive connector (Reserved)
CN21	IDE hard drive connector
CN22	CD-ROM connector
CN23	CFC connector
CN25	Front panel connector
CN26	SIR connector (Reserved)
CN27	Battery status connector
FAN1	Fan power for system
FAN2	Fan power for CPU
Slot 1	PCI/ISA bus expansion connector

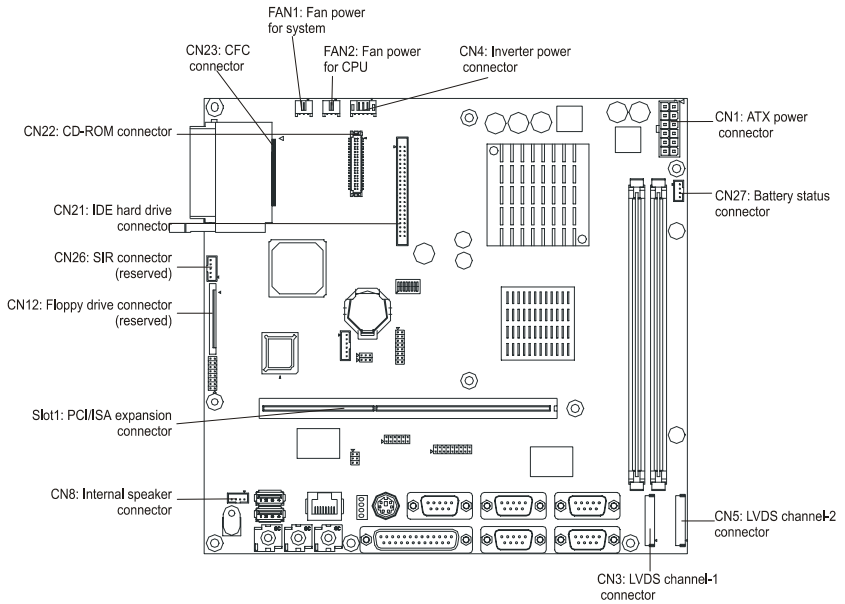

Figure 4.2: Connectors on the PC-3200 motherboard

CMOS Clear for External RTC (J5)

Warning! To avoid damaging the computer, always turn off the power supply before setting “Clear CMOS”. Set the jumper back to “Normal operation” before turning on the power supply.



This jumper is used to erase CMOS data and reset system BIOS information.

The procedure for clearing CMOS is:

1. Turn off system.
2. Short pin 2 and pin 3.
3. Return jumper to pins 1 and 2.
4. Turn on the system. The BIOS is now reset to its default setting.

Table 4.3: CMOS clear (J5)

*Normal operation	Clear CMOS
<div style="display: flex; justify-content: space-around; margin-bottom: 5px;"> 1 2 3 </div>	<div style="display: flex; justify-content: space-around; margin-bottom: 5px;"> 1 2 3 </div>

* default setting

COM-port interface (J2, J3, J4)

The panel PC provides four serial ports (COM1, 3, 4: RS-232; COM2: RS-232/422/485) in one COM port connector.

COM2 RS-232/422/485 setting (J2)

COM2 can be configured to operate in RS-232, RS-422, or RS-485 mode. This is done via J2.

Table 4.4: COM2 RS-232/422/485 setting (J2)

*RS-232

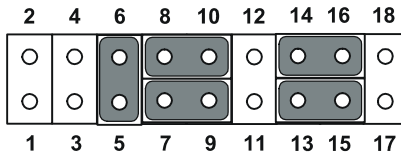

RS-422

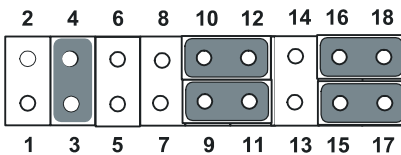

RS-485

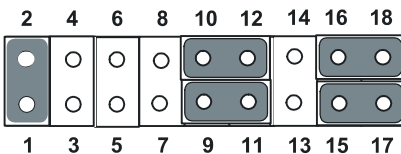

* default setting

The IRQ and the address ranges for COM1, 2, 3, and 4 are fixed. However, if you wish to disable the port or change these parameters later you can do this in the system BIOS setup. The table overleaf shows the default settings for the panel PC's serial ports.

COM1 and COM2 are one set. You can exchange the address range and interrupt IRQ of COM1 for the address range and interrupt IRQ of COM2. After exchanging, COM1's address range is 3F8 ~ 3FF and its request IRQ is IRQ4; and COM2's address range is 2F8 ~ 2FF and its interrupt IRQ is IRQ3.

COM3 and COM4 are another set. Their selectable function is the same as the COM1/COM2 set

Table 4.5: Serial port default settings

Port	Address Range	Interrupt
COM1	3F8 ~ 3FF	IRQ4
COM2	2F8 ~ 2FF	IRQ3
COM3	3E8 ~ 3EF	IRQ10
COM4	2E8 ~ 2EF	IRQ5

COM1/COM2/COM3/COM4 pin 9 output setting (J3)

Table 4.6: COM1/2/3/4 pin 9 settings (J3)

*Normal operation	+5V output	+12V output																																																																								
<table border="1"> <tr> <td>2</td><td>4</td><td>6</td><td>8</td><td>10</td><td>12</td> </tr> <tr> <td>○</td><td>○</td><td>○</td><td>○</td><td>○</td><td>○</td> </tr> <tr> <td>○</td><td>○</td><td>○</td><td>○</td><td>○</td><td>○</td> </tr> <tr> <td>1</td><td>3</td><td>5</td><td>7</td><td>9</td><td>11</td> </tr> </table>	2	4	6	8	10	12	○	○	○	○	○	○	○	○	○	○	○	○	1	3	5	7	9	11	<table border="1"> <tr> <td>2</td><td>4</td><td>6</td><td>8</td><td>10</td><td>12</td> </tr> <tr> <td>○</td><td>○</td><td>○</td><td>○</td><td>○</td><td>○</td> </tr> <tr> <td>○</td><td>○</td><td>○</td><td>○</td><td>○</td><td>○</td> </tr> <tr> <td>1</td><td>3</td><td>5</td><td>7</td><td>9</td><td>11</td> </tr> </table>	2	4	6	8	10	12	○	○	○	○	○	○	○	○	○	○	○	○	1	3	5	7	9	11	<table border="1"> <tr> <td>2</td><td>4</td><td>6</td><td>8</td><td>10</td><td>12</td> </tr> <tr> <td>○</td><td>○</td><td>○</td><td>○</td><td>○</td><td>○</td> </tr> <tr> <td>○</td><td>○</td><td>○</td><td>○</td><td>○</td><td>○</td> </tr> <tr> <td>1</td><td>3</td><td>5</td><td>7</td><td>9</td><td>11</td> </tr> </table>	2	4	6	8	10	12	○	○	○	○	○	○	○	○	○	○	○	○	1	3	5	7	9	11
2	4	6	8	10	12																																																																					
○	○	○	○	○	○																																																																					
○	○	○	○	○	○																																																																					
1	3	5	7	9	11																																																																					
2	4	6	8	10	12																																																																					
○	○	○	○	○	○																																																																					
○	○	○	○	○	○																																																																					
1	3	5	7	9	11																																																																					
2	4	6	8	10	12																																																																					
○	○	○	○	○	○																																																																					
○	○	○	○	○	○																																																																					
1	3	5	7	9	11																																																																					

*default setting

Note:

- Pins 1, 3 and 5 are for COM1
- Pins 2, 4 and 6 are for COM2
- Pins 7, 9 and 11 are for COM3
- Pins 8, 10 and 12 are for COM4

VGA interface

The panel PC's AGP VGA interface can drive conventional CRT displays. It is also capable of driving a wide range of flat panel displays, including electro luminescent (EL), gas plasma, passive LCD and active LCD displays.

LCD panel power setting



The panel PC's AGP SVGA interface supports 5 V and 3.3 V LCD displays. The LCD cable already has a built-in default setting. You do not need to adjust any jumper or switch to select the panel power.

Watchdog Timer Configuration (J4)

An onboard watchdog timer reduces the chance of disruptions which EMP (electromagnetic pulse) interference can cause. This is an invaluable protective device for standalone or unmanned applications. Setup involves one jumper and running the control software. (Refer to Appendix B.)

When the watchdog timer activates (i.e. CPU processing has come to a halt), it can reset the system or generate an interrupt on IRQ11. This can be set via jumper J4 as shown below:

Table 4.7: Watchdog activity selection (J4)













*System reset			IRQ11		
1	2	3	1	2	3
					

*default setting

Wake on LAN select (J1)

The PC-3200 provides Wake-on LAN function when ATX power is used. To enable Wake-on LAN function, the J1 should be set as shown below:

Table 4.8: Wake-On-LAN select (J1)

*Normal Power		Wake-on-LAN	
1		2	
3		4	
5		6	
1		2	
3		4	
5		6	

*default setting

Chapter

5

BIOS Installation

The PC-3200 comes with an Award BIOS chip that contains the ROM setup for your system. This chip serves as an interface between the processor and the rest of the main board's components. This chapter explains the information contained in the setup program and tells you how to modify the settings according to your system configuration. Some setup items will not be explained, because it is recommended that users do not change such items.

Note: Values for the various setup items that appear on your own screen (including default values) may not be the same as the values shown on the screen figures in this chapter. This is because the BIOS is revised and updated from time to time.

System test and initialization

These routines test and initialize board hardware. If the routines encounter an error during the tests, you will either hear a few short beeps or see an error message on the screen. There are two kinds of errors: fatal and non-fatal. The system can usually continue the boot up sequence with non-fatal errors. Non-fatal error messages usually appear on the screen along with the following instructions:

Press <F1> to RESUME

Write down the message and press the F1 key to continue the bootup sequence.

System configuration verification

These routines check the current system configuration against the values stored in the board's CMOS memory. If they do not match, the program outputs an error message. You will then need to run the BIOS setup program to set the configuration information in memory.

There are three situations in which you will need to change the CMOS settings:

1. You are starting your system for the first time
2. You have changed the hardware attached to your system
3. The CMOS memory has lost power and the configuration information has been erased.

The PC-3200 CMOS memory has an integral lithium battery backup. The battery backup should last ten years in normal service, but when it finally runs down, you will need to replace the complete unit.

Award BIOS setup

Award's BIOS ROM has a built-in Setup program that allows users to modify the basic system configuration. This type of information is stored in battery-backed CMOS RAM so that it retains the Setup information when the power is turned off.

Entering setup

Power on the computer and press immediately. This will allow you to enter Setup.

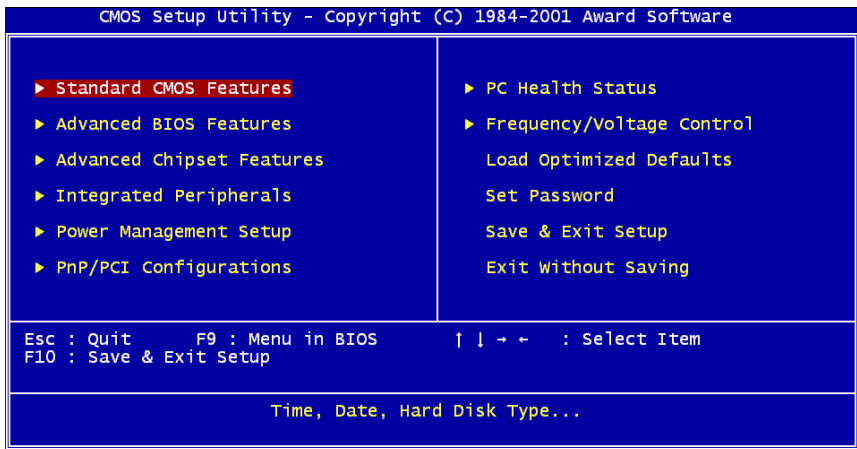

Standard CMOS Features setup

When you choose the Standard CMOS Features option from the Initial Setup Screen menu, the screen shown below is displayed. This standard Setup Menu allows users to configure system components such as date, time, hard disk drive, floppy drive and display. Once a field is high lighted, on-line help information is displayed in the left bottom of the Menu screen.

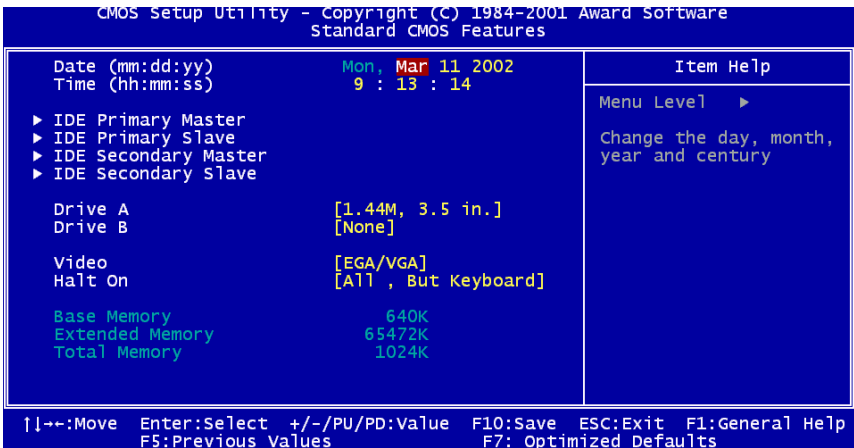

Advanced BIOS Features setup

By choosing the Advanced BIOS Features Setup option from the Initial Setup Screen menu, the screen below is displayed. Users are not encouraged to run the BIOS and Chipset Features setup programs. Your system should have been fine-tuned before shipping. Improper setup may cause the system to fail, so consult your dealer before making any changes.

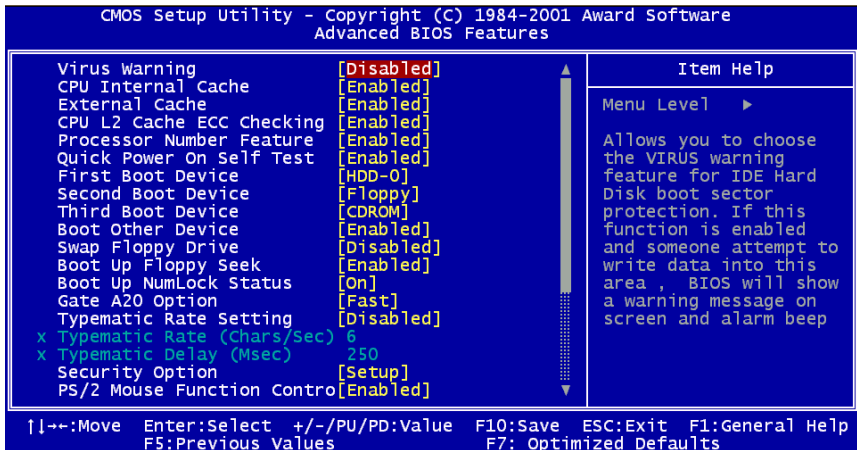

Advanced Chipset Features setup

By choosing the Advanced Chipset Features option from the Initial Setup Screen menu, the screen below is displayed.

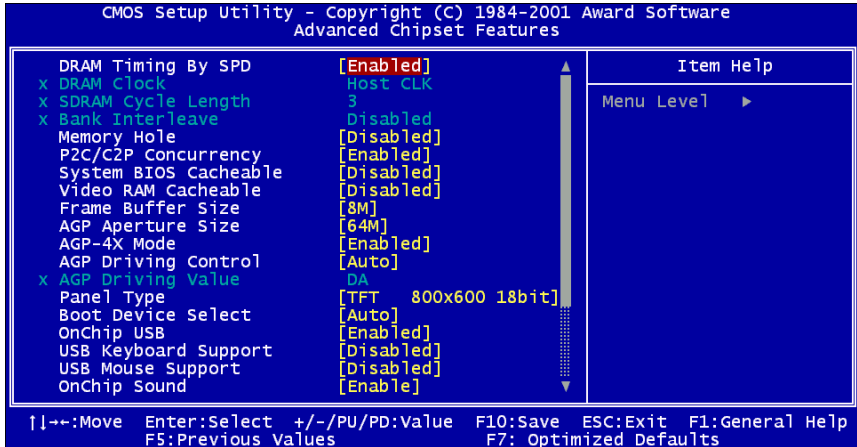

Note: It is strongly recommended that setup items in this section NOT be changed, because advanced knowledge is required to effect such changes.

Integrated Peripherals

Choosing the Integrated Peripherals option from the Initial Setup Screen menu should produce the screen below. Here we see the default values for the PC-3200.

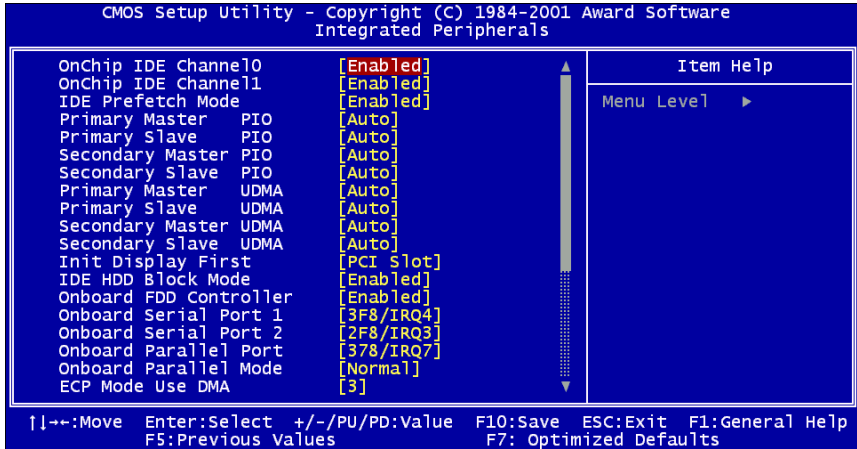

Power Management Setup

By choosing the Power Management Setup option from the Initial Setup Screen menu, the screen below is displayed.

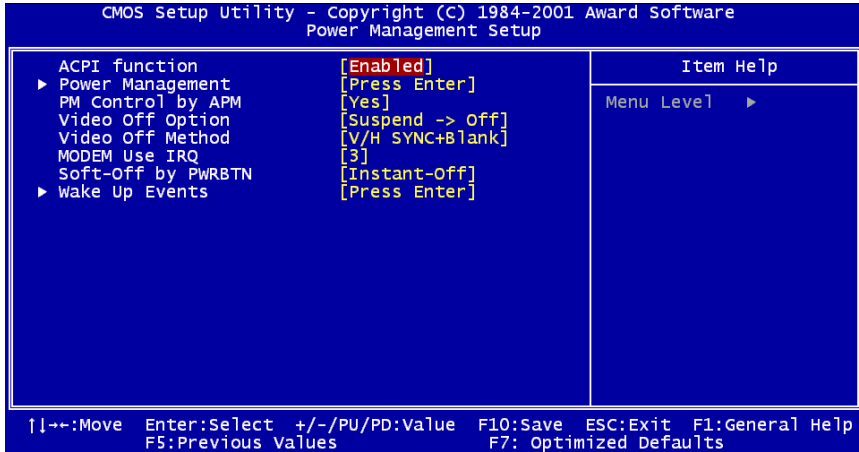

PnP/PCI Configurations

By choosing the PnP/PCI Configurations option from the Initial Setup Screen menu, the screen below is displayed.

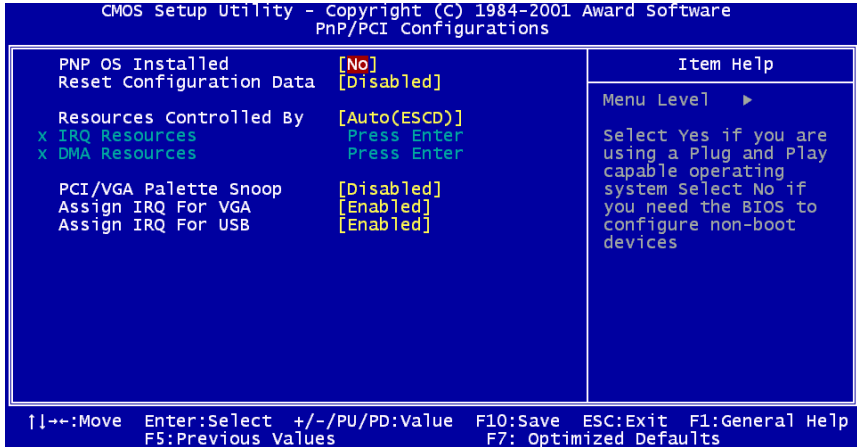

PC Health Status

The PC Health Status option displays information such as CPU and motherboard temperatures, fan speeds, and core voltage.

```
CMOS Setup Utility - Copyright (C) 1984-2001 Award Software
PC Health Status

Current CPU Temp.
Current System Temp.
Current CPUFAN1 Speed
Current CPUFAN2 Speed
Vcore
 2.5V
 3.3V
 5V
 12V

Item Help
Menu Level ►

↑↓←→:Move  Enter:Select  +/-/PU/PD:Value  F10:Save  ESC:Exit  F1:General Help
F5:Previous Values  F7: Optimized Defaults
```

Frequency/Voltage Control

By choosing the Frequency/Voltage Control option from the Initial Setup Screen menu, the screen below is displayed.

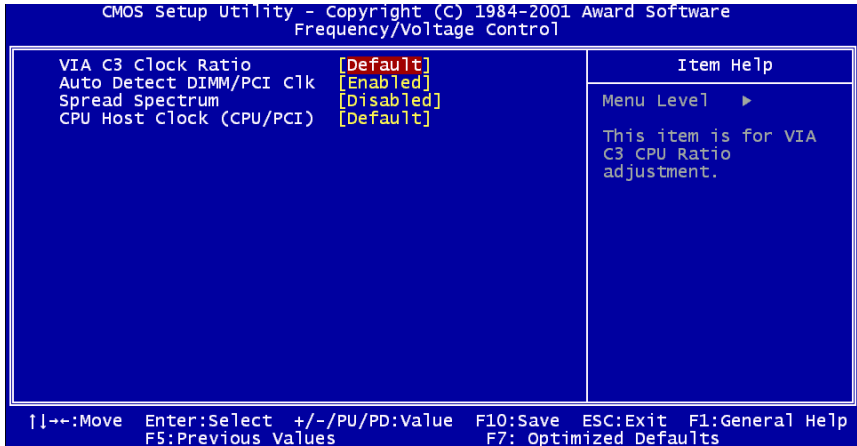

Warning *Incorrect settings in Frequency/Voltage Control may damage the system CPU, video adapter, or other hardware.*

Load Optimized Defaults

Load Optimized Defaults loads the default system values directly from ROM. If the stored record created by the Setup program should ever become corrupted (and therefore unusable), these defaults will load automatically when you turn the PC-3200 system on.

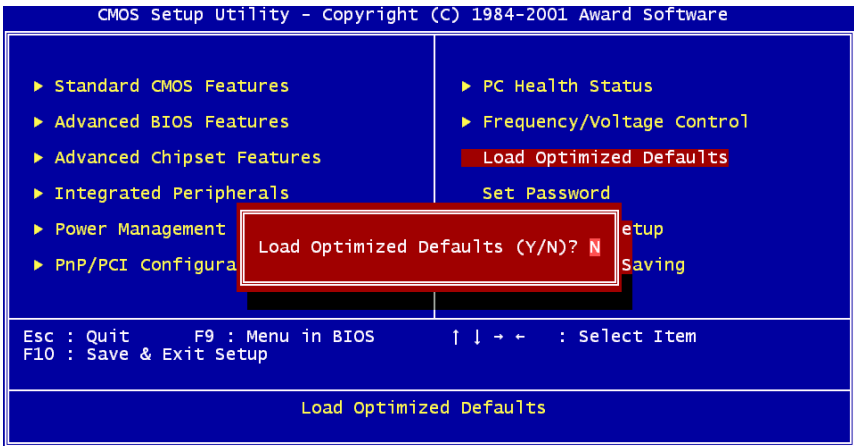

Set Password

To Establish Password

1. Choose the Set Password option from the CMOS Setup Utility main menu and press <Enter>.
2. When you see “Enter Password,” enter the desired password and press <Enter>.
3. At the “Confirm Password” prompt, retype the desired password, then press <Enter>.
4. Select Save to CMOS and EXIT, type <Y>, then <Enter>.

To Change Password

1. Choose the Set Password option from the CMOS Setup Utility main menu and press <Enter>.
2. When you see “Enter Password,” enter the existing password and press <Enter>.
3. You will see “Confirm Password.” Type it again, and press <Enter>.
4. Select Set Password again, and at the “Enter Password” prompt, enter the new password and press <Enter>.
5. At the “Confirm Password” prompt, retype the new password, and press <Enter>.
6. Select Save to CMOS and EXIT, type <Y>, then <Enter>.

To Disable Password

1. Choose the Set Password option from the CMOS Setup Utility main menu

and press <Enter>.

2. When you see “Enter Password,” enter the existing password and press <Enter>.
3. You will see “Confirm Password.” Type it again, and press <Enter>.
4. Select Set Password again, and at the “Enter Password” prompt, don’t enter anything; just press <Enter>.
5. At the “Confirm Password” prompt, again don’t type in anything; just press <Enter>.
6. Select Save to CMOS and EXIT, type <Y>, then <Enter>.

Save & Exit Setup

If you select this option and press <Y> then <Enter>, the values entered in the setup utilities will be recorded in the chipset's CMOS memory. The microprocessor will check this every time you turn your system on and use the settings to configure the system. This record is required for the system to operate.

Exit Without Saving

Selecting this option and pressing <Enter> lets you exit the Setup program without recording any new values or changing old ones.

Chapter

6

Drivers Installation

The PC-3200 comes with a CD, which contains most of drives and utilities of your needs.

There are several ways of installation depending on the driver package under different Operating System application.

If you utilize Windows NT series OS, you are strongly recommended to download the latest version Windows NT Service Pack from Microsoft website and install it before installing any driver.

Note: For Touchscreen installation please refers to the excel file:

ReadMe_All-Prods-Touch-list.xls to find out your match touchscreen type and follow the installation guide in respective folders.

5.1 Installation 1:

Applicable for Windows 9x/NT4.0/2000/XP

1. Insert the PC-3200 CD Diskette into the CD ROM Drive.
2. From the CD ROM, select the desired component Driver folder; select the desired Operation System folder to double click on the Setup.exe icon. A driver installation screen will appear.

(Notice: take VGA driver installation under Windows 98 for example, choose the corresponding folder depending on your OS)

3. A driver installation screen will appear, please follow the onscreen instructions to install the driver in sequence and click on the Next button.

(Notice: In some cases the system will ask you to insert Windows 98 CD Diskette and key in its path. Then click on the OK button to key in path.)

4. Click on the **Finish** button to finish installation process. And allows the system to reboot.

(Notice: After finished touchscreen installing, calibrate the touchscreen controller.)

Installation 2:

Applicable for Windows 9x/2000/ME/XP

1. Insert the **PC-3200 CD Diskette** into the CD ROM Drive.
2. Click on **Start** button, select the **Settings**, and then click on the **Control Panel** icon.
3. Double click on the **Add/Remove Hardware** icon and **Add New Hardware Wizard** will appear. Click on the **Next** button.
4. Select **Search for the best driver for your device (Recommended)** and click on the **Next** button.
5. Select **Specify a location**, click on **Have Disk** button then key in the CD-ROM path and specify component drivers and OS folders. Then click on the **Next** button.
6. The Wizard shows that Windows driver file search for the device: (For example, Ethernet devices, the list appear **Realtek RTL8139/810X Family PCI Fast Ethernet NIC (8-23-2001)**). Click on the **Next** button.
7. The system will ask you to insert Windows 98 CD Diskette. Click on the **OK** button to insert Diskette and key in path.
8. Click on the **OK** button.
9. Click on the **Finish** button to finish installation process. And allows the system to reboot.

Installation 3:

Applicable for Windows NT 4.0

1. Insert the **PC-3200 CD Diskette** into the CD ROM Drive.
2. Start system with Windows NT 4.0 installed.
IMPORTANT: When the "Please select the operating system to start..." message is displayed, select "Windows NT Workstation Version 4.00 [VGA mode]".

3. From **Start**, select the **Settings group**, and then click on the **Control Panel** icon.
4. In the **Control Panel**, select the desired device and click on the icon.
5. Follow the step-by-step instruction and click on **OK** button.
6. Click on the **Have Disk...** button.
7. Key in CD-ROM path and specify component drivers, then click on the **OK** button.
8. From the list of displayed devices, select your desired device.
9. If a message appears stating the driver is already installed on the system, and asks if you want to use the current or new drivers, be sure to select the **New** button.
10. If prompted for the driver diskette a second time, click on the **Continue** button.
(Notice: In some cases the system will ask you to insert Windows NT CD Diskette. Follow its instructions to complete the setup procedures.)
11. When the message **The drivers were successfully installed** is displayed, remove the display driver diskette, then click on the **OK** button.
12. Reboot the system