

OMNI-SKU Series

Industrial Modular Touch Panel PC
With 6th Gen. Intel[®] Core[™] Processor
(Formerly code name: Skylake)

User's Manual 5th Ed

Copyright Notice

This document is copyrighted, 2019. All rights are reserved. The original manufacturer reserves the right to make improvements to the products described in this manual at any time without notice.

No part of this manual may be reproduced, copied, translated, or transmitted in any form or by any means without the prior written permission of the original manufacturer. Information provided in this manual is intended to be accurate and reliable. However, the original manufacturer assumes no responsibility for its use, or for any infringements upon the rights of third parties that may result from its use.

The material in this document is for product information only and is subject to change without notice. While reasonable efforts have been made in the preparation of this document to assure its accuracy, AAEMON assumes no liabilities resulting from errors or omissions in this document, or from the use of the information contained herein.

AAEMON reserves the right to make changes in the product design without notice to its users.

Acknowledgement

All other products' name or trademarks are properties of their respective owners.

- Microsoft Windows is a registered trademark of Microsoft Corp.
- Intel, Pentium, Celeron, and Xeon are registered trademarks of Intel Corporation
- Core, Atom are trademarks of Intel Corporation
- ITE is a trademark of Integrated Technology Express, Inc.
- IBM, PC/AT, PS/2, and VGA are trademarks of International Business Machines Corporation.

All other product names or trademarks are properties of their respective owners.

Packing List

Before setting up your product, please make sure the following items have been shipped:

Item	Quantity
OMNI-SKU Series Panel PC (panel size from 10.4 – 21.5")	1
Product DVD	1
Phoenix Power Connector	1

If any of these items are missing or damaged, please contact your distributor or sales representative immediately.

About this Document

This User's Manual contains all the essential information, such as detailed descriptions and explanations on the product's hardware and software features (if any), its specifications, dimensions, jumper/connector settings/definitions, and driver installation instructions (if any), to facilitate users in setting up their product.

Users may refer to the AAEON.com for the latest version of this document.

Safety Precautions

Please read the following safety instructions carefully. It is advised that you keep this manual for future references

1. All cautions and warnings on the device should be noted.
2. All cables and adapters supplied by AAEON are certified and in accordance with the material safety laws and regulations of the country of sale. Do not use any cables or adapters not supplied by AAEON to prevent system malfunction or fires.
3. Make sure the power source matches the power rating of the device.
4. Position the power cord so that people cannot step on it. Do not place anything over the power cord.
5. Always completely disconnect the power before working on the system's hardware.
6. No connections should be made when the system is powered as a sudden rush of power may damage sensitive electronic components.
7. If the device is not to be used for a long time, disconnect it from the power supply to avoid damage by transient over-voltage.
8. Always disconnect this device from any AC supply before cleaning.
9. While cleaning, use a damp cloth instead of liquid or spray detergents.
10. Make sure the device is installed near a power outlet and is easily accessible.
11. Keep this device away from humidity.
12. Place the device on a solid surface during installation to prevent falls
13. Do not cover the openings on the device to ensure optimal heat dissipation.
14. Watch out for high temperatures when the system is running.
15. Do not touch the heat sink or heat spreader when the system is running
16. Never pour any liquid into the openings. This could cause fire or electric shock.

17. As most electronic components are sensitive to static electrical charge, be sure to ground yourself to prevent static charge when installing the internal components. Use a grounding wrist strap and contain all electronic components in any static-shielded containers.
18. If any of the following situations arises, please the contact our service personnel:
 - i. Damaged power cord or plug
 - ii. Liquid intrusion to the device
 - iii. Exposure to moisture
 - iv. Device is not working as expected or in a manner as described in this manual
 - v. The device is dropped or damaged
 - vi. Any obvious signs of damage displayed on the device
19. **DO NOT LEAVE THIS DEVICE IN AN UNCONTROLLED ENVIRONMENT WITH TEMPERATURES BEYOND THE DEVICE'S PERMITTED STORAGE TEMPERATURES (SEE CHAPTER 1) TO PREVENT DAMAGE.**

FCC Statement

Warning!



This device complies with Part 15 FCC Rules. Operation is subject to the following two conditions: (1) this device may not cause harmful interference, and (2) this device must accept any interference received including interference that may cause undesired operation.

Caution:

There is a danger of explosion if the battery is incorrectly replaced. Replace only with the same or equivalent type recommended by the manufacturer. Dispose of used batteries according to the manufacturer's instructions and your local government's recycling or disposal directives.

Attention:

Il y a un risque d'explosion si la batterie est remplacée de façon incorrecte. Ne la remplacer qu'avec le même modèle ou équivalent recommandé par le constructeur. Recycler les batteries usées en accord avec les instructions du fabricant et les directives gouvernementales de recyclage.

China RoHS Requirements (CN)

产品中有毒有害物质或元素名称及含量

AAEON System

QQ4-381 Rev.A0

部件名称	有毒有害物质或元素					
	铅 (Pb)	汞 (Hg)	镉 (Cd)	六价铬 (Cr(VI))	多溴联苯 (PBB)	多溴二苯醚 (PBDE)
印刷电路板及其电子组件	X	○	○	○	○	○
外部信号连接器及线材	X	○	○	○	○	○
外壳	○	○	○	○	○	○
中央处理器与内存	X	○	○	○	○	○
硬盘	X	○	○	○	○	○
液晶模块	X	×	○	○	○	○
光驱	X	○	○	○	○	○
触控模块	X	○	○	○	○	○
电源	X	○	○	○	○	○
电池	X	○	○	○	○	○

本表格依据 SJ/T 11364 的规定编制。

○：表示该有毒有害物质在该部件所有均质材料中的含量均在 GB/T 26572标准规定的限量要求以下。

×：表示该有害物质的某一均质材料超出了GB/T 26572的限量要求，然而该部件仍符合欧盟指令2011/65/EU 的规范。

备注：

- 一、此产品所标示之环保使用期限，系指在一般正常使用状况下。
- 二、上述部件物质中央处理器、内存、硬盘、光驱、电源为选购品。
- 三、上述部件物质液晶模块、触控模块仅一体机产品适用。

China RoHS Requirement (EN)

Hazardous and Toxic Materials List

AAEON System

QO4-381 Rev.A0

Component Name	Hazardous or Toxic Materials or Elements					
	Lead (Pb)	Mercury (Hg)	Cadmium (Cd)	Hexavalent Chromium (Cr(VI))	Polybrominated biphenyls (PBBS)	Polybrominated diphenyl ethers (PBDES)
PCB and Components	X	O	O	O	O	O
Wires & Connectors for Ext.Connections	X	O	O	O	O	O
Chassis	O	O	O	O	O	O
CPU & RAM	X	O	O	O	O	O
HDD Drive	X	O	O	O	O	O
LCD Module	X	X	O	O	O	O
Optical Drive	X	O	O	O	O	O
Touch Control Module	X	O	O	O	O	O
PSU	X	O	O	O	O	O
Battery	X	O	O	O	O	O

This form is prepared in compliance with the provisions of SJ/T 11364.

O: The level of toxic or hazardous materials present in this component and its parts is below the limit specified by GB/T 26572.

X: The level of toxic of hazardous materials present in the component exceed the limits specified by GB/T 26572, but is still in compliance with EU Directive 2011/65/EU (RoHS 2).

Notes:

- The Environment Friendly Use Period indicated by labelling on this product is applicable only to use under normal conditions.
- Individual components including the CPU, RAM/memory, HDD, optical drive, and PSU are optional.
- LCD Module and Touch Control Module only applies to certain products which feature these components.

Table of Contents

- Chapter 1 - Product Specifications..... 1**
 - 1.1 Specifications..... 2
 - 1.1.1 OMNI-3105-SKU..... 4
 - 1.1.2 OMNI-3125-SKU..... 6
 - 1.1.3 OMNI-3155-SKU..... 8
 - 1.1.4 OMNI-2155-SKU..... 10
 - 1.1.5 OMNI-3175-SKU..... 12
 - 1.1.6 OMNI-3195-SKU..... 14
 - 1.1.7 OMNI-2215-SKU..... 16
 - 1.2 OMNI Modules 18
 - 1.2.1 USB/ COM/ LAN Module 18
 - 1.2.2 Dual LAN Module..... 18
 - 1.2.3 MiniCard and SIM Card Module..... 19
 - 1.2.4 RS-232/422/485 Module 19
 - 1.2.5 Isolated RS-232/422/485 Module 20
 - 1.2.6 Digital I/O Module..... 20
 - 1.2.7 CAN Bus Module 20
 - 1.2.8 Audio Module..... 21
 - 1.2.9 HMS Module 21
 - 1.2.10 COM x 4 + DIO x 16 Module 21
- Chapter 2 – Hardware Information..... 22**
 - 2.1 Dimensions 23
 - 2.1.1 Dimensions: Main Panels 23
 - 2.1.2 Dimensions: OMNI Modules..... 24
 - 2.1.3 Dimensions: Cables 27
 - 2.2 List of Jumpers 28

2.2.1	mSATA/Mini-Card Operating VCC Selection (JP1).....	29
2.2.2	Resistive Touch Mode (JP2)	29
2.2.3	LVDS Port Backlight Lightness Control Mode Selection (JP3).....	29
2.2.4	LVDS Port Backlight Inverter VCC Selection (JP4)	29
2.2.5	Auto Power Button Enable/Disable Selection (JP5)	30
2.2.6	Clear CMOS (JP7).....	30
2.2.7	COM2 Pin8 Function Selection (JP9)	30
2.2.8	COM1 Pin8 Function Selection (JP10)	31
2.3	List of Connectors	32
2.3.1	Front Panel Connector (JP6)	33
2.3.2	Mini-Card Slot (Full-Mini Card) (CN2).....	33
2.3.3	Touch Screen Connector (CN3).....	35
2.3.4	Micro SIM Card Socket (CN4).....	37
2.3.5	eDP/LVDS Port (CN5)	37
2.3.6	LVDS Port Inverter / Backlight Connector (CN8).....	40
2.3.7	LPC Port (CN11)	41
2.3.8	+5V Output for SATA HDD (CN12).....	41
2.3.9	SATA Port (CN13).....	42
2.3.10	BIOS Debug Port (CN14).....	42
2.3.11	HDMI Connector (CN15).....	43
2.3.12	USB 3.0 Ports (CN19).....	44
2.3.13	Battery (CN20).....	45
2.3.14	CPU FAN (Optional) (CN21).....	45
2.3.15	LAN (RJ45) Connector (CN23)	45
2.3.16	External Power Input (CN25).....	47
2.3.17	COM Port 2 (CN26).....	47
2.3.18	COM Port 1 (CN27).....	48
2.4	Assembling Modules.....	51

2.5	Installing the Hard Disk Drive.....	53
2.6	Installing DRAM.....	55
2.7	Mount the OMNI onto the wall.....	56
2.8	Assemble the OMNI panel and the CPU Box.....	58
2.9	P-CAP Touch Screen Operating.....	61
Chapter 3 - AMI BIOS Setup.....		62
3.1	System Test and Initialization	63
3.2	AMI BIOS Setup.....	64
3.3	Setup Submenu: Main	65
3.4	Setup Submenu: Advanced.....	66
3.4.1	Advanced: CPU Configuration	67
3.4.2	Advanced: SATA Configuration	69
3.4.3	Advanced: Hardware Monitor	70
3.4.4	Advanced: SIO Configuration.....	71
3.4.4.1	SIO Configuration: Serial Port 1 Configuration	72
3.4.4.2	SIO Configuration: Serial Port 2 Configuration.....	73
3.4.5	Advanced: USB Configuration.....	74
3.4.6	Advanced: Digital IO Port Configuration.....	75
3.4.7	Advanced: Power Management	76
3.5	Setup submenu: Chipset.....	78
3.5.1	Chipset: System Agent (SA) Configuration	79
3.5.1.1	System Agent (SA) Configuration: Graphics Configuration....	80
3.5.1.1.1	Graphics Configuration: LVDS Panel Configuration.....	81
3.5.2	Chipset: PCH-IO Configuration.....	82
3.6	Setup submenu: Security	83
3.7	Setup submenu: Boot.....	84
3.8	Boot: BBS Priorities	85
3.9	Setup submenu: Save & Exit.....	86

Chapter 4 – Drivers Installation & Touchscreen Settings	87
4.1 Product CD/DVD.....	88
4.2 PCAP Dual Monitor Touch Settings.....	96
Appendix A – Watchdog Timer Programming.....	98
A.1 Watchdog Timer Initial Program.....	99
Appendix B – I/O Information.....	101
B.1 I/O Address Map.....	102
B.2 Memory Address Map.....	104
B.3 IRQ Mapping Chart.....	106
Appendix C – CANBus Utility (for CANBus Module).....	119
C.1 CANBus Driver Installation	120
C.2 CANBus Utility.....	124
C.3 Mask and Filter Function.....	126
Appendix D –Electrical Specifications for I/O Ports.....	127
D.1 Digital I/O Register	128
D.2 Digital I/O Sample Program.....	129

Chapter 1

Product Specifications

1.1 Specifications

Specifications for System and Power Supply are same for all models/SKUs of OMNI-SKU series. All other specifications are listed by SKU in the following sub-sections.

System

Processor	Intel® Core™ i5-6300U processor, 2.4 GHz Intel® Celeron® 3955U processor, 2.0 GHz
System Memory	260-pin DDR4 SODIMM x 1, up to 16 GB
LCD/CRT Controller	Integrated in processor
Ethernet	Intel® I211, 10/100/1000Base-TX x 1
I/O Port	USB 3.0 Type A x 4 SMA Antenna hole x 1 HDMI x 1 DB-9 Type RS-232/422/485 x 2 RJ-45 Type 10/100/1000Base-TX x 1 3-pin terminal block x1 for 9~30 VDC power input LED Power on/off switch x1 (Power on = Orange, Power off =N/A)
Storage Disk Drive	2.5" SATA HDD bay x 1
Expansion Slot	Full Size Mini card x 1 SIM card x 1 OMNI I/O connector x 1

System

OS support	Windows® 8.1
	Windows® 10 (64 bit)
	Linux Kernel 2.6.x or higher

Power Supply

DC Input	DC 9 (min.) ~ 30 (max.) V w/3-pin terminal block, ATX Power function
----------	--

1.1.1 OMNI-3105-SKU

Mechanical

Construction	Aluminum design (IP65 Front Frame)
Mounting	VESA 100/ Panel Mount
Dimension	11.02" x 9.41" x 2.87" (280mm x 239mm x 73 mm)
Carton Dimension	16.34" x 7.05" x 15.39" (415mm x 179mm x 391mm)
Gross Weight	8.82 lbs. (4 kg)

Environmental

Operating Temperature	-4°F ~ 131°F (-20°C ~ 55°C) with 0.5 m/s airflow (Industrial Grade HDD)
Storage Temperature	-4°F ~ 158°F (-20°C ~ 70°C)
Storage Humidity	90% @40°C; non-condensing
Vibration	1 Grms/ 5~ 500Hz/ operation – with HDD
Shock	--
EMC	CE/FCC class A

LCD

Display Type	10.4" TFT-LCD, LED
Max Resolution	800(H) x 600(V)
Max. Colors	16.2M colors
Luminance	230 cd/m ²
Viewing Angle	120 (H), 100 (V)
Back Light	LED
Back Light MTBF (Hours)	50,000

Touchscreen

Type	P-CAP/ 5-wire resistive
Light Transmission	P-CAP (90% ± 3%), 5-wire Resistive (80% ± 3%)

1.1.2 OMNI-3125-SKU

Mechanical

Construction	Aluminum design (IP65 Front Frame)
Mounting	VESA 100 / Panel Mount
Dimension	12.95" x 11.34" x 2.72" (329mm x 288mm x 69 mm)
Carton Dimension	20.87" x 17.52" x 7.87" (530mm x 445mm x 200mm)
Gross Weight	12.34 lbs. (5.6 kg)

Environmental

Operating Temperature	-4°F ~ 131°F (-20°C ~ 55°C) with 0.5 m/s airflow (Industrial Grade HDD)
Storage Temperature	-4°F ~ 158°F (-20°C ~ 70°C)
Storage Humidity	90% @40°C; non-condensing
Vibration	1 Grms/ 5~ 500Hz/ operation – with HDD
Shock	--
EMC	CE/FCC class A

LCD

Display Type	12.1" TFT-LCD, LED
Max Resolution	1024(H) x 768(V)
Max. Colors	16.2M colors
Luminance	500 cd/m ²
Viewing Angle	160° (H), 160° (V)
Back Light	LED
Back Light MTBF (Hours)	50,000

Touchscreen

Type	P-CAP/ 5-wire resistive
Light Transmission	P-CAP (90% ± 3%), 5-wire Resistive (80% ± 3%)

1.1.3 OMNI-3155-SKU

Mechanical

Construction	Aluminum design (IP65 Front Frame)
Mounting	VESA 100/ Panel Mount
Dimension	14.53" x 12.36" x 2.79" (369mm x 314mm x 71 mm)
Carton Dimension	20.08" x 9.84" x 18.11" (510mm x 250mm x 460mm)
Gross Weight	14.3 lbs. (6.5 kg)

Environmental

Operating Temperature	-4°F ~ 131°F (-20°C ~ 55°C) with 0.5 m/s airflow (Industrial Grade HDD)
Storage Temperature	-4°F ~ 158°F (-20°C ~ 70°C)
Storage Humidity	90% @40°C; non-condensing
Vibration	1 Grms/ 5~ 500Hz/ operation – with HDD
Shock	--
EMC	CE/FCC class A

LCD

Display Type	15" TFT-LCD, LED
Max Resolution	1024(H) x 768(V)
Max. Colors	16.2M (8bit/color)
Luminance	300 cd/m ²
Viewing Angle	176° (H), 176° (V)
Back Light	LED
Back Light MTBF (Hours)	70,000

Touchscreen

Type	P-CAP/ 5-wire resistive
Light Transmission	P-CAP (90%± 2%), 5-wire Resistive (80% ± 2%)

1.1.4 OMNI-2155-SKU

Mechanical

Construction	Aluminum design (IP65 Front Frame)
Mounting	VESA 100 / Panel Mount
Dimension	16.54" x 10.43" x 2.87" (420 mm x 265 mm x 73 mm)
Carton Dimension	20.87" x 17.52" x 7.87" (530mm x 445mm x 200mm)
Gross Weight	14.96 lbs. (6.8 kg)

Environmental

Operating Temperature	-4°F ~ 131°F (-20°C ~ 55°C) with 0.5 m/s airflow (Industrial Grade HDD)
Storage Temperature	-4°F ~ 158°F (-20°C ~ 70°C)
Storage Humidity	90% @40°C; non-condensing
Vibration	1 Grms/ 5~ 500Hz/ operation – with HDD
Shock	--
EMC	CE/FCC class A

LCD

Display Type	15.6" TFT-LCD, LED
Max Resolution	1366(H) x 768(V)
Max. Colors	16.7M (8 bit/color)
Luminance	400 cd/m ²
Viewing Angle	160 (H), 140 (V)
Back Light	LED
Back Light MTBF (Hours)	50,000

Touchscreen

Type	P-CAP/ 5-wire resistive
Light Transmission	P-CAP (90% ± 3%), 5-wire Resistive (80% ± 2%)

1.1.5 OMNI-3175-SKU

Mechanical

Construction	Aluminum design (IP65 Front Frame)
Mounting	VESA 100 / Panel Mount
Dimension	16.14" x 14.57" x 2.32" (410mm x 370mm) x 59mm)
Carton Dimension	20.55" x 10.31" x 19.29"(522mm x 262mm x 490mm)
Gross Weight	16.28 lbs. (7.4 kg)

Environmental

Operating Temperature	-4°F ~ 131°F (-20°C ~ 55°C) with 0.5 m/s airflow (Industrial Grade HDD)
Storage Temperature	-4°F ~ 158°F (-20°C ~ 70°C)
Storage Humidity	90% @40°C; non-condensing
Vibration	1 Grms/ 5~ 500Hz/ operation – with HDD
Shock	--
EMC	CE/FCC class A

LCD

Display Type	17" TFT-LCD, LED
Max Resolution	1280(H) x 1024(V)
Max. Colors	16.7M colors (RGB 6-bits + Hi-FRC data)
Luminance	350 cd/m ²
Viewing Angle	170 (H), 160 (V)
Back Light	LED
Back Light MTBF (Hours)	50,000

Touchscreen

Type	P-CAP/ 5-wire resistive
Light Transmission	P-CAP (90% ± 3%), 5-wire Resistive (80% ± 3%)

1.1.6 OMNI-3195-SKU

Mechanical

Construction	Aluminum design (IP65 Front Frame)
Mounting	VESA 100 / Panel Mount
Dimension	18.14" x 16.14" x 2.83" (460.8mm x 410mm x 72 mm)
Carton Dimension	26.02" x 8.11" x 19.53" (661mm x 206mm x 496mm)
Gross Weight	20.06 lbs. (9.1 kg)

Environmental

Operating Temperature	-4°F ~ 131°F (-20°C ~ 55°C) with 0.5 m/s airflow (Industrial Grade HDD)
Storage Temperature	-4°F ~ 158°F (-20°C ~ 70°C)
Storage Humidity	90% @40°C; non-condensing
Vibration	1 Grms/ 5~ 500Hz/ operation – with HDD
Shock	--
EMC	CE/FCC class A

LCD

Display Type	17" TFT-LCD, LED
Max Resolution	1280(H) x 1024(V)
Max. Colors	16.7M colors (RGB 6-bits + Hi-FRC data)
Luminance	350 cd/m ²
Viewing Angle	170 (H), 160 (V)
Back Light	LED
Back Light MTBF (Hours)	50,000

Touchscreen

Type	P-CAP/ 5-wire resistive
Light Transmission	P-CAP (90% ± 3%), 5-wire Resistive (80% ± 3%)

1.1.7 OMNI-2215-SKU

Mechanical

Construction	Aluminum design (IP65 Front Frame)
Mounting	VESA 100/ Panel Mount
Dimension	21.7" x 14.7" x 2.6" (550mm x 373mm x 66mm)
Carton Dimension	26.38" x 7.87" x 20.67" (670mm x 200mm x 525mm)
Gross Weight	20.02 lbs. (9.1 kg)

Environmental

Operating Temperature	-4°F ~ 131°F (-20°C ~ 55°C) with 0.5 m/s airflow (Industrial Grade HDD)
Storage Temperature	-4°F ~ 158°F (-20°C ~ 70°C)
Storage Humidity	90% @40°C; non-condensing
Vibration	1 Grms/ 5~ 500Hz/ operation – with HDD
Shock	--
EMC	CE/FCC class A

LCD

Display Type	21.5" TFT-LCD, LED
Max Resolution	1920(H) x 1080(V)
Max. Colors	16.7M colors
Luminance	250 cd/m ²
Viewing Angle	178 (H), 178 (V)
Back Light	LED
Back Light MTBF (Hours)	50,000

Touchscreen

Type	P-CAP/ 5-wire resistive
Light Transmission	P-CAP (· 85%), 5-wire Resistive (80% ± 5%)

1.2 OMNI Modules

Featuring a modular designed, the OMNI-SKU Series Panel PC can be fitted with a number of modules to expand its base capabilities. Please refer to the sections below for their features.

Note: The interface between the CPU box and the module is through PCIe signal.

1.2.1 USB/ COM/ LAN Module

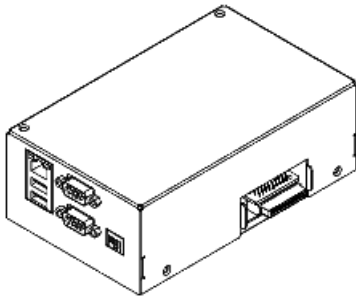

Features

- USB 2.0 x 2
- RS-232/422/485 x 2 (Selectable by external switch)
- Intel 10/100/1000 Giga LAN x 1

1.2.2 Dual LAN Module

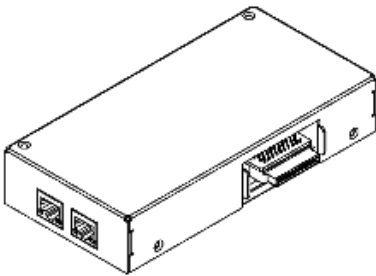

Features

- Intel 10/100/1000 Giga LAN x 2

1.2.3 MiniCard and SIM Card Module

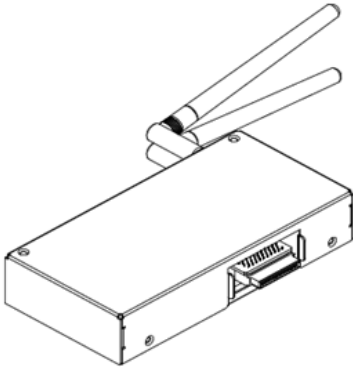

Features

- MiniCard x 2
- SIM Card x 2

1.2.4 RS-232/422/485 Module

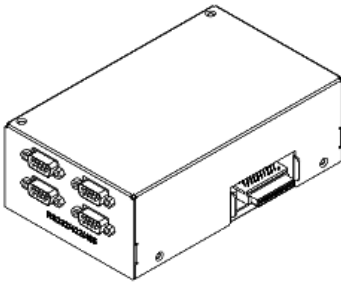

Features

- RS-232/422/485 x 4
(Selectable by jumper)

1.2.5 Isolated RS-232/422/485 Module

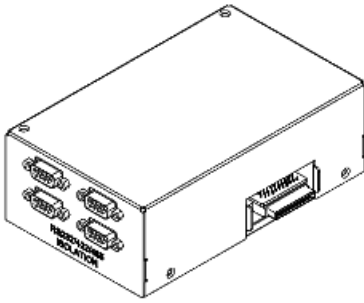

Features

- Isolated RS-232/422/485 x 4 (Selectable by jumper)
- 2k VDC Isolation

1.2.6 Digital I/O Module

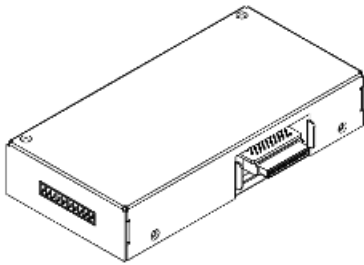

Features

- Digital I/O x 8

1.2.7 CAN Bus Module

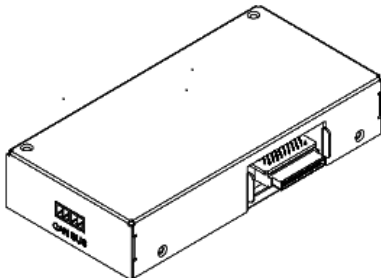

Features

- CAN Bus with Phoenix connectors
- 2k VDC Isolation
- Support plug and play after installing driver

1.2.8 Audio Module

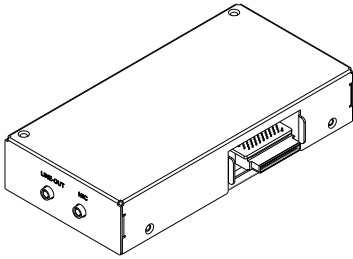

Features

- Mic-in
- Line-out
- Support plug and play after installing driver & reboot

1.2.9 HMS Module

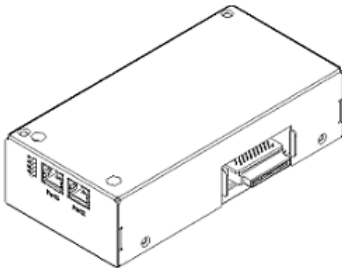

Features

- 10/100 Ethernet x 2

1.2.10 COM x 4 + DIO x 16 Module

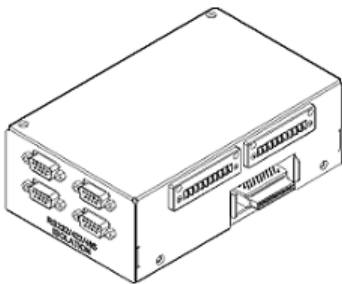

Features

- Isolated RS-232/422/485 x 4
- Digital I/O x8

Chapter 2

Hardware Information

2.1 Dimensions

2.1.1 Dimensions: Main Panels

OMNI-2155-SKU

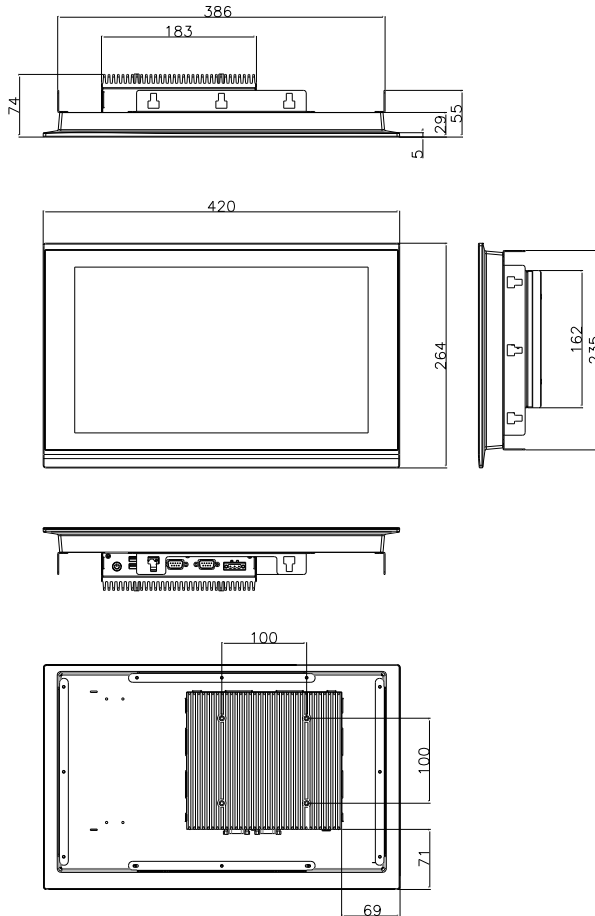

2.1.2 Dimensions: OMNI Modules

USB/ CAN/ LAN Module

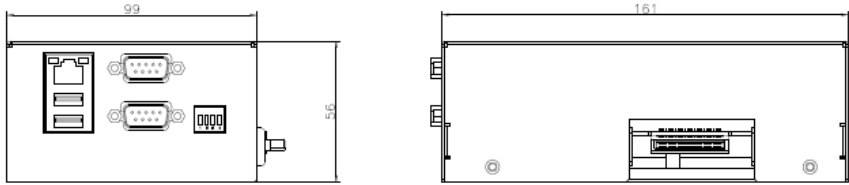

Dual LAN Module

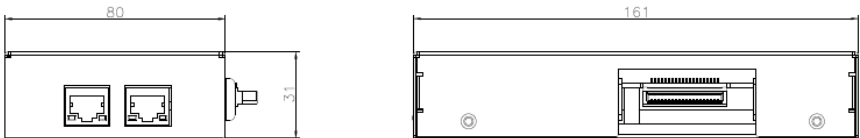

MiniCard & SIM Card Module

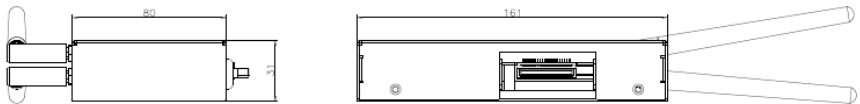

RS-232/422/485 Module

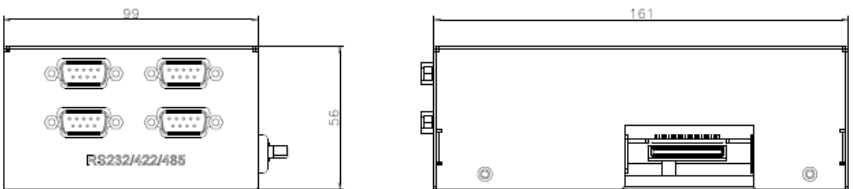

Isolated RS-232/422/485 Module

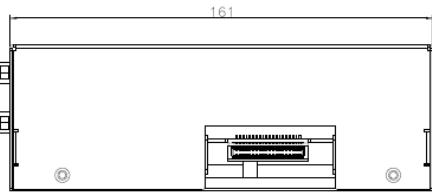
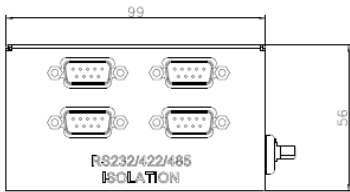

Digital I/O Module

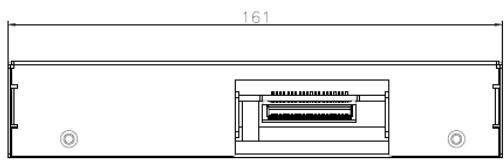
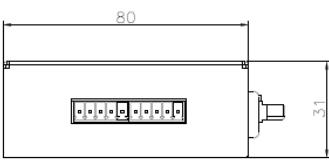

CAN Bus Module

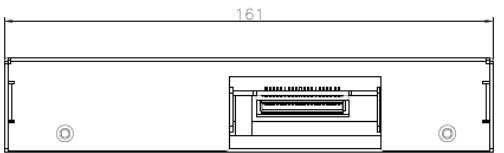
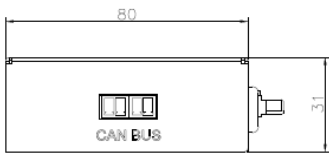

Audio Module

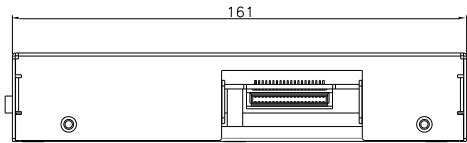
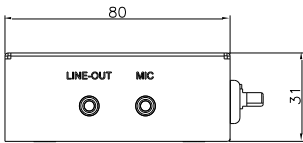

HMS Module

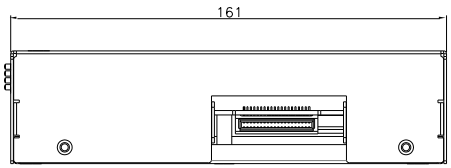
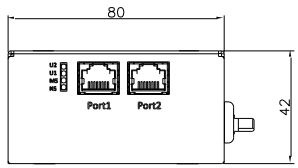

COM x 4 + DIO x 16 Module

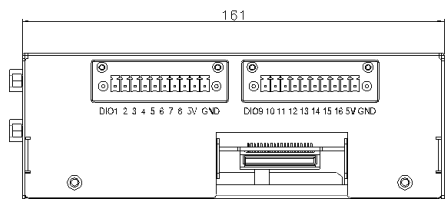
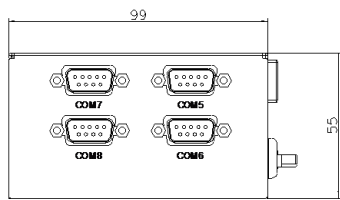

2.1.3 Dimensions: Cables

Touch and Panel Select Cable

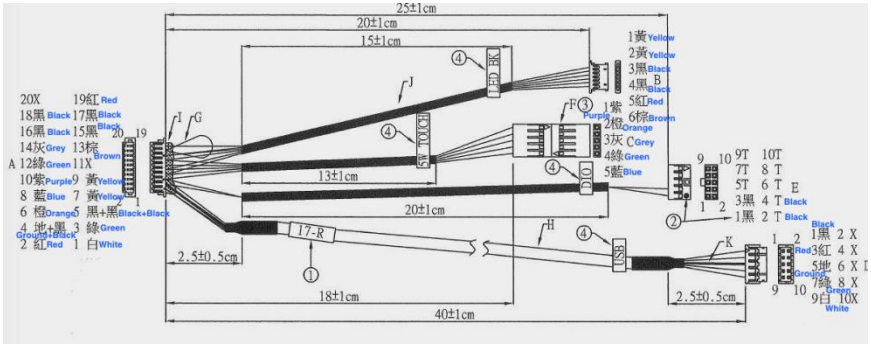

LVDS Cable

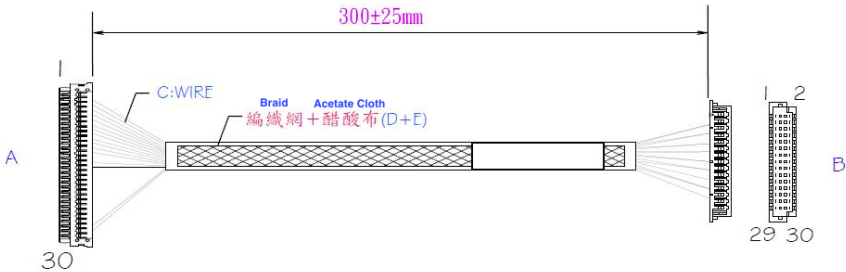

2.2 List of Jumpers

Please refer to the table below for all of the system's jumpers that you can configure for your application

Label	Function
JP1	mSATA/Mini-Card Operating VCC Selection
JP2	Resistive Touch Mode
JP3	LVDS Port Backlight Lightness Control Mode Selection
JP4	LVDS Port Backlight Inverter VCC Selection
JP5	Auto Power Button Enable/Disable Selection
JP7	Clear CMOS Jumper
JP8	Panel Select ID (Auto detect by LCD kit cable)
JP9	COM2 Pin8 Function Selection
JP10	COM1 Pin8 Function Selection

2.2.1 mSATA/Mini-Card Operating VCC Selection (JP1)

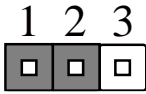

mSATA



Mini-Card (Default)

2.2.2 Resistive Touch Mode (JP2)

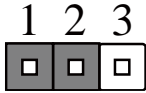

4/8 Wires Mode

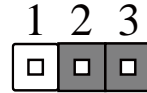

5 Wires Mode (Default)

2.2.3 LVDS Port Backlight Lightness Control Mode Selection (JP3)

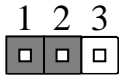

VR Mode

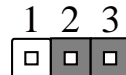

PWM Mode (Default)

2.2.4 LVDS Port Backlight Inverter VCC Selection (JP4)

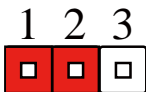

+12V (Default)

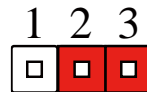

+5V

2.2.5 Auto Power Button Enable/Disable Selection (JP5)

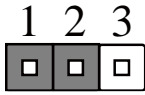

Disable (Default)

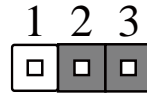

Enable

2.2.6 Clear CMOS (JP7)

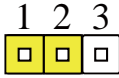

Normal (Default)

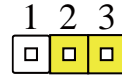

Clear CMOS

2.2.7 COM2 Pin8 Function Selection (JP9)

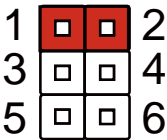

+12V

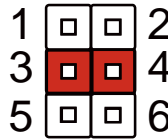

Ring(Default)

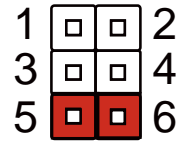

+5V

2.2.8 COM1 Pin8 Function Selection (JP10)

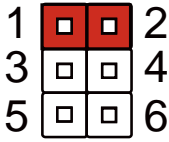

+12V

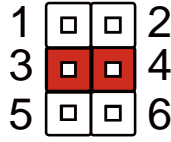

Ring(Default)

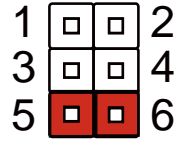

+5V

2.3 List of Connectors

Please refer to the table below for all of the system's connectors that you can configure for your application

Label	Function
JP6	Front Panel Connector
CN1	VGA Connector(Optional)
CN2	Mini-Card Slot (Full-Mini Card)
CN3	Touch Screen Connector
CN4	Micro SIM Card Socket
CN5	eDP/LVDS Port
CN6	Omni Panel Wire Type
CN7	LVDS Port Inverter / Backlight Connector Ext. I/O
CN8	LVDS Port Inverter / Backlight Connector
CN9	USB 2.0
CN10	USB 2.0
CN11	LPC Port
CN12	+5V Output for SATA HDD
CN13	SATA Port
CN14	SPI Debug Port
CN15	HDMI
CN16	Speaker R
CN17	Speaker L
CN18	Audio I/O Port
CN19	USB 3.0/2.0 Port
CN20	Battery
CN21	Smart FAN
CN23	LAN Port(RJ45)

CN24	USB 3.0/2.0 Port
CN25	External Power Input
CN26	COM Port 2
CN27	COM Port 1

2.3.1 Front Panel Connector (JP6)

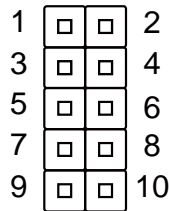

Pin	Signal	Pin	Signal
1	PWR_BTN-	2	PWR_BTN+
3	HDD_LED-	4	HDD_LED+
5	SPEAKER-	6	SPEAKER+
7	PWR_LED-	8	PWR_LED+
9	H/W RESET-	10	H/W RESET+

2.3.2 Mini-Card Slot (Full-Mini Card) (CN2)

Pin	Pin Name	Signal Type	Signal Level
1	PCIE_WAKE#	IN	
2	+3.3VSB	PWR	+3.3V
3	NC		
4	GND	GND	
5	NC		
6	+1.5V	PWR	+1.5V

Pin	Pin Name	Signal Type	Signal Level
7	PCIE_CLK_REQ#	IN	
8	NC	PWR	
9	GND	GND	
10	NC	I/O	
11	PCIE_REF_CLK-	DIFF	
12	NC	IN	
13	PCIE_REF_CLK+	DIFF	
14	NC		
15	GND	GND	
16	NC	PWR	
17	NC		
18	GND	GND	
19	NC		
20	W_DISABLE#	OUT	+3.3V
21	GND	GND	
22	PCIE_RST#	OUT	+3.3V
23	PCIE_RX-/MSATA_RX+	DIFF	
24	+3.3VSB	PWR	+3.3V
25	PCIE_RX+/MSATA_RX-	DIFF	
26	GND	GND	
27	GND	GND	
28	+1.5V	PWR	+1.5V
29	GND	GND	
30	SMB_CLK	I/O	+3.3V
31	PCIE_TX-/MSATA_TX-	DIFF	
32	SMB_DATA	I/O	+3.3V
33	PCIE_TX+/MSATA_TX+	DIFF	

Pin	Pin Name	Signal Type	Signal Level
34	GND	GND	
35	GND	GND	
36	USB_D-	DIFF	
37	GND	GND	
38	USB_D+	DIFF	
39	+3.3VSB	PWR	+3.3V
40	GND	GND	
41	+3.3VSB	PWR	+3.3V
42	NC		
43	GND	GND	
44	NC		
45	NC		
46	NC		
47	NC		
48	+1.5V	PWR	+1.5V
49	NC		
50	GND	GND	
51	NC		
52	+3.3VSB	PWR	+3.3V

2.3.3 Touch Screen Connector (CN3)

8 Wires

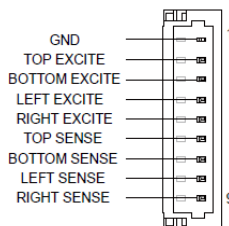

Pin	Signal	Pin	Signal
1	GND	2	TOP EXCITE
3	BOTTOM EXCITE	4	LEFT EXCITE
5	RIGHT EXCITE	6	TOP SENSE
7	BOTTOM SENSE	8	LEFT SENSE
9	RIGHT SENSE		

4 Wires

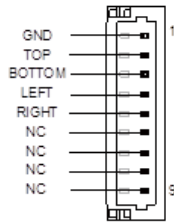

Pin	Signal	Pin	Signal
1	GND	2	TOP
3	BOTTOM	4	LEFT
5	RIGHT	6	NC
7	NC	8	NC
9	NC		

5 Wires

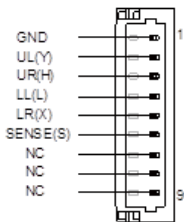

Pin	Signal	Pin	Signal
1	GND	2	UL(Y)

3	UR(H)	4	LL(L)
5	LR(X)	6	SENSE(S)
7	NC	8	NC
9	NC		

2.3.4 Micro SIM Card Socket (CN4)

Pin	Pin Name	Signal Type	Signal Level
1	UIM_PWR	PWR	
2	UIM_RST	IN	
3	UIM_CLK	IN	
4	NC		
5	GND	GND	
6	UIM_VPP	PWR	
7	UIM_DATA	I/O	
8	NC		

2.3.5 eDP/LVDS Port (CN5)

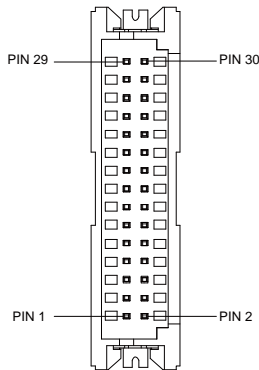

* LVDS LCD_PWR can be set to +3.3V or +5V by cable

LVDS Function

Pin	Pin Name	Signal Type	Signal Level
1	BKL_ENABLE	OUT	
2	BKL_CONTROL	OUT	
3	LCD_PWR	PWR	+3.3V/+5V
4	GND	GND	
5	LVDS_A_CLK-	DIFF	
6	LVDS_A_CLK+	DIFF	
7	LCD_PWR	PWR	+3.3V/+5V
8	GND	GND	
9	LVDS_DA0-	DIFF	
10	LVDS_DA0+	DIFF	
11	LVDS_DA1-	DIFF	
12	LVDS_DA1+	DIFF	
13	LVDS_DA2-	DIFF	
14	LVDS_DA2+	DIFF	
15	LVDS_DA3-	DIFF	
16	LVDS_DA3+	DIFF	
17	DDC_DATA	I/O	+3.3V
18	DDC_CLK	I/O	+3.3V
19	LVDS_DB0-	DIFF	
20	LVDS_DB0+	DIFF	
21	LVDS_DB1-	DIFF	
22	LVDS_DB1+	DIFF	
23	LVDS_DB2-	DIFF	
24	LVDS_DB2+	DIFF	

Pin	Pin Name	Signal Type	Signal Level
25	LVDS_DB3-	DIFF	
26	LVDS_DB3+	DIFF	
27	LCD_PWR	PWR	+3.3V/+5V
28	GND	GND	
29	LVDS_B_CLK-	DIFF	
30	LVDS_B_CLK+	DIFF	

eDP Function

Pin	Pin Name	Signal Type	Signal Level
1	BKL_ENABLE	OUT	
2	BKL_CONTROL	OUT	
3	LCD_PWR	PWR	+3.3V/+5V
4	GND	GND	
5	eDP_TX3_D-	DIFF	
6	eDP_TX3_D+	DIFF	
7	LCD_PWR	PWR	+3.3V/+5V
8	GND	GND	
9	eDP_TX2_D-	DIFF	
10	eDP_TX2_D+	DIFF	
11	eDP_TX1_D-	DIFF	
12	eDP_TX1_D+	DIFF	
13	eDP_TX0_D-	DIFF	
14	eDP_TX0_D+	DIFF	
15	NC		
16	eDP_HPD	DIFF	
17	eDP_AUX_D-	I/O	+3.3V

Pin	Pin Name	Signal Type	Signal Level
18	eDP_AUX_D+	I/O	+3.3V
19	NC		
20	NC		
21	NC		
22	NC		
23	NC		
24	NC		
25	NC		
26	NC		
27	LCD_PWR	PWR	+3.3V/+5V
28	GND	GND	
29	NC		
30	NC		

2.3.6 LVDS Port Inverter / Backlight Connector (CN8)

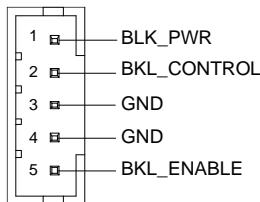

Pin	Pin Name	Signal Type	Signal Level
1	BKL_PWR	PWR	+5V / +12V
2	BKL_CONTROL	OUT	
3	GND	GND	
4	GND	GND	
5	BKL_ENABLE	OUT	+5V

* LVDS BKL_PWR can be set to +5V or +12V by JP4

* LVDS BKL_CONTROL can be set by JP3

2.3.7 LPC Port (CN11)

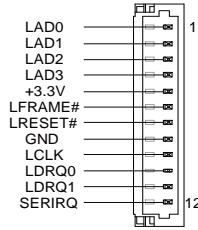

Pin	Pin Name	Signal Type	Signal Level
1	LAD0	I/O	+3.3V
2	LAD1	I/O	+3.3V
3	LAD2	I/O	+3.3V
4	LAD3	I/O	+3.3V
5	+3.3V	PWR	+3.3V
6	LFRAME#	IN	
7	LRESET#	OUT	+3.3V
8	GND	GND	
9	LCLK	OUT	
10	LDRQ0	IN	
11	LDRQ1	IN	
12	SERIRQ	I/O	+3.3V

2.3.8 +5V Output for SATA HDD (CN12)

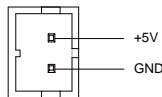

Pin	Pin Name	Signal Type	Signal Level
1	+5V	PWR	+5V
2	GND	GND	

2.3.9 SATA Port (CN13)

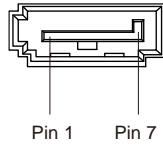

Pin	Pin Name	Signal Type	Signal Level
1	GND	GND	
2	SATA_TX+	DIFF	
3	SATA_TX-	DIFF	
4	GND	GND	
5	SATA_RX-	DIFF	
6	SATA_RX+	DIFF	
7	GND	GND	

2.3.10 BIOS Debug Port (CN14)

Pin	Pin Name	Signal Type	Signal Level
1	SPI_MISO	OUT	
2	GND	GND	
3	SPI_CLK	IN	
4	+3.3VSB	PWR	+3.3V
5	SPI_MOSI	IN	

Pin	Pin Name	Signal Type	Signal Level
6	SPI_CS	IN	
7	NC		

2.3.11 HDMI Connector (CN15)



Pin	Pin Name	Signal Type	Signal Level
1	DVI_D2+	OUT	
2	GND	GND	
3	DVI_D2-	OUT	
4	DVI_D1+	OUT	
5	GND	GND	
6	DVI_D1-	OUT	
7	DVI_D0+	OUT	
8	GND	GND	
9	DVI_D0-	OUT	
10	DVI_CLK+	OUT	
11	GND	GND	
12	DVI_CLK-	OUT	
13	NC		
14	NC		
15	SCL	I/O	
16	SDA	I/O	
17	GND	GND	
18	+5V	PWR	
19	HPD	IN	

2.3.12 USB 3.0 Ports (CN19)

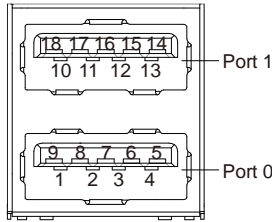

Pin	Pin Name	Signal Type	Signal Level
1	+5VSB	PWR	+5V
2	USB_D-	DIFF	
3	USB_D+	DIFF	
4	GND	GND	
5	USB_SSRX-	DIFF	
6	USB_SSRX+	DIFF	
7	GND	GND	
8	USB_SSTX-	DIFF	
9	USB_SSTX+	DIFF	
10	+5VSB	PWR	+5V
11	USB_D-	DIFF	
12	USB_D+	DIFF	
13	GND	GND	
14	USB_SSRX-	DIFF	
15	USB_SSRX+	DIFF	
16	GND	GND	
17	USB_SSTX-	DIFF	
18	USB_SSTX+	DIFF	

2.3.13 Battery (CN20)

Pin	Pin Name	Signal Type	Signal Level
1	+3.3V	PWR	3.3V
2	GND	GND	

2.3.14 CPU FAN (Optional) (CN21)

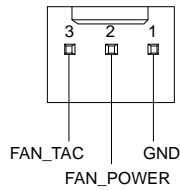

Pin	Pin Name	Signal Type	Signal Level
1	GND	GND	
2	FAN_POWER	PWR	+12V
3	FAN_TAC	IN	

2.3.15 LAN (RJ45) Connector (CN23)

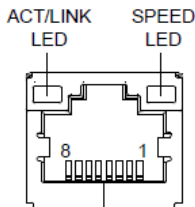

Pin	Signal	Pin	Signal
1	MDI0+	2	MDI0-
3	MDI1+	4	MDI2+
5	MDI2-	6	MDI1-

2.316. External Power Input (CN25)

Pin	Pin Name	Signal Type	Signal Level
1	+12V	PWR	+9~+24V (or
2	GND	GND	

2.3.17 COM Port 2 (CN26)

RS-232			
Pin	Pin Name	Signal Type	Signal level
1	DCD	IN	
2	DSR	IN	
3	RX	IN	
4	RTS	OUT	±5V
5	TX	OUT	±5V
6	CTS	IN	
7	DTR	OUT	±5V
8	RI/+5V/+12V	IN/ PWR	+5V/+12V
9	GND	GND	

RS-422			
Pin	Pin Name	Signal Type	Signal level
1	RS422_TX-	OUT	±5V
2	NC		
3	RS422_TX+	OUT	±5V
4	NC		
5	RS422_RX+	IN	

6	NC		
7	RS422_RX-	IN	
8	NC/+5V/+12V	PWR	+5V/+12V
9	GND	GND	

RS-485			
Pin	Pin Name	Signal Type	Signal level
1	RS485_D-	I/O	±5V
2	NC		
3	RS485_D+	I/O	±5V
4	NC		
5	NC		
6	NC		
7	NC		
8	NC/+5V/+12V	PWR	+5V/+12V
9	GND	GND	

* COM2 RS-232/422/485 can be set through BIOS setting. Default is RS-232.

* Pin 8 function can be set by JP11.

2.3.18 COM Port 1 (CN27)

RS-232			
Pin	Pin Name	Signal Type	Signal level
1	DCD	IN	
2	DSR	IN	
3	RX	IN	

4	RTS	OUT	±5V
5	TX	OUT	±5V
6	CTS	IN	
7	DTR	OUT	±5V
8	RI/+5V/+12V	IN/ PWR	+5V/+12V
9	GND	GND	

RS-422

Pin	Pin Name	Signal Type	Signal level
1	RS422_TX-	OUT	±5V
2	NC		
3	RS422_TX+	OUT	±5V
4	NC		
5	RS422_RX+	IN	
6	NC		
7	RS422_RX-	IN	
8	NC/+5V/+12V	PWR	+5V/+12V
9	GND	GND	

RS-485

Pin	Pin Name	Signal Type	Signal level
1	RS485_D-	I/O	±5V
2	NC		
3	RS485_D+	I/O	±5V
4	NC		
5	NC		
6	NC		

7	NC		
8	NC/+5V/+12V	PWR	+5V/+12V
9	GND	GND	

* COM1 RS-232/422/485 can be set through BIOS setting. Default is RS-232.

* Pin 8 function can be set by JP9.

2.4 Assembling Modules

To install a module:

Step 1 - Insert the connector to the OMNI slot by the side of the PCB box

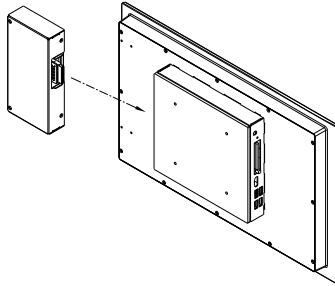

Step 2 - Secure with the screws provided.

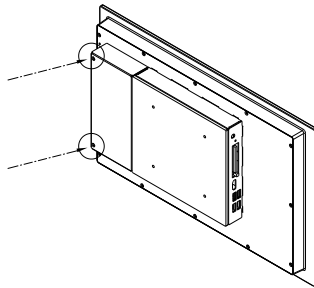

The module is installed as the image shown below.

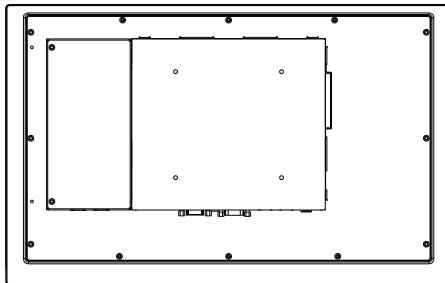

To detach a module:

Step 1 – Remove the screws from the module

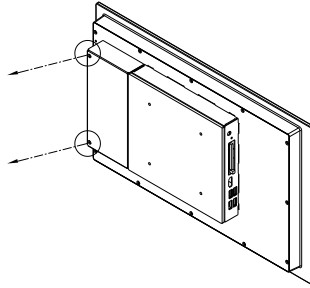

Step 2 – Remove the module

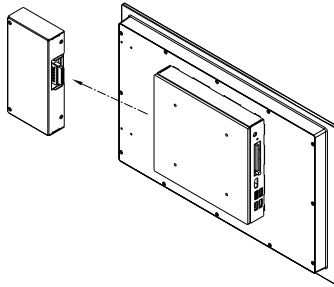

The module is detached from the main panel.

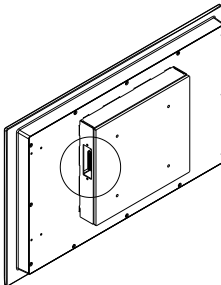

2.5 Installing the Hard Disk Drive

1. Put the rubber provided onto the holes of the bracket.



2. Place the HDD onto the bracket and secure with the screws provided

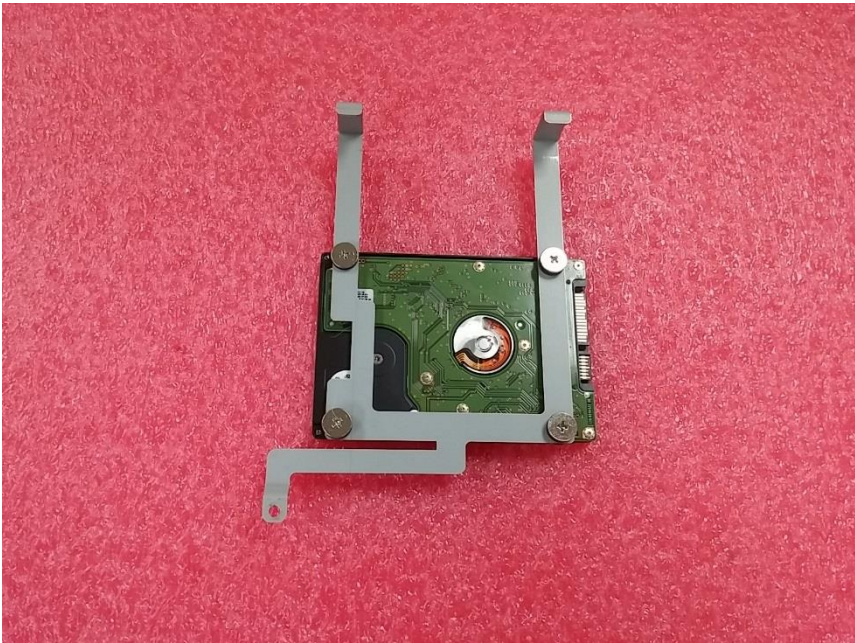

- Hook the setup on to the bar above the PCB board as shown below. Secure it with the screw provided.



* Users are advised to use storage devices provided and installed by AAEON.

2.6 Installing DRAM

To install DRAM, remove the HDD and HDD bracket and insert the RAM module as shown below.

* Users are advised to use DRAM modules provided and installed by AAEON.

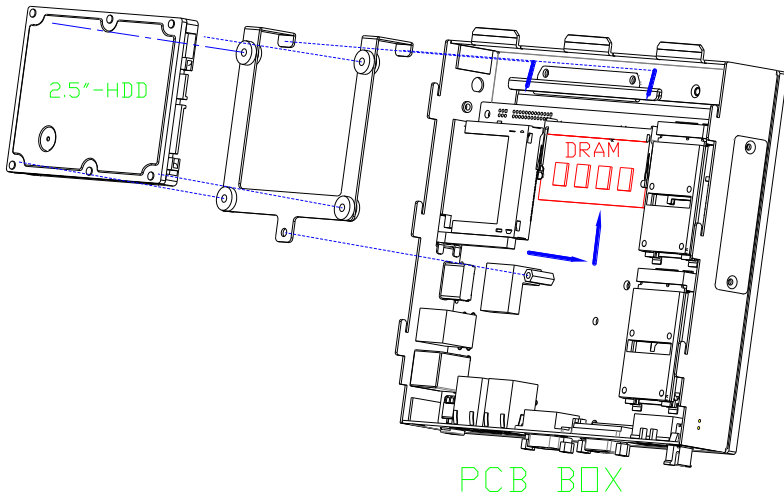

2.7 Mount the OMNI onto the wall

Step 1 - Glue the water-proof rubber along back side of the panel

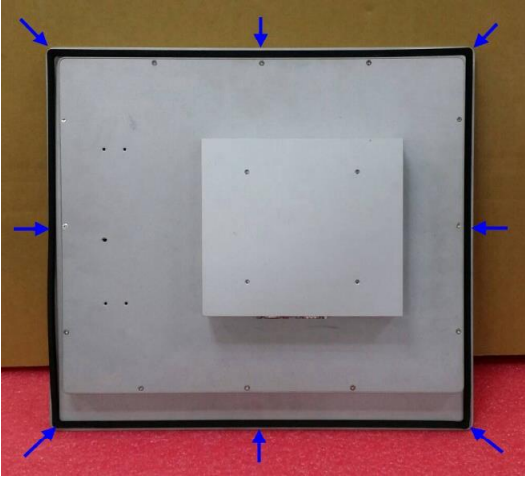

Step 2 - Screw the provided mounting brackets into back of the panel

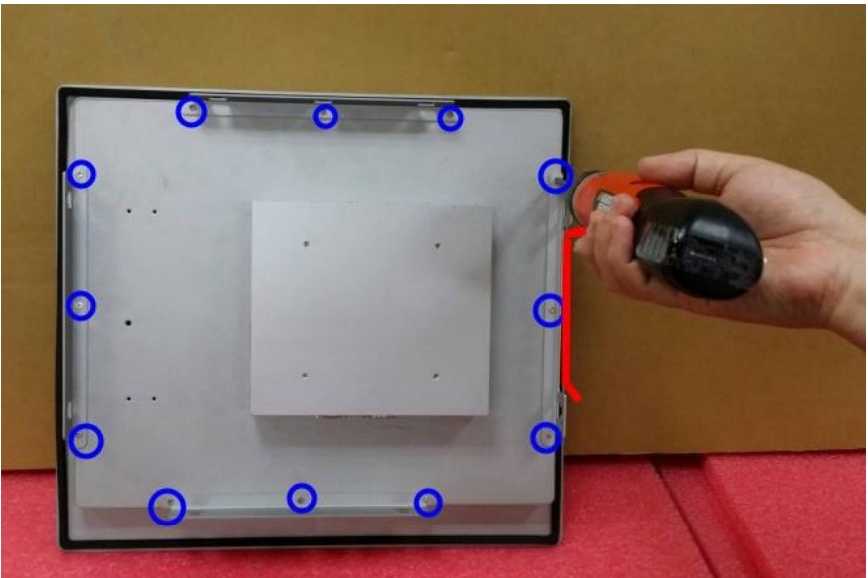

Step 3 - Secure the panel with wall-mount brackets onto the wall with screws

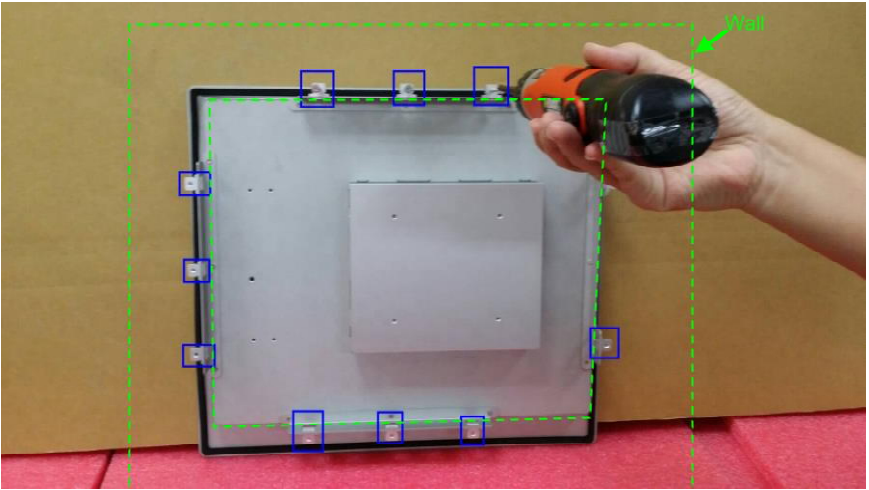

2.8 Assemble the OMNI panel and the CPU Box

The left photo shows the LCD Kit and the right photo shows BOXER Kit



Step 1 - Plug connectors into connector sockets accordingly

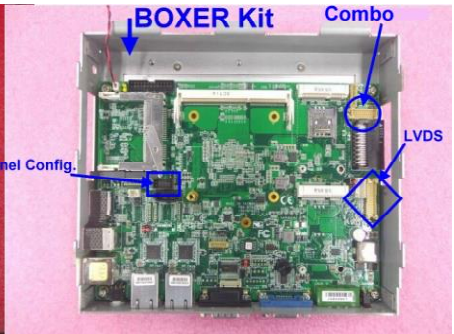

:

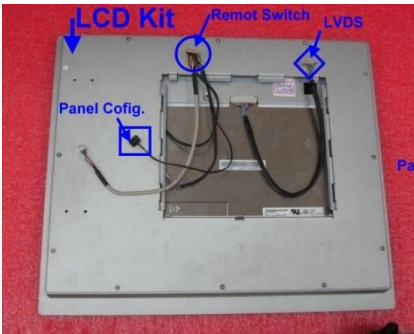

Step 2 - Assemble the panel and CPU Box**Step 3** – Slide the CPU Box into the panel and tighten them with screws

The assembling process is completed

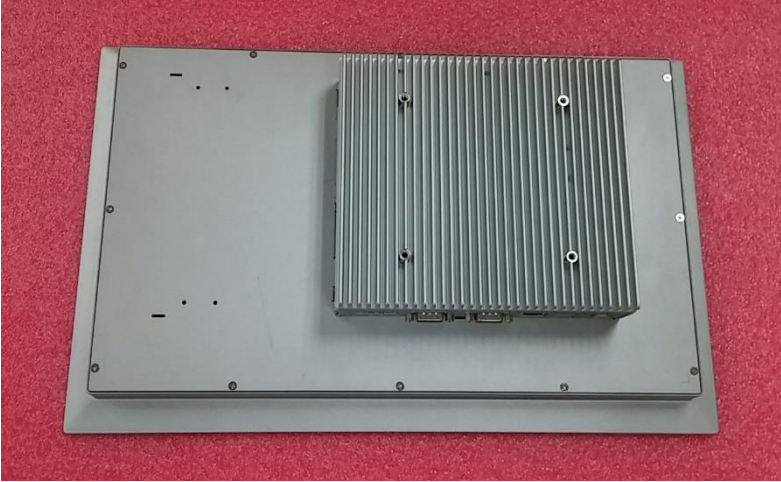

2.9 P-CAP Touch Screen Operating

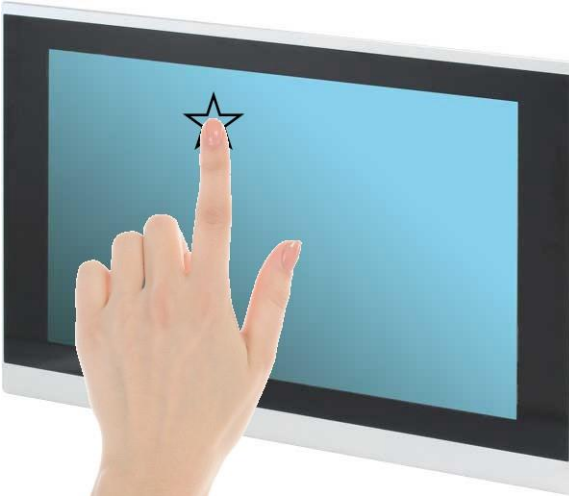

1. Always touch the screen with finger pads.
2. The force of finger should be lower than 10g.

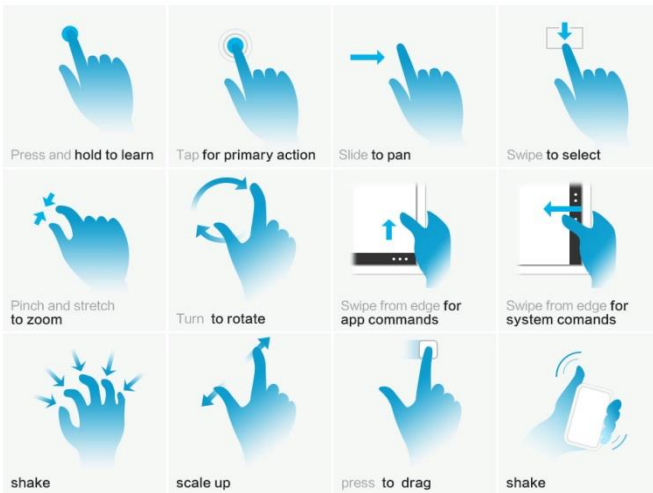

Chapter 3

AMI BIOS Setup

3.1 System Test and Initialization

The system uses certain routines to perform testing and initialization. If an error, fatal or non-fatal, is encountered, a few short beeps or an error message will be outputted. The board can usually continue the boot up sequence with non-fatal errors.

The system configuration verification routines check the current system configuration against the values stored in the CMOS memory. If they do not match, an error message will be outputted, in which case you will need to run the BIOS setup program to set the configuration information in memory.

There are three situations in which you will need to change the CMOS settings:

- You are starting your system for the first time
- You have changed your system's hardware
- The CMOS memory has lost power and the configuration information is erased

The system's CMOS memory uses a backup battery for data retention, which is to be replaced once emptied.

3.2 AMI BIOS Setup

The AMI BIOS ROM has a pre-installed Setup program that allows users to modify basic system configurations, which is stored in the battery-backed CMOS RAM and BIOS NVRAM so that the information is retained when the power is turned off.

To enter BIOS Setup, press or <F2> immediately while your computer is powering up.

The function for each interface can be found below.

Main – Date and time can be set here. Press <Tab> to switch between date elements

Advanced – Enable/ Disable boot option for legacy network devices

Chipset – For hosting bridge parameters

Boot – Enable/ Disable quiet Boot Option

Security – The setup administrator password can be set here

Save & Exit – Save your changes and exit the program

3.3 Setup Submenu: Main

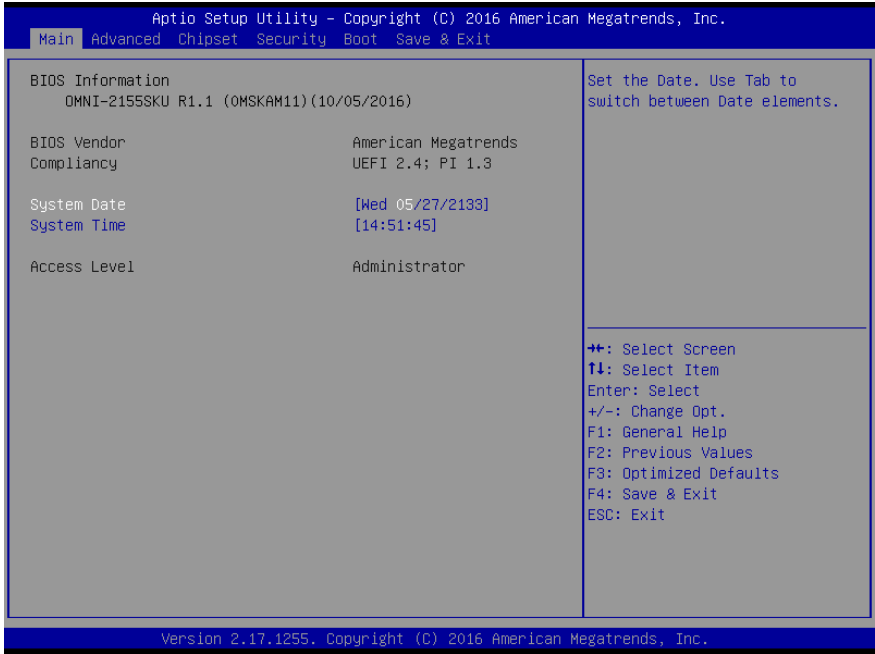

3.4 Setup Submenu: Advanced

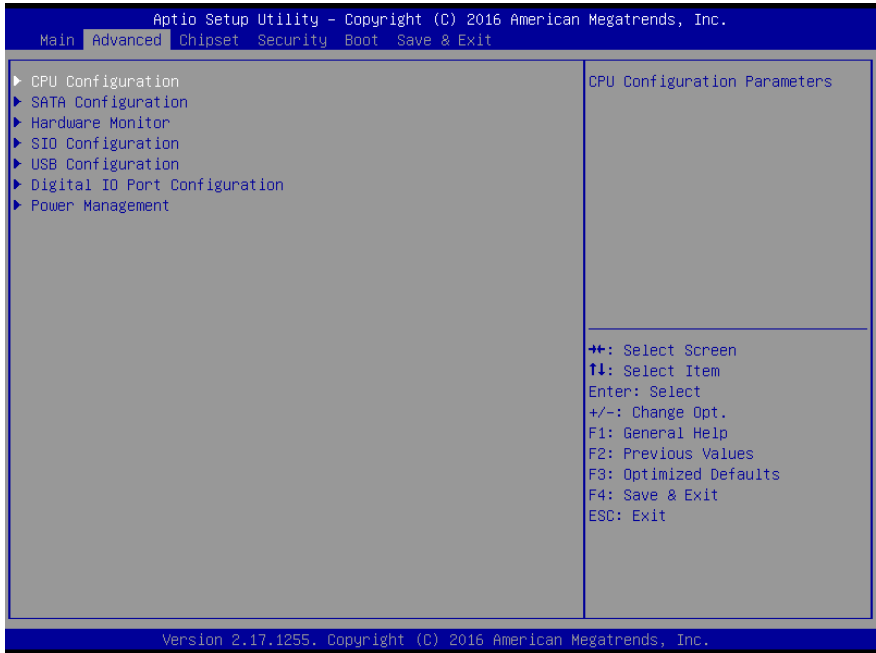

3.4.1 Advanced: CPU Configuration

The screenshot displays the 'Advanced' menu of the Aptio Setup Utility. The title bar reads 'Aptio Setup Utility - Copyright (C) 2016 American Megatrends, Inc.' and the sub-menu is 'Advanced'. The main area is divided into two columns. The left column lists various CPU-related settings, and the right column provides a detailed description of the Hyper-Threading Technology setting. A vertical scrollbar is visible between the two columns.

Setting	Value
Intel(R) Core(TM) i5-6300U CPU @ 2.40GHz	
CPU Signature	406E3
Microcode Patch	9E
Max CPU Speed	2400 MHz
Min CPU Speed	400 MHz
CPU Speed	2400 MHz
Processor Cores	2
Hyper Threading Technology	Supported
Intel VT-x Technology	Supported
Intel SMX Technology	Supported
64-bit	Supported
EIST Technology	Supported
CPU C3 state	Supported
CPU C6 state	Supported
CPU C7 state	Supported
L1 Data Cache	32 kB x 2
L1 Code Cache	32 kB x 2
L2 Cache	256 kB x 2
L3 Cache	3 MB
L4 Cache	Not Present
Hyper-threading	[Enabled]
Active Processor Cores	[All]

Hyper-Threading Technology Description:
Enabled for Windows XP and Linux (OS optimized for Hyper-Threading Technology) and Disabled for other OS (OS not optimized for Hyper-Threading Technology). When Disabled only one thread per enabled core is enabled.

Navigation Legend:
++: Select Screen
↑↓: Select Item
Enter: Select
+/-: Change Opt.
F1: General Help
F2: Previous Values
F3: Optimized Defaults
F4: Save & Exit
ESC: Exit

Version 2.17.1255. Copyright (C) 2016 American Megatrends, Inc.

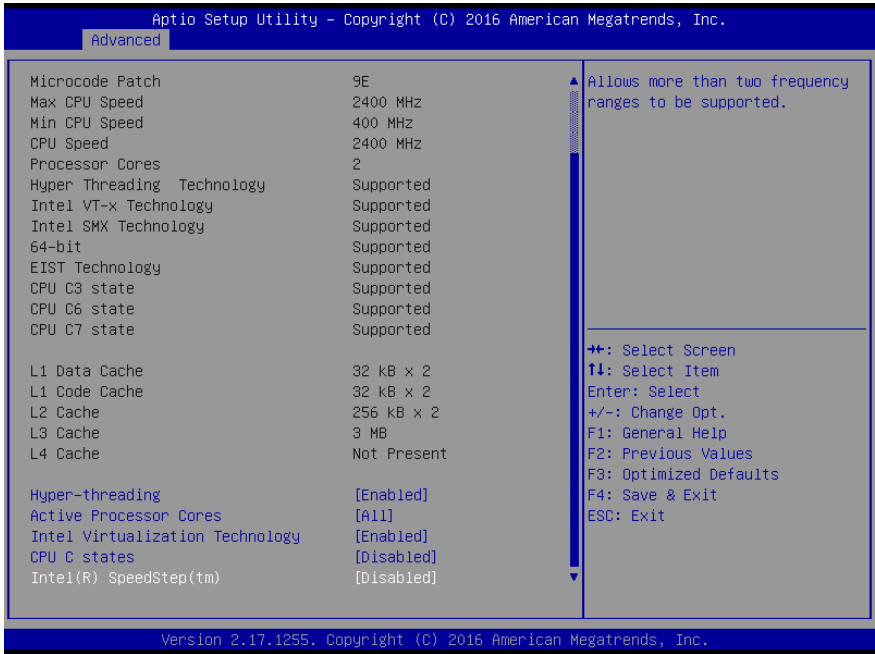

Options summary:

Hyper-threading	Disabled	Optimal Default, Failsafe Default
	Enabled	
Enabled for Windows XP and Linux (OS optimized for Hyper-Threading Technology) and Disabled for other OS (OS not optimized for Hyper-Threading Technology). When Disabled only one thread per enabled core is enabled.		
Intel Virtualization Technology	Disabled	Optimal Default, Failsafe Default
	Enabled	
When enabled, a VMM can utilize the additional hardware capabilities provided by Vanderpool Technology		
Active Processor Cores	1	Optimal Default, Failsafe Default
	All	
Number of cores to enable in each processor package.		
CPU C States	Disabled	Optimal Default, Failsafe Default
	Enabled	
Enable or disable CPU C states		
Intel(R) SpeedStep(tm)	Disabled	Optimal Default, Failsafe Default
	Enabled	
Allows more than two frequency ranges to be supported.		

3.4.2 Advanced: SATA Configuration

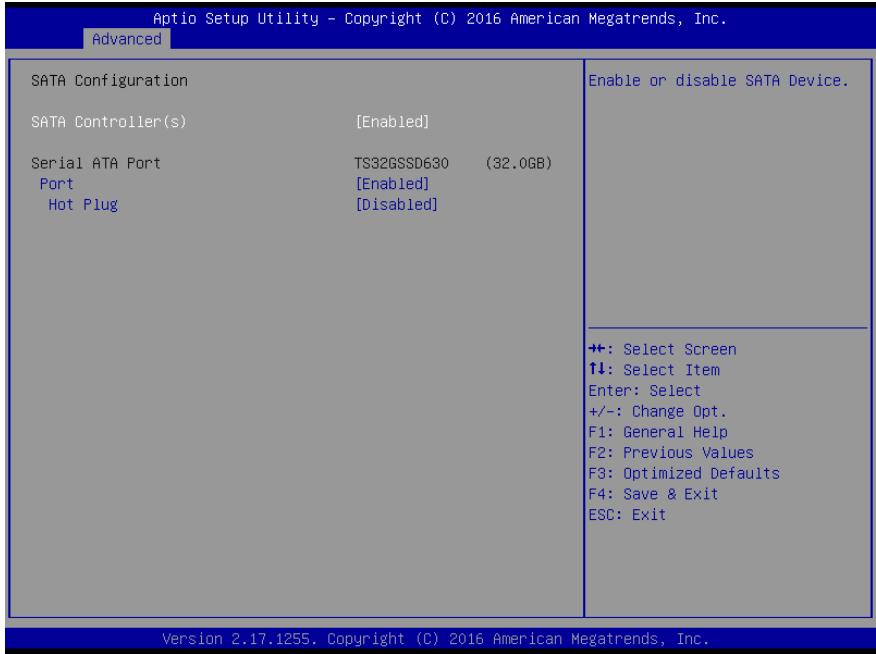

Options summary:

SATA Controller(s)	Enabled	Optimal Default, Failsafe Default
	Disabled	
Enable or Disable SATA Device.		
Port 0	Enabled	Optimal Default, Failsafe Default
	Disabled	
Enable or Disable SATA Port.		
Hot Plug	Enabled	Optimal Default, Failsafe Default
	Disabled	
Designates this port as Hot Pluggable.		

3.4.3 Advanced: Hardware Monitor

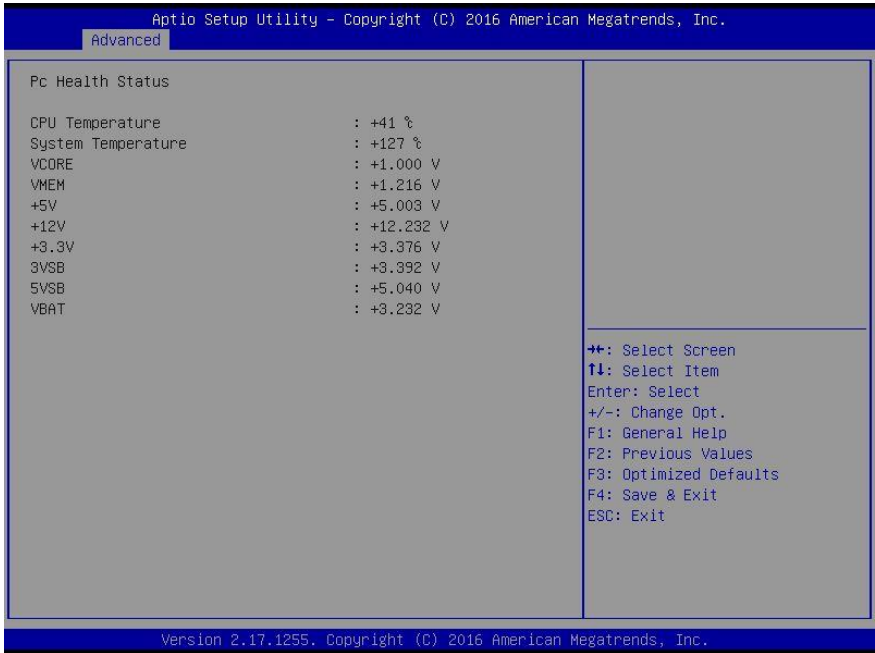

3.4.4 Advanced: SIO Configuration

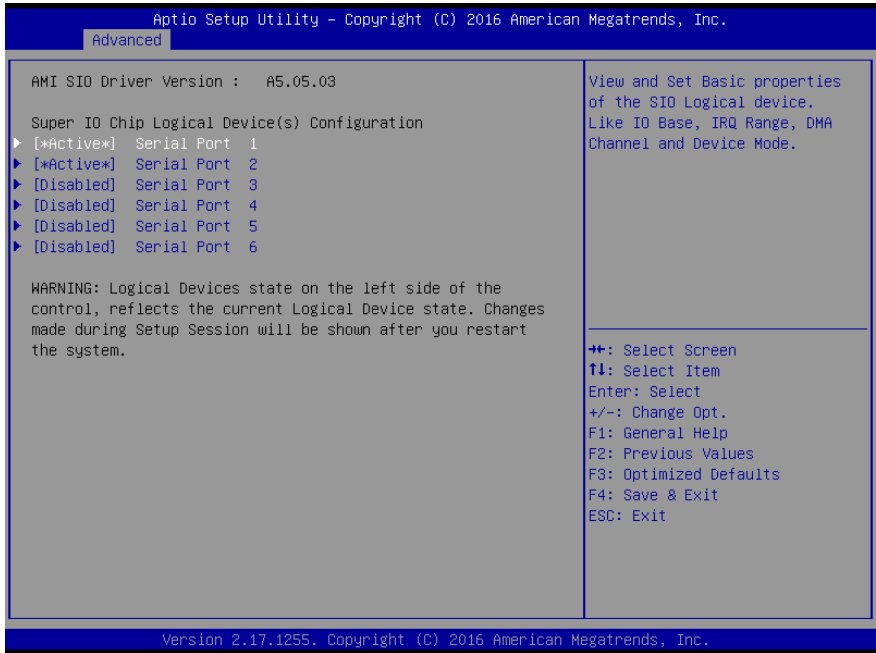

3.4.4.1 SIO Configuration: Serial Port 1 Configuration

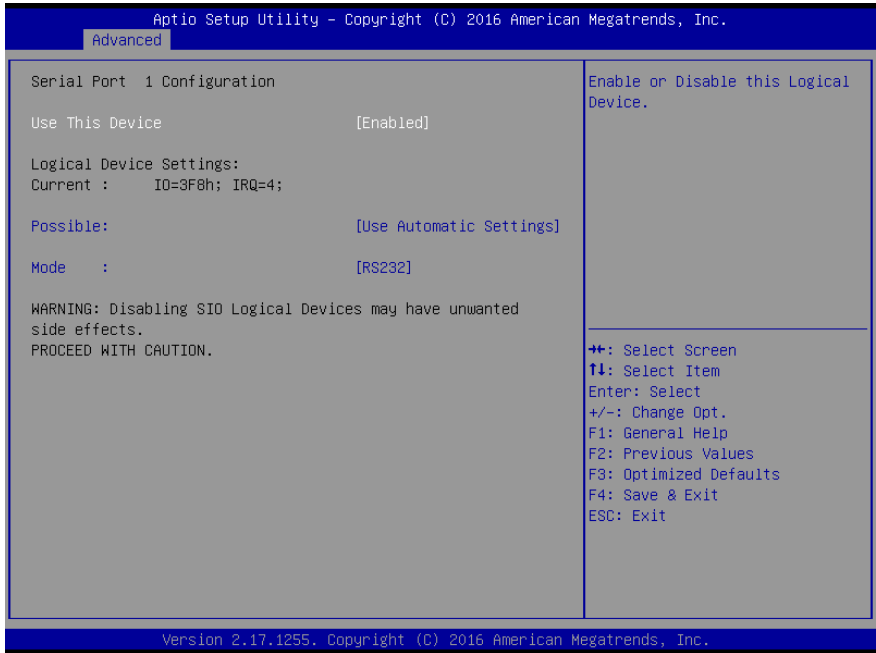

Options summary:

Use This Device	Disabled	Optimal Default, Failsafe Default
	Enabled	
Enable or Disable this Logical Device.		
Possible:	Use Automatic Settings	Optimal Default, Failsafe Default
	IO=2F8; IRQ=3;	
	IO=3F8; IRQ=4;	
Allows user to change Device's Resource settings. New settings will be reflected on This Setup Page after System restarts.		
Mode:	RS232	Optimal Default, Failsafe Default
	RS422	
	RS485	
UART RS232, 422, 485 selection		

3.4.4.2 SIO Configuration: Serial Port 2 Configuration



Options summary:

Use This Device	Disabled	Optimal Default, Failsafe Default
	Enabled	
Enable or Disable this Logical Device.		
Possible:	Use Automatic Settings	Optimal Default, Failsafe Default
	IO=2F8; IRQ=3;	
	IO=3F8; IRQ=4;	
Allows user to change Device's Resource settings. New settings will be reflected on This Setup Page after System restarts.		
Mode:	RS232	Optimal Default, Failsafe Default
	RS422	
	RS485	
UART RS232, 422, 485 selection		

3.4.5 Advanced: USB Configuration

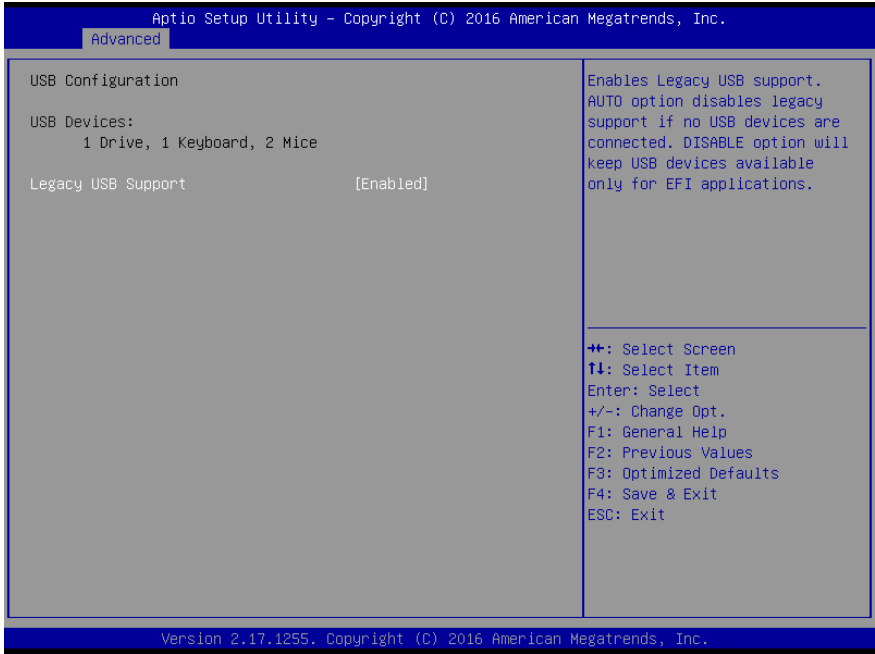

Options summary:

Legacy USB Support	Enabled	Optimal Default, Failsafe Default
	Disabled	
	Auto	
Enables Legacy USB support. AUTO option disables legacy support if no USB devices are connected. DISABLE option will keep USB devices available only for EFI applications.		

3.4.6 Advanced: Digital IO Port Configuration

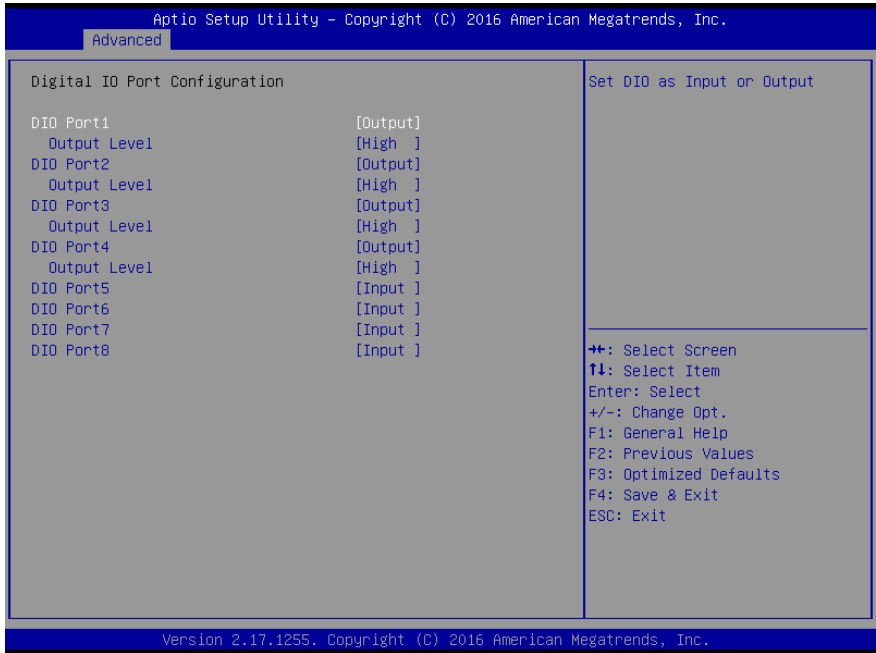

Options summary:

DIO Port1/2/3/4/5/6/7/8	Output	Optimal Default, Failsafe Default
	Input	
Set DIO as Input or Output		
Output Level	Low	Optimal Default, Failsafe Default
	High	
Set output level when DIO pin is output		

3.4.7 Advanced: Power Management

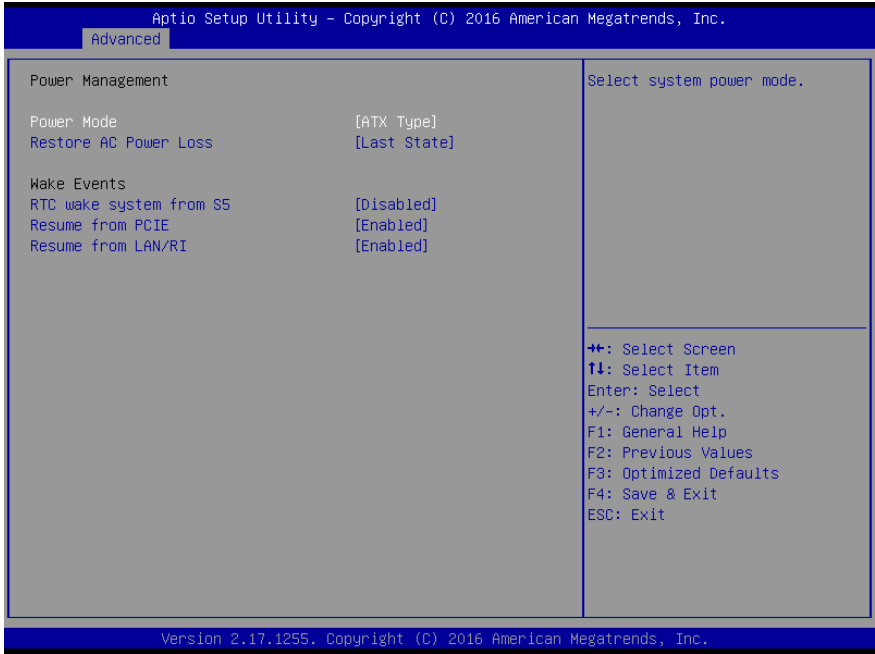

Options summary:

Power Mode	ATX Type	Optimal Default, Failsafe Default
	AT Type	
Select power supply mode.		
Restore AC Power Loss	Last State	Optimal Default, Failsafe Default
	Power On	
	Power Off	
Select power state when power is re-applied after a power failure.		
RTC wake system from S5	Disabled	Optimal Default, Failsafe Default
	Fixed Time	
	Dynamic Time	
Fixed Time: System will wake on the hr::min::sec specified./n Dynamic Time: System will wake on the current time + Increase minute(s)		

Resume from PCIE	Enabled	Optimal Default, Failsafe Default
	Disabled	
Enable/Disable Resume from PCIE		
Resume from LAN/RI	Enabled	Optimal Default, Failsafe Default
	Disabled	
Enable/Disable Resume from LAN/RI		

3.5 Setup submenu: Chipset

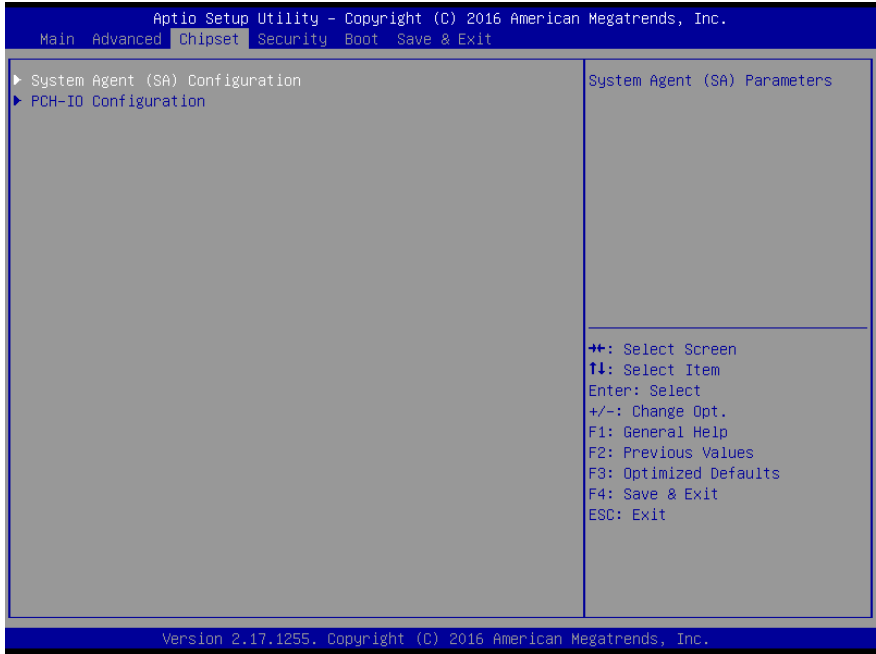

3.5.1 Chipset: System Agent (SA) Configuration



Options summary:

Max TOLUD	Dynamic	Optimal Default, Failsafe Default
	1 GB	
	1.25 GB	
	1.5 GB	
	1.75 GB	
	2 GB	
	2.25 GB	
	2.5 GB	
	2.75 GB	
	3 GB	

Maximum Value of TOLUD (Top of Low Usable DRAM)\nDynamic assignment would adjust TOLUD automatically based on largest MMIO length of installed graphic controller.\nChanging this value may cause side effect, if reserved memory is lesser than MMIO required. This happens often when Gfx device with large MMIO requirement.

3.5.1.1 System Agent (SA) Configuration: Graphics Configuration

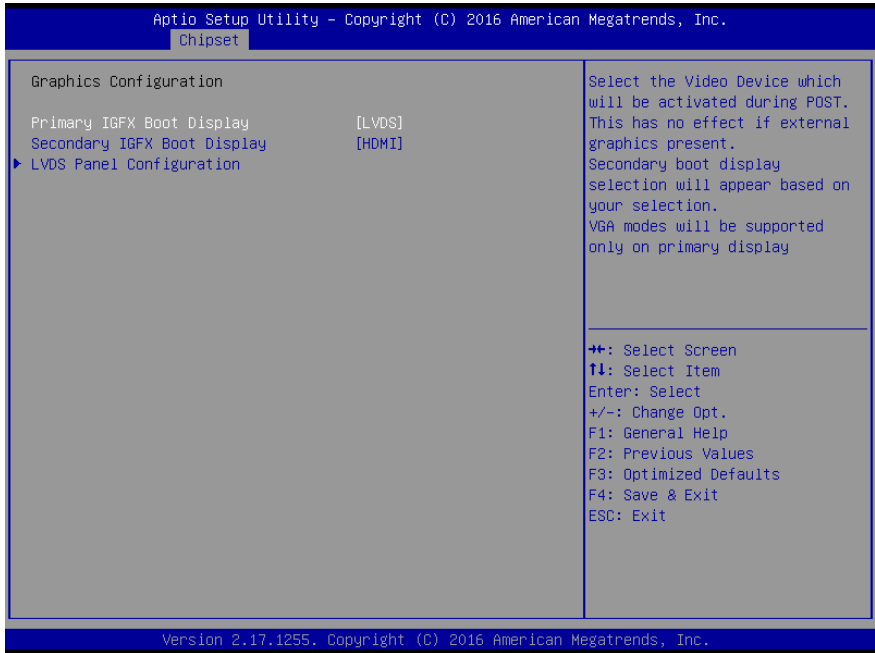

Options summary:

Primary IGFX Boot Display	VBIOS default	Optimal Default, Failsafe Default
	HDMI	
	LVDS	
Secondary IGFX Boot Display	Disabled	Optimal Default, Failsafe Default
	HDMI	

Select the Video Device which will be activated during POST.
 This has no effect if external graphics present.
 Secondary boot display selection will appear based on your selection.
 VGA modes will be supported only on primary display

3.5.1.1.1 Graphics Configuration: LVDS Panel Configuration

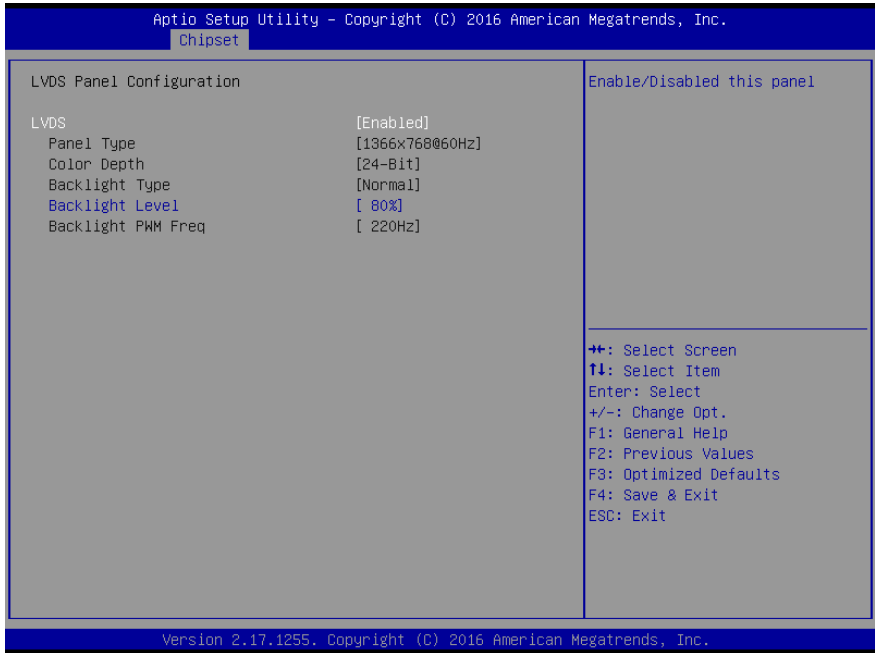

Options summary:

LVDS	Enabled	Optimal Default, Failsafe Default
	Disabled	
Enable/Disable this panel		
Backlight Level	80%	Optimal Default, Failsafe Default
	0% ~ 100%	
Select backlight control level		

3.5.2 Chipset: PCH-IO Configuration

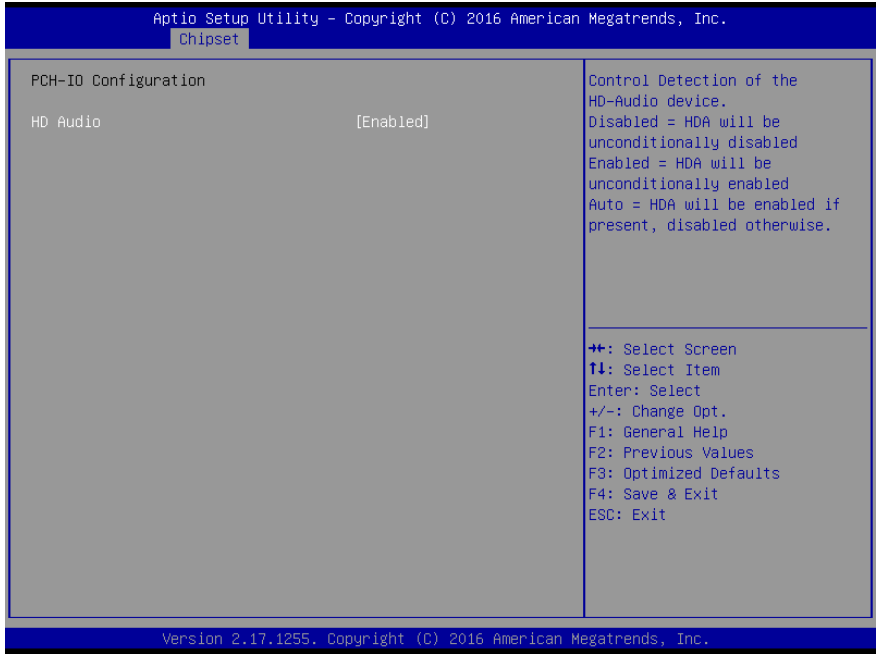

Options summary:

HD Audio	Disabled	Optimal Default, Failsafe Default
	Enabled	
Control Detection of the HD-Audio device. Disabled = HDA will be unconditionally disabled Enabled = HDA will be unconditionally enabled Auto = HDA will be enabled if present, disabled otherwise.		

3.6 Setup submenu: Security

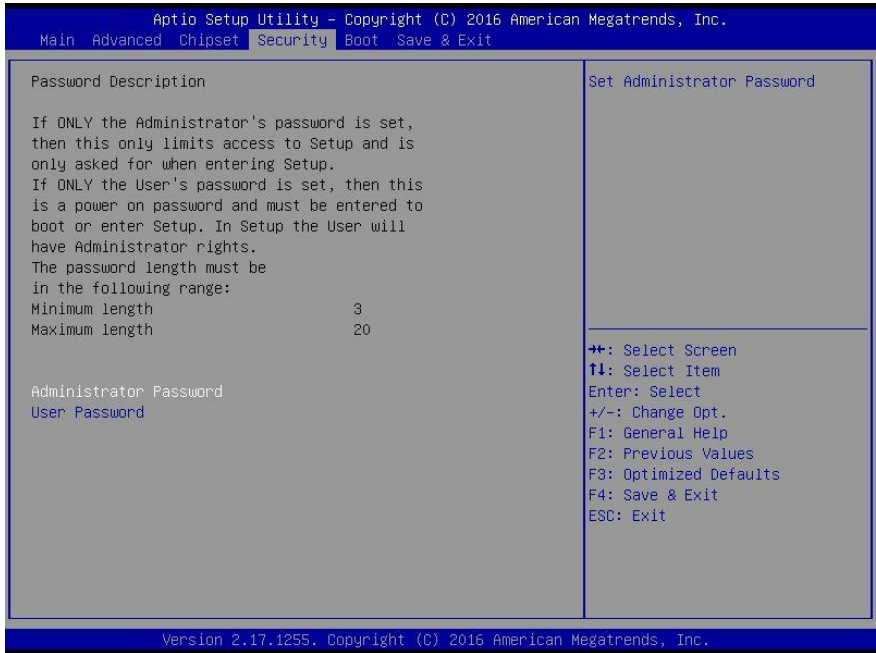

Change User/Administrator Password

You can set a User Password once an Administrator Password is set. The password will be required during boot up, or when the user enters the Setup utility. Please Note that a User Password does not provide access to many of the features in the Setup utility. Select the password you wish to set, press Enter to open a dialog box to enter your password. Password length must be between 3 and 20 numbers or letters. Press Enter to confirm your entry, after which you will be prompted to retype your password for a final confirmation. Press Enter again after you have retyped it correctly.

Removing the Password

Highlight this item and type in the current password. At the next dialog box press Enter to disable password protection.

3.7 Setup submenu: Boot

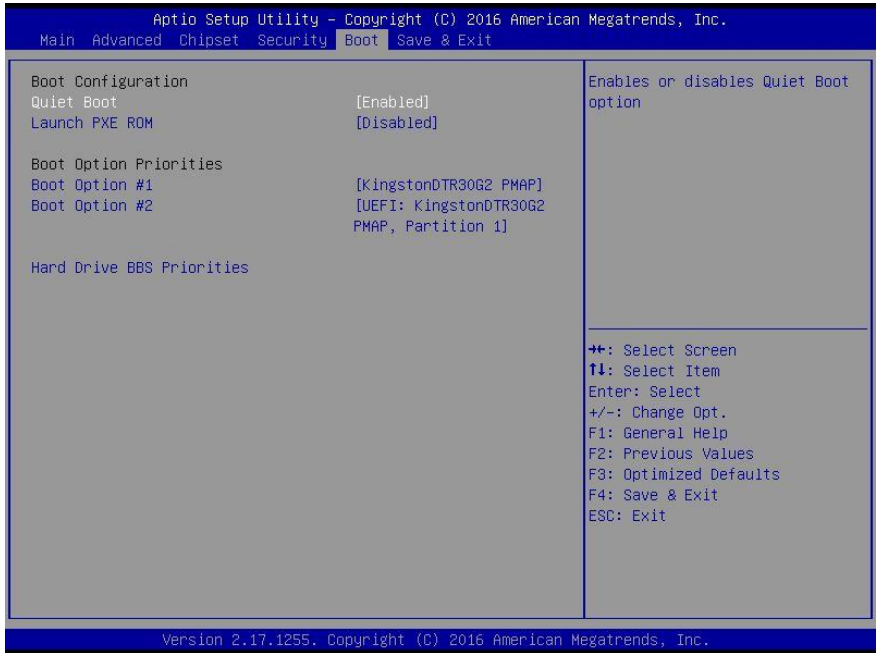

Options summary:

Quiet Boot	Disabled	Optimal Default, Failsafe Default
	Enabled	
Enables or disables Quiet Boot option.		
Launch PXE OpROM	Disabled	Optimal Default, Failsafe Default
	Enabled	
Controls the execution of UEFI and Legacy PXE OpROM.		

3.8 Boot: BBS Priorities

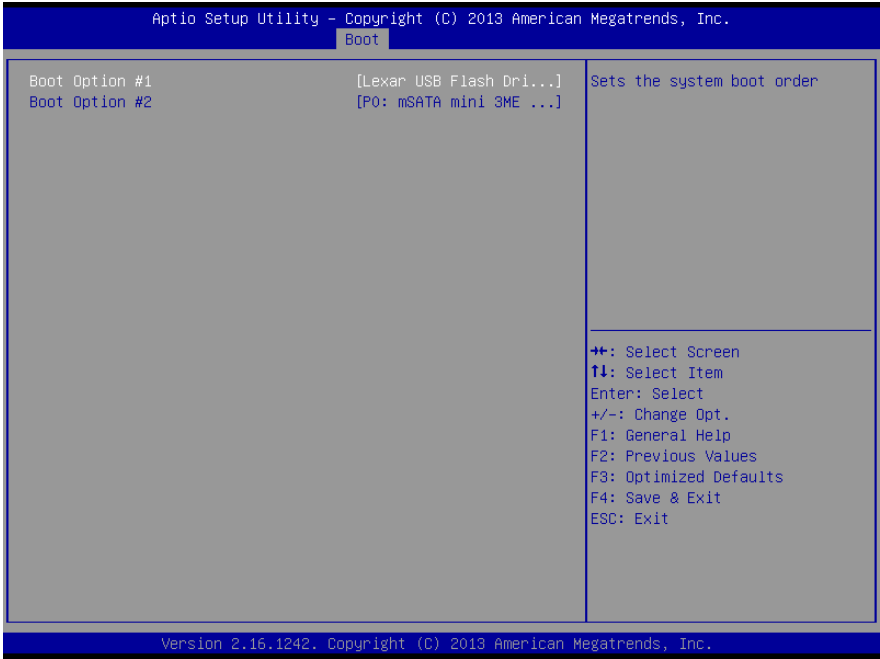

3.9 Setup submenu: Save & Exit

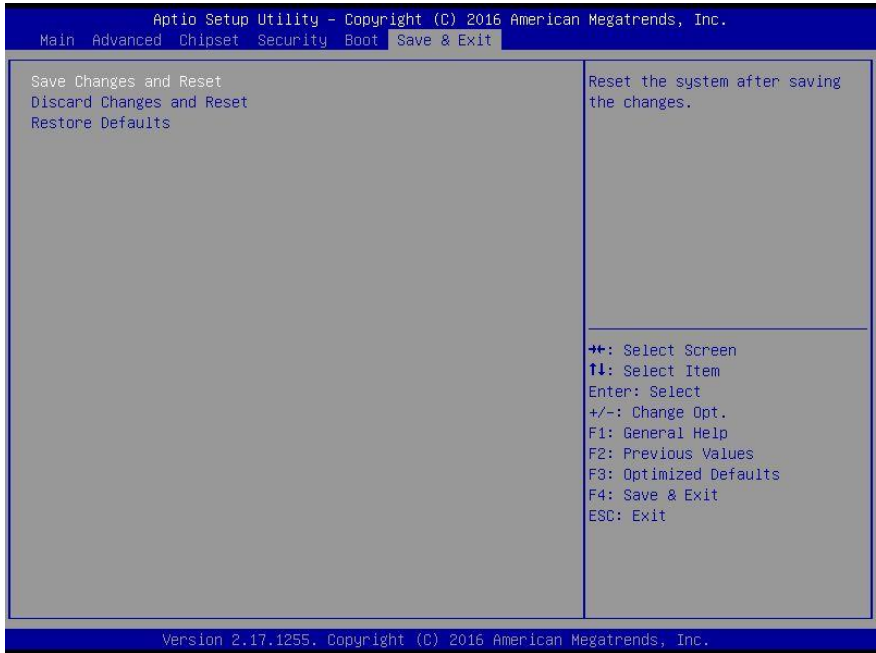

Chapter 4

Drivers Installation & Touchscreen Settings

4.1 Product CD/DVD

The OMNI-BT series comes with a product DVD that contains all the drivers and utilities you need to setup your product. Insert the DVD and follow the steps in the autorun program to install the drivers.

In case the program does not start, follow the sequence below to install the drivers.

Step 1 – Install Chipset Drivers

1. Open the **Step 1 – Chipset** folder and select your OS
2. Open the **SetupChipset.exe** file in the folder
3. Follow the instructions
4. Drivers will be installed automatically

Step 2 – Install Graphics Driver

1. Open the **STEP2 - VGA** folder and select your OS
2. Open the **Setup.exe** file in the folder
3. Follow the instructions
4. Drivers will be installed automatically

Step 3 – Install LAN Driver

1. Open the **STEP3 – LAN** folder and select your OS
2. Open the **.exe** file in the folder
3. Follow the instructions
4. Drivers will be installed automatically

Step 4 – Install Audio Drivers

1. Open the **STEP4 - Audio** folder followed by **0005-Win7_Win8_Win81_Win10_R279.exe**

2. Follow the instructions
3. Drivers will be installed automatically

Step 5 – Install USB 3.0 Drivers

1. Open the **STEP5 - USB3.0** folder and select your OS
2. Open the **.exe** file in the folder
3. Follow the instructions
4. Drivers will be installed automatically

Step 6 – Install ME Drivers (Optional, Windows 8.1/ 10 only)

1. Open the **STEP6 – ME** folder followed by **SetupME.exe**
2. Follow the instructions
3. Drivers will be installed automatically

Step 7 – Install PenMount Touch 6000 Series Driver (Resistive touchscreen only)

1. Open the **STEP7 –PenMount Touch 6000** folder followed by **Setup.exe**
2. Follow the instructions
3. Drivers will be installed automatically

* The OMNI-SKU Series uses either 5-wire resistive or projected capacitive multi-touch technologies. The latter is capable of 10 fingers multi-touch with Windows 7 & Windows 8.x.

Step 8 – Serial Port Drivers (Optional)

For Windows 7:

1. Change User Account Control settings to **Never notify**

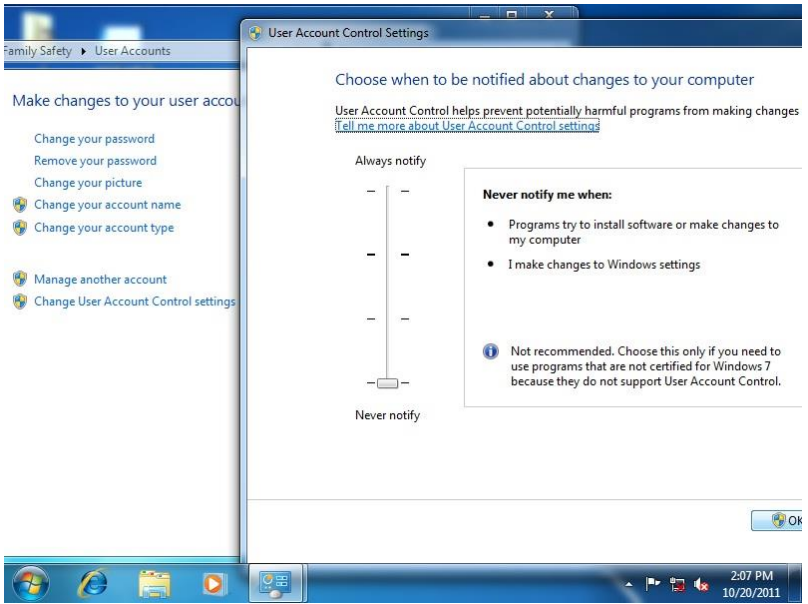

2. Reboot and log in as administrator

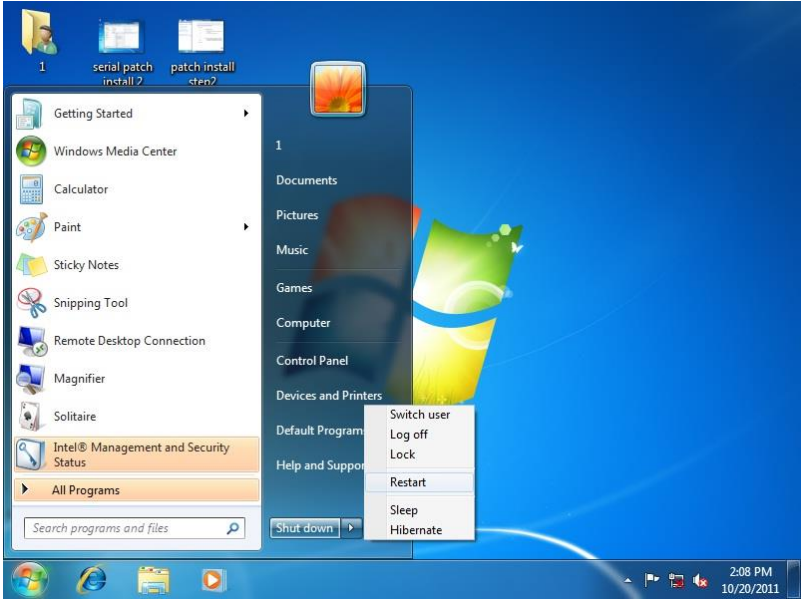

3. Run patch.bat as administrator

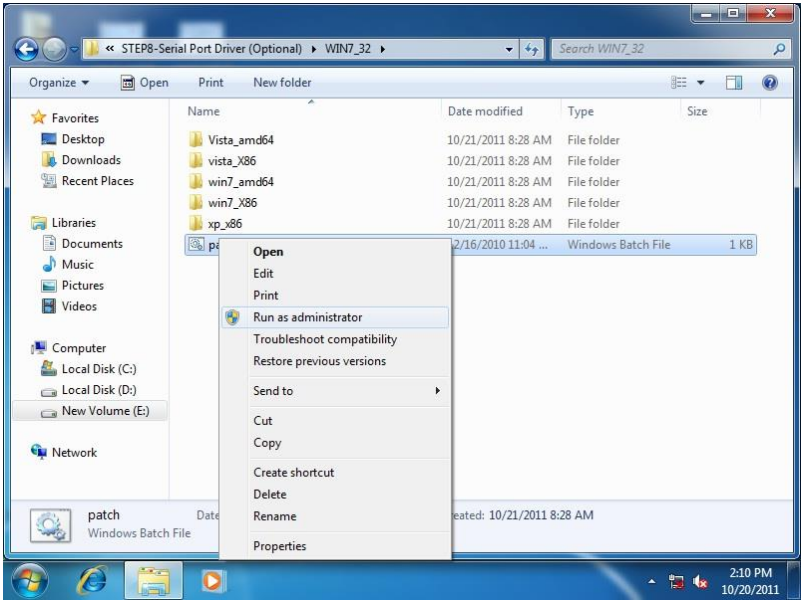

For Windows 8:

1. Open the Apps Screen, right click on the **Command Prompt** tile and select **Run as Administrator**

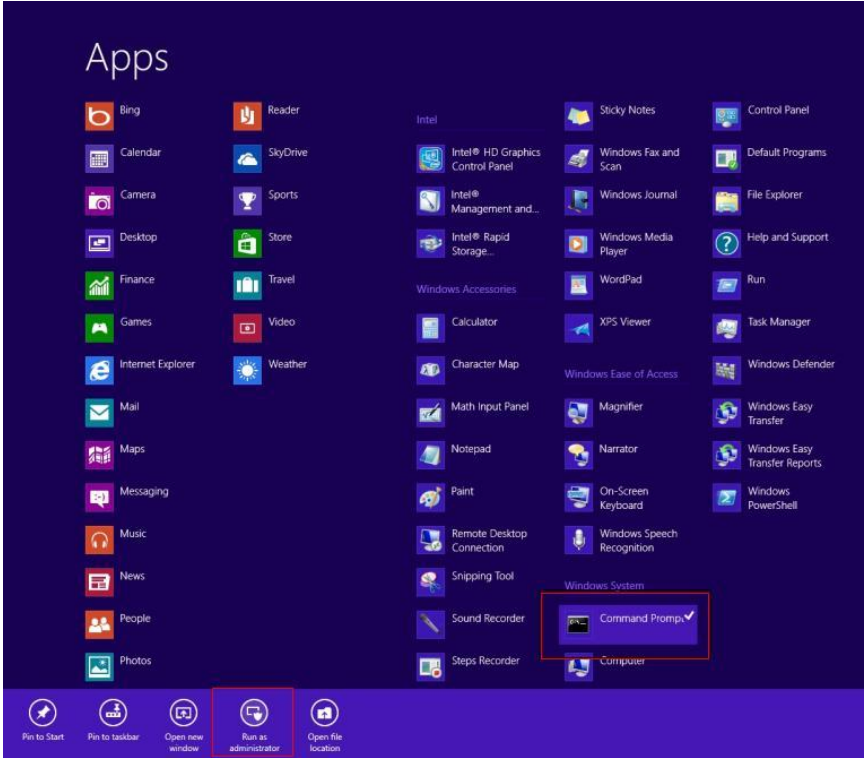

- To install the driver (patch.bat), you will first have to locate the file in command prompt. To do that, first go to the directory which contains the file by entering **<drive letter>: eg.** if the driver is in D drive, enter **D:**
- You are now at the directory containing the installation file. Next, go to the folder in which the file resides by entering **cd <folder>** eg: if the file is in a folder named abc, enter **cd <abc>**.
- You are now at the folder where the file is located. Enter the **patch.bat** to open and install the drivers. If your file is in a subfolder, enter the **cd <folder>** command again to access the subfolder (screenshot below is for reference only).

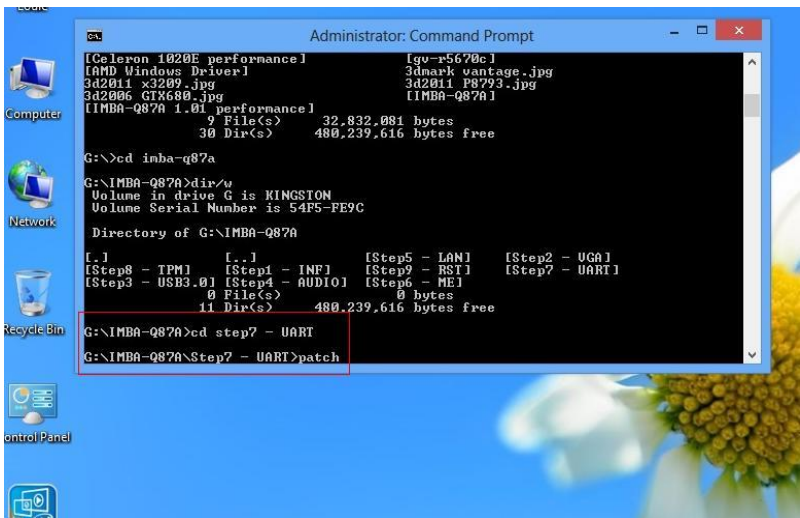

- Reboot after installation completes.
- To confirm the installation, go to Device Manager, expand the Ports (COM & LPT) tree and double click on any of the COM ports to open its properties. Go to the Driver tab, select Driver Details and click on **serial.sys**, you should see its provider as **Windows (R) Win 7 DDK Provider**.

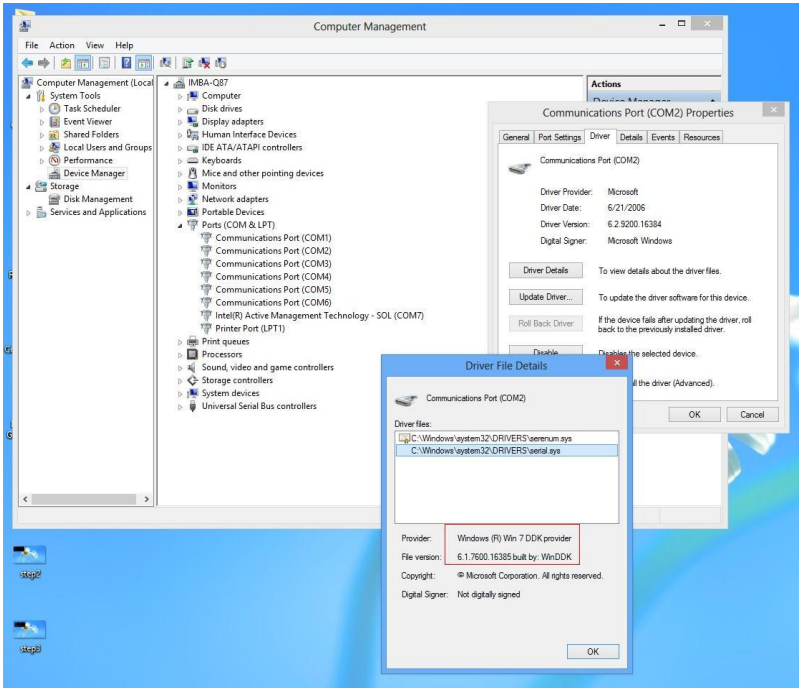

For Windows 10

1. Open the **STEP8 – Serial Port Driver (Optional)** folder and select **Win10_32_64**
2. Open the **Setup.exe** file in the folder
3. Follow the instructions
4. Drivers will be installed automatically

Step 9 – Install DIO Driver (for DIO module only)

Please refer to Appendix D – DI/O Utility (for DI/O Module)

Step 10 – Install CANBus Driver (for CANBus module only)

Please refer to Appendix C – CANBus Utility (for DI/O Module)

4.2 PCAP Dual Monitor Touch Settings

When two panels are used, they can set to be the primary and secondary display. The instruction below shows how this can be done:

1. Go to Display Panel and choose your preferred primary display.

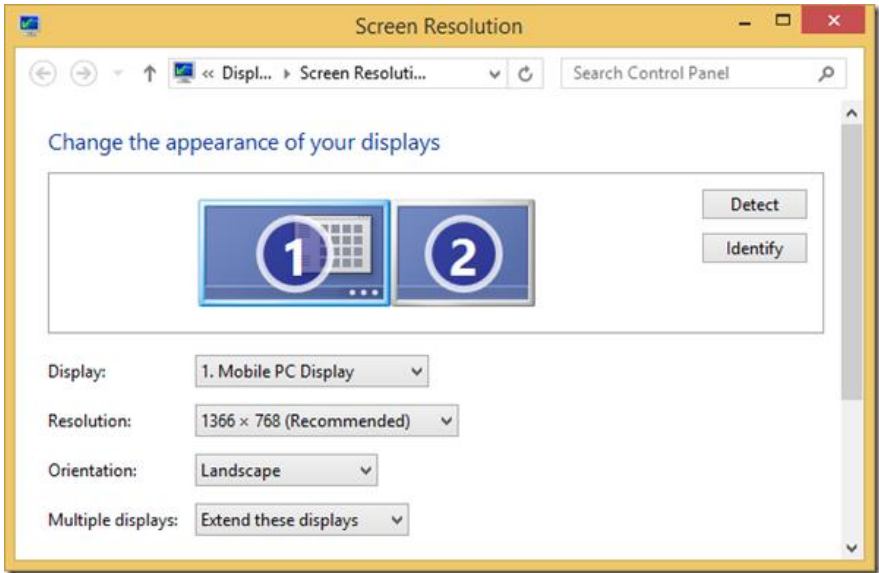

- Go to **Tablet PC Settings** in **Control Panel**. Under **Display options**, select the primary display from step 1. Apply the changes and exit.

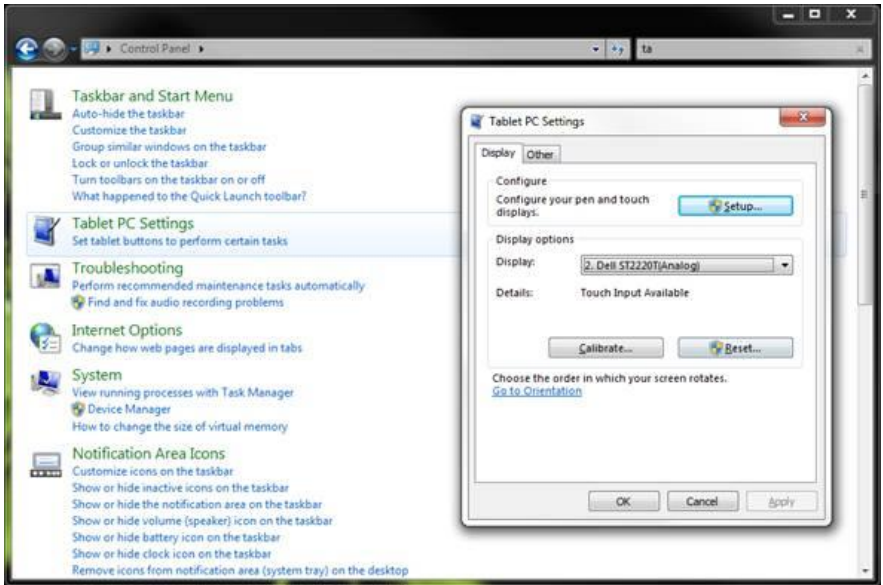

***Do NOT calibrate the screen on your own. Doing so might disrupt the device's factory calibration**

Appendix A

Watchdog Timer Programming

A.1 Watchdog Timer Initial Program

Table 1 : Super I/O relative register table		
	Default Value	Note
Index	0x2E(Note1)	SIO MB PnP Mode Index Register 0x2E or 0x4E
Data	0x2F(Note2)	SIO MB PnP Mode Data Register 0x2F or 0x4F

Table 2 : Watchdog relative register table					
	LDN	Register	BitNum	Value	Note
Timer Counter	0x07(Note3)	0xF6(Note4)		(Note24)	Time of watchdog timer (0~255) This register is byte access
Counting Unit	0x07(Note5)	0xF5(Note6)	3(Note7)	0(Note8)	Select time unit. 0: second 1: minute
Watchdog Enable	0x07(Note9)	0xF5(Note10)	5(Note11)	1(Note12)	0: Disable 1: Enable
Timeout Status	0x07(Note13)	0xF5(Note14)	6(Note15)	1	1: Clear timeout status
Output Mode	0x07(Note16)	0xF5(Note17)	4(Note18)	1(Note19)	Select WDTRST# output mode 0: level 1: pulse
WDTRST output	0x07(Note20)	0xFA(Note21)	0(Note22)	1(Note23)	Enable/Disable time out output via WDTRST# 0: Disable 1: Enable

```

*****
// SuperIO relative definition (Please reference to Table 1)
#define byte SIOIndex //This parameter is represented from Note1
#define byte SIOData //This parameter is represented from Note2
#define void IOWriteByte(byte IOPort, byte Value);
#define byte IOReadByte(byte IOPort);
// Watch Dog relative definition (Please reference to Table 2)
#define byte TimerLDN //This parameter is represented from Note3
#define byte TimerReg //This parameter is represented from Note4
#define byte TimerVal // This parameter is represented from Note24
#define byte UnitLDN //This parameter is represented from Note5
#define byte UnitReg //This parameter is represented from Note6
#define byte UnitBit //This parameter is represented from Note7
#define byte UnitVal //This parameter is represented from Note8
#define byte EnableLDN //This parameter is represented from Note9
#define byte EnableReg //This parameter is represented from Note10
#define byte EnableBit //This parameter is represented from Note11
#define byte EnableVal //This parameter is represented from Note12
#define byte StatusLDN // This parameter is represented from Note13
#define byte StatusReg // This parameter is represented from Note14
#define byte StatusBit // This parameter is represented from Note15
#define byte ModeLDN // This parameter is represented from Note16
#define byte ModeReg // This parameter is represented from Note17
#define byte ModeBit // This parameter is represented from Note18
#define byte ModeVal // This parameter is represented from Note19
#define byte WDTRstLDN // This parameter is represented from Note20
#define byte WDTRstReg // This parameter is represented from Note21
#define byte WDTRstBit // This parameter is represented from Note22
#define byte WDTRstVal // This parameter is represented from Note23
*****

```

Appendix B

I/O Information

B.1 I/O Address Map

Note: There is no PS/2 interface on the OMNI-SKU series, hence the exclamation marks

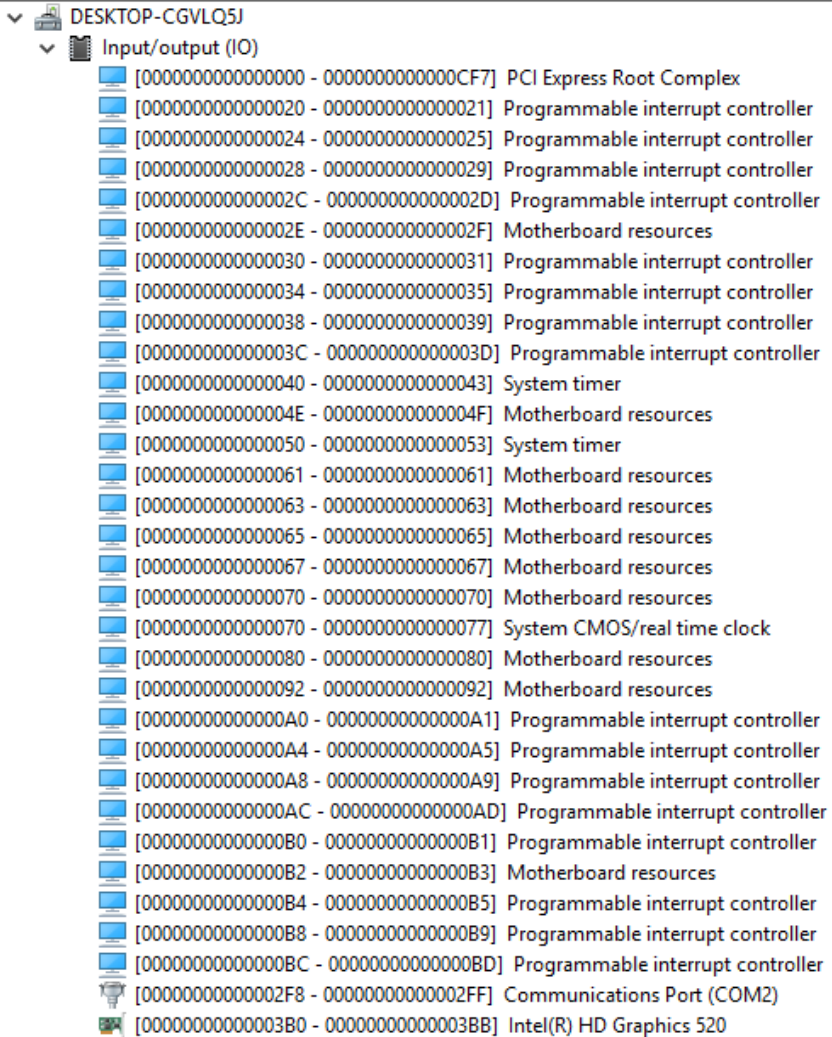































Address Range	Resource Name
[0000000000000000 - 0000000000000CF7]	PCI Express Root Complex
[0000000000000020 - 0000000000000021]	Programmable interrupt controller
[0000000000000024 - 0000000000000025]	Programmable interrupt controller
[0000000000000028 - 0000000000000029]	Programmable interrupt controller
[000000000000002C - 000000000000002D]	Programmable interrupt controller
[000000000000002E - 000000000000002F]	Motherboard resources
[0000000000000030 - 0000000000000031]	Programmable interrupt controller
[0000000000000034 - 0000000000000035]	Programmable interrupt controller
[0000000000000038 - 0000000000000039]	Programmable interrupt controller
[000000000000003C - 000000000000003D]	Programmable interrupt controller
[0000000000000040 - 0000000000000043]	System timer
[000000000000004E - 000000000000004F]	Motherboard resources
[0000000000000050 - 0000000000000053]	System timer
[0000000000000061 - 0000000000000061]	Motherboard resources
[0000000000000063 - 0000000000000063]	Motherboard resources
[0000000000000065 - 0000000000000065]	Motherboard resources
[0000000000000067 - 0000000000000067]	Motherboard resources
[0000000000000070 - 0000000000000070]	Motherboard resources
[0000000000000070 - 0000000000000077]	System CMOS/real time clock
[0000000000000080 - 0000000000000080]	Motherboard resources
[0000000000000092 - 0000000000000092]	Motherboard resources
[00000000000000A0 - 00000000000000A1]	Programmable interrupt controller
[00000000000000A4 - 00000000000000A5]	Programmable interrupt controller
[00000000000000A8 - 00000000000000A9]	Programmable interrupt controller
[00000000000000AC - 00000000000000AD]	Programmable interrupt controller
[00000000000000B0 - 00000000000000B1]	Programmable interrupt controller
[00000000000000B2 - 00000000000000B3]	Motherboard resources
[00000000000000B4 - 00000000000000B5]	Programmable interrupt controller
[00000000000000B8 - 00000000000000B9]	Programmable interrupt controller
[00000000000000BC - 00000000000000BD]	Programmable interrupt controller
[00000000000002F8 - 00000000000002FF]	Communications Port (COM2)
[00000000000003B0 - 00000000000003BB]	Intel(R) HD Graphics 520

































	[0000000000000A0 - 0000000000000A1]	Programmable interrupt controller
	[0000000000000A4 - 0000000000000A5]	Programmable interrupt controller
	[0000000000000A8 - 0000000000000A9]	Programmable interrupt controller
	[0000000000000AC - 0000000000000AD]	Programmable interrupt controller
	[0000000000000B0 - 0000000000000B1]	Programmable interrupt controller
	[0000000000000B2 - 0000000000000B3]	Motherboard resources
	[0000000000000B4 - 0000000000000B5]	Programmable interrupt controller
	[0000000000000B8 - 0000000000000B9]	Programmable interrupt controller
	[0000000000000BC - 0000000000000BD]	Programmable interrupt controller
	[00000000000002F8 - 00000000000002FF]	Communications Port (COM2)
	[00000000000003B0 - 00000000000003BB]	Intel(R) HD Graphics 520
	[00000000000003C0 - 00000000000003DF]	Intel(R) HD Graphics 520
	[00000000000003F8 - 00000000000003FF]	Communications Port (COM1)
	[00000000000004D0 - 00000000000004D1]	Programmable interrupt controller
	[0000000000000680 - 000000000000069F]	Motherboard resources
	[0000000000000A00 - 0000000000000A0F]	Motherboard resources
	[0000000000000A10 - 0000000000000A1F]	Motherboard resources
	[0000000000000A20 - 0000000000000A2F]	Motherboard resources
	[0000000000000D00 - 0000000000000FFF]	PCI Express Root Complex
	[0000000000000164E - 0000000000000164F]	Motherboard resources
	[00000000000001800 - 000000000000018FE]	Motherboard resources
	[00000000000001854 - 00000000000001857]	Motherboard resources
	[0000000000000E000 - 0000000000000EFFF]	Mobile 6th Generation Intel(R) Processor Family I/O PCI Express Root Port #1 - 9D10
	[0000000000000F000 - 0000000000000F03F]	Intel(R) HD Graphics 520
	[0000000000000F040 - 0000000000000F05F]	Mobile 6th Generation Intel(R) Processor Family I/O SMBUS - 9D23
	[0000000000000F060 - 0000000000000F07F]	Standard SATA AHCI Controller
	[0000000000000F080 - 0000000000000F083]	Standard SATA AHCI Controller
	[0000000000000F090 - 0000000000000F097]	Standard SATA AHCI Controller
	[0000000000000F090 - 0000000000000F097]	Standard SATA AHCI Controller
	[0000000000000FF00 - 0000000000000FFFE]	Motherboard resources
	[0000000000000FFFF - 0000000000000FFFF]	Motherboard resources
	[0000000000000FFFF - 0000000000000FFFF]	Motherboard resources
	[0000000000000FFFF - 0000000000000FFFF]	Motherboard resources
	[0000000000000FFFF - 0000000000000FFFF]	Motherboard resources
>		Interrupt request (IRQ)
>		Memory



































B.2 Memory Address Map



































Address Range	Device Name
[000000000000A0000 - 000000000000BFFFFF]	Intel(R) HD Graphics 520
[000000000000A0000 - 000000000000BFFFFF]	PCI Express Root Complex
[00000000090000000 - 0000000000FFFFFFF]	PCI Express Root Complex
[000000000C0000000 - 000000000CFFFFFFF]	Intel(R) HD Graphics 520
[000000000DE000000 - 000000000DEFFFFFFF]	Intel(R) HD Graphics 520
[000000000DF000000 - 000000000DF01FFFFF]	Intel(R) I210 Gigabit Network Connection
[000000000DF020000 - 000000000DF0F0FFFFF]	Mobile 6th Generation Intel(R) Processor Family I/O PCI Express Root Port #1 - 9D10
[000000000DF020000 - 000000000DF023FFFFF]	Intel(R) I210 Gigabit Network Connection
[000000000DF100000 - 000000000DF10FFFFF]	High Definition Audio Controller
[000000000DF110000 - 000000000DF11FFFFF]	Intel(R) USB 3.0 eXtensible Host Controller - 1.0 (Microsoft)
[000000000DF120000 - 000000000DF123FFFFF]	High Definition Audio Controller
[000000000DF124000 - 000000000DF127FFFFF]	Mobile 6th Generation Intel(R) Processor Family I/O PMC - 9D21
[000000000DF128000 - 000000000DF129FFFFF]	Standard SATA AHCI Controller
[000000000DF12A000 - 000000000DF12A0FFF]	Mobile 6th Generation Intel(R) Processor Family I/O SMBUS - 9D23
[000000000DF12B000 - 000000000DF12B7FFF]	Standard SATA AHCI Controller
[000000000DF12C000 - 000000000DF12C0FFF]	Standard SATA AHCI Controller
[000000000DF12E000 - 000000000DF12EFFFFF]	Mobile 6th Generation Intel(R) Processor Family I/O Thermal subsystem - 9D31
[000000000DFFE0000 - 000000000DFFFFFFFF]	Motherboard resources
[000000000E0000000 - 000000000EFFFFFFF]	Motherboard resources
[000000000FD000000 - 000000000FDABFFFFF]	Motherboard resources
[000000000FD000000 - 000000000FE7FFFFFFF]	PCI Express Root Complex
[000000000FDAC0000 - 000000000FDACFFFFF]	Motherboard resources
[000000000FDAD0000 - 000000000FDADFFFFF]	Motherboard resources
[000000000FDAE0000 - 000000000FDAEFFFFF]	Motherboard resources
[000000000FDAF0000 - 000000000FDAFFFFF]	Motherboard resources
[000000000FDB00000 - 000000000FDBFFFFFFF]	Motherboard resources
[000000000FE000000 - 000000000FE01FFFFF]	Motherboard resources
[000000000FE028000 - 000000000FE028FFFFF]	Motherboard resources
[000000000FE029000 - 000000000FE029FFFFF]	Motherboard resources
[000000000FE036000 - 000000000FE03BFFFFF]	Motherboard resources
[000000000FE03D000 - 000000000FE3FFFFFFF]	Motherboard resources
[000000000FE40F000 - 000000000FE40FFFFF]	Intel(R) Management Engine Interface
[000000000FE410000 - 000000000FE7FFFFFFF]	Motherboard resources



































	[00000000DF120000 - 00000000DF123FFF]	High Definition Audio Controller
	[00000000DF124000 - 00000000DF127FFF]	Mobile 6th Generation Intel(R) Processor Family I/O PMC - 9D21
	[00000000DF128000 - 00000000DF129FFF]	Standard SATA AHCI Controller
	[00000000DF12A000 - 00000000DF12A0FF]	Mobile 6th Generation Intel(R) Processor Family I/O SMBUS - 9D23
	[00000000DF12B000 - 00000000DF12B7FF]	Standard SATA AHCI Controller
	[00000000DF12C000 - 00000000DF12C0FF]	Standard SATA AHCI Controller
	[00000000DF12E000 - 00000000DF12EFFF]	Mobile 6th Generation Intel(R) Processor Family I/O Thermal subsystem - 9D31
	[00000000DFFE0000 - 00000000DFFFFFFF]	Motherboard resources
	[00000000E0000000 - 00000000EFFFFFFF]	Motherboard resources
	[00000000FD000000 - 00000000FDABFFFF]	Motherboard resources
	[00000000FD000000 - 00000000FE7FFFFF]	PCI Express Root Complex
	[00000000FDAC0000 - 00000000FDACFFFF]	Motherboard resources
	[00000000FDAD0000 - 00000000FDADFFFF]	Motherboard resources
	[00000000FDAE0000 - 00000000FDAEFFFF]	Motherboard resources
	[00000000FDAF0000 - 00000000FDAFFFFF]	Motherboard resources
	[00000000FDB00000 - 00000000FDBFFFFF]	Motherboard resources
	[00000000FE000000 - 00000000FE01FFFF]	Motherboard resources
	[00000000FE028000 - 00000000FE028FFF]	Motherboard resources
	[00000000FE029000 - 00000000FE029FFF]	Motherboard resources
	[00000000FE036000 - 00000000FE03BFFF]	Motherboard resources
	[00000000FE03D000 - 00000000FE3FFFFFF]	Motherboard resources
	[00000000FE40F000 - 00000000FE40FFFF]	Intel(R) Management Engine Interface
	[00000000FE410000 - 00000000FE7FFFFFF]	Motherboard resources
	[00000000FED00000 - 00000000FED003FF]	High precision event timer
	[00000000FED10000 - 00000000FED17FFF]	Motherboard resources
	[00000000FED18000 - 00000000FED18FFF]	Motherboard resources
	[00000000FED19000 - 00000000FED19FFF]	Motherboard resources
	[00000000FED20000 - 00000000FED3FFFF]	Motherboard resources
	[00000000FED40000 - 00000000FED40FFF]	Trusted Platform Module 1.2
	[00000000FED45000 - 00000000FED8FFFF]	Motherboard resources
	[00000000FED90000 - 00000000FED93FFF]	Motherboard resources
	[00000000FEE00000 - 00000000FEEFFFFFF]	Motherboard resources
	[00000000FF000000 - 00000000FFFFFFFF]	Legacy device
	[00000000FF000000 - 00000000FFFFFFFF]	Motherboard resources



































B.3 IRQ Mapping Chart



































Interrupt request (IRQ)	
 (ISA) 0x00000000 (00)	System timer
 (ISA) 0x00000003 (03)	Communications Port (COM2)
 (ISA) 0x00000004 (04)	Communications Port (COM1)
 (ISA) 0x00000008 (08)	System CMOS/real time clock
 (ISA) 0x0000000E (14)	Motherboard resources
 (ISA) 0x00000036 (54)	Microsoft ACPI-Compliant System
 (ISA) 0x00000037 (55)	Microsoft ACPI-Compliant System
 (ISA) 0x00000038 (56)	Microsoft ACPI-Compliant System
 (ISA) 0x00000039 (57)	Microsoft ACPI-Compliant System
 (ISA) 0x0000003A (58)	Microsoft ACPI-Compliant System
 (ISA) 0x0000003B (59)	Microsoft ACPI-Compliant System
 (ISA) 0x0000003C (60)	Microsoft ACPI-Compliant System
 (ISA) 0x0000003D (61)	Microsoft ACPI-Compliant System
 (ISA) 0x0000003E (62)	Microsoft ACPI-Compliant System
 (ISA) 0x0000003F (63)	Microsoft ACPI-Compliant System
 (ISA) 0x00000040 (64)	Microsoft ACPI-Compliant System
 (ISA) 0x00000041 (65)	Microsoft ACPI-Compliant System
 (ISA) 0x00000042 (66)	Microsoft ACPI-Compliant System
 (ISA) 0x00000043 (67)	Microsoft ACPI-Compliant System
 (ISA) 0x00000044 (68)	Microsoft ACPI-Compliant System
 (ISA) 0x00000045 (69)	Microsoft ACPI-Compliant System
 (ISA) 0x00000046 (70)	Microsoft ACPI-Compliant System
 (ISA) 0x00000047 (71)	Microsoft ACPI-Compliant System
 (ISA) 0x00000048 (72)	Microsoft ACPI-Compliant System
 (ISA) 0x00000049 (73)	Microsoft ACPI-Compliant System
 (ISA) 0x0000004A (74)	Microsoft ACPI-Compliant System
 (ISA) 0x0000004B (75)	Microsoft ACPI-Compliant System
 (ISA) 0x0000004C (76)	Microsoft ACPI-Compliant System
 (ISA) 0x0000004D (77)	Microsoft ACPI-Compliant System
 (ISA) 0x0000004E (78)	Microsoft ACPI-Compliant System
 (ISA) 0x0000004F (79)	Microsoft ACPI-Compliant System
 (ISA) 0x00000050 (80)	Microsoft ACPI-Compliant System
 (ISA) 0x00000051 (81)	Microsoft ACPI-Compliant System



































	(ISA) 0x00000051 (81)	Microsoft ACPI-Compliant System
	(ISA) 0x00000052 (82)	Microsoft ACPI-Compliant System
	(ISA) 0x00000053 (83)	Microsoft ACPI-Compliant System
	(ISA) 0x00000054 (84)	Microsoft ACPI-Compliant System
	(ISA) 0x00000055 (85)	Microsoft ACPI-Compliant System
	(ISA) 0x00000056 (86)	Microsoft ACPI-Compliant System
	(ISA) 0x00000057 (87)	Microsoft ACPI-Compliant System
	(ISA) 0x00000058 (88)	Microsoft ACPI-Compliant System
	(ISA) 0x00000059 (89)	Microsoft ACPI-Compliant System
	(ISA) 0x0000005A (90)	Microsoft ACPI-Compliant System
	(ISA) 0x0000005B (91)	Microsoft ACPI-Compliant System
	(ISA) 0x0000005C (92)	Microsoft ACPI-Compliant System
	(ISA) 0x0000005D (93)	Microsoft ACPI-Compliant System
	(ISA) 0x0000005E (94)	Microsoft ACPI-Compliant System
	(ISA) 0x0000005F (95)	Microsoft ACPI-Compliant System
	(ISA) 0x00000060 (96)	Microsoft ACPI-Compliant System
	(ISA) 0x00000061 (97)	Microsoft ACPI-Compliant System
	(ISA) 0x00000062 (98)	Microsoft ACPI-Compliant System
	(ISA) 0x00000063 (99)	Microsoft ACPI-Compliant System
	(ISA) 0x00000064 (100)	Microsoft ACPI-Compliant System
	(ISA) 0x00000065 (101)	Microsoft ACPI-Compliant System
	(ISA) 0x00000066 (102)	Microsoft ACPI-Compliant System
	(ISA) 0x00000067 (103)	Microsoft ACPI-Compliant System
	(ISA) 0x00000068 (104)	Microsoft ACPI-Compliant System
	(ISA) 0x00000069 (105)	Microsoft ACPI-Compliant System
	(ISA) 0x0000006A (106)	Microsoft ACPI-Compliant System
	(ISA) 0x0000006B (107)	Microsoft ACPI-Compliant System
	(ISA) 0x0000006C (108)	Microsoft ACPI-Compliant System
	(ISA) 0x0000006D (109)	Microsoft ACPI-Compliant System
	(ISA) 0x0000006E (110)	Microsoft ACPI-Compliant System
	(ISA) 0x0000006F (111)	Microsoft ACPI-Compliant System
	(ISA) 0x00000070 (112)	Microsoft ACPI-Compliant System
	(ISA) 0x00000071 (113)	Microsoft ACPI-Compliant System
	(ISA) 0x00000072 (114)	Microsoft ACPI-Compliant System



































	(ISA) 0x00000072 (114)	Microsoft ACPI-Compliant System
	(ISA) 0x00000073 (115)	Microsoft ACPI-Compliant System
	(ISA) 0x00000074 (116)	Microsoft ACPI-Compliant System
	(ISA) 0x00000075 (117)	Microsoft ACPI-Compliant System
	(ISA) 0x00000076 (118)	Microsoft ACPI-Compliant System
	(ISA) 0x00000077 (119)	Microsoft ACPI-Compliant System
	(ISA) 0x00000078 (120)	Microsoft ACPI-Compliant System
	(ISA) 0x00000079 (121)	Microsoft ACPI-Compliant System
	(ISA) 0x0000007A (122)	Microsoft ACPI-Compliant System
	(ISA) 0x0000007B (123)	Microsoft ACPI-Compliant System
	(ISA) 0x0000007C (124)	Microsoft ACPI-Compliant System
	(ISA) 0x0000007D (125)	Microsoft ACPI-Compliant System
	(ISA) 0x0000007E (126)	Microsoft ACPI-Compliant System
	(ISA) 0x0000007F (127)	Microsoft ACPI-Compliant System
	(ISA) 0x00000080 (128)	Microsoft ACPI-Compliant System
	(ISA) 0x00000081 (129)	Microsoft ACPI-Compliant System
	(ISA) 0x00000082 (130)	Microsoft ACPI-Compliant System
	(ISA) 0x00000083 (131)	Microsoft ACPI-Compliant System
	(ISA) 0x00000084 (132)	Microsoft ACPI-Compliant System
	(ISA) 0x00000085 (133)	Microsoft ACPI-Compliant System
	(ISA) 0x00000086 (134)	Microsoft ACPI-Compliant System
	(ISA) 0x00000087 (135)	Microsoft ACPI-Compliant System
	(ISA) 0x00000088 (136)	Microsoft ACPI-Compliant System
	(ISA) 0x00000089 (137)	Microsoft ACPI-Compliant System
	(ISA) 0x0000008A (138)	Microsoft ACPI-Compliant System
	(ISA) 0x0000008B (139)	Microsoft ACPI-Compliant System
	(ISA) 0x0000008C (140)	Microsoft ACPI-Compliant System
	(ISA) 0x0000008D (141)	Microsoft ACPI-Compliant System
	(ISA) 0x0000008E (142)	Microsoft ACPI-Compliant System
	(ISA) 0x0000008F (143)	Microsoft ACPI-Compliant System
	(ISA) 0x00000090 (144)	Microsoft ACPI-Compliant System
	(ISA) 0x00000091 (145)	Microsoft ACPI-Compliant System
	(ISA) 0x00000092 (146)	Microsoft ACPI-Compliant System
	(ISA) 0x00000093 (147)	Microsoft ACPI-Compliant System



































 (ISA) 0x00000093 (147)	Microsoft ACPI-Compliant System
 (ISA) 0x00000094 (148)	Microsoft ACPI-Compliant System
 (ISA) 0x00000095 (149)	Microsoft ACPI-Compliant System
 (ISA) 0x00000096 (150)	Microsoft ACPI-Compliant System
 (ISA) 0x00000097 (151)	Microsoft ACPI-Compliant System
 (ISA) 0x00000098 (152)	Microsoft ACPI-Compliant System
 (ISA) 0x00000099 (153)	Microsoft ACPI-Compliant System
 (ISA) 0x0000009A (154)	Microsoft ACPI-Compliant System
 (ISA) 0x0000009B (155)	Microsoft ACPI-Compliant System
 (ISA) 0x0000009C (156)	Microsoft ACPI-Compliant System
 (ISA) 0x0000009D (157)	Microsoft ACPI-Compliant System
 (ISA) 0x0000009E (158)	Microsoft ACPI-Compliant System
 (ISA) 0x0000009F (159)	Microsoft ACPI-Compliant System
 (ISA) 0x000000A0 (160)	Microsoft ACPI-Compliant System
 (ISA) 0x000000A1 (161)	Microsoft ACPI-Compliant System
 (ISA) 0x000000A2 (162)	Microsoft ACPI-Compliant System
 (ISA) 0x000000A3 (163)	Microsoft ACPI-Compliant System
 (ISA) 0x000000A4 (164)	Microsoft ACPI-Compliant System
 (ISA) 0x000000A5 (165)	Microsoft ACPI-Compliant System
 (ISA) 0x000000A6 (166)	Microsoft ACPI-Compliant System
 (ISA) 0x000000A7 (167)	Microsoft ACPI-Compliant System
 (ISA) 0x000000A8 (168)	Microsoft ACPI-Compliant System
 (ISA) 0x000000A9 (169)	Microsoft ACPI-Compliant System
 (ISA) 0x000000AA (170)	Microsoft ACPI-Compliant System
 (ISA) 0x000000AB (171)	Microsoft ACPI-Compliant System
 (ISA) 0x000000AC (172)	Microsoft ACPI-Compliant System
 (ISA) 0x000000AD (173)	Microsoft ACPI-Compliant System
 (ISA) 0x000000AE (174)	Microsoft ACPI-Compliant System
 (ISA) 0x000000AF (175)	Microsoft ACPI-Compliant System
 (ISA) 0x000000B0 (176)	Microsoft ACPI-Compliant System
 (ISA) 0x000000B1 (177)	Microsoft ACPI-Compliant System
 (ISA) 0x000000B2 (178)	Microsoft ACPI-Compliant System
 (ISA) 0x000000B3 (179)	Microsoft ACPI-Compliant System
 (ISA) 0x000000B4 (180)	Microsoft ACPI-Compliant System



































	(ISA) 0x000000B4 (180)	Microsoft ACPI-Compliant System
	(ISA) 0x000000B5 (181)	Microsoft ACPI-Compliant System
	(ISA) 0x000000B6 (182)	Microsoft ACPI-Compliant System
	(ISA) 0x000000B7 (183)	Microsoft ACPI-Compliant System
	(ISA) 0x000000B8 (184)	Microsoft ACPI-Compliant System
	(ISA) 0x000000B9 (185)	Microsoft ACPI-Compliant System
	(ISA) 0x000000BA (186)	Microsoft ACPI-Compliant System
	(ISA) 0x000000BB (187)	Microsoft ACPI-Compliant System
	(ISA) 0x000000BC (188)	Microsoft ACPI-Compliant System
	(ISA) 0x000000BD (189)	Microsoft ACPI-Compliant System
	(ISA) 0x000000BE (190)	Microsoft ACPI-Compliant System
	(ISA) 0x000000BF (191)	Microsoft ACPI-Compliant System
	(ISA) 0x000000C0 (192)	Microsoft ACPI-Compliant System
	(ISA) 0x000000C1 (193)	Microsoft ACPI-Compliant System
	(ISA) 0x000000C2 (194)	Microsoft ACPI-Compliant System
	(ISA) 0x000000C3 (195)	Microsoft ACPI-Compliant System
	(ISA) 0x000000C4 (196)	Microsoft ACPI-Compliant System
	(ISA) 0x000000C5 (197)	Microsoft ACPI-Compliant System
	(ISA) 0x000000C6 (198)	Microsoft ACPI-Compliant System
	(ISA) 0x000000C7 (199)	Microsoft ACPI-Compliant System
	(ISA) 0x000000C8 (200)	Microsoft ACPI-Compliant System
	(ISA) 0x000000C9 (201)	Microsoft ACPI-Compliant System
	(ISA) 0x000000CA (202)	Microsoft ACPI-Compliant System
	(ISA) 0x000000CB (203)	Microsoft ACPI-Compliant System
	(ISA) 0x000000CC (204)	Microsoft ACPI-Compliant System
	(ISA) 0x00000100 (256)	Microsoft ACPI-Compliant System
	(ISA) 0x00000101 (257)	Microsoft ACPI-Compliant System
	(ISA) 0x00000102 (258)	Microsoft ACPI-Compliant System
	(ISA) 0x00000103 (259)	Microsoft ACPI-Compliant System
	(ISA) 0x00000104 (260)	Microsoft ACPI-Compliant System
	(ISA) 0x00000105 (261)	Microsoft ACPI-Compliant System
	(ISA) 0x00000106 (262)	Microsoft ACPI-Compliant System
	(ISA) 0x00000107 (263)	Microsoft ACPI-Compliant System
	(ISA) 0x00000108 (264)	Microsoft ACPI-Compliant System



































 (ISA) 0x00000108 (264)	Microsoft ACPI-Compliant System
 (ISA) 0x00000109 (265)	Microsoft ACPI-Compliant System
 (ISA) 0x0000010A (266)	Microsoft ACPI-Compliant System
 (ISA) 0x0000010B (267)	Microsoft ACPI-Compliant System
 (ISA) 0x0000010C (268)	Microsoft ACPI-Compliant System
 (ISA) 0x0000010D (269)	Microsoft ACPI-Compliant System
 (ISA) 0x0000010E (270)	Microsoft ACPI-Compliant System
 (ISA) 0x0000010F (271)	Microsoft ACPI-Compliant System
 (ISA) 0x00000110 (272)	Microsoft ACPI-Compliant System
 (ISA) 0x00000111 (273)	Microsoft ACPI-Compliant System
 (ISA) 0x00000112 (274)	Microsoft ACPI-Compliant System
 (ISA) 0x00000113 (275)	Microsoft ACPI-Compliant System
 (ISA) 0x00000114 (276)	Microsoft ACPI-Compliant System
 (ISA) 0x00000115 (277)	Microsoft ACPI-Compliant System
 (ISA) 0x00000116 (278)	Microsoft ACPI-Compliant System
 (ISA) 0x00000117 (279)	Microsoft ACPI-Compliant System
 (ISA) 0x00000118 (280)	Microsoft ACPI-Compliant System
 (ISA) 0x00000119 (281)	Microsoft ACPI-Compliant System
 (ISA) 0x0000011A (282)	Microsoft ACPI-Compliant System
 (ISA) 0x0000011B (283)	Microsoft ACPI-Compliant System
 (ISA) 0x0000011C (284)	Microsoft ACPI-Compliant System
 (ISA) 0x0000011D (285)	Microsoft ACPI-Compliant System
 (ISA) 0x0000011E (286)	Microsoft ACPI-Compliant System
 (ISA) 0x0000011F (287)	Microsoft ACPI-Compliant System
 (ISA) 0x00000120 (288)	Microsoft ACPI-Compliant System
 (ISA) 0x00000121 (289)	Microsoft ACPI-Compliant System
 (ISA) 0x00000122 (290)	Microsoft ACPI-Compliant System
 (ISA) 0x00000123 (291)	Microsoft ACPI-Compliant System
 (ISA) 0x00000124 (292)	Microsoft ACPI-Compliant System
 (ISA) 0x00000125 (293)	Microsoft ACPI-Compliant System
 (ISA) 0x00000126 (294)	Microsoft ACPI-Compliant System
 (ISA) 0x00000127 (295)	Microsoft ACPI-Compliant System
 (ISA) 0x00000128 (296)	Microsoft ACPI-Compliant System
 (ISA) 0x00000129 (297)	Microsoft ACPI-Compliant System



































	(ISA) 0x00000129 (297)	Microsoft ACPI-Compliant System
	(ISA) 0x0000012A (298)	Microsoft ACPI-Compliant System
	(ISA) 0x0000012B (299)	Microsoft ACPI-Compliant System
	(ISA) 0x0000012C (300)	Microsoft ACPI-Compliant System
	(ISA) 0x0000012D (301)	Microsoft ACPI-Compliant System
	(ISA) 0x0000012E (302)	Microsoft ACPI-Compliant System
	(ISA) 0x0000012F (303)	Microsoft ACPI-Compliant System
	(ISA) 0x00000130 (304)	Microsoft ACPI-Compliant System
	(ISA) 0x00000131 (305)	Microsoft ACPI-Compliant System
	(ISA) 0x00000132 (306)	Microsoft ACPI-Compliant System
	(ISA) 0x00000133 (307)	Microsoft ACPI-Compliant System
	(ISA) 0x00000134 (308)	Microsoft ACPI-Compliant System
	(ISA) 0x00000135 (309)	Microsoft ACPI-Compliant System
	(ISA) 0x00000136 (310)	Microsoft ACPI-Compliant System
	(ISA) 0x00000137 (311)	Microsoft ACPI-Compliant System
	(ISA) 0x00000138 (312)	Microsoft ACPI-Compliant System
	(ISA) 0x00000139 (313)	Microsoft ACPI-Compliant System
	(ISA) 0x0000013A (314)	Microsoft ACPI-Compliant System
	(ISA) 0x0000013B (315)	Microsoft ACPI-Compliant System
	(ISA) 0x0000013C (316)	Microsoft ACPI-Compliant System
	(ISA) 0x0000013D (317)	Microsoft ACPI-Compliant System
	(ISA) 0x0000013E (318)	Microsoft ACPI-Compliant System
	(ISA) 0x0000013F (319)	Microsoft ACPI-Compliant System
	(ISA) 0x00000140 (320)	Microsoft ACPI-Compliant System
	(ISA) 0x00000141 (321)	Microsoft ACPI-Compliant System
	(ISA) 0x00000142 (322)	Microsoft ACPI-Compliant System
	(ISA) 0x00000143 (323)	Microsoft ACPI-Compliant System
	(ISA) 0x00000144 (324)	Microsoft ACPI-Compliant System
	(ISA) 0x00000145 (325)	Microsoft ACPI-Compliant System
	(ISA) 0x00000146 (326)	Microsoft ACPI-Compliant System
	(ISA) 0x00000147 (327)	Microsoft ACPI-Compliant System
	(ISA) 0x00000148 (328)	Microsoft ACPI-Compliant System
	(ISA) 0x00000149 (329)	Microsoft ACPI-Compliant System
	(ISA) 0x0000014A (330)	Microsoft ACPI-Compliant System



































	(ISA) 0x0000014A (330)	Microsoft ACPI-Compliant System
	(ISA) 0x0000014B (331)	Microsoft ACPI-Compliant System
	(ISA) 0x0000014C (332)	Microsoft ACPI-Compliant System
	(ISA) 0x0000014D (333)	Microsoft ACPI-Compliant System
	(ISA) 0x0000014E (334)	Microsoft ACPI-Compliant System
	(ISA) 0x0000014F (335)	Microsoft ACPI-Compliant System
	(ISA) 0x00000150 (336)	Microsoft ACPI-Compliant System
	(ISA) 0x00000151 (337)	Microsoft ACPI-Compliant System
	(ISA) 0x00000152 (338)	Microsoft ACPI-Compliant System
	(ISA) 0x00000153 (339)	Microsoft ACPI-Compliant System
	(ISA) 0x00000154 (340)	Microsoft ACPI-Compliant System
	(ISA) 0x00000155 (341)	Microsoft ACPI-Compliant System
	(ISA) 0x00000156 (342)	Microsoft ACPI-Compliant System
	(ISA) 0x00000157 (343)	Microsoft ACPI-Compliant System
	(ISA) 0x00000158 (344)	Microsoft ACPI-Compliant System
	(ISA) 0x00000159 (345)	Microsoft ACPI-Compliant System
	(ISA) 0x0000015A (346)	Microsoft ACPI-Compliant System
	(ISA) 0x0000015B (347)	Microsoft ACPI-Compliant System
	(ISA) 0x0000015C (348)	Microsoft ACPI-Compliant System
	(ISA) 0x0000015D (349)	Microsoft ACPI-Compliant System
	(ISA) 0x0000015E (350)	Microsoft ACPI-Compliant System
	(ISA) 0x0000015F (351)	Microsoft ACPI-Compliant System
	(ISA) 0x00000160 (352)	Microsoft ACPI-Compliant System
	(ISA) 0x00000161 (353)	Microsoft ACPI-Compliant System
	(ISA) 0x00000162 (354)	Microsoft ACPI-Compliant System
	(ISA) 0x00000163 (355)	Microsoft ACPI-Compliant System
	(ISA) 0x00000164 (356)	Microsoft ACPI-Compliant System
	(ISA) 0x00000165 (357)	Microsoft ACPI-Compliant System
	(ISA) 0x00000166 (358)	Microsoft ACPI-Compliant System
	(ISA) 0x00000167 (359)	Microsoft ACPI-Compliant System
	(ISA) 0x00000168 (360)	Microsoft ACPI-Compliant System
	(ISA) 0x00000169 (361)	Microsoft ACPI-Compliant System
	(ISA) 0x0000016A (362)	Microsoft ACPI-Compliant System
	(ISA) 0x0000016B (363)	Microsoft ACPI-Compliant System

	(ISA) 0x0000016B (363)	Microsoft ACPI-Compliant System
	(ISA) 0x0000016C (364)	Microsoft ACPI-Compliant System
	(ISA) 0x0000016D (365)	Microsoft ACPI-Compliant System
	(ISA) 0x0000016E (366)	Microsoft ACPI-Compliant System
	(ISA) 0x0000016F (367)	Microsoft ACPI-Compliant System
	(ISA) 0x00000170 (368)	Microsoft ACPI-Compliant System
	(ISA) 0x00000171 (369)	Microsoft ACPI-Compliant System
	(ISA) 0x00000172 (370)	Microsoft ACPI-Compliant System
	(ISA) 0x00000173 (371)	Microsoft ACPI-Compliant System
	(ISA) 0x00000174 (372)	Microsoft ACPI-Compliant System
	(ISA) 0x00000175 (373)	Microsoft ACPI-Compliant System
	(ISA) 0x00000176 (374)	Microsoft ACPI-Compliant System
	(ISA) 0x00000177 (375)	Microsoft ACPI-Compliant System
	(ISA) 0x00000178 (376)	Microsoft ACPI-Compliant System
	(ISA) 0x00000179 (377)	Microsoft ACPI-Compliant System
	(ISA) 0x0000017A (378)	Microsoft ACPI-Compliant System
	(ISA) 0x0000017B (379)	Microsoft ACPI-Compliant System
	(ISA) 0x0000017C (380)	Microsoft ACPI-Compliant System
	(ISA) 0x0000017D (381)	Microsoft ACPI-Compliant System
	(ISA) 0x0000017E (382)	Microsoft ACPI-Compliant System
	(ISA) 0x0000017F (383)	Microsoft ACPI-Compliant System
	(ISA) 0x00000180 (384)	Microsoft ACPI-Compliant System
	(ISA) 0x00000181 (385)	Microsoft ACPI-Compliant System
	(ISA) 0x00000182 (386)	Microsoft ACPI-Compliant System
	(ISA) 0x00000183 (387)	Microsoft ACPI-Compliant System
	(ISA) 0x00000184 (388)	Microsoft ACPI-Compliant System
	(ISA) 0x00000185 (389)	Microsoft ACPI-Compliant System
	(ISA) 0x00000186 (390)	Microsoft ACPI-Compliant System
	(ISA) 0x00000187 (391)	Microsoft ACPI-Compliant System
	(ISA) 0x00000188 (392)	Microsoft ACPI-Compliant System
	(ISA) 0x00000189 (393)	Microsoft ACPI-Compliant System
	(ISA) 0x0000018A (394)	Microsoft ACPI-Compliant System
	(ISA) 0x0000018B (395)	Microsoft ACPI-Compliant System
	(ISA) 0x0000018C (396)	Microsoft ACPI-Compliant System

	(ISA) 0x0000018C (396)	Microsoft ACPI-Compliant System
	(ISA) 0x0000018D (397)	Microsoft ACPI-Compliant System
	(ISA) 0x0000018E (398)	Microsoft ACPI-Compliant System
	(ISA) 0x0000018F (399)	Microsoft ACPI-Compliant System
	(ISA) 0x00000190 (400)	Microsoft ACPI-Compliant System
	(ISA) 0x00000191 (401)	Microsoft ACPI-Compliant System
	(ISA) 0x00000192 (402)	Microsoft ACPI-Compliant System
	(ISA) 0x00000193 (403)	Microsoft ACPI-Compliant System
	(ISA) 0x00000194 (404)	Microsoft ACPI-Compliant System
	(ISA) 0x00000195 (405)	Microsoft ACPI-Compliant System
	(ISA) 0x00000196 (406)	Microsoft ACPI-Compliant System
	(ISA) 0x00000197 (407)	Microsoft ACPI-Compliant System
	(ISA) 0x00000198 (408)	Microsoft ACPI-Compliant System
	(ISA) 0x00000199 (409)	Microsoft ACPI-Compliant System
	(ISA) 0x0000019A (410)	Microsoft ACPI-Compliant System
	(ISA) 0x0000019B (411)	Microsoft ACPI-Compliant System
	(ISA) 0x0000019C (412)	Microsoft ACPI-Compliant System
	(ISA) 0x0000019D (413)	Microsoft ACPI-Compliant System
	(ISA) 0x0000019E (414)	Microsoft ACPI-Compliant System
	(ISA) 0x0000019F (415)	Microsoft ACPI-Compliant System
	(ISA) 0x000001A0 (416)	Microsoft ACPI-Compliant System
	(ISA) 0x000001A1 (417)	Microsoft ACPI-Compliant System
	(ISA) 0x000001A2 (418)	Microsoft ACPI-Compliant System
	(ISA) 0x000001A3 (419)	Microsoft ACPI-Compliant System
	(ISA) 0x000001A4 (420)	Microsoft ACPI-Compliant System
	(ISA) 0x000001A5 (421)	Microsoft ACPI-Compliant System
	(ISA) 0x000001A6 (422)	Microsoft ACPI-Compliant System
	(ISA) 0x000001A7 (423)	Microsoft ACPI-Compliant System
	(ISA) 0x000001A8 (424)	Microsoft ACPI-Compliant System
	(ISA) 0x000001A9 (425)	Microsoft ACPI-Compliant System
	(ISA) 0x000001AA (426)	Microsoft ACPI-Compliant System
	(ISA) 0x000001AB (427)	Microsoft ACPI-Compliant System
	(ISA) 0x000001AC (428)	Microsoft ACPI-Compliant System
	(ISA) 0x000001AD (429)	Microsoft ACPI-Compliant System

	(ISA) 0x000001AD (429)	Microsoft ACPI-Compliant System
	(ISA) 0x000001AE (430)	Microsoft ACPI-Compliant System
	(ISA) 0x000001AF (431)	Microsoft ACPI-Compliant System
	(ISA) 0x000001B0 (432)	Microsoft ACPI-Compliant System
	(ISA) 0x000001B1 (433)	Microsoft ACPI-Compliant System
	(ISA) 0x000001B2 (434)	Microsoft ACPI-Compliant System
	(ISA) 0x000001B3 (435)	Microsoft ACPI-Compliant System
	(ISA) 0x000001B4 (436)	Microsoft ACPI-Compliant System
	(ISA) 0x000001B5 (437)	Microsoft ACPI-Compliant System
	(ISA) 0x000001B6 (438)	Microsoft ACPI-Compliant System
	(ISA) 0x000001B7 (439)	Microsoft ACPI-Compliant System
	(ISA) 0x000001B8 (440)	Microsoft ACPI-Compliant System
	(ISA) 0x000001B9 (441)	Microsoft ACPI-Compliant System
	(ISA) 0x000001BA (442)	Microsoft ACPI-Compliant System
	(ISA) 0x000001BB (443)	Microsoft ACPI-Compliant System
	(ISA) 0x000001BC (444)	Microsoft ACPI-Compliant System
	(ISA) 0x000001BD (445)	Microsoft ACPI-Compliant System
	(ISA) 0x000001BE (446)	Microsoft ACPI-Compliant System
	(ISA) 0x000001BF (447)	Microsoft ACPI-Compliant System
	(ISA) 0x000001C0 (448)	Microsoft ACPI-Compliant System
	(ISA) 0x000001C1 (449)	Microsoft ACPI-Compliant System
	(ISA) 0x000001C2 (450)	Microsoft ACPI-Compliant System
	(ISA) 0x000001C3 (451)	Microsoft ACPI-Compliant System
	(ISA) 0x000001C4 (452)	Microsoft ACPI-Compliant System
	(ISA) 0x000001C5 (453)	Microsoft ACPI-Compliant System
	(ISA) 0x000001C6 (454)	Microsoft ACPI-Compliant System
	(ISA) 0x000001C7 (455)	Microsoft ACPI-Compliant System
	(ISA) 0x000001C8 (456)	Microsoft ACPI-Compliant System
	(ISA) 0x000001C9 (457)	Microsoft ACPI-Compliant System
	(ISA) 0x000001CA (458)	Microsoft ACPI-Compliant System
	(ISA) 0x000001CB (459)	Microsoft ACPI-Compliant System
	(ISA) 0x000001CC (460)	Microsoft ACPI-Compliant System
	(ISA) 0x000001CD (461)	Microsoft ACPI-Compliant System
	(ISA) 0x000001CE (462)	Microsoft ACPI-Compliant System

	(ISA) 0x000001CE (462)	Microsoft ACPI-Compliant System
	(ISA) 0x000001CF (463)	Microsoft ACPI-Compliant System
	(ISA) 0x000001D0 (464)	Microsoft ACPI-Compliant System
	(ISA) 0x000001D1 (465)	Microsoft ACPI-Compliant System
	(ISA) 0x000001D2 (466)	Microsoft ACPI-Compliant System
	(ISA) 0x000001D3 (467)	Microsoft ACPI-Compliant System
	(ISA) 0x000001D4 (468)	Microsoft ACPI-Compliant System
	(ISA) 0x000001D5 (469)	Microsoft ACPI-Compliant System
	(ISA) 0x000001D6 (470)	Microsoft ACPI-Compliant System
	(ISA) 0x000001D7 (471)	Microsoft ACPI-Compliant System
	(ISA) 0x000001D8 (472)	Microsoft ACPI-Compliant System
	(ISA) 0x000001D9 (473)	Microsoft ACPI-Compliant System
	(ISA) 0x000001DA (474)	Microsoft ACPI-Compliant System
	(ISA) 0x000001DB (475)	Microsoft ACPI-Compliant System
	(ISA) 0x000001DC (476)	Microsoft ACPI-Compliant System
	(ISA) 0x000001DD (477)	Microsoft ACPI-Compliant System
	(ISA) 0x000001DE (478)	Microsoft ACPI-Compliant System
	(ISA) 0x000001DF (479)	Microsoft ACPI-Compliant System
	(ISA) 0x000001E0 (480)	Microsoft ACPI-Compliant System
	(ISA) 0x000001E1 (481)	Microsoft ACPI-Compliant System
	(ISA) 0x000001E2 (482)	Microsoft ACPI-Compliant System
	(ISA) 0x000001E3 (483)	Microsoft ACPI-Compliant System
	(ISA) 0x000001E4 (484)	Microsoft ACPI-Compliant System
	(ISA) 0x000001E5 (485)	Microsoft ACPI-Compliant System
	(ISA) 0x000001E6 (486)	Microsoft ACPI-Compliant System
	(ISA) 0x000001E7 (487)	Microsoft ACPI-Compliant System
	(ISA) 0x000001E8 (488)	Microsoft ACPI-Compliant System
	(ISA) 0x000001E9 (489)	Microsoft ACPI-Compliant System
	(ISA) 0x000001EA (490)	Microsoft ACPI-Compliant System
	(ISA) 0x000001EB (491)	Microsoft ACPI-Compliant System
	(ISA) 0x000001EC (492)	Microsoft ACPI-Compliant System
	(ISA) 0x000001ED (493)	Microsoft ACPI-Compliant System
	(ISA) 0x000001EE (494)	Microsoft ACPI-Compliant System
	(ISA) 0x000001EF (495)	Microsoft ACPI-Compliant System

	(ISA) 0x000001ED (493)	Microsoft ACPI-Compliant System
	(ISA) 0x000001EE (494)	Microsoft ACPI-Compliant System
	(ISA) 0x000001EF (495)	Microsoft ACPI-Compliant System
	(ISA) 0x000001F0 (496)	Microsoft ACPI-Compliant System
	(ISA) 0x000001F1 (497)	Microsoft ACPI-Compliant System
	(ISA) 0x000001F2 (498)	Microsoft ACPI-Compliant System
	(ISA) 0x000001F3 (499)	Microsoft ACPI-Compliant System
	(ISA) 0x000001F4 (500)	Microsoft ACPI-Compliant System
	(ISA) 0x000001F5 (501)	Microsoft ACPI-Compliant System
	(ISA) 0x000001F6 (502)	Microsoft ACPI-Compliant System
	(ISA) 0x000001F7 (503)	Microsoft ACPI-Compliant System
	(ISA) 0x000001F8 (504)	Microsoft ACPI-Compliant System
	(ISA) 0x000001F9 (505)	Microsoft ACPI-Compliant System
	(ISA) 0x000001FA (506)	Microsoft ACPI-Compliant System
	(ISA) 0x000001FB (507)	Microsoft ACPI-Compliant System
	(ISA) 0x000001FC (508)	Microsoft ACPI-Compliant System
	(ISA) 0x000001FD (509)	Microsoft ACPI-Compliant System
	(ISA) 0x000001FE (510)	Microsoft ACPI-Compliant System
	(ISA) 0x000001FF (511)	Microsoft ACPI-Compliant System
	(PCI) 0x00000005 (05)	Mobile 6th Generation Intel(R) Processor Family I/O SMBUS - 9D23
	(PCI) 0x00000006 (06)	Mobile 6th Generation Intel(R) Processor Family I/O Thermal subsystem - 9D31
	(PCI) 0x00000010 (16)	High Definition Audio Controller
	(PCI) 0xFFFFFFF4 (-12)	Intel(R) Management Engine Interface
	(PCI) 0xFFFFFFF5 (-11)	Intel(R) USB 3.0 eXtensible Host Controller - 1.0 (Microsoft)
	(PCI) 0xFFFFFFF6 (-10)	Intel(R) HD Graphics 520
	(PCI) 0xFFFFFFF7 (-9)	Intel(R) I210 Gigabit Network Connection
	(PCI) 0xFFFFFFF8 (-8)	Intel(R) I210 Gigabit Network Connection
	(PCI) 0xFFFFFFF9 (-7)	Intel(R) I210 Gigabit Network Connection
	(PCI) 0xFFFFFFFA (-6)	Intel(R) I210 Gigabit Network Connection
	(PCI) 0xFFFFFFFB (-5)	Intel(R) I210 Gigabit Network Connection
	(PCI) 0xFFFFFFF4 (-4)	Intel(R) I210 Gigabit Network Connection
	(PCI) 0xFFFFFFF5 (-3)	Standard SATA AHCI Controller
	(PCI) 0xFFFFFFF6 (-2)	Mobile 6th Generation Intel(R) Processor Family I/O PCI Express Root Port #1 - 9D10
> 	Memory	

Appendix C

CANBus Utility (for CANBus Module)

C.1 CANBus Driver Installation

Before using the utility, please follow the instructions below to install the drivers.

For Windows 8.1

1. Locate the CANBus in Device Manager

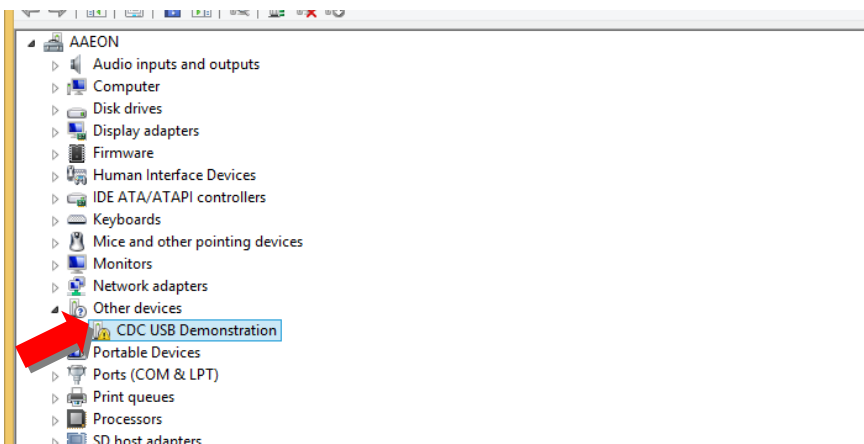

2. Right click and select Update driver

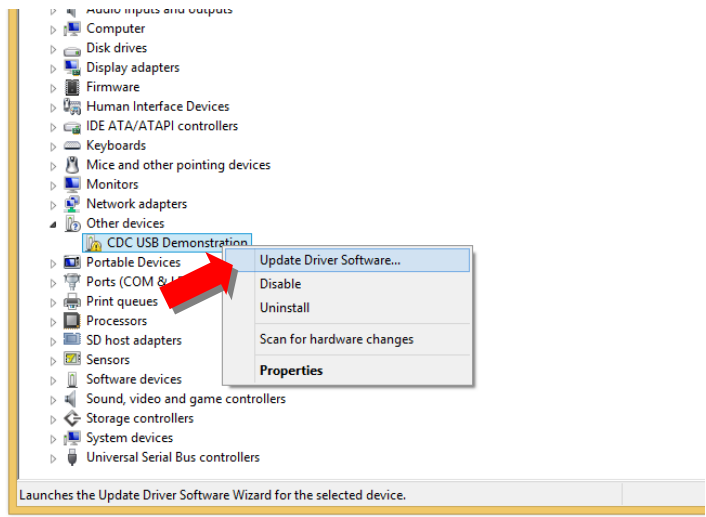

3. Choose **Browse my computer for driver software** and **Next**

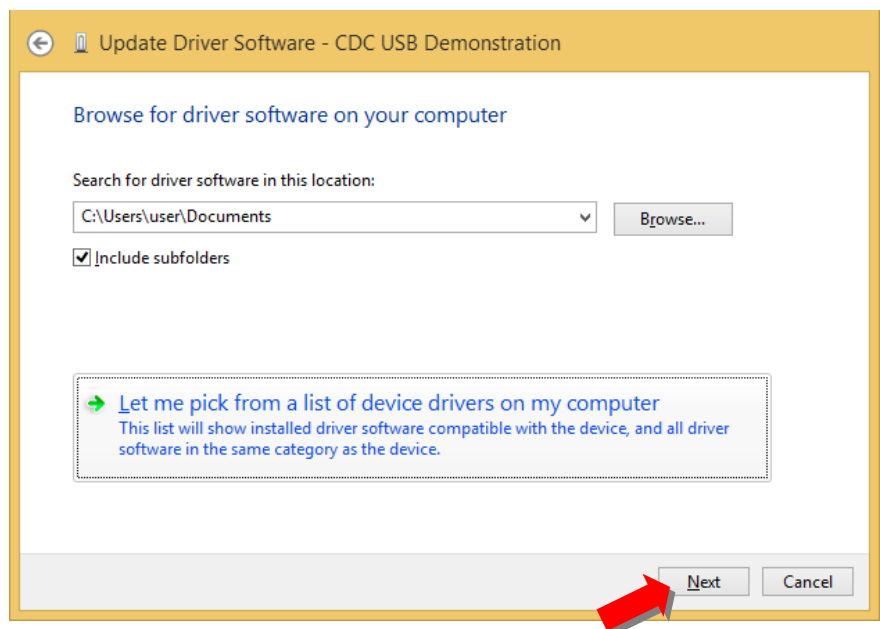

4. Click **Have Disk** and **browse to the driver's directory**

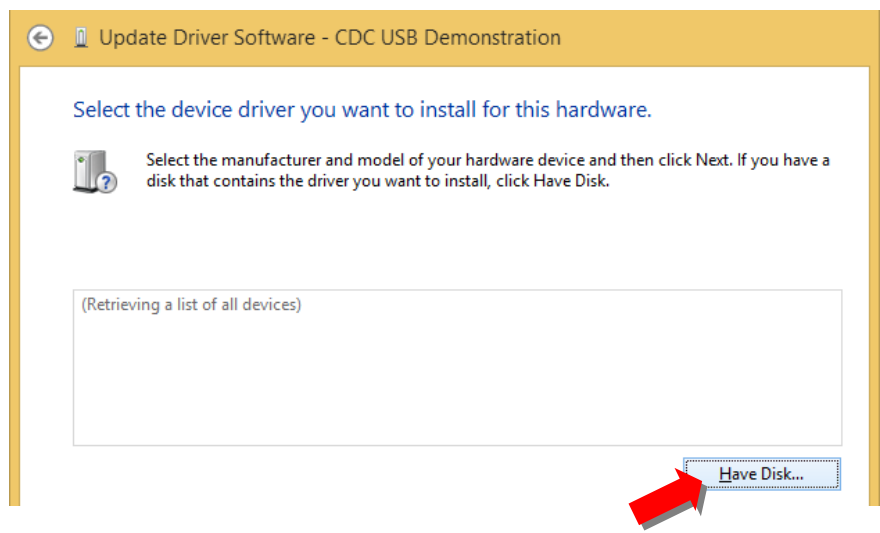

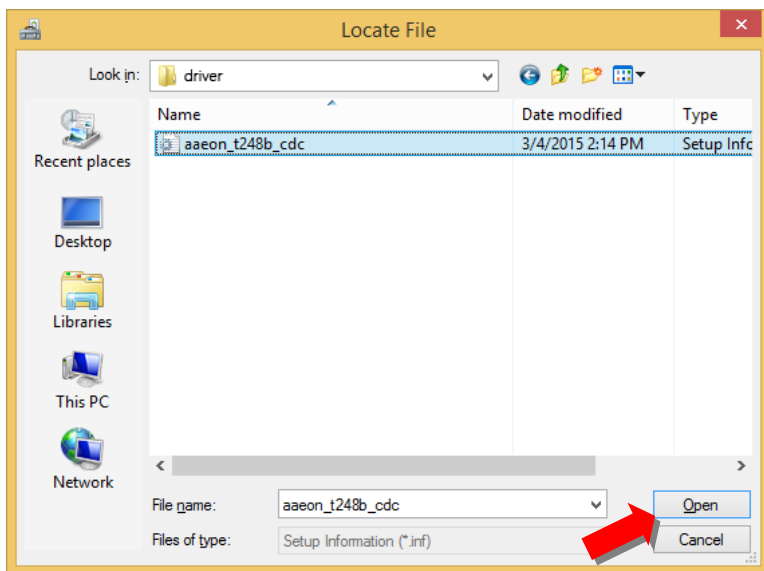

5. After selecting the directory, click **next** and **install the drivers**

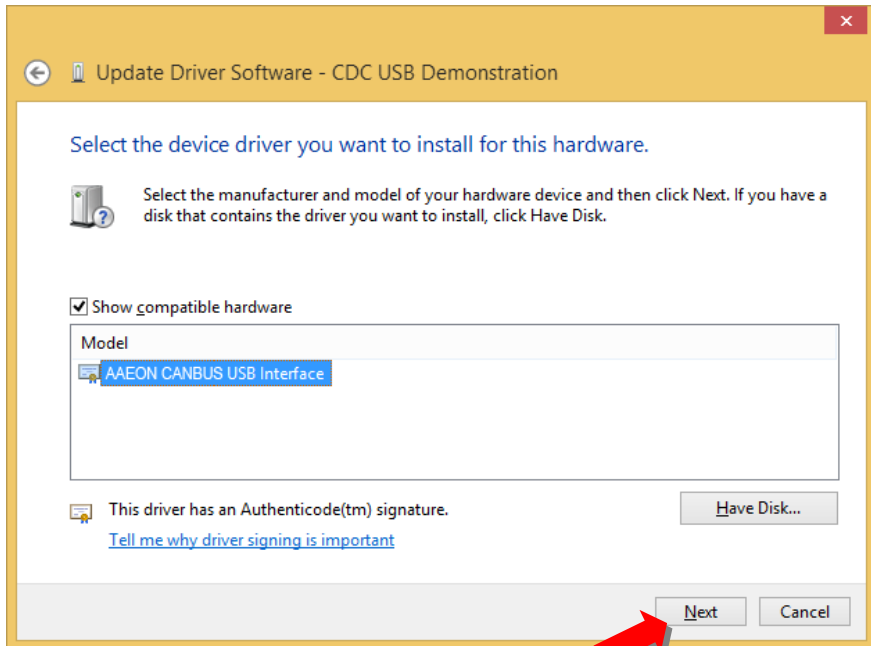

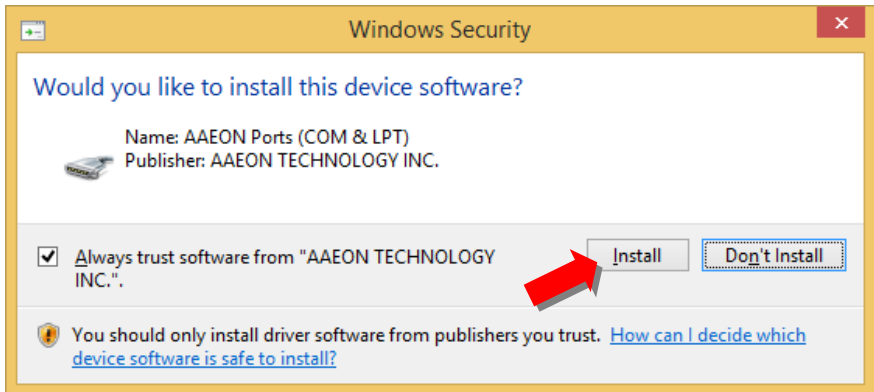

6. You should see this after the driver is successfully installed.

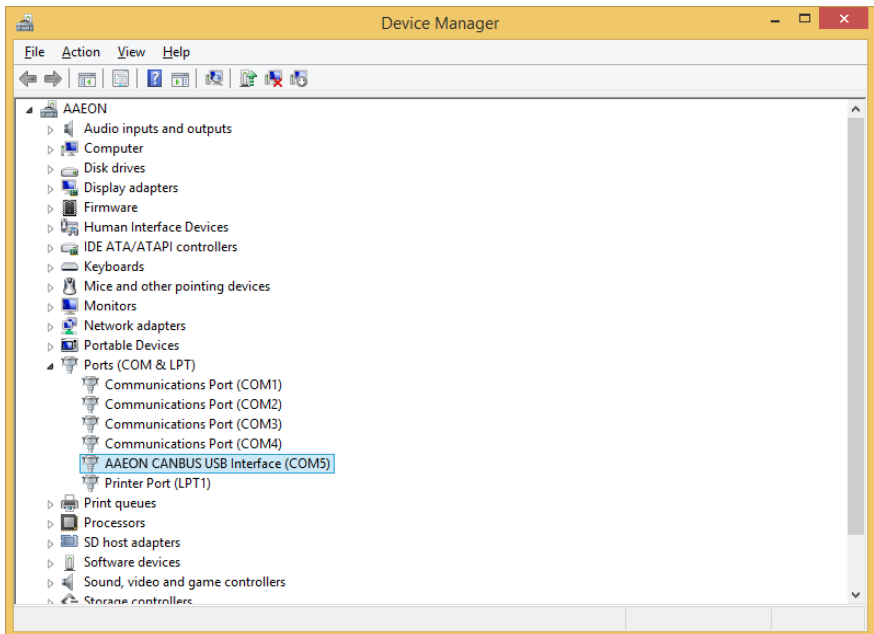

C.2 CANBus Utility



1. COM PORT NUMBER
2. COM PORT BAUD RATE:
 - i. 115200
 - ii. 57600
 - iii. 38400
 - iv. 19200
 - v. 9600
3. CONNECTION BUTTON
4. FIRMWARE VERSION
5. CAN BUS PORT SELECTOR: 0 OR 1
6. CAN BUS BAUD RATE (PRESS SET TO APPLY CHANGE):
 - i. 125K

- ii. 500K
 - iii. 1M
7. CAN BUS MODE: STANDARD OR EXTENDED (PRESS SET BUTTON TO APPLY CHANGE)
 - i. STANDARD: ID RANGE WILL BE 0x000~0x7FF
 - ii. EXTENDED: ID RANGE WILL BE 0x00000000~0x1FFFFFFF
 8. ENABLE/ DISABLE RTR MODE (PRESS SET BUTTON TO APPLY CHANGE):

IF RTR IS ENABLED, A REMOTE FRAME WILL BE TRANSMITTED VIA THE BUS. THIS MEANS THAT NO DATA BYTES ARE INCLUDED WITHIN THIS FRAME. NEVERTHELESS, IT IS NECESSARY TO SPECIFY THE CORRECT DATA LENGTH CODE WHICH DEPENDS ON THE CORRESPONDING DATA FRAME WITH THE SAME IDENTIFIER CODING. IF THE RTR IS DISABLED, A DATA FRAME WILL BE SENT INCLUDING THE NUMBER OF DATA BYTES AS SPECIFIED BY THE DATA LENGTH CODE.
 9. CAN BUS ID: THE IDENTIFIER IS TRANSMITTED FIRST ON THE BUS DURING THE ARBITRATION PROCESS. THE IDENTIFIER ACTS AS THE MESSAGE'S NAME.
 10. DATA FIELD: DATA TO BE TRANSMITTED.
 11. RECEIVED DATA WILL BE LISTED HERE
 12. COUNTER INCREASED WHEN RECEIVING DATA
 13. SEND BUTTON
 14. LOOP TEST FUNCTION: PRESS THIS BUTTON TO SEND DATA AUTOMATICALLY.
 15. RECEIVE BUTTON: PRESS TO START RECEIVING DATA.
 16. CLEAR RECEIVE FIELD
 17. MASK AND FILTER FUNCTION, PLEASE REFER TO NEXT SESSION.
 18. GET STATUS FROM FIRMWARE REGISTER
 19. GET ERROR STATUS FROM FIRMWARE REGISTER
 20. LOAD DEFAULT
 21. SAVE CURRENT SETTING TO FIRMWARE REGISTER

C.3 Mask and Filter Function

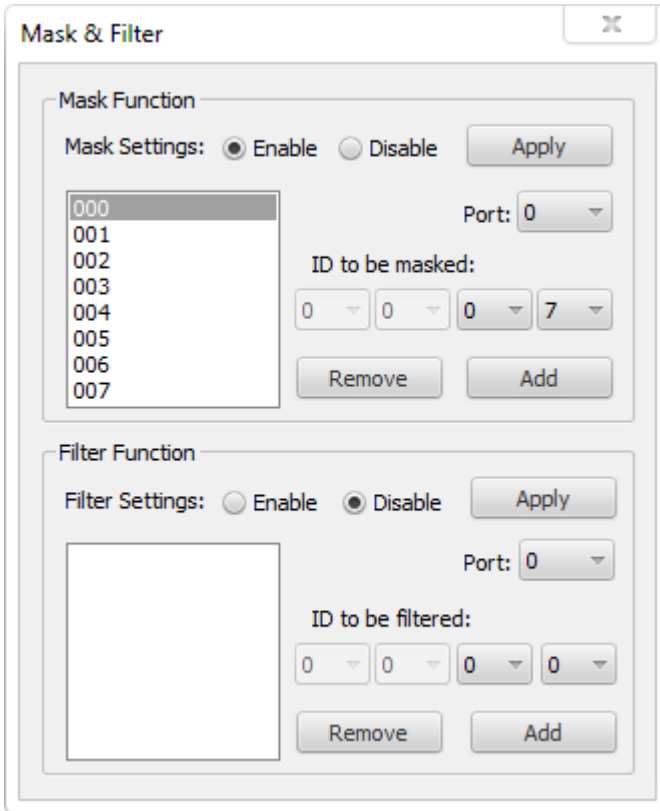

1. MASK: SPECIFIED ID CANNOT BE RECEIVED.
2. FILTER: ONLY SPECIFIED ID CANNOT BE RECEIVED.
3. WORKS ON PORT THAT APPLY TO RECEIVE PORT

Appendix D

Electrical Specifications for I/O Ports

D.1 Digital I/O Register

Table 1 : SuperIO relative register table

	Default Value	Note
Index	0x2E(Note1)	SIO MB PnP Mode Index Register 0x2E or 0x4E
Data	0x2F(Note2)	SIO MB PnP Mode Data Register 0x2F or 0x4F

Table 2 : Digital Input relative register table

	LDN	Register	BitNum	Value	Note
DIO-1 Pin Status	0x06(Note3)	0xA2 (Note4)	0(Note5)		GPIO50
DIO-2 Pin Status	0x06(Note6)	0xA2 (Note7)	1(Note8)		GPIO51
DIO-3 Pin Status	0x06(Note9)	0xA2 (Note10)	2(Note11)		GPIO52
DIO-4 Pin Status	0x06(Note12)	0xA2 (Note13)	3(Note14)		GPIO53
DIO-5 Pin Status	0x06(Note15)	0xA2 (Note16)	4(Note17)		GPIO54
DIO-6 Pin Status	0x06(Note18)	0xA2 (Note19)	5(Note20)		GPIO55
DIO-7 Pin Status	0x06(Note21)	0xA2 (Note22)	6(Note23)		GPIO56
DIO-8 Pin Status	0x06(Note24)	0xA2 (Note25)	7(Note26)		GPIO57

Table 3 : Digital Output relative register table

	LDN	Register	BitNum	Value	Note
DIO-1 Output Data	0x06(Note27)	0xA1 (Note28)	0(Note29)	(Note30)	GPIO50
DIO-2 Output Data	0x06(Note31)	0xA1 (Note32)	1(Note33)	(Note34)	GPIO51
DIO-3 Output Data	0x06(Note35)	0xA1 (Note36)	2(Note37)	(Note38)	GPIO52
DIO-4 Output Data	0x06(Note39)	0xA1 (Note40)	3(Note41)	(Note42)	GPIO53
DIO-5 Output Data	0x06(Note43)	0xA1 (Note44)	4(Note45)	(Note46)	GPIO54
DIO-6 Output Data	0x06(Note47)	0xA1 (Note48)	5(Note49)	(Note50)	GPIO55
DIO-7 Output Data	0x06(Note51)	0xA1 (Note52)	6(Note53)	(Note54)	GPIO56
DIO-8 Output Data	0x06(Note55)	0xA1 (Note56)	7(Note57)	(Note58)	GPIO57

D.2 Digital I/O Sample Program

```
*****
// SuperIO relative definition (Please reference to Table 1)
#define byte  SIOIndex //This parameter is represented from Note1
#define byte  SIOData //This parameter is represented from Note2
#define void   IOWriteByte(byte IOPort, byte Value);
#define byte   IOReadByte(byte IOPort);
// Digital Input Status relative definition (Please reference to Table 2)
#define byte   DInput1LDN // This parameter is represented from Note3
#define byte   DInput1Reg // This parameter is represented from Note4
#define byte   DInput1Bit // This parameter is represented from Note5
#define byte   DInput2LDN // This parameter is represented from Note6
#define byte   DInput2Reg // This parameter is represented from Note7
#define byte   DInput2Bit // This parameter is represented from Note8
#define byte   DInput3LDN // This parameter is represented from Note9
#define byte   DInput3Reg // This parameter is represented from Note10
#define byte   DInput3Bit // This parameter is represented from Note11
#define byte   DInput4LDN // This parameter is represented from Note12
#define byte   DInput4Reg // This parameter is represented from Note13
#define byte   DInput4Bit // This parameter is represented from Note14
#define byte   DInput5LDN // This parameter is represented from Note15
#define byte   DInput5Reg // This parameter is represented from Note16
#define byte   DInput5Bit // This parameter is represented from Note17
#define byte   DInput6LDN // This parameter is represented from Note18
#define byte   DInput6Reg // This parameter is represented from Note19
#define byte   DInput6Bit // This parameter is represented from Note20
#define byte   DInput7LDN // This parameter is represented from Note21
#define byte   DInput7Reg // This parameter is represented from Note22
#define byte   DInput7Bit // This parameter is represented from Note23
#define byte   DInput8LDN // This parameter is represented from Note24
#define byte   DInput8Reg // This parameter is represented from Note25
#define byte   DInput8Bit // This parameter is represented from Note26
*****
```

```

*****
// Digital Output control relative definition (Please reference to Table 3)
#define byte   DOutput1LDN // This parameter is represented from Note27
#define byte   DOutput1Reg // This parameter is represented from Note28
#define byte   DOutput1Bit // This parameter is represented from Note29
#define byte   DOutput1Val // This parameter is represented from Note30
#define byte   DOutput2LDN // This parameter is represented from Note31
#define byte   DOutput2Reg // This parameter is represented from Note32
#define byte   DOutput2Bit // This parameter is represented from Note33
#define byte   DOutput2Val // This parameter is represented from Note34
#define byte   DOutput3LDN // This parameter is represented from Note35
#define byte   DOutput3Reg // This parameter is represented from Note36
#define byte   DOutput3Bit // This parameter is represented from Note37
#define byte   DOutput3Val // This parameter is represented from Note38
#define byte   DOutput4LDN // This parameter is represented from Note39
#define byte   DOutput4Reg // This parameter is represented from Note40
#define byte   DOutput4Bit // This parameter is represented from Note41
#define byte   DOutput4Val // This parameter is represented from Note42
#define byte   DOutput5LDN // This parameter is represented from Note43
#define byte   DOutput5Reg // This parameter is represented from Note44
#define byte   DOutput5Bit // This parameter is represented from Note45
#define byte   DOutput5Val // This parameter is represented from Note46
#define byte   DOutput6LDN // This parameter is represented from Note47
#define byte   DOutput6Reg // This parameter is represented from Note48
#define byte   DOutput6Bit // This parameter is represented from Note49
#define byte   DOutput6Val // This parameter is represented from Note50
#define byte   DOutput7LDN // This parameter is represented from Note51
#define byte   DOutput7Reg // This parameter is represented from Note52
#define byte   DOutput7Bit // This parameter is represented from Note53
#define byte   DOutput7Val // This parameter is represented from Note54
#define byte   DOutput8LDN // This parameter is represented from Note55
#define byte   DOutput8Reg // This parameter is represented from Note56
#define byte   DOutput8Bit // This parameter is represented from Note57
#define byte   DOutput8Val // This parameter is represented from Note58
*****

```



```
*****
VOID Main(){
    Boolean PinStatus ;

    // Procedure : AaeonReadPinStatus
    // Input :
    //     Example, Read Digital I/O Pin 3 status
    // Output :
    //     InputStatus :
    //         0: Digital I/O Pin level is low
    //         1: Digital I/O Pin level is High
    PinStatus = AaeonReadPinStatus(DInput3LDN, DInput3Reg, DInput3Bit);

    // Procedure : AaeonSetOutputLevel
    // Input :
    //     Example, Set Digital I/O Pin 6 level
    AaeonSetOutputLevel(DOutput6LDN, DOutput6Reg, DOutput6Bit, DOutput6Val);
}
*****
```

```
*****
Boolean  AeonReadPinStatus(byte LDN, byte Register, byte BitNum){
    Boolean PinStatus ;

    PinStatus = SIOBitRead(LDN, Register, BitNum);
    Return PinStatus ;
}
VOID  AeonSetOutputLevel(byte LDN, byte Register, byte BitNum, byte Value){
    ConfigToOutputMode(LDN, Register, BitNum);
    SIOBitSet(LDN, Register, BitNum, Value);
}
*****
```

```

*****
VOID  SIOEnterMBPnPMode(){
    IOWriteByte(SIOIndex, 0x87);
    IOWriteByte(SIOIndex, 0x87);
}

VOID  SIOExitMBPnPMode(){
    IOWriteByte(SIOIndex, 0xAA);
}

VOID  SIOSelectLDN(byte LDN){
    IOWriteByte(SIOIndex, 0x07); // SIO LDN Register Offset = 0x07
    IOWriteByte(SIOData, LDN);
}

VOID  SIOBitSet(byte LDN, byte Register, byte BitNum, byte Value){
    Byte TmpValue;

    SIOEnterMBPnPMode();
    SIOSelectLDN(byte LDN);
    IOWriteByte(SIOIndex, Register);
    TmpValue = IOReadByte(SIOData);
    TmpValue &= ~(1 << BitNum);
    TmpValue |= (Value << BitNum);
    IOWriteByte(SIOData, TmpValue);
    SIOExitMBPnPMode();
}

VOID  SIOByteSet(byte LDN, byte Register, byte Value){
    SIOEnterMBPnPMode();
    SIOSelectLDN(LDN);
    IOWriteByte(SIOIndex, Register);
    IOWriteByte(SIOData, Value);
    SIOExitMBPnPMode();
}
*****

```

```
*****
Boolean SIOBitRead(byte LDN, byte Register, byte BitNum){
    Byte TmpValue;

    SIOEnterMBPnPMode();
    SIOSelectLDN(LDN);
    IOWriteByte(SIOIndex, Register);
    TmpValue = IOReadByte(SIOData);
    TmpValue &= (1 << BitNum);
    SIOExitMBPnPMode();
    If(TmpValue == 0)
        Return 0;
    Return 1;
}
VOID ConfigToOutputMode(byte LDN, byte Register, byte BitNum){
    Byte TmpValue, OutputEnableReg;

    OutputEnableReg = Register-1;
    SIOEnterMBPnPMode();
    SIOSelectLDN(LDN);
    IOWriteByte(SIOIndex, OutputEnableReg);
    TmpValue = IOReadByte(SIOData);
    TmpValue |= (1 << BitNum);
    IOWriteByte(SIOData, OutputEnableReg);
    SIOExitMBPnPMode();
}
*****
```