

UP Net Plus

Maker Board
UPCP-CR-NPL4-A10-001
UPCP-CR-NPL4-A10-002

User's Manual 2nd Ed

Copyright Notice

This document is copyrighted, 2019. All rights are reserved. The original manufacturer reserves the right to make improvements to the products described in this manual at any time without notice.

No part of this manual may be reproduced, copied, translated, or transmitted in any form or by any means without the prior written permission of the original manufacturer. Information provided in this manual is intended to be accurate and reliable. However, the original manufacturer assumes no responsibility for its use, or for any infringements upon the rights of third parties that may result from its use.

The material in this document is for product information only and is subject to change without notice. While reasonable efforts have been made in the preparation of this document to assure its accuracy, AAEMON assumes no liabilities resulting from errors or omissions in this document, or from the use of the information contained herein.

AAEMON reserves the right to make changes in the product design without notice to its users.

Acknowledgement

All other products' name or trademarks are properties of their respective owners.

- Microsoft Windows is a registered trademark of Microsoft Corp.
- Intel, Pentium, Celeron, and Xeon are registered trademarks of Intel Corporation
- Core, Atom are trademarks of Intel Corporation
- ITE is a trademark of Integrated Technology Express, Inc.
- IBM, PC/AT, PS/2, and VGA are trademarks of International Business Machines Corporation.

All other product names or trademarks are properties of their respective owners.

Packing List

Before setting up your product, please make sure the following items have been shipped:

Item	Quantity
● UP Net Plus	1
● Adapter Board I	1
● Adapter Board II	1
● Standoff	12

If any of these items are missing or damaged, please contact your distributor or sales representative immediately.

About this Document

This User's Manual contains all the essential information, such as detailed descriptions and explanations on the product's hardware and software features (if any), its specifications, dimensions, jumper/connector settings/definitions, and driver installation instructions (if any), to facilitate users in setting up their product.

Users may refer to the product page on AAEON.com for the latest version of this document.

Safety Precautions

Please read the following safety instructions carefully. It is advised that you keep this manual for future references

1. All cautions and warnings on the device should be noted.
2. Make sure the power source matches the power rating of the device.
3. Position the power cord so that people cannot step on it. Do not place anything over the power cord.
4. Always completely disconnect the power before working on the system's hardware.
5. No connections should be made when the system is powered as a sudden rush of power may damage sensitive electronic components.
6. If the device is not to be used for a long time, disconnect it from the power supply to avoid damage by transient over-voltage.
7. Always disconnect this device from any AC supply before cleaning.
8. While cleaning, use a damp cloth instead of liquid or spray detergents.
9. Make sure the device is installed near a power outlet and is easily accessible.
10. Keep this device away from humidity.
11. Place the device on a solid surface during installation to prevent falls
12. Do not cover the openings on the device to ensure optimal heat dissipation.
13. Watch out for high temperatures when the system is running.
14. Do not touch the heat sink or heat spreader when the system is running
15. Never pour any liquid into the openings. This could cause fire or electric shock.
16. As most electronic components are sensitive to static electrical charge, be sure to ground yourself to prevent static charge when installing the internal components. Use a grounding wrist strap and contain all electronic components in any static-shielded containers.

17. If any of the following situations arises, please the contact our service personnel:
 - i. Damaged power cord or plug
 - ii. Liquid intrusion to the device
 - iii. Exposure to moisture
 - iv. Device is not working as expected or in a manner as described in this manual
 - v. The device is dropped or damaged
 - vi. Any obvious signs of damage displayed on the device
18. **DO NOT LEAVE THIS DEVICE IN AN UNCONTROLLED ENVIRONMENT WITH TEMPERATURES BEYOND THE DEVICE'S PERMITTED STORAGE TEMPERATURES (SEE CHAPTER 1) TO PREVENT DAMAGE.**

FCC Statement

This equipment has been tested and found to comply with the limits for a Class B digital device, pursuant to part 15 of the FCC Rules. These limits are designed to provide reasonable protection against harmful interference in a residential installation. This equipment generates, uses and can radiate radio frequency energy and, if not installed and used in accordance with the instructions, may cause harmful interference to radio communications. However, there is no guarantee that interference will not occur in a particular installation. If this equipment does cause harmful interference to radio or television reception, which can be determined by turning the equipment off and on, the user is encouraged to try to correct the interference by one or more of the following measures:

- Reorient or relocate the receiving antenna.
 - Increase the separation between the equipment and receiver.
 - Connect the equipment into an outlet on a circuit different from that to which the receiver is connected.
 - Consult the dealer or an experienced radio/TV technician for help.
-
- Any changes or modifications not expressly approved by the party responsible for compliance could void the authority to operate equipment.
 - This device and its antenna must not be co-located or operating in conjunction with any other antenna or transmitter.
 - End-users and installers must be provided with antenna installation instructions and transmitter operating conditions for satisfying RF exposure compliance.

This equipment complies with FCC radiation exposure limits set forth for an uncontrolled environment. This equipment should be installed and operated with minimum distance 20cm between the radiator & your body.

This device complies with Part 15 of FCC rules. Operation is subject to the following two conditions: (1) this device may not cause harmful interference and (2) this device must accept any interference received, including interference that may cause undesired operation.

China RoHS Requirements (CN)

产品中有毒有害物质或元素名称及含量

AAEON Main Board/ Daughter Board/ Backplane

部件名称	有毒有害物质或元素					
	铅 (Pb)	汞 (Hg)	镉 (Cd)	六价铬 (Cr(VI))	多溴联苯 (PBB)	多溴二苯醚 (PBDE)
印刷电路板 及其电子组件	○	○	○	○	○	○
外部信号 连接器及线材	○	○	○	○	○	○

O: 表示该有毒有害物质在该部件所有均质材料中的含量均在 SJ/T 11363-2006 标准规定的限量要求以下。

X: 表示该有毒有害物质至少在该部件的某一均质材料中的含量超出 SJ/T 11363-2006 标准规定的限量要求。

备注: 此产品所标示之环保使用期限, 系指在一般正常使用状况下。

China RoHS Requirement (EN)

Poisonous or Hazardous Substances or Elements in Products

AAEON Main Board/ Daughter Board/ Backplane

Component	Poisonous or Hazardous Substances or Elements					
	Lead (Pb)	Mercury (Hg)	Cadmium (Cd)	Hexavalent Chromium (Cr(VI))	Polybrominated Biphenyls (PBB)	Polybrominated Diphenyl Ethers (PBDE)
PCB & Other Components	○	○	○	○	○	○
Wires & Connectors for External Connections	○	○	○	○	○	○
<p>O: The quantity of poisonous or hazardous substances or elements found in each of the component's parts is below the SJ/T 11363-2006-stipulated requirement.</p> <p>X: The quantity of poisonous or hazardous substances or elements found in at least one of the component's parts is beyond the SJ/T 11363-2006-stipulated requirement.</p> <p>Note: The Environment Friendly Use Period as labeled on this product is applicable under normal usage only</p>						

Table of Contents

Chapter 1 - Product Specifications	1
1.1 Specifications	2
Chapter 2 – Hardware Information	4
2.1 Dimensions	5
2.2 Jumpers and Connectors.....	6
2.3 List of Switches and Connectors.....	7
2.3.1 SIM Card (SIM1).....	8
2.3.2 Docking I (CN1)	8
2.3.3 USB 3.0 (CN2).....	11
2.3.4 Mini PCIe (CN3).....	11
2.3.5 Docking II (CN4).....	13
2.3.6 SATA Port (CN5)	15
2.3.7 SATA Power (CN6).....	16
2.3.8 I2C (CN8).....	16
Chapter 3 – Drivers Installation	17
3.1 Driver Download and Installation.....	18

Chapter 1

Product Specifications

1.1 Specifications

System

Ethernet	Intel I211-AT x 4 (A10-001) Intel I210-IT for wide temperature x 4 (A10-002)
EEPROM	EEPROM on I2C0 4Kb with Jumper for A0~A2 address x 1
Power Requirement	12V5A
Power Supply Type	12VDC from M/B
Power Consumption (Typical)	Max 10W
Dimensions (L x W)	90 x 56 mm
Operating Temperature	0 ~ 60°C (32 ~ 140°F)
Operation Humidity	10 ~ 80% relative humidity, non-condensing
Certification	CE/FCC Class B
OS Support	Microsoft Windows 10 Linux: ubilinux, Ubuntu, Yocto Android 9.0

I/O

Ethernet	001: 4 x Intel I211-AT 002: 4 x Intel I210-IT for wide temperature
USB	USB 3.0 Type A x 1
SATA	SATA x 1 (vertical)
Expansion Slot	mPCIe Slot (Full Size) x 1 (SATA/USB/PCIE) SIM Card Slot x 1 DOCKING I DOCKING II

Chapter 2

Hardware Information

2.1 Dimensions

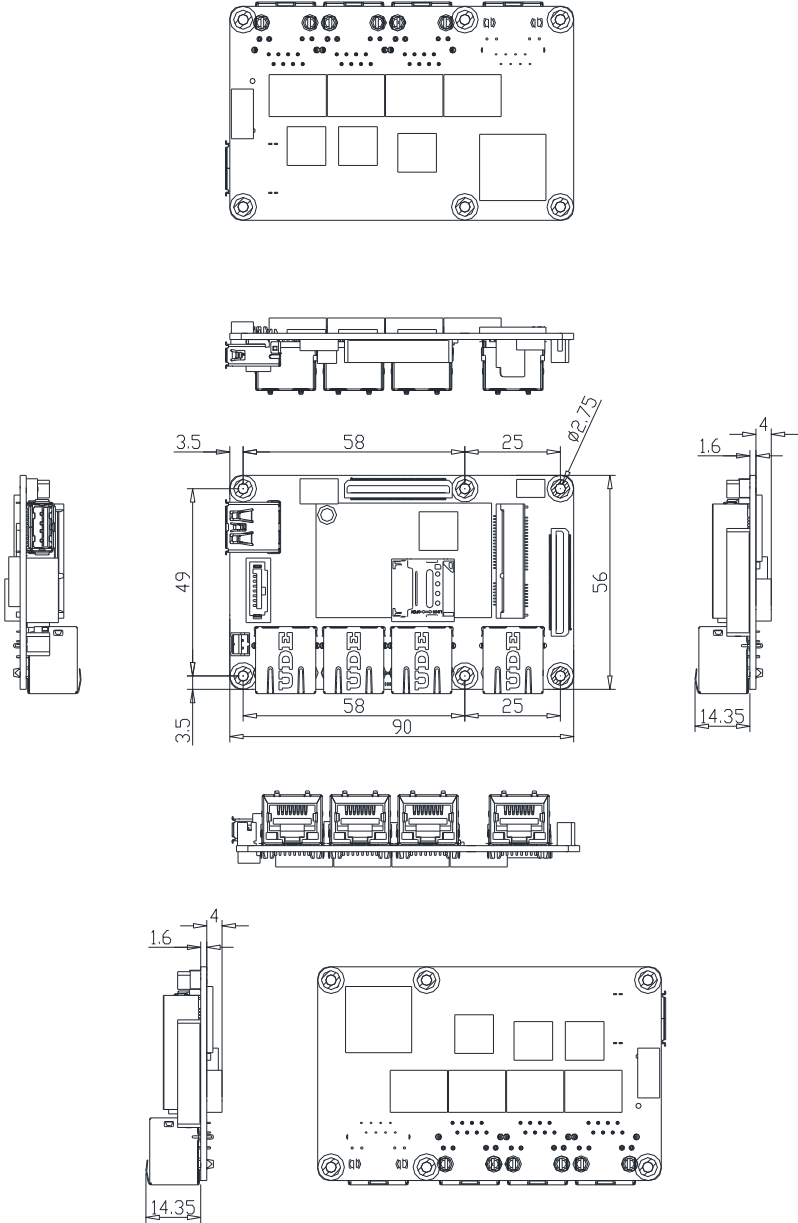

2.2 Jumpers and Connectors

Top side

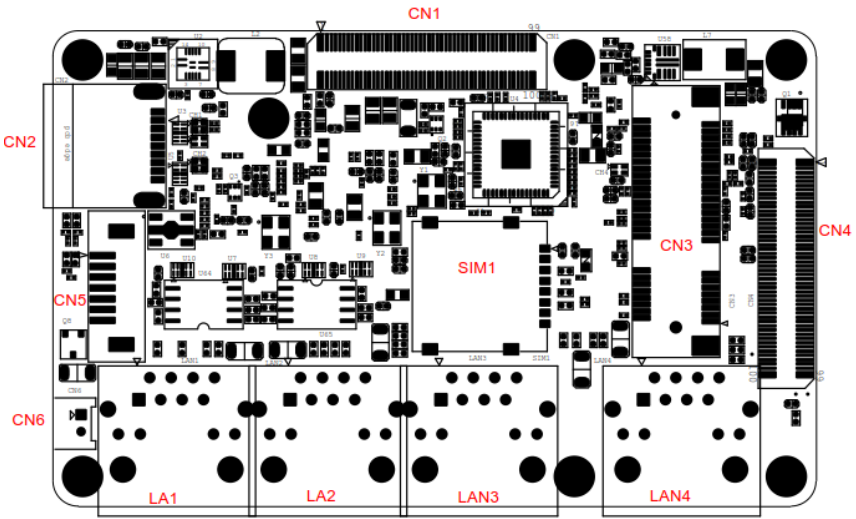

Bottom side

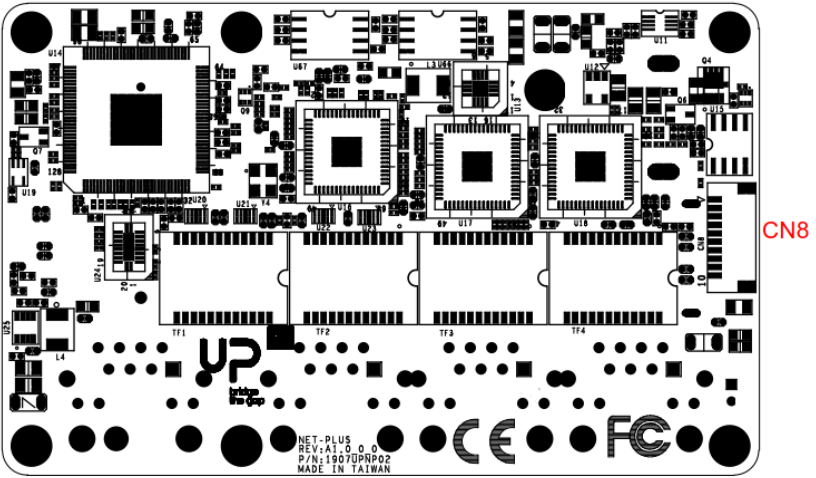

2.3 List of Switches and Connectors

Please refer to the table below for all of the board's jumpers that you can configure for your application

Reference	Function	Connector Type
SIM1	SIM CARD	(TF)Micro SIM Socket.8PSMD.Hinge Type.REGO.80440GIH-081T-12CL
CN1	DOCKING I	(TF)Board-Board Connector.100P180D(F).SMD.Pitch=0.5mm.H=6.05mm. Panasonic.AXK5S00347YG
CN2	USB3.0	(TF)USB3.0 Connector.Single Port.Type A.9P90D(F).SMD.Trontek.930-00406-A91-22
CN3	MINI PCIE	(TF)MiniCard SLOT.52P90D.(F).SMD.FOXCONN.AS0B226-S68Q-7H
CN4	DOCKING II	(TF)Board-Board Connector.100P180D(F).SMD.Pitch=0.5mm.H=6.05mm. Panasonic.AXK5S00347YG
CN5	SATA PORT	(TF)SATA CONNECTOR.7P.180D(M).SMT.TechBest.007-01-00757
CN6	SATA POWER	(TF)WAFER BOX.2P.180D(M).DIP.2.0mm.w/LOCK.PINREX.721-81-02 TW00
CN8	I2C	(TF)Wafer Box.10P90D(M).SMD.1.0mm.PINREX.710-74-10TWR6

2.3.1 SIM Card (SIM1)

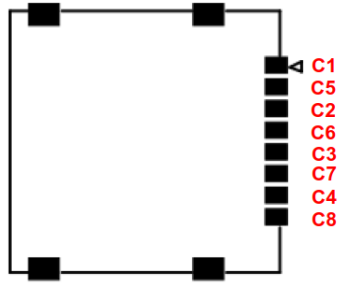

Pin	Signal	Pin	Signal
C1	P_UIM_PWRF	C5	GND_UIM
C2	P_UIM_RSTC	C6	P_UIM_VPPC
C3	P_UIM_CLKC	C7	P_UIM_DATC
C4	NC	C8	NC

2.3.2 Docking I (CN1)

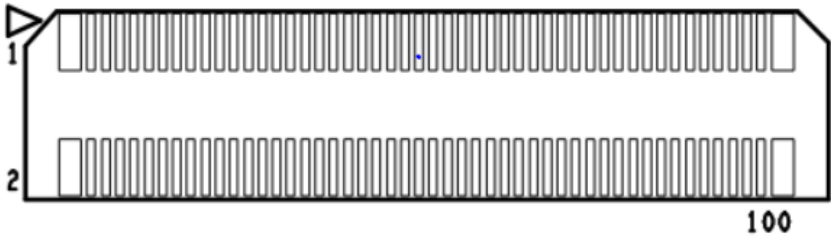

Pin	Signal Description	Pin	Signal Description
1	+V5A_CON	2	+V5A_CON
3	+V5A_CON	4	+V5A_CON
5	+V5A_CON	6	+V5A_CON
7	+V5A_CON	8	+V5A_CON
9	GND	10	GND

Pin	Signal Description	Pin	Signal Description
11	PMU_PLT_RST#	12	NC
13	NC	14	NC
15	PM_SLP_S3#_3P3	16	NC
17	PCIE_CLKREQ3#	18	NC
19	NC	20	GND
21	GND	22	NC
23	NC	24	NC
25	NC	26	NC
27	NC	28	NC
29	NC	30	NC
31	NC	32	NC
33	GND	34	NC
35	LPC_R_AD0	36	NC
37	LPC_R_AD1	38	NC
39	LPC_R_AD2	40	NC
41	LPC_R_AD3	42	NC
43	GND	44	NC
45	NC	46	NC
47	NC	48	NC
49	NC	50	GND
51	NC	52	NC
53	GND	54	NC
55	NC	56	GND
57	NC	58	NC
59	GND	60	NC
61	NC	62	GND

Pin	Signal Description	Pin	Signal Description
63	NC	64	NC
65	GND	66	NC
67	NC	68	GND
69	NC	70	NC
71	GND	72	GND
73	I2C_SDA0	74	NC
75	I2C_SCL0	76	NC
77	GND	78	NC
79	NC	80	NC
81	NC	82	NC
83	GND	84	NC
85	NC	86	ISH_GPIO_13
87	NC	88	ISH_GPIO_14
89	GND	90	NC
91	LPC_FRAME_R	92	NC
93	LPC_R_CLKOUT0	94	GND
95	NC	96	NC
97	INT_SERIRQ_R	98	NC
99	NC	100	NC

2.3.3 USB 3.0 (CN2)

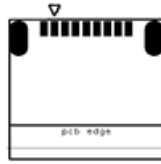

Pin	Signal	Pin	Signal
1	+5V	2	USB2_C_DN2
3	USB2_C_DP2	4	GND
5	USB3_RXN_CON_P2	6	USB3_RXP_CON_P2
7	GND	8	USB3_TXN_CON_P2
9	USB3_TXP_CON_P2		

2.3.4 Mini PCIe (CN3)

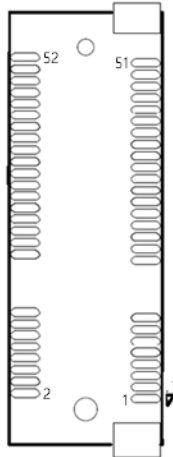

Pin	Signal	Pin	Signal
1	WAKE_MINI_N	2	+V3.3A
3	NC	4	GND
5	NC	6	+V1.5S

Pin	Signal	Pin	Signal
7	NC	8	P_UIM_PWR
9	GND	10	P_UIM_DAT
11	CLK_PCIE_MINICARD_N	12	P_UIM_CLK
13	CLK_PCIE_MINICARD_P	14	P_UIM_RST
15	GND	16	P_UIM_VPP
17	NC	18	GND
19	NC	20	3GPW_EN
21	GND	22	PLTRST
23	PERn0_mSATA_R+	24	+V3.3A
25	PERn0_mSATA_R-	26	GND
27	GND	28	+V1.5S
29	GND	30	NC
31	PETn0_mSATA_T-	32	NC
33	PETp0_mSATA_T+	34	GND
35	GND	36	USB2_DN3
37	GND	38	USB2_DP3
39	+V3.3A	40	GND
41	+V3.3A	42	NC
43	mSATA_PCl_e_SEL_C	44	NC
45	NC	46	NC
47	NC	48	+V1.5S
49	NC	50	GND
51	NC	52	+V3.3A

2.3.5 Docking II (CN4)

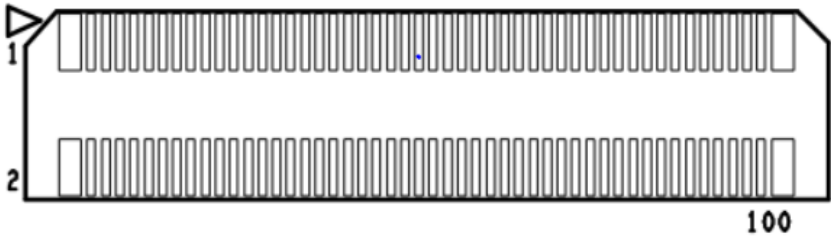

Pin	Signal	Pin	Signal
1	+12V	2	+12V
3	+12V	4	+12V
5	+12V	6	+12V
7	+12V	8	+12V
9	NC	10	NC
11	NC	12	GND
13	NC	14	NC
15	NC	16	NC
17	GND	18	GND
19	NC	20	NC
21	NC	22	NC
23	GND	24	GND
25	NC	26	NC
27	NC	28	NC
29	GND	30	GND
31	PCIE_REFCLK0_P	32	PCIE_REFCLK1_P
33	PCIE_REFCLK0_N	34	PCIE_REFCLK1_N
35	GND	36	GND
37	PCIE_RXP0	38	PCIE_RXP1
39	PCIE_RXN0	40	PCIE_RXN1

Pin	Signal	Pin	Signal
41	GND	42	GND
43	PCIE_TXP0	44	PCIE_TXP1
45	PCIE_TXN0	46	PCIE_TXN1
47	GND	48	GND
49	PCIE_REFCLK2_P	50	PCIE_P3_USB3_P4_TXP
51	PCIE_REFCLK2_N	52	PCIE_P3_USB3_P4_TXN
53	GND	54	GND
55	PCIE_TXP2	56	PCIE_P3_USB3_P4_RXP
57	PCIE_TXN2	58	PCIE_P3_USB3_P4_RXN
59	GND	60	GND
61	PCIE_RXP2	62	SATA_P1_USB3_P5_RXN
63	PCIE_RXN2	64	SATA_P1_USB3_P5_RXP
65	GND	66	GND
67	NC	68	SATA_P1_USB3_P5_TXN
69	NC	70	SATA_P1_USB3_P5_TXP
71	GND	72	GND
73	NC	74	SATA_RXN0
75	NC	76	SATA_RXP0
77	GND	78	GND
79	USB2_DP3	80	SATA_TXP0
81	USB2_DN3	82	SATA_TXN0
83	GND	84	GND
85	USB2_DP4	86	NC
87	USB2_DN4	88	NC
89	GND	90	GND
91	NC	92	SATA_LED_N
93	NC	94	NC

Pin	Signal	Pin	Signal
95	PCIE_WAKE0_N	96	PCIE_CLKREQ0#
97	PCIE_WAKE1_N	98	PCIE_CLKREQ1#
99	PCIE_WAKE2_N	100	PCIE_CLKREQ2#

2.3.6 SATA Port (CN5)

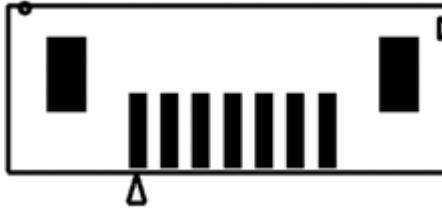

Pin	Signal	Pin	Signal
1	GND	2	SATA_TXP0
3	SATA_TXN0	4	GND
5	SATA_RXN0	6	SATA_RXP0
7	GND		

2.3.7 SATA Power (CN6)



Pin	Signal
1	+V5S
2	GND

2.3.8 I2C (CN8)



Pin	Signal	Pin	Signal
1	NC	2	I2C_SCL0
3	I2C_SDA0	4	GND
5	PM_SLP_S3#_3P3	6	PCIE_CLKREQ3#
7	NC	8	ISH_GPIO_13
9	ISH_GPIO_14	10	NC

Chapter 3

Drivers Installation

3.1 Driver Download and Installation

**Please access <https://www.up-community.org> and go to the Downloads section to find the relevant driver.*