

MIX-TLUD1

Industrial Motherboard

E22524

Revised Edition v2

August 2023

Copyright Notice

This document is copyrighted, 2023. All rights are reserved. The original manufacturer reserves the right to make improvements to the products described in this manual at any time without notice.

No part of this manual may be reproduced, copied, translated, or transmitted in any form or by any means without the prior written permission of the original manufacturer. Information provided in this manual is intended to be accurate and reliable. However, the original manufacturer assumes no responsibility for its use, or for any infringements upon the rights of third parties that may result from its use. The material in this document is for product information only and is subject to change without notice. While reasonable efforts have been made in the preparation of this document to assure its accuracy, the original manufacturer assumes no liabilities resulting from errors or omissions in this document, or from the use of the information contained herein.

The original manufacturer reserves the right to make changes in the product design without notice to its users.

Acknowledgments

All other products' name or trademarks are properties of their respective owners.

- AMI is a trademark of American Megatrends Inc.
- Intel®, Core™ are trademarks of Intel® Corporation.
- Microsoft Windows® is a registered trademark of Microsoft Corp.
- IBM, PC/AT, PS/2, and VGA are trademarks of International Business Machines Corporation.

The original manufacturer reserves the right to make changes in the product design without notice to its users.

All other product names or trademarks are properties of their respective owners.

Contents

Chapter 1	Product overview	
1.1	Package contents.....	1-1
1.2	Features	1-1
1.3	Specifications.....	1-2
Chapter 2	Motherboard information	
2.1	Before you proceed	2-1
2.2	Motherboard layout.....	2-1
2.3	Screw size.....	2-4
	2.3.1 Component side.....	2-4
	2.3.2 Solder side	2-5
2.4	Central Processing Unit (CPU)	2-6
2.5	System memory	2-7
2.6	Jumpers	2-8
2.7	Connectors	2-14
	2.7.1 Rear panel connectors.....	2-14
	2.7.2 Internal connectors	2-16
Chapter 3	BIOS Setup	
3.1	BIOS Setup	3-1
3.2	Main menu	3-2
	3.2.1 System Date [Day MM/DD/YYYY]	3-2
	3.2.2 System Time [HH:MM:SS].....	3-2
3.3	Advanced menu	3-2
	3.3.1 CPU Configuration	3-2
	3.3.2 Trusted Computing	3-3
	3.3.3 SATA Configuration	3-4
	3.3.4 USB Configuration	3-4
	3.3.5 Hardware Monitor	3-5
	3.3.6 SIO Configuration	3-5
	3.3.7 AMT Configuration	3-6
	3.3.8 PCH-FW Configuration	3-6
	3.3.9 NVMe Configuration.....	3-6
	3.3.10 Power Management.....	3-6
	3.3.11 Digital IO Port Configuration	3-7

3.4	Chipset menu	3-7
3.4.1	System Agent (SA) Configuration	3-7
3.4.2	PCH-IO Configuration	3-8
3.5	Security menu	3-8
3.5.1	Administrator Password	3-8
3.5.2	User Password	3-8
3.5.3	Secure Boot	3-9
3.6	Boot menu	3-10
3.6.1	Boot Configuration	3-10
3.6.2	Boot Option Priorities	3-10
3.7	Save & Exit menu	3-11
3.7.1	Save Options	3-11
3.7.2	Default Options	3-11
Appendix		
	Notices	A-1

Chapter 1

Product overview

1.1 Package contents

Check your industrial motherboard package for the following items.

- 1 x Industrial Motherboard
- 1 x SATA 6.0Gb/s cable
- 1 x SATA power cable
- 1 x I/O Shield



If any of the above items is damaged or missing, contact your distributor or sales representative immediately.

1.2 Features

- Intel® 11th Generation 10nm Tiger Lake-UP3 processor
- 2 x SO-DIMMs, max. 64GB, DDR4 3200 MHz, non-ECC, memory
- 1 x SATA 6.0 Gb/s, 2 x USB 3.2 Gen 2, 4 x USB 2.0
- Realtek® ALC897-VA2-CG High Definition Audio CODEC
- Multi-display outputs: 2 x HDMI 2.0, 2 x DisplayPort
- Dual Ethernet LAN: 1 x Intel® PCIe Gb LAN 219LM; 1 x Intel® PCIe Gb LAN 225LM
- 1 x PCIe [x4] slot
- 1 x M.2 M Key (22 x 80mm) for NVMe (PCIe x4, Gen3) storage devices; 1 x mini-PCIE (PCIE/SATA; Half/Full-size)

1.3 Specifications

SYSTEM	
CPU	10nm 11 th Generation Intel® Tiger Lake-UP3, 28W TDPs
Memory	2 x SO-DIMMs, max. 32GB, DDR4 3200 MHz, non-ECC memory Dual channel memory architecture
Graphics	Intel® Iris® Xe Graphics for Core™ i7 & Core™ i5 Intel® UHD Graphics for Core™ i3 & Celeron®
I/O Chipset	IT5121E
Storage	1 x M.2 M key (2280mm) for NVMe (PCIe4; Gen3) storage 1 x SATA 6.0Gb/s port
Ethernet	1 x Intel® PCIe Gb LAN 219LM for vPro 1 x Intel® PCIe Gb LAN 225LM
Audio	Realtek® ALC897-VA2-CG
TPM	Nuvoton NPCT750ABCYX TPM2.0 onboard
Expansion slots	1 x mini-PCIE (PCIE/SATA; Half/Full-size) 1 x PCIe 3.0 [x4] slot
BIOS	256Mbit Flash ROM, AMI BIOS
H/W Status Monitor	Monitors CPU / system temperature Monitors Vcore / 3.3V / 5V / 12V voltages Monitors chassis fan speed
Watchdog Timer	1~255 steps by software program
Smart Fan Control	CPU fan / Chassis fan
Wake On LAN / PXE	Yes (WOL, PXE)
Power States	S3, S4, S5
Graphics	
Graphics Multi Display	4 independent display
HDMI	HDMI 2.0 up to 4096 x 2304 @60Hz
DisplayPort	up to 4096 x 2304 @60Hz
LVDS	Up to 1920 x 1200 @60Hz, Daul Channel 18/24 bit (via CH7511B)
eDP	UP to 4096 x 2304 @60Hz
Backlight Control	Voltage / PWM; Max 1A
Environment, Power, and ME	
Battery	Lithium battery
Power requirement	12(+/-5%) DC
Operating temperature	32°F~122°F (0°C~55°C)
Storage temperature	-40°F~185°F (-40°C~85°C)
Operating humidity	0%~90% relative humidity, non-condensing
Certificate	CE & FCC (Class A)
Form factor	Mini ITX Form Factor: 6.7" x 6.7" (170mm x 170mm)
Weight	1.1 lb (0.5 Kg)

(continued on the next page)

Internal I/O Connectors	
Storage	1 x M.2 M key (2280) for NVMe (PCIe x 4; Gen3) storage 1 x SATA 6.0Gb/s port 1 x 4-pin SATA power connector
USB	1 x USB 3.1 Gen 1 pin header supports additional 2 USB 3.1 Gen 1 ports (at mid-board)
Display	1 x 40-pin LVDS connector 1 x 40-pin eDP connector
Serial port	2 x Boxer headers for RS-232
DIO	8-bit Digital I/O interface (4-in / 4-out)
FAN	1 x 4-pin CPU fan header 1 x 4-pin Chassis fan header
Power	1 x 4-pin (2x2) DC-in 12 (-5%~+5%)
Others	1 x Clear CMOS jumper 1 x AT / ATX mode selection jumper 1 x SIM socket
Rear I/O Ports	
Rear I/O Ports	1 x DC Jack 2 x HDMI 2.0 ports 2 x DisplayPort++ 2 x USB 3.2 Gen 2 ports 4 x USB 2.0 ports 2 x LAN (RJ-45) ports 1 x Mic-In audio jack (pink) 1 x Line-Out audio jack (lime)
Others	
OS support	Windows® 10 64-bit Ubuntu 20.04.2 LTS
Accessories	1 x SATA cable 1 x SATA power cable 1 x I/O shield



Specifications are subject to change without notice.

Chapter 2

Motherboard information

2.1 Before you proceed

Take note of the following precautions before you install motherboard components or change any motherboard settings.



CAUTION!

- Unplug the power cord from the wall socket before touching any component.
 - Before handling components, use a grounded wrist strap or touch a safely grounded object or a metal object, such as the power supply case, to avoid damaging them due to static electricity.
 - Hold components by the edges to avoid touching the ICs on them.
 - Whenever you uninstall any component, place it on a grounded antistatic pad or in the bag that came with the component.
 - Before you install or remove any component, ensure that the ATX power supply is switched off or the power cord is detached from the power supply. Failure to do so may cause severe damage to the motherboard, peripherals, or components.
-

2.2 Motherboard layout



Place four screws into the holes indicated by circles to secure the motherboard to the chassis.



Do not overtighten the screws! Doing so can damage the motherboard.

Place this side towards the rear of the chassis

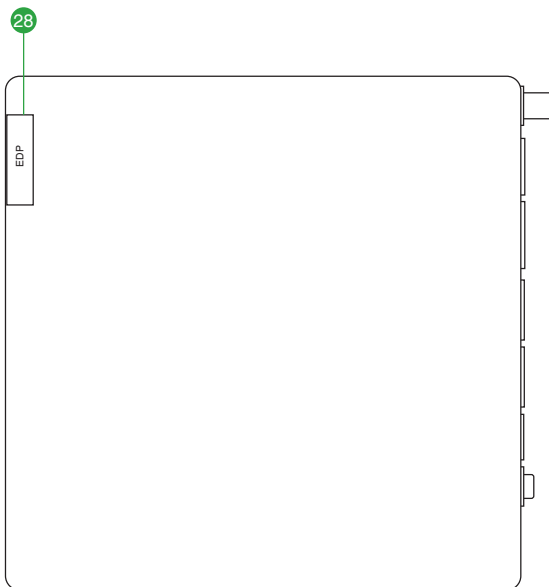
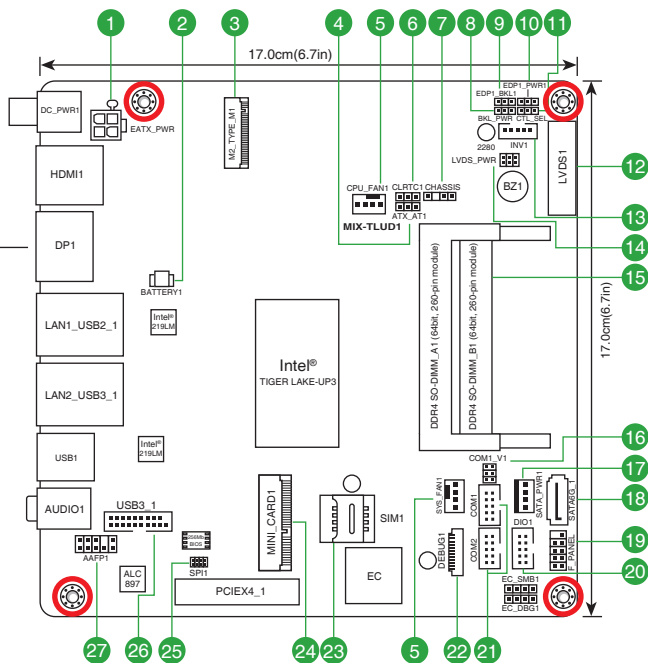

Connectors/Jumpers/Slots		Page
1.	12VDC connector (4-pin EATX_PWR2)	2-16
2.	Battery connector (2-pin BATTERY1)	2-16
3.	M.2 M Key slot	2-17
4.	ATX/AT mode selection jumper (3-pin ATX_AT1)	2-10
5.	CPU and chassis fan headers (4-pin CPU_FAN1, 4-pin SYS_FAN1)	2-17
6.	Clear RTC RAM (3-pin CLRTC1)	2-8
7.	Chassis intrusion jumper (4-1 pin CHASSIS)	2-9
8.	Inverter voltage selection jumper (3-pin BKL_PWR)	2-10
9.	EDP backlight selection jumper (3-pin EDP1_BKL1)	2-11
10.	EDP voltage selection jumper (3-pin EDP1_PWR1)	2-11
11.	Inverter backlight control mode selection jumper (3-pin CTL_SEL)	2-12
12.	LVDS connector (40-pin LVDS)	2-18
13.	Backlight inverter power connector (5-pin INV)	2-19
14.	LVDS panel voltage selection jumper (6-pin LVDS_PWR)	2-12
15.	DDR4 SO-DIMM slots	2-7
16.	COM1 Ring/+5V/+12V selection jumper (6-pin COM1_V1)	2-13
17.	SATA power header (SATA_PWR)	2-19
18.	SATA 6.0Gb/s port (7-pin SATA6G_1)	2-20
19.	System Panel header (10-1 pin F_PANEL)	2-21
20.	Digital I/O header (10-pin DIO1)	2-20
21.	COM Port headers (10-pin COM1~2)	2-22
22.	Debug Card connector	2-22
23.	SIM Card connector (8-pin SIM1)	2-23
24.	Mini PCIe x1 slot (MINI_CARD1)	2-23
25.	BIOS programmable connector (8-pin SPI1)	2-24
26.	USB 3.1 Gen 1 header (20-1 pin USB3_1)	2-24
27.	Front Panel Audio header (10-1 pin AAFP)	2-25
28.	Embedded DisplayPort connector (40-pin EDP)	2-26

2.3 Screw size

2.3.1 Component side

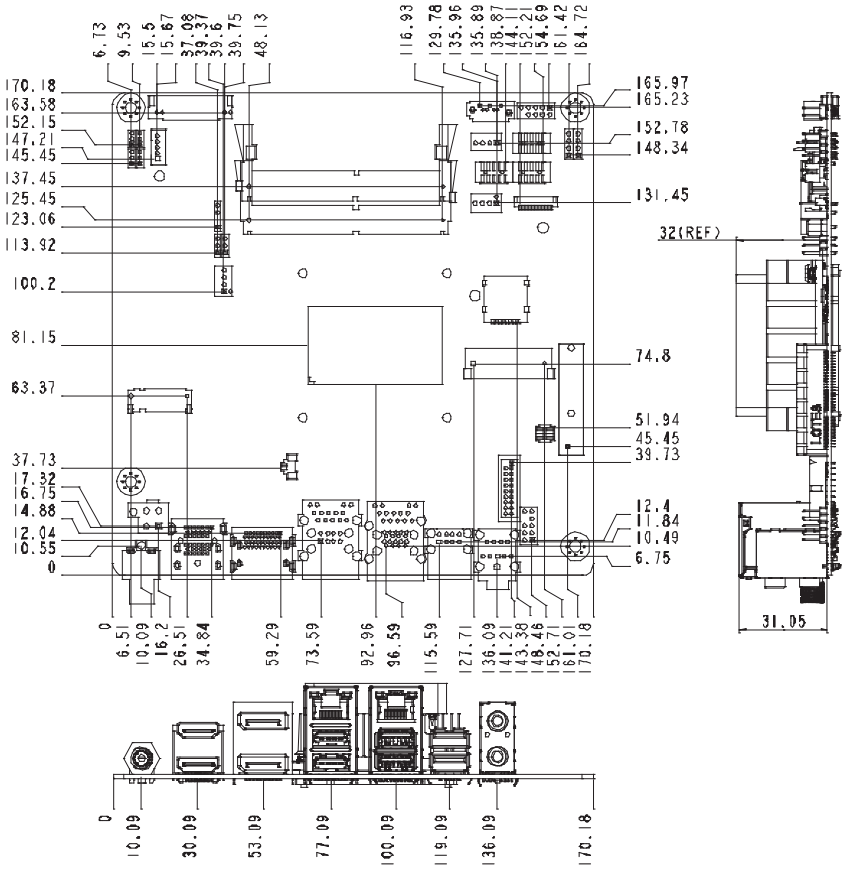

2.3.2 Solder side

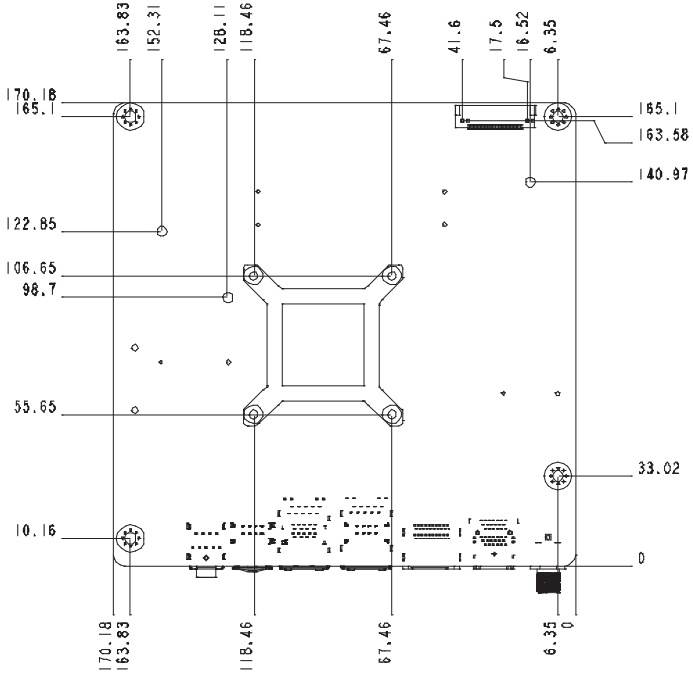

2.4 Central Processing Unit (CPU)

This motherboard comes with a 14nm 11th Generation Intel® Tiger Lake-UP3 processor.

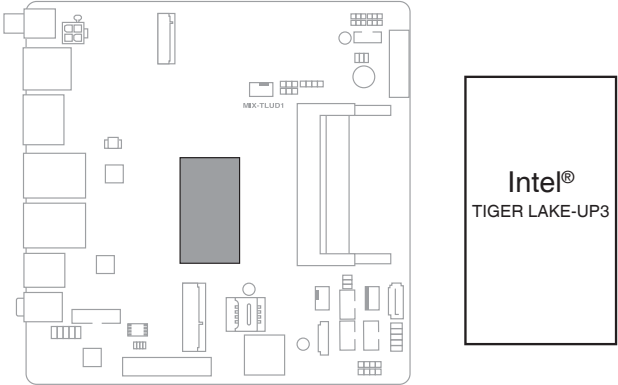

2.5 System memory

This motherboard comes with two Double Data Rate 4 (DDR4) Small Outline Dual Inline Memory Modules (SO-DIMM) sockets. The figure illustrates the location of the DDR4 SO-DIMM sockets:

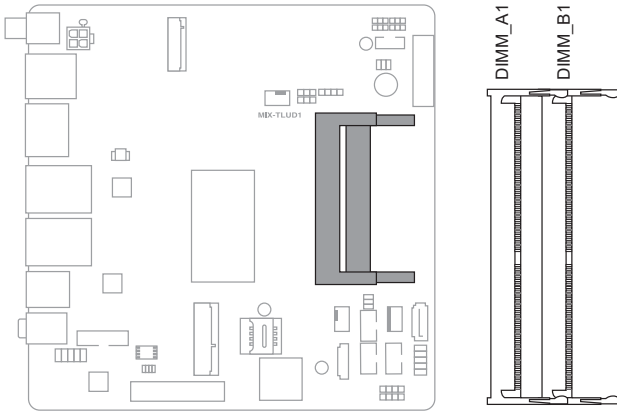

Use the DIMM_A1 slot when inserting only one SO-DIMM.

Installing a DIMM

To install a DIMM

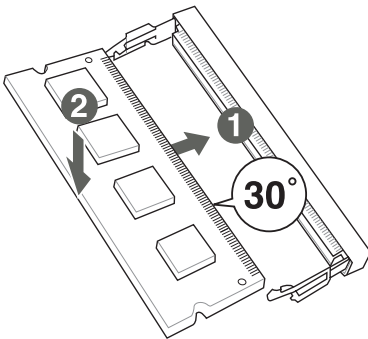

To remove a DIMM

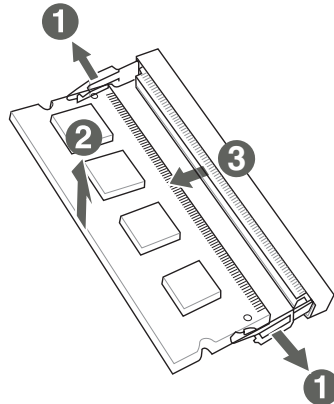

2.6 Jumpers

1. Clear RTC RAM (3-pin CLRTC)

This jumper allows you to clear the Real Time Clock (RTC) RAM in CMOS. You can clear the CMOS memory of system setup parameters by erasing the CMOS RTC RAM data. The onboard button cell battery powers the RAM data in CMOS, which include system setup information such as system passwords.

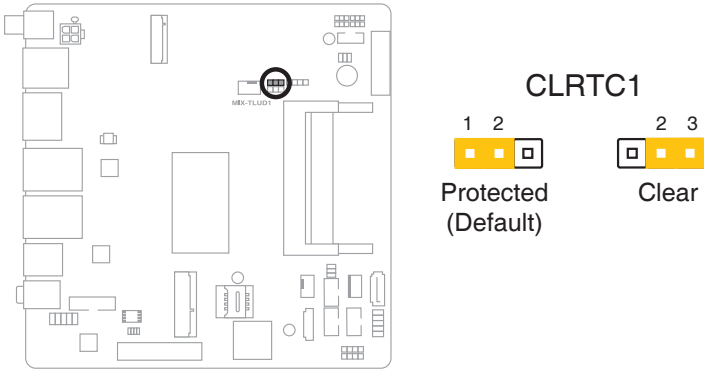

To erase the RTC RAM:

1. Turn OFF the computer and unplug the power cord.
2. Move the jumper cap from pins 1-2 (default) to pins 2-3. Keep the cap on pins 2-3 for about 5~10 seconds, then move the cap back to pins 1-2.
3. Plug the power cord and turn ON the computer.
4. Hold down the key during the boot process and enter BIOS setup to reenter data.



Except when clearing the RTC RAM, never remove the cap on CLRTC jumper default position. Removing the cap will cause system boot failure!



- If the steps above do not help, remove the onboard battery and move the jumper again to clear the CMOS RTC RAM data. After clearing the CMOS, reinstall the battery.
 - You do not need to clear the RTC when the system hangs due to overclocking. For system failure due to overclocking, use the CPU Parameter Recall (C.P.R) feature. Shut down and reboot the system so the BIOS can automatically reset parameter settings to default values.
-

2. Chassis intrusion jumper (4-1 pin CHASSIS)

This connector is for a chassis-mounted intrusion detection sensor or switch. Connect one end of the chassis intrusion sensor or switch cable to this connector. The chassis intrusion sensor or switch sends a high-level signal to this connector when a chassis component is removed or replaced. The signal is then generated as a chassis intrusion event.

Move the jumper cap to pins 1-2 when you intend to use the chassis intrusion detection feature.

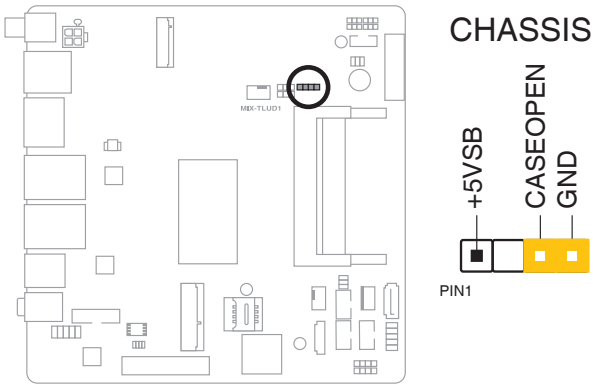

Pins	
1-2	Enables the chassis intrusion detection feature
3-4	Disables the chassis intrusion detection feature (Default)

3. AT/ATX mode selection (3-pin AT_ATX)

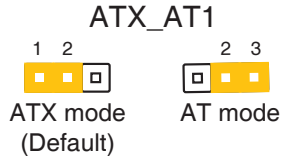
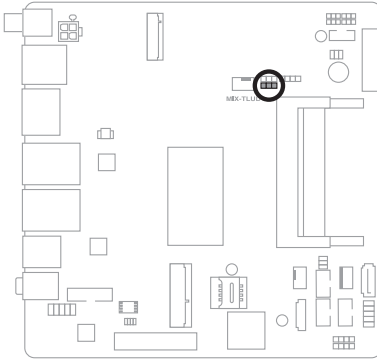

	Pins
ATX mode (Default)	1-2
AT mode	2-3

4. Inverter voltage selection (3-pin BKL_PWR)

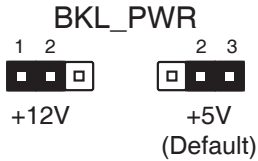
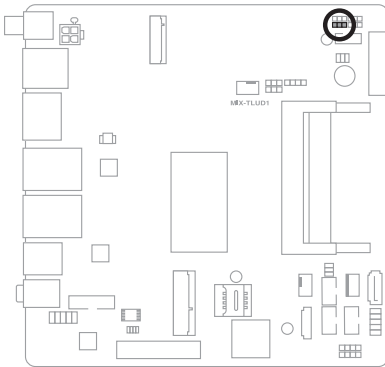

Setting	Pins
+12V	1-2
+5V (Default)	2-3

5. EDP backlight selection jumper (3-pin EDP1_BKL1)

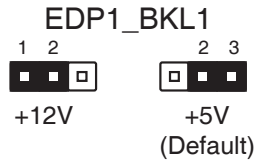
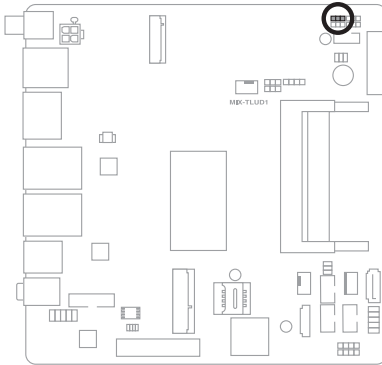

Setting	Pins
+12V	1-2
+5V (Default)	2-3

6. EDP voltage selection jumper (3-pin EDP1_PWR1)

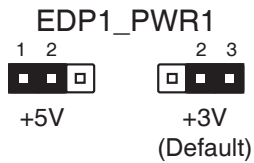
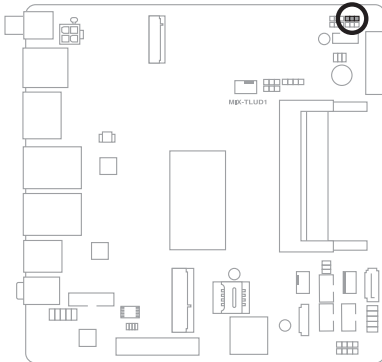

Setting	Pins
+5V	1-2
+3V (Default)	2-3

7. Inverter backlight control mode selection jumper (3-pin CTL_SEL)

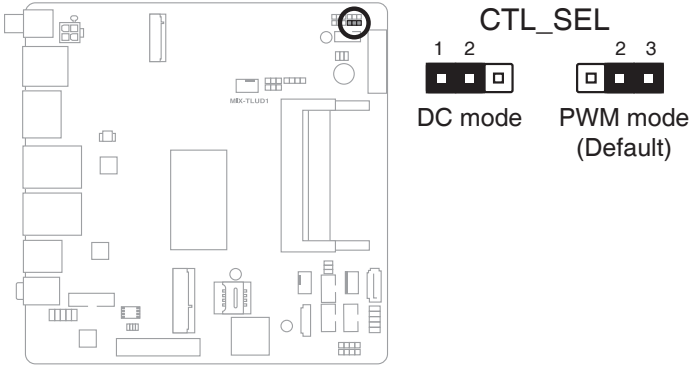

Setting	Pins
DC Voltage Control	1-2
PWM Control (Default)	2-3

8. LVDS panel voltage selection jumper (6-pin LVDS_PWR)

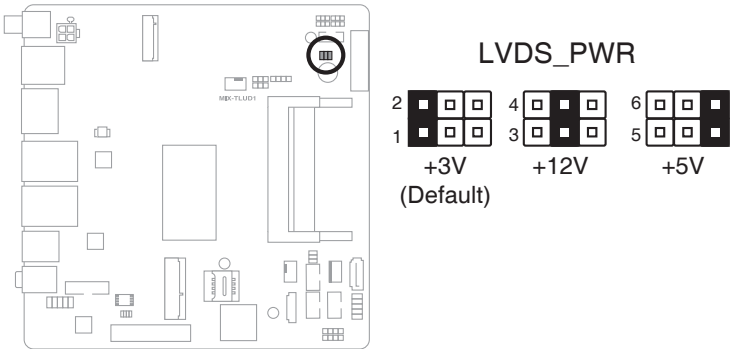

Setting	Pins
+3V (Default)	1-2
+12V	3-4
+5V	5-6

9. COM1 Ring/+5V/+12V selection jumper (6-pin COM1_V1)

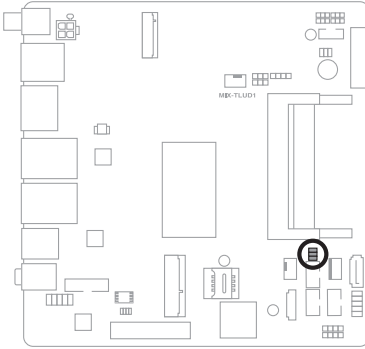

COM1_V1



2 1
+12V



4 3
+5V



6 5
Ring
(Default)

Setting	Pins
+12V	1-2
+5V	3-4
Ring (Default)	5-6

2.7 Connectors

2.7.1 Rear panel connectors

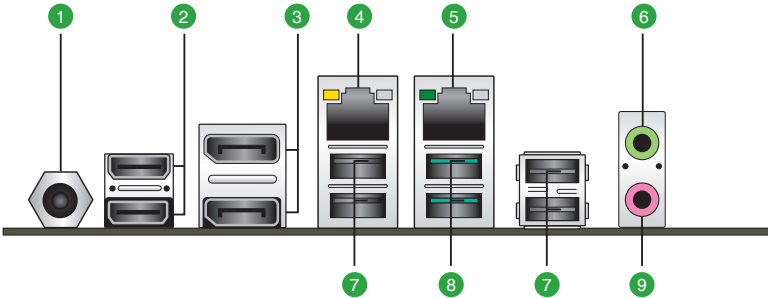

1. **DC power connector.** Insert the power adapter into this port.
2. **HDMI™ ports.** These ports are for High-Definition Multimedia Interface (HDMI™) connectors, and are HDCP compliant allowing playback of HD DVD, Blu-ray, and other protected content.
3. **DisplayPort.** This port is for a DisplayPort-compatible devices.
4. **LAN (RJ-45) ports.** These ports allow Gigabit connection to a Local Area Network (LAN) through a network hub. Refer to the table below for the LAN port LED indications.

LAN port LED indications

ACT/LINK LED		SPEED LED	
Status	Description	Status	Description
Off	No link	Green	1 Gbps connection
Yellow	Linked	Orange	100 Mbps connection
Blinking	Data activity	Off	10 Mbps connection

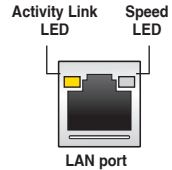

5. **2.5G Ethernet port.** This port allows 2.5Gbps Ethernet connection to a Local Area Network (LAN) through a network hub. Refer to the table below for the Ethernet port LED indications.

LAN port LED indications

ACT/LINK LED		SPEED LED	
Status	Description	Status	Description
-	-	Green	2.5 Gbps connection
Off	No link	Orange	1 Gbps connection
Green	Linked	Off	100 Mbps connection
Blinking	Data activity	Off	10 Mbps connection

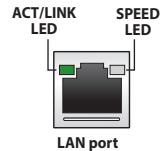

6. **Line Out port (lime).** This port connects to a headphone or a speaker.
7. **USB 2.0 ports.** These two 4-pin Universal Serial Bus (USB) ports are available for connecting USB 2.0/1.1 devices.



Before you install Windows® 7 operating system, go to BIOS Setup > Advanced > XHCI mode [Disabled], USB 2.0 (EHCI) support [Enabled], and set them back when you finish installing the operating system.

8. **USB 3.2 Gen 2 ports (Teal Blue, Type-A).** These 9-pin Universal Serial Bus (USB) ports connect to USB 3.2 Gen 2 devices.



We strongly recommend that you connect USB 3.2 Gen 2 devices to USB 3.2 Gen 2 ports for a faster and better performance from your USB 3.2 Gen 2 devices.

9. **Microphone port (pink).** This port connects to a microphone.

2.7.2 Internal connectors

1. ATX power connector (4-pin EATX_PWR)

This connector is for an ATX power supply plug. The power supply plug is designed to fit this connector in only one orientation. Find the proper orientation and push down firmly until the connector completely fits.

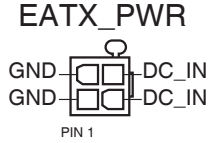
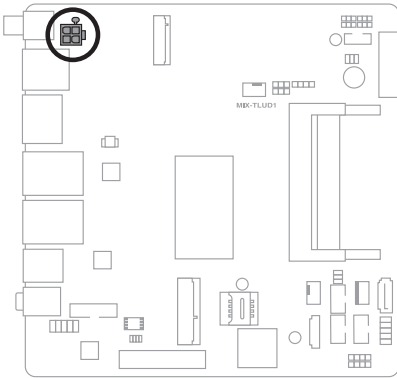

2. Battery connector (2-pin BATTERY)

This connector is for the lithium CMOS battery.

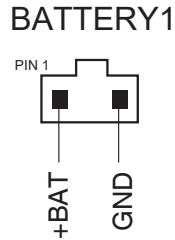
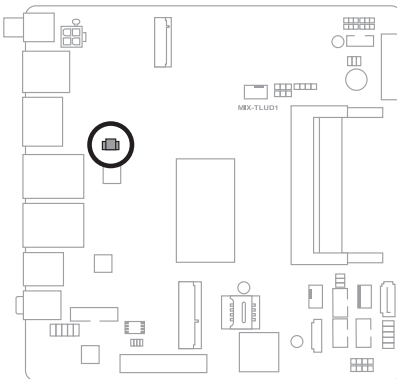

3. M.2 M Key slot

This slot allows you to install an M.2 (NGFF) module.

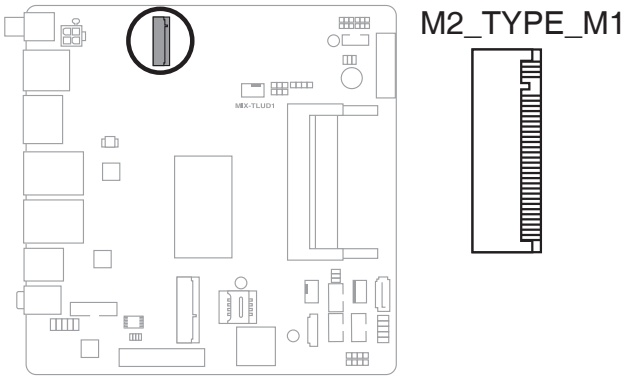

- The M.2 SSD module is purchased separately.
- The M.2 M Key slot supports type 2280 PCIe 3.0 x4 (Gen3) NVMe storage devices.

4. CPU and chassis fan headers (4-pin CPU_FAN1, 4-pin SYS_FAN1)

Connect the fan cables to the fan connectors on the motherboard, ensuring that the black wire of each cable matches the ground pin of the connector.

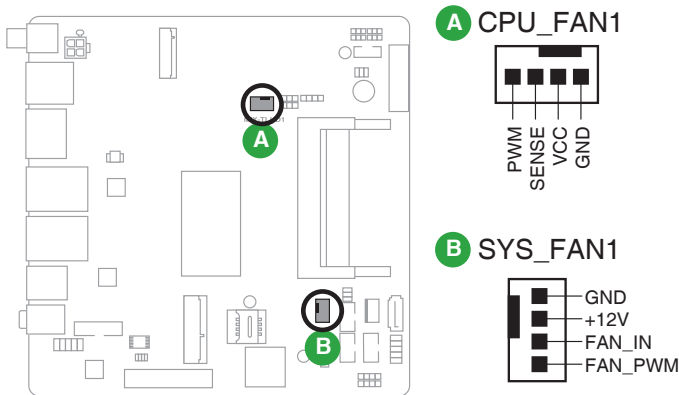

Do not forget to connect the fan cables to the fan connectors. Insufficient air flow inside the system may damage the motherboard components. These are not jumpers! Do not place jumper caps on the fan connectors!

5. LVDS connector (40-pin LVDS)

This connector is for an LCD monitor that supports Low-Voltage Differential Signaling (LVDS) interface.

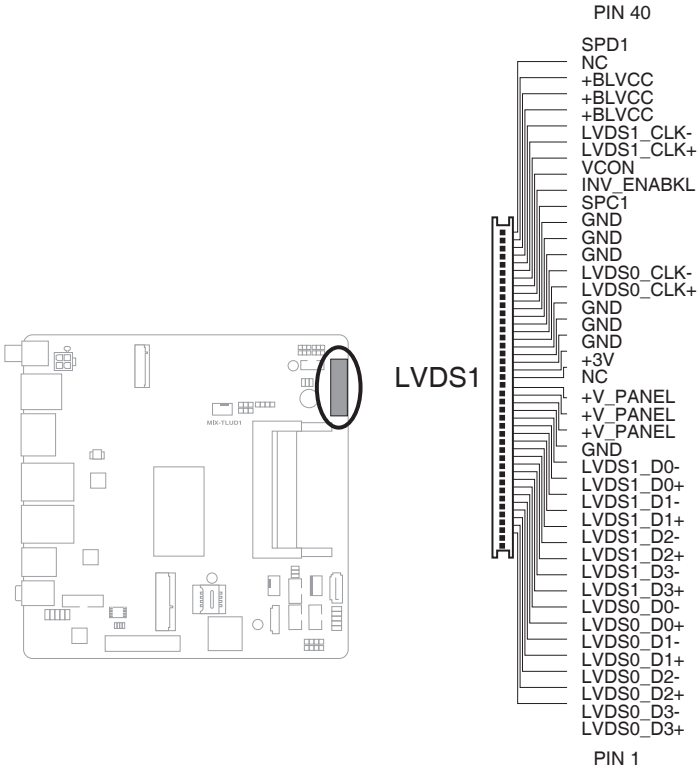

6. Backlight inverter power connector (5-pin INV)

Connect the backlight inverter power cable to this connector.

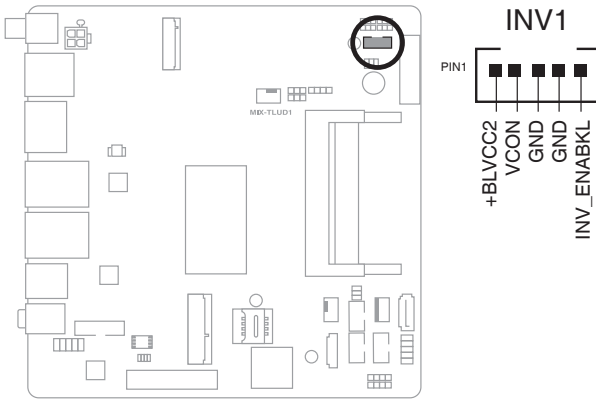

The backlight inverter power connector supports 1A current to the maximum.

7. SATA power header (4-pin SATA_PWR)

This header is for the SATA power cable. The power cable plug is designed to fit this header in only one orientation. Find the proper orientation and push down firmly until the header completely fits.

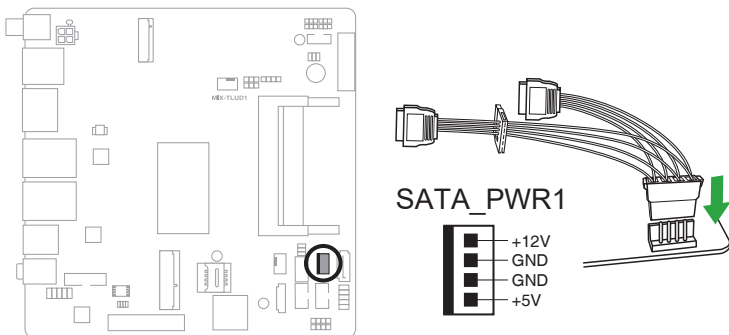

The SATA power header supports 1A current to the maximum.

8. SATA 6.0Gb/s port (7-pin SATA6G_1)

This port connects to a Serial ATA 6.0 Gb/s hard disk drive via a Serial ATA 6.0 Gb/s signal cable.

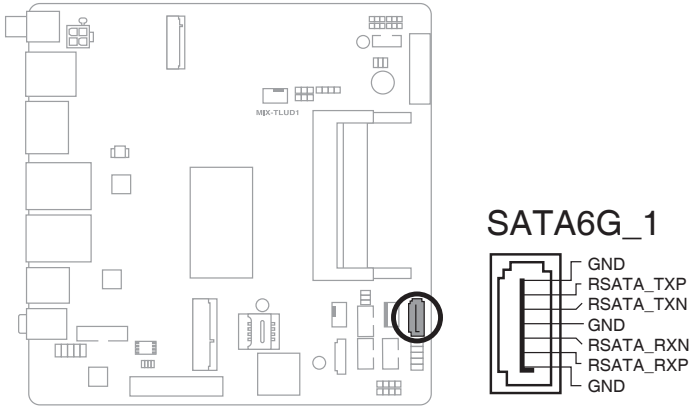

When using hot-plug and NCQ, set the SATA Mode Selection item in the BIOS to [AHCI]. See section 3.3.3 **SATA Configuration** for details.

9. Digital I/O header (10-pin DIO)

This header includes 8 I/O lines (In/Out programmable). All of the Digital I/O lines are programmable and each I/O pin can be individually programmed to support various devices.

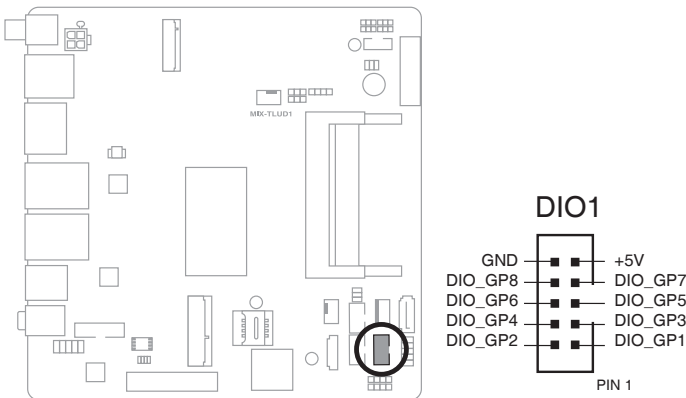

To configure the I/O pins in BIOS, go to the Advanced tab > Digital IO Port Configuration. See section 3.3.11 **Digital IO Port Configuration** for details.

10. System Panel header (10-1 pin F_PANEL)

This header supports several chassis-mounted functions.

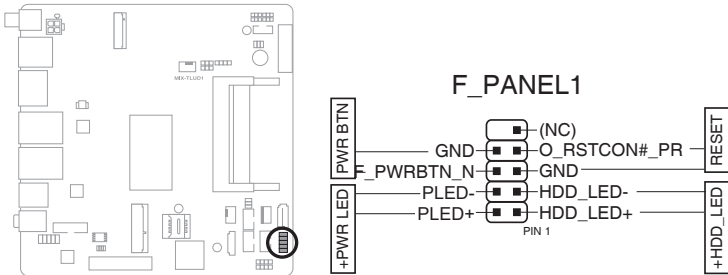

- **System power LED (2-pin PWR_LED)**

This 2-pin header is for the system power LED. Connect the chassis power LED cable to this header. The system power LED lights up when you turn on the system power, and blinks when the system is in sleep mode.

- **Hard disk drive activity LED (2-pin HDD_LED)**

This 2-pin header is for the HDD Activity LED. Connect the HDD Activity LED cable to this header. The IDE LED lights up or flashes when data is read from or written to the HDD.

- **ATX power button/soft-off button (2-pin PWR_BTN)**

This 2-pin header is for the system power button.

- **Reset button (2-pin RESET)**

This 2-pin header is for the chassis-mounted reset button for system reboot without turning off the system power.

11. COM Port headers (10-pin COM1~2)

These headers are for serial (COM) ports. Connect the serial port module cables to these header, then install the modules to slot openings at the back of the system chassis.

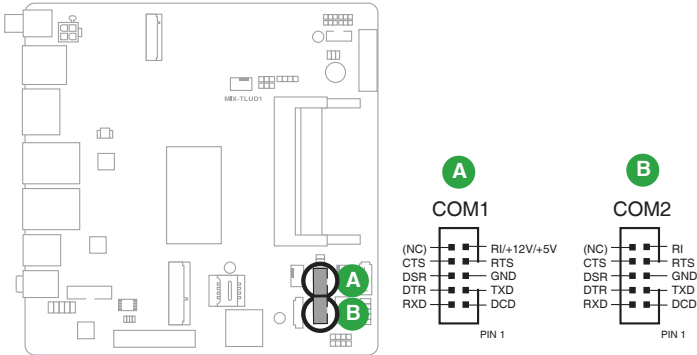

The COM module is purchased separately.

12. Debug Card connector

This connector allows connection to a Debug card.

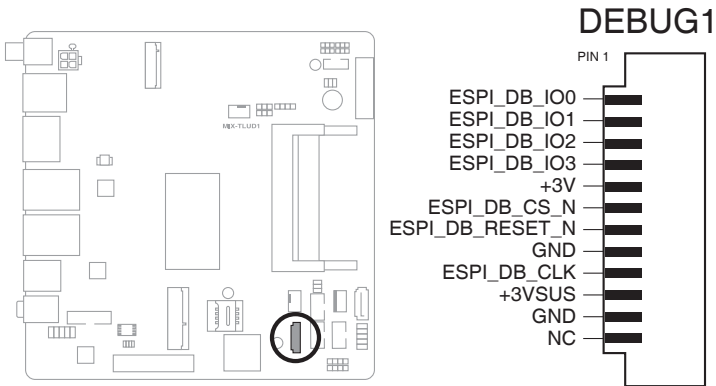

13. SIM Card connector (10-pin SIM1)

This slot connects to a SIM card reader module.

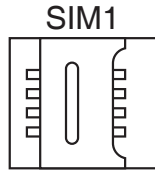
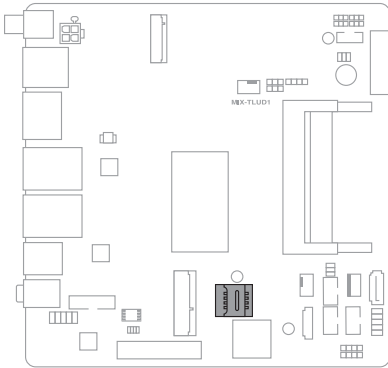

14. Mini PCIe x1 slot (MINI_CARD1)

Use this slot to connect Minicard readers.

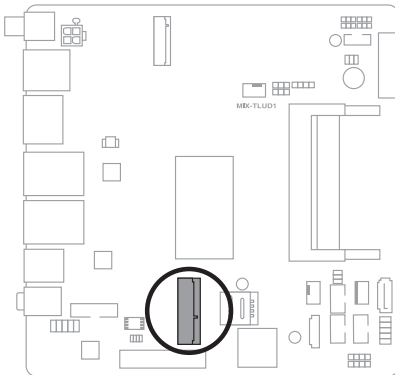

MINI_CARD1



- The Mini-card module is purchased separately.
- MINI_CARD1 supports mSATA PCIE function.

15. BIOS programmable connector (8-pin SPI_1)

Use this connector to flash the BIOS ROM.

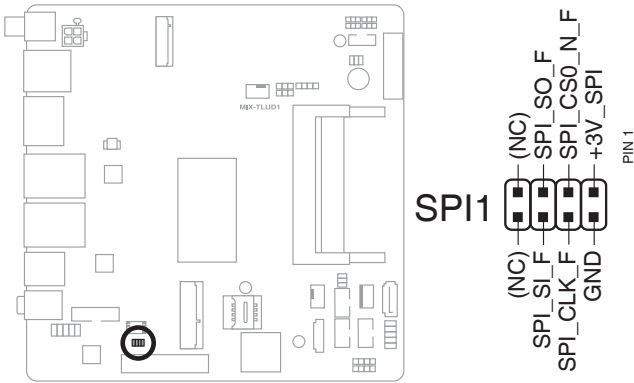

16. USB 3.2 Gen 1 header (20-pin USB3_1)

The USB 3.2 Gen 1 header allows you to connect a USB 3.2 Gen 1 module for additional USB 3.2 Gen 1 ports. The USB 3.2 Gen 1 header provides data transfer speeds of up to 5 Gb/s.

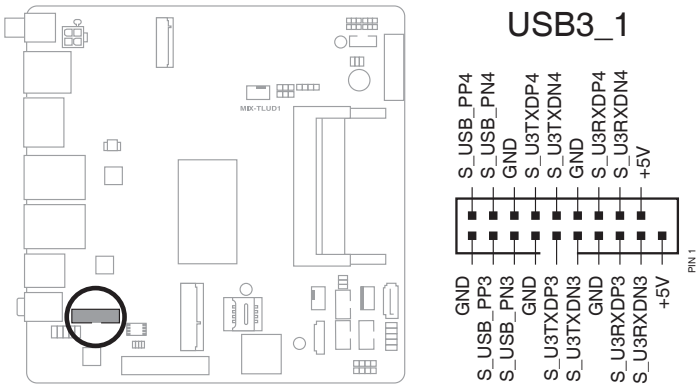

The USB 3.2 Gen 1 module is purchased separately.



The plugged USB 3.2 Gen 1 device may run on xHCI or EHCI mode depending on the operating system's setting.

17. Front Panel Audio header (10-1 pin AAFP)

This header is for a chassis-mounted front panel audio I/O module that supports HD Audio audio standard. Connect one end of the front panel audio I/O module cable to this header.

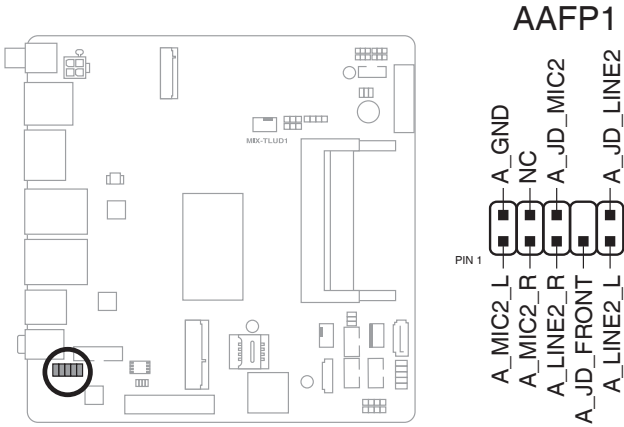

We recommend that you connect a high-definition front panel audio module to this connector to avail of the motherboard's high-definition audio capability.

18. Embedded DisplayPort connector (40-pin EDP)

This connector is for an internal embedded DisplayPort connection.

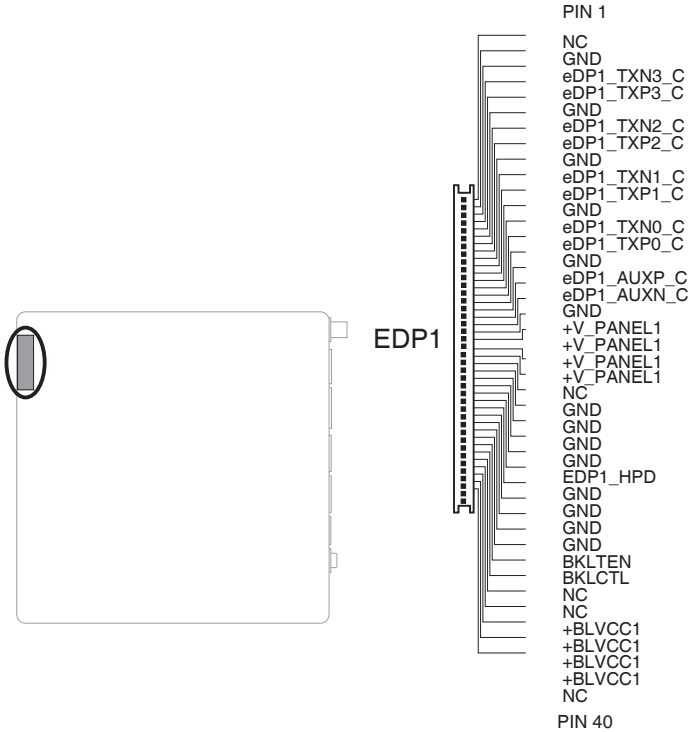

Chapter 3

BIOS Setup

3.1 BIOS Setup

Use the BIOS Setup to configure settings. The BIOS screens include navigation keys and help to guide you in using the BIOS Setup program.

Entering BIOS Setup at startup

To enter BIOS Setup at startup:

Press <Delete> during the Power-On Self Test (POST). If you do not press <Delete>, POST continues with its routine.

Entering BIOS Setup after POST

To enter BIOS Setup after POST:

- Press <Ctrl>+<Alt>+ simultaneously.
- Press the reset button on the system chassis.
- Press the power button to turn the system off then back on. Do this option only if you failed to enter BIOS Setup using the first two options.



Using the power button, reset button, or the <Ctrl>+<Alt>+ keys to reboot a running operating system can cause damage to your data or system. Always shut down the system properly from the operating system.



- The default BIOS settings for this motherboard apply to most working conditions and ensures optimal performance. If the system becomes unstable after changing any BIOS settings, load the default settings to regain system stability. Select the option **Restore Defaults** under the Save & Exit Menu. See section **3.7 Save & Exit Menu**.
 - If the system fails to boot after changing any BIOS setting, try to clear the CMOS and reset the motherboard to the default value. See section **2.6 Jumpers** for information on how to erase the RTC RAM.
-

Menu bar

The menu bar on top of the screen has the following main items:

Main	For changing the basic system configuration.
Advanced	For changing the advanced system settings.
Chipset	For viewing and changing chipset settings.
Security	For setting up BIOS security settings.
Boot	For changing the system boot configuration.
Save & Exit	For selecting the exit options and loading default settings.

To select an item on the menu bar, press the right or left arrow key on the keyboard until the desired item is highlighted.

3.2 Main menu

The Main menu provides you an overview of the basic system information, and allows you to set the system date and time.

3.2.1 System Date [Day MM/DD/YYYY]

Allows you to set the system date.

3.2.2 System Time [HH:MM:SS]

Allows you to set the system time.

3.3 Advanced menu

The Advanced menu items allow you to change the settings for the CPU and other system devices.



Be cautious when changing the settings of the Advanced menu items. Incorrect field values can cause the system to malfunction.

3.3.1 CPU Configuration

The items in this menu show CPU-related information the BIOS automatically detects.



The items shown in the submenu may be different depending on the type of CPU installed.

Hyper-threading [Enabled]

The Intel Hyper-Threading Technology allows a hyper-threading processor to appear as two logical processors to the operating system, allowing the operating system to schedule two threads or processes simultaneously.

[Enabled] Two threads per activated core are enabled.

[Disabled] Only one thread per activated core is enabled.

Intel (VMX) Virtualization Technology [Enabled]

[Enabled] Allows a hardware platform to run multiple operating systems separately and simultaneously, enabling one system to virtually function as several systems.

[Disabled] Disables this function.

Configurable TDP Boot Mode [Up]

Allows you to select configurable TDP boot mode. Configuration options: [Nominal] [Down] [Up]

3.3.2 Trusted Computing

Security Device Support [Enable]

Allows you to enable or disable BIOS support for security devices. Configuration options: [Disable] [Enable]

SHA-1 PCR Bank [Disabled]

Allows you to enable or disable SHA-1 PCR Bank. Configuration options: [Disabled] [Enabled]

SHA256 PCR Bank [Enabled]

Allows you to enable or disable SHA256 PCR Bank. Configuration options: [Disabled] [Enabled]

SHA384 PCR Bank [Disabled]

Allows you to enable or disable SHA384 PCR Bank. Configuration options: [Disabled] [Enabled]

Pending operation [None]

Allows you to schedule an operation for security devices. Reboot your system for the changes to take effect. Configuration options: [None] [TPM Clear]

Platform Hierarchy [Enabled]

Allows you to enable or disable Platform Hierarchy. Configuration options: [Enabled] [Disabled]

Storage Hierarchy [Enabled]

Allows you to enable or disable Storage Hierarchy. Configuration options: [Enabled] [Disabled]

Endorsement Hierarchy [Enabled]

Allows you to enable or disable Endorsement Hierarchy. Configuration options: [Enabled] [Disabled]

TPM2.0 UEFI Spec Version [TCG_2]

Allows you to select the TCG2 spec version support.

[TCG_1_2] Compatible mode for Windows® 8 / Windows® 10.

[TCG_2] Newer TCG2 protocol and event format for Windows® 10 or later.

Physical Presence Spec Version [1.3]

Allows you to select which TCG Physical Presence Interface Specification Version is supported by the OS. Configuration options: [1.2] [1.3]

Device Select [Auto]

Allows you to schedule an operation for security devices. Reboot your system for the changes to take effect. Configuration options: [Auto] [TPM 1.2] [TPM 2.0]

[Auto] Select this item to support both TPM 1.2 and TPM 2.0 devices with default support of TPM 2.0 devices. If TPM 2.0 devices are not found, TPM 1.2 devices will be enumerated.

3.3.3 SATA Configuration

While entering Setup, the BIOS automatically detects the presence of SATA devices. The SATA Port items show **Empty** if no SATA device is installed to the corresponding SATA port.

SATA Controller(s) [Enabled]

Allows you to enable or disable SATA devices. Configuration options: [Enabled] [Disabled]

Port 0, Port 1 [Enabled]

These items allow you to enable/disable the SATA or M.2 port(s). Configuration options: [Disabled] [Enabled]

Hot Plug [Disabled]

These items allow you to enable/disable SATA Hot Plug Support. Configuration options: [Disabled] [Enabled]

3.3.4 USB Configuration

The items in this menu allow you to change the USB-related features.



The USB Devices item shows the auto-detected values. If no USB device is detected, the item shows **None**.

Legacy USB Support [Enabled]

- [Enabled] Enables the support for USB devices on legacy operating systems (OS).
- [Disabled] The USB devices can be used only for EFI applications.
- [Auto] Allows the system to detect the presence of USB devices at startup. If detected, the USB controller legacy mode is enabled. If no USB device is detected, the legacy USB support is disabled.

3.3.5 Hardware Monitor

The items in this menu allow you to configure the smart fan.

Smart Fan Configuration

CPU Fan 1 Mode / System Fan 1 Mode [Auto]

Allows you to select the CPU Fan 1 / System Fan 1 mode. Configuration options: [Auto] [Silent] [Performance] [Full Speed] [Manual] [Disable]

3.3.6 SIO Configuration

The items in this menu allow you to configure Super IO settings.

[*Active*] Serial Port 1

Use This device [Enabled]

Allows you to enable or disable this logical device. Configuration options: [Enabled] [Disabled]



The following two items appear only when you set **Use this device** to [Enabled].

Possible [Use Automatic Settings]

Allows you to select an optimal setting for Super I/O devices. New settings will take effect after restarting the system. Configuration options: [Use Automatic Settings] [IO=3F8h; IRQ=4;] [IO=3E8h; IRQ=7;]

[*Active*] Serial Port 2

Use This device [Enabled]

Allows you to enable or disable this logical device. Configuration options: [Enabled] [Disabled]



The following item appears only when you set **Use this device** to [Enabled].

Possible [Use Automatic Settings]

Allows you to select an optimal setting for Super I/O devices. Configuration

options: [Use Automatic Settings] [IO=3E8h; IRQ=7;] [IO=3F8h; IRQ=4;]

3.3.7 AMT Configuration

AMT BIOS Features [Enabled]

When disabled, you are not able to access the MEBx setup. Configuration options: [Enabled] [Disabled]

3.3.8 PCH-FW Configuration

Firmware Update Configuration

Me FW Image Re-Flash [Disabled]

This item allows you to enable or disable Me FW Image Re-Flash function. Configuration options: [Disabled] [Enabled]

FW Update [Enabled]

This item allows you to enable or disable FW Update function. Configuration options: [Disabled] [Enabled]

3.3.9 NVMe Configuration

This menu displays the NVMe controller and Drive information of the connected devices.

3.3.10 Power Management

Power Mode [ATX Type]

Select power supply mode. Configuration options: [ATX Type] [AT Type]



Ensure to power off the system before switching between ATX and AT type.

Restore AC Power Loss [Last State]

[Last State] The system goes into either off or on state, whatever the system state was.

[Always On] The system goes into on state after an AC power loss.

[Always Off] The system goes into off state after an AC power loss.

RI Wake Event [Disabled]

Enable or disable system to wake up from RI#. Configuration options: [Enabled] [Disabled]

RTC Wake system from S5 [Disabled]

[Disabled] Disables system wake up from S5.

[Fixed Time] The system will wake up at the specified hr.:min.:sec. Configuration options: [Disabled] [Enabled] .

[Dynamic Time] The system will wake up at the current time plus a specified number of minutes.



The following items appear when Fixed Time is enabled.

Wake up day/hour/minute/second [0]

Specify the values for day/hour/minute/second.



The following item appears when Dynamic Time is enabled.

Wake up minute increase [1]

Specify the number of minutes added to the current time before waking up system. Input value range: [1~5]

3.3.11 Digital IO Port Configuration

The items listed in this screen configure Digital IO settings.

DIO Port1~Port4 [Output], DIO Port5~Port8 [Input]

Configuration options: [Input] [Output]



The following item appears only when you set **DIO Port1~8** to [Output].

Output Level [High]

Configuration options: [Low] [High]

3.4 Chipset menu

The Chipset menu items allow you to change configuration options for the North Bridge and South Bridge.

3.4.1 System Agent (SA) Configuration

In-Band ECC Support [Disabled]

Allows you to enable or disable the in-band ECC. Either the IBECC or the TME can be enabled. Configuration options: [Disabled] [Enabled]

Primary Display [Auto]

Allows you to decide which graphics controller to use as the primary boot device. Configuration options: [Auto] [IGFX]

M.2 M-Key Gen Speed [Auto]

Allows you to configure the PCIe speed. Configuration options: [Auto] [Gen1] [Gen2] [Gen3] [Gen4]

LVDS [Disabled]

Allows you to enable or disable LVDS (CH7511B). Configuration options: [Disabled] [Enabled]

3.4.2 PCH-IO Configuration

HD Audio [Enabled]

This item controls the detection of HD Audio devices. Configuration options: [Disabled] [Enabled]

PCIEX4 Gen Speed [Auto]

Configures the speed of PCIe slot. Configuration options: [Auto] [Gen1] [Gen2] [Gen3]

3.5 Security menu

The Security menu items allow you to change the system security settings.

3.5.1 Administrator Password

If you have set an administrator password, we recommend that you enter the administrator password for accessing the system. Otherwise, you might be able to see or change only selected fields in the BIOS setup program.

To set an administrator password:

1. Select the Administrator Password item and press <Enter>.
2. From the Create New Password box, key in a password, then press <Enter>.
3. Confirm the password when prompted.

To change an administrator password:

1. Select the Administrator Password item and press <Enter>.
2. From the Enter Current Password box, key in the current password, then press <Enter>.
3. From the Create New Password box, key in a new password, then press <Enter>.
4. Confirm the password when prompted.

To clear the administrator password, follow the same steps as in changing an administrator password, but press <Enter> when prompted to create/confirm the password. After you clear the password, the Administrator Password item on top of the screen shows Not Installed.

3.5.2 User Password

If you have set a user password, you must enter the user password for accessing the system. The User Password item on top of the screen shows the default Not Installed. After you set a password, this item shows Installed.

To set a user password:

1. Select the User Password item and press <Enter>.
2. From the Create New Password box, key in a password, then press <Enter>.
3. Confirm the password when prompted.

To change a user password:

1. Select the User Password item and press <Enter>.
2. From the Enter Current Password box, key in the current password, then press <Enter>.
3. From the Create New Password box, key in a new password, then press <Enter>.
4. Confirm the password when prompted.

To clear the user password, follow the same steps as in changing a user password, but press <Enter> when prompted to create/confirm the password. After you clear the password, the **User Password** item on top of the screen shows **Not Installed**.

3.5.3 Secure Boot

Secure Boot [Disabled]

This item allows you to configure the Windows® Secure Boot settings and manage its keys to protect the system from unauthorized access and malwares during POST. Configuration options: [Disabled] [Enabled]

Secure Boot Mode [Custom]

This item allows you to select the secure boot mode. Configuration options: [Standard] [Custom]

Restore Factory Keys

This item allows you to restore factory keys. Press **Yes** to proceed and **No** to cancel.

Reset to Setup Mode

This item allows you to delete all the system variables and reset to the Setup mode. Press **Yes** to proceed and **No** to cancel.

Key Management**Factory Key Provision**

This item allows you to install factory default secure boot keys in Setup mode after resetting the system.

Restore Factory Keys

This item allows you to restore factory keys. Press **Yes** to proceed and **No** to cancel.

Reset To Setup Mode

This item allows you to reset to Setup Mode. Press **Yes** to proceed and **No** to cancel.

Export Secure Boot variables

This item allows you to export secure boot variables.

Enroll Efi Image

This item allows the image to run in Secure Boot mode.

Remove 'UEFI CA' from DB

This item allows you to remove UEFI CA from DB. Press **Yes** to proceed and **No** to cancel.

Restore DB defaults

This item allows you to restore DB variables to factory defaults. Press **Yes** to proceed and **No** to cancel.

Platform Key (PK)

This item allows you to enroll factory defaults or load certification from a file.

Key Exchange Keys / Authorized Signatures / Forbidden Signatures / Authorized TimeStamps / OsRecovery Signatures

This item allows you to enroll factory defaults or load certification from a file. Configuration options: [Update] [Append]

3.6 Boot menu

The Boot menu items allow you to change the system boot options.

3.6.1 Boot Configuration

Quiet Boot [Enabled]

This item enables/disables Quiet Boot. Configuration options: [Disabled] [Enabled]

Network Stack [Disabled]

This item allows you to disable or enable the UEFI network stack. Configuration options: [Disable] [Enable]

3.6.2 Boot Option Priorities

Boot Option #1-#10

This item allows you to set the system boot order. Configuration options: [USB Key] [USB Hard Disk] [Hard Disk] [NVME] [Network] [USB Lan] [CD/DVD] [USB CD/DVD] [USB Floppy] [SD] [Disabled]

3.7 Save & Exit menu

3.7.1 Save Options

Save Changes and Reset

Once you are finished making your selections, choose this option from the Exit menu to ensure the values you selected are saved. When you select this option, a confirmation window appears. Select Yes to save changes and reboot system.

Discard Changes and Exit

This option allows you to exit the Setup program without saving your changes. When you select this option or if you press <Esc>, a confirmation window appears. Select Yes to discard changes and reboot system.

3.7.2 Default Options

Restore Defaults

Save or restore User Defaults to all setup options.

Appendix

Notices

Federal Communications Commission Statement

This device complies with Part 15 of the FCC Rules. Operation is subject to the following two conditions:

- This device may not cause harmful interference.
- This device must accept any interference received including interference that may cause undesired operation.

This equipment has been tested and found to comply with the limits for a Class A digital device, pursuant to Part 15 of the FCC Rules. These limits are designed to provide reasonable protection against harmful interference in a residential installation. This equipment generates, uses and can radiate radio frequency energy and, if not installed and used in accordance with manufacturer's instructions, may cause harmful interference to radio communications. However, there is no guarantee that interference will not occur in a particular installation. If this equipment does cause harmful interference to radio or television reception, which can be determined by turning the equipment off and on, the user is encouraged to try to correct the interference by one or more of the following measures:

- Reorient or relocate the receiving antenna.
- Increase the separation between the equipment and receiver.
- Connect the equipment to an outlet on a circuit different from that to which the receiver is connected.
- Consult the dealer or an experienced radio/TV technician for help.



WARNING! The use of shielded cables for connection of the monitor to the graphics card is required to assure compliance with FCC regulations. Changes or modifications to this unit not expressly approved by the party responsible for compliance could void the user's authority to operate this equipment.



DO NOT throw the motherboard in municipal waste. This product has been designed to enable proper reuse of parts and recycling. This symbol of the crossed out wheeled bin indicates that the product (electrical and electronic equipment) should not be placed in municipal waste. Check local regulations for disposal of electronic products.



DO NOT throw the mercury-containing button cell battery in municipal waste. This symbol of the crossed out wheeled bin indicates that the battery should not be placed in municipal waste.



电子电气产品有害物质限制使用标识要求：图中之数字为产品之环保使用期限。仅指电子电气产品中含有的有害物质不致发生外泄或突变从而对环境造成污染或对人身、财产造成严重损害的期限。

部件名称	有害物质					
	铅 (Pb)	汞 (Hg)	镉 (Cd)	六价铬 (Cr(VI))	多溴联苯 (PBB)	多溴二苯醚 (PBDE)
印刷电路板及其电子组件	×	○	○	○	○	○
外壳	×	○	○	○	○	○
电源适配器	×	○	○	○	○	○
外部信号连接头及线材	×	○	○	○	○	○
中央处理器与内存	×	○	○	○	○	○

本表格依据 SJ/T 11364 的规定编制。

○：表示该有害物质在该部件所有均质材料中的含量均在 GB/T 26572 规定的限量要求以下。

×：表示该有害物质至少在该部件的某一均质材料中的含量超出 GB/T 26572 规定的限量要求，然该部件仍符合欧盟指令 2011/65/EU 的规范。

备注：此产品所标示之环保使用期限，系指在一般正常使用状况下。