

ICS-6270

Industrial DIN Rail Network Appliance

User's Manual 4th Ed

Copyright Notice

This document is copyrighted, 20188. All rights are reserved. The original manufacturer reserves the right to make improvements to the products described in this manual at any time without notice.

No part of this manual may be reproduced, copied, translated, or transmitted in any form or by any means without the prior written permission of the original manufacturer. Information provided in this manual is intended to be accurate and reliable. However, the original manufacturer assumes no responsibility for its use, or for any infringements upon the rights of third parties that may result from its use.

The material in this document is for product information only and is subject to change without notice. While reasonable efforts have been made in the preparation of this document to assure its accuracy, AAEMON assumes no liabilities resulting from errors or omissions in this document, or from the use of the information contained herein.

AAEMON reserves the right to make changes in the product design without notice to its users.

Acknowledgement

All other products' name or trademarks are properties of their respective owners.

- Microsoft Windows is a registered trademark of Microsoft Corp.
- Intel, Pentium, Celeron, and Xeon are registered trademarks of Intel Corporation
- Core, Atom are trademarks of Intel Corporation
- ITE is a trademark of Integrated Technology Express, Inc.
- IBM, PC/AT, PS/2, and VGA are trademarks of International Business Machines Corporation.

All other product names or trademarks are properties of their respective owners.

Packing List

Before setting up your product, please make sure the following items have been shipped:

Item	Quantity
● ICS-6270	1
● DIN Rail Kit	1
● SATA Cable	1
● SATA Power Cable	1
● Memory heatsink	1
● Thermal Pad	1
● 2 Pin Phoenix Contact Connector (Male)	1

If any of these items are missing or damaged, please contact your distributor or sales representative immediately.

About this Document

This User's Manual contains all the essential information, such as detailed descriptions and explanations on the product's hardware and software features (if any), its specifications, dimensions, jumper/connector settings/definitions, and driver installation instructions (if any), to facilitate users in setting up their product.

Users may refer to the AAEON.com for the latest version of this document.

Safety Precautions

Please read the following safety instructions carefully. It is advised that you keep this manual for future references

1. All cautions and warnings on the device should be noted.
2. All cables and adapters supplied by AAEON are certified and in accordance with the material safety laws and regulations of the country of sale. Do not use any cables or adapters not supplied by AAEON to prevent system malfunction or fires.
3. Make sure the power source matches the power rating of the device.
4. Position the power cord so that people cannot step on it. Do not place anything over the power cord.
5. Always completely disconnect the power before working on the system's hardware.
6. No connections should be made when the system is powered as a sudden rush of power may damage sensitive electronic components.
7. If the device is not to be used for a long time, disconnect it from the power supply to avoid damage by transient over-voltage.
8. Always disconnect this device from any AC supply before cleaning.
9. While cleaning, use a damp cloth instead of liquid or spray detergents.
10. Make sure the device is installed near a power outlet and is easily accessible.
11. Keep this device away from humidity.
12. Place the device on a solid surface during installation to prevent falls
13. Do not cover the openings on the device to ensure optimal heat dissipation.
14. Watch out for high temperatures when the system is running.
15. Do not touch the heat sink or heat spreader when the system is running
16. Never pour any liquid into the openings. This could cause fire or electric shock.

17. As most electronic components are sensitive to static electrical charge, be sure to ground yourself to prevent static charge when installing the internal components. Use a grounding wrist strap and contain all electronic components in any static-shielded containers.
18. If any of the following situations arises, please the contact our service personnel:
 - i. Damaged power cord or plug
 - ii. Liquid intrusion to the device
 - iii. Exposure to moisture
 - iv. Device is not working as expected or in a manner as described in this manual
 - v. The device is dropped or damaged
 - vi. Any obvious signs of damage displayed on the device
19. **DO NOT LEAVE THIS DEVICE IN AN UNCONTROLLED ENVIRONMENT WITH TEMPERATURES BEYOND THE DEVICE'S PERMITTED STORAGE TEMPERATURES (SEE CHAPTER 1) TO PREVENT DAMAGE.**

Warning!



This device complies with Part 15 FCC Rules. Operation is subject to the following two conditions: (1) this device may not cause harmful interference, and (2) this device must accept any interference received including interference that may cause undesired operation.

Caution:

There is a danger of explosion if the battery is incorrectly replaced. Replace only with the same or equivalent type recommended by the manufacturer. Dispose of used batteries according to the manufacturer's instructions and your local government's recycling or disposal directives.

Attention:

Il y a un risque d'explosion si la batterie est remplacée de façon incorrecte. Ne la remplacer qu'avec le même modèle ou équivalent recommandé par le constructeur. Recycler les batteries usées en accord avec les instructions du fabricant et les directives gouvernementales de recyclage.

China RoHS Requirements (CN)

产品中有毒有害物质或元素名称及含量

AAEON Embedded Box PC/ Industrial System

部件名称	有毒有害物质或元素					
	铅 (Pb)	汞 (Hg)	镉 (Cd)	六价铬 (Cr(VI))	多溴联苯 (PBB)	多溴二苯醚 (PBDE)
印刷电路板 及其电子组件	○	○	○	○	○	○
外部信号 连接器及线材	○	○	○	○	○	○
外壳	○	○	○	○	○	○
中央处理器 与内存	○	○	○	○	○	○
硬盘	○	○	○	○	○	○
电源	○	○	○	○	○	○
<p>O: 表示该有毒有害物质在该部件所有均质材料中的含量均在 SJ/T 11363-2006 标准规定的限量要求以下。</p> <p>X: 表示该有毒有害物质至少在该部件的某一均质材料中的含量超出 SJ/T 11363-2006 标准规定的限量要求。</p> <p>备注:</p> <p>一、此产品所标示之环保使用期限，系指在一般正常使用状况下。</p> <p>二、上述部件物质中央处理器、内存、硬盘、光驱、触控模块为选购品。</p>						

China RoHS Requirement (EN)

Poisonous or Hazardous Substances or Elements in Products

AAEON Embedded Box PC/ Industrial System

Component	Poisonous or Hazardous Substances or Elements					
	Lead (Pb)	Mercury (Hg)	Cadmium (Cd)	Hexavalent Chromium (Cr(VI))	Polybrominated Biphenyls (PBB)	Polybrominated Diphenyl Ethers (PBDE)
PCB & Other Components	○	○	○	○	○	○
Wires & Connectors for External Connections	○	○	○	○	○	○
Chassis	○	○	○	○	○	○
CPU & RAM	○	○	○	○	○	○
Hard Disk	○	○	○	○	○	○
PSU	○	○	○	○	○	○

O: The quantity of poisonous or hazardous substances or elements found in each of the component's parts is below the SJ/T 11363-2006-stipulated requirement.

X: The quantity of poisonous or hazardous substances or elements found in at least one of the component's parts is beyond the SJ/T 11363-2006-stipulated requirement.

Note: The Environment Friendly Use Period as labeled on this product is applicable under normal usage only

Table of Contents

Chapter 1 – Product Specifications	14
1.1 Specifications	15
Chapter 2 – Hardware Information	18
2.1 Dimensions	19
2.2 Jumpers and Connectors.....	22
2.3 List of Jumpers	24
2.3.1 CMOS Setting Selection (CN1)	25
2.3.2 Auto PWRBTN Selection (JP1).....	25
2.4 List of Connectors.....	26
2.4.1 Digital I/O (CN3)	27
2.4.2 DC-IN (CN1).....	27
2.4.3 COM PORT (CN23).....	27
2.5 List of Connectors for T461 TYPE A.....	28
2.5.1 COM PORT (CN9).....	28
2.6 Hard Disk Drive Installation	29
2.7 DIMM Sink Installation.....	33
Chapter 3 – AMI BIOS Setup.....	38
3.1 System Test and Initialization	39
3.2 AMI BIOS Setup	40
3.3 Setup Submenu: Main.....	41
3.4 Setup Submenu: Advanced.....	42
3.4.1 Advanced: Trusted Computing	43
3.4.2 Advanced: CPU Configuration	45
3.4.3 Advanced: SATA Drives	46
3.4.4 Advanced: USB Configuration	47
3.4.5 Advanced: Hardware Monitor	48

3.4.6	Advanced: SIO Configuration.....	49
3.4.6.1	Serial Port 1 Configuration.....	50
3.4.6.2	Serial Port 2 Configuration.....	51
3.4.7	Serial Port Console Redirection.....	52
3.4.7.1	Console Redirection Settings.....	53
3.4.7.2	Legacy Console Redirection Settings.....	56
3.4.7.3	Serial Port for Out-of-Band Management/Windows Emergency Management Services(EMS).....	57
3.4.8	LAN Bypass Configuration.....	59
3.4.9	Digital IO Port Configuration.....	61
3.5	Setup submenu: Chipset.....	62
3.5.1	Chipset: North Bridge.....	63
3.5.1.1	North Bridge: AMI Graphic Output Protocol Policy.....	64
3.6	Setup submenu: Security.....	65
3.7	Setup submenu: Boot.....	66
3.8	Setup submenu: Exit.....	67
Chapter 4 – Driver Installation.....		68
4.1	Driver Installation.....	69
Appendix A – Watchdog Timer Programming.....		71
A.1	Watchdog Timer Initial Program.....	72
Appendix B – I/O Information.....		78
B.1	I/O Address Map.....	79
B.2	Memory Address Map.....	81
B.3	IRQ Mapping Chart.....	82
Appendix C – Standard LAN Bypass Platform Setting.....		92
C.1	Introduction to LED.....	93
C.1.1	Status LED Configuration.....	94
C.1.2	Sample Code.....	95

C.2	Introduction to LAN Bypass	97
C.2.1	LAN Bypass.....	98
C.2.2	Sample Code.....	100
C.3	Introduction to Software Reset Button Configuration	102
C.3.1	Soft Reset Button Configuration	103
C.3.2	Sample Code.....	104

Chapter 1

Product Specifications

1.1 Specifications

System

- **Processor** Intel® Pentium® N3350 processor SoC
- **System Memory** 204-pin DDR3L 1867MHz SODIMM slot x 1, up to 8GB
- **Chipset** -
- **Ethernet** Intel® i211 (Co-lay with Intel® i210) Gigabit Ethernet x 6
- **Bypass** Supports up to 2 pairs bypass function
- **Storage** 2.5" HDD bay x 1
CFast™ socket x 1 (Co-lay for BOM Optional mSATA x 1)
- **Expansion Interface** Mini-Card socket (full-size) with SIM socket x 1
USB 3.0 Type A on I/O side x 2
- **OS Support** **Windows 10 (64 bit)**
VGA
Chipset
LAN
Yocto* Tool based Embedded Linux 4.1 or above
VGA
Chipset
LAN
- **Front Panel I/O** RS-232/422/485 COM Port up to 2 (1 via

	daughter board)
	USB 3.0 Port x 2
	RJ-45 LAN ports with LEDs x 6 (ICS-6270A)
	VGA port x 1
	GPIO Programmable Button x 1
	Power LED x 1
	Status LED x 1
	HDD Active LED x 1
	Bypass LED x 2
	DIN Rail and Wall mount
● Rear Panel I/O	
● Top Panel I/O	2Pin Terminal Block +9~36VDC x 1
● RTC	Internal RTC
● Watchdog Timer	1~255 steps by software programming
● Software Button	GPIO Programmable push button x 1
● TPM	Optional support TPM v1.2 9660/TPM2.0 9665
● GPIO	Reserve internal pin header 8-bit Digital I/O interface (4-in /4-out)
● Fan	Fanless
● Color	Dark Grey
● Power Requirement	2Pin Terminal Block +9~36VDC power input
● Dimension (W x D x H)	75 x 120 x 140 mm

Display

- Graphic Engine Intel® HD 505 Graphics
- Output Interface VGA

Environmental

- Operating Temperature -40°C ~ 75°C (-40°F ~ 156°F)
- Storage Temperature -40°C ~ 85°C (-40°F ~ 185°F)
- Operating Humidity 10 ~ 80% relative humidity, non-condensing
- Storage Humidity 10 ~ 80% @ 40°C, non-condensing
- Anti-Vibration 0.5 G_{rms}/5~500Hz/ operation (2.5" HDD)
1.5 G_{rms} /5~500Hz/ non-operation
- Anti-Shock 10 G peak acceleration (11m sec. duration),
operation
20 G peak acceleration (11m sec. duration),
non operation

Standards & Regulations

- Green RoHS
- Certification CE FCC ClassA

Chapter 2

Hardware Information

2.1 Dimensions

System

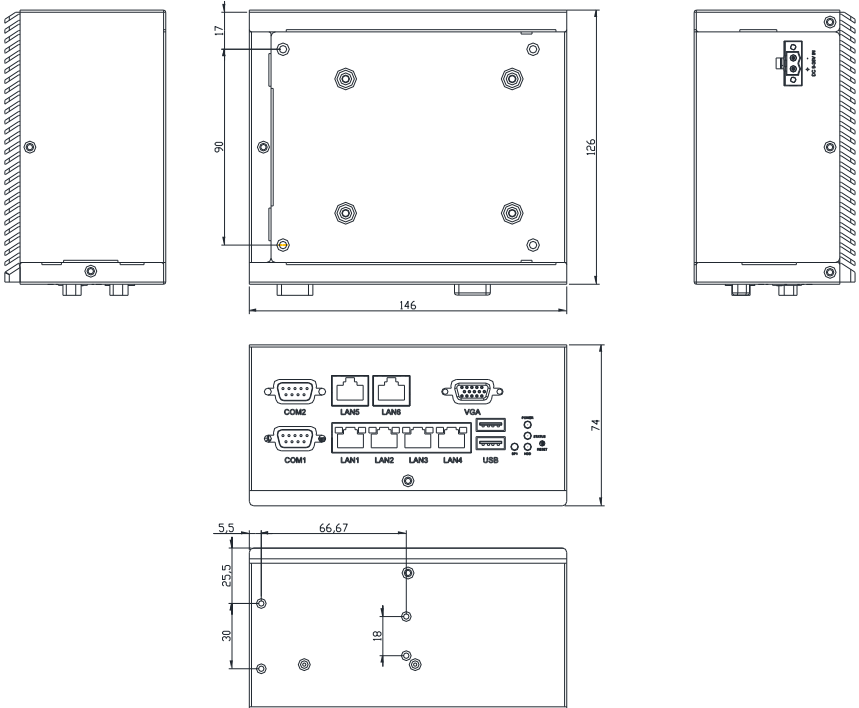

Board

Component Side

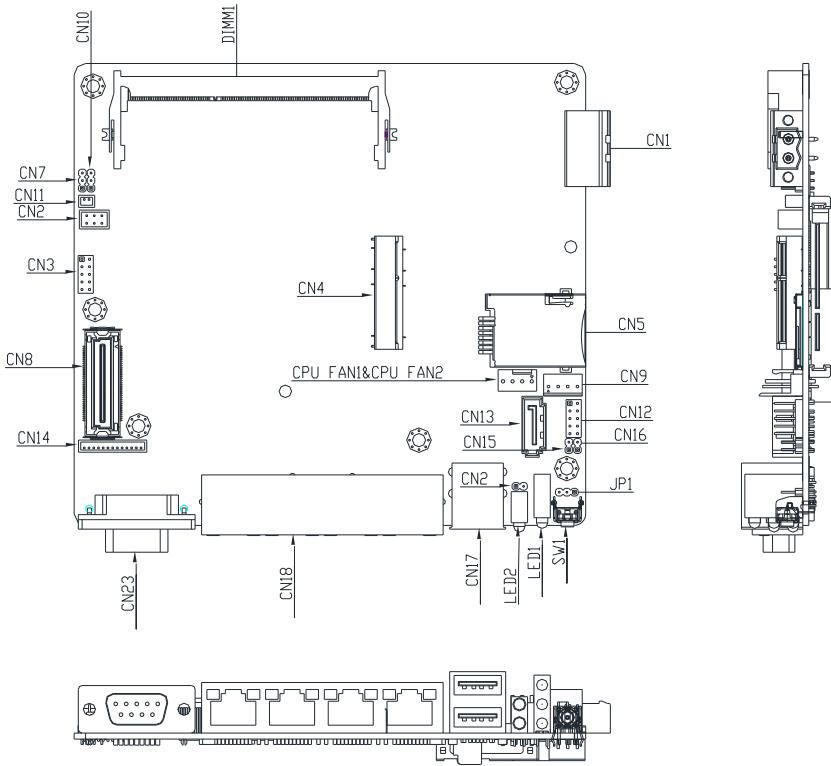

Solder Side

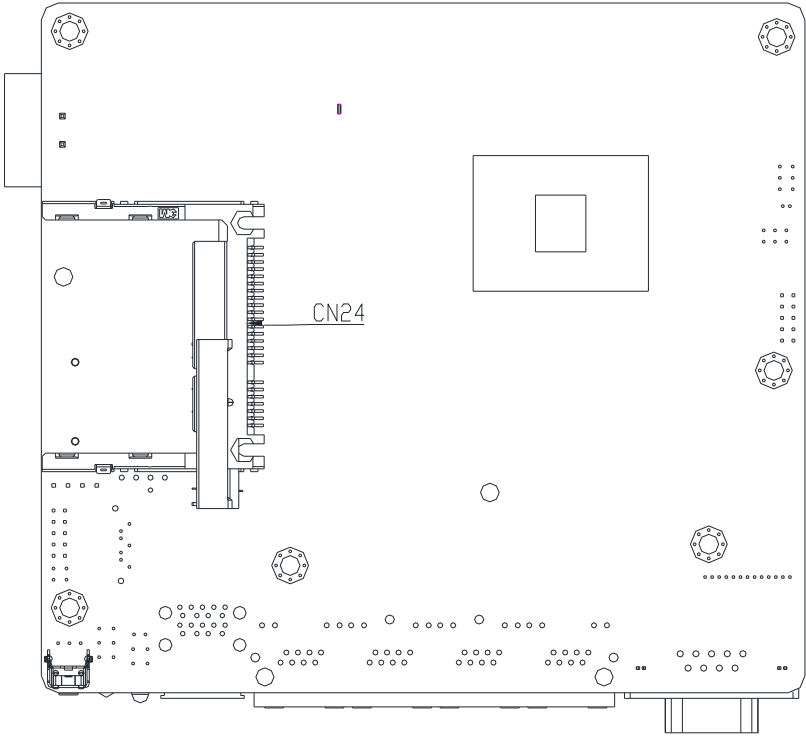

2.2 Jumpers and Connectors

Component Side

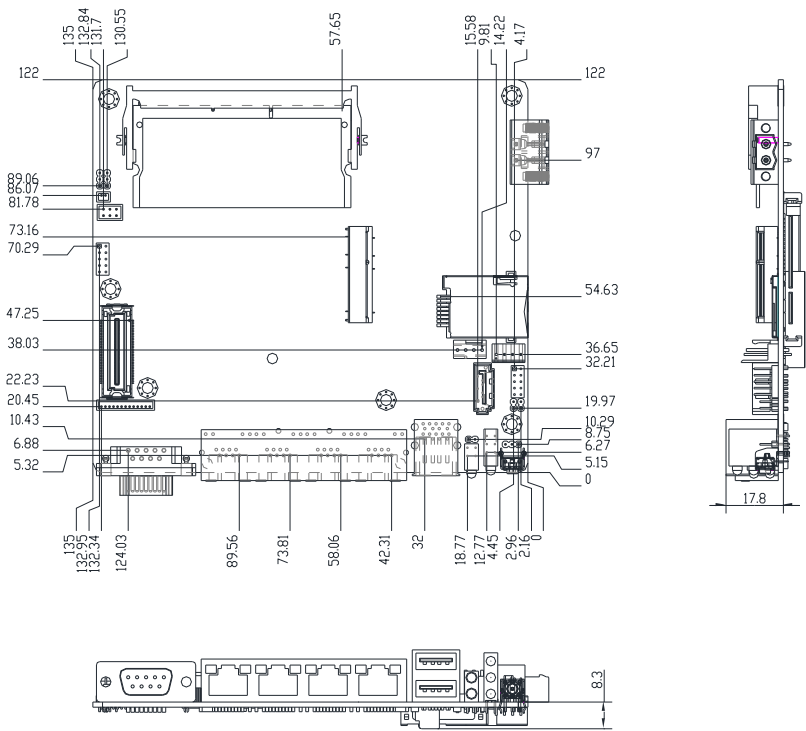

Solder Side

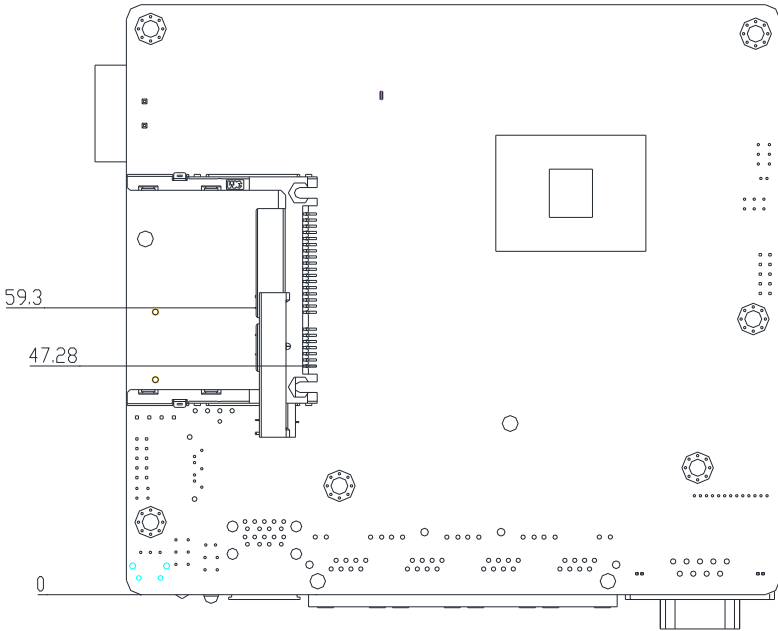

2.3 List of Jumpers

Please refer to the table below for all of the board's jumpers that you can configure for your application.

Label	Function
JP1	Auto PWRBTN Selection
CN7	CMOS Setting Selection

2.3.1 CMOS Setting Selection (CN1)



Normal (Default)



Clear CMOS

2.3.2 Auto PWRBTN Selection (JP1)



Don't use Auto PWRBTN



Use Auto PWRBTN

2.4 List of Connectors

Please refer to the table below for all of the board's connectors that you can configure for your application

Label	Function
DIMM1	DDR3L SODIMM SOCKET
CPU_FAN1	4P SMART FAN
CN2	KB/MS
CN23	COM PORT/RS232/RS422/RS485
CN13	SATA6G INTERFACE
CN9	SATA POWER
CN4	Mini Pci-E socket
CN24	CFast CARD SOCKET
CN5	SIM CARD SOCKET
CN15	RESET
CN16	POWER BUTTON
CN17	USB3.0 DUAL Port
CN3	Digital I/O
CN18	LAN1-4
CN1	DC-IN

2.4.1 Digital I/O (CN3)

This connector offers 4-pair of digital I/O functions and address is 801H. The pin definitions are illustrated below:

Pin	Signal	Pin	Signal
1	Digital- IN/OUT1	2	Digital- IN/OUT2
3	Digital- IN/OUT3	4	Digital- IN/OUT4
5	Digital- IN/OUT5	6	Digital- IN/OUT6
7	Digital- IN/OUT7	8	Digital- IN/OUT8
9	+5V	10	GND

2.4.2 DC-IN (CN1)

Pin	Signal	Pin	Signal
1	GND	2	POWER

2.4.3 COM PORT (CN23)

Pin	Signal	Pin	Signal
1	DCD/ RS422_TX-/ RS485_D-	2	RXD/RS422_TX+/ RS485_D+
3	TXD/ RS422_RX+	4	DTR/ RS422_RX-
5	GND	6	DSR
7	RTS	8	CTS
9	RI		

2.5 List of Connectors for T461 TYPE A

Please refer to the table below for all of the board's connectors that you can configure for your application

Label	Function
CN3	GIGA LAN
CN4	GIGA LAN
CN7	VGA PORT
CN9	COM2/RS232/RS422/RS485

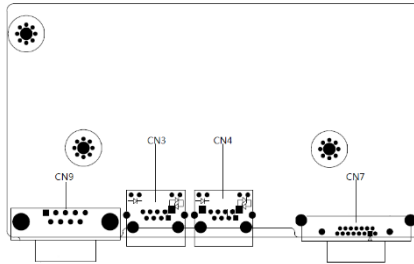

2.5.1 COM PORT (CN9)

Pin	Signal	Pin	Signal
1	DCD/ RS422_TX-/ RS485_D-	2	RXD/RS422_TX+/ RS485_D+
3	TXD/ RS422_RX+	4	DTR/ RS422_RX-
5	GND	6	DSR
7	RTS	8	CTS
9	RI		

2.6 Hard Disk Drive Installation

1. Loosen the screw and remove the top case from the lower side.

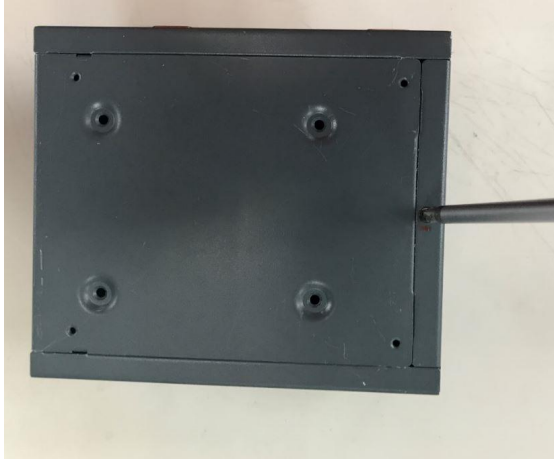

2. Place the SATA Cable and the Power cable onto the motherboard..



3. Put the SSD together and fasten them tightly with screws..



- Put the lid back on and fasten the screws securely.

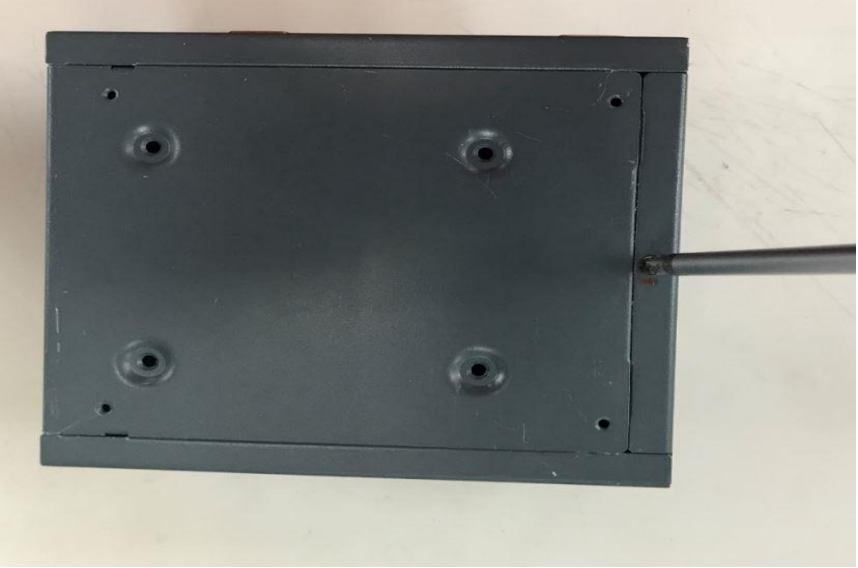

2.7 DIMM Sink Installation

1. Unscrew and remove the cover lid.

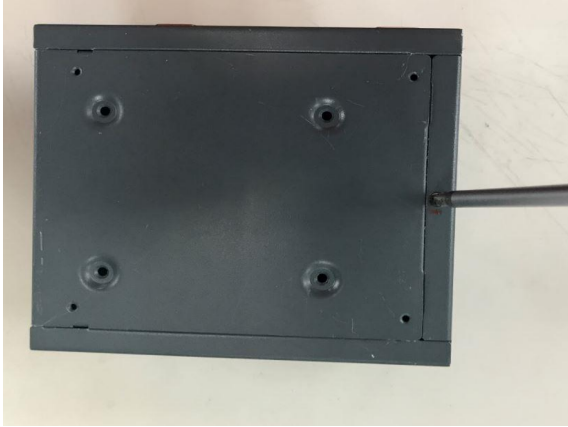

2. Place the DIMM onto the motherboard.



3. Glue the SINK onto the PAD.



4. Put the sink together and fasten them securely with screws.



5.



- Put the lid back on and fasten the screws securely..

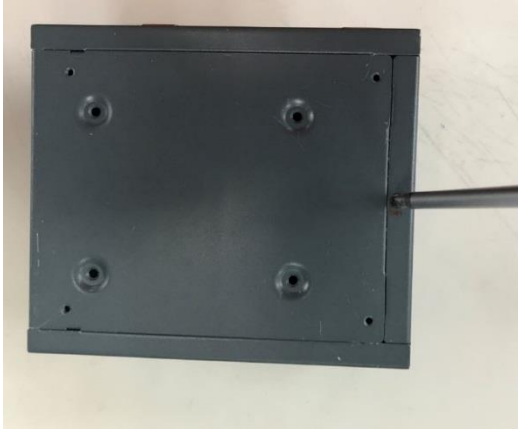

Chapter 3

AMI BIOS Setup

3.1 System Test and Initialization

These routines test and initialize board hardware. If the routines encounter an error during the tests, you will either hear a few short beeps or see an error message on the screen. There are two kinds of errors: fatal and non-fatal. The system can usually continue the boot up sequence with non-fatal errors.

System configuration verification

These routines check the current system configuration stored in the CMOS memory and BIOS NVRAM. If system configuration is not found or system configuration data error is detected, system will load optimized default and re-boot with this default system configuration automatically.

There are four situations in which you will need to setup system configuration:

1. You are starting your system for the first time
2. You have changed the hardware attached to your system
3. The system configuration is reset by Clear-CMOS jumper
4. The CMOS memory has lost power and the configuration information has been erased.

The ICS-6270 CMOS memory has an integral lithium battery backup for data retention. You have to replace the battery when it finally runs down.

Note: The Intel Apollo Lake platform only supports UEFI boot mode.

3.2 AMI BIOS Setup

AMI BIOS ROM has a built-in Setup program that allows users to modify the basic system configuration. This type of information is stored in battery-backed CMOS RAM and BIOS NVRAM so that it retains the Setup information when the power is turned off.

Entering Setup

Power on the computer and press or <Esc> immediately. This will allow you to enter Setup.

Main

Basic information and set Date & Time.

Advanced

Major feature configuration (e.g.: CPU, Super IO, Hardware Monitor, Digital I/O, etc.).

Chipset

Configuration for Chipset features.

Security

Set BIOS Administrator/User password.

Boot

Adjust Boot configuration/priorities.

Save & Exit

Save changes/restore defaults and exit system setup.

3.3 Setup Submenu: Main

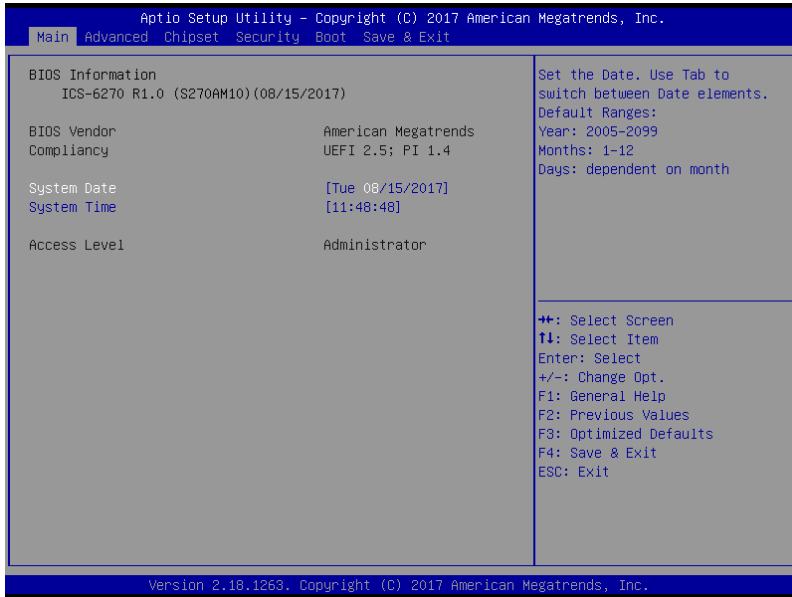

3.4 Setup Submenu: Advanced

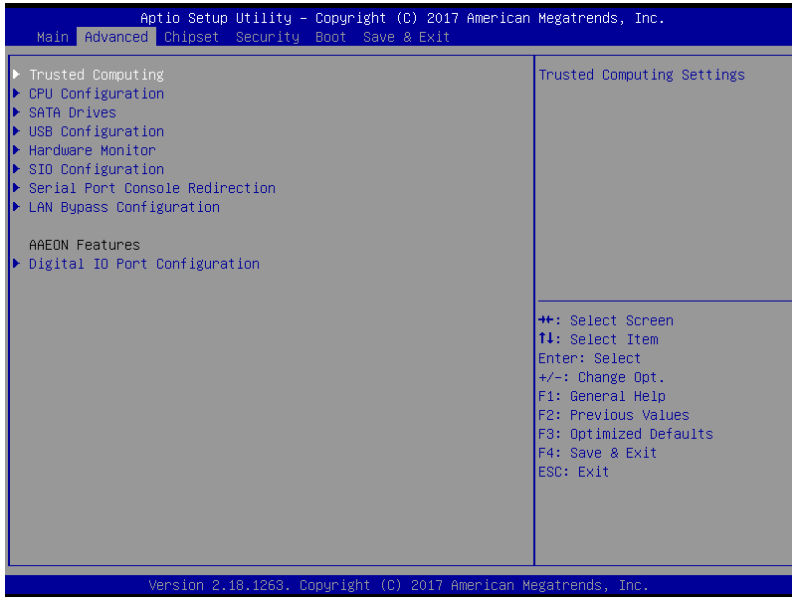

3.4.1 Advanced: Trusted Computing

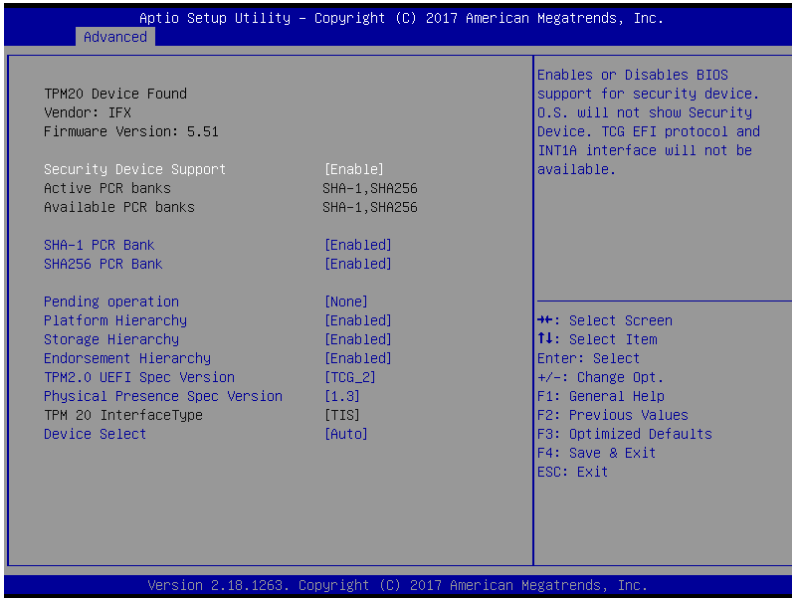

Options summary:

Security Device Support	Disabled
	Enabled
Enables or Disables BIOS support for security device. O.S. will not show Security Device. TCG EFI protocol and INT1A interface will not be available.	
SHA-1 PCR Bank	Disabled
	Enabled
Enable or Disable SHA-1 PCR Bank	
SHA256 PCR Bank	Disabled
	Enabled
Enable or Disable SHA256 PCR Bank	
Pending operation	None
	TPM Clear
Schedule an Operation for the Security Device. NOTE: Your Computer will reboot during restart in order to change State of Security Device.	
Platform Hierarchy	Disabled
	Enabled
Enable or Disable Platform Hierarchy	

Storage Hierarchy	Disabled
	Enabled
Enable or Disable Storage Hierarchy	
Endorsement Hierarchy	Disabled
	Enabled
Enable or Disable Endorsement Hierarchy	
TPM2.0 UEFI Spec Version	TCG_1_2
	TCG_2
Select the TCG2 Spec Version Support, TCG_1_2: the Compatible mode for Win8/Win10, TCG_2: Support new TCG2 protocol and event format for Win10 or later	
Physical Presence Spec Version	1.2
	1.3
Select to Tell O.S. to support PPI Spec Version 1.2 or 1.3. Note some HCK tests might not support 1.3.	
Device Select	TPM 1.2
	TPM 2.0
	Auto
TPM 1.2 will restrict support to TPM 1.2 devices, TPM 2.0 will restrict support to TPM 2.0 devices, Auto will support both with the default set to TPM 2.0 devices if not found, TPM 1.2 devices will be enumerated	

3.4.2 Advanced: CPU Configuration

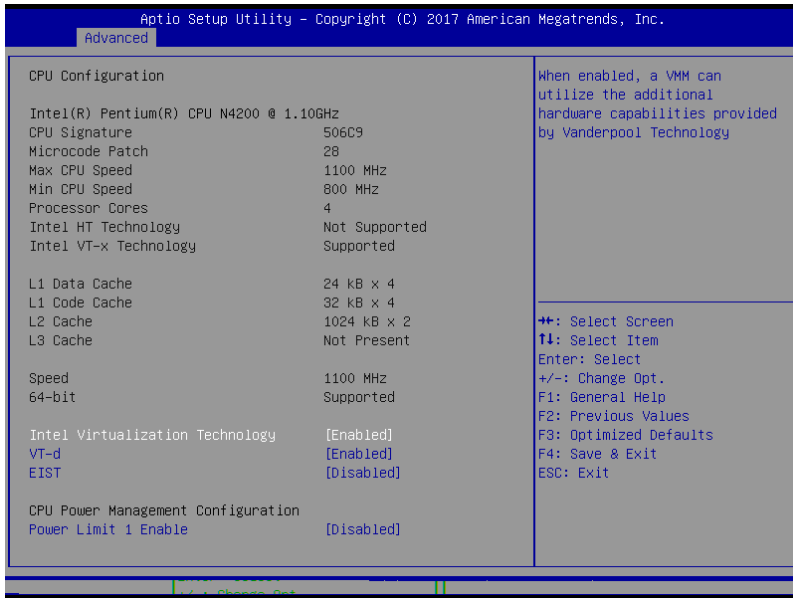

Options summary:

Intel Virtualization Technology	Disabled
	Enabled
When enabled, a VMM can utilize the additional hardware capabilities provided by Vanderpool Technology	
VT-d	Disabled
	Enabled
Enable/Disable CPU VT-d	
EIST	Disabled
	Enabled
Enable/Disable Intel SpeedStep	
Power Limit 1 Enable	Disabled
	Enabled
Enable/Disable Power Limit 1	

3.4.3 Advanced: SATA Drives

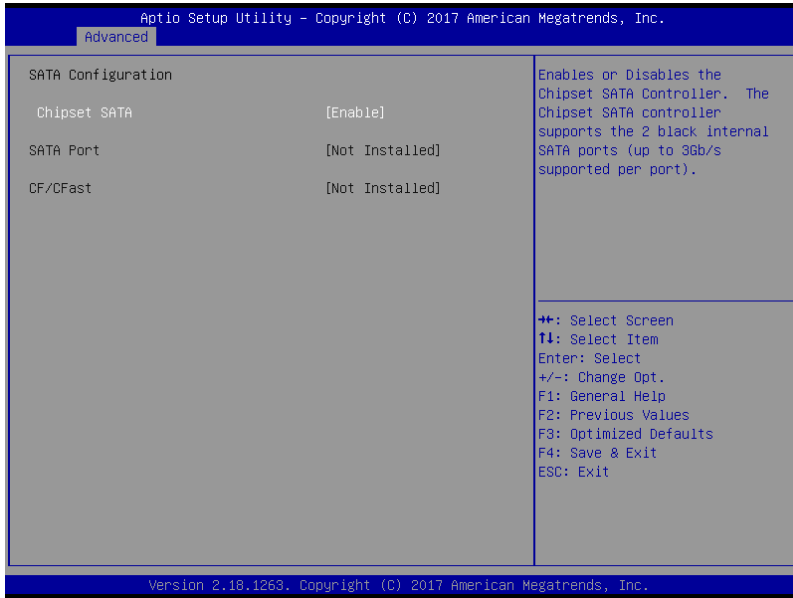

Options summary :

Chipset SATA	Disabled
	Enabled
Enables or Disables the Chipset SATA Controller. The Chipset SATA controller supports the 2 black internal SATA ports (up to 3Gb/s supported per port).	

3.4.4 Advanced: USB Configuration

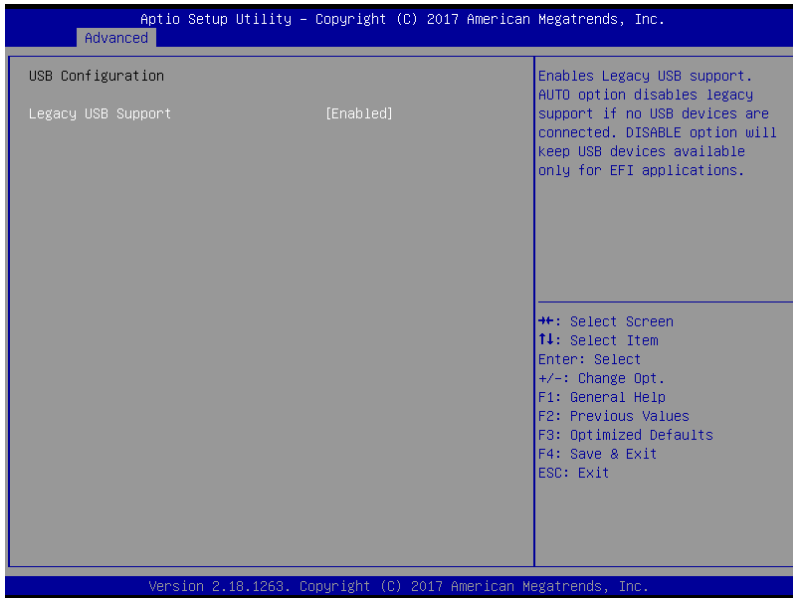

Options summary :

Legacy USB Support	Disabled
	Enabled
Enables Legacy USB support. AUTO option disables legacy support if no USB devices are connected. DISABLE option will keep USB devices available only for EFI applications.	

3.4.5 Advanced: Hardware Monitor

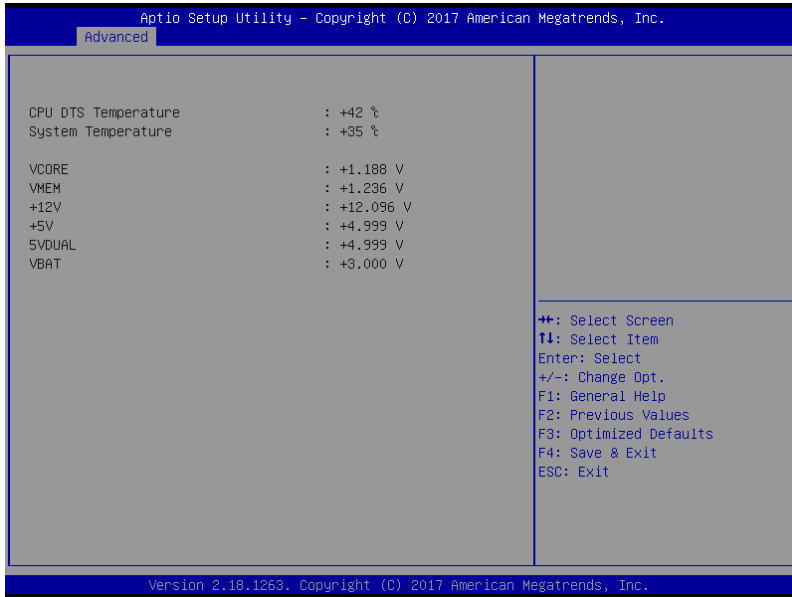

3.4.6 Advanced: SIO Configuration

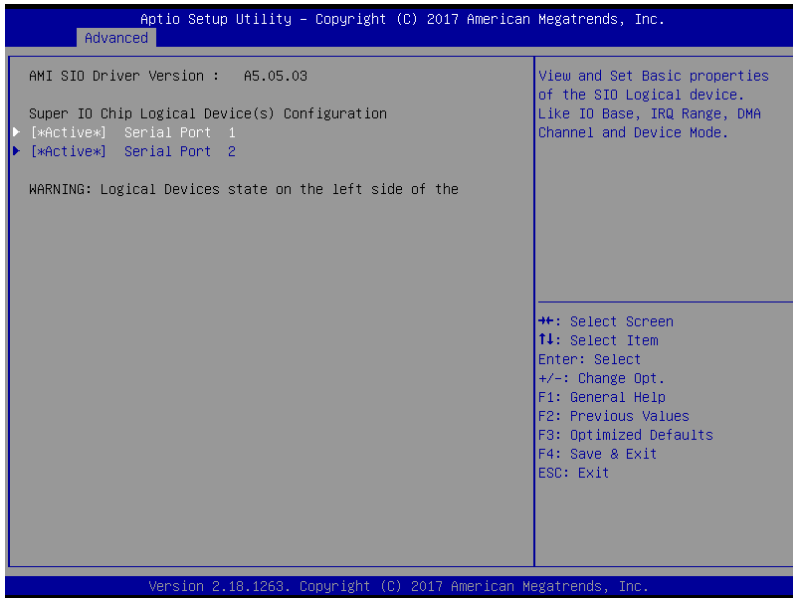

3.4.6.1 Serial Port 1 Configuration

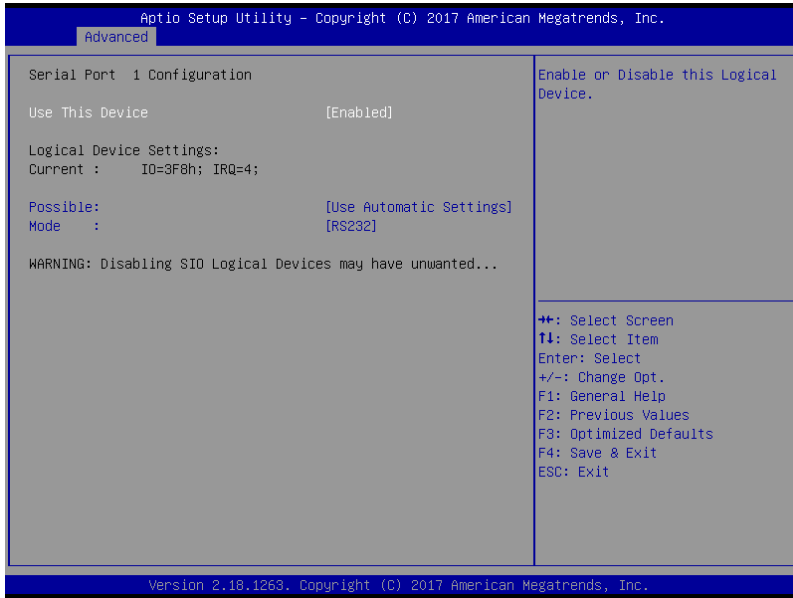

Options summary:

Use This Device	Disabled
	Enabled
Enable or Disable this Logical Device.	
Possible:	Use Automatic Settings
	IO=2F8h; IRQ=3;
	IO=3F8h; IRQ=4;
Allows user to change Device's Resource settings. New settings will be reflected on This Setup Page after System restarts.	
Mode:	RS232
	RS422
	RS485
UART RS232, 422, 485 selection	

3.4.6.2 Serial Port 2 Configuration

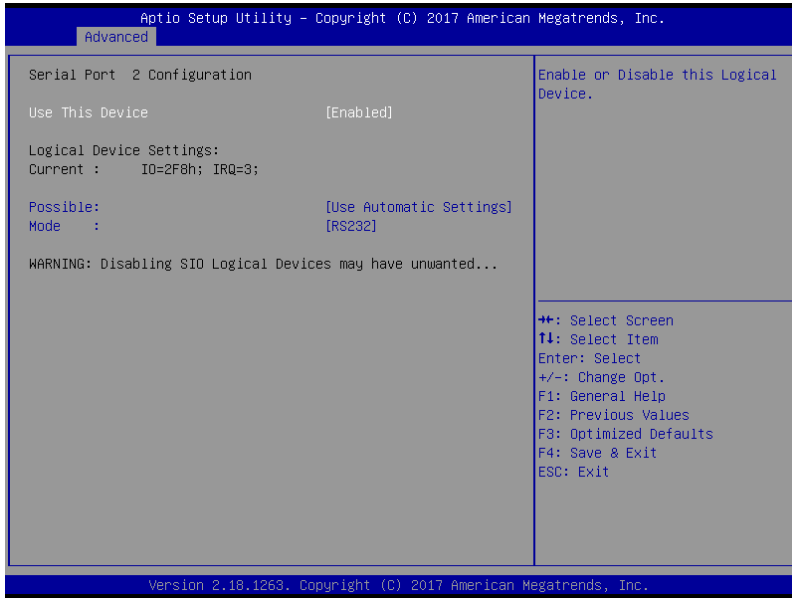

Options summary:

Use This Device	Disabled
	Enabled
Enable or Disable this Logical Device.	
Possible:	Use Automatic Settings
	IO=2F8h; IRQ=3;
	IO=3F8h; IRQ=4;
Allows user to change Device's Resource settings. New settings will be reflected on This Setup Page after System restarts.	
Mode:	RS232
	RS422
	RS485
UART RS232, 422, 485 selection	

3.4.7 Serial Port Console Redirection

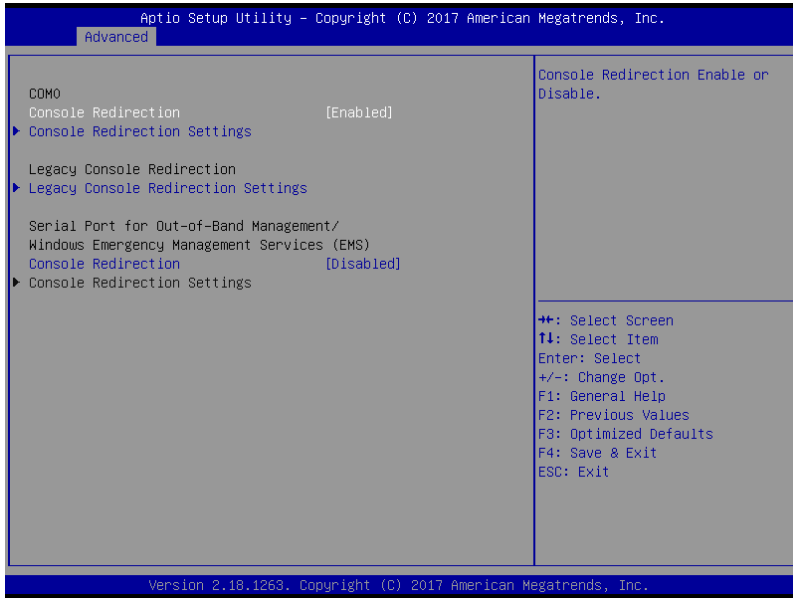

Options summary:

Console Redirection	Disabled
	Enabled
Console Redirection Enabled or Disabled.	

3.4.7.1 Console Redirection Settings

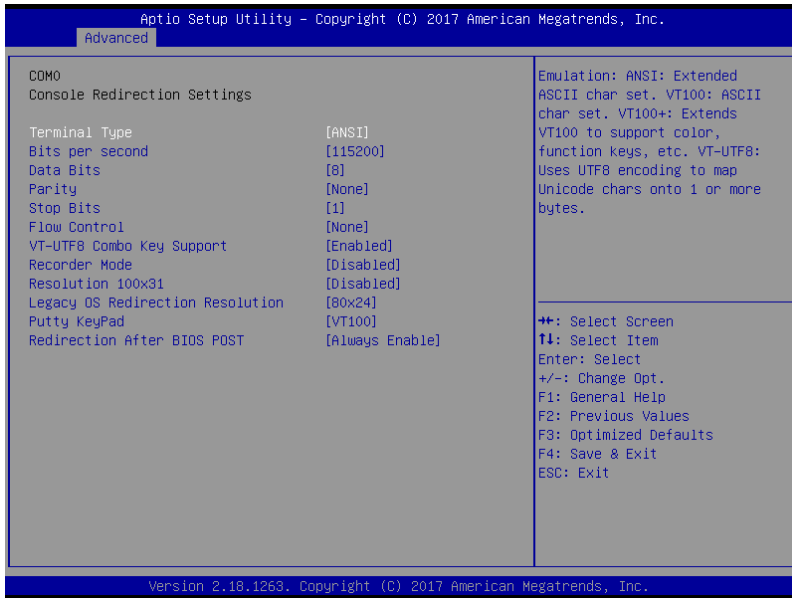

Options summary:

Terminal Type	VT100
	VT100+
	VT-UTF8
	ANSI
Emulation: ANSI: Extended ASCII char set. VT100: ASCII char set. VT100+: Extends VT100 to support color, function keys, etc. VT-UTF8: Uses UTF8 encoding to map Unicode chars onto 1 or more bytes.	
Bits per second	9600
	19200
	38400
	57600
	115200
Selects serial port transmission speed. The speed must be matched on the other side. Long or noisy lines may require lower speeds.	
Data Bits	7
	8
Data Bits	

Parity	None
	Even
	Odd
	Mark
	Space
A parity bit can be sent with the data bits to detect some transmission errors. Even: parity bit is 0 if the num of 1's in the data bits is even. Odd: parity bit is 0 if num of 1's in the data bits is odd. Mark: parity bit is always 1. Space: Parity bit is always 0. Mark and Space Parity do not allow for error detection.	
Stop Bits	1
	2
Stop bits indicate the end of a serial data packet. (A start bit indicates the beginning). The standard setting is 1 stop bit. Communication with slow devices may require more than 1 stop bit.	
Flow Control	None
	Hardware RTS/CTS
Flow control can prevent data loss from buffer overflow. When sending data, if the receiving buffers are full, a 'stop' signal can be sent to stop the data flow. Once the buffers are empty, a 'start' signal can be sent to re-start the flow. Hardware flow control uses two wires to send start/stop signals.	
VT-UTF8 Combo Key Support	Disabled
	Enabled
Enable VT-UTF8 Combination Key Support for ANSI/VT100 terminals	
Recorder Mode	Disabled
	Enabled
On this mode enabled only text will be send. This is to capture Terminal data.	
Resolution 100x31	Disabled
	Enabled
Enables or disables extended terminal resolution	
Legacy OS Redirection Resolution	80x24
	80x25
On Legacy OS, the Number of Rows and Columns supported redirection	
Putty KeyPad	VT100
	LINUX
	XTERMR6
	SCO
	ESCN
VT400	
Select FunctionKey and KeyPad on Putty.	
Redirection After BIOS POST	Always Enable
	BootLoader

The Setting Specify if BootLoader is selected than Legacy console redirection is disabled before booting to Legacy OS. Default value is Always Enable which means Legacy console Redirection is enabled for Legacy OS.

3.4.7.2 Legacy Console Redirection Settings

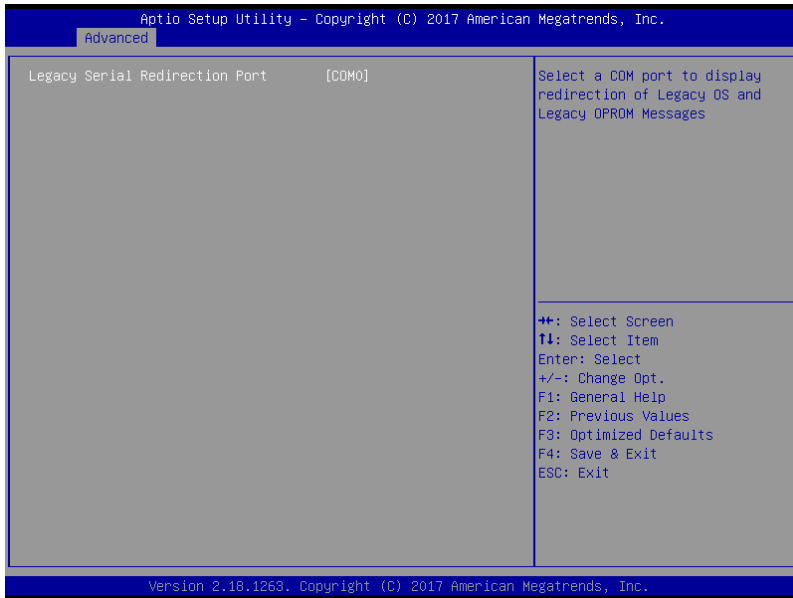

Legacy Serial Redirection Port	COM0
Select a COM port to display redirection of Legacy OS and Legacy OPRM Messages	

3.4.7.3 Serial Port for Out-of-Band Management/Windows Emergency Management Services(EMS)

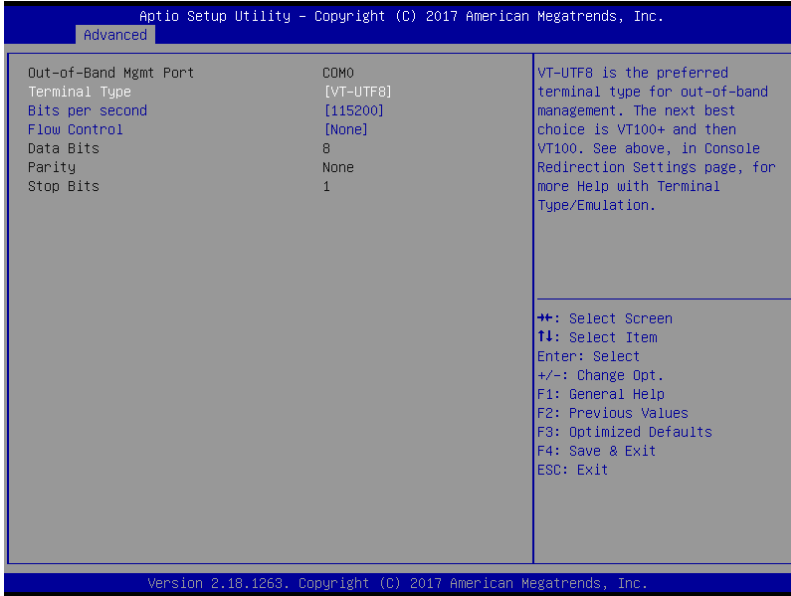

Options summary:

Terminal Type	VT100
	VT100+
	VT-UTF8
	ANSI
VT-UTF8 is the preferred terminal type for out-of-band management. The next best choice is VT100+ and then VT100. See above, in Console Redirection Settings page, for more Help with Terminal Type/Emulation.	
Bits per second	9600
	19200
	57600
	115200
Selects serial port transmission speed. The speed must be matched on the other side. Long or noisy lines may require lower speeds.	
Flow Control	None
	Hardware RTS/CTS
	Software Xon/Xoff

Flow control can prevent data loss from buffer overflow. When sending data, if the receiving buffers are full, a 'stop' signal can be sent to stop the data flow. Once the buffers are empty, a 'start' signal can be sent to re-start the flow. Hardware flow control uses two wires to send start/stop signals.

Data Bits	7
	8

Data Bits

Parity	None
	Even
	Odd
	Mark
	Space

A parity bit can be sent with the data bits to detect some transmission errors. Even: parity bit is 0 if the num of 1's in the data bits is even. Odd: parity bit is 0 if num of 1's in the data bits is odd. Mark: parity bit is always 1. Space: Parity bit is always 0. Mark and Space Parity do not allow for error detection.

Stop Bits	1
	2

Stop bits indicate the end of a serial data packet. (A start bit indicates the beginning). The standard setting is 1 stop bit. Communication with slow devices may require more than 1 stop bit.

3.4.8 LAN Bypass Configuration

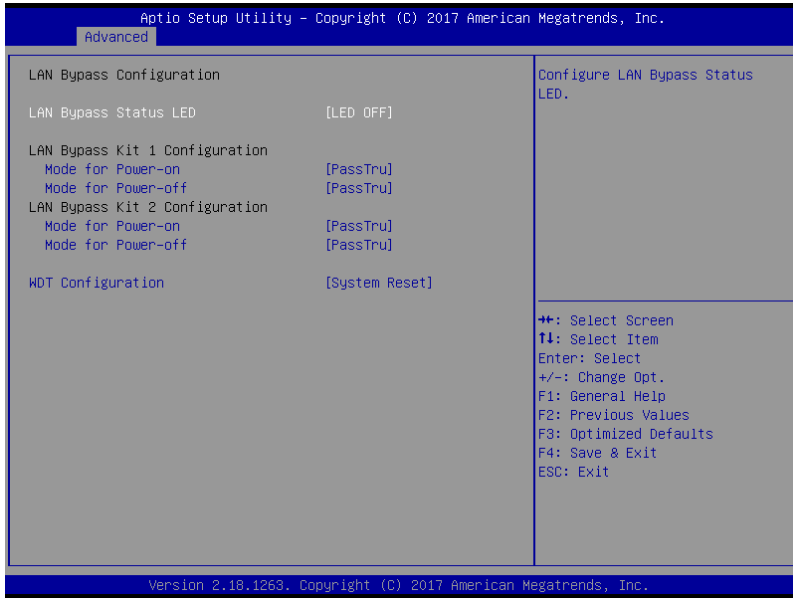

Options summary :

STATUS LED CTRL	LED OFF
	RED LED ON
	RED LED BLINK
	RED LED FAST BLINK
	GREEN LED ON
	GREEN LED BLINK
	GREEN LED FAST BLINK
Configure LAN Bypass Status LED.	
LAN kit Power ON	Bypass
	PassTru
Setting LAN kit function behavior when power on.(Bypass/Pass Through)	
LAN kit Power Off	Bypass
	PassTru
Setting LAN kit function behavior when power off.(Bypass/Pass Through)	

WDT configuration	Force Bypass
	SystemReset
Configure WDT behavior , System Reset Force Bypass	

3.4.9 Digital IO Port Configuration

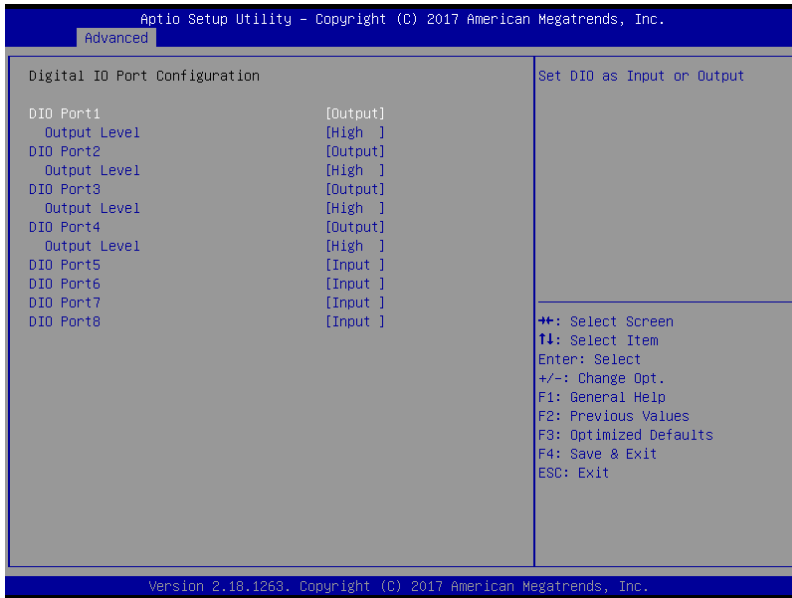

DIO_P#1~4	Input
	Output
Set DIO as Input or Output	
DIO_P#5~8	Input
	Output
Set DIO as Input or Output	
DIO_P#1~4 Direction	Low
	High
Set output level when DIO pin is output	

3.5 Setup submenu: Chipset

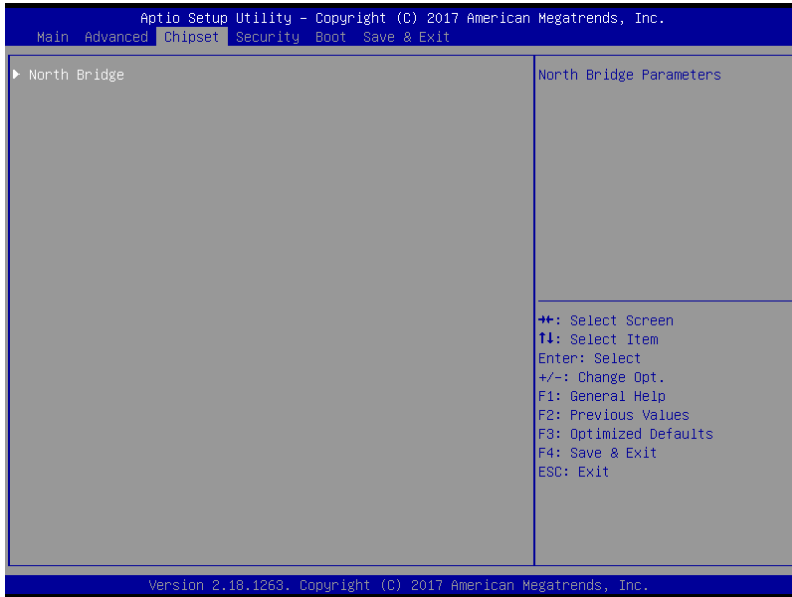

3.5.1 Chipset: North Bridge

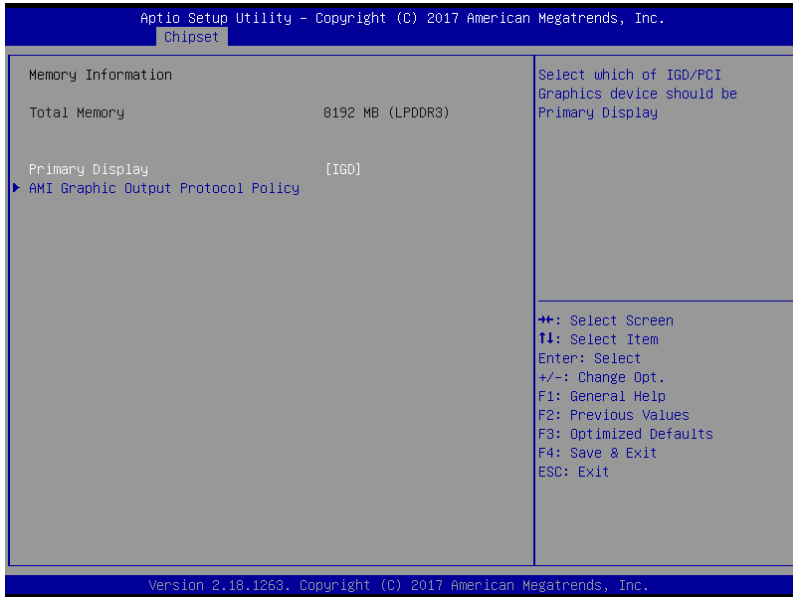

Options summary:

Primary Display	IGD
	PCIe
Select which of IGD/PCI Graphics device should be Primary Display	

3.5.1.1 North Bridge: AMI Graphic Output Protocol Policy

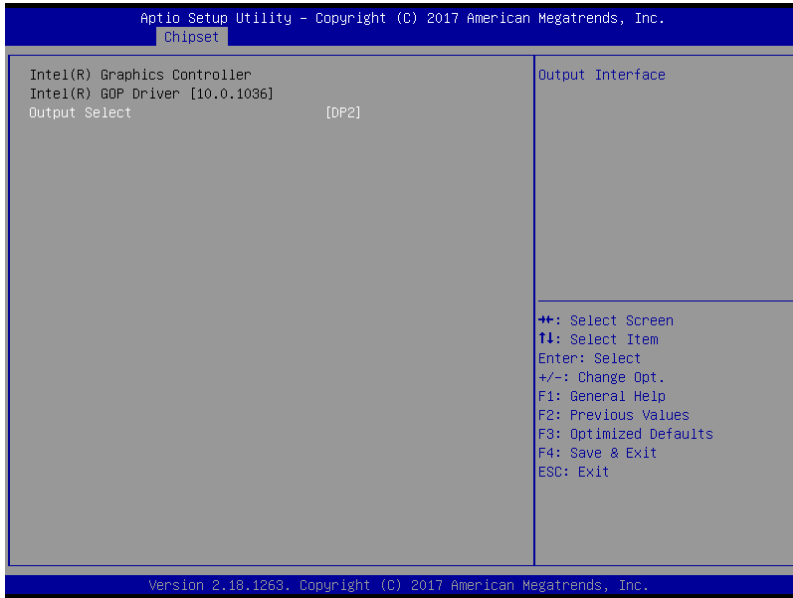

Options summary :

Output Select	DP2
Output Interface	

3.6 Setup submenu: Security

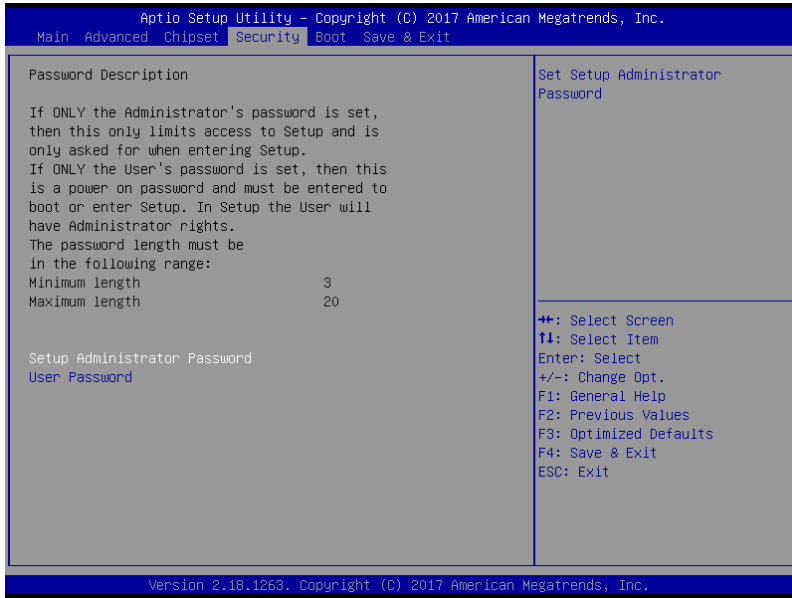

Change User/Supervisor Password

You can install a Supervisor password, and if you install a supervisor password, you can then install a user password. A user password does not provide access to many of the features in the Setup utility.

If you highlight these items and press Enter, a dialog box appears which lets you enter a password. You can enter no more than six letters or numbers. Press Enter after you have typed in the password. A second dialog box asks you to retype the password for confirmation. Press Enter after you have retyped it correctly. The password is required at boot time, or when the user enters the Setup utility.

Removing the Password

Highlight this item and type in the current password. At the next dialog box press Enter to disable password protection.

3.7 Setup submenu: Boot

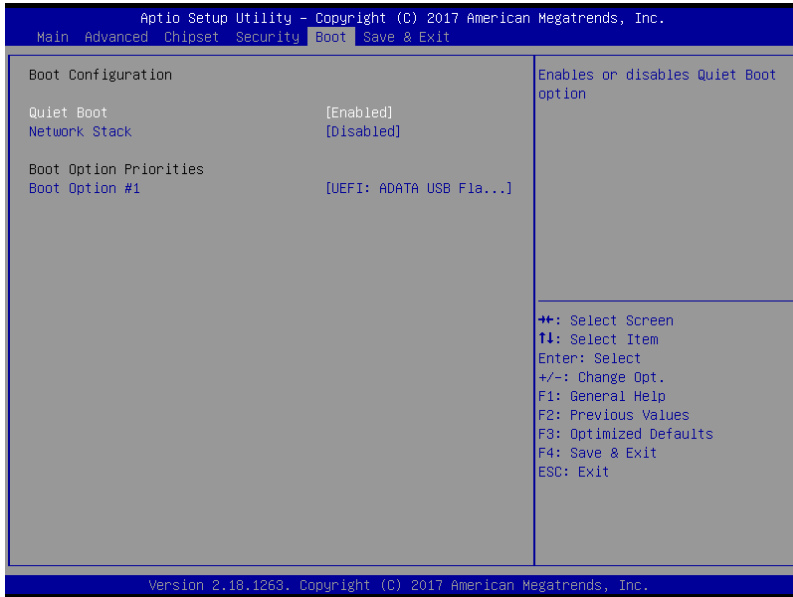

Options summary :

Quiet Boot	Disabled
	Enabled
Enables or disables Quiet Boot option.	
Network Stack	Disabled
	Enabled
Enable/Disable UEFI Network Stack	

3.8 Setup submenu: Exit

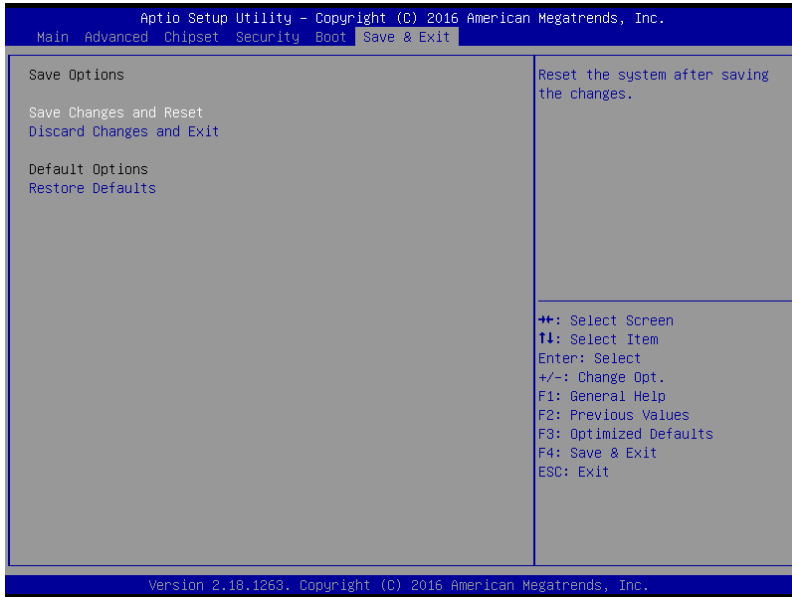

Chapter 4

Driver Installation

4.1 Driver Installation

Please download the driver from AAEON website. It contains all the drivers and utilities you need to setup your product. Follow the steps below to install the drivers.

<http://www.aaeon.com/en/p/desktop-network-appliance-ics-6270>

Step 1 – Install Chipset Drivers

1. Open the **Step 1 - Chipset** folder followed by the **SetupChipset.exe** file
2. Follow the instructions
3. Drivers will be installed automatically

Step 2 – Install Graphics Driver

1. Open the **Step 2 - Graphics** folder followed by **Setup.exe** file
2. Follow the instructions
3. Drivers will be installed automatically

Step 3 – Install TXE Driver

1. Open the **Step 4 - TXE** folder, followed by the **SetupTXE.exe** file
2. Follow the instructions
3. Drivers will be installed automatically

Step 4 – Install LAN Driver

1. Open the **STEP4 – LAN** folder and select your OS
2. Open the **.exe** file in the folder
3. Follow the instructions
4. Drivers will be installed automatically

Step 5 – Install Serial IO Driver

1. Open the **STEP5 – Serial IO** folder and select your OS

2. Open the **.exe** file in the folder
3. Follow the instructions
4. Drivers will be installed automatically

Appendix A

Watchdog Timer Programming

A.1 Watchdog Timer Initial Program

	Default Value	Note
Index	0x2E(Note1)	SIO MB PnP Mode Index Register 0x2E or 0x4E
Data	0x2F(Note2)	SIO MB PnP Mode Data Register 0x2F or 0x4F

	LDN	Register	BitNum	Value	Note
Timer Counter	0x07(Note3)	0x73(Note4)		(Note24)	Time of watchdog timer (0~255) This register is byte access
Counting Unit	0x07(Note5)	0x72(Note6)	7(Note7)	1(Note8)	Select time unit. 1: second 0: minute
Watchdog Enable (KRST)	0x07(Note9)	0x72(Note10)	6(Note11)	1(Note12)	0: Disable 1: Enable
Timeout Status	0x07(Note13)	0x71(Note14)	0(Note15)	1	1: Clear timeout status

```
*****
// SuperIO relative definition (Please reference to Table 1)
#define byte   SIOIndex   //This parameter is represented from Note1
#define byte   SIOData    //This parameter is represented from Note2
#define void   IOWriteByte(byte IOPort, byte Value);
#define byte   IOReadByte(byte IOPort);
// Watch Dog relative definition (Please reference to Table 2)
#define byte   TimerLDN   //This parameter is represented from Note3
#define byte   TimerReg   //This parameter is represented from Note4
#define byte   TimerVal   // This parameter is represented from Note24
#define byte   UnitLDN    //This parameter is represented from Note5
#define byte   UnitReg    //This parameter is represented from Note6
#define byte   UnitBit    //This parameter is represented from Note7
#define byte   UnitVal    //This parameter is represented from Note8
#define byte   EnableLDN  //This parameter is represented from Note9
#define byte   EnableReg  //This parameter is represented from Note10
#define byte   EnableBit  //This parameter is represented from Note11
#define byte   EnableVal  //This parameter is represented from Note12
#define byte   StatusLDN  // This parameter is represented from Note13
#define byte   StatusReg  // This parameter is represented from Note14
#define byte   StatusBit  // This parameter is represented from Note15
*****
```

```
*****  
VOID Main(){  
    // Procedure : AaeonWDTConfig  
    // (byte)Timer : Time of WDT timer.(0x00~0xFF)  
    // (boolean)Unit : Select time unit(0: second, 1: minute).  
    AaeonWDTConfig();  
  
    // Procedure : AaeonWDTEnable  
    // This procedure will enable the WDT counting.  
    AaeonWDTEnable();  
}  
*****
```

```
*****
// Procedure : AaeonWDTEnable
VOID  AaeonWDTEnable (){
    WDTEnableDisable(EnableLDN, EnableReg, EnableBit, 1);
}

// Procedure : AaeonWDTConfig
VOID  AaeonWDTConfig (){
    // Disable WDT counting
    WDTEnableDisable(EnableLDN, EnableReg, EnableBit, 0);
    // Clear Watchdog Timeout Status
    WDTClearTimeoutStatus();
    // WDT relative parameter setting
    WDTParameterSetting();
}

VOID  WDTEnableDisable(byte LDN, byte Register, byte BitNum, byte Value){
    SIOBitSet(LDN, Register, BitNum, Value);
}

VOID  WDTParameterSetting(){
    // Watchdog Timer counter setting
    SIOByteSet(TimerLDN, TimerReg, TimerVal);
    // WDT counting unit setting
    SIOBitSet(UnitLDN, UnitReg, UnitBit, UnitVal);
}

VOID  WDTClearTimeoutStatus(){
    SIOBitSet(StatusLDN, StatusReg, StatusBit, 1);
}
*****
```

```
*****
VOID SIOEnterMBPnPMode0{
    Switch(SIOIndex){
        Case 0x2E:
            IOWriteByte(SIOIndex, 0x87);
            IOWriteByte(SIOIndex, 0x01);
            IOWriteByte(SIOIndex, 0x55);
            IOWriteByte(SIOIndex, 0x55);
            Break;
        Case 0x4E:
            IOWriteByte(SIOIndex, 0x87);
            IOWriteByte(SIOIndex, 0x01);
            IOWriteByte(SIOIndex, 0x55);
            IOWriteByte(SIOIndex, 0xAA);
            Break;
    }
}

VOID SIOExitMBPnPMode0{
    IOWriteByte(SIOIndex, 0x02);
    IOWriteByte(SIOData, 0x02);
}

VOID SIOSelectLDN(byte LDN){
    IOWriteByte(SIOIndex, 0x07); // SIO LDN Register Offset = 0x07
    IOWriteByte(SIOData, LDN);
}
*****
```

```
*****
```

```
VOID SIOBitSet(byte LDN, byte Register, byte BitNum, byte Value){  
    Byte TmpValue;
```

```
    SIOEnterMBPnPMode();  
    SIOSelectLDN(byte LDN);  
    IOWriteByte(SIOIndex, Register);  
    TmpValue = IOReadByte(SIOData);  
    TmpValue &= ~(1 << BitNum);  
    TmpValue |= (Value << BitNum);  
    IOWriteByte(SIOData, TmpValue);  
    SIOExitMBPnPMode();
```

```
}
```

```
VOID SIOByteSet(byte LDN, byte Register, byte Value){
```

```
    SIOEnterMBPnPMode();  
    SIOSelectLDN(LDN);  
    IOWriteByte(SIOIndex, Register);  
    IOWriteByte(SIOData, Value);  
    SIOExitMBPnPMode();
```

```
}
```









```
*****
```

Appendix B

I/O Information

B.1 I/O Address Map

















































▼	📁	Input/output (IO)
📁	[0000000000000000 - 000000000000006F]	PCI Express Root Complex
📁	[0000000000000020 - 0000000000000021]	Programmable interrupt controller
📁	[0000000000000024 - 0000000000000025]	Programmable interrupt controller
📁	[0000000000000028 - 0000000000000029]	Programmable interrupt controller
📁	[000000000000002C - 000000000000002D]	Programmable interrupt controller
📁	[000000000000002E - 000000000000002F]	Motherboard resources
📁	[0000000000000030 - 0000000000000031]	Programmable interrupt controller
📁	[0000000000000034 - 0000000000000035]	Programmable interrupt controller
📁	[0000000000000038 - 0000000000000039]	Programmable interrupt controller
📁	[000000000000003C - 000000000000003D]	Programmable interrupt controller
📁	[0000000000000040 - 0000000000000043]	System timer
📁	[000000000000004E - 000000000000004F]	Motherboard resources
📁	[0000000000000050 - 0000000000000053]	System timer
📁	[0000000000000060 - 0000000000000060]	Standard PS/2 Keyboard
📁	[0000000000000061 - 0000000000000061]	Motherboard resources
📁	[0000000000000063 - 0000000000000063]	Motherboard resources
📁	[0000000000000064 - 0000000000000064]	Standard PS/2 Keyboard
📁	[0000000000000065 - 0000000000000065]	Motherboard resources
📁	[0000000000000067 - 0000000000000067]	Motherboard resources
📁	[0000000000000070 - 0000000000000070]	Motherboard resources
📁	[0000000000000070 - 0000000000000077]	System CMOS/real time clock
📁	[0000000000000078 - 00000000000000CF]	PCI Express Root Complex
📁	[0000000000000080 - 000000000000008F]	Motherboard resources
📁	[0000000000000092 - 0000000000000092]	Motherboard resources
📁	[00000000000000A0 - 00000000000000A1]	Programmable interrupt controller
📁	[00000000000000A4 - 00000000000000A5]	Programmable interrupt controller
📁	[00000000000000A8 - 00000000000000A9]	Programmable interrupt controller
📁	[00000000000000AC - 00000000000000AD]	Programmable interrupt controller
📁	[00000000000000B0 - 00000000000000B1]	Programmable interrupt controller
📁	[00000000000000B2 - 00000000000000B3]	Motherboard resources
📁	[00000000000000B4 - 00000000000000B5]	Programmable interrupt controller
📁	[00000000000000B8 - 00000000000000B9]	Programmable interrupt controller
📁	[00000000000000BC - 00000000000000BD]	Programmable interrupt controller
📁	[00000000000002F8 - 00000000000002FF]	Communications Port (COM2)
📁	[00000000000003F8 - 00000000000003FF]	Communications Port (COM1)
📁	[0000000000000400 - 000000000000047F]	Motherboard resources
📁	[00000000000004D0 - 00000000000004D1]	Programmable interrupt controller
📁	[0000000000000500 - 00000000000005FE]	Motherboard resources
📁	[0000000000000680 - 000000000000069F]	Motherboard resources
📁	[0000000000000A00 - 0000000000000A2F]	Motherboard resources
📁	[0000000000000A30 - 0000000000000A3F]	Motherboard resources
📁	[0000000000000A40 - 0000000000000A4F]	Motherboard resources
📁	[0000000000000D00 - 0000000000000FFF]	PCI Express Root Complex
📁	[0000000000000900 - 00000000000009FF]	PCI-to-PCI Bridge
📁	[0000000000000900 - 0000000000000BFF]	Intel(R) Celeron(R)/Pentium(R) Processor PCI Express Root Port - 5ADB
📁	[0000000000000900 - 0000000000000BFF]	PCI-to-PCI Bridge
📁	[0000000000000A00 - 0000000000000AFF]	PCI-to-PCI Bridge
📁	[0000000000000B00 - 0000000000000BFF]	PCI-to-PCI Bridge















































-  [000000000000C000 - 000000000000CFFF] Intel(R) Celeron(R)/Pentium(R) Processor PCI Express Root Port - 5ADA
-  [000000000000D000 - 000000000000DFFF] Intel(R) Celeron(R)/Pentium(R) Processor PCI Express Root Port - 5AD9
-  [000000000000E000 - 000000000000EFFF] Intel(R) Celeron(R)/Pentium(R) Processor PCI Express Root Port - 5AD8
-  [000000000000F000 - 000000000000F03F] Intel(R) HD Graphics
-  [000000000000F040 - 000000000000F05F] Intel(R) Celeron(R)/Pentium(R) Processor SMBUS - 5AD4
-  [000000000000F060 - 000000000000F07F] Standard SATA AHCI Controller
-  [000000000000F080 - 000000000000F083] Standard SATA AHCI Controller
-  [000000000000F090 - 000000000000F097] Standard SATA AHCI Controller



















































B.2 Memory Address Map



















































Address Range	Device Name
[000000007B800001 - 000000007BFFFFFF]	PCI Express Root Complex
[000000007C000001 - 000000007CFFFFFF]	PCI Express Root Complex
[0000000080000000 - 0000000080FFFFFF]	Intel(R) HD Graphics
[0000000080000000 - 00000000CFFFFFFF]	PCI Express Root Complex
[0000000090000000 - 0000000090FFFFFF]	Intel(R) HD Graphics
[0000000091000000 - 00000000910FFFFFFF]	High Definition Audio Controller
[0000000091100000 - 00000000913FFFFFFF]	PCI-to-PCI Bridge
[0000000091100000 - 00000000917FFFFFFF]	Intel(R) Celeron(R)/Pentium(R) Processor PCI Express Root Port - 5ADB
[0000000091100000 - 00000000917FFFFFFF]	PCI-to-PCI Bridge
[00000000912FC000 - 00000000912FFFFFFF]	Intel(R) I210 Gigabit Fiber Network Connection
[0000000091300000 - 00000000913FFFFFFF]	Intel(R) I210 Gigabit Fiber Network Connection
[0000000091400000 - 00000000916FFFFFFF]	PCI-to-PCI Bridge
[00000000915FC000 - 00000000915FFFFFFF]	Intel(R) I210 Gigabit Fiber Network Connection #2
[0000000091600000 - 00000000916FFFFFFF]	Intel(R) I210 Gigabit Fiber Network Connection #2
[0000000091700000 - 00000000917FFFFFFF]	PCI-to-PCI Bridge
[00000000917DC000 - 00000000917DFFFFFF]	Intel(R) I211 Gigabit Network Connection #4
[00000000917E0000 - 00000000917FFFFFFF]	Intel(R) I211 Gigabit Network Connection #4
[000000009180C000 - 00000000918FFFFFFF]	Intel(R) Celeron(R)/Pentium(R) Processor PCI Express Root Port - 5ADA
[00000000918DC000 - 00000000918DFFFFFF]	Intel(R) I211 Gigabit Network Connection
[00000000918E0000 - 00000000918FFFFFFF]	Intel(R) I211 Gigabit Network Connection
[0000000091900000 - 00000000919FFFFFFF]	Intel(R) Celeron(R)/Pentium(R) Processor PCI Express Root Port - 5AD9
[00000000919DC000 - 00000000919DFFFFFF]	Intel(R) I211 Gigabit Network Connection #3
[00000000919E0000 - 00000000919FFFFFFF]	Intel(R) I211 Gigabit Network Connection #3
[0000000091A00000 - 0000000091AFFFFFFF]	Intel(R) Celeron(R)/Pentium(R) Processor PCI Express Root Port - 5AD8
[0000000091ADC000 - 0000000091ADFFFFFF]	Intel(R) I211 Gigabit Network Connection #2
[0000000091AE0000 - 0000000091AFFFFFFF]	Intel(R) I211 Gigabit Network Connection #2
[0000000091B00000 - 0000000091B0FFFFFF]	Intel(R) USB 3.0 eXtensible Host Controller - 1.0 (Microsoft)
[0000000091B10000 - 0000000091B13FFF]	High Definition Audio Controller
[0000000091B14000 - 0000000091B15FFF]	Standard SATA AHCI Controller
[0000000091B16000 - 0000000091B160FF]	Intel(R) Celeron(R)/Pentium(R) Processor SMBUS - 5AD4
[0000000091B17000 - 0000000091B177FF]	Standard SATA AHCI Controller
[0000000091B18000 - 0000000091B180FF]	Standard SATA AHCI Controller
[0000000091B1B000 - 0000000091B1BFFF]	Intel(R) Trusted Execution Engine Interface
[00000000D0C00000 - 00000000D0C00653]	Intel(R) Serial IO GPIO Host Controller - INT3452
[00000000D0C40000 - 00000000D0C4076B]	Intel(R) Serial IO GPIO Host Controller - INT3452
[00000000D0C50000 - 00000000D0C5076B]	Intel(R) Serial IO GPIO Host Controller - INT3452
[00000000D0C70000 - 00000000D0C70673]	Intel(R) Serial IO GPIO Host Controller - INT3452
[00000000E0000000 - 00000000EFFFFFFF]	Motherboard resources
[00000000E0000000 - 00000000EFFFFFFF]	PCI Express Root Complex
[00000000FEA00000 - 00000000FEAFFFFFFF]	Motherboard resources
[00000000FED00000 - 00000000FED003FF]	High precision event timer
[00000000FED01000 - 00000000FED01FFF]	Motherboard resources
[00000000FED03000 - 00000000FED03FFF]	Motherboard resources
[00000000FED06000 - 00000000FED06FFF]	Motherboard resources
[00000000FED08000 - 00000000FED09FFF]	Motherboard resources
[00000000FED1C000 - 00000000FED1CFFF]	Motherboard resources
[00000000FED40000 - 00000000FED44FFF]	Trusted Platform Module 2.0
[00000000FED80000 - 00000000FEDBFFFF]	Motherboard resources
[00000000FEE00000 - 00000000FEEFFFFFFF]	Motherboard resources



















































B.3 IRQ Mapping Chart



















































▼		Interrupt request (IRQ)	
		(ISA) 0x00000000 (00)	System timer
		(ISA) 0x00000001 (01)	Standard PS/2 Keyboard
		(ISA) 0x00000003 (03)	Communications Port (COM2)
		(ISA) 0x00000004 (04)	Communications Port (COM1)
		(ISA) 0x00000008 (08)	High precision event timer
		(ISA) 0x0000000C (12)	PS/2 Compatible Mouse
		(ISA) 0x0000000E (14)	Intel(R) Serial IO GPIO Host Controller - INT3452
		(ISA) 0x0000000E (14)	Intel(R) Serial IO GPIO Host Controller - INT3452
		(ISA) 0x0000000E (14)	Intel(R) Serial IO GPIO Host Controller - INT3452
		(ISA) 0x0000000E (14)	Intel(R) Serial IO GPIO Host Controller - INT3452
		(ISA) 0x00000036 (54)	Microsoft ACPI-Compliant System
		(ISA) 0x00000037 (55)	Microsoft ACPI-Compliant System
		(ISA) 0x00000038 (56)	Microsoft ACPI-Compliant System
		(ISA) 0x00000039 (57)	Microsoft ACPI-Compliant System
		(ISA) 0x0000003A (58)	Microsoft ACPI-Compliant System
		(ISA) 0x0000003B (59)	Microsoft ACPI-Compliant System
		(ISA) 0x0000003C (60)	Microsoft ACPI-Compliant System
		(ISA) 0x0000003D (61)	Microsoft ACPI-Compliant System
		(ISA) 0x0000003E (62)	Microsoft ACPI-Compliant System
		(ISA) 0x0000003F (63)	Microsoft ACPI-Compliant System
		(ISA) 0x00000040 (64)	Microsoft ACPI-Compliant System
		(ISA) 0x00000041 (65)	Microsoft ACPI-Compliant System
		(ISA) 0x00000042 (66)	Microsoft ACPI-Compliant System
		(ISA) 0x00000043 (67)	Microsoft ACPI-Compliant System
		(ISA) 0x00000044 (68)	Microsoft ACPI-Compliant System
		(ISA) 0x00000045 (69)	Microsoft ACPI-Compliant System
		(ISA) 0x00000046 (70)	Microsoft ACPI-Compliant System
		(ISA) 0x00000047 (71)	Microsoft ACPI-Compliant System
		(ISA) 0x00000048 (72)	Microsoft ACPI-Compliant System
		(ISA) 0x00000049 (73)	Microsoft ACPI-Compliant System
		(ISA) 0x0000004A (74)	Microsoft ACPI-Compliant System
		(ISA) 0x0000004B (75)	Microsoft ACPI-Compliant System
		(ISA) 0x0000004C (76)	Microsoft ACPI-Compliant System
		(ISA) 0x0000004D (77)	Microsoft ACPI-Compliant System
		(ISA) 0x0000004E (78)	Microsoft ACPI-Compliant System
		(ISA) 0x0000004F (79)	Microsoft ACPI-Compliant System
		(ISA) 0x00000050 (80)	Microsoft ACPI-Compliant System
		(ISA) 0x00000051 (81)	Microsoft ACPI-Compliant System
		(ISA) 0x00000052 (82)	Microsoft ACPI-Compliant System
		(ISA) 0x00000053 (83)	Microsoft ACPI-Compliant System
		(ISA) 0x00000054 (84)	Microsoft ACPI-Compliant System
		(ISA) 0x00000055 (85)	Microsoft ACPI-Compliant System
		(ISA) 0x00000056 (86)	Microsoft ACPI-Compliant System
		(ISA) 0x00000057 (87)	Microsoft ACPI-Compliant System
		(ISA) 0x00000058 (88)	Microsoft ACPI-Compliant System
		(ISA) 0x00000059 (89)	Microsoft ACPI-Compliant System
		(ISA) 0x0000005A (90)	Microsoft ACPI-Compliant System
		(ISA) 0x0000005B (91)	Microsoft ACPI-Compliant System



















































 (ISA) 0x0000005C (92)	Microsoft ACPI-Compliant System
 (ISA) 0x0000005D (93)	Microsoft ACPI-Compliant System
 (ISA) 0x0000005E (94)	Microsoft ACPI-Compliant System
 (ISA) 0x0000005F (95)	Microsoft ACPI-Compliant System
 (ISA) 0x00000060 (96)	Microsoft ACPI-Compliant System
 (ISA) 0x00000061 (97)	Microsoft ACPI-Compliant System
 (ISA) 0x00000062 (98)	Microsoft ACPI-Compliant System
 (ISA) 0x00000063 (99)	Microsoft ACPI-Compliant System
 (ISA) 0x00000064 (100)	Microsoft ACPI-Compliant System
 (ISA) 0x00000065 (101)	Microsoft ACPI-Compliant System
 (ISA) 0x00000066 (102)	Microsoft ACPI-Compliant System
 (ISA) 0x00000067 (103)	Microsoft ACPI-Compliant System
 (ISA) 0x00000068 (104)	Microsoft ACPI-Compliant System
 (ISA) 0x00000069 (105)	Microsoft ACPI-Compliant System
 (ISA) 0x0000006A (106)	Microsoft ACPI-Compliant System
 (ISA) 0x0000006B (107)	Microsoft ACPI-Compliant System
 (ISA) 0x0000006C (108)	Microsoft ACPI-Compliant System
 (ISA) 0x0000006D (109)	Microsoft ACPI-Compliant System
 (ISA) 0x0000006E (110)	Microsoft ACPI-Compliant System
 (ISA) 0x0000006F (111)	Microsoft ACPI-Compliant System
 (ISA) 0x00000070 (112)	Microsoft ACPI-Compliant System
 (ISA) 0x00000071 (113)	Microsoft ACPI-Compliant System
 (ISA) 0x00000072 (114)	Microsoft ACPI-Compliant System
 (ISA) 0x00000073 (115)	Microsoft ACPI-Compliant System
 (ISA) 0x00000074 (116)	Microsoft ACPI-Compliant System
 (ISA) 0x00000075 (117)	Microsoft ACPI-Compliant System
 (ISA) 0x00000076 (118)	Microsoft ACPI-Compliant System
 (ISA) 0x00000077 (119)	Microsoft ACPI-Compliant System
 (ISA) 0x00000078 (120)	Microsoft ACPI-Compliant System
 (ISA) 0x00000079 (121)	Microsoft ACPI-Compliant System
 (ISA) 0x0000007A (122)	Microsoft ACPI-Compliant System
 (ISA) 0x0000007B (123)	Microsoft ACPI-Compliant System
 (ISA) 0x0000007C (124)	Microsoft ACPI-Compliant System
 (ISA) 0x0000007D (125)	Microsoft ACPI-Compliant System
 (ISA) 0x0000007E (126)	Microsoft ACPI-Compliant System
 (ISA) 0x0000007F (127)	Microsoft ACPI-Compliant System
 (ISA) 0x00000080 (128)	Microsoft ACPI-Compliant System
 (ISA) 0x00000081 (129)	Microsoft ACPI-Compliant System
 (ISA) 0x00000082 (130)	Microsoft ACPI-Compliant System
 (ISA) 0x00000083 (131)	Microsoft ACPI-Compliant System
 (ISA) 0x00000084 (132)	Microsoft ACPI-Compliant System
 (ISA) 0x00000085 (133)	Microsoft ACPI-Compliant System
 (ISA) 0x00000086 (134)	Microsoft ACPI-Compliant System
 (ISA) 0x00000087 (135)	Microsoft ACPI-Compliant System
 (ISA) 0x00000088 (136)	Microsoft ACPI-Compliant System
 (ISA) 0x00000089 (137)	Microsoft ACPI-Compliant System
(ISA) 0x0000008A (138)	Microsoft ACPI-Compliant System
(ISA) 0x0000008B (139)	Microsoft ACPI-Compliant System
(ISA) 0x0000008C (140)	Microsoft ACPI-Compliant System
(ISA) 0x0000008D (141)	Microsoft ACPI-Compliant System
(ISA) 0x0000008E (142)	Microsoft ACPI-Compliant System



















































 (ISA) 0x0000008F (143)	Microsoft ACPI-Compliant System
 (ISA) 0x00000090 (144)	Microsoft ACPI-Compliant System
 (ISA) 0x00000091 (145)	Microsoft ACPI-Compliant System
 (ISA) 0x00000092 (146)	Microsoft ACPI-Compliant System
 (ISA) 0x00000093 (147)	Microsoft ACPI-Compliant System
 (ISA) 0x00000094 (148)	Microsoft ACPI-Compliant System
 (ISA) 0x00000095 (149)	Microsoft ACPI-Compliant System
 (ISA) 0x00000096 (150)	Microsoft ACPI-Compliant System
 (ISA) 0x00000097 (151)	Microsoft ACPI-Compliant System
 (ISA) 0x00000098 (152)	Microsoft ACPI-Compliant System
 (ISA) 0x00000099 (153)	Microsoft ACPI-Compliant System
 (ISA) 0x0000009A (154)	Microsoft ACPI-Compliant System
 (ISA) 0x0000009B (155)	Microsoft ACPI-Compliant System
 (ISA) 0x0000009C (156)	Microsoft ACPI-Compliant System
 (ISA) 0x0000009D (157)	Microsoft ACPI-Compliant System
 (ISA) 0x0000009E (158)	Microsoft ACPI-Compliant System
 (ISA) 0x0000009F (159)	Microsoft ACPI-Compliant System
 (ISA) 0x000000A0 (160)	Microsoft ACPI-Compliant System
 (ISA) 0x000000A1 (161)	Microsoft ACPI-Compliant System
 (ISA) 0x000000A2 (162)	Microsoft ACPI-Compliant System
 (ISA) 0x000000A3 (163)	Microsoft ACPI-Compliant System
 (ISA) 0x000000A4 (164)	Microsoft ACPI-Compliant System
 (ISA) 0x000000A5 (165)	Microsoft ACPI-Compliant System
 (ISA) 0x000000A6 (166)	Microsoft ACPI-Compliant System
 (ISA) 0x000000A7 (167)	Microsoft ACPI-Compliant System
 (ISA) 0x000000A8 (168)	Microsoft ACPI-Compliant System
 (ISA) 0x000000A9 (169)	Microsoft ACPI-Compliant System
 (ISA) 0x000000AA (170)	Microsoft ACPI-Compliant System
 (ISA) 0x000000AB (171)	Microsoft ACPI-Compliant System
 (ISA) 0x000000AC (172)	Microsoft ACPI-Compliant System
 (ISA) 0x000000AD (173)	Microsoft ACPI-Compliant System
 (ISA) 0x000000AE (174)	Microsoft ACPI-Compliant System
 (ISA) 0x000000AF (175)	Microsoft ACPI-Compliant System
 (ISA) 0x000000B0 (176)	Microsoft ACPI-Compliant System
 (ISA) 0x000000B1 (177)	Microsoft ACPI-Compliant System
 (ISA) 0x000000B2 (178)	Microsoft ACPI-Compliant System
 (ISA) 0x000000B3 (179)	Microsoft ACPI-Compliant System
 (ISA) 0x000000B4 (180)	Microsoft ACPI-Compliant System
 (ISA) 0x000000B5 (181)	Microsoft ACPI-Compliant System
 (ISA) 0x000000B6 (182)	Microsoft ACPI-Compliant System
 (ISA) 0x000000B7 (183)	Microsoft ACPI-Compliant System
 (ISA) 0x000000B8 (184)	Microsoft ACPI-Compliant System
 (ISA) 0x000000B9 (185)	Microsoft ACPI-Compliant System
 (ISA) 0x000000BA (186)	Microsoft ACPI-Compliant System
 (ISA) 0x000000BB (187)	Microsoft ACPI-Compliant System
 (ISA) 0x000000BC (188)	Microsoft ACPI-Compliant System
 (ISA) 0x000000BD (189)	Microsoft ACPI-Compliant System
 (ISA) 0x000000BE (190)	Microsoft ACPI-Compliant System
 (ISA) 0x000000BF (191)	Microsoft ACPI-Compliant System
 (ISA) 0x000000C0 (192)	Microsoft ACPI-Compliant System
 (ISA) 0x000000C1 (193)	Microsoft ACPI-Compliant System













































 (ISA) 0x000000C2 (194)	Microsoft ACPI-Compliant System
 (ISA) 0x000000C3 (195)	Microsoft ACPI-Compliant System
 (ISA) 0x000000C4 (196)	Microsoft ACPI-Compliant System
 (ISA) 0x000000C5 (197)	Microsoft ACPI-Compliant System
 (ISA) 0x000000C6 (198)	Microsoft ACPI-Compliant System
 (ISA) 0x000000C7 (199)	Microsoft ACPI-Compliant System
 (ISA) 0x000000C8 (200)	Microsoft ACPI-Compliant System
 (ISA) 0x000000C9 (201)	Microsoft ACPI-Compliant System
 (ISA) 0x000000CA (202)	Microsoft ACPI-Compliant System
 (ISA) 0x000000CB (203)	Microsoft ACPI-Compliant System
 (ISA) 0x000000CC (204)	Microsoft ACPI-Compliant System
 (ISA) 0x00000100 (256)	Microsoft ACPI-Compliant System
 (ISA) 0x00000101 (257)	Microsoft ACPI-Compliant System
 (ISA) 0x00000102 (258)	Microsoft ACPI-Compliant System
 (ISA) 0x00000103 (259)	Microsoft ACPI-Compliant System
 (ISA) 0x00000104 (260)	Microsoft ACPI-Compliant System
 (ISA) 0x00000105 (261)	Microsoft ACPI-Compliant System
 (ISA) 0x00000106 (262)	Microsoft ACPI-Compliant System
 (ISA) 0x00000107 (263)	Microsoft ACPI-Compliant System
 (ISA) 0x00000108 (264)	Microsoft ACPI-Compliant System
 (ISA) 0x00000109 (265)	Microsoft ACPI-Compliant System
 (ISA) 0x0000010A (266)	Microsoft ACPI-Compliant System
 (ISA) 0x0000010B (267)	Microsoft ACPI-Compliant System
 (ISA) 0x0000010C (268)	Microsoft ACPI-Compliant System
 (ISA) 0x0000010D (269)	Microsoft ACPI-Compliant System
 (ISA) 0x0000010E (270)	Microsoft ACPI-Compliant System
 (ISA) 0x0000010F (271)	Microsoft ACPI-Compliant System
 (ISA) 0x00000110 (272)	Microsoft ACPI-Compliant System
 (ISA) 0x00000111 (273)	Microsoft ACPI-Compliant System
 (ISA) 0x00000112 (274)	Microsoft ACPI-Compliant System
 (ISA) 0x00000113 (275)	Microsoft ACPI-Compliant System
 (ISA) 0x00000114 (276)	Microsoft ACPI-Compliant System
 (ISA) 0x00000115 (277)	Microsoft ACPI-Compliant System
 (ISA) 0x00000116 (278)	Microsoft ACPI-Compliant System
 (ISA) 0x00000117 (279)	Microsoft ACPI-Compliant System
 (ISA) 0x00000118 (280)	Microsoft ACPI-Compliant System
 (ISA) 0x00000119 (281)	Microsoft ACPI-Compliant System
 (ISA) 0x0000011A (282)	Microsoft ACPI-Compliant System
 (ISA) 0x0000011B (283)	Microsoft ACPI-Compliant System
 (ISA) 0x0000011C (284)	Microsoft ACPI-Compliant System
 (ISA) 0x0000011D (285)	Microsoft ACPI-Compliant System
 (ISA) 0x0000011E (286)	Microsoft ACPI-Compliant System
 (ISA) 0x0000011F (287)	Microsoft ACPI-Compliant System
 (ISA) 0x00000120 (288)	Microsoft ACPI-Compliant System
 (ISA) 0x00000121 (289)	Microsoft ACPI-Compliant System
 (ISA) 0x00000122 (290)	Microsoft ACPI-Compliant System
 (ISA) 0x00000123 (291)	Microsoft ACPI-Compliant System
 (ISA) 0x00000124 (292)	Microsoft ACPI-Compliant System
 (ISA) 0x00000125 (293)	Microsoft ACPI-Compliant System
 (ISA) 0x00000126 (294)	Microsoft ACPI-Compliant System
 (ISA) 0x00000127 (295)	Microsoft ACPI-Compliant System

 (ISA) 0x00000128 (296)	Microsoft ACPI-Compliant System
 (ISA) 0x00000129 (297)	Microsoft ACPI-Compliant System
 (ISA) 0x0000012A (298)	Microsoft ACPI-Compliant System
 (ISA) 0x0000012B (299)	Microsoft ACPI-Compliant System
 (ISA) 0x0000012C (300)	Microsoft ACPI-Compliant System
 (ISA) 0x0000012D (301)	Microsoft ACPI-Compliant System
 (ISA) 0x0000012E (302)	Microsoft ACPI-Compliant System
 (ISA) 0x0000012F (303)	Microsoft ACPI-Compliant System
 (ISA) 0x00000130 (304)	Microsoft ACPI-Compliant System
 (ISA) 0x00000131 (305)	Microsoft ACPI-Compliant System
 (ISA) 0x00000132 (306)	Microsoft ACPI-Compliant System
 (ISA) 0x00000133 (307)	Microsoft ACPI-Compliant System
 (ISA) 0x00000134 (308)	Microsoft ACPI-Compliant System
 (ISA) 0x00000135 (309)	Microsoft ACPI-Compliant System
 (ISA) 0x00000136 (310)	Microsoft ACPI-Compliant System
 (ISA) 0x00000137 (311)	Microsoft ACPI-Compliant System
 (ISA) 0x00000138 (312)	Microsoft ACPI-Compliant System
 (ISA) 0x00000139 (313)	Microsoft ACPI-Compliant System
 (ISA) 0x0000013A (314)	Microsoft ACPI-Compliant System
 (ISA) 0x0000013B (315)	Microsoft ACPI-Compliant System
 (ISA) 0x0000013C (316)	Microsoft ACPI-Compliant System
 (ISA) 0x0000013D (317)	Microsoft ACPI-Compliant System
 (ISA) 0x0000013E (318)	Microsoft ACPI-Compliant System
 (ISA) 0x0000013F (319)	Microsoft ACPI-Compliant System
 (ISA) 0x00000140 (320)	Microsoft ACPI-Compliant System
 (ISA) 0x00000141 (321)	Microsoft ACPI-Compliant System
 (ISA) 0x00000142 (322)	Microsoft ACPI-Compliant System
 (ISA) 0x00000143 (323)	Microsoft ACPI-Compliant System
 (ISA) 0x00000144 (324)	Microsoft ACPI-Compliant System
 (ISA) 0x00000145 (325)	Microsoft ACPI-Compliant System
 (ISA) 0x00000146 (326)	Microsoft ACPI-Compliant System
 (ISA) 0x00000147 (327)	Microsoft ACPI-Compliant System
 (ISA) 0x00000148 (328)	Microsoft ACPI-Compliant System
 (ISA) 0x00000149 (329)	Microsoft ACPI-Compliant System
 (ISA) 0x0000014A (330)	Microsoft ACPI-Compliant System
 (ISA) 0x0000014B (331)	Microsoft ACPI-Compliant System
 (ISA) 0x0000014C (332)	Microsoft ACPI-Compliant System
 (ISA) 0x0000014D (333)	Microsoft ACPI-Compliant System
 (ISA) 0x0000014E (334)	Microsoft ACPI-Compliant System
 (ISA) 0x0000014F (335)	Microsoft ACPI-Compliant System
 (ISA) 0x00000150 (336)	Microsoft ACPI-Compliant System
 (ISA) 0x00000151 (337)	Microsoft ACPI-Compliant System
 (ISA) 0x00000152 (338)	Microsoft ACPI-Compliant System
 (ISA) 0x00000153 (339)	Microsoft ACPI-Compliant System
 (ISA) 0x00000154 (340)	Microsoft ACPI-Compliant System
 (ISA) 0x00000155 (341)	Microsoft ACPI-Compliant System
 (ISA) 0x00000156 (342)	Microsoft ACPI-Compliant System
 (ISA) 0x00000157 (343)	Microsoft ACPI-Compliant System
 (ISA) 0x00000158 (344)	Microsoft ACPI-Compliant System
 (ISA) 0x00000159 (345)	Microsoft ACPI-Compliant System
 (ISA) 0x0000015A (346)	Microsoft ACPI-Compliant System

	(ISA) 0x0000015B (347)	Microsoft ACPI-Compliant System
	(ISA) 0x0000015C (348)	Microsoft ACPI-Compliant System
	(ISA) 0x0000015D (349)	Microsoft ACPI-Compliant System
	(ISA) 0x0000015E (350)	Microsoft ACPI-Compliant System
	(ISA) 0x0000015F (351)	Microsoft ACPI-Compliant System
	(ISA) 0x00000160 (352)	Microsoft ACPI-Compliant System
	(ISA) 0x00000161 (353)	Microsoft ACPI-Compliant System
	(ISA) 0x00000162 (354)	Microsoft ACPI-Compliant System
	(ISA) 0x00000163 (355)	Microsoft ACPI-Compliant System
	(ISA) 0x00000164 (356)	Microsoft ACPI-Compliant System
	(ISA) 0x00000165 (357)	Microsoft ACPI-Compliant System
	(ISA) 0x00000166 (358)	Microsoft ACPI-Compliant System
	(ISA) 0x00000167 (359)	Microsoft ACPI-Compliant System
	(ISA) 0x00000168 (360)	Microsoft ACPI-Compliant System
	(ISA) 0x00000169 (361)	Microsoft ACPI-Compliant System
	(ISA) 0x0000016A (362)	Microsoft ACPI-Compliant System
	(ISA) 0x0000016B (363)	Microsoft ACPI-Compliant System
	(ISA) 0x0000016C (364)	Microsoft ACPI-Compliant System
	(ISA) 0x0000016D (365)	Microsoft ACPI-Compliant System
	(ISA) 0x0000016E (366)	Microsoft ACPI-Compliant System
	(ISA) 0x0000016F (367)	Microsoft ACPI-Compliant System
	(ISA) 0x00000170 (368)	Microsoft ACPI-Compliant System
	(ISA) 0x00000171 (369)	Microsoft ACPI-Compliant System
	(ISA) 0x00000172 (370)	Microsoft ACPI-Compliant System
	(ISA) 0x00000173 (371)	Microsoft ACPI-Compliant System
	(ISA) 0x00000174 (372)	Microsoft ACPI-Compliant System
	(ISA) 0x00000175 (373)	Microsoft ACPI-Compliant System
	(ISA) 0x00000176 (374)	Microsoft ACPI-Compliant System
	(ISA) 0x00000177 (375)	Microsoft ACPI-Compliant System
	(ISA) 0x00000178 (376)	Microsoft ACPI-Compliant System
	(ISA) 0x00000179 (377)	Microsoft ACPI-Compliant System
	(ISA) 0x0000017A (378)	Microsoft ACPI-Compliant System
	(ISA) 0x0000017B (379)	Microsoft ACPI-Compliant System
	(ISA) 0x0000017C (380)	Microsoft ACPI-Compliant System
	(ISA) 0x0000017D (381)	Microsoft ACPI-Compliant System
	(ISA) 0x0000017E (382)	Microsoft ACPI-Compliant System
	(ISA) 0x0000017F (383)	Microsoft ACPI-Compliant System
	(ISA) 0x00000180 (384)	Microsoft ACPI-Compliant System
	(ISA) 0x00000181 (385)	Microsoft ACPI-Compliant System
	(ISA) 0x00000182 (386)	Microsoft ACPI-Compliant System
	(ISA) 0x00000183 (387)	Microsoft ACPI-Compliant System
	(ISA) 0x00000184 (388)	Microsoft ACPI-Compliant System
	(ISA) 0x00000185 (389)	Microsoft ACPI-Compliant System
	(ISA) 0x00000186 (390)	Microsoft ACPI-Compliant System
	(ISA) 0x00000187 (391)	Microsoft ACPI-Compliant System
	(ISA) 0x00000188 (392)	Microsoft ACPI-Compliant System
	(ISA) 0x00000189 (393)	Microsoft ACPI-Compliant System
	(ISA) 0x0000018A (394)	Microsoft ACPI-Compliant System
	(ISA) 0x0000018B (395)	Microsoft ACPI-Compliant System
	(ISA) 0x0000018C (396)	Microsoft ACPI-Compliant System
	(ISA) 0x0000018D (397)	Microsoft ACPI-Compliant System

 (ISA) 0x0000018E (398)	Microsoft ACPI-Compliant System
 (ISA) 0x0000018F (399)	Microsoft ACPI-Compliant System
 (ISA) 0x00000190 (400)	Microsoft ACPI-Compliant System
 (ISA) 0x00000191 (401)	Microsoft ACPI-Compliant System
 (ISA) 0x00000192 (402)	Microsoft ACPI-Compliant System
 (ISA) 0x00000193 (403)	Microsoft ACPI-Compliant System
 (ISA) 0x00000194 (404)	Microsoft ACPI-Compliant System
 (ISA) 0x00000195 (405)	Microsoft ACPI-Compliant System
 (ISA) 0x00000196 (406)	Microsoft ACPI-Compliant System
 (ISA) 0x00000197 (407)	Microsoft ACPI-Compliant System
 (ISA) 0x00000198 (408)	Microsoft ACPI-Compliant System
 (ISA) 0x00000199 (409)	Microsoft ACPI-Compliant System
 (ISA) 0x0000019A (410)	Microsoft ACPI-Compliant System
 (ISA) 0x0000019B (411)	Microsoft ACPI-Compliant System
 (ISA) 0x0000019C (412)	Microsoft ACPI-Compliant System
 (ISA) 0x0000019D (413)	Microsoft ACPI-Compliant System
 (ISA) 0x0000019E (414)	Microsoft ACPI-Compliant System
 (ISA) 0x0000019F (415)	Microsoft ACPI-Compliant System
 (ISA) 0x000001A0 (416)	Microsoft ACPI-Compliant System
 (ISA) 0x000001A1 (417)	Microsoft ACPI-Compliant System
 (ISA) 0x000001A2 (418)	Microsoft ACPI-Compliant System
 (ISA) 0x000001A3 (419)	Microsoft ACPI-Compliant System
 (ISA) 0x000001A4 (420)	Microsoft ACPI-Compliant System
 (ISA) 0x000001A5 (421)	Microsoft ACPI-Compliant System
 (ISA) 0x000001A6 (422)	Microsoft ACPI-Compliant System
 (ISA) 0x000001A7 (423)	Microsoft ACPI-Compliant System
 (ISA) 0x000001A8 (424)	Microsoft ACPI-Compliant System
 (ISA) 0x000001A9 (425)	Microsoft ACPI-Compliant System
 (ISA) 0x000001AA (426)	Microsoft ACPI-Compliant System
 (ISA) 0x000001AB (427)	Microsoft ACPI-Compliant System
 (ISA) 0x000001AC (428)	Microsoft ACPI-Compliant System
 (ISA) 0x000001AD (429)	Microsoft ACPI-Compliant System
 (ISA) 0x000001AE (430)	Microsoft ACPI-Compliant System
 (ISA) 0x000001AF (431)	Microsoft ACPI-Compliant System
 (ISA) 0x000001B0 (432)	Microsoft ACPI-Compliant System
 (ISA) 0x000001B1 (433)	Microsoft ACPI-Compliant System
 (ISA) 0x000001B2 (434)	Microsoft ACPI-Compliant System
 (ISA) 0x000001B3 (435)	Microsoft ACPI-Compliant System
 (ISA) 0x000001B4 (436)	Microsoft ACPI-Compliant System
 (ISA) 0x000001B5 (437)	Microsoft ACPI-Compliant System
 (ISA) 0x000001B6 (438)	Microsoft ACPI-Compliant System
 (ISA) 0x000001B7 (439)	Microsoft ACPI-Compliant System
 (ISA) 0x000001B8 (440)	Microsoft ACPI-Compliant System
 (ISA) 0x000001B9 (441)	Microsoft ACPI-Compliant System
 (ISA) 0x000001BA (442)	Microsoft ACPI-Compliant System
 (ISA) 0x000001BB (443)	Microsoft ACPI-Compliant System
 (ISA) 0x000001BC (444)	Microsoft ACPI-Compliant System
 (ISA) 0x000001BD (445)	Microsoft ACPI-Compliant System
 (ISA) 0x000001BE (446)	Microsoft ACPI-Compliant System
 (ISA) 0x000001BF (447)	Microsoft ACPI-Compliant System
 (ISA) 0x000001C0 (448)	Microsoft ACPI-Compliant System

 (ISA) 0x000001C1 (449)	Microsoft ACPI-Compliant System
 (ISA) 0x000001C2 (450)	Microsoft ACPI-Compliant System
 (ISA) 0x000001C3 (451)	Microsoft ACPI-Compliant System
 (ISA) 0x000001C4 (452)	Microsoft ACPI-Compliant System
 (ISA) 0x000001C5 (453)	Microsoft ACPI-Compliant System
 (ISA) 0x000001C6 (454)	Microsoft ACPI-Compliant System
 (ISA) 0x000001C7 (455)	Microsoft ACPI-Compliant System
 (ISA) 0x000001C8 (456)	Microsoft ACPI-Compliant System
 (ISA) 0x000001C9 (457)	Microsoft ACPI-Compliant System
 (ISA) 0x000001CA (458)	Microsoft ACPI-Compliant System
 (ISA) 0x000001CB (459)	Microsoft ACPI-Compliant System
 (ISA) 0x000001CC (460)	Microsoft ACPI-Compliant System
 (ISA) 0x000001CD (461)	Microsoft ACPI-Compliant System
 (ISA) 0x000001CE (462)	Microsoft ACPI-Compliant System
 (ISA) 0x000001CF (463)	Microsoft ACPI-Compliant System
 (ISA) 0x000001D0 (464)	Microsoft ACPI-Compliant System
 (ISA) 0x000001D1 (465)	Microsoft ACPI-Compliant System
 (ISA) 0x000001D2 (466)	Microsoft ACPI-Compliant System
 (ISA) 0x000001D3 (467)	Microsoft ACPI-Compliant System
 (ISA) 0x000001D4 (468)	Microsoft ACPI-Compliant System
 (ISA) 0x000001D5 (469)	Microsoft ACPI-Compliant System
 (ISA) 0x000001D6 (470)	Microsoft ACPI-Compliant System
 (ISA) 0x000001D7 (471)	Microsoft ACPI-Compliant System
 (ISA) 0x000001D8 (472)	Microsoft ACPI-Compliant System
 (ISA) 0x000001D9 (473)	Microsoft ACPI-Compliant System
 (ISA) 0x000001DA (474)	Microsoft ACPI-Compliant System
 (ISA) 0x000001DB (475)	Microsoft ACPI-Compliant System
 (ISA) 0x000001DC (476)	Microsoft ACPI-Compliant System
 (ISA) 0x000001DD (477)	Microsoft ACPI-Compliant System
 (ISA) 0x000001DE (478)	Microsoft ACPI-Compliant System
 (ISA) 0x000001DF (479)	Microsoft ACPI-Compliant System
 (ISA) 0x000001E0 (480)	Microsoft ACPI-Compliant System
 (ISA) 0x000001E1 (481)	Microsoft ACPI-Compliant System
 (ISA) 0x000001E2 (482)	Microsoft ACPI-Compliant System
 (ISA) 0x000001E3 (483)	Microsoft ACPI-Compliant System
 (ISA) 0x000001E4 (484)	Microsoft ACPI-Compliant System
 (ISA) 0x000001E5 (485)	Microsoft ACPI-Compliant System
 (ISA) 0x000001E6 (486)	Microsoft ACPI-Compliant System
 (ISA) 0x000001E7 (487)	Microsoft ACPI-Compliant System
 (ISA) 0x000001E8 (488)	Microsoft ACPI-Compliant System
 (ISA) 0x000001E9 (489)	Microsoft ACPI-Compliant System
 (ISA) 0x000001EA (490)	Microsoft ACPI-Compliant System
 (ISA) 0x000001EB (491)	Microsoft ACPI-Compliant System
 (ISA) 0x000001EC (492)	Microsoft ACPI-Compliant System
 (ISA) 0x000001ED (493)	Microsoft ACPI-Compliant System
 (ISA) 0x000001EE (494)	Microsoft ACPI-Compliant System
 (ISA) 0x000001EF (495)	Microsoft ACPI-Compliant System
 (ISA) 0x000001F0 (496)	Microsoft ACPI-Compliant System
 (ISA) 0x000001F1 (497)	Microsoft ACPI-Compliant System
 (ISA) 0x000001F2 (498)	Microsoft ACPI-Compliant System
 (ISA) 0x000001F3 (499)	Microsoft ACPI-Compliant System

	(ISA) 0x000001F4 (500)	Microsoft ACPI-Compliant System
	(ISA) 0x000001F5 (501)	Microsoft ACPI-Compliant System
	(ISA) 0x000001F6 (502)	Microsoft ACPI-Compliant System
	(ISA) 0x000001F7 (503)	Microsoft ACPI-Compliant System
	(ISA) 0x000001F8 (504)	Microsoft ACPI-Compliant System
	(ISA) 0x000001F9 (505)	Microsoft ACPI-Compliant System
	(ISA) 0x000001FA (506)	Microsoft ACPI-Compliant System
	(ISA) 0x000001FB (507)	Microsoft ACPI-Compliant System
	(ISA) 0x000001FC (508)	Microsoft ACPI-Compliant System
	(ISA) 0x000001FD (509)	Microsoft ACPI-Compliant System
	(ISA) 0x000001FE (510)	Microsoft ACPI-Compliant System
	(ISA) 0x000001FF (511)	Microsoft ACPI-Compliant System
	(PCI) 0x00000019 (25)	High Definition Audio Controller
	(PCI) 0xFFFFFDF (-33)	Intel(R) I210 Gigabit Fiber Network Connection #2
	(PCI) 0xFFFFFE0 (-32)	Intel(R) I210 Gigabit Fiber Network Connection #2
	(PCI) 0xFFFFFE1 (-31)	Intel(R) I210 Gigabit Fiber Network Connection #2
	(PCI) 0xFFFFFE2 (-30)	Intel(R) I210 Gigabit Fiber Network Connection #2
	(PCI) 0xFFFFFE3 (-29)	Intel(R) I210 Gigabit Fiber Network Connection #2
	(PCI) 0xFFFFFE4 (-28)	Intel(R) I210 Gigabit Fiber Network Connection #2
	(PCI) 0xFFFFFE5 (-27)	Intel(R) I211 Gigabit Network Connection #4
	(PCI) 0xFFFFFE6 (-26)	Intel(R) I211 Gigabit Network Connection #4
	(PCI) 0xFFFFFE7 (-25)	Intel(R) I211 Gigabit Network Connection #4
	(PCI) 0xFFFFFE8 (-24)	Intel(R) I211 Gigabit Network Connection #4
	(PCI) 0xFFFFFE9 (-23)	Intel(R) I211 Gigabit Network Connection
	(PCI) 0xFFFFFEA (-22)	Intel(R) I211 Gigabit Network Connection
	(PCI) 0xFFFFFEB (-21)	Intel(R) I211 Gigabit Network Connection
	(PCI) 0xFFFFFEC (-20)	Intel(R) I211 Gigabit Network Connection
	(PCI) 0xFFFFFED (-19)	Intel(R) I211 Gigabit Network Connection #3
	(PCI) 0xFFFFFEE (-18)	Intel(R) I211 Gigabit Network Connection #3
	(PCI) 0xFFFFFEF (-17)	Intel(R) I211 Gigabit Network Connection #3
	(PCI) 0xFFFFFFF0 (-16)	Intel(R) I211 Gigabit Network Connection #3
	(PCI) 0xFFFFFFF1 (-15)	Intel(R) I211 Gigabit Network Connection #2
	(PCI) 0xFFFFFFF2 (-14)	Intel(R) I211 Gigabit Network Connection #2
	(PCI) 0xFFFFFFF3 (-13)	Intel(R) I211 Gigabit Network Connection #2
	(PCI) 0xFFFFFFF4 (-12)	Intel(R) I211 Gigabit Network Connection #2
	(PCI) 0xFFFFFFF5 (-11)	Intel(R) I210 Gigabit Fiber Network Connection
	(PCI) 0xFFFFFFF6 (-10)	Intel(R) I210 Gigabit Fiber Network Connection
	(PCI) 0xFFFFFFF7 (-9)	Intel(R) I210 Gigabit Fiber Network Connection
	(PCI) 0xFFFFFFF8 (-8)	Intel(R) I210 Gigabit Fiber Network Connection
	(PCI) 0xFFFFFFF9 (-7)	Intel(R) I210 Gigabit Fiber Network Connection
	(PCI) 0xFFFFFFFA (-6)	Intel(R) I210 Gigabit Fiber Network Connection
	(PCI) 0xFFFFFFFB (-5)	Intel(R) USB 3.0 eXtensible Host Controller - 1.0 (Microsoft)
	(PCI) 0xFFFFFFFC (-4)	Intel(R) Trusted Execution Engine Interface
	(PCI) 0xFFFFFFFD (-3)	Intel(R) HD Graphics
	(PCI) 0xFFFFFFE (-2)	Standard SATA AHCI Controller

Appendix C

Standard LAN Bypass Platform Setting

C.1 Introduction to LED

ICS-6270 provides a LED indicator which can change the LED status by AAEON SDK.

User is able to program the LED status to express different status.

C.1.1 Status LED Configuration

The LED status indicator of FWS-2273 is programmable with AAEON SDK for your application.

Table 1 : Truth Table of Status LED

STA_LED2	STA_LED2	STA_LED2	STA_LED2
0	0	0	LED Off
0	0	1	Red
0	1	0	Red Blinking (Slowly)
0	1	1	Red Blinking (Quickly)
1	0	0	Reserved
1	0	1	Green Blinking (Slowly)
1	1	0	Green Blinking (Quickly)
1	1	1	Green

Table 2 : Status LED relative register mapping table

CPLD Slave Address 0x90 (Note1)				
	Attribute	Offset(SMBUS)	BitNum	Value
STA_LED2	R/W	0x00 (Note2)	2	(Table 1)
STA_LED1	R/W	0x00 (Note2)	1	(Table 1)
STA_LED0	R/W	0x00 (Note2)	0	(Table 1)

C.1.2 Sample Code

```
*****
*****
#define ByteCPLD_SLAVE_ADDRESS //This parameter is represented from Note1
#define ByteOFFSET //This parameter is represented from Note2
*****
*****
bData = aaeonSmbusReadByte(CPLD_SLAVE_ADDRESS, OFFSET);

switch( LED_FLAG)
{
case 0:
{
//LED Off
//BIT2=0, BIT1=0, BIT0=0
bData = bData & 0xF8;
break;
}
case 1:
{
//Red LED On
//BIT2=0, BIT1=0, BIT0=1
bData = (bData & 0xF8) | 0x01;
break;
}
case 2:
{
//Red LED Blink
//BIT2=0, BIT1=1, BIT0=0
bData = (bData & 0xF8) | 0x02;
break;
}
case 3:
{
//Red LED Fast Blink
//BIT2=0, BIT1=1, BIT0=1
bData = (bData & 0xF8) | 0x03;
break;
}
case 4:
```

```
{
    //Green LED On
    //BIT2=1, BIT1=1, BIT0=1
    bData = (bData & 0xF8) | 0x07;
    break;
}
case 5:
{
    //Green LED Blink
    //BIT2=1, BIT1=0, BIT0=1
    bData = (bData & 0xF8) | 0x05;
    break;
}
case 6:
{
    //Green LED Fast Blink
    //BIT2=1, BIT1=1, BIT0=0
    bData = (bData & 0xF8) | 0x06;
    break;
}
default:
    break;
}
SmbusWriteByte(CPLD_SLAVE_ADDRESS, 0x00, bData);
*****
*****
```

C.2 Introduction to LAN Bypass

ICS-6270 provides LAN Bypass kit and allow uninterrupted network traffic even if a single in-line appliance is shut down or hangs.

C.2.1 LAN Bypass

Table1: LAN Kit ID Select

LAN_ID2	LAN_ID1	LAN_ID0	LAN kit selected
0	0	0	LAN Kit 1 Selected
0	0	1	LAN Kit 2 Selected

Table2: LAN Bypass register table

Function	Description
LAN_ID3	
LAN_ID2	Use for selecting which LAN kit will be configured, refer to Table 1 of ID Select table of LAN kit.
LAN_ID1	They should be set before ACT_EN.
LAN_ID0	
PWR_ON	Use for configuring LAN Bypass function behavior to LAN kit, when system power on. 1: Bypass 0: Pass Through
PWR_OFF	Use for configuring LAN Bypass function behavior to LAN kit, when system power off. 1: Bypass 0: Pass Through
WDT_EN	Use for configuring WDT function behavior to LAN kit, when WDT triggered. 0: Normal WDT reset (Default) 1: Force Bypass
ACT_EN	Use for activating programming of LAN kit. It is edge triggering (falling edge 1 to 0) and should be set to high(1) as its normal state.

Table3: LAN Bypass register mapping table

CPLD Slave Address 0x90 (Note1)				
	Attribute	Offset(SMBUS)	BitNum	Value
LAN_ID3	R/W	0x01(Note2)	3	(Table 1)
LAN_ID2	R/W	0x01(Note2)	2	(Table 1)
LAN_ID1	R/W	0x01(Note2)	1	(Table 1)
LAN_ID0	R/W	0x01(Note2)	0	(Table 1)
PWR_ON	R/W	0x01(Note2)	6	(Table 2)
PWR_OFF	R/W	0x01(Note2)	5	(Table 2)
WDT_EN	R/W	0x01(Note2)	4	(Table 2)
ACT_EN	R/W	0x01(Note2)	7	(Table 2)

C.2.2 Sample Code

```
*****
*****
#define ByteCPLD_SLAVE_ADDRESS //This parameter is represented from Note1
#define ByteOFFSET //This parameter is represented from Note2
*****
*****

// Select Lan Pair
BYTE bLanSel = LAN_PAIR;

BYTE bData = SmbusReadByte(CPLD_SLAVE_ADDRESS, OFFSET);
// Set Reg01h bit3
if(bLanSel & 0x08)
    bData = bData | 0x08;
else
    bData = bData & 0xF7;
// Set Reg01h bit2
if(bLanSel & 0x04)
    bData = bData | 0x04;
else
    bData = bData & 0xFB;
// Set Reg01h bit1
if(bLanSel & 0x02)
    bData = bData | 0x02;
else
    bData = bData & 0xFD;
// Set Reg01h bit0
if(bLanSel & 0x01)
    bData = bData | 0x01;
else
    bData = bData & 0xFE;

// Power On Action (Reg01h bit6)
if(SET_PASS_THROUGH) // Pass Through
    bData = bData & 0xBF;
else // Bypass
    bData = bData | 0x40;

// Power Off Action (Reg01h bit5)
if(SET_PASS_THROUGH) // Pass Through
```

```
        bData = bData & 0xDF;
else // Bypass
    bData = bData | 0x20;

// WDT Action (Reg01h bit4)
if(SET_WDT_RESET)// Reset
    bData = bData & 0xEF;
else // Bypass
    bData = bData | 0x10;

SmbusWriteByte(CPLD_SLAVE_ADDRESS, OFFSET, bData);

// Apply Settings (Reg01h bit7)
bData = SmbusReadByte(CPLD_SLAVE_ADDRESS, OFFSET);
SmbusWriteByte(CPLD_SLAVE_ADDRESS, OFFSET, bData & 0x7F);
Sleep(500);
bData = SmbusReadByte(CPLD_SLAVE_ADDRESS, OFFSET);
SmbusWriteByte(CPLD_SLAVE_ADDRESS, OFFSET, bData | 0x80);
*****
```

C.3 Introduction to Software Reset Button Configuration

ICS-6270 provides a general propose input button which status get by AAeon SDK.

C.3.1 Soft Reset Button Configuration

Table 1 : Soft Reset Button register mapping table

	Attribute	Register(I/O)	BitNum	Value	Attribute
BTN_STS	R	0xA05(Note1)	4(Note2)	(Note3)	BTN_STS

Table 2 : LAN Bypass relative register table

Function	Description
BTN_STS	Reading this register returns the pin level status which is normal high active low. 0: Pin Level States Low. 1: Pin Level States High.

C.3.2 Sample Code

```
*****
#define Word      BTN_STS      //This parameter is represented from Note1
#define ByteBTN_STS_R      //This parameter is represented from Note2
*****
Byte  GET_Value (Word IoAddr, Byte BitNum,Byte Value){
    BYTE  TmpValue;

    TmpValue = inportb (IoAddr);
    return  (TmpValue & (1 << BitNum))
}
*****
VOID  Main(){
    Byte RstBtn;

    RstBtn = GET_Value (BTN_STS, BTN_STS_R); // Active Low
}
*****
```