

GENESYSM-EHL5

GENESYSM Compact Embedded System

User's Manual 1st Ed

Copyright Notice

This document is copyrighted, 2023. All rights are reserved. The original manufacturer reserves the right to make improvements to the products described in this manual at any time without notice.

No part of this manual may be reproduced, copied, translated, or transmitted in any form or by any means without the prior written permission of the original manufacturer. Information provided in this manual is intended to be accurate and reliable. However, the original manufacturer assumes no responsibility for its use, or for any infringements upon the rights of third parties that may result from its use.

The material in this document is for product information only and is subject to change without notice. While reasonable efforts have been made in the preparation of this document to assure its accuracy, AAeon assumes no liabilities resulting from errors or omissions in this document, or from the use of the information contained herein.

AAeon reserves the right to make changes in the product design without notice to its users.

Acknowledgement

All other products' name or trademarks are properties of their respective owners.

- Microsoft Windows® is a registered trademark of Microsoft Corp.
- Intel®, Atom®, Pentium®, and Celeron® are registered trademarks of Intel Corporation
- ITE is a trademark of Integrated Technology Express, Inc.
- IBM, PC/AT, PS/2, and VGA are trademarks of International Business Machines Corporation.
- Realtek is a trademark of Realtek Semiconductor Corporation
- Linux® is a registered trademark of Linus Torvalds in the United States, other countries

All other product names or trademarks are properties of their respective owners.

Packing List

Before setting up your product, please make sure the following items have been shipped:

Item	Quantity
• GENESYSM-EHL5	1
• Heatsink (TH2EHL5010)	1
• Thermal Pad (TH5EHL5010)	4

If any of these items are missing or damaged, please contact your distributor or sales representative immediately.

About this Document

This User's Manual contains all the essential information, such as detailed descriptions and explanations on the product's hardware and software features (if any), its specifications, dimensions, jumper/connector settings/definitions, and driver installation instructions (if any), to facilitate users in setting up their product.

Users may refer to the product page at AAEON.com for the latest version of this document.

Safety Precautions

Please read the following safety instructions carefully. It is advised that you keep this manual for future references

1. All cautions and warnings on the device should be noted.
2. Make sure the power source matches the power rating of the device.
3. Position the power cord so that people cannot step on it. Do not place anything over the power cord.
4. Always completely disconnect the power before working on the system's hardware.
5. No connections should be made when the system is powered as a sudden rush of power may damage sensitive electronic components.
6. If the device is not to be used for a long time, disconnect it from the power supply to avoid damage by transient over-voltage.
7. Always disconnect this device from any AC supply before cleaning.
8. While cleaning, use a damp cloth instead of liquid or spray detergents.
9. Make sure the device is installed near a power outlet and is easily accessible.
10. Keep this device away from humidity.
11. Place the device on a solid surface during installation to prevent falls
12. Do not cover the openings on the device to ensure optimal heat dissipation.
13. Watch out for high temperatures when the system is running.
14. Do not touch the heat sink or heat spreader when the system is running
15. Never pour any liquid into the openings. This could cause fire or electric shock.
16. As most electronic components are sensitive to static electrical charge, be sure to ground yourself to prevent static charge when installing the internal components. Use a grounding wrist strap and contain all electronic components in any static-shielded containers.

17. If any of the following situations arises, please the contact our service personnel:
 - i. Damaged power cord or plug
 - ii. Liquid intrusion to the device
 - iii. Exposure to moisture
 - iv. Device is not working as expected or in a manner as described in this manual
 - v. The device is dropped or damaged
 - vi. Any obvious signs of damage displayed on the device
18. **DO NOT LEAVE THIS DEVICE IN AN UNCONTROLLED ENVIRONMENT WITH TEMPERATURES BEYOND THE DEVICE'S PERMITTED STORAGE TEMPERATURES (SEE CHAPTER 1) TO PREVENT DAMAGE.**

Warning!



This device complies with Part 15 FCC Rules. Operation is subject to the following two conditions: (1) this device may not cause harmful interference, and (2) this device must accept any interference received including interference that may cause undesired operation.

Caution:

There is a danger of explosion if the battery is incorrectly replaced. Replace only with the same or equivalent type recommended by the manufacturer. Dispose of used batteries according to the manufacturer's instructions and your local government's recycling or disposal directives.

Attention:

Il y a un risque d'explosion si la batterie est remplacée de façon incorrecte. Ne la remplacer qu'avec le même modèle ou équivalent recommandé par le constructeur. Recycler les batteries usées en accord avec les instructions du fabricant et les directives gouvernementales de recyclage.

产品中有毒有害物质或元素名称及含量

AAEON System

QO4-381 Rev.A0

部件名称	有毒有害物质或元素					
	铅 (Pb)	汞 (Hg)	镉 (Cd)	六价铬 (Cr(VI))	多溴联苯 (PBB)	多溴二苯醚 (PBDE)
印刷电路板 及其电子组件	×	○	○	○	○	○
外部信号 连接器及线材	×	○	○	○	○	○
外壳	○	○	○	○	○	○
中央处理器 与内存	×	○	○	○	○	○
硬盘	×	○	○	○	○	○
液晶模块	×	○	○	○	○	○
光驱	×	○	○	○	○	○
触控模块	×	○	○	○	○	○
电源	×	○	○	○	○	○
电池	×	○	○	○	○	○

本表格依据 SJ/T 11364 的规定编制。

○：表示该有毒有害物质在该部件所有均质材料中的含量均在 GB/T 26572 标准规定的限量要求以下。

×：表示该有害物质的某一均质材料超出了 GB/T 26572 的限量要求，然而该部件仍符合欧盟指令 2011/65/EU 的规范。

备注：

- 一、此产品所标示之环保使用期限，系指在一般正常使用状况下。
- 二、上述部件物质中央处理器、内存、硬盘、光驱、电源为选购品。
- 三、上述部件物质液晶模块、触控模块仅一体机产品适用。

China RoHS Requirement (EN)

Hazardous and Toxic Materials List

AAEON System

QQ4-381 Rev.A0

Component Name	Hazardous or Toxic Materials or Elements					
	Lead (Pb)	Mercury (Hg)	Cadmium (Cd)	Hexavalent Chromium (Cr(VI))	Polybrominated biphenyls (PBBS)	Polybrominated ethers (PBDES)
PCB and Components	X	O	O	O	O	O
Wires & Connectors for Ext.Connections	X	O	O	O	O	O
Chassis	O	O	O	O	O	O
CPU & RAM	X	O	O	O	O	O
HDD Drive	X	O	O	O	O	O
LCD Module	X	O	O	O	O	O
Optical Drive	X	O	O	O	O	O
Touch Control Module	X	O	O	O	O	O
PSU	X	O	O	O	O	O
Battery	X	O	O	O	O	O

This form is prepared in compliance with the provisions of SJ/T 11364.

O: The level of toxic or hazardous materials present in this component and its parts is below the limit specified by GB/T 26572.

X: The level of toxic or hazardous materials present in the component exceed the limits specified by GB/T 26572, but is still in compliance with EU Directive 2011/65/EU (RoHS 2).

Notes:

1. The Environment Friendly Use Period indicated by labelling on this product is applicable only to use under normal conditions.
2. Individual components including the CPU, RAM/memory, HDD, optical drive, and PSU are optional.
3. LCD Module and Touch Control Module only applies to certain products which feature these components.

Table of Contents

Chapter 1 - Product Specifications	1
1.1 Specifications	2
1.2 Block Diagram	5
Chapter 2 – Hardware Information	6
2.1 Dimensions	7
2.2 Jumpers and Connectors.....	10
2.3 List of Jumpers	12
2.3.1 Clear CMOS Jumper (JP1)	12
2.3.2 Auto Power Button Enable/Disable Selection (JP6)	12
2.3.3 COM 2 Pin 8 Function Selection (JP8)	13
2.3.4 SMBus/I2C Connector (JP11).....	13
2.4 List of Connectors.....	14
2.4.1 Battery (CN1).....	16
2.4.2 Amplifier R-Channel Output (CN4).....	16
2.4.3 Amplifier L-Channel Output (CN5)	17
2.4.4 M.2 3052 B-Key (CN6)	17
2.4.5 Nano SIM Card Socket (CN7).....	20
2.4.6 M.2 2242 B-Key (CN8)	21
2.4.7 HDMI (CN11).....	24
2.4.8 RJ-45 LAN Port 1 (CN14)	25
2.4.9 RJ-45 LAN Port 2 (CN15).....	26
2.4.10 SATA Port (CN16).....	26
2.4.11 +5V Output for SATA HDD (CN17)	27
2.4.12 Digital IO Port (CN18).....	27
2.4.13 Digital IO Port (CN19).....	28
2.4.14 USB 3.1 Ports (CN20).....	29

2.4.15	USB 2.0 Port (CN21).....	30
2.4.16	M.2 2280 B-Key (CN25).....	31
2.4.17	M.2 2230 E-Key (CN26).....	34
2.4.18	COM Port 1~2 (CN27).....	37
2.4.19	eSPI Debug Port (CN32).....	39
2.4.20	CPU FAN (CN33).....	39
2.4.21	External Power Input (CN34).....	40
2.4.22	Front Panel Connector (CN36).....	40
2.4.23	VGA Port (CN39).....	41
2.4.24	LAN 1 SDP Connector (CN43).....	42
2.4.25	LAN 2 SDP Connector (CN44).....	42
2.4.26	DDR4 SODIMM (DIMM1).....	43
2.5	Electrical Specifications for I/O Ports.....	44
Chapter 3 - AMI BIOS Setup.....		45
3.1	System Test and Initialization.....	46
3.2	AMI BIOS Setup.....	47
3.3	Setup Submenu: Main.....	48
3.4	Setup Submenu: Advanced.....	49
3.4.1	CPU Configuration.....	50
3.4.2	PCH-FW Configuration.....	51
3.4.2.1	Firmware Update Configuration.....	52
3.4.3	Trusted Computing.....	53
3.4.4	SATA Configuration.....	55
3.4.5	Hardware Monitor.....	56
3.4.5.1	Smart Fan Mode Configuration.....	57
3.4.6	SIO Configuration.....	58
3.4.6.1	Serial Port 1 Configuration.....	59
3.4.6.2	Serial Port 2 Configuration.....	60

3.4.7	Serial Port Console Redirection	61
3.4.8	SCS Configuration.....	62
3.4.9	Power Management.....	63
3.4.10	GPIO Port Configuration	64
3.4.11	AAEON BIOS Robot	65
3.4.12	Device Detecting Configuration	67
3.4.12.1	Device #* Detecting Configuration.....	69
3.5	Setup Submenu: Chipset	80
3.5.1	System Agent (SA) Configuration.....	81
3.5.1.1	Memory Configuration	82
3.6	Setup Submenu: Security.....	83
3.6.1	Secure Boot.....	84
3.6.1.1	Key Management.....	85
3.7	Setup Submenu: Boot	87
3.7.1	BBS Priorities	88
3.8	Setup Submenu: Save & Exit.....	89
Chapter 4 – Driver Installation		90
4.1	Driver Download/Installation	91
Appendix A - I/O Information.....		93
A.1	I/O Address Map	94
A.2	Memory Address Map	96
A.3	IRQ Mapping Chart.....	97
A.4	DMA Channel Assignments	99
Appendix B – Mating Connectors and Cables.....		100
B.1	Mating Connectors and Cables.....	101

Chapter 1

Product Specifications

1.1 Specifications

System

Form Factor	3.5" SubCompact Board System
CPU	Intel Atom® Processor X Series, Pentium® and Celeron® N and J Series Processors: Intel Atom® x6425E (4C/4T, 2.00 GHz, 12W) Intel® Celeron® Processor J6412 (4C/4T, 2.00 GHz, 10W) Intel® Celeron® Processor N6210 (2C/2T, 1.20 GHz, 6.5W)
Chipset	Integrated with Intel® SoC
Memory Type	DDR4 up to 3200, Single Channel SODIMM x 1, Max 32GB, Non-ECC *BECC supported by selected SOC
BIOS	UEFI
Wake on LAN	Yes
Watchdog Timer	255 Levels
Security	TPM 2.0
RTC Battery	Lithium Battery 3V/240mAh
Dimension	7.00" x 5.28" x 2.08" (178mm x 134.1mm x 53mm)
Weight	2.2 lb. (1Kg)
OS Support	Windows® 10 (64-bit) Linux Ubuntu 20.04.3 (IOT)/Kernel 5.13

Power

Power Requirement	+12V/+9V~36V
Power Supply Type	ATX
Connector	DC Jack Connector

Power

Power Consumption	Intel Atom® x6425E, DDR4 32GB, 3.26A @+12V (Typical) Intel Atom® x6425E, DDR4 32GB, 3.42A @+12V (Max)
--------------------------	--

Display

Controller	Intel® UHD Graphics for 10th Gen Intel® Processors
LVDS/eDP	—
Display Interface	HDMI 2.0 x 1, up to 4K @60Hz VGA x 1, up to 2560 x 1440
Multiple Display	Up to 2 Simultaneous Displays

Audio

Codec	—
Audio Interface	—
Speaker	—

External I/O

Ethernet	Intel® I210 1GbE, RJ-45 x 2
USB	USB 3.2 Gen 2 x 2 USB 2.0 x 2
Serial Port	COM 1 (RS-232/422/485) COM 2 (RS-232/422/485, supports 5V/12V/RI)
Video	HDMI 2.0 x 1 VGA x 1

Internal I/O

USB	—
Serial Port	—

Internal I/O

Video	—
SATA	SATA 6Gb/s x 1 +5V SATA Power Connector x 1
Audio	—
DIO/GPIO	GPIO 16-bit (Optional: with E-Base)
SMBus/I2C	SMBus/I2C x 1 (Default: SMBus)
Touch	—
Fan	4-pin Smart Fan x 1
SIM	Nano SIM x 1
Front Panel	HDD LED, PWR LED, Power Button, Buzzer, Reset
Others	eMMC 5.1, 32GB

Expansion

Mini PCIe/mSATA	—
M.2	M.2 2230 E-Key x 1 (PCIe 3.0 [x1] + USB 2.0) M.2 2242 B-Key x 1 (PCIe 3.0 [x2]/SATA, Default: PCIe 3.0 [x2]) M.2 2280 B-Key x 1 (PCIe 3.0 [x1] + USB 2.0) M.2 3052 B-Key x 1 (USB 3.2 Gen 2)
Others	—

Environment

Operating Temperature	32°F ~ 122°F (0°C ~ 50°C) with 0.5 m/s air flow
Storage Temperature	-40°F ~ 185°F (-40°C ~ 85°C)
Operating Humidity	0% ~ 90% relative humidity, non-condensing
MTBF (Hours)	335,427
EMC	CE/FCC Class A

1.2 Block Diagram

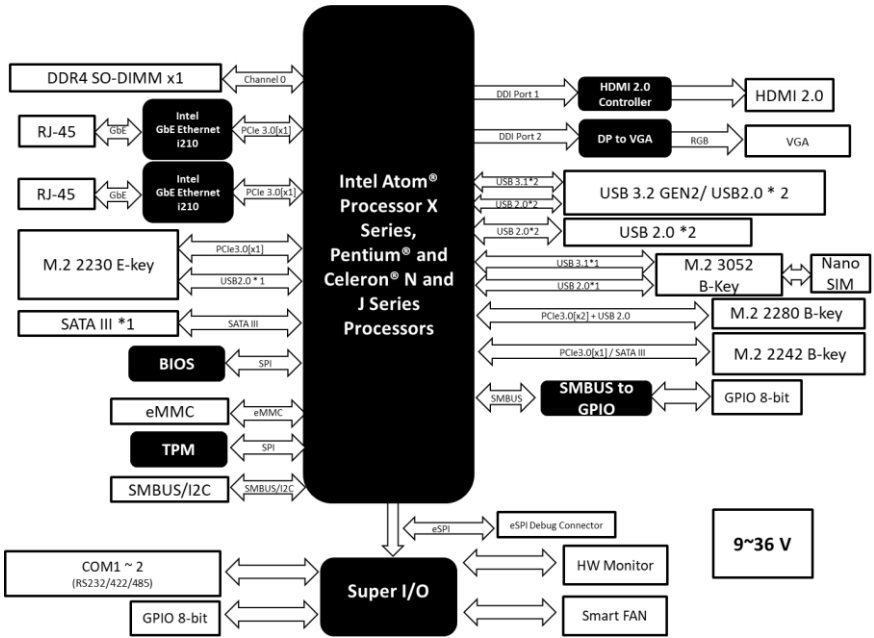

Chapter 2

Hardware Information

2.1 Dimensions

System

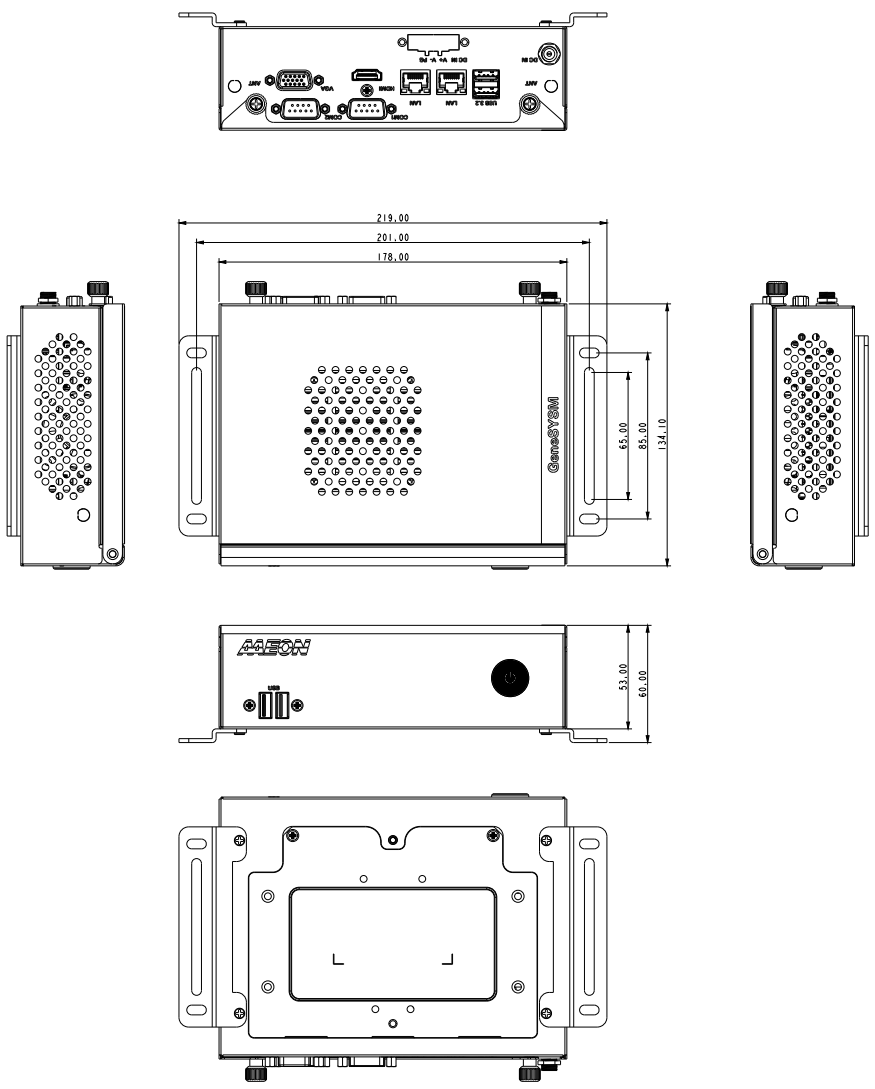

Board – Component Side

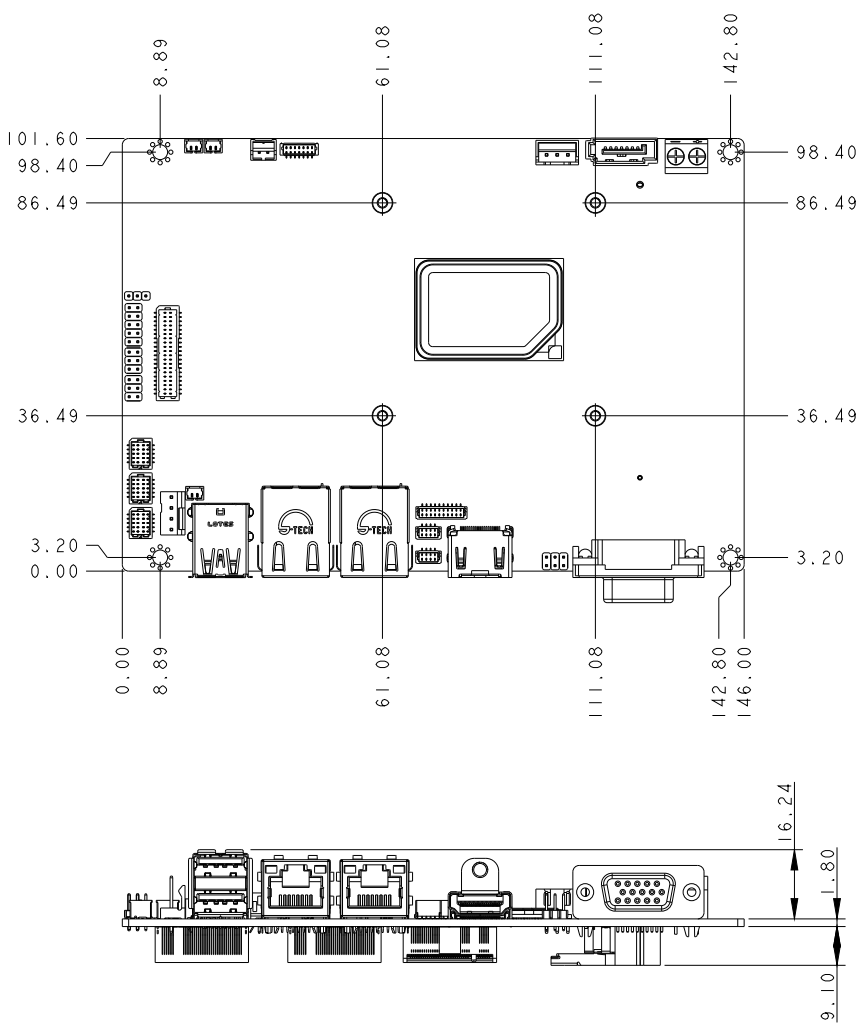

Board – Solder Side

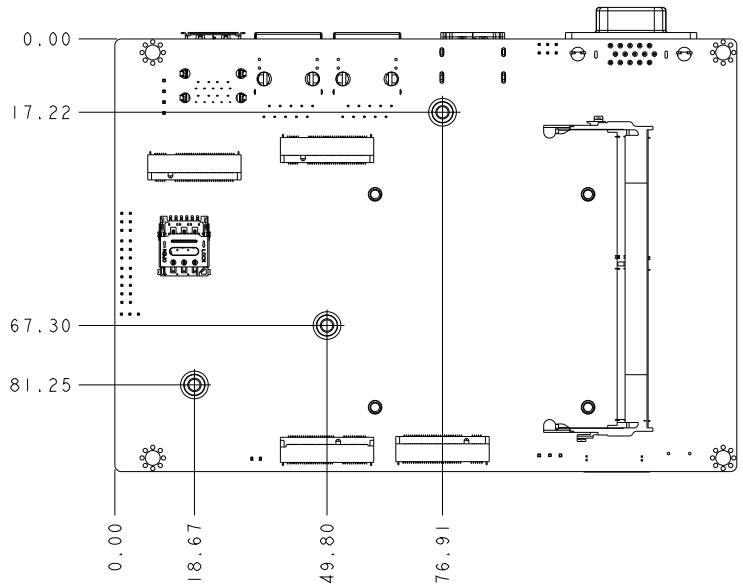

VGA

2.2 Jumpers and Connectors

Component Side

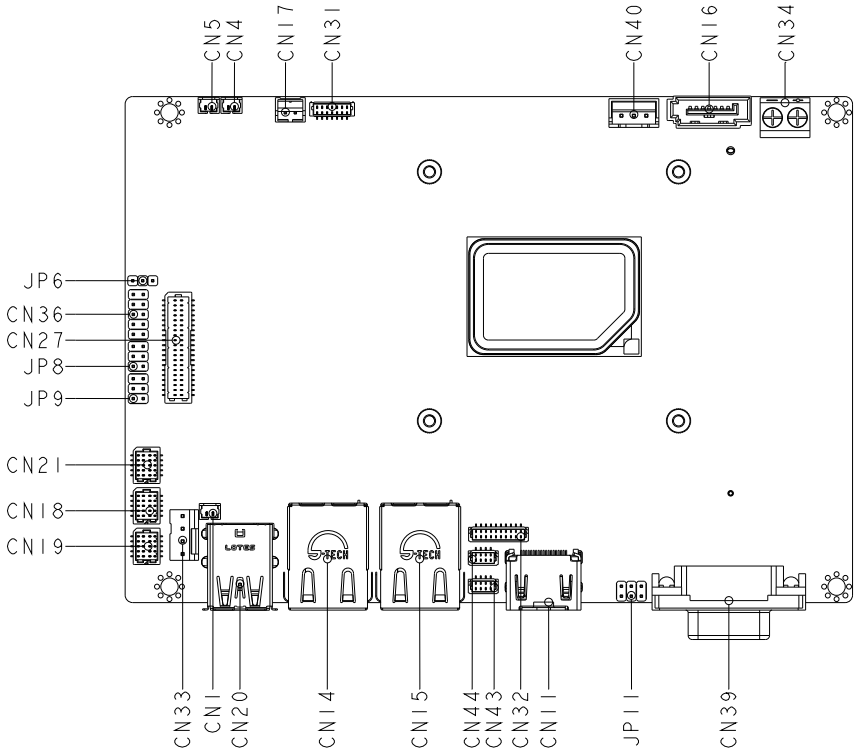

Solder Side

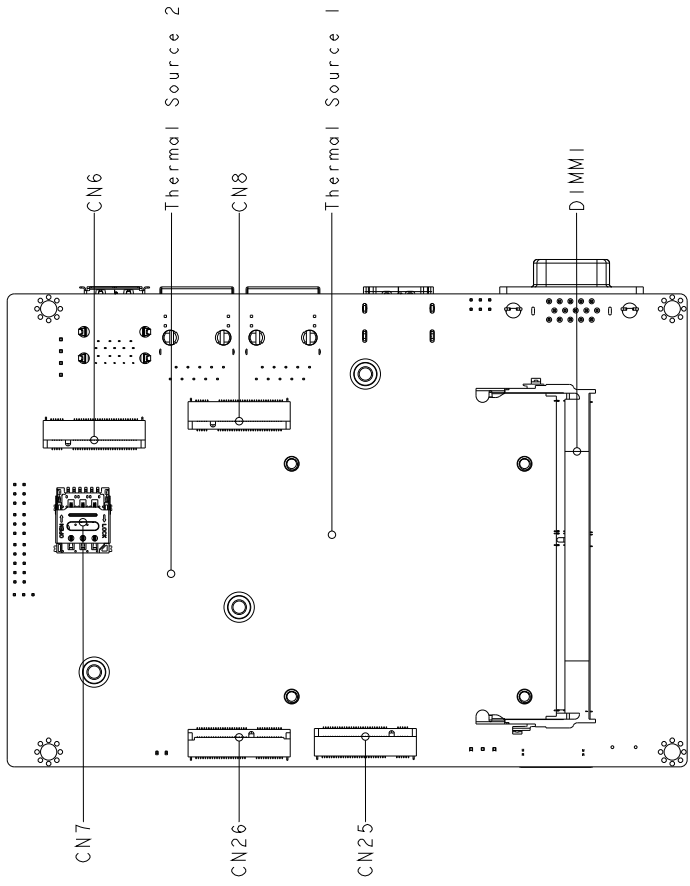

VGA

2.3 List of Jumpers

Please refer to the table below for all of the board's jumpers that you can configure for your application

Label	Function
JP1	Clear CMOS Jumper
JP6	Auto Power Button Enable/Disable Selection
JP8	COM 2 Pin 8 Function Selection
JP11	SMBus/I2C Connector

2.3.1 Clear CMOS Jumper (JP1)

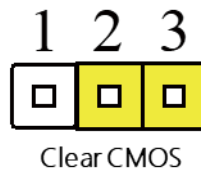
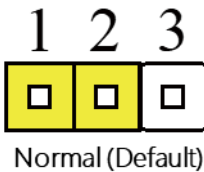

2.3.2 Auto Power Button Enable/Disable Selection (JP6)

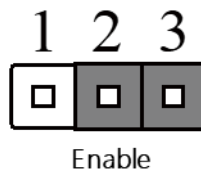
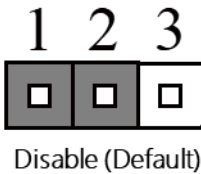

Note: Use power button CN36 (1-2) to power on the system when Auto Power Button is Disabled.

2.3.3 COM 2 Pin 8 Function Selection (JP8)

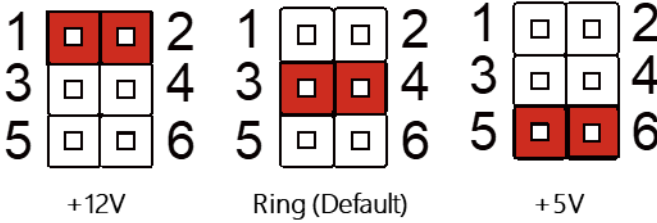

2.3.4 SMBus/I2C Connector (JP11)

Pin	Signal Type	Pin	Signal Type
1	SMBUS DATA / I2C DATA	2	+3.3V
3	SMBUS CLK / I2C CLK	4	+1.8V
5	SMBUS INT / INT SERIRQ	6	GND

Default: SMBUS. BOM Change is required for I2C support.

2.4 List of Connectors

Please refer to the table below for all of the board's connectors that you can configure for your application

Label	Function
CN1	Battery
CN4	Amplifier R-Channel Output
CN5	Amplifier L-Channel Output
CN6	M.2 3052 B-Key (USB 3.2 Gen 2/USB 2.0)
CN7	Nano SIM Card Socket
CN8	M.2 2242 B-Key (PCIe [x2] or SATA 6Gb/s)
CN11	HDMI Port
CN14	RJ-45 LAN Port 1
CN15	RJ-45 LAN Port 2
CN16	SATA Port
CN17	+5V Output for SATA HDD
CN18	Digital IO Port
CN19	Digital IO Port
CN20	USB 3.1 Ports
CN21	USB 2.0 Port
CN25	M.2 2280 B-Key (PCIe [x1])
CN26	M.2 2230 E-Key (PCIe [x1]/USB 2.0)
CN27	COM Port 1~2
CN31	SPI Program Port
CN32	eSPI Debug Port
CN33	CPU Fan
CN34	External Power Input
CN36	Front Panel
CN39	VGA Port
CN43	LAN 1 SDP Connector

Label	Function
CN44	LAN 2 SDP Connector
DIMM1	DDR4 SODIMM

2.4.1 Battery (CN1)

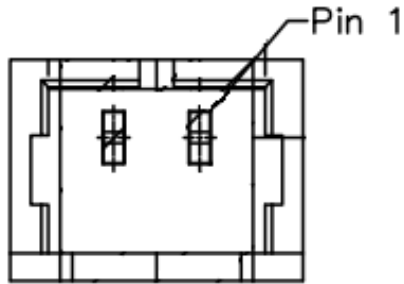

Pin	Pin Name	Signal Type	Signal Level
1	+3.3V	PWR	3.3V
2	GND	GND	

2.4.2 Amplifier R-Channel Output (CN4)

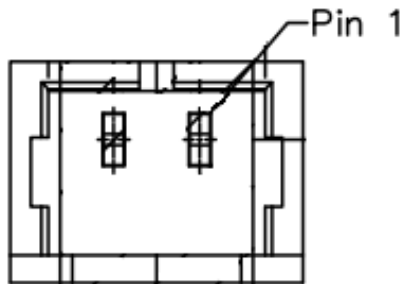

Pin	Pin Name	Signal Type	Signal level
1	SKR_R+	OUT	
2	SKR_R-	OUT	

2.4.3 Amplifier L-Channel Output (CN5)

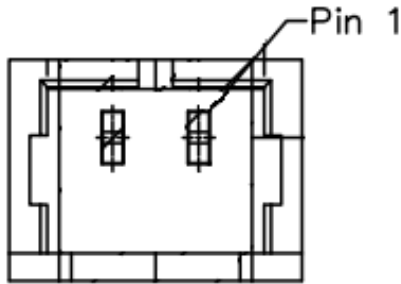

Pin	Pin Name	Signal Type	Signal level
1	SKR_L+	OUT	
2	SKR_L-	OUT	

2.4.4 M.2 3052 B-Key (CN6)

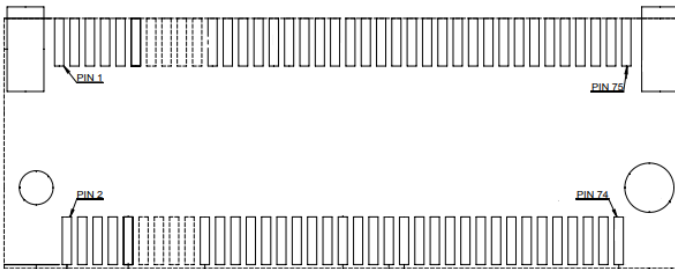

Pin	Pin Name	Signal Type	Signal level
1	GND	GND	
2	+3.3V	PWR	+3.3V
3	GND	GND	
4	+3.3V	PWR	+3.3V
5	GND	GND	
6	N.C	N.C	

Pin	Pin Name	Signal Type	Signal level
7	USB_D+	DIFF	
8	W_DISABLE	IN	
9	USB_D-	DIFF	
10	SSD_DAS#	OUT	
20	N.C	N.C	
21	GND	GND	
22	N.C	N.C	
23	N.C	N.C	
24	N.C	N.C	
25	N.C	N.C	
26	N.C	N.C	
27	GND	GND	
28	N.C	N.C	
29	USB_RX-	DIFF	
30	UIM_RST	OUT	
31	USB_RX+	DIFF	
32	UIM_CLK	OUT	
33	GND	GND	
34	UIM_DAT	IN / OUT	
35	USB_TX-	DIFF	
36	UIM_PWR	PWR	
37	USB_TX+	DIFF	
38	DEVSLP	IN	
39	GND	GND	
40	GF_SM_CLK	OUT	
41	N.C	N.C	
42	GF_SM_DAT	IN / OUT	
43	N.C	N.C	

Pin	Pin Name	Signal Type	Signal level
44	N.C	N.C	
45	GND	GND	
46	N.C	N.C	
47	N.C	N.C	
48	N.C	N.C	
49	N.C	N.C	
50	PERST#	IN	
51	GND	GND	
52	N.C	N.C	
53	N.C	N.C	
54	PEWAKE#	OUT	
55	N.C	N.C	
56	N.C	N.C	
57	GND	GND	
58	N.C	N.C	
59	N.C	N.C	
60	N.C	N.C	
61	N.C	N.C	
62	N.C	N.C	
63	N.C	N.C	
64	N.C	N.C	
65	N.C	N.C	
66	N.C	N.C	
67	N.C	N.C	
68	N.C	N.C	
69	GND	GND	
70	+3.3V	PWR	+3.3V
71	GND	GND	

Pin	Pin Name	Signal Type	Signal level
72	+3.3V	PWR	+3.3V
73	GND	GND	
74	+3.3V	PWR	+3.3V
75	N.C	N.C	

2.4.5 Nano SIM Card Socket (CN7)

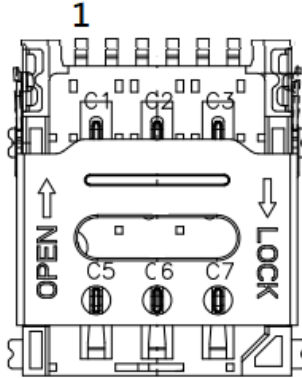

Pin	Pin Name	Signal Type	Signal level
1	UIM_PWR	PWR	
2	UIM_RST	IN	
3	UIM_CLK	IN	
4	GND	GND	
5	UIM_VPP	PWR	
6	UIM_DATA	I/O	

2.4.6 M.2 2242 B-Key (CN8)

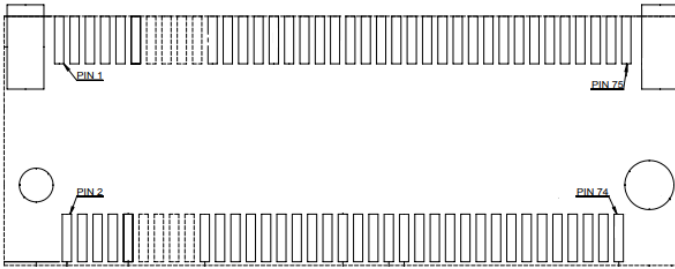

Pin	Pin Name	Signal Type	Signal level
1	GND	GND	
2	+3.3V	PWR	+3.3V
3	GND	GND	
4	+3.3V	PWR	+3.3V
5	GND	GND	
6	N.C	N.C	
7	N.C	N.C	
8	W_DISABLE	IN	
9	N.C	N.C	
10	SSD_DAS#	OUT	
11	GND	GND	
20	N.C	N.C	
21	GND	GND	
22	N.C	N.C	
23	N.C	N.C	
24	N.C	N.C	
25	N.C	N.C	
26	N.C	N.C	
27	GND	GND	
28	N.C	N.C	

Pin	Pin Name	Signal Type	Signal level
29	PCIE_RX-	DIFF	
30	N.C	N.C	
31	PCIE_RX+	DIFF	
32	N.C	N.C	
33	GND	GND	
34	N.C	N.C	
35	PCIE_TX-	DIFF	
36	N.C	N.C	
37	PCIE_TX+	DIFF	
38	DEVSLP	IN	
39	GND	GND	
40	N.C	N.C	
41	PCIE0_RX- / SATA1_RX+	DIFF	
42	N.C	N.C	
43	PCIE0_RX+ / SATA1_RX-	DIFF	
44	N.C	N.C	
45	GND	GND	
46	N.C	N.C	
47	PCIE0_TX- / SATA1_TX-	DIFF	
48	N.C	N.C	
49	PCIE0_TX+ / SATA1_TX+	DIFF	
50	PERST#	IN	
51	GND	GND	
52	CLKREQ#	OUT	
53	PCIE_CLK-	CLK	
54	PEWAKE#	OUT	
55	PCIE_CLK+	CLK	
56	N.C	N.C	

Pin	Pin Name	Signal Type	Signal level
57	GND	GND	
58	N.C	N.C	
59	N.C	N.C	
60	N.C	N.C	
61	N.C	N.C	
62	N.C	N.C	
63	N.C	N.C	
64	N.C	N.C	
65	N.C	N.C	
66	N.C	N.C	
67	N.C	N.C	
68	N.C	N.C	
69	GND	GND	
70	+3.3V	PWR	+3.3V
71	GND	GND	
72	+3.3V	PWR	+3.3V
73	GND	GND	
74	+3.3V	PWR	+3.3V
75	N.C	N.C	

Note: The speed of PCIe for CN8 can be changed by BIOS and be changed to mSATA by BOM.

Default: PCIe [x2].

2.4.7 HDMI (CN11)

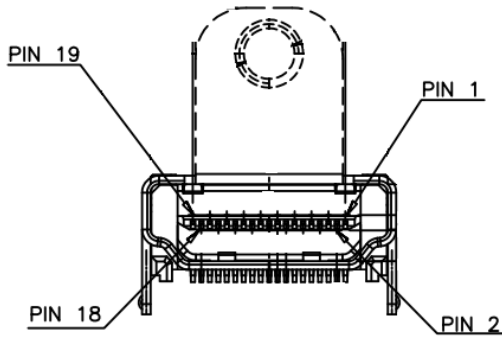

Pin	Pin Name	Signal Type	Signal level
1	HDMI_D2+	DIFF	
2	GND	GND	
3	HDMI_D2-	DIFF	
4	HDMI_D1+	DIFF	
5	GND	GND	
6	HDMI_D1-	DIFF	
7	HDMI_D0+	DIFF	
8	GND	GND	
9	HDMI_D0-	DIFF	
10	HDMI_CLK+	DIFF	
11	GND	GND	
12	HDMI_CLK-	DIFF	
13	N.C	N.C	
14	N.C	N.C	
15	HDMI_SLK	CLK	
16	HDMI_SDA	IN/OUT	
17	GND	GND	
18	+5V	I/O	+5V

Pin	Pin Name	Signal Type	Signal level
19	HPLG_DETECT	IN	

2.4.8 RJ-45 LAN Port 1 (CN14)

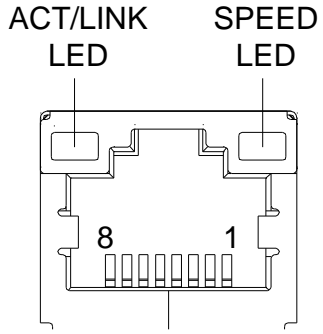

Pin	Pin Name	Signal Type	Signal level
1	MDI0+	DIFF	
2	MDI0-	DIFF	
3	MDI1+	DIFF	
4	MDI2+	DIFF	
5	MDI2-	DIFF	
6	MDI1-	DIFF	
7	MDI3+	DIFF	
8	MDI3-	DIFF	

2.4.9 RJ-45 LAN Port 2 (CN15)

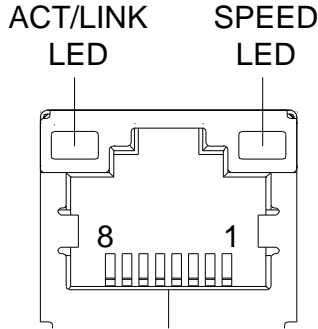

Pin	Pin Name	Signal Type	Signal level
1	MDI0+	DIFF	
2	MDI0-	DIFF	
3	MDI1+	DIFF	
4	MDI2+	DIFF	
5	MDI2-	DIFF	
6	MDI1-	DIFF	
7	MDI3+	DIFF	
8	MDI3-	DIFF	

2.4.10 SATA Port (CN16)

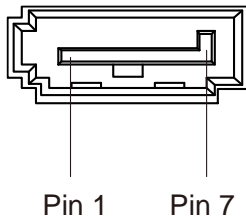

Pin	Pin Name	Signal Type	Signal level
1	GND	GND	
2	SATA_TX+	DIFF	

Pin	Pin Name	Signal Type	Signal level
3	SATA_TX-	DIFF	
4	GND	GND	
5	SATA_RX-	DIFF	
6	SATA_RX+	DIFF	
7	GND	GND	

2.4.11 +5V Output for SATA HDD (CN17)

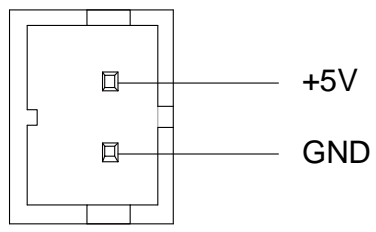

Pin	Pin Name	Signal Type	Signal level
1	+5V	PWR	+5V
2	GND	GND	

2.4.12 Digital IO Port (CN18)

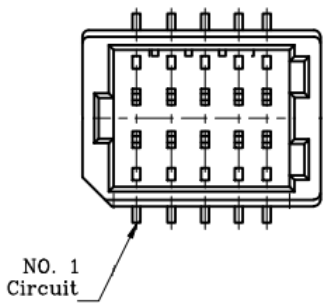

Pin	Pin Name	Signal Type	Signal level
1	+5V	PWR	+5V

Pin	Pin Name	Signal Type	Signal level
2	DIO1	I/O	+5V
3	DIO0	I/O	+5V
4	DIO3	I/O	+5V
5	DIO2	I/O	+5V
6	DIO5	I/O	+5V
7	DIO4	I/O	+5V
8	DIO7	I/O	+5V
9	DIO6	I/O	+5V
10	GND	GND	

2.4.13 Digital IO Port (CN19)

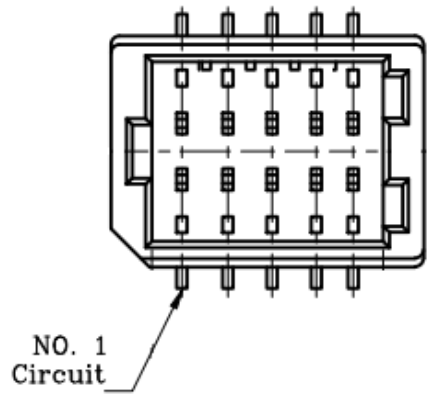

Pin	Pin Name	Signal Type	Signal level
1	+5V	PWR	+5V
2	DIO9	I/O	+5V
3	DIO8	I/O	+5V
4	DIO11	I/O	+5V
5	DIO10	I/O	+5V
6	DIO13	I/O	+5V
7	DIO12	I/O	+5V

Pin	Pin Name	Signal Type	Signal level
8	DIO15	I/O	+5V
9	DIO14	I/O	+5V
10	GND	GND	

2.4.14 USB 3.1 Ports (CN20)

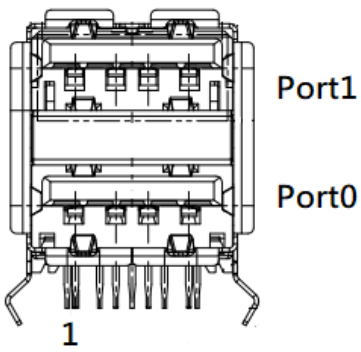

Pin	Pin Name	Signal Type	Signal level
1	+5VSB	PWR	+5V
2	USB_D-	DIFF	
3	USB_D+	DIFF	
4	GND	GND	
5	USB_SSRX-	DIFF	
6	USB_SSRX+	DIFF	
7	GND	GND	
8	USB_SSTX-	DIFF	
9	USB_SSTX+	DIFF	
10	+5VSB	PWR	+5V
11	USB_D-	DIFF	
12	USB_D+	DIFF	
13	GND	GND	

Pin	Pin Name	Signal Type	Signal level
14	USB_SSRX-	DIFF	
15	USB_SSRX+	DIFF	
16	GND	GND	
17	USB_SSTX-	DIFF	
18	USB_SSTX+	DIFF	

2.4.15 USB 2.0 Port (CN21)

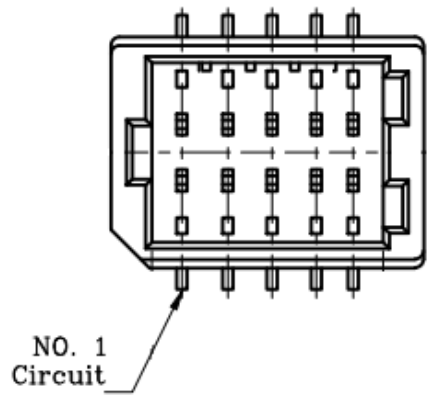

Pin	Pin Name	Signal Type	Signal level
1	+5VSB	PWR	+5V
2	+5VSB	PWR	+5V
3	USB_D0-	DIFF	
4	USB_D1-	DIFF	
5	USB_D0+	DIFF	
6	USB_D1+	DIFF	
7	GND	GND	
8	GND	GND	
9	GND	GND	
10	GND	GND	

2.4.16 M.2 2280 B-Key (CN25)

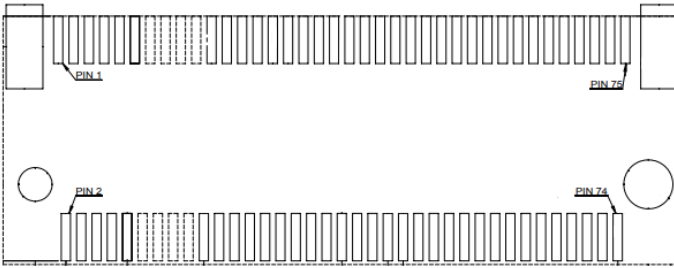

Pin	Pin Name	Signal Type	Signal level
1	GND	GND	
2	+3.3V	PWR	+3.3V
3	GND	GND	
4	+3.3V	PWR	+3.3V
5	GND	GND	
6	N.C	N.C	
7	USB_D8+	DIFF	
8	W_DISABLE	IN	
9	USB_D8-	DIFF	
10	SSD_DAS#	OUT	
11	GND	GND	
20	N.C	N.C	
21	GND	GND	
22	N.C	N.C	
23	N.C	N.C	
24	N.C	N.C	
25	N.C	N.C	
26	N.C	N.C	
27	GND	GND	
28	N.C	N.C	

Pin	Pin Name	Signal Type	Signal level
29	PCIE7_RX-	DIFF	
30	N.C	N.C	
31	PCIE7_RX+	DIFF	
32	N.C	N.C	
33	GND	GND	
34	N.C	N.C	
35	PCIE7_TX-	DIFF	
36	N.C	N.C	
37	PCIE7_TX+	DIFF	
38	N.C	N.C	
39	GND	GND	
40	N.C	N.C	
41	PCIE6_RX-	DIFF	
42	N.C	N.C	
43	PCIE6_RX+	DIFF	
44	N.C	N.C	
45	GND	GND	
46	N.C	N.C	
47	PCIE6_TX-	DIFF	
48	N.C	N.C	
49	PCIE6_TX+	DIFF	
50	PERST#	IN	
51	GND	GND	
52	CLKREQ#	OUT	
53	PCIE1_CLK-	CLK	
54	PEWAKE#	OUT	
55	PICE1_CLK+	CLK	
56	N.C	N.C	

Pin	Pin Name	Signal Type	Signal level
57	GND	GND	
58	N.C	N.C	
59	N.C	N.C	
60	N.C	N.C	
61	N.C	N.C	
62	N.C	N.C	
63	N.C	N.C	
64	N.C	N.C	
65	N.C	N.C	
66	N.C	N.C	
67	N.C	N.C	
68	N.C	N.C	
69	GND	GND	
70	+3.3V	PWR	+3.3V
71	GND	GND	
72	+3.3V	PWR	+3.3V
73	GND	GND	
74	+3.3V	PWR	+3.3V
75	N.C	N.C	

Note: The speed of PCIe for CN25 can be changed by BIOS.

Default: PCIe [x1].

2.4.17 M.2 2230 E-Key (CN26)

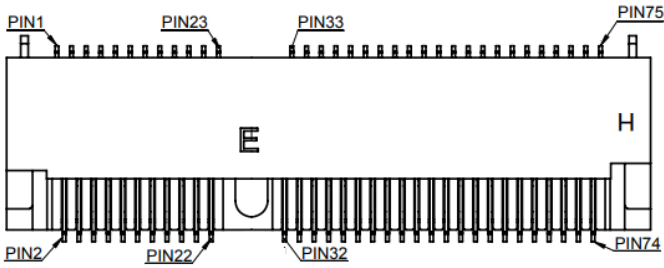

Pin	Pin Name	Signal Type	Signal level
1	GND	GND	
2	+3.3V	PWR	+3.3V
3	USB_D+	DIFF	
4	+3.3V	PWR	+3.3V
5	USB_D-	DIFF	
6	NC	NC	
7	GND	GND	
8	BT_PCM_CLK	NC	
9	NC	NC	
10	BT_PCM_FRM_CRF_RST	NC	
11	NC	NC	
12	BT_PCM_IN	NC	
13	NC	NC	
14	BT_PCM_OUT_CLKREQ	NC	
15	NC	NC	
16	NC	NC	
17	NC	NC	
18	GND	GND	
19	NC	NC	
20	NC	NC	

Pin	Pin Name	Signal Type	Signal level
21	NC	NC	
22	NC	NC	
23	NC	NC	
32	NC	NC	
33	GND	GND	
34	NC	NC	
35	PCIE1_TX+	DIFF	
36	NC	NC	
37	PCIE1_TX-	DIFF	
38	NC	NC	
39	GND	GND	
40	NC	NC	
41	PCIE1_RX+	DIFF	
42	NC	NC	
43	PCIE1_RX-	DIFF	
44	NC	NC	
45	GND	GND	
46	N.C	N.C	
47	PCIE0_CLK+	DIFF	
48	N.C	N.C	
49	PCIE0_CLK-	DIFF	
50	NC	NC	
51	GND	GND	
52	RESET#	IN	3.3V
53	PCIE_CLKREQ#	OUT	
54	BT_EN	IN	3.3V
55	PCIE_WAKE#	OUT	3.3V
56	WIFI_EN	IN	3.3V

Pin	Pin Name	Signal Type	Signal level
57	GND	GND	
58	I2C_DATA	IN / OUT	3.3V
59	N.C	N.C	
60	I2C_CLK	IN	3.3V
61	N.C	N.C	
62	ALERT#	N.C	3.3V
63	GND	GND	
64	N.C	N.C	
65	N.C	N.C	
66	N.C	N.C	
67	N.C	N.C	
68	N.C	N.C	
69	GND	GND	
70	N.C	N.C	
71	N.C	N.C	
72	+3.3V	PWR	+3.3V
73	N.C	N.C	
74	+3.3V	PWR	+3.3V
75	GND	GND	

2.4.18 COM Port 1~2 (CN27)

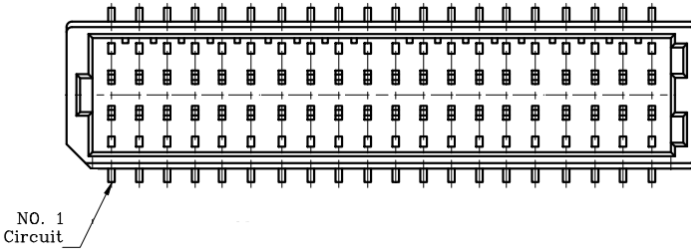

RS-232/422/485

Pin	Pin Name	Signal Type	Signal level
1	COM1: DCD / RS422_TX- / RS485_D-	IN / OUT	±5V
2	COM2: DCD / RS422_TX- / RS485_D-	IN / OUT	±5V
3	COM1: RX / RS422_TX+ / RS485_D+	IN / OUT	±5V
4	COM2: RX / RS422_TX+ / RS485_D+	IN / OUT	±5V
5	COM1: TX / RS422_RX+	OUT / IN	±5V
6	COM2: TX / RS422_RX+	OUT / IN	±5V
7	COM1: DTR / RS422_RX-	OUT / IN	±5V
8	COM2: DTR / RS422_RX-	OUT / IN	±5V
9	COM1: GND	GND	
10	COM2: GND	GND	
11	COM1: DSR	IN	
12	COM2: DSR	IN	
13	COM1: RTS	OUT	±5V
14	COM2: RTS	OUT	±5V
15	COM1: CTS	IN	
16	COM2: CTS	IN	
17	COM1: RI	IN/ PWR	+5V/+12V
18	COM2: RI/+5V/+12V	IN/ PWR	+5V/+12V
19	N.C	N.C	
20	N.C	N.C	

RS-232/422/485			
Pin	Pin Name	Signal Type	Signal level
21	COM3: DCD / RS422_TX- / RS485_D-	IN / OUT	±5V
22	COM4: DCD / RS422_TX- / RS485_D-	IN / OUT	±5V
23	COM3: RX / RS422_TX+ / RS485_D+	IN / OUT	±5V
24	COM4: RX / RS422_TX+ / RS485_D+	IN / OUT	±5V
25	COM3: TX / RS422_RX+	OUT / IN	±5V
26	COM4: TX / RS422_RX+	OUT / IN	±5V
27	COM3: DTR / RS422_RX-	OUT / IN	±5V
28	COM4: DTR / RS422_RX-	OUT / IN	±5V
29	COM3: GND	GND	
30	COM4: GND	GND	
31	COM3: DSR	IN	
32	COM4: DSR	IN	
33	COM3: RTS	OUT	±5V
34	COM4: RTS	OUT	±5V
35	COM3: CTS	IN	
36	COM4: CTS	IN	
37	COM3: RI/+5V/+12V	IN/ PWR	+5V/+12V
38	COM4: RI	IN/ PWR	+5V/+12V
39	N.C	N.C	
40	N.C	N.C	

2.4.19 eSPI Debug Port (CN32)

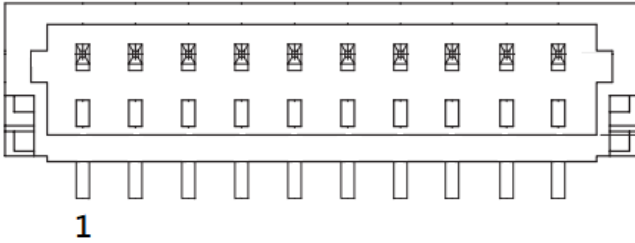

Pin	Pin Name	Signal Type	Signal level
1	ESPI_IO0	I/O	+1.8V
2	ESPI_IO1	I/O	+3.3V
3	ESPI_IO2	I/O	+3.3V
4	ESPI_IO3	I/O	+3.3V
5	+3.3V	PWR	+3.3V
6	ESPI_CS#	IN	
7	ESPI_RST#	OUT	+3.3V
8	GND	GND	
9	ESPI_CLK	OUT	
10	+3.3V	PWR	+3.3V

2.4.20 CPU FAN (CN33)

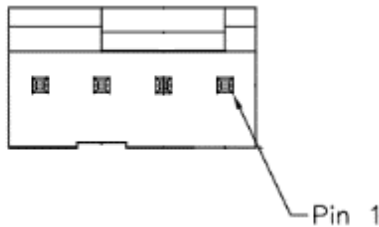

Pin	Pin Name	Signal Type	Signal level
1	GND	GND	
2	FAN_POWER	PWR	+12V

Pin	Pin Name	Signal Type	Signal level
3	FAN_TAC	IN	
4	FAN_CTL	OUT	

2.4.21 External Power Input (CN34)

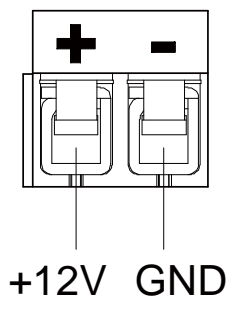

Pin	Pin Name	Signal Type	Signal level
1	+12V	PWR	+9~+36V (or +12V)
2	GND	GND	

2.4.22 Front Panel Connector (CN36)

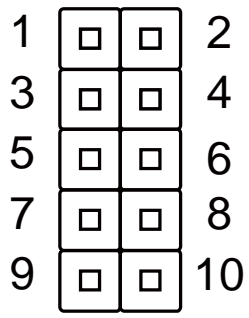

Pin	Function	Pin	Function
1	PWR_BTN-	2	PWR_BTN+
3	HDD_LED-	4	HDD_LED+

Pin	Function	Pin	Function
5	SPEAKER-	6	SPEAKER+
7	PWR_LED-	8	PWR_LED+
9	H/W RESET-	10	H/W RESET+

2.4.23 VGA Port (CN39)

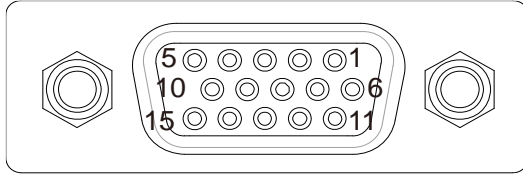

Pin	Pin Name	Signal Type	Signal level
1	RED	OUT	
2	GREEN	OUT	
3	BLUE	OUT	
4	NC		
5	GND	GND	
6	RED_GND_RTN	GND	
7	GREEN_GND_RTN	GND	
8	BLUE_GND_RTN	GND	
9	+5V	PWR	+5V
10	GND	GND	
11	NC		
12	DDC_DATA	I/O	+5V
13	HSYNC	OUT	
14	VSYNC	OUT	
15	DDC_CLK	I/O	+5V

2.4.24 LAN 1 SDP Connector (CN43)

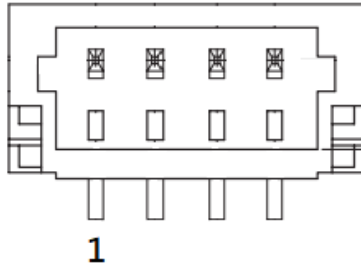

Pin	Pin Name	Signal Type	Signal level
1	SDP0	IN / OUT	
2	SDP0	IN / OUT	
3	SDP0	IN / OUT	
4	SDP0	IN / OUT	

2.4.25 LAN 2 SDP Connector (CN44)

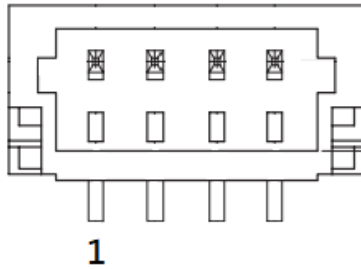

Pin	Pin Name	Signal Type	Signal level
1	SDP0	IN / OUT	
2	SDP0	IN / OUT	
3	SDP0	IN / OUT	
4	SDP0	IN / OUT	

2.4.26 DDR4 SODIMM (DIMM1)

Standard specifications.

2.5 Electrical Specifications for I/O Ports

I/O	Reference	Signal Name	Rate Output
M.2 3052 B-Key	CN6	+3.3VSB	+3.3V/2.0A
M.2 2242 B-Key	CN8	+3.3VSB	+3.3V/1.5A
HDMI Port	CN11	+5V	+5V/0.5A
+5V Output for SATA HDD	CN17	+5V	+5V/1.5A
Digital IO Port	CN18	+5V	+5V/0.5A
Digital IO Port	CN19	+5V	+5V/0.5A
USB 3.1 Ports	CN20	+5VSB	+5V/0.9A (per channel)
USB 2.0 Port	CN21	+5VSB	+5V/0.5A (per channel)
M.2 2280 B-Key	CN25	+3.3VSB	+3.3V/1.5A
M.2 2230 E-Key	CN26	+3.3VSB	+3.3V/1.5A
COM Port 2	CN27	+5V/+12V	+5V/0.5A or +12V/0.5A (per channel)
eSPI Debug Port	CN32	+3.3V	+3.3V/0.5A
CPU Fan	CN33	+12V	+12V/1.0A
VGA Port	CN39	+5V	+5V/1.0A

Chapter 3

AMI BIOS Setup

3.1 System Test and Initialization

These routines check the current system configuration stored in the CMOS memory and BIOS NVRAM. If system configuration is not found or system configuration data error is detected, system will load optimized default and re-boot with this default system configuration automatically.

There are four situations in which you will need to setup system configuration:

1. You are starting your system for the first time
2. You have changed the hardware attached to your system
3. The system configuration is reset by Clear-CMOS jumper
4. The CMOS memory has lost power and the configuration information has been erased.

The GENESYSM-EHL5 CMOS memory has an integral lithium battery backup for data retention. However, you will need to replace the complete unit when it finally runs down.

3.2 AMI BIOS Setup

The AMI BIOS ROM has a pre-installed Setup program that allows users to modify basic system configurations, which is stored in the battery-backed CMOS RAM and BIOS NVRAM so that the information is retained when the power is turned off.

To enter BIOS Setup, press or <ESC> immediately while your computer is powering up.

The function for each interface can be found below.

Main

Set the date, use <Tab> to switch between date elements.

Advanced

Enable/disable boot option for legacy network devices.

Chipset

Host bridge parameters.

Boot

Enables/disables quiet boot option.

Security

Set setup administrator password.

Save & Exit

Exit system setup after saving the changes.

3.3 Setup Submenu: Main



3.4 Setup Submenu: Advanced

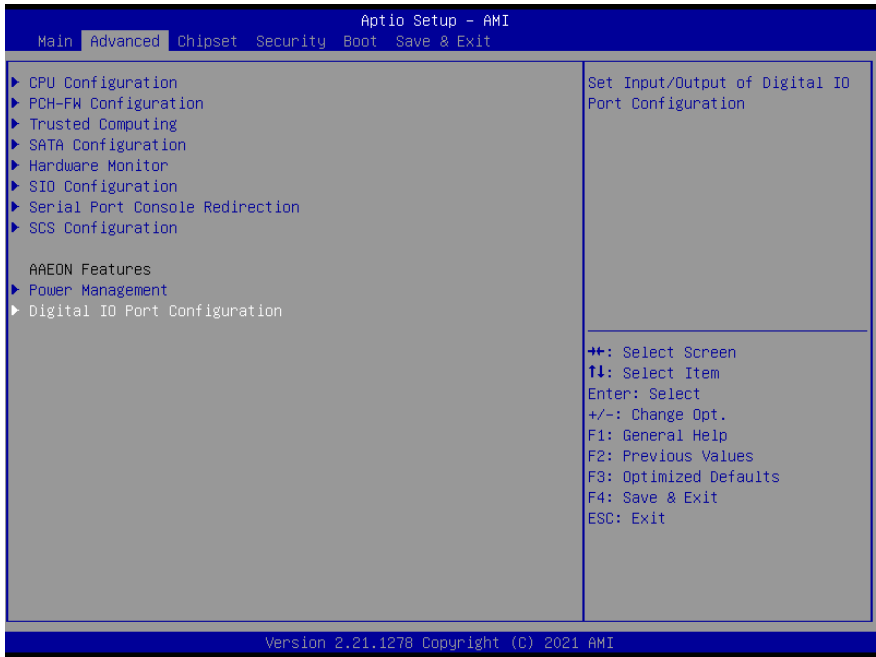

3.4.1 CPU Configuration

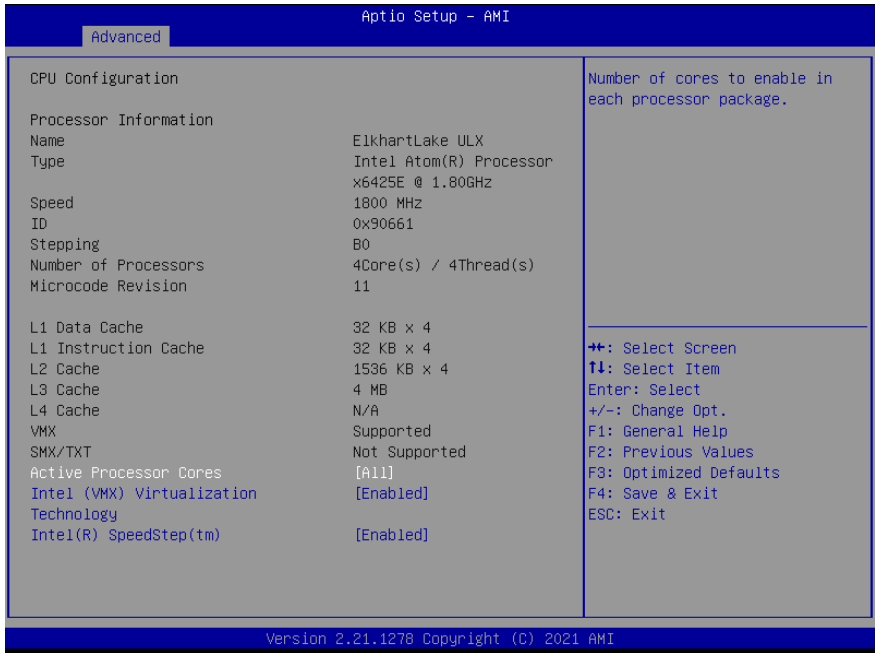

Options Summary		
Active Processor Cores	All	Optimal Default, Failsafe Default
	1~N	
Number of cores to enable in each processor package.		
Intel (VMX) Virtualization Technology	Disabled	
	Enabled	Optimal Default, Failsafe Default
When enabled, a VMM can utilize the additional hardware capabilities provided by Vanderpool Technology.		
Intel® SpeedStep™	Disabled	
	Enabled	Optimal Default, Failsafe Default
Allows more than two frequency ranges to be supported.		

3.4.2 PCH-FW Configuration

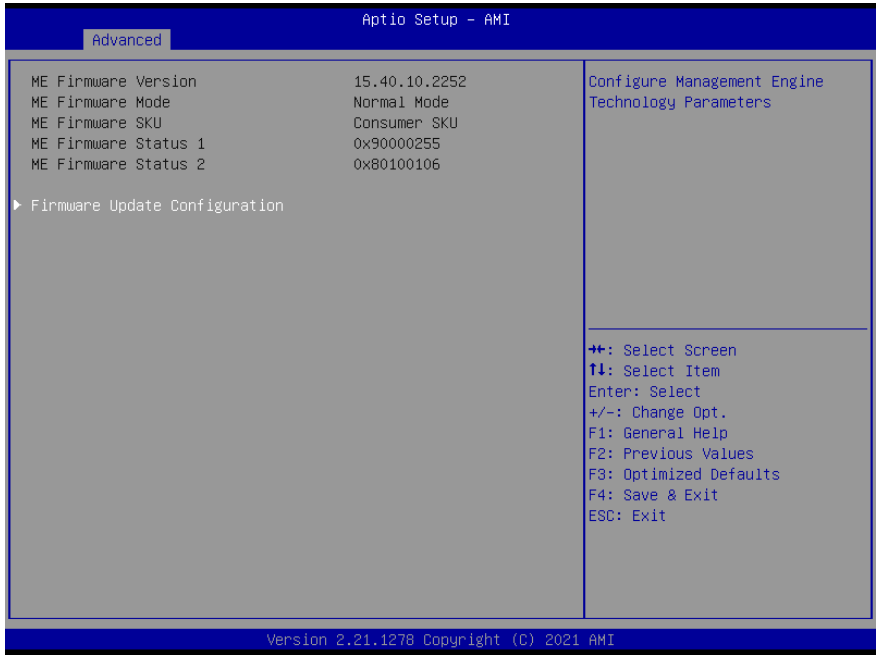

3.4.2.1 Firmware Update Configuration

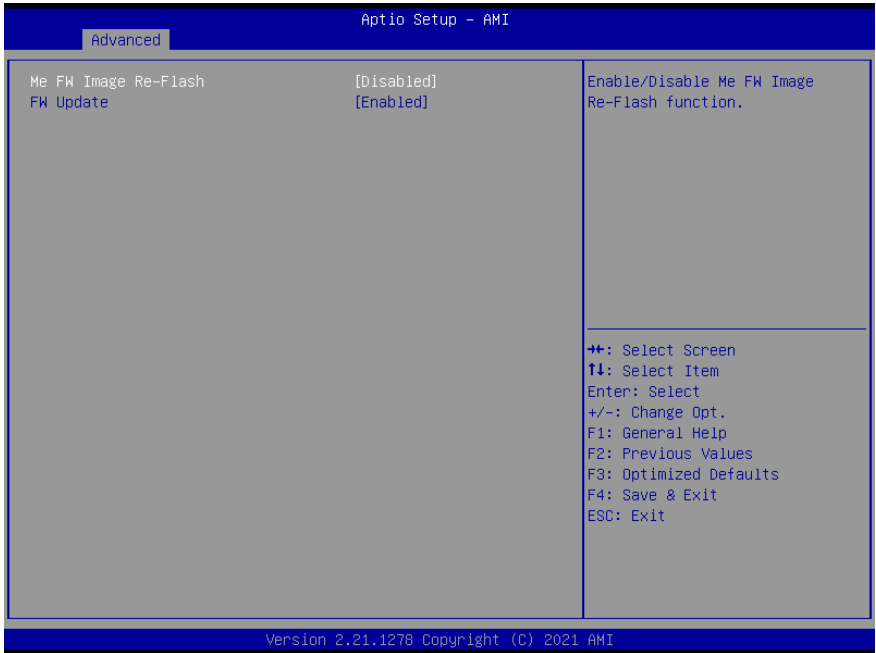

Options Summary		
Me FW Image Re-Flash	Enabled	
	Disabled	Optimal Default, Failsafe Default
Enable/Disable Me FW Image Re-Flash function.		
FW Update	Disabled	
	Enabled	Optimal Default, Failsafe Default
Enable/Disable ME FW Update function.		

3.4.3 Trusted Computing

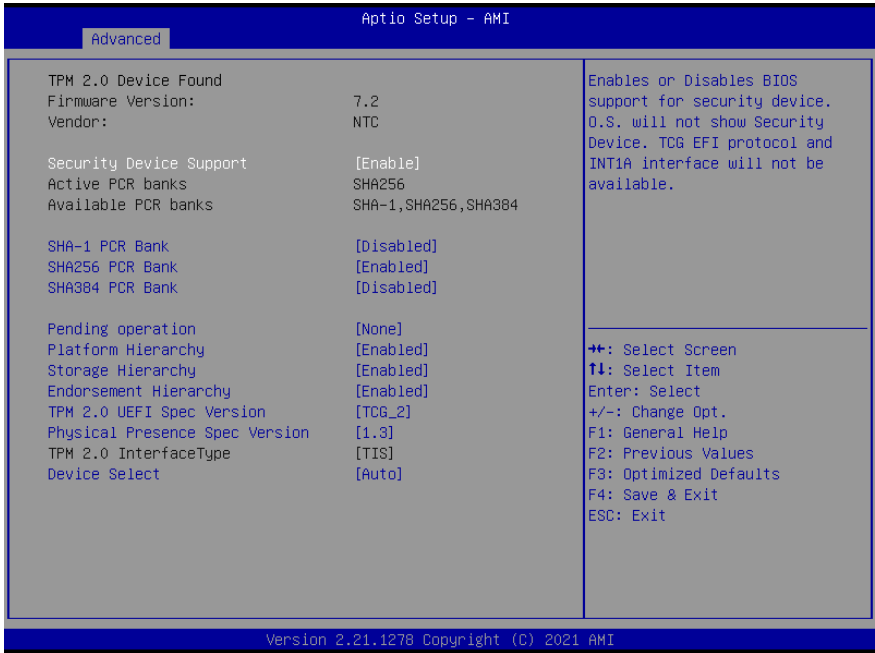

Options Summary		
Security Device Support	Enable	Optimal Default, Failsafe Default
	Disable	
Enables or Disables BIOS support for security device. O.S. will not show Security Device. TCG EFI protocol and INT1A interface will not be available.		
SHA-1 PCR Bank	Disabled	Optimal Default, Failsafe Default
	Enabled	
Enable or Disable SHA-1 PCR Bank.		
SHA256 PCR Bank	Enabled	Optimal Default, Failsafe Default
	Disabled	
Enable or Disable SHA256 PCR Bank.		
SHA384 PCR Bank	Enabled	Optimal Default, Failsafe Default
	Disabled	
Enable or Disable SHA384 PCR Bank.		
SM3_256 PCR Bank	Enabled	Optimal Default, Failsafe Default
	Disabled	

Options Summary		
Enable or Disable SM3_256 PCR Bank.		
Pending operation	None	Optimal Default, Failsafe Default
	TPM Clear	
Schedule an Operation for the Security Device. NOTE: Your Computer will reboot during restart in order to change State of Security Device.		
Platform Hierarchy	Enabled	Optimal Default, Failsafe Default
	Disabled	
Enable or Disable Platform Hierarchy.		
Storage Hierarchy	Enabled	Optimal Default, Failsafe Default
	Disabled	
Enable or Disable Storage Hierarchy.		
Endorsement Hierarchy	Enabled	Optimal Default, Failsafe Default
	Disabled	
Enable or Disable Endorsement Hierarchy.		
TPM 2.0 UEFI Spec Version	TCG_2	Optimal Default, Failsafe Default
	TCG_1_2	
Select the TCH2 Spec Version Support. TCG_1_2: The Compatible mode for Win8/Win10. TCG_2: Support new TCG2 protocol and event format for Win10 or later.		
Physical Presence Spec Version	1.3	Optimal Default, Failsafe Default
	1.2	
Select to Tell O.S. to support PPI Spec Version 1.2 or 1.3. Note some HCK tests might not support 1.3.		
Device Select	Auto	Optimal Default, Failsafe Default
	TPM 1.2	
	TPM 2.0	
TPM 1.2 will restrict support to TPM 1.2 devices. TPM 2.0 will restrict support to TPM 2.0 devices. Auto will support both with the default set to TPM 2.0 devices if not found. TPM 1.2 devices will be enumerated.		

3.4.4 SATA Configuration



Options Summary		
SATA Controller(s)	Enabled	Optimal Default, Failsafe Default
	Disabled	
Enable/Disable SATA Device.		
Port*	Enabled	Optimal Default, Failsafe Default
	Disabled	
Enable or Disable SATA Port.		

3.4.5 Hardware Monitor

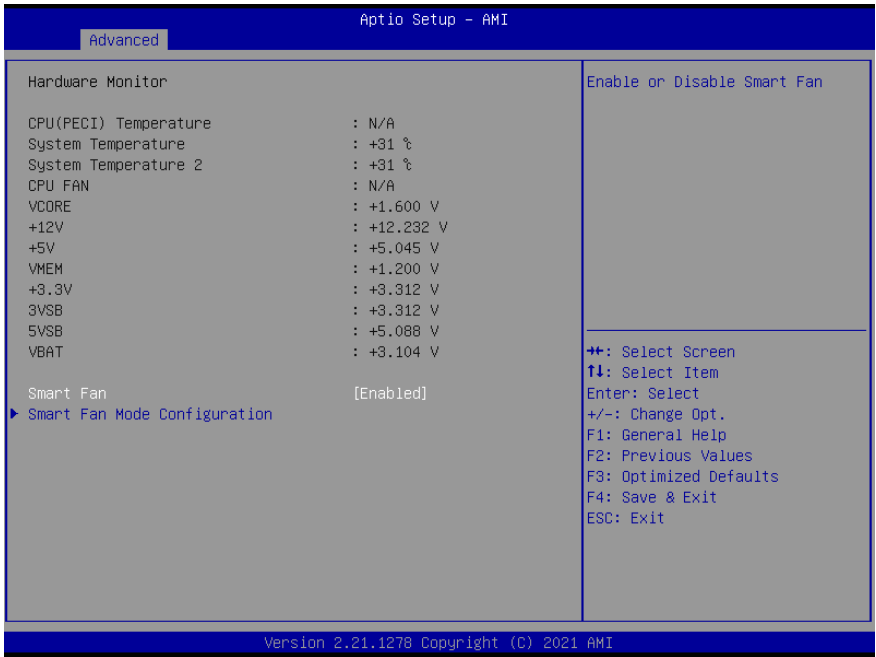

Options Summary		
Smart Fan	Disable	
	Enable	Optimal Default, Failsafe Default
Enables or Disables Smart Fan.		

3.4.5.1 Smart Fan Mode Configuration

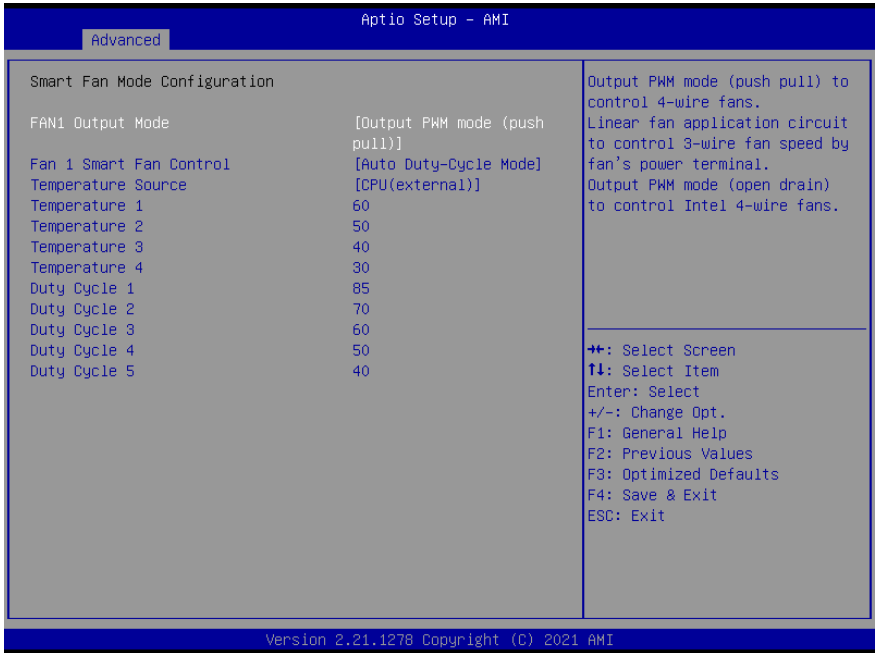

Options Summary		
FAN1 Output Mode	Output PWM mode (open drain)	
	Linear Fan Application	
	Output PWM mode (push pull)	Optimal Default, Failsafe Default
Fan 1 Smart Fan Control	Manual Duty Mode	
	Auto Duty-Cycle Mode	Optimal Default, Failsafe Default
Smart Fan Mode Select.		
Temperature Source	CPU(PECI) Temperature	
	System Temperature	Optimal Default, Failsafe Default
	System Temperature 2	
Select the monitored temperature source for this fan.		
Temperature 1	60	
Duty Cycle 1	85	

Options Summary

Auto fan speed control. Fan speed will follow different temperature by different duty cycle 1-100

3.4.6 SIO Configuration



3.4.6.1 Serial Port 1 Configuration



Options Summary		
Use This Device	Disable	
	Enable	Optimal Default, Failsafe Default
Enable or Disable this Logical Device.		
Possible:	Use Automatic Settings	Optimal Default, Failsafe Default
	IO=3F8h; IRQ=4	
	IO=2F8h; IRQ=3	
Allows user to change Device's Resource settings. New settings will be reflected on This Setup Page after System restarts.		
Mode:	RS232	Optimal Default, Failsafe Default
	RS422	
	RS485	
UART RS232, 422, 485 selection.		

3.4.6.2 Serial Port 2 Configuration

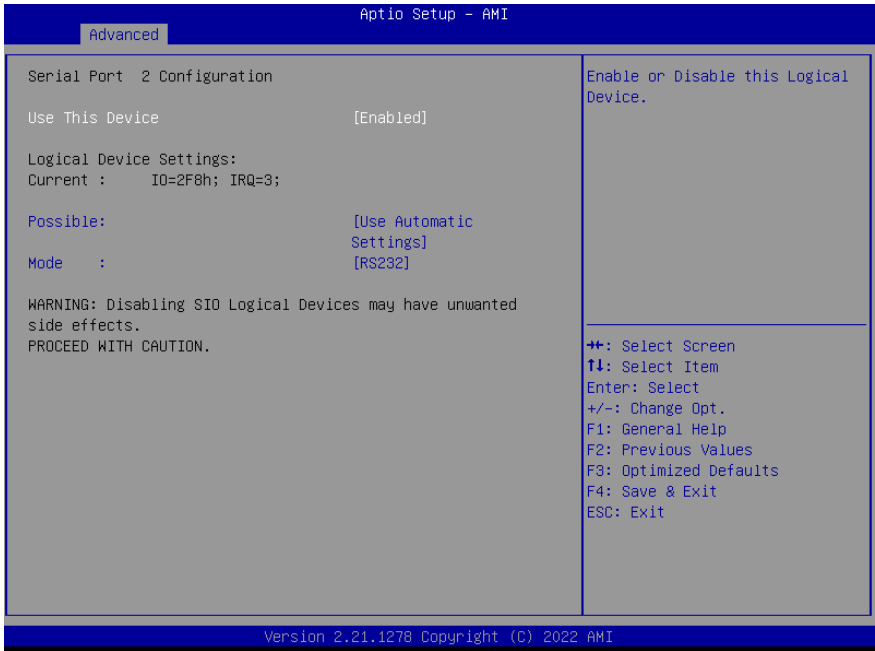

Options Summary		
Use This Device	Disable	
	Enable	Optimal Default, Failsafe Default
Enable or Disable this Logical Device.		
Possible:	Use Automatic Settings	Optimal Default, Failsafe Default
	IO=2F8h; IRQ=3	
	IO=3F8h; IRQ=4	
Allows user to change Device's Resource settings. New settings will be reflected on This Setup Page after System restarts.		
Mode:	RS232	Optimal Default, Failsafe Default
	RS422	
	RS485	
UART RS232, 422, 485 selection.		

3.4.7 Serial Port Console Redirection

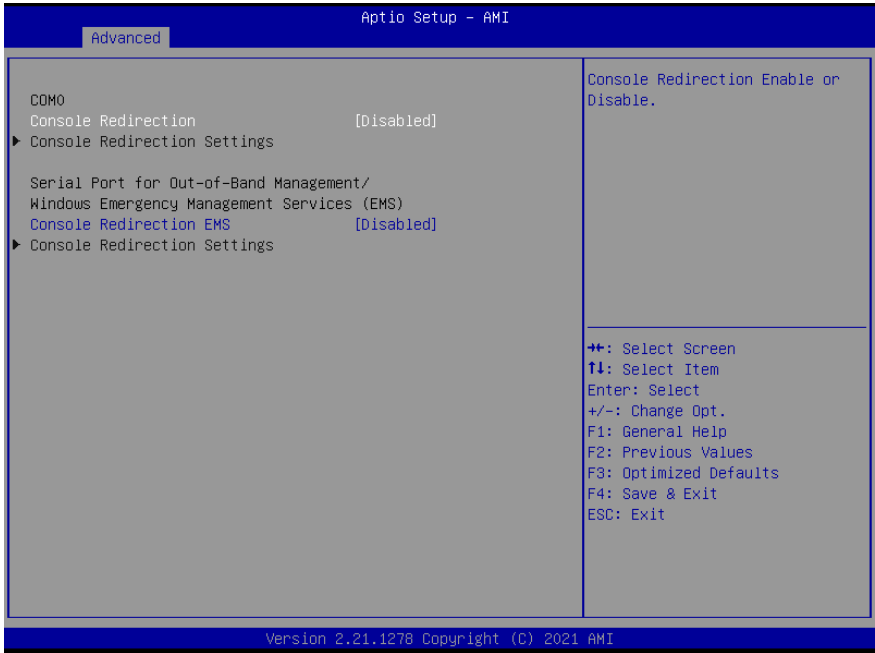

Options Summary		
Console Redirection	Disabled	Optimal Default, Failsafe Default
	Enabled	
Console Redirection Enable or Disable.		
Console Redirection EMS	Disabled	Optimal Default, Failsafe Default
	Enabled	
Console Redirection Enable or Disable.		

3.4.8 SCS Configuration

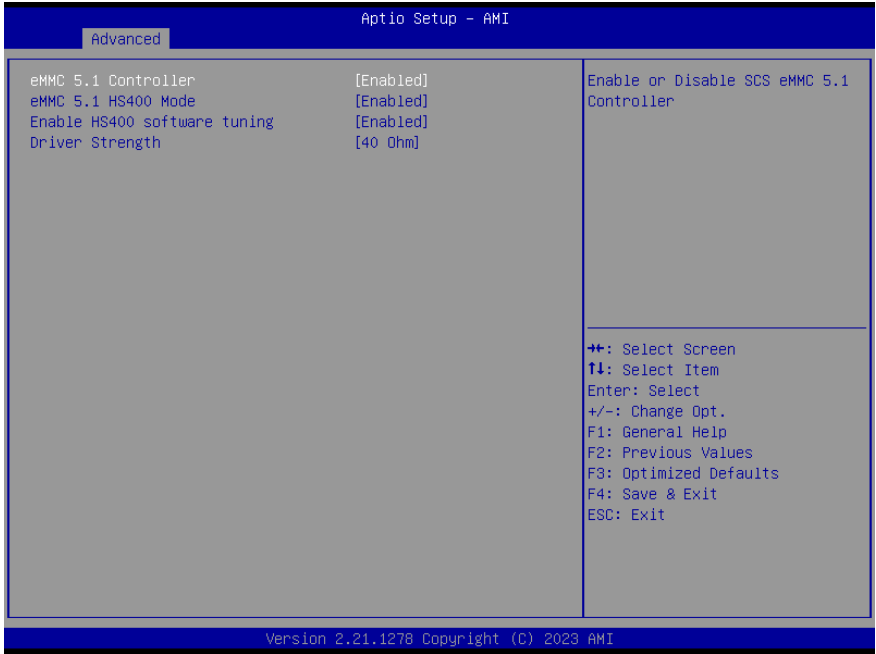

Options Summary		
eMMC 5.1 Controller	Disabled	
	Enabled	Optimal Default, Failsafe Default
Enable or Disable SCS eMMC 5.1 Controller.		
eMMC 5.1 HS400 Mode	Disabled	
	Enabled	Optimal Default, Failsafe Default
Enable or Disable SCS eMMC 5.1 HS400 Mode.		
Enable HS400 software tuning	Disabled	
	Enabled	Optimal Default, Failsafe Default
Software tuning should improve eMMC HS400 stability at the expense of boot time.		
Driver Strength	33 Ohm	
	40 Ohm	Optimal Default, Failsafe Default
	50 Ohm	
Sets I/O driver strength.		

3.4.9 Power Management

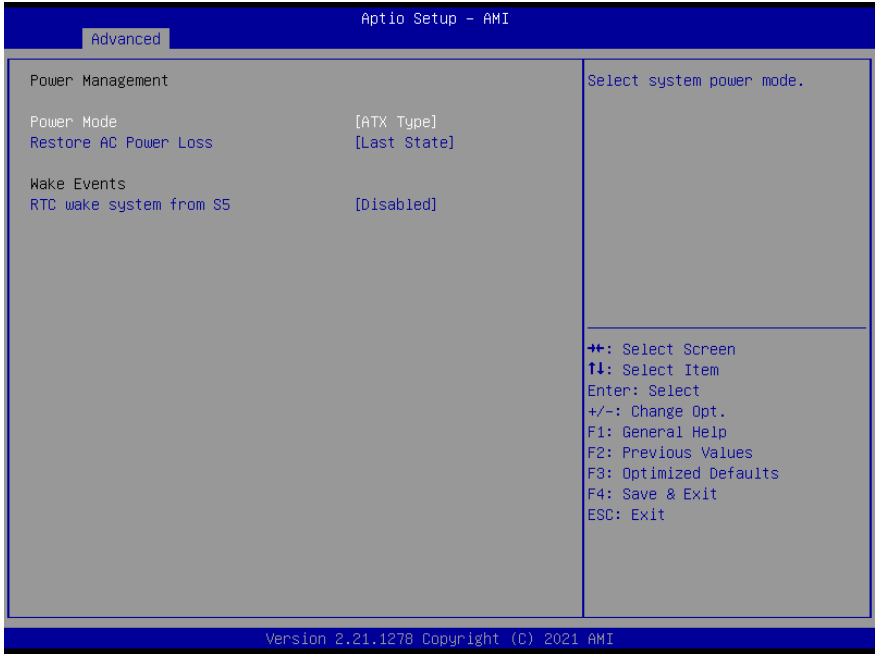

Options Summary		
Power Mode	ATX Type	Optimal Default, Failsafe Default
	AT Type	
Select power supply mode.		
Restore AC Power Loss	Last State	Optimal Default, Failsafe Default
	Always On	
	Always Off	
Select power state when power is re-applied after a power failure.		
RTC wake system from S5	Disable	Optimal Default, Failsafe Default
	Fixed Time	
Fixed Time: System will wake on the hr::min::sec specified./n Dynamic Time: System will wake on the current time + Increase minute(s).		

3.4.10 GPIO Port Configuration

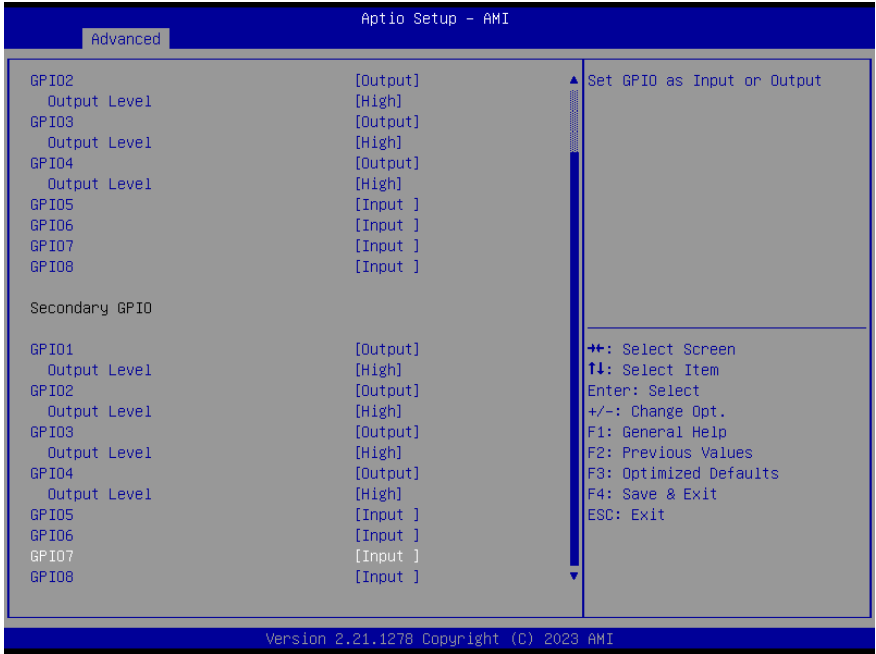

Options Summary		
GPIO Port*	Output	
	Input	
Set GPIO as Input or Output.		
Output Level	High	
	Low	
Set output level when GPIO pin is output		

3.4.11 AAEON BIOS Robot



Options Summary		
Sends watch dog before BIOS POST	Disabled	Optimal Default, Failsafe Default
	Enabled	
Enabled - Robot set Watch Dog Timer (WDT) right after power on, before BIOS start POST process. And then Robot will clear WDT on completion of POST. WDT will reset system automatically if it is not cleared before its timer counts down to zero.		
POST Timer (second)	30	Optimal Default, Failsafe Default
Timer count set to Watch Dog Timer for POST. WARNING: Do not set to a value equal or shorter than normal POST time, otherwise system may never complete POST unless clearing BIOS settings. More than 2x normal POST time is suggested.		
Sends watch dog before booting OS	Disabled	Optimal Default, Failsafe Default
	Enabled	
Enabled - Robot set Watch Dog Timer (WDT) after POST completion, before BIOS transfer control to OS. WARNING: Before enabling this function, a program in OS must be in responsible for clearing WDT. Also, this function should be disabled if OS is going to update itself.		

Options Summary		
OS Timer (minute)	3	Optimal Default, Failsafe Default
Timer count set to Watch Dog Timer for OS loading.		
Delayed POST (PEI phase)	Disabled	Optimal Default, Failsafe Default
	Enabled	
Enabled - Robot holds BIOS from starting POST, right after power on. This allows BIOS POST to start with stable power or start after system is physically warmed-up. Note: Robot does this before 'Sends watch dog'.		
Delayed time (second)	10	Optimal Default, Failsafe Default
Period of time for Robot to hold BIOS from POST.		
Delayed POST (DXE phase)	Disabled	Optimal Default, Failsafe Default
	Enabled	
Enabled - Robot holds BIOS before POST completion. This allows BIOS POST to start with stable power or start after system is physically warmed-up. Note: Robot does this after 'Sends watch dog before BIOS POST'.		
Delayed time (second)	10	Optimal Default, Failsafe Default
Period of time for Robot to hold BIOS from POST.		
Reset system once	Disabled	Optimal Default, Failsafe Default
	Enabled	
Enabled - Robot resets system for one time on each boot. This will send a soft or hard reset to onboard devices, thus puts devices to more stable state.		
Soft or hard reset	Soft reset	Optimal Default, Failsafe Default
	Hard reset"	
Select reset type robot should send on each boot.		

3.4.12 Device Detecting Configuration



Options Summary		
Action	Reset System	Optimal Default, Failsafe Default
	Hold System	
Select action that robot should do.		
Soft or hard reset	Soft	Optimal Default, Failsafe Default
	Hard	
Select reset type robot should send on each boot.		
Retry-Count	3	Optimal Default, Failsafe Default
Fill retry counter here. Robot will reset system at most counter times, and then let system continue its POST.		
At time	After show logo	Optimal Default, Failsafe Default
	Before show logo	
Select robot action time: After show logo - Robot will do action after logo is displayed. System devices are almost ready. Before show logo - Robot will do action earlier before logo, but some devices may not be ready.		

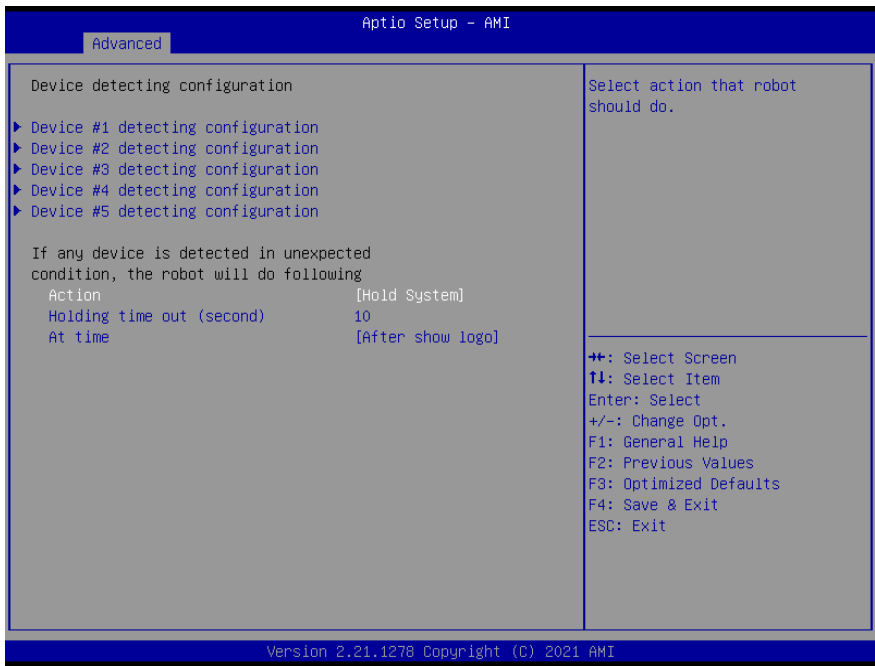

Options Summary		
Action	Reset System	Optimal Default, Failsafe Default
	Hold System	
Select action that robot should do.		
Holding time out (second)	10	Optimal Default, Failsafe Default
Fill hold time out here. Robot will hold system no longer then time-out value, and then let system continue its POST.		
At time	After show logo	Optimal Default, Failsafe Default
	Before show logo	
Select robot action time: After show logo - Robot will do action after logo is displayed. System devices are almost ready. Before show logo - Robot will do action earlier before logo, but some devices may not be ready.		

3.4.12.1 Device #* Detecting Configuration

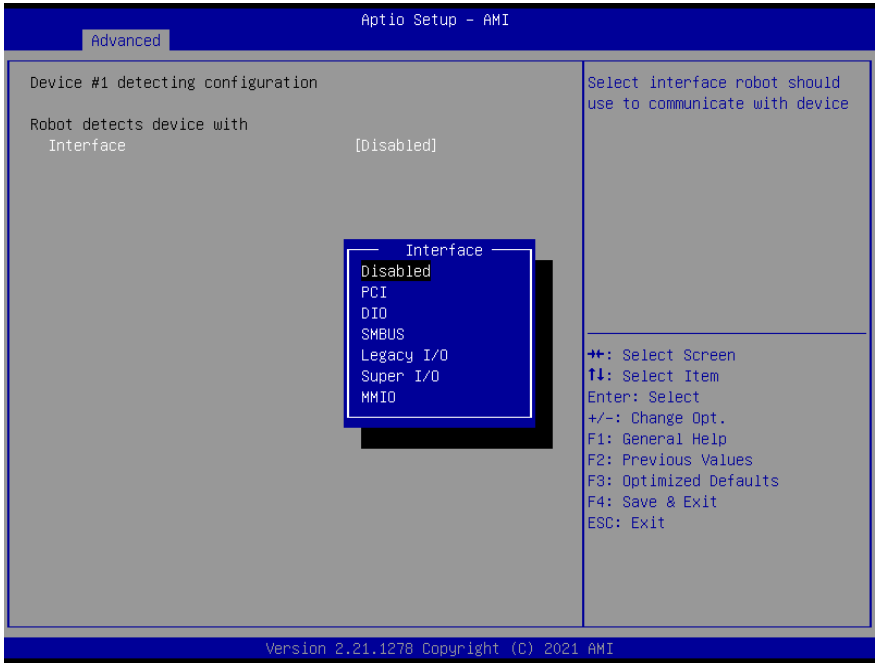

Options Summary		
Interface	Disabled	Optimal Default, Failsafe Default
	PCI	
	DIO	
	SMBUS	
	Legacy I/O	
	Super I/O	
	MMIO	
Select interface robot should use to communicate with device.		

3.4.12.1.1 PCI Interface

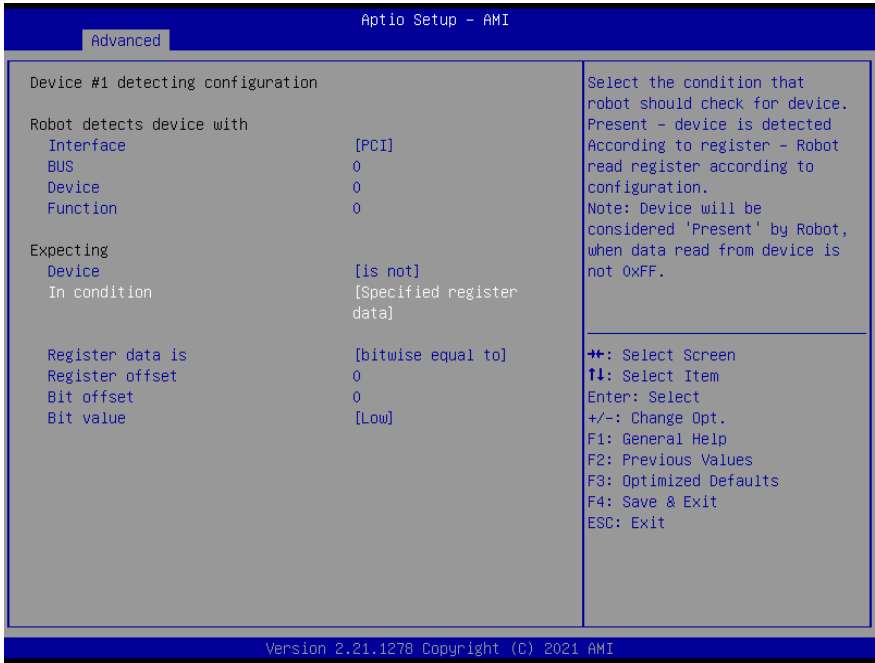

Options Summary – PCI Interface		
BUS	0	Optimal Default, Failsafe Default
Fill BUS number to a PCI device, in hexadecimal. Range: 0 – FF.		
Device	0	Optimal Default, Failsafe Default
Fill DEVICE number to a PCI device, in hexadecimal. Range: 0 – FF.		
Function	0	Optimal Default, Failsafe Default
Fill FUNCTION number to a PCI device, in hexadecimal. Range: 0 – FF.		
Device	is	
	Is not	Optimal Default, Failsafe Default
Select that robot should or should not do action if condition met.		
In condition	Present	Optimal Default, Failsafe Default
	Specified register data	

Options Summary – PCI Interface

Select the condition that robot should check for device.

Present - device is detected According to register - Robot read register according to configuration.

Note: Device will be considered 'Present' by Robot, when data read from device is not 0xFF.

Register data is	bitwise equal to	Optimal Default, Failsafe Default
	byte-wise equal to	
	byte-wise lesser than	
	byte-wise larger than	

Select how robot should compare data read from register, to a value configured below.

Register offset	0	Optimal Default, Failsafe Default
------------------------	---	-----------------------------------

Fill register offset (or index) for robot to read, in hexadecimal. Range: 0 – FF.

Bit offset	0	Optimal Default, Failsafe Default
-------------------	---	-----------------------------------

Fill bit offset for register, for robot to compare with bit value.

Bit value	Low	Optimal Default, Failsafe Default
	High	

Fill bit value for robot to compare register-bit with specified offset.

Byte value	0	Optimal Default, Failsafe Default
-------------------	---	-----------------------------------

Fill a byte value for robot to compare register data with, in hexadecimal. Range: 0 – FF.

3.4.12.12 DIO Interface

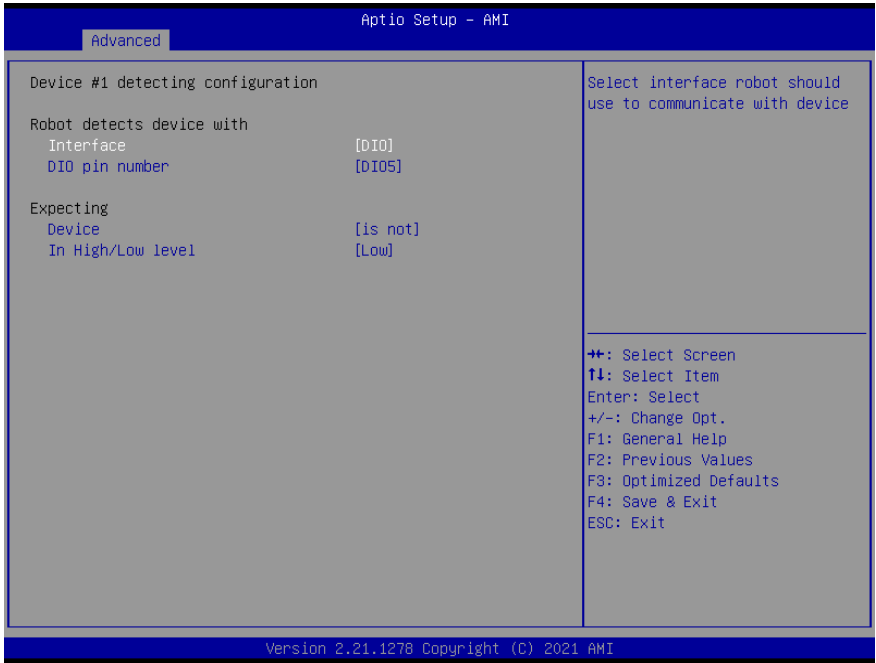

Options Summary – DIO Interface		
Device	is	
	Is not	Optimal Default, Failsafe Default
Select that robot should or should not do action if condition met.		
DIO pin number	DIO1	Optimal Default, Failsafe Default
	DIO*	
Fill DIO pin number.\n0 - DIO0\n1 - DIO1\n... and so on. For COM express product:\n0-3 - GPIO-3\n4-7 - GPO0-3.		
Device	is	
	Is not	Optimal Default, Failsafe Default
Select that robot should or should not do action if condition met.		
In High/Low level	Low	Optimal Default, Failsafe Default
	High	
Select High/Low level of the DIO pin that robot should do action.		

3.4.12.1.3 SMBUS Interface

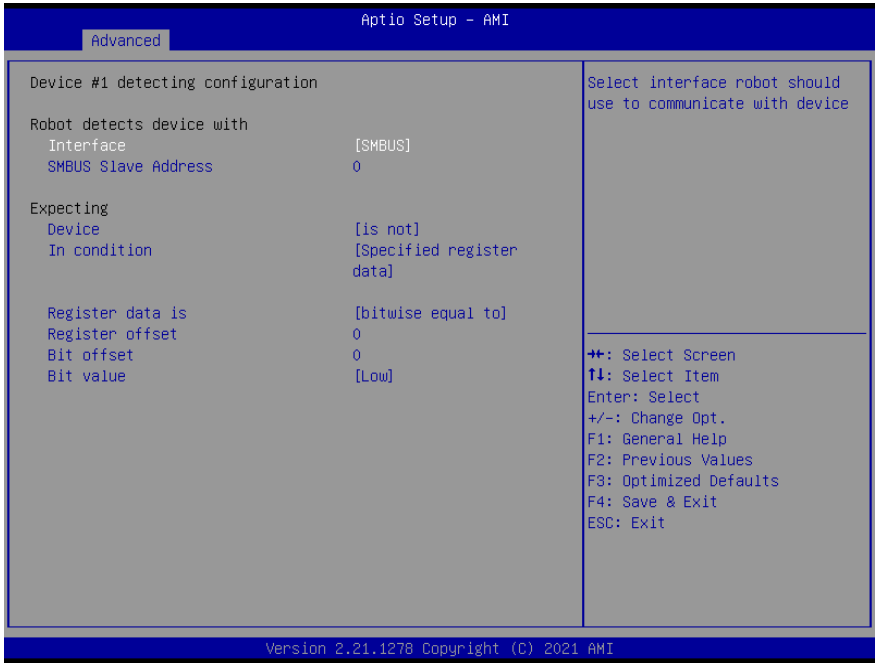

Options Summary – SMBUS Interface		
SMBUS Slave Address	0	Optimal Default, Failsafe Default
Fill slave address to a SMBUS device, in hexadecimal. Range: 0 – FF.		
Device	is	
	Is not	Optimal Default, Failsafe Default
Select that robot should or should not do action if condition met.		
In condition	Present	Optimal Default, Failsafe Default
	Specified register data	
Select the condition that robot should check for device. Present - device is detected. According to register - Robot read register according to configuration. Note: Device will be considered 'Present' by Robot, when data read from device is not 0xFF.		
Register data is	bitwise equal to	Optimal Default, Failsafe Default
	byte-wise equal to	
	byte-wise lesser than	
	byte-wise larger than	
Select how robot should compare data read from register, to a value configured below.		

Options Summary – SMBUS Interface		
Register offset	0	Optimal Default, Failsafe Default
Fill register offset (or index) for robot to read, in hexadecimal. Range: 0 – FF.		
Bit offset	0	Optimal Default, Failsafe Default
Fill bit offset for register, for robot to compare with bit value.		
Bit value	Low	Optimal Default, Failsafe Default
	High	
Fill bit value for robot to compare register-bit with specified offset.		
Byte value	0	Optimal Default, Failsafe Default
Fill a byte value for robot to compare register data with, in hexadecimal. Range: 0 – FF.		

3.4.12.1.4 Legacy I/O Interface

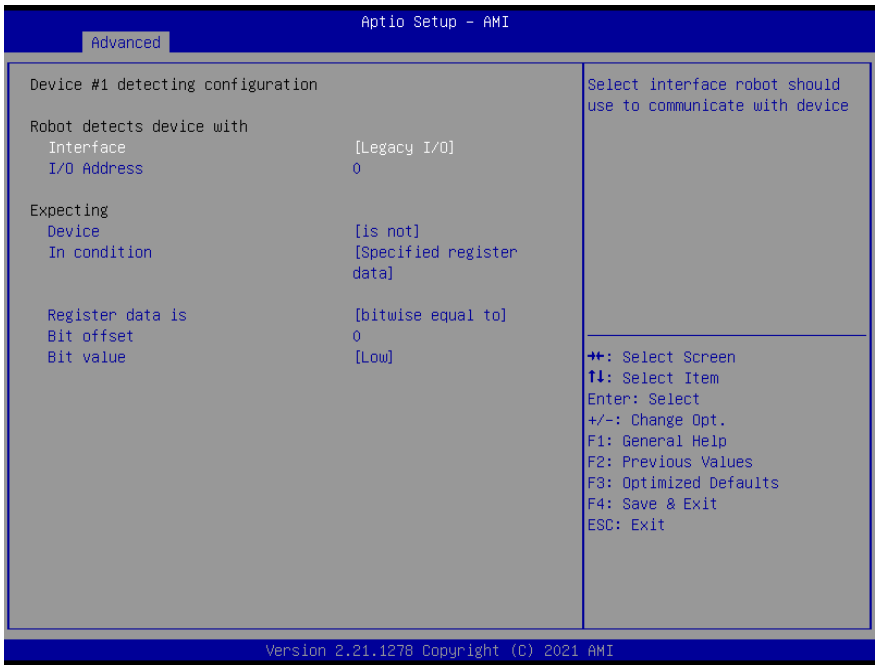

Options Summary – Legacy I/O Interface		
I/O Address	0	Optimal Default, Failsafe Default
Fill I/O address device is responding to. Range: 0~FFFF.		
Device	Is	
	Is not	Optimal Default, Failsafe Default
Select that robot should or should not do action if condition met.		
In condition	Present	Optimal Default, Failsafe Default
	Specified register data	
Select the condition that robot should check for device. Present - device is detected According to register - Robot read register according to configuration. Note: Device will be considered 'Present' by Robot, when data read from device is not 0xFF.		
Register data is	bitwise equal to	Optimal Default, Failsafe Default
	byte-wise equal to	
	byte-wise lesser than	
	byte-wise larger than	
Select how robot should compare data read from register, to a value configured below.		

Options Summary – Legacy I/O Interface		
Bit offset	0	Optimal Default, Failsafe Default
Fill bit offset for register, for robot to compare with bit value.		
Bit value	Low	Optimal Default, Failsafe Default
	High	
Fill bit value for robot to compare register-bit with specified offset.		
Byte value	0	Optimal Default, Failsafe Default
Fill a byte value for robot to compare register data with, in hexadecimal. Range: 0 – FF.		

3.4.12.1.5 Super I/O Interface

The screenshot shows the 'Advanced' menu in the Aptio Setup - AMI BIOS. The 'Super I/O LDN' option is selected, showing a configuration for 'Device #1'. The interface is set to 'Super I/O LDN' with a value of '0'. The 'Expecting' section shows 'Device' as '[is not]' and 'In condition' as '[Specified register data]'. The 'Register data is' section shows 'Register data is' as '[bitwise equal to]', 'Register offset' as '0', 'Bit offset' as '0', and 'Bit value' as '[Low]'. A legend on the right lists navigation keys: ++ for Select Screen, F1 for Select Item, Enter for Select, +/- for Change Opt., F1 for General Help, F2 for Previous Values, F3 for Optimized Defaults, F4 for Save & Exit, and ESC for Exit. The bottom of the screen displays 'Version 2.21.1278 Copyright (C) 2021 AMI'.

Options Summary – Super I/O Interface		
Super I/O LDN	0	Optimal Default, Failsafe Default
Fill LDN number to a Super I/O device. Range: 0~FF.		
Device	is	
	is not	Optimal Default, Failsafe Default
Select that robot should or should not do action if condition met.		

Options Summary – Super I/O Interface

In condition	Present	Optimal Default, Failsafe Default
	Specified register data	
Select the condition that robot should check for device. Present - device is detected According to register - Robot read register according to configuration. Note: Device will be considered 'Present' by Robot, when data read from device is not 0xFF.		
Register data is	bitwise equal to	Optimal Default, Failsafe Default
	bytewise equal to	
	bytewise lesser than	
	bytewise larger than	
Select how robot should compare data read from register, to a value configured below.		
Register offset	0	Optimal Default, Failsafe Default
Fill register offset (or index) for robot to read, in hexadecimal. Range: 0 – FF.		
Bit offset	0	Optimal Default, Failsafe Default
Fill bit offset for register, for robot to compare with bit value.		
Bit value	Low	Optimal Default, Failsafe Default
	High	
Fill bit value for robot to compare register-bit with specified offset.		
Byte value	0	Optimal Default, Failsafe Default
Fill a byte value for robot to compare register data with, in hexadecimal. Range: 0 – FF.		

3.4.12.16 MMIO Interface

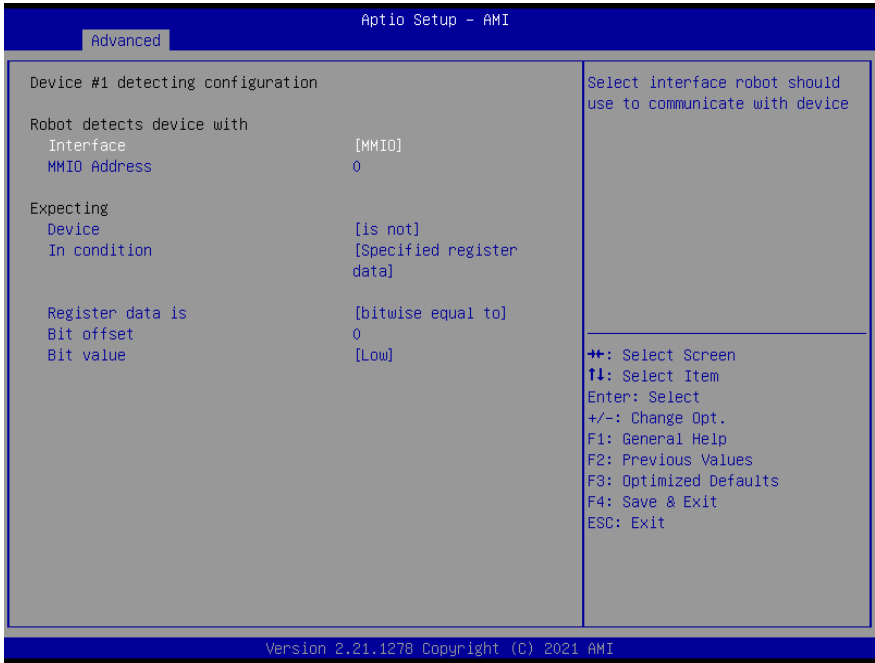

Options Summary – MMIO Interface		
MMIO Address	0	Optimal Default, Failsafe Default
Fill Memory Mapped I/O address device is responding to. Range: 0~FFFFFFFF.		
Device	is	
	Is not	Optimal Default, Failsafe Default
Select that robot should or should not do action if condition met.		
In condition	Present	Optimal Default, Failsafe Default
	Specified register data	
Select the condition that robot should check for device. Present - device is detected According to register - Robot read register according to configuration. Note: Device will be considered 'Present' by Robot, when data read from device is not 0xFF.		
Register data is	bitwise equal to	Optimal Default, Failsafe Default
	byte-wise equal to	
	byte-wise lesser than	
	byte-wise larger than	
Select how robot should compare data read from register, to a value configured below.		

Options Summary – MMIO Interface		
Bit offset	0	Optimal Default, Failsafe Default
Fill bit offset for register, for robot to compare with bit value.		
Bit value	Low	Optimal Default, Failsafe Default
	High	
Fill bit value for robot to compare register-bit with specified offset.		
Byte value	0	Optimal Default, Failsafe Default
Fill a byte value for robot to compare register data with, in hexadecimal. Range: 0 – FF.		

3.5 Setup Submenu: Chipset



3.5.1 System Agent (SA) Configuration

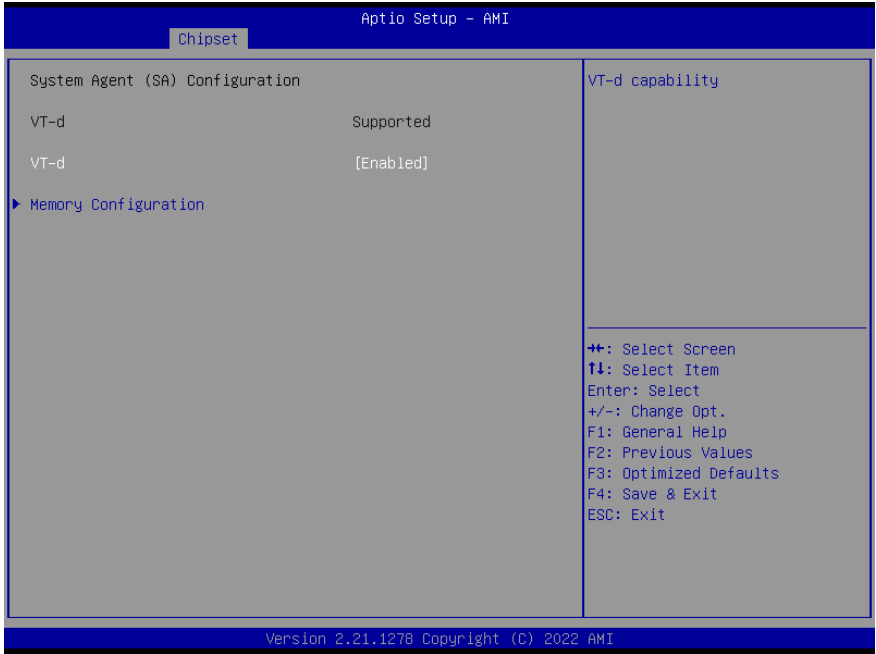

Options Summary		
VT-d	Disabled	
	Enabled	Optimal Default, Failsafe Default
VT-d capability.		

3.5.1.1 Memory Configuration



Options Summary		
In-Band ECC	Disabled	Optimal Default, Failsafe Default
	Enabled	
Enable/Disable In-Band ECC.		

3.6 Setup Submenu: Security

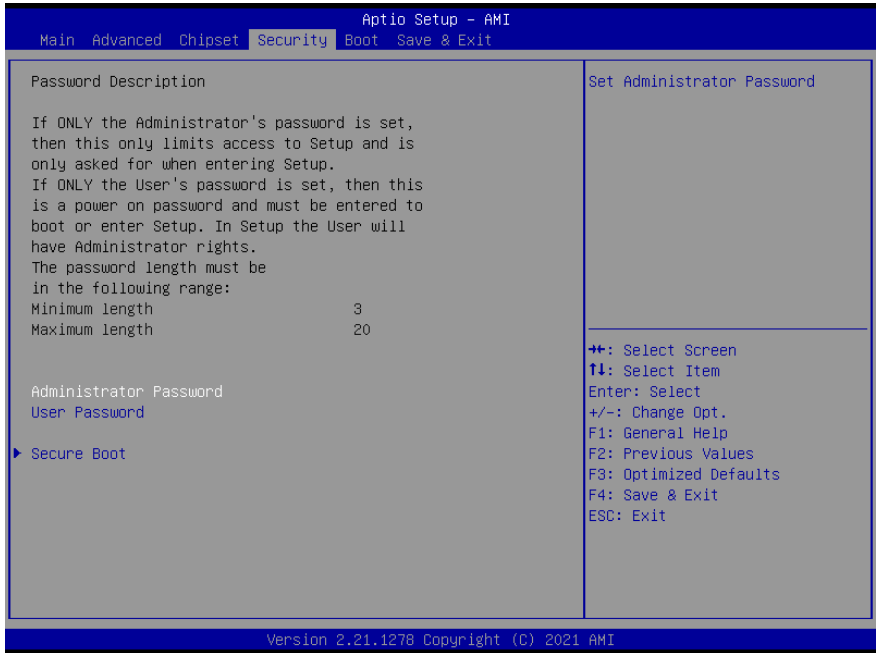

Change User/Administrator Password

You can set an Administrator Password or User Password. An Administrator Password must be set before you can set a User Password. The password will be required during boot up, or when the user enters the Setup utility. A User Password does not provide access to many of the features in the Setup utility.

Select the password you wish to set, and press Enter. In the dialog box, enter your password (must be between 3 and 20 letters or numbers). Press Enter and retype your password to confirm. Press Enter again to set the password.

Removing the Password

Select the password you want to remove and enter the current password. At the next dialog box press Enter to disable password protection.

3.6.1 Secure Boot

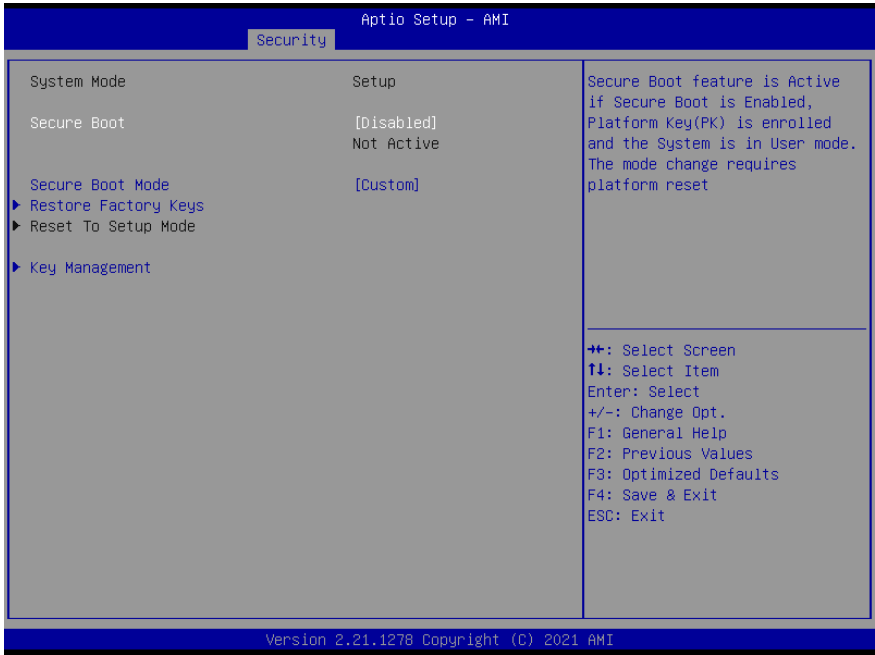

Options Summary		
Secure Boot	Disabled	Optimal Default, Failsafe Default
	Enabled	
Secure Boot feature is Active if Secure Boot is Enabled, Platform Key (PK) is enrolled and the System is in User mode. The mode change requires platform reset.		
Secure Boot Mode	Custom	Optimal Default, Failsafe Default
	Standard	
Secure Boot mode options: Standard or Custom. In Custom mode, Secure Boot Policy variables can be configured by a physically present user without full authentication.		
Restore Factory Keys		
Force System to User Mode. Install factory default Secure Boot key databases.		
Reset to Setup Mode		
Delete all Secure Boot key databases from NVRAM.		

3.6.1.1 Key Management

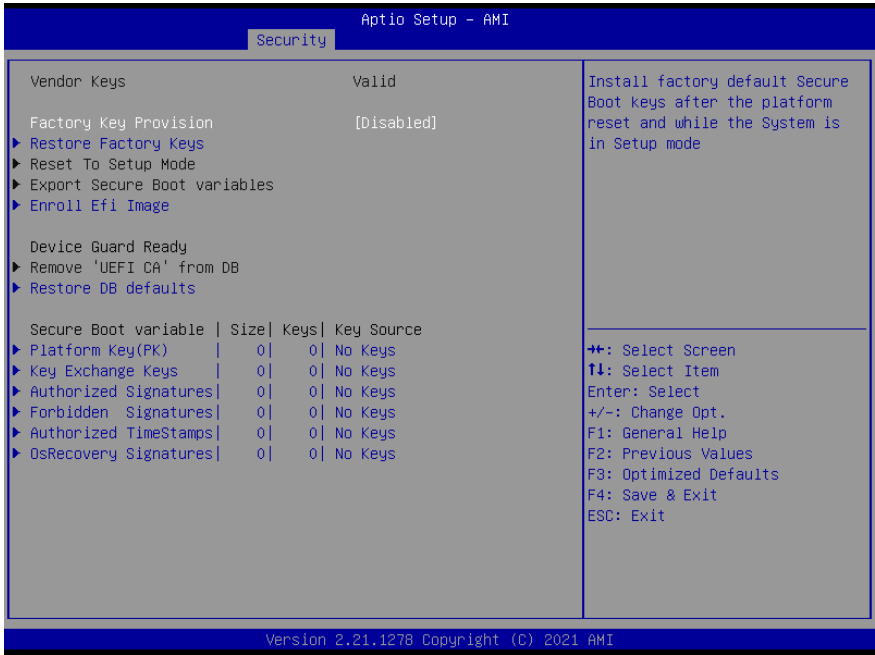

Options Summary		
Factory Key Provision	Disabled	Optimal Default, Failsafe Default
	Enabled	
Secure Boot feature is Active if Secure Boot is Enabled, Platform Key (PK) is enrolled and the System is in User mode. The mode change requires platform reset.		
Restore Factory Keys		
Force System to User Mode. Install factory default Secure Boot key databases.		
Reset to Setup Mode		
Delete all Secure Boot key databases from NVRAM.		
Export Secure Boot variables		
Copy NVRAM content of Secure Boot variables to files in a root folder on a file system device.		
Enroll Efi Image		
Allow the image to run in Secure Boot mode. Enroll SHA256 Hash certificate of a PE image into Authorized Signature Database (db).		
Remove 'UEFI CA' from DB		

Options Summary	
Device Guard ready system must not list 'Microsoft UEFI CA' Certificate in Authorized Signature database (db).	
Restore DB defaults	
Restore DB variable to factory defaults.	
Platform Key (PK)	Details
	Export
	Update
	Delete
Key Exchange Keys	Details
	Export
	Update
	Append
	Delete
Authorized Signatures	Details
	Export
	Update
	Append
	Delete
Forbidden Signatures	Details
	Export
	Update
	Append
	Delete
Authorized TimeStamps	Update
	Append
OsRecovery Signatures	Update
	Append
Enroll Factory Defaults or load certificates from a file:	
1. Public Key Certificate:	
a) EFI_SIGNATURE_LIST	
b) EFI_CERT_X509 (DER)	
c) EFI_CERT_RSA2048 (bin)	
d) EFI_CERT_SHAXXX	
2. Authenticated UEFI Variable.	
3. EFI PE/COFF Image (SHA256).	
Key Source: Factory, External, Mixed.	

3.7 Setup Submenu: Boot

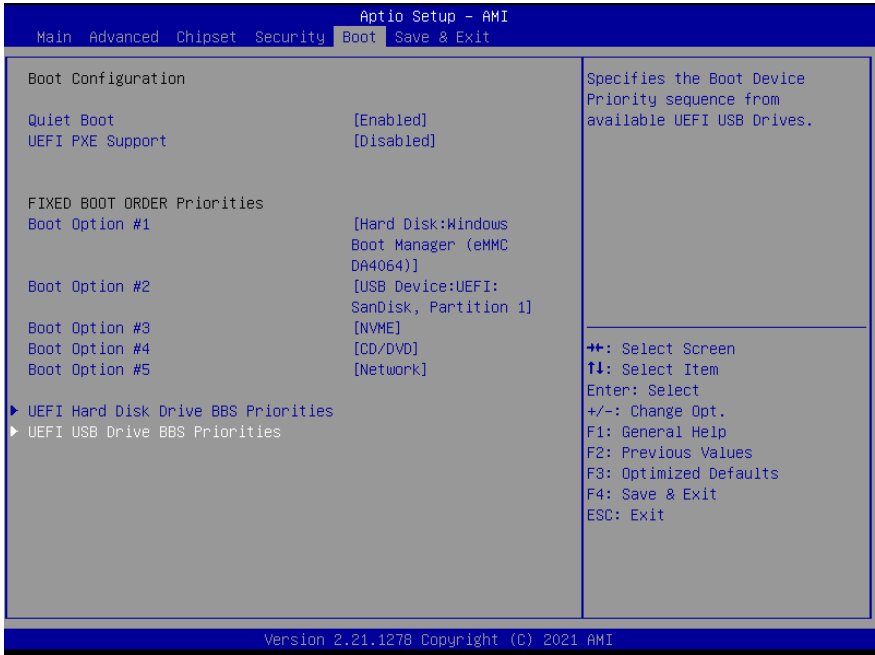

Options Summary		
Quiet Boot	Disabled	
	Enabled	Optimal Default, Failsafe Default
Enable or Disable Quiet Boot option.		
UEFI PXE Support	Disabled	Optimal Default, Failsafe Default
	Enabled	
Enable/Disable UEFI Network Stack.		
FIXED BOOT ORDER Priorities		
Sets the system boot order.		

3.7.1 BBS Priorities



3.8 Setup Submenu: Save & Exit

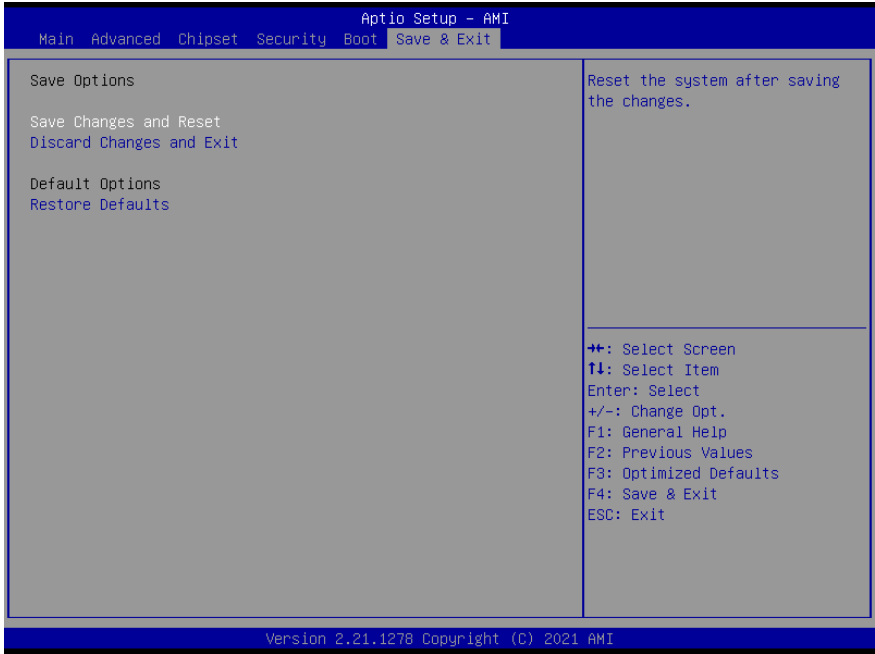

Options Summary	
Save Changes and Reset	Reset the system after saving the changes.
Discard Changes and Exit	Exit system setup without saving any changes.
Restore Defaults	Restore/Load Default values for all the setup options.

Chapter 4

Driver Installation

4.1 Driver Download/Installation

Drivers for the GENESYSM-EHL5 can be downloaded from the product page on the AAEON website by following this link:

<https://www.aaeon.com/en>

Download the driver(s) you need and follow the steps below to install them.

Install Chipset Drivers

1. Open the **Intel Chipset** folder
2. Run the **SetupChipset.exe** in the folder
3. Follow the instructions
4. Drivers will be installed automatically

Install Graphics Drivers

1. Open the **Intel Graphics** folder
2. Run the **igxpin.exe** file in the folder
3. Follow the instructions
4. Drivers will be installed automatically

Install LAN Driver

1. Open the **Intel LAN** folder
2. Run the **PROWinx64.exe** file in the folder
3. Follow the instructions
4. Drivers will be installed automatically

Install Audio Driver

1. Open the **Audio** folder
2. Run the **Setup.exe** file in the folder
3. Follow the instructions
4. Drivers will be installed automatically

Install Serial IO Drivers

1. Open the **Serial IO** folder
2. Follow the instructions
3. Drivers will be installed automatically

Install ME Drivers

1. Open the **ME** folder
2. Run the **SetupME.exe** file in the folder
3. Follow the instructions
4. Drivers will be installed automatically

Peripheral Drivers

1. Open the **Ecilite, PSE_HECI, or PSEIO** folder.
2. Peripheral Drivers .inf files will need to be installed manually.









































Appendix A











I/O Information

A.1 I/O Address Map

GENESYSM Compact Embedded System

GENESYSM-EHL5











































▼		Input/output (IO)
		[0000000000000000 - 000000000000CF7] PCI Express Root Complex
		[0000000000000020 - 000000000000021] Programmable interrupt controller
		[0000000000000024 - 000000000000025] Programmable interrupt controller
		[0000000000000028 - 000000000000029] Programmable interrupt controller
		[000000000000002C - 00000000000002D] Programmable interrupt controller
		[000000000000002E - 00000000000002F] Motherboard resources
		[0000000000000030 - 000000000000031] Programmable interrupt controller
		[0000000000000034 - 000000000000035] Programmable interrupt controller
		[0000000000000038 - 000000000000039] Programmable interrupt controller
		[000000000000003C - 00000000000003D] Programmable interrupt controller
		[0000000000000040 - 000000000000043] System timer
		[000000000000004E - 00000000000004F] Motherboard resources
		[0000000000000050 - 000000000000053] System timer
		[0000000000000061 - 000000000000061] Motherboard resources
		[0000000000000063 - 000000000000063] Motherboard resources
		[0000000000000065 - 000000000000065] Motherboard resources
		[0000000000000067 - 000000000000067] Motherboard resources
		[0000000000000070 - 000000000000070] Motherboard resources
		[0000000000000080 - 000000000000080] Motherboard resources
		[0000000000000092 - 000000000000092] Motherboard resources
		[00000000000000A0 - 0000000000000A1] Programmable interrupt controller
		[00000000000000A4 - 0000000000000A5] Programmable interrupt controller
		[00000000000000A8 - 0000000000000A9] Programmable interrupt controller
		[00000000000000AC - 0000000000000AD] Programmable interrupt controller
		[00000000000000B0 - 0000000000000B1] Programmable interrupt controller
		Motherboard resources
		[00000000000000B2 - 0000000000000B3] Programmable interrupt controller
		[00000000000000B4 - 0000000000000B5] Programmable interrupt controller
		[00000000000000B8 - 0000000000000B9] Programmable interrupt controller
		[00000000000000BC - 0000000000000BD] Programmable interrupt controller
		[00000000000002E8 - 0000000000002EF] Communications Port (COM4)
		[00000000000002F8 - 0000000000002FF] Communications Port (COM2)
		[00000000000003E8 - 0000000000003EF] Communications Port (COM3)
		[00000000000003F8 - 0000000000003FF] Communications Port (COM1)
		[00000000000004D0 - 00000000000004D1] Programmable interrupt controller
		[0000000000000680 - 000000000000069F] Motherboard resources
		[0000000000000A00 - 0000000000000A0F] Motherboard resources
		[0000000000000A10 - 0000000000000A1F] Motherboard resources
		[0000000000000A20 - 0000000000000A2F] Motherboard resources
		[0000000000000D00 - 000000000000FFFF] PCI Express Root Complex
		[000000000000164E - 000000000000164F] Motherboard resources











































-  [000000000000164E - 000000000000164F] Motherboard resources
-  [0000000000001800 - 00000000000018FE] Motherboard resources
-  [0000000000001854 - 0000000000001857] Motherboard resources
-  [0000000000002000 - 00000000000020FE] Motherboard resources
-  [0000000000003000 - 0000000000003FFF] Intel(R) PCI Express Root Port #6 - 4B3E
-  [0000000000004000 - 000000000000403F] Intel(R) UHD Graphics
-  [0000000000004060 - 000000000000407F] Standard SATA AHCI Controller
-  [0000000000004080 - 0000000000004083] Standard SATA AHCI Controller
-  [0000000000004090 - 0000000000004097] Standard SATA AHCI Controller
-  [000000000000EFA0 - 000000000000EFBF] Intel(R) SMBus Controller - 4B23

A.2 Memory Address Map







Address Range	Device Name
[0000000000A0000 - 0000000000BFFFF]	PCI Express Root Complex
[000000007FC00000 - 000000007FC1FFFF]	Intel(R) I210 Gigabit Network Connection
[000000007FC00000 - 000000007FCFFFFFF]	Intel(R) PCI Express Root Port #6 - 4B3E
[000000007FC00000 - 00000000BFFFFFFF]	PCI Express Root Complex
[000000007FC20000 - 000000007FC23FFF]	Intel(R) I210 Gigabit Network Connection
[000000007FD00000 - 000000007FD01FFF]	Standard SATA AHCI Controller
[000000007FD02000 - 000000007FD027FF]	Standard SATA AHCI Controller
[000000007FD03000 - 000000007FD030FF]	Standard SATA AHCI Controller
[00000000C0000000 - 00000000CFFFFFFF]	Motherboard resources
[00000000FD000000 - 00000000FD68FFFF]	Motherboard resources
[00000000FD690000 - 00000000FD69FFFF]	Intel(R) Serial IO GPIO Host Controller - INT1020
[00000000FD6A0000 - 00000000FD6AFFFF]	Intel(R) Serial IO GPIO Host Controller - INT1020
[00000000FD6B0000 - 00000000FD6BFFFF]	Intel(R) Serial IO GPIO Host Controller - INT1020
[00000000FD6B0000 - 00000000FD6CFFFF]	Motherboard resources
[00000000FD6C0000 - 00000000FD6CFFFF]	Intel(R) Serial IO GPIO Host Controller - INT1020
[00000000FD6D0000 - 00000000FD6DFFFF]	Intel(R) Serial IO GPIO Host Controller - INT1020
[00000000FD6E0000 - 00000000FD6EFFFF]	Intel(R) Serial IO GPIO Host Controller - INT1020
[00000000FD6F0000 - 00000000FDFFFFFF]	Motherboard resources
[00000000FE000000 - 00000000FE01FFFF]	Motherboard resources
[00000000FE010000 - 00000000FE010FFF]	Intel(R) SPI (flash) Controller - 4B24
[00000000FE050000 - 00000000FE053FFF]	Unknown device
[00000000FE060000 - 00000000FE063FFF]	Unknown device
[00000000FE200000 - 00000000FE7FFFFFF]	Motherboard resources
[00000000FEC80000 - 00000000FECFFFFFF]	Motherboard resources
[00000000FED00000 - 00000000FED003FF]	High precision event timer
[00000000FED20000 - 00000000FED7FFFF]	Motherboard resources
[00000000FED40000 - 00000000FED44FFF]	Trusted Platform Module 2.0
[00000000FED45000 - 00000000FED8FFFF]	Motherboard resources
[00000000FED90000 - 00000000FED93FFF]	Motherboard resources
[00000000FEDA0000 - 00000000FEDA0FFF]	Motherboard resources
[00000000FEDA1000 - 00000000FEDA1FFF]	Motherboard resources
[00000000FEE00000 - 00000000FEEFFFFFF]	Motherboard resources
[00000000FF000000 - 00000000FFFFFFFF]	Motherboard resources
[0000004000000000 - 000000400FFFFFFF]	Intel(R) UHD Graphics
[0000006000000000 - 0000006000FFFFFF]	Intel(R) UHD Graphics
[0000006001320000 - 000000600132FFFF]	Intel(R) USB 3.10 eXtensible Host Controller - 1.20 (Microsoft)
[000000600133E000 - 000000600133E0FF]	Intel(R) SMBus Controller - 4B23
[000000600133F000 - 000000600133FFFF]	SDA Standard Compliant SD Host Controller
[0000007FFFC00000 - 0000007FFFDFFFFFF]	Intel(R) Integrated Sensor Solution
[0000007FFFEF4000 - 0000007FFFEF5FFF]	Intel(R) Serial IO I2C Host Controller - 4BB9
[0000007FFFEF6000 - 0000007FFFEF7FFF]	Intel(R) Serial IO I2C Host Controller - 4BBD
[0000007FFFEF6000 - 0000007FFFEF7FFF]	Intel(R) Serial IO I2C Host Controller - 4BBD
[0000007FFFEF8000 - 0000007FFFEF9FFF]	Intel(R) Serial IO I2C Host Controller - 4BC0
[0000007FFFEFB000 - 0000007FFFEFBFFF]	Intel(R) Management Engine Interface #1
[0000007FFFEFC000 - 0000007FFFEFFFFFF]	High Definition Audio Controller
[0000007FFFEF0000 - 0000007FFFEFFFFFF]	High Definition Audio Controller
Large Memory	
[0000004000000000 - 0000007FFFFFFF]	PCI Express Root Complex

A.3 IRQ Mapping Chart

▼		Interrupt request (IRQ)	
		(ISA) 0x00000000 (00)	System timer
		(ISA) 0x00000003 (03)	Communications Port (COM2)
		(ISA) 0x00000004 (04)	Communications Port (COM1)
		(ISA) 0x0000000B (11)	Communications Port (COM3)
		(ISA) 0x0000000B (11)	Communications Port (COM4)
		(ISA) 0x0000000E (14)	Intel(R) Serial IO GPIO Host Controller - INTC1020
		(ISA) 0x00000023 (35)	Unknown device
		(ISA) 0x00000024 (36)	Unknown device
		(ISA) 0x00000036 (54)	Microsoft ACPI-Compliant System
		(ISA) 0x00000037 (55)	Microsoft ACPI-Compliant System
		(ISA) 0x00000038 (56)	Microsoft ACPI-Compliant System
		(ISA) 0x00000039 (57)	Microsoft ACPI-Compliant System
		(ISA) 0x0000003A (58)	Microsoft ACPI-Compliant System
		(ISA) 0x0000003B (59)	Microsoft ACPI-Compliant System
		(ISA) 0x0000003C (60)	Microsoft ACPI-Compliant System
		(ISA) 0x0000003D (61)	Microsoft ACPI-Compliant System
		(ISA) 0x0000003E (62)	Microsoft ACPI-Compliant System
		(ISA) 0x0000003F (63)	Microsoft ACPI-Compliant System
		(ISA) 0x00000040 (64)	Microsoft ACPI-Compliant System
		(ISA) 0x00000041 (65)	Microsoft ACPI-Compliant System
		(ISA) 0x00000042 (66)	Microsoft ACPI-Compliant System
		(ISA) 0x00000043 (67)	Microsoft ACPI-Compliant System
		(ISA) 0x00000044 (68)	Microsoft ACPI-Compliant System
		(ISA) 0x00000045 (69)	Microsoft ACPI-Compliant System
		(ISA) 0x00000046 (70)	Microsoft ACPI-Compliant System
		(ISA) 0x00000047 (71)	Microsoft ACPI-Compliant System
		(ISA) 0x00000048 (72)	Microsoft ACPI-Compliant System
		(ISA) 0x00000049 (73)	Microsoft ACPI-Compliant System
		(ISA) 0x0000004A (74)	Microsoft ACPI-Compliant System
		(ISA) 0x0000004B (75)	Microsoft ACPI-Compliant System
		(ISA) 0x0000004C (76)	Microsoft ACPI-Compliant System
		(ISA) 0x0000004D (77)	Microsoft ACPI-Compliant System
		(ISA) 0x0000004E (78)	Microsoft ACPI-Compliant System
		(ISA) 0x0000004F (79)	Microsoft ACPI-Compliant System
		(ISA) 0x00000050 (80)	Microsoft ACPI-Compliant System
		(ISA) 0x00000051 (81)	Microsoft ACPI-Compliant System
		(ISA) 0x00000052 (82)	Microsoft ACPI-Compliant System
		(ISA) 0x00000053 (83)	Microsoft ACPI-Compliant System
		(ISA) 0x00000054 (84)	Microsoft ACPI-Compliant System
		(ISA) 0x00000055 (85)	Microsoft ACPI-Compliant System
		(ISA) 0x00000056 (86)	Microsoft ACPI-Compliant System

	(ISA) 0x000001E8 (488)	Microsoft ACPI-Compliant System
	(ISA) 0x000001E9 (489)	Microsoft ACPI-Compliant System
	(ISA) 0x000001EA (490)	Microsoft ACPI-Compliant System
	(ISA) 0x000001EB (491)	Microsoft ACPI-Compliant System
	(ISA) 0x000001EC (492)	Microsoft ACPI-Compliant System
	(ISA) 0x000001ED (493)	Microsoft ACPI-Compliant System
	(ISA) 0x000001EE (494)	Microsoft ACPI-Compliant System
	(ISA) 0x000001EF (495)	Microsoft ACPI-Compliant System
	(ISA) 0x000001F0 (496)	Microsoft ACPI-Compliant System
	(ISA) 0x000001F1 (497)	Microsoft ACPI-Compliant System
	(ISA) 0x000001F2 (498)	Microsoft ACPI-Compliant System
	(ISA) 0x000001F3 (499)	Microsoft ACPI-Compliant System
	(ISA) 0x000001F4 (500)	Microsoft ACPI-Compliant System
	(ISA) 0x000001F5 (501)	Microsoft ACPI-Compliant System
	(ISA) 0x000001F6 (502)	Microsoft ACPI-Compliant System
	(ISA) 0x000001F7 (503)	Microsoft ACPI-Compliant System
	(ISA) 0x000001F8 (504)	Microsoft ACPI-Compliant System
	(ISA) 0x000001F9 (505)	Microsoft ACPI-Compliant System
	(ISA) 0x000001FA (506)	Microsoft ACPI-Compliant System
	(ISA) 0x000001FB (507)	Microsoft ACPI-Compliant System
	(ISA) 0x000001FC (508)	Microsoft ACPI-Compliant System
	(ISA) 0x000001FD (509)	Microsoft ACPI-Compliant System
	(ISA) 0x000001FE (510)	Microsoft ACPI-Compliant System
	(ISA) 0x000001FF (511)	Microsoft ACPI-Compliant System
	(PCI) 0x00000010 (16)	High Definition Audio Controller
	(PCI) 0x00000010 (16)	SDA Standard Compliant SD Host Controller
	(PCI) 0xFFFFFFFF (-18)	Intel(R) Serial IO I2C Host Controller - 4BB9
	(PCI) 0xFFFFFFFF (-17)	Intel(R) Serial IO I2C Host Controller - 4BBD
	(PCI) 0xFFFFFFFF0 (-16)	Intel(R) Serial IO I2C Host Controller - 4BC0
	(PCI) 0xFFFFFFFF1 (-15)	Intel(R) Integrated Sensor Solution
	(PCI) 0xFFFFFFFF2 (-14)	Intel(R) Management Engine Interface #1
	(PCI) 0xFFFFFFFF3 (-13)	Intel(R) I210 Gigabit Network Connection
	(PCI) 0xFFFFFFFF4 (-12)	Intel(R) I210 Gigabit Network Connection
	(PCI) 0xFFFFFFFF5 (-11)	Intel(R) I210 Gigabit Network Connection
	(PCI) 0xFFFFFFFF6 (-10)	Intel(R) I210 Gigabit Network Connection
	(PCI) 0xFFFFFFFF7 (-9)	Intel(R) I210 Gigabit Network Connection
	(PCI) 0xFFFFFFFF8 (-8)	Intel(R) I210 Gigabit Network Connection
	(PCI) 0xFFFFFFFF9 (-7)	Intel(R) USB 3.10 eXtensible Host Controller - 1.20 (Microsoft)
	(PCI) 0xFFFFFFFFFA (-6)	Intel(R) UHD Graphics
	(PCI) 0xFFFFFFFFFB (-5)	Standard SATA AHCI Controller
	(PCI) 0xFFFFFFFFFC (-4)	Intel(R) PCI Express Root Port #1 - 4B39
	(PCI) 0xFFFFFFFFFD (-3)	Intel(R) PCI Express Root Port #0 - 4B38

A.4 DMA Channel Assignments

- ▼  Direct memory access (DMA)
 -  0 Intel(R) Serial IO I2C Host Controller - 4BB9
 -  0 Intel(R) Serial IO I2C Host Controller - 4BBD
 -  1 Intel(R) Serial IO I2C Host Controller - 4BB9
 -  1 Intel(R) Serial IO I2C Host Controller - 4BBD
 -  6 Intel(R) Serial IO I2C Host Controller - 4BC0
 -  7 Intel(R) Serial IO I2C Host Controller - 4BC0

Appendix B

Mating Connectors and Cables

B.1 Mating Connectors and Cables

Label	Function	Mating Connector		Available Cable	Cable P/N
		Vendor	Model no		
CN1	RTC Battery	Molex	51021-0200	Battery Cable	175011301C
CN4	Amplifier R-channel output	Molex	51021-0200	N/A	N/A
CN5	Amplifier L-channel output	Molex	51021-0200	N/A	N/A
CN16	SATA port	Molex	887505318	SATA Cable	1709070500
CN17	+5V Output for SATA HDD	JST	PHR-2	SATA Power Cable	1702150155
CN18 CN19	Digital IO Port	ACES	50247-010H0H0-001	N/A	N/A
CN21 CN22	USB 2.0 Port	ACES	50247-010H0H0-001	USB2.0 Cable	170010010D
CN27	COM Port 1~2	JCTC	HSG:11002H00-2*20P TER:11002TOP-2E	COM Cable	170X000568
CN32	eSPI Debug Port	JST	SHR-10V-S-B	N/A	N/A
CN33	CPU FAN	Molex	47054-1000	N/A	N/A
CN34	External Power Input	Molex	19211-0003	Power Cable	170204010R
CN36	Front Panel	Molex	51110-1050	N/A	N/A
CN43 CN44	LAN1&2 SDP Connector	JST	SHR-04V-S-B	N/A	N/A