



GENE-TWL7

3.5" Subcompact Board

User's Manual 2nd Ed

Copyright Notice

This document is copyrighted, 2026. All rights are reserved. The original manufacturer reserves the right to make improvements to the products described in this manual at any time without notice.

No part of this manual may be reproduced, copied, translated, or transmitted in any form or by any means without the prior written permission of the original manufacturer. Information provided in this manual is intended to be accurate and reliable. However, the original manufacturer assumes no responsibility for its use, or for any infringements upon the rights of third parties that may result from its use.

The material in this document is for product information only and is subject to change without notice. While reasonable efforts have been made in the preparation of this document to assure its accuracy, AAEMON assumes no liabilities resulting from errors or omissions in this document, or from the use of the information contained herein.

AAEMON reserves the right to make changes in the product design without notice to its users.

Acknowledgements

All other products' name or trademarks are properties of their respective owners.

- Microsoft Windows is a registered trademark of Microsoft Corp.
- Intel Core is a trademark of Intel Corporation
- Realtek is a trademark of Realtek Semiconductor Corporation.
- Ubuntu is a trademark of Canonical.
- Linux is the registered trademark of Linus Torvalds in the U.S. and other countries

All other product names or trademarks are properties of their respective owners.

Packing List

Before setting up your product, please make sure the following items have been shipped:

Item	Quantity
• GENE-TWL7	1

If any of these items are missing or damaged, please contact your distributor or sales representative immediately.

About this Document

This User's Manual contains all the essential information, such as detailed descriptions and explanations on the product's hardware and software features (if any), its specifications, dimensions, jumper/connector settings/definitions, and driver installation instructions (if any), to facilitate users in setting up their product.

Users may refer to the product page at AAEON.com for the latest version of this document.

Safety Precautions

Please read the following safety instructions carefully. It is advised that you keep this manual for future references

1. All cautions and warnings on the device should be noted.
2. Make sure the power source matches the power rating of the device.
3. Position the power cord so that people cannot step on it. Do not place anything over the power cord.
4. Always completely disconnect the power before working on the system's hardware.
5. No connections should be made when the system is powered as a sudden rush of power may damage sensitive electronic components.
6. If the device is not to be used for a long time, disconnect it from the power supply to avoid damage by transient over-voltage.
7. Always disconnect this device from any AC supply before cleaning.
8. While cleaning, use a damp cloth instead of liquid or spray detergents.
9. Make sure the device is installed near a power outlet and is easily accessible.
10. Keep this device away from humidity.
11. Place the device on a solid surface during installation to prevent falls
12. Do not cover the openings on the device to ensure optimal heat dissipation.
13. Watch out for high temperatures when the system is running.
14. Do not touch the heat sink or heat spreader when the system is running
15. Never pour any liquid into the openings. This could cause fire or electric shock.
16. As most electronic components are sensitive to static electrical charge, be sure to ground yourself to prevent static charge when installing the internal components. Use a grounding wrist strap and contain all electronic components in any static-shielded containers.

17. If any of the following situations arises, please the contact our service personnel:
 - i. Damaged power cord or plug
 - ii. Liquid intrusion to the device
 - iii. Exposure to moisture
 - iv. Device is not working as expected or in a manner as described in this manual
 - v. The device is dropped or damaged
 - vi. Any obvious signs of damage displayed on the device
18. **DO NOT LEAVE THIS DEVICE IN AN UNCONTROLLED ENVIRONMENT WITH TEMPERATURES BEYOND THE DEVICE'S PERMITTED STORAGE TEMPERATURES (SEE CHAPTER 1) TO PREVENT DAMAGE.**

FCC Statement

Warning!



This device complies with Part 15 FCC Rules. Operation is subject to the following two conditions: (1) this device may not cause harmful interference, and (2) this device must accept any interference received including interference that may cause undesired operation.

Caution:

There is a danger of explosion if the battery is incorrectly replaced. Replace only with the same or equivalent type recommended by the manufacturer. Dispose of used batteries according to the manufacturer's instructions and your local government's recycling or disposal directives.

Attention:

Il y a un risque d'explosion si la batterie est remplacée de façon incorrecte. Ne la remplacer qu'avec le même modèle ou équivalent recommandé par le constructeur. Recycler les batteries usées en accord avec les instructions du fabricant et les directives gouvernementales de recyclage.

产品中有毒有害物质或元素名称及含量

AAEON 主板/子板/背板

QO4-381 Rev.A2

部件名称	有毒有害物质或元素					
	铅 (Pb)	汞 (Hg)	镉 (Cd)	六价铬 (Cr(VI))	多溴联苯 (PBB)	多溴二苯醚 (PBDE)
印刷电路板 及其电子组件	×	○	○	○	○	○
外部信号 连接器及线材	×	○	○	○	○	○

本表格依据 SJ/T 11364 的规定编制。

○：表示该有毒有害物质在该部件所有均质材料中的含量均在GB/T 26572标准规定的限量要求以下。

×：表示该有害物质的某一均质材料超出了GB/T 26572的限量要求，然而该部件仍符合欧盟指令2011/65/EU 的规范。

环保使用期限(EFUP (Environmental Friendly Use Period))：10年

备注：此产品所标示之环保使用期限，系指在一般正常使用状况下。

China RoHS Requirement (EN)

Name and content of hazardous substances in product

AAEON Main Board/Daughter Board/Backplane

QQ4-381 Rev.A2

Part Name	Hazardous Substances					
	铅 (Pb)	汞 (Hg)	镉 (Cd)	六价铬 (Cr(VI))	多溴联苯 (PBB)	多溴二苯醚 (PBDE)
PCB Assemblies	×	○	○	○	○	○
Connector and Cable	×	○	○	○	○	○

The table is prepared in accordance with the provisions of SJ/T 11364.

○: Indicates that said hazardous substance contained in all of the homogenous materials for this product is below the limit requirement of GB/T 26572.

×: Indicates that said hazardous substance contained in at least one of the homogenous materials used for this part is above the limit requirement of GB/T 26572. But this product still be compliance with 2011/65/EU Directive (allowed with 2011/65/EU Annex III of RoHS exemption with number 6(c),7(a),7(c)-1).

EFUP (Environment Friendly Use Period) value: 10 years

Notes: This product defined period of use is under normal condition.

Table of Contents

Chapter 1 - Product Specifications	1
1.1 Specifications	2
1.2 Block Diagram	5
Chapter 2 – Hardware Information	6
2.1 Dimensions	7
2.2 Jumpers and Connectors.....	9
2.3 List of Jumpers	11
2.3.1 Auto Power Button Enable/Disable (JP1).....	11
2.3.2 COM Port Function Selection (JP2/JP3)	12
2.3.3 LVDS Power Selection& LVDS BKLK Power Selection (JP4/JP6).....	13
2.3.4 Clear CMOS Jumper (JP5).....	14
2.4 List of Connectors.....	15
2.4.1 USB 2.0 Connector (CN1/CN11/CN24/CN25)	16
2.4.2 Fan Connector (CN2)	16
2.4.3 +5V Output for SATA HDD (CN4)	17
2.4.4 Port 80 Debug Port (CN5)	18
2.4.5 SPI Flash Programming Port (CN6).....	19
2.4.6 Front Panel (CN7).....	19
2.4.7 I2C/SMBus Header (CN8)	20
2.4.8 SATA Connector (CN9).....	21
2.4.9 Audio Pin Header (CN10).....	21
2.4.10 12V DC Input Terminal Block Connector (CN13).....	22
2.4.11 External +5VSB Input (CN14).....	23
2.4.12 GPIO Port (CN15).....	23
2.4.13 COM Port (CN16/CN17/CN18/CN19)	24

2.4.14	M.2 2280 M-Key Slot (CN20).....	25
2.4.15	LVDS Connector (CN21/CN32).....	27
2.4.16	LVDS Inverter/Backlight Connector (CN22/CN31)	29
2.4.17	RTC Battery Connector (CN23).....	29
2.4.18	HDMI Port (CN26).....	30
2.4.19	Display Port (CN27).....	31
2.4.20	Dual LAN Port (CN28).....	32
2.4.21	Dual USB 3.2 Gen 2 Port (CN29).....	33
2.4.22	DDR5 SODIMM Slot (CN33).....	34
2.4.23	Full-size Mini Card/mSATA Slot (CN34).....	41
2.4.24	M.2 2230 E-Key Slot (CN35).....	43
2.5	Thermal Solutions.....	46
2.5.1	Heatsink Optional Accessory - GENE-APL7-HSK01.....	46
Chapter 3 - AMI BIOS Setup.....		48
3.1	System Test and Initialization.....	49
3.2	AMI BIOS Setup.....	50
3.3	Setup Submenu: Main.....	51
3.4	Setup Submenu: Advanced.....	52
3.4.1	CPU Configuration.....	53
3.4.2	PCH-FW Configuration.....	54
3.4.3	Firmware Update Configuration.....	55
3.4.4	PTT Configuration.....	56
3.4.5	Trusted Computing.....	57
3.4.6	SATA Configuration.....	59
3.4.7	Hardware Monitor.....	60
3.4.7.1	Smart Fan Mode Configuration.....	61
3.4.8	SIO Configuration.....	62

3.4.8.1	Serial Port 1 Configuration	63
3.4.8.2	Serial Port 2 Configuration	64
3.4.8.3	Serial Port 3 Configuration	65
3.4.8.4	Serial Port 4 Configuration	66
3.4.9	Serial Port Console Redirection	67
3.4.10	Legacy Console Redirection Settings.....	68
3.4.11	AAEON BIOS Robot	69
3.4.11.1	Device Detecting Configuration	71
3.4.11.2	Device #1 ~ #5 Detecting Configuration.....	72
3.4.12	Power Management.....	73
3.4.13	GPIO Port Configuration	74
3.5	Setup Submenu: Chipset	75
3.5.1	System Agent (SA) Configuration.....	76
3.5.2	Memory Configuration	77
3.5.3	LVDS Panel Configuration	78
3.5.4	PCH-IO Configuration	80
3.6	Setup Submenu: Security.....	81
3.6.1	Secure Boot.....	82
3.6.2	Key Management.....	83
3.7	Setup Submenu: Boot	85
3.7.1	BBS Priorities	86
3.8	Setup Submenu: Save & Exit.....	87
Chapter 4	– Driver Installation	88
4.1	Driver Download/Installation	89
Appendix A	- I/O Information.....	92
A.1	I/O Address Map	93
A.2	Large Memory	95

A.3	Memory Address Map	96
A.3	IRQ Mapping Chart.....	97
Appendix B – Mating Connectors and Cables.....		111
B.1	Mating Connectors and Cables.....	112

Chapter 1

Product Specifications

1.1 Specifications

System

Form Factor	3.5" SubCompact Board
CPU	Intel® Processor N150 (4C/4T, up to 3.6 GHz, 6W) Intel® Core™ 3 Processor N355 (8C/8T, up to 3.9 GHz, 15W)
Chipset	Integrated with Intel® SoC
Memory Type	DDR5 4800, Single Channel SODIMM x 1, Max. 16GB, Non-ECC
BIOS	AMI UEFI 256 Mbit
Wake on LAN	Yes
Watchdog Timer	255 Levels
Security	TPM 2.0
RTC Battery	Lithium Battery 3V/240mAh
Dimensions	5.75" x 4" (146mm x 101.7mm)
Weight	1.1 lb (0.3 kg)
OS Support	Windows® 11 (64-bit) Ubuntu 24.04.2 / Kernel 6.11.0-17-generic

Power

Power Requirement	+12V, Support ERP
Power Supply Type	AT/ATX
Connector	2-pin Phoenix Connector 4-pin ATX Connector (optional)
Power Consumption	TBC

Display

Controller	Intel® UHD Graphics
LVDS/eDP	LVDS 1: Dual Channel 18/24-bit, up to 1920 x 1080 (co-lay eDP, by COM change) LVDS 2: Dual Channel 18/24-bit, up to 1920 x 1080
Display Interface	HDMI 1.4b x 1, up to 3840 x 2160 @144Hz DP 1.4a x 1, up to 3840 x 2160 @120Hz
Multiple Display	Up to 3 Simultaneous Displays

Audio

Codec	CMedia CM9825
Audio Interface	Line-In / Line-Out / Mic
Speaker	—

External I/O

Ethernet	Intel® Ethernet Controller I226, 2.5GbE x 2
USB	USB 3.2 Gen 2 x 2
Serial Port	—
Video	HDMI 1.4b x 1 DP x 1

Internal I/O

USB	USB 2.0 x 4
Serial Port	COM 1, COM 2 (RS-232/422/485, supports 5V/12V/RI) COM 3, COM 4 (RS-232)
Video	LVDS x 2 Inverter x 1 (12V/2A)
SATA	SATA 6Gb/s x 1 +5V SATA Power Connector x 1

Internal I/O

Audio	Audio Header x 1 (Line-in / Line-out / Mic)
DIO/GPIO	GPIO 8-bit
SMBus/I2C	SMBus / I2C x 1 (Default: SMBus)
Touch	—
Fan	4-pin Smart Fan x 1
Sim	—
Front Panel	PWR LED, HDD LED, PWR Button, HW Reset

Expansion

Mini PCIe/mSATA	Full-size Mini PCIe / mSATA x 1 (Default: PCIe [x1] x 1, USB 2.0, SATA select by BIOS)
M.2	M.2 2230 E-Key x 1 (PCIe [x1], USB 2.0) M.2 2280 M-Key x 1 (PCIe 3.0 [x2])
Others	—

Environmental

Operating Temp.	32°F – 140°F (0°C – 60°C)
Storage Temp.	-40°F – 185°F (-40°C – 85°C)
Operating Humidity	0% – 90% relative humidity, non-condensing
MTBF (Hours)	957,274
EMC	CE/FCC Class A

1.2 Block Diagram

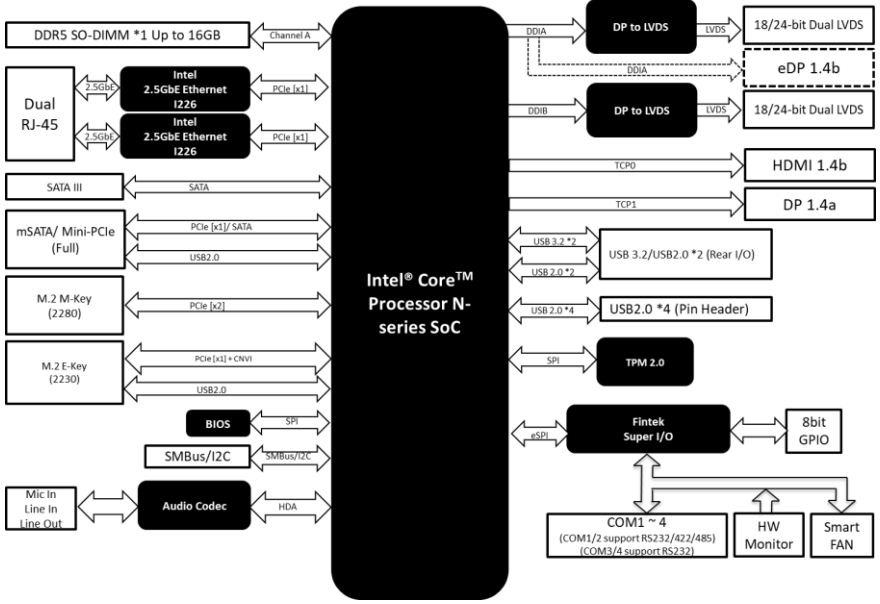

Chapter 2

Hardware Information

2.1 Dimensions

Top View

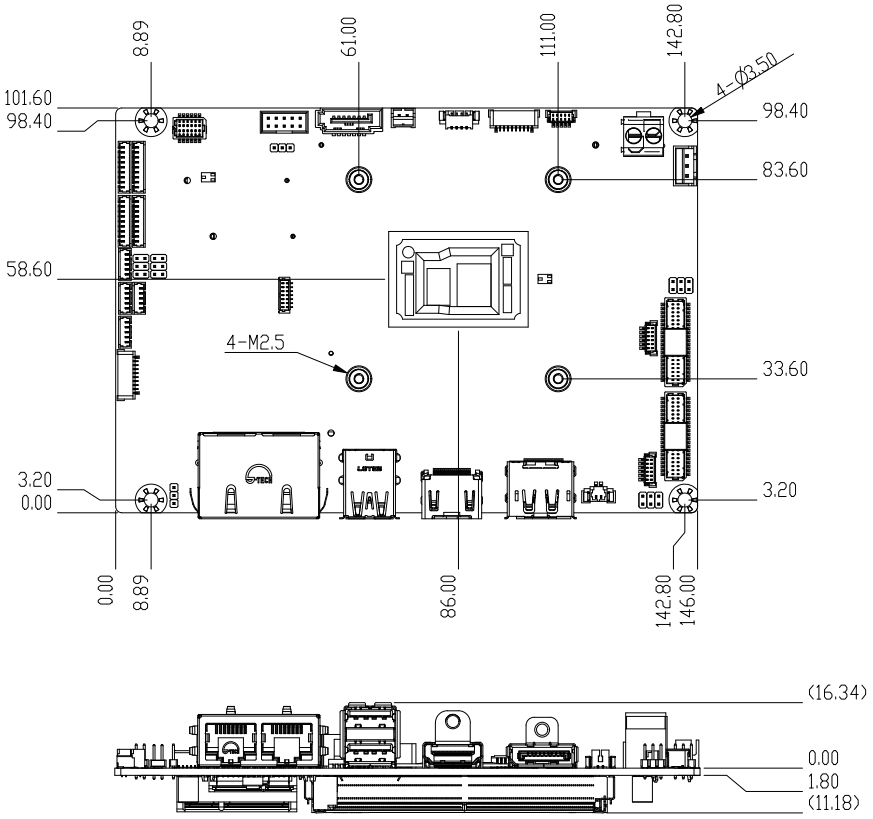

Bottom View

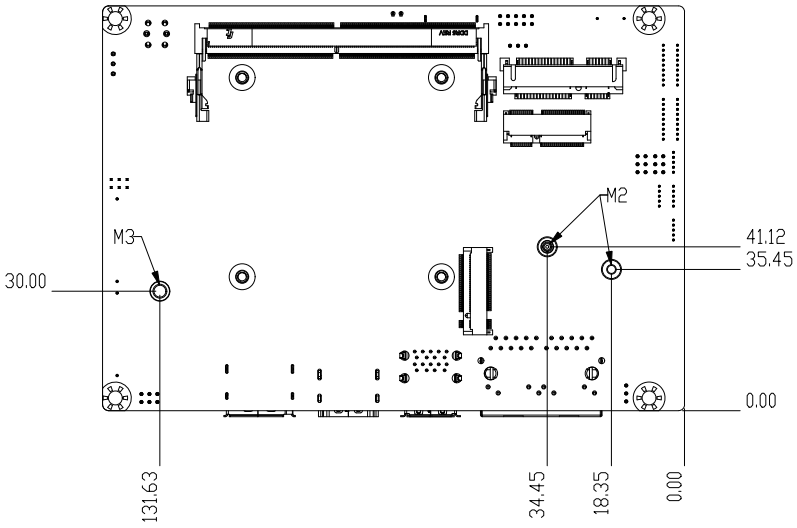

3D View

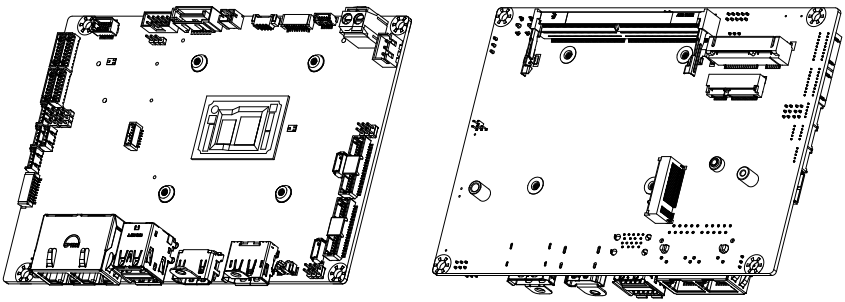

2.2 Jumpers and Connectors

Top View

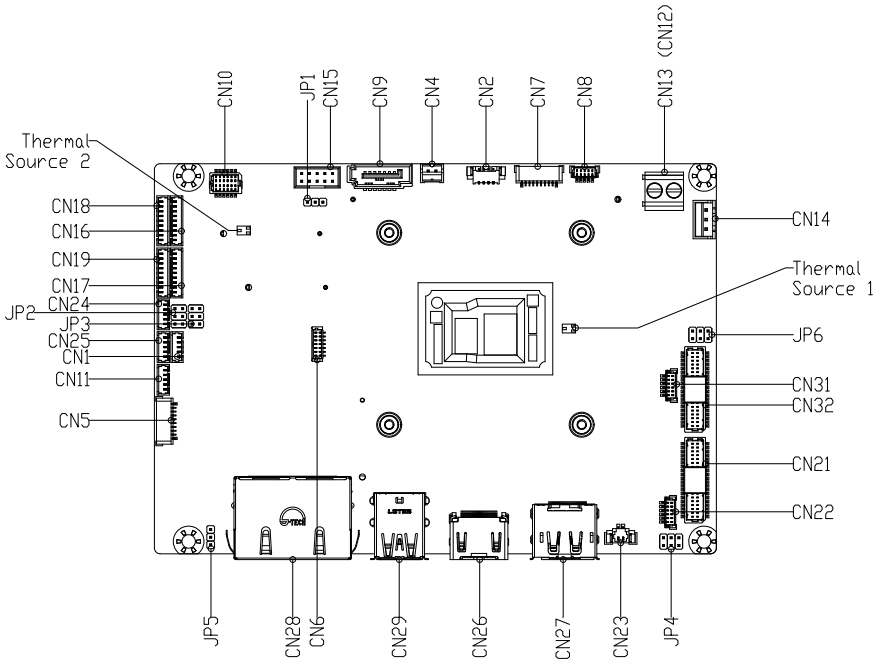

Bottom View

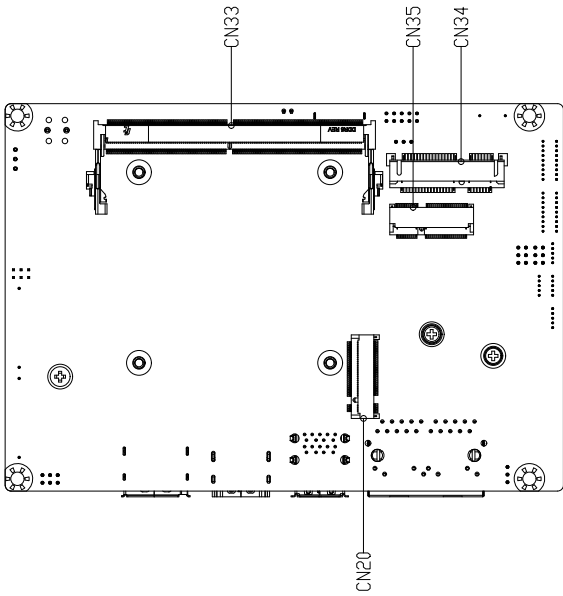

2.3 List of Jumpers

Please refer to the table below for all of the board's jumpers that you can configure for your application

Label	Function
JP1	Auto Power Button Enable/Disable
JP2/JP3	COM Port Function Selection
JP4/JP6	LVDS Power Selection& LVDS BKLT Power Selection
JP5	Clear CMOS Jumper

2.3.1 Auto Power Button Enable/Disable (JP1)

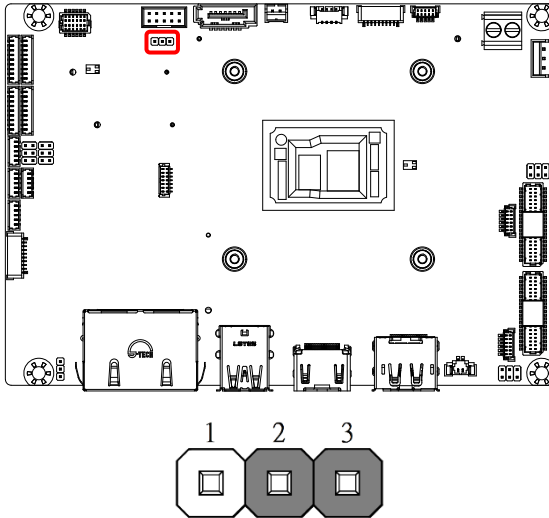

Auto Power Button Enable/Disable

1-2	Disable - ATX	
2-3	Enable - AT	Default

2.3.2 COM Port Function Selection (JP2/JP3)

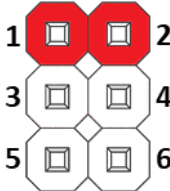
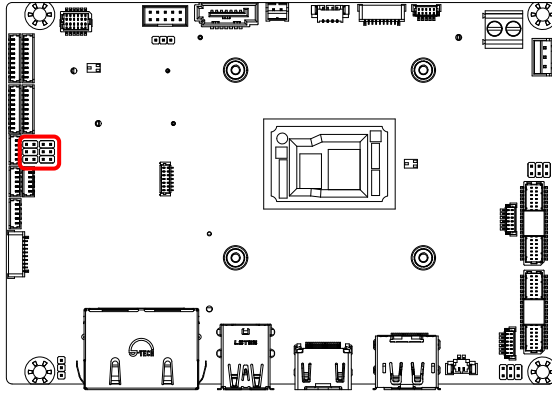

+12V

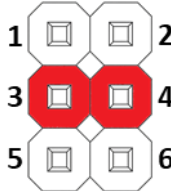

Ring (Default)

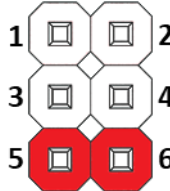

+5V

COM Port Function Selection

1-2	12V	
3-4	Ring	Default
5-6	5V	

Note: JP2 controls CN18, JP3 controls CN19.

2.3.3 LVDS Power Selection & LVDS BKLT Power Selection (JP4/JP6)

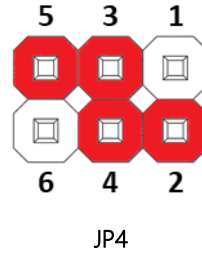
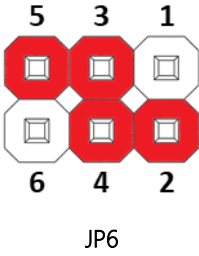
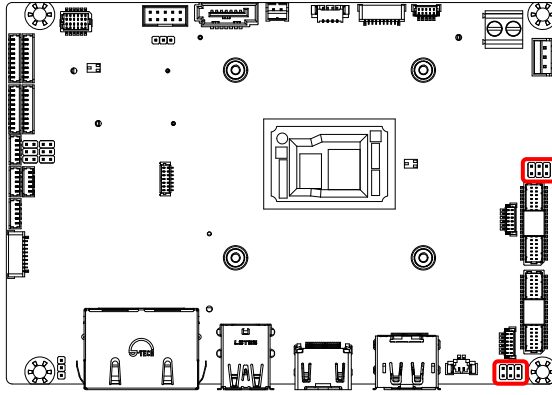

LVDS Power Selection

2-4	+3.3V	Default
4-6	+5V	

LVDS BKLT Power Selection

1-3	+12V	
3-5	+5V	Default

2.3.4 Clear CMOS Jumper (JP5)

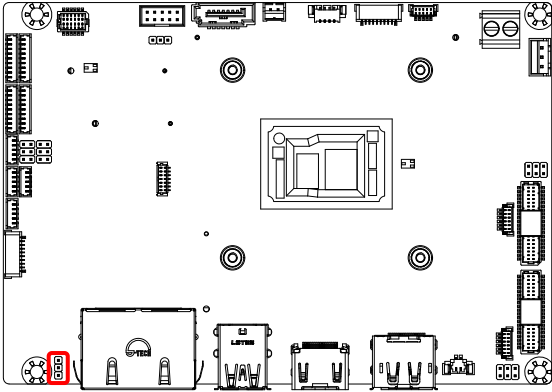

Clear CMOS

1-2	Save CMOS	Default
2-3	Clear CMOS	

2.4 List of Connectors

Please refer to the table below for all of the board's connectors that you can configure for your application

Label	Function
CN1	USB 2.0 Connector (5Pin*1 Board to Wire)
CN2	4-pin Fan Connector
CN4	+5V Output for SATA HDD
CN5	Port 80 Debug Port (10Pin*1 Board to Wire)
CN6	SPI Flash Programming Port (7Pin*1 Board to Wire)
CN7	Front Panel
CN8	I2C/SMBus Header
CN9	SATA Connector
CN10	Audio Pin Header (6Pin*2 Board to Wire)
CN11	USB 2.0 Connector (5Pin*1 Board to Wire)
CN13	12V DC Input Terminal Block Connector
CN14	3-pin ATX +5VSB Input
CN15	GPIO Port (5Pin*2 Board to Wire Type 1)
CN16	COM Port (9Pin*1 Board to Wire)
CN17	COM Port (9Pin*1 Board to Wire)
CN18	COM Port (9Pin*1 Board to Wire)
CN19	COM Port (9Pin*1 Board to Wire)
CN20	M.2 2280 M-Key Slot
CN21	LVDS 1/eDP Connector
CN22	LVDS Inverter/Backlight Connector (6Pin*1 Board to Wire)
CN23	CMOS Battery
CN24	USB 2.0 Connector (5Pin*1 Board to Wire)
CN25	USB 2.0 Connector (5Pin*1 Board to Wire)
CN26	HDMI Port
CN27	Display Port
CN28	Dual RJ-45 LAN Port
CN29	Dual USB 3.2 Gen 2 Port
CN31	LVDS_BKLT2
CN32	LVDS 2 Connector
CN33 DIMM1	DDR5 SODIMM Slot
CN34	Mini Card/mSATA
CN35	M.2 2230 E-Key Slot

2.4.1 USB 2.0 Connector (CN1/CN11/CN24/CN25)

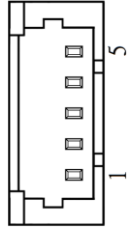
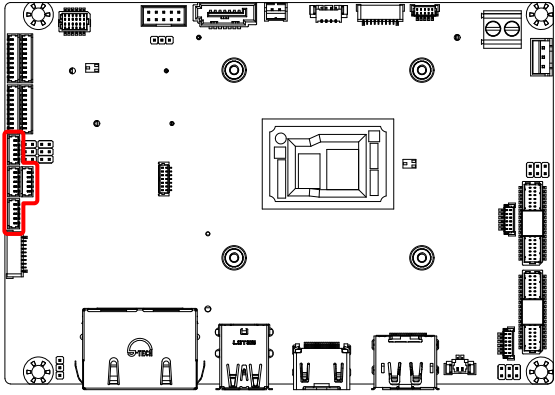

Pin	Pin Name	Signal Type	Signal Level
1	+5V	PWR	+5V
2	USB2_DN	DIFF	-
3	USB2_DP	DIFF	-
4	GND	GND	GND
5	GND	GND	GND

Note: The driving current of +5V supports up to 0.5A/Port.

2.4.2 Fan Connector (CN2)

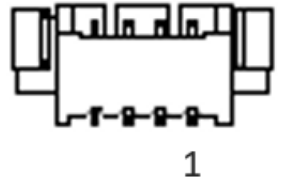
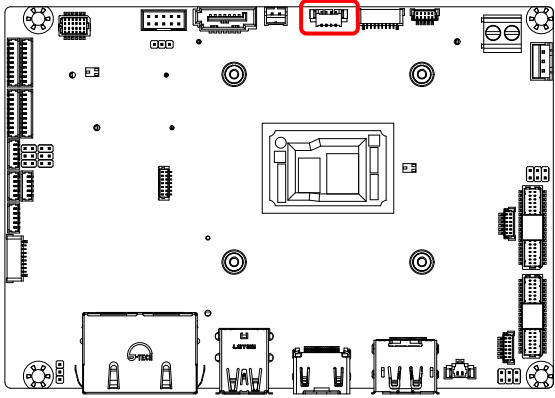

Pin	Pin Name	Signal Type	Signal Level
1	GND	GND	GND

Pin	Pin Name	Signal Type	Signal Level
2	FAN_POWER	PWR	+12V
3	FAN_TAC	IN	-
4	FAN_CTL	OUT	-

Note: The driving current of FAN_POWER supports up to 1A.

2.4.3 +5V Output for SATA HDD (CN4)

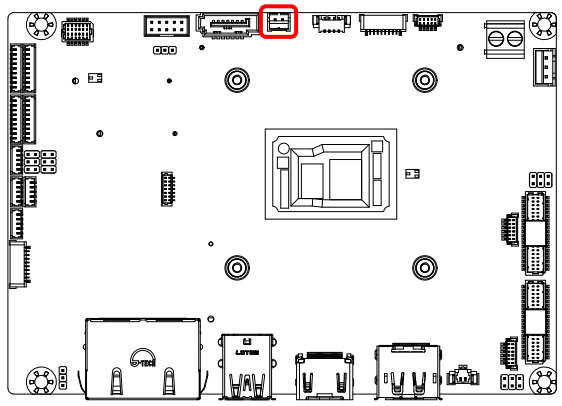

Pin	Pin Name	Signal Type	Signal Level
1	+V5S	PWR	+5V
2	GND	GND	GND

Note: The driving current of +V5S supports up to 2A.

2.4.4 Port 80 Debug Port (CN5)

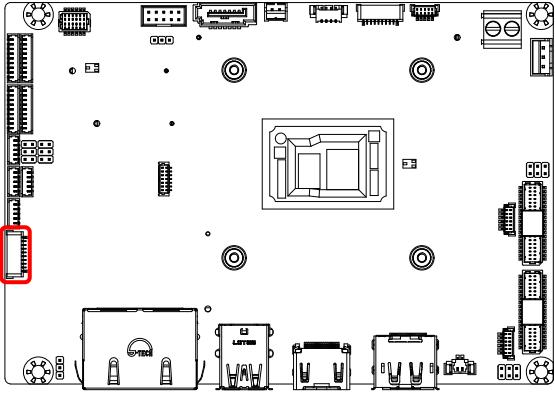

Pin	Pin Name	Signal Type	Signal Level
1	ESPI_IO0_EC_R	IN/OUT	1.8V
2	ESPI_IO1_EC_R	IN/OUT	1.8V
3	ESPI_IO2_EC_R	IN/OUT	1.8V
4	ESPI_IO3_EC_R	IN/OUT	1.8V
5	+3P3S	PWR	3.3V
6	ESPI_CS_EC_R_N	OUT	3.3V
7	ESPI_RST_EC_R_N	OUT	1.8V
8	GND	GND	GND
9	ESPI_CLK_EC_R	OUT	1.8V
10	+3P3A	PWR	3.3V

2.4.5 SPI Flash Programming Port (CN6)

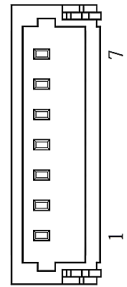
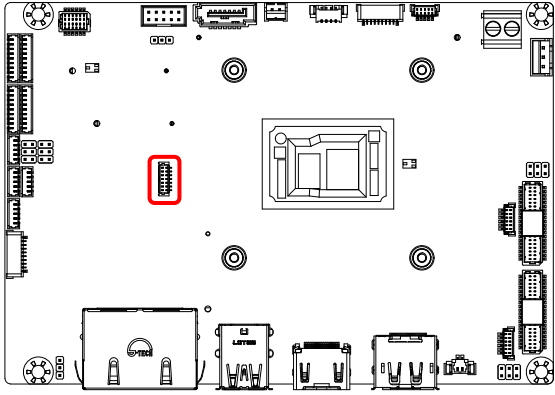

Pin	Pin Name	Signal Type	Signal Level
1	SPI_MISO	OUT	-
2	GND	GND	GND
3	SPI_CLK	IN	-
4	+V3P3A_SPI	PWR	+3.3V
5	SPI_MOSI	IN	-
6	SPI_CS	IN	-
7	NC	-	-

2.4.6 Front Panel (CN7)

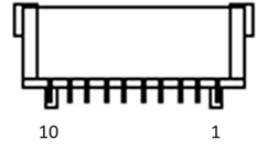
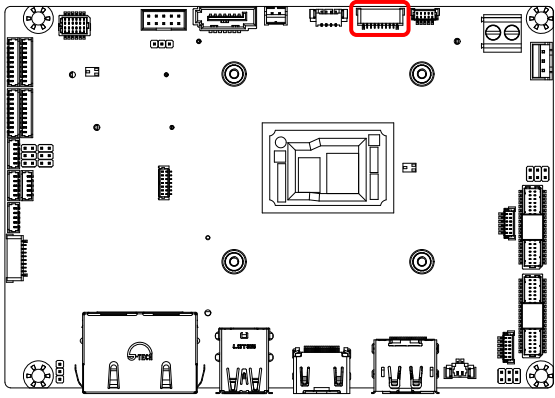

Pin	Pin Name	Signal Type	Signal Level
1	GND	GND	GND

Pin	Pin Name	Signal Type	Signal Level
2	EXT_PWRBTN#	IN	-
3	SATA_LED-	OUT	-
4	SATA_LED+	OUT	-
5	BUZZER-	OUT	-
6	BUZZER+	OUT	-
7	GND	GND	GND
8	PWR_LED+	OUT	-
9	GND	GND	GND
10	HWRST#	IN	-

2.4.7 I2C/SMBus Header (CN8)

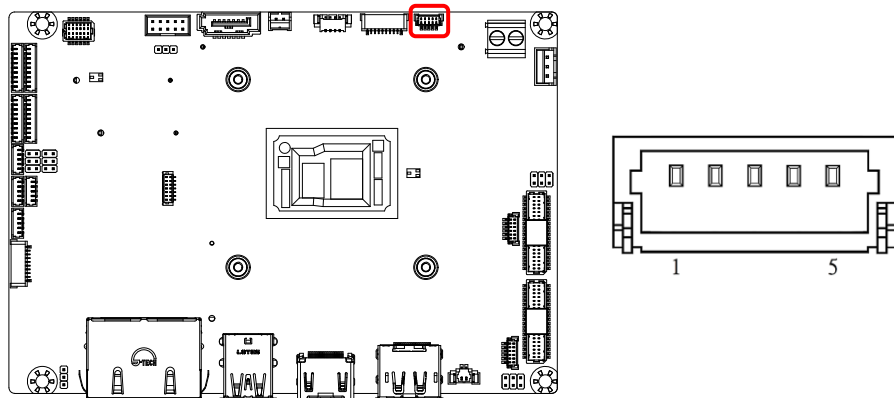

Pin	Pin Name	Signal Type	Signal Level
1	+V3P3S	PWR	+3.3V
2	SMB_CLK/ I2C_CLK/TIME_SYNC0	OUT	+3.3V
3	SMB_DAT/ I2C_DAT/TIME_SYNC1	IN/OUT	+3.3V
4	SMB_ALERT/ INT_SERIRQ/LAN_SDP	IN	+3.3V
5	GND	GND	GND

Note: Default function is SMBus.

2.4.8 SATA Connector (CN9)

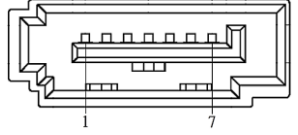
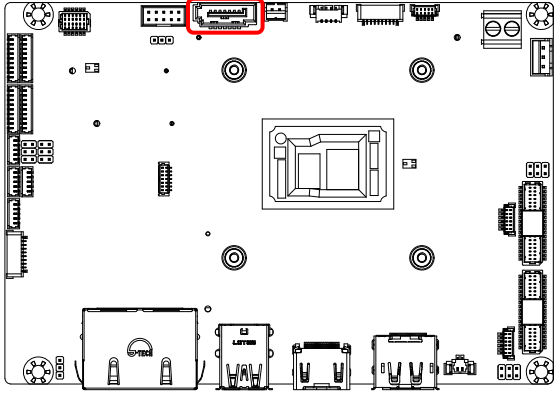

Pin	Pin Name	Signal Type	Signal Level
1	GND	GND	GND
2	SATA_TXP	DIFF	-
3	SATA_TXN	DIFF	-
4	GND	GND	GND
5	SATA_RXN	DIFF	-
6	SATA_RXP	DIFF	-
7	GND	GND	GND

2.4.9 Audio Pin Header (CN10)

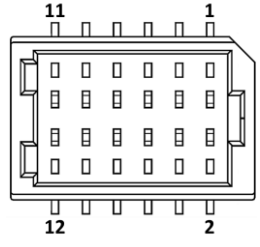
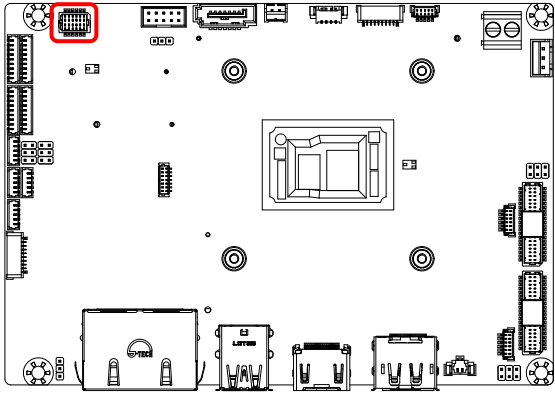

Pin	Pin Name	Signal Type	Signal Level
1	RIGHT_OUT	OUT	-
2	MIC_R	IN	-
3	LEFT_OUT	OUT	-
4	MIC_L	IN	-
5	JD_LOUT	IN	-
6	JD_MIC	IN	-
7	GND_AUDIO	GND	GND
8	GND_AUDIO	GND	GND
9	JD_LIN	IN	-
10	LINE_R_IN	IN	-
11	+VDD_AUDIO	PWR	+5V
12	LINE_L_IN	IN	-

2.4.10 12V DC Input Terminal Block Connector (CN13)

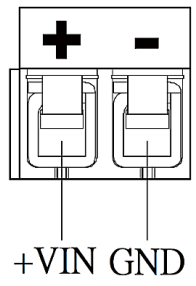
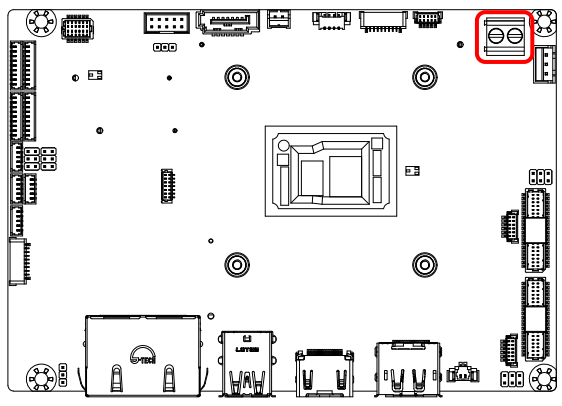

Pin	Pin Name	Signal Type	Signal Level
1	+VIN	PWR	+12V
2	GND	GND	GND

2.4.11 External +5VSB Input (CN14)

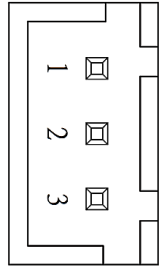
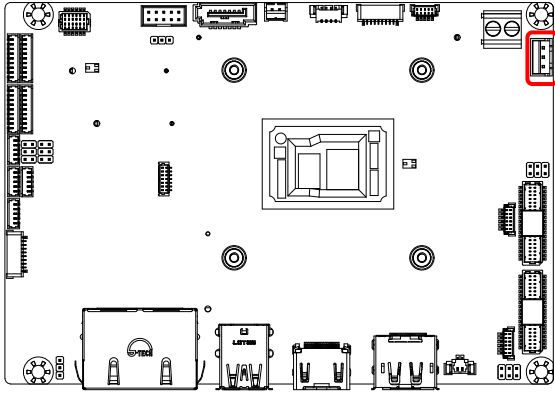

Pin	Pin Name	Signal Type	Signal Level
1	PS_ON#	OUT	+5V
2	GND	GND	GND
3	+5VSB	PWR	+5V

Note: The driving current of +5VSB supports up to 2.5A.

2.4.12 GPIO Port (CN15)

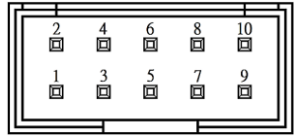
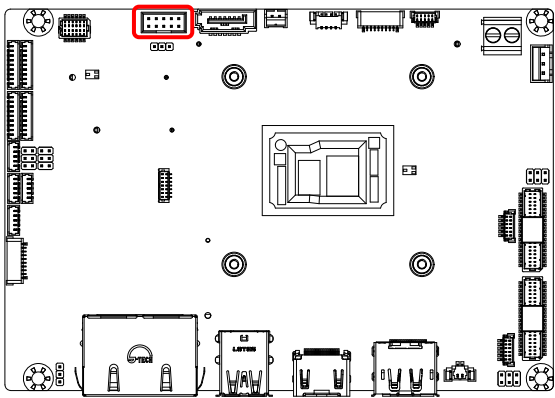

Pin	Pin Name	Signal Type	Signal Level
1	GPIO_0	IN/OUT	-
2	GPIO_1	IN/OUT	-
3	GPIO_2	IN/OUT	-

Pin	Pin Name	Signal Type	Signal Level
4	GPIO_3	IN/OUT	-
5	GPIO_4	IN/OUT	-
6	GPIO_5	IN/OUT	-
7	GPIO_6	IN/OUT	-
8	GPIO_7	IN/OUT	-
9	+V5S	PWR	+5V
10	GND	GND	GND

Note: The driving current of +V5S supports up to 0.5A.

2.4.13 COM Port (CN16/CN17/CN18/CN19)

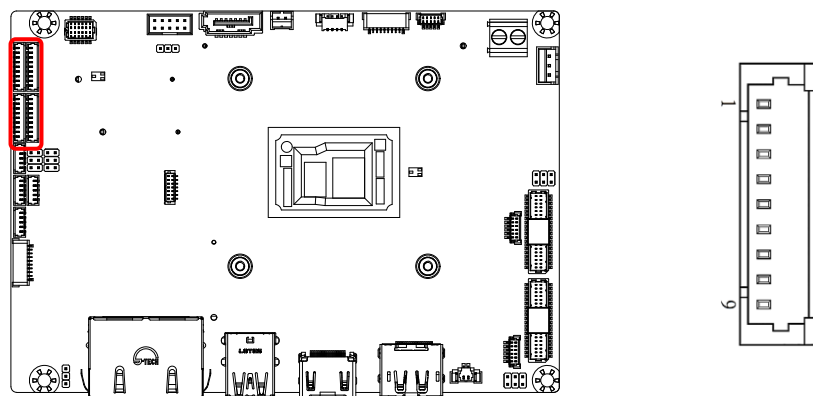

COM Port CN16/CN17 RS-232

Pin	Pin Name	Signal Type	Signal Level
1	DCD	IN	-
2	DSR	IN	-
3	RX	IN	-
4	RTS	OUT	±9V
5	TX	OUT	±9V
6	CTS	IN	-
7	DTR	OUT	±9V
8	RI	IN/ PWR	-
9	GND	GND	GND

COM Port CN18/CN19 RS-422/485/232

Pin	Pin Name	Signal Type	Signal Level
1	DCD	IN	-
2	DSR	IN	-
3	RX	IN	-
4	RTS	OUT	±9V
5	TX	OUT	±9V
6	CTS	IN	-
7	DTR	OUT	±9V
8	RI	IN/ PWR	12V/5V/RING
9	GND	GND	GND

Note: COM CN18/CN19 RS-232/422/485 can be set by BIOS setting. Default is RS-232.

2.4.14 M.2 2280 M-Key Slot (CN20)

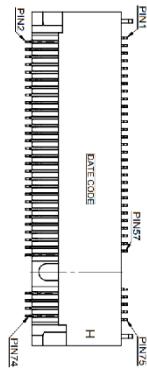
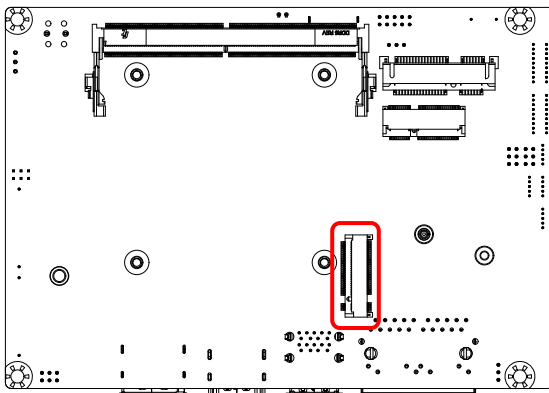

Pin	Pin Name	Signal Type	Signal Level
1	GND	GND	GND
2	+V3P3S	PWR	+3.3V
3	GND	GND	GND
4	+V3P3S	PWR	+3.3V
5	PCIE_12_RXN	DIFF	-
6	CARD_PWR_OFF_N	IN	-
7	PCIE_12_RXP	DIFF	-
8	NC	-	-
9	GND	GND	GND
10	PCH_SATA_LED_N	OUT	+3.3V
11	PCIE_12_TXN	DIFF	-

Pin	Pin Name	Signal Type	Signal Level
12	+V3P3S	PWR	+3.3V
13	PCIE_12_TXP	DIFF	-
14	+V3P3S	PWR	+3.3V
15	GND	GND	GND
16	+V3P3S	PWR	+3.3V
17	PCIE_11_RXN	DIFF	-
18	+V3P3S	PWR	+3.3V
19	PCIE_11_RXP	DIFF	-
20	NC	-	-
21	GND	GND	GND
22	KEYM_SSD_VIO	IN	-
23	PCIE_11_TXN	DIFF	-
24	NC	-	-
25	PCIE_11_TXP	DIFF	-
26	NC	-	-
27	GND	GND	GND
28	NC	-	-
29	PCIE_10_RXN	DIFF	-
30	NC	-	-
31	PCIE_10_RXP	DIFF	-
32	NC	-	-
33	GND	GND	GND
34	NC	-	-
35	PCIE_10_TXN	DIFF	-
36	NC	-	-
37	PCIE_10_TXP	DIFF	-
38	NC	-	-
39	GND	GND	GND
40	NC	-	-
41	PCIE_9_RXN/SATA_1_RXP	DIFF	-
42	NC	-	-
43	PCIE_9_RXP/SATA_1_RXN	DIFF	-
44	NC	-	-
45	GND	GND	GND
46	NC	-	-
47	PCIE_9_TXN/SATA_1_TXN	DIFF	-
48	NC	-	-
49	PCIE_9_TXP/SATA_1_TXP	DIFF	-
50	BUF_PLT_RST#	IN	-

Pin	Pin Name	Signal Type	Signal Level
51	GND	GND	GND
52	M2M_CLKREQ#	OUT	-
53	PCIE_5_CLK_DN	DIFF	-
54	PCIE_WAKE#	OUT	-
55	PCIE_5_CLK_DP	DIFF	-
56	NC	-	-
57	GND	GND	GND
58	NC	-	-
67	NC	-	-
68	SUS_CLK	IN	-
69	KEYM_DET	IN	-
70	+V3P3S	PWR	+3.3V
71	GND	GND	GND
72	+V3P3S	PWR	+3.3V
73	GND	GND	GND
74	+V3P3S	PWR	+3.3V
75	GND	GND	GND

2.4.15 LVDS Connector (CN21/CN32)

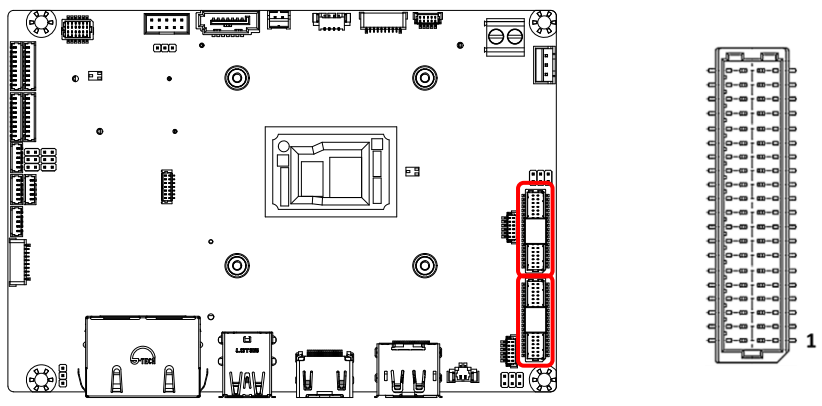

Pin	Pin Name	Signal Type	Signal Level
1	BKL_ENABLE	OUT	
2	BKL_CONTROL	OUT	
3	GND	GND	
4	GND	GND	
5	LVDS_A_CLK-	DIFF	

Pin	Pin Name	Signal Type	Signal Level
6	LCD_PWR	PWR	+3.3V/+5V
7	LVDS_A_CLK+	DIFF	
8	LCD_PWR	PWR	+3.3V/+5V
9	GND	GND	
10	GND	GND	
11	LVDS_DA0-	DIFF	
12	LVDS_DA2-	DIFF	
13	LVDS_DA0+	DIFF	
14	LVDS_DA2+	DIFF	
15	GND	GND	
16	GND	GND	
17	LVDS_DA1-	DIFF	
18	LVDS_DA3-	DIFF	
19	LVDS_DA1+	DIFF	
20	LVDS_DA3+	DIFF	
21	GND	GND	
22	GND	GND	
23	LVDS_DB0-	DIFF	
24	DDC_DATA	I/O / DIFF	+3.3V
25	LVDS_DB0+	DIFF	
26	DDC_CLK	I/O / DIFF	+3.3V
27	GND	GND	
28	GND	GND	
29	LVDS_DB1-	DIFF	
30	LVDS_DB2-	DIFF	
31	LVDS_DB1+	DIFF	
32	LVDS_DB2+	DIFF	
33	GND	GND	
34	GND	GND	
35	LVDS_B_CLK-	DIFF	
36	LVDS_DB3-	DIFF	
37	LVDS_B_CLK+	DIFF	
38	LVDS_DB3+	DIFF	
39	eDP HPD	IN	+3.3V
40	N.C	N.C	

2.4.16 LVDS Inverter/Backlight Connector (CN22/CN31)

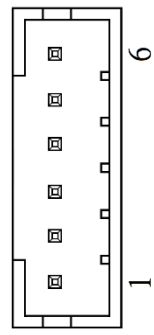
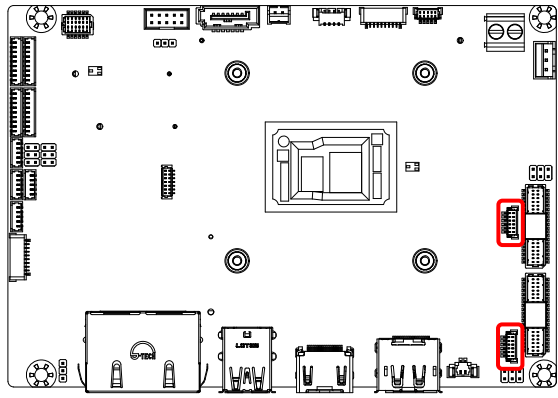

Pin	Pin Name	Signal Type	Signal Level
1	BKL_PWR	PWR	+5V(Default)/+12V
2	BKL_PWR	PWR	+5V(Default)/+12V
3	BKL_CONTROL	OUT	-
4	GND	GND	GND
5	GND	GND	GND
6	BKL_ENABLE	OUT	+3.3V

Note: The driving current of BKL_PWR supports up to 2A.

2.4.17 RTC Battery Connector (CN23)

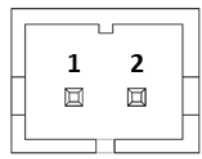
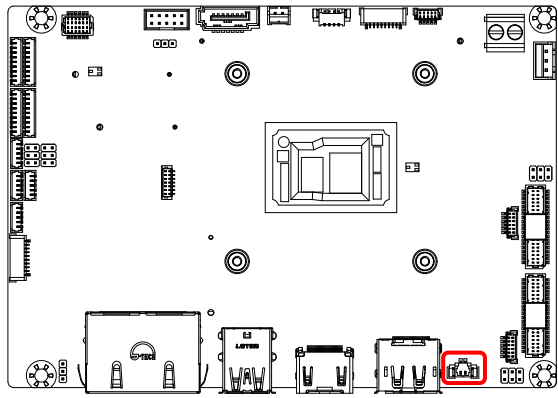

Pin	Pin Name	Signal Type	Signal Level
1	+3.3V	PWR	+3.3V
2	GND	GND	GND

2.4.18 HDMI Port (CN26)

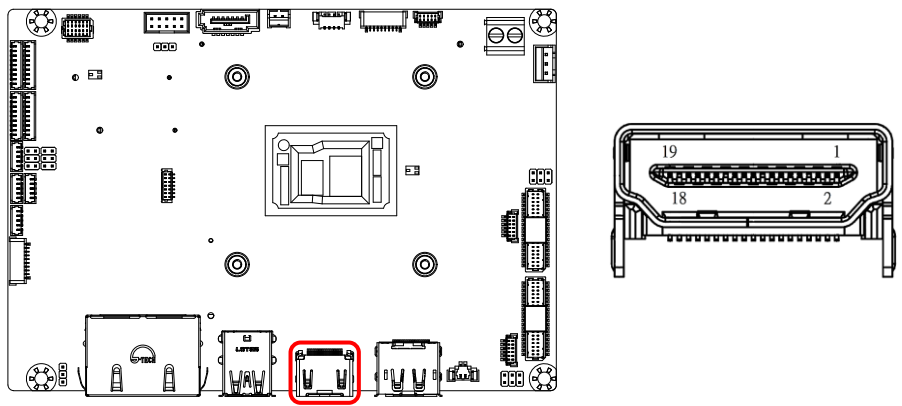

Pin	Pin Name	Signal Type	Signal Level
1	HDMI_TX2+	DIFF	-
2	GND	GND	GND
3	HDMI_TX2-	DIFF	-
4	HDMI_TX1+	DIFF	-
5	GND	GND	GND
6	HDMI_TX1-	DIFF	-
7	HDMI_TX0+	DIFF	-
8	GND	GND	GND
9	HDMI_TX0-	DIFF	-
10	HDMI_CLK+	DIFF	-
11	GND	GND	GND
12	HDMI_CLK-	DIFF	-
13	N/A	N/A	N/A
14	N/A	N/A	N/A
15	DDC_CLK	IN/OUT	-
16	DDC_DATA	IN/OUT	-
17	GND	GND	GND
18	+V5S	PWR	+5V
19	HDMI_HPD	IN	-

Note: Mini Card/mSATA function can be set by BIOS. Default is mSATA.

2.4.19 Display Port (CN27)

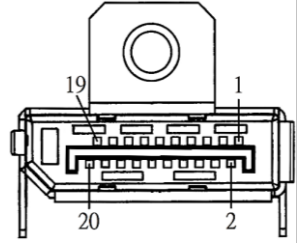
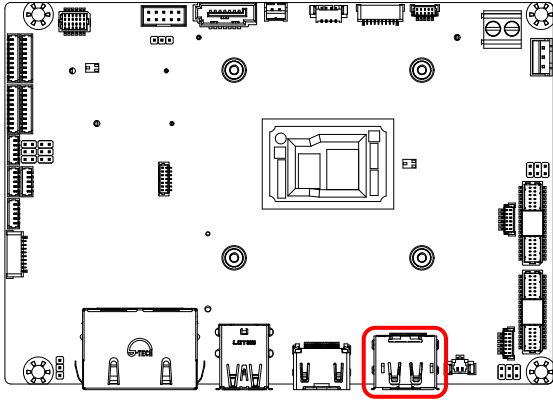

Pin	Pin Name	Signal Type	Signal Level
1	DP_TX0_DP	DIFF	-
2	GND	GND	GND
3	DP_TX0_DN	DIFF	-
4	DP_TX1_DP	DIFF	-
5	GND	GND	GND
6	DP_TX1_DN	DIFF	-
7	DP_TX2_DP	DIFF	-
8	GND	GND	GND
9	DP_TX2_DN	DIFF	-
10	DP_TX3_DP	DIFF	-
11	GND	GND	GND
12	DP_TX3_DN	DIFF	-
13	DP_OB_AUX_EN	IN	-
14	GND	GND	GND
15	DP_AUX_DP	IN/OUT	-
16	GND	GND	GND
17	DP_AUX_DN	IN/OUT	-
18	DP_HPD	IN/OUT	-
19	GND	GND	GND
20	+3.3V	PWR	+3.3V

2.4.20 Dual LAN Port (CN28)

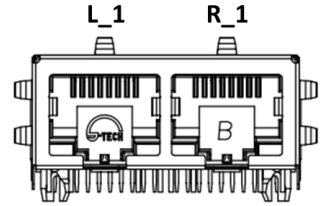
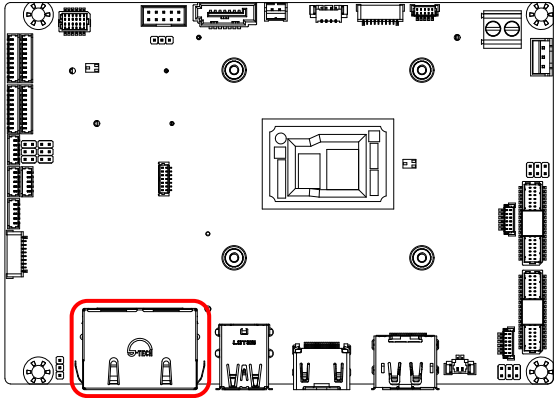

Pin	Pin Name	Signal Type	Signal Level
L_1	LAN1_MDI0_P	DIFF	-
L_2	LAN1_MDI0_N	DIFF	-
L_3	LAN1_MDI1_P	DIFF	-
L_4	LAN1_MDI1_N	DIFF	-
L_5	LAN1_MDI2_P	DIFF	-
L_6	LAN1_MDI2_N	DIFF	-
L_7	LAN1_MDI3_P	DIFF	-
L_8	LAN1_MDI3_N	DIFF	-
R_1	LAN2_MDI0_P	DIFF	-
R_2	LAN2_MDI0_N	DIFF	-
R_3	LAN2_MDI1_P	DIFF	-
R_4	LAN2_MDI1_N	DIFF	-
R_5	LAN2_MDI2_P	DIFF	-
R_6	LAN2_MDI2_N	DIFF	-
R_7	LAN2_MDI3_P	DIFF	-
R_8	LAN2_MDI3_N	DIFF	-

2.4.21 Dual USB 3.2 Gen 2 Port (CN29)

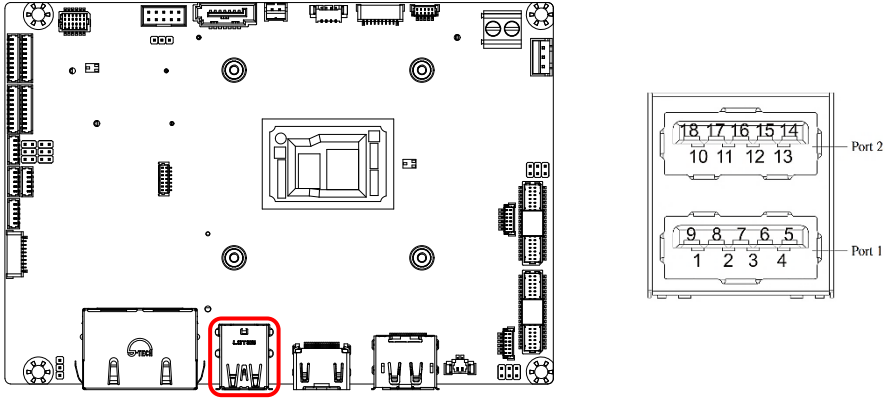

Pin	Pin Name	Signal Type	Signal Level
1	+5V	PWR	+5V
2	USB2_1_DN	DIFF	-
3	USB2_1_DP	DIFF	-
4	GND	GND	GND
5	USB3_1_RXN	DIFF	-
6	USB3_1_RXP	DIFF	-
7	GND	GND	GND
8	USB3_1_TXN	DIFF	-
9	USB3_1_TXP	DIFF	-
10	+5V	PWR	+5V
11	USB2_2_DN	DIFF	-
12	USB2_2_DP	DIFF	-
13	GND	GND	GND
14	USB3_2_RXN	DIFF	-
15	USB3_2_RXP	DIFF	-
16	GND	GND	GND
17	USB3_2_TXN	DIFF	-
18	USB3_2_TXP	DIFF	-

Note: The driving current of +5V supports up to 0.9A/Port.

2.4.22 DDR5 SODIMM Slot (CN33)

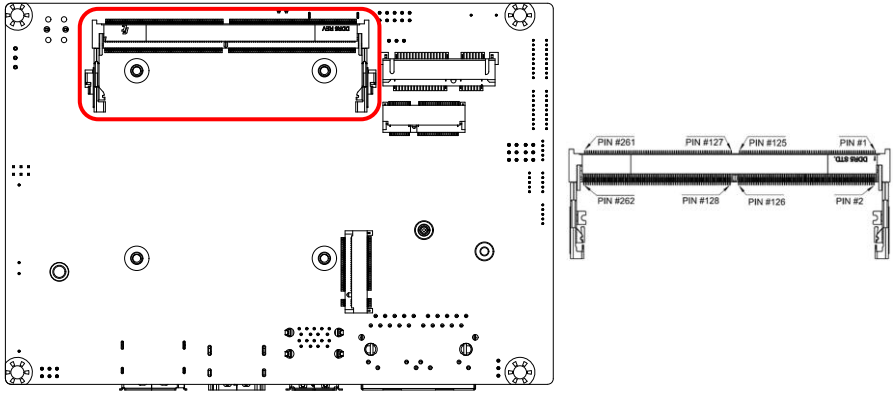

Pin	Pin Name	Signal Type	Signal Level
1	VIN_BULK	IN	+5V
2	HSA	IN	GND
3	VIN_BULK	IN	+5V
4	HSCL	IN	VPP or VDD
5	NC	-	-
6	HSDA	IN/OUT	VPP or VDD
7	PWR_GOOD	IN/OUT	VDDQ
8	PWR_EN	IN	VDDQ
9	VSS	GND	GND
10	VSS	GND	GND
11	DQ0_A	IN	VDDQ
12	DQ1_A	IN	VDDQ
13	VSS	GND	GND
14	VSS	GND	GND
15	DQ2_A	IN	VDDQ
16	DQ3_A	IN	VDDQ
17	VSS	GND	GND
18	VSS	GND	GND
19	DM0_A_n	IN	GND
20	DQS0_A_c	DIFF	-
21	VSS	GND	GND
22	DQS0_A_t	DIFF	-
23	DQ4_A	IN	VDDQ
24	VSS	GND	GND

Pin	Pin Name	Signal Type	Signal Level
25	VSS	GND	GND
26	DQ5_A	IN	VDDQ
27	DQ6_A	IN	VDDQ
28	VSS	GND	GND
29	VSS	GND	GND
30	DQ7_A	IN	VDDQ
31	DQ8_A	IN	VDDQ
32	VSS	GND	GND
33	VSS	GND	GND
34	DQ9_A	IN	VDDQ
35	DQ10_A	IN	VDDQ
36	VSS	GND	GND
37	VSS	GND	GND
38	DQ11_A	IN	VDDQ
39	DQS1_A_c	DIFF	-
40	VSS	GND	GND
41	DQS1_A_t	DIFF	-
42	DM1_A_n	IN	GND
43	VSS	GND	GND
44	VSS	GND	GND
45	DQ12_A	IN	VDDQ
46	DQ13_A	IN	VDDQ
47	VSS	GND	GND
48	VSS	GND	GND
49	DQ14_A	IN	VDDQ
50	DQ15_A	IN	VDDQ
51	VSS	GND	GND
52	VSS	GND	GND
53	DQ16_A	IN	VDDQ
54	DQ17_A	IN	VDDQ
55	VSS	GND	GND
56	VSS	GND	GND
57	DQ18_A	IN	VDDQ
58	DQ19_A	IN	VDDQ
59	VSS	GND	GND
60	VSS	GND	GND
61	DM2_A_n	IN	GND
62	DQS2_A_c	DIFF	-
63	VSS	GND	GND

Pin	Pin Name	Signal Type	Signal Level
64	DQS2_A_t	DIFF	-
65	DQ20_A	IN	VDDQ
66	VSS	GND	GND
67	VSS	GND	GND
68	DQ21_A	IN	VDDQ
69	DQ22_A	IN	VDDQ
70	VSS	GND	GND
71	VSS	GND	GND
72	DQ23_A	IN	VDDQ
73	DQ24_A	IN	VDDQ
74	VSS	GND	GND
75	VSS	GND	GND
76	DQ25_A	IN	VDDQ
77	DQ26_A	IN	VDDQ
78	VSS	GND	GND
79	VSS	GND	GND
80	DQ27_A	IN	VDDQ
81	DQS3_A_c	DIFF	-
82	VSS	GND	GND
83	DQS3_A_t	DIFF	-
84	DM3_A_n	IN	GND
85	VSS	GND	GND
86	VSS	GND	GND
87	DQ28_A	IN	VDDQ
88	DQ29_A	IN	VDDQ
89	VSS	GND	GND
90	VSS	GND	GND
91	DQ30_A	IN	VDDQ
92	DQ31_A	IN	VDDQ
93	VSS	GND	GND
94	VSS	GND	GND
95	CB0_A	IN	VDDQ
96	CB1_A	IN	VDDQ
97	VSS	GND	GND
98	VSS	GND	GND
99	CB2_A	IN	VDDQ
100	DQS4_A_c	DIFF	-
101	VSS	GND	GND
102	DQS4_A_t	DIFF	-

Pin	Pin Name	Signal Type	Signal Level
103	CB3_A	IN	VDDQ
104	VSS	GND	GND
105	VSS	GND	GND
106	CS0_A_n	IN	GND
107	CA0_A	IN	VDDQ
108	ALERT_n	IN/OUT	GND
109	CA1_A	IN	VDDQ
110	CS1_A_n	IN	GND
111	VSS	GND	GND
112	VSS	GND	GND
113	CA2_A	IN	VDDQ
114	CA3_A	IN	VDDQ
115	CA4_A	IN	VDDQ
116	CA5_A	IN	VDDQ
117	VSS	GND	GND
118	VSS	GND	GND
119	CA6_A	IN	VDDQ
120	CA7_A	IN	VDDQ
121	CA8_A	IN	VDDQ
122	CA9_A	IN	VDDQ
123	VSS	GND	GND
124	VSS	GND	GND
125	CA10_A	IN	VDDQ
126	CA11_A	IN	VDDQ
127	CA12_A	IN	VDDQ
128	NC	-	-
129	VSS	GND	GND
130	VSS	GND	GND
131	CK0_A_t	DIFF	-
132	CK1_A_t	DIFF	-
133	CK0_A_c	DIFF	-
134	CK1_A_c	DIFF	-
135	VSS	GND	GND
136	VSS	GND	GND
137	CK0_B_t	DIFF	-
138	CK1_B_t	DIFF	-
139	CK0_B_c	DIFF	-
140	CK1_B_c	DIFF	-
141	VSS	GND	GND

Pin	Pin Name	Signal Type	Signal Level
142	VSS	GND	GND
143	NC	-	-
144	CA12_B	IN	VDDQ
145	CA11_B	IN	VDDQ
146	CA10_B	IN	VDDQ
147	VSS	GND	GND
148	VSS	GND	GND
149	CA9_B	IN	VDDQ
150	CA8_B	IN	VDDQ
151	CA7_B	IN	VDDQ
152	CA6_B	IN	VDDQ
153	VSS	GND	GND
154	VSS	GND	GND
155	CA5_B	IN	VDDQ
156	CA4_B	IN	VDDQ
157	CA3_B	IN	VDDQ
158	CA2_B	IN	VDDQ
159	VSS	GND	GND
160	VSS	GND	GND
161	CS0_B_n	IN	GND
162	CA1_B	IN	VDDQ
163	RESET_n	IN	GND
164	CA0_B	IN	VDDQ
165	CS1_B_n	IN	GND
166	VSS	GND	GND
167	VSS	GND	GND
168	CB0_B	IN	VDDQ
169	DQS4_B_c	DIFF	-
170	VSS	GND	GND
171	DQS4_B_t	DIFF	-
172	CB1_B	IN	VDDQ
173	VSS	GND	GND
174	VSS	GND	GND
175	CB3_B	IN	VDDQ
176	CB2_B	IN	VDDQ
177	VSS	GND	GND
178	VSS	GND	GND
179	DQ0_B	IN	VDDQ
180	DQ1_B	IN	VDDQ

Pin	Pin Name	Signal Type	Signal Level
181	VSS	GND	GND
182	VSS	GND	GND
183	DQ2_B	IN	VDDQ
184	DQ3_B	IN	VDDQ
185	VSS	GND	GND
186	VSS	GND	GND
187	DM0_B_n	IN	GND
188	DQS0_B_c	DIFF	-
189	VSS	GND	GND
190	DQS0_B_t	DIFF	-
191	DQ4_B	IN	VDDQ
192	VSS	GND	GND
193	VSS	GND	GND
194	DQ5_B	IN	VDDQ
195	DQ6_B	IN	VDDQ
196	VSS	GND	GND
197	VSS	GND	GND
198	DQ7_B	IN	VDDQ
199	DQ8_B	IN	VDDQ
200	VSS	GND	GND
201	VSS	GND	GND
202	DQ9_B	IN	VDDQ
203	DQ10_B	IN	VDDQ
204	VSS	GND	GND
205	VSS	GND	GND
206	DQ11_B	IN	VDDQ
207	DQS1_B_c	DIFF	-
208	VSS	GND	GND
209	DQS1_B_t	DIFF	-
210	DM1_B_n	IN	GND
211	VSS	GND	GND
212	VSS	GND	GND
213	DQ12_B	IN	VDDQ
214	DQ13_B	IN	VDDQ
215	VSS	GND	GND
216	VSS	GND	GND
217	DQ14_B	IN	VDDQ
218	DQ15_B	IN	VDDQ
219	VSS	GND	GND

Pin	Pin Name	Signal Type	Signal Level
220	VSS	GND	GND
221	DQ16_B	IN	VDDQ
222	DQ17_B	IN	VDDQ
223	VSS	GND	GND
224	VSS	GND	GND
225	DQ18_B	IN	VDDQ
226	DQ19_B	IN	VDDQ
227	VSS	GND	GND
228	VSS	GND	GND
229	DM2_B_n	IN	GND
230	DQS2_B_c	DIFF	-
231	VSS	GND	GND
232	DQS2_B_t	DIFF	-
233	DQ20_B	IN	VDDQ
234	VSS	GND	GND
235	VSS	GND	GND
236	DQ21_B	IN	VDDQ
237	DQ22_B	IN	VDDQ
238	VSS	GND	GND
239	VSS	GND	GND
240	DQ23_B	IN	VDDQ
241	DQ24_B	IN	VDDQ
242	VSS	GND	GND
243	VSS	GND	GND
244	DQ25_B	IN	VDDQ
245	DQ26_B	IN	VDDQ
246	VSS	GND	GND
247	VSS	GND	GND
248	DQ27_B	IN	VDDQ
249	DQS3_B_c	DIFF	-
250	VSS	GND	GND
251	DQS3_B_t	DIFF	-
252	DM3_B_n	IN	GND
253	VSS	GND	GND
254	VSS	GND	GND
255	DQ28_B	IN	VDDQ
256	DQ29_B	IN	VDDQ
257	VSS	GND	GND
258	VSS	GND	GND

Pin	Pin Name	Signal Type	Signal Level
259	DQ30_B	IN	VDDQ
260	DQ31_B	IN	VDDQ
261	VSS	GND	GND
262	VSS	GND	GND

2.4.23 Full-size Mini Card/mSATA Slot (CN34)

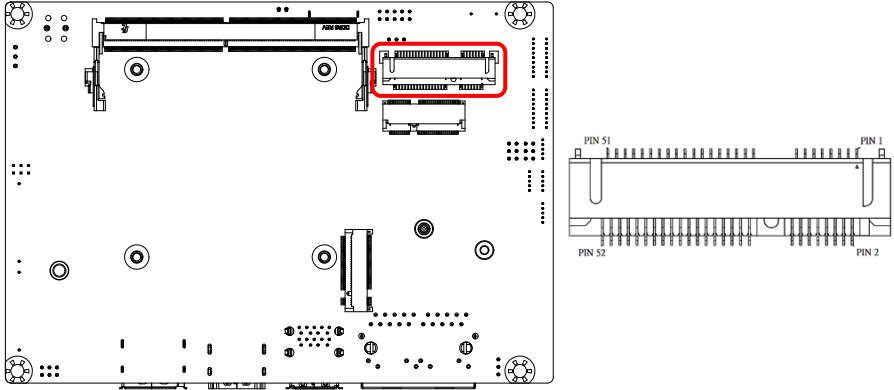

Pin	Pin Name	Signal Type	Signal Level
1	PCIE_WAKE#	IN	-
2	+3.3V	PWR	+3.3V
3	NC	NC	NC
4	GND	GND	GND
5	NC	NC	NC
6	+1.5V	PWR	+1.5V
7	PCIE_CLK_REQ#	IN	-
8	NC	NC	NC
9	GND	GND	GND
10	NC	NC	NC
11	PCIE_REF_CLK-	DIFF	-
12	NC	NC	NC
13	PCIE_REF_CLK+	DIFF	-
14	NC	NC	NC
15	GND	GND	GND
16	NC	NC	NC
17	NC	NC	NC
18	GND	GND	GND

Pin	Pin Name	Signal Type	Signal Level
19	NC	NC	NC
20	W_DISABLE#	OUT	+3.3V
21	GND	GND	GND
22	PCIE_RST3	OUT	+3.3V
23	PCIE_RX-/SATA_RX-	DIFF	GND
24	+3.3V	PWR	+3.3V
25	PCIE_RX+/SATA_RX+	DIFF	-
26	GND	GND	GND
27	GND	GND	GND
28	+1.5V	PWR	+1.5V
29	GND	GND	GND
30	SMB_CLK	IN/OUT	+3.3V
31	PCIE_TX-/SATA_TX-	DIFF	-
32	SMB_DATA	IN/OUT	+3.3V
33	PCIE_TX+/SATA_TX+	DIFF	-
34	GND	GND	GND
35	GND	GND	GND
36	USB_D-	DIFF	-
37	GND	GND	GND
38	USB_D+	DIFF	-
39	+3.3V	PWR	+3.3V
40	GND	GND	GND
41	+3.3V	PWR	+3.3V
42	NC	NC	NC
43	GND	GND	GND
44	NC	NC	NC
45	NC	NC	NC
46	NC	NC	NC
47	NC	NC	NC
48	+1.5V	PWR	+1.5V
49	NC	NC	NC
50	GND	GND	GND
51	NC	NC	NC
52	+3.3V	PWR	+3.3V

Note: Mini-Card/mSATA function can be set by BIOS.

2.4.24 M.2 2230 E-Key Slot (CN35)

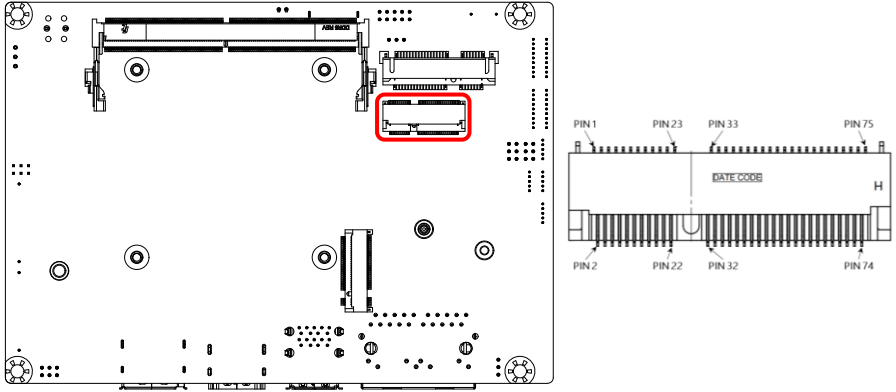

Pin	Pin Name	Signal Type	Signal Level
1	GND	GND	GND
2	+V3P3A	PWR	+3.3V
3	USB2_10_DP	DIFF	-
4	+V3P3A	PWR	+3.3V
5	USB2_10_DN	DIFF	-
6	NC	-	-
7	GND	GND	GND
8	NC	-	-
9	CNV_WR_D1_DN	DIFF	-
10	KEYE_CNV_RF_RST	IN	-
11	CNV_WR_D1_DP	DIFF	-
12	NC	-	-
13	GND	GND	GND
14	KEYE_CNV_CLKREQ	OUT	-
15	CNV_WR_D0_DN	DIFF	-
16	NC	-	-
17	CNV_WR_D0_DP	DIFF	-
18	GND	GND	GND
19	GND	GND	GND
20	KEYE_UART_WAKE_N	IN	-
21	CNV_WR_CLK_DN	DIFF	-
22	CNV_BRI_RSP	IN	-
23	CNV_WR_CLK_DP	DIFF	-
32	CNV_RGI_DT	IN	-

Pin	Pin Name	Signal Type	Signal Level
33	GND	GND	GND
34	CNV_RGI_RSP	OUT	-
35	PCIE_8_TXP	DIFF	-
36	CNV_BRI_DT	-	-
37	PCIE_8_TXN	DIFF	-
38	MLK_RST_N	IN	-
39	GND	GND	GND
40	MLK_DATA	IN/OUT	-
41	PCIE_8_RXP	DIFF	-
42	MLK_CLK	IN	-
43	PCIE_8_RXN	DIFF	-
44	NC	-	-
45	GND	GND	GND
46	NC	-	-
47	PCIE_3_CLK_DP	DIFF	-
48	NC	-	-
49	PCIE_3_CLK_DN	DIFF	-
50	SUS_CLK	IN	-
51	GND	GND	GND
52	BUF_PLT_RST#	IN	-
53	PCIE_CLKREQ#3	OUT	-
54	NC	-	-
55	PCIE_WAKE#	IN/OUT	-
56	NC	-	-
57	GND	GND	GND
58	NC	-	-
59	CNV_WT_D1_DN	DIFF	-
60	NC	-	-
61	CNV_WT_D1_DP	DIFF	-
62	NC	-	-
63	GND	GND	GND
64	NC	-	-
65	CNV_WT_D0_DN	DIFF	-
66	NC	-	-
67	CNV_WT_D0_DP	DIFF	-
68	NC	-	-
69	GND	GND	GND
70	NC	-	-
71	CNV_WT_CLK_DN	DIFF	-

Pin	Pin Name	Signal Type	Signal Level
72	+V3P3A	PWR	+3.3V
73	CNV_WT_CLK_DP	DIFF	-
74	+V3P3A	PWR	+3.3V
75	GND	GND	GND

2.5 Thermal Solutions

2.5.1 Heatsink Optional Accessory - GENE-APL7-HSK01

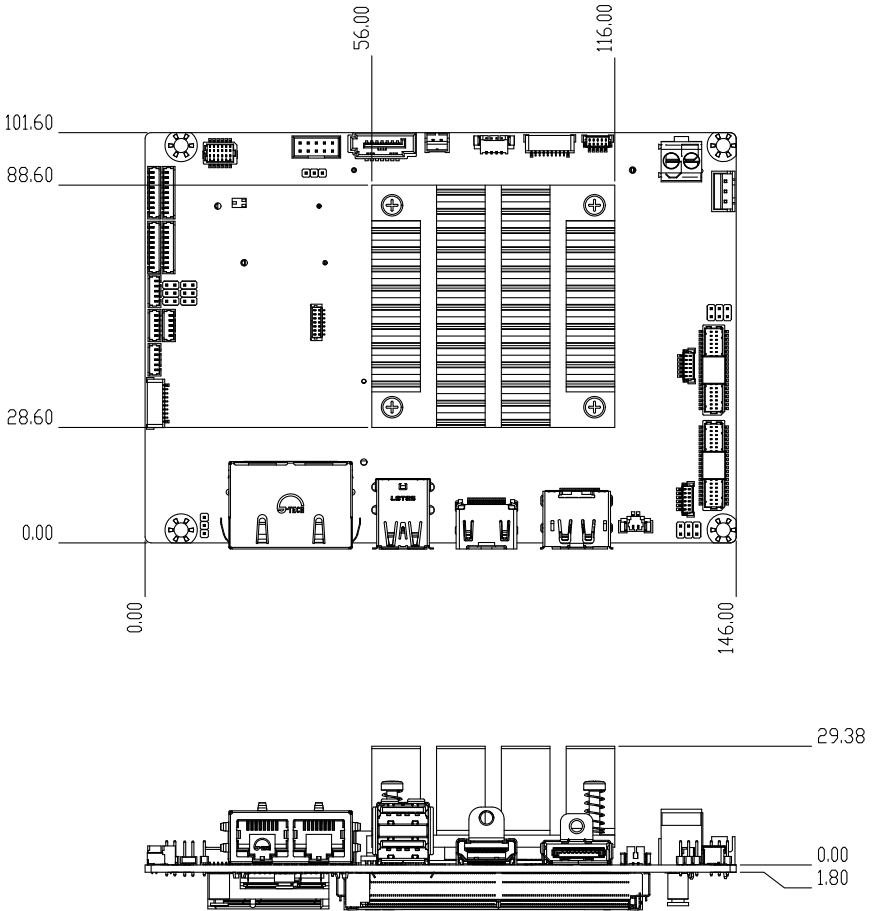

Optional Accessory GENE-APL7-HSK01 Assembly

3.5" Subcompact Board

GENE-TWL7

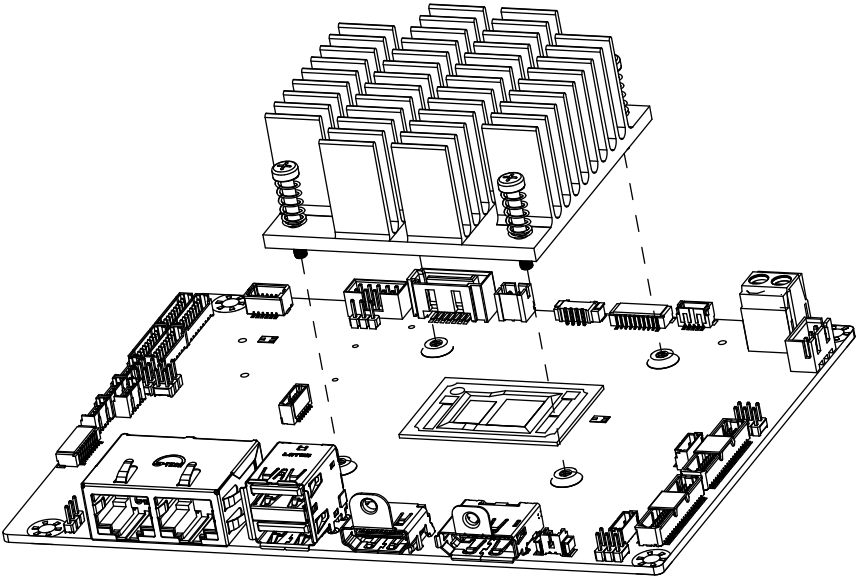

Chapter 3

AMI BIOS Setup

3.1 System Test and Initialization

These routines check the current system configuration stored in the CMOS memory and BIOS NVRAM. If system configuration is not found or system configuration data error is detected, system will load optimized default and re-boot with this default system configuration automatically.

There are four situations in which you will need to setup system configuration:

1. You are starting your system for the first time
2. You have changed the hardware attached to your system
3. The system configuration is reset by Clear-CMOS jumper
4. The CMOS memory has lost power and the configuration information has been erased.

The GENE-TWL7 CMOS memory has an integral lithium battery backup for data retention. However, you will need to replace the battery when it finally runs down.

3.2 AMI BIOS Setup

AMI BIOS ROM has a built-in Setup program that allows users to modify the basic system configuration. This type of information is stored in battery-backed CMOS RAM and BIOS NVRAM so that it retains the Setup information when the power is turned off.

Entering Setup

Power on the computer and press or <ESC> immediately. This will allow you to enter Setup.

Main

Set the date, use tab to switch between date elements.

Advanced

Enable/disable the feature configurations.

Chipset

Host bridge parameters.

Boot

Enables/disable quiet boot option.

Security

Set setup administrator password.

Save & Exit

Exit system setup after saving the changes.

3.3 Setup Submenu: Main

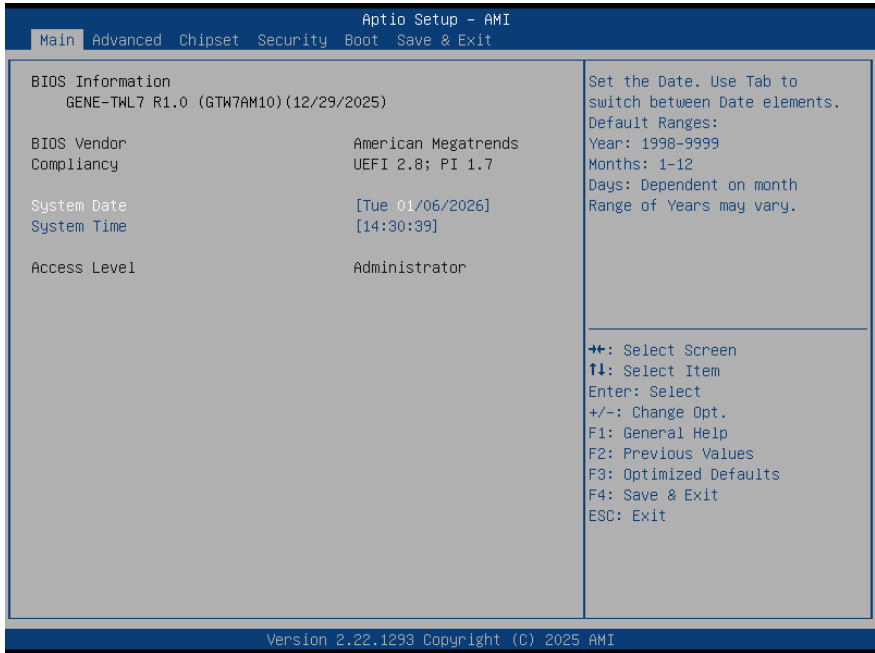

3.4 Setup Submenu: Advanced

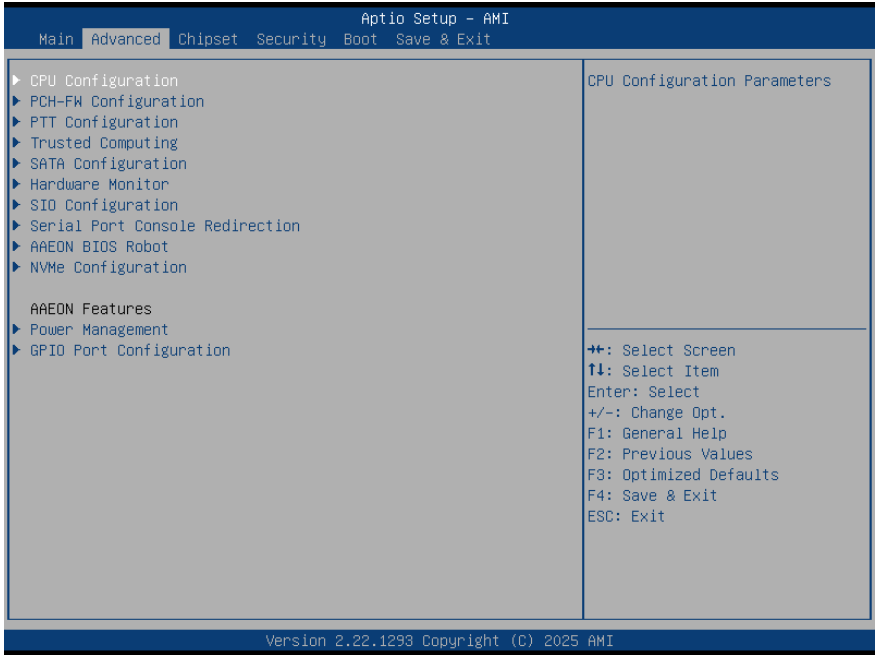

3.4.1 CPU Configuration



Options Summary		
Intel (VMX) Virtualization Technology	Disabled	
	Enabled	Optimal Default, Failsafe Default
When enabled, a VMM can utilize the additional hardware capabilities provided by Vanderpool Technology.		
Intel® SpeedStep™	Disabled	
	Enabled	Optimal Default, Failsafe Default
Allows more than two frequency ranges to be supported.		
Turbo Mode	Disabled	
	Enabled	Optimal Default, Failsafe Default
Enable or Disable processor Turbo Mode (requires EMTTM enabled). AUTO means enabled		
C states	Disabled	
	Enabled	Optimal Default, Failsafe Default
Enable/Disable CPU Power Management. Allows CPU to go to C states when it's not 100% utilized.		

3.4.2 PCH-FW Configuration

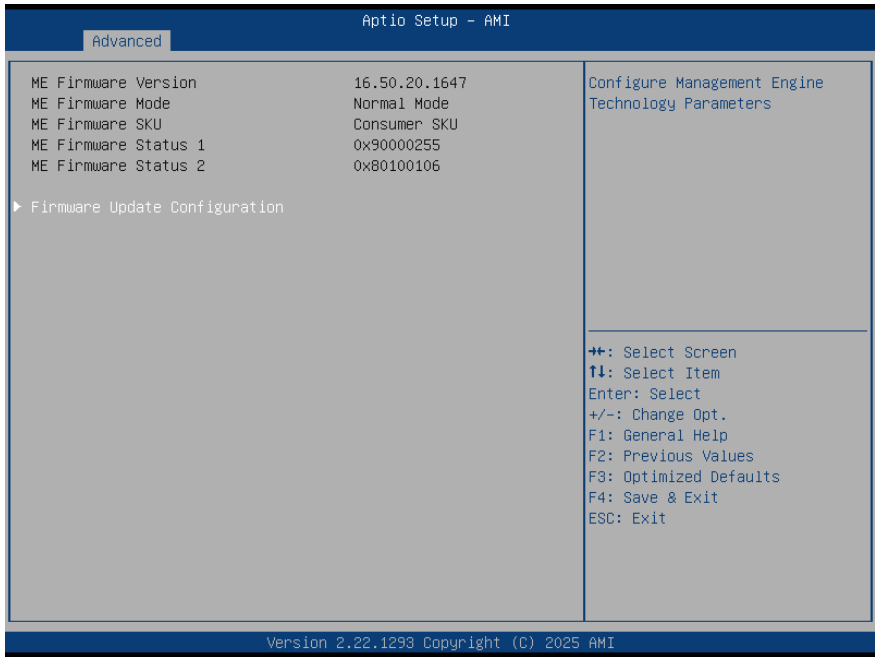

3.4.3 Firmware Update Configuration



Options Summary		
Me FW Image Re-Flash	Enabled	
	Disabled	Optimal Default, Failsafe Default
Enable/Disable Me FW Image Re-Flash function.		
FW Update	Disabled	
	Enabled	Optimal Default, Failsafe Default
Enable/Disable ME FW Update function.		

3.4.4 PTT Configuration

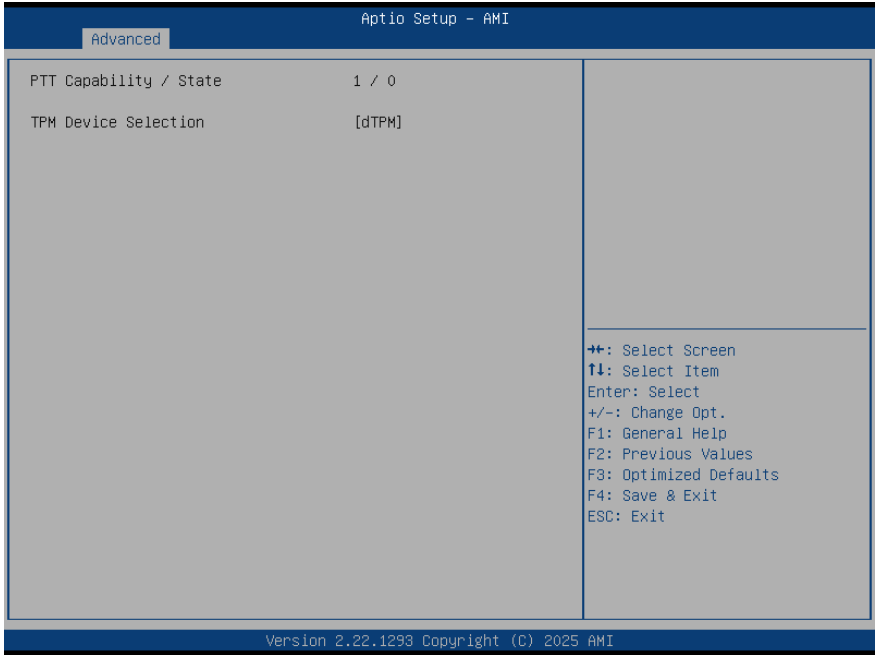

Options Summary		
TPM Device Selection	dTPM	Optimal Default, Failsafe Default
	PTT	
<p>Selects TPM device: PTT or discrete TPM. PTT - enables PTT in SkuMgr. dTPM - disables PTT in SkuMgr. Warning! PTT/dTPM will be disabled and all data saved on it will be lost.</p>		

3.4.5 Trusted Computing

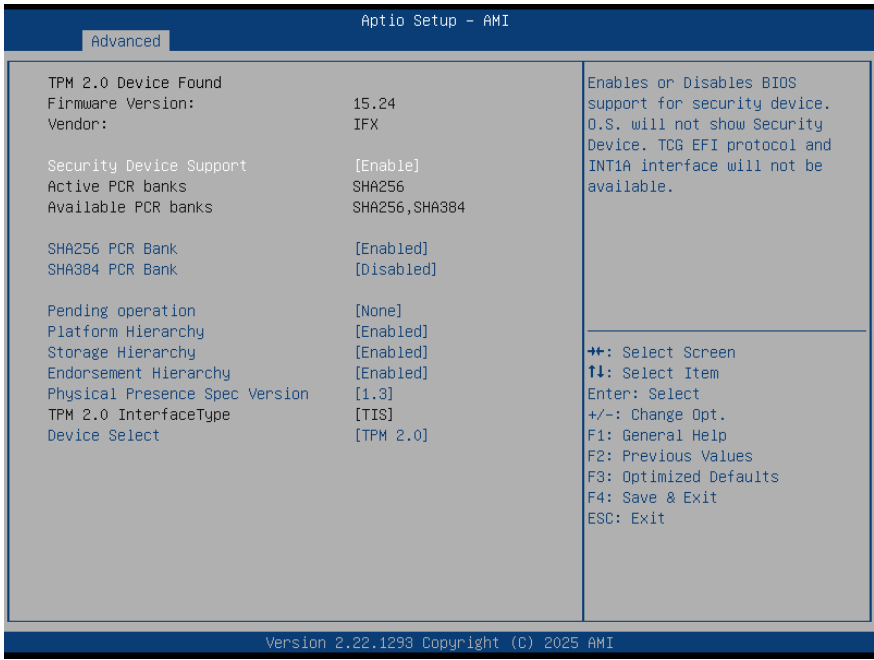

Options Summary		
Security Device Support	Enable	Optimal Default, Failsafe Default
	Disable	
Enables or disables BIOS support for the security device. When disabled, the operating system will not detect the security device, and the TCG EFI protocol and INT1A interface will be unavailable.		
SHA256 PCR Bank	Enabled	Optimal Default, Failsafe Default
	Disabled	
Enable or Disable SHA256 PCR Bank.		
SHA384 PCR Bank	Enabled	Optimal Default, Failsafe Default
	Disabled	
Enable or Disable SHA384 PCR Bank.		
Pending operation	None	Optimal Default, Failsafe Default
	TPM Clear	
Schedules an operation for the security device.		
Note: The computer will reboot during the process to change the security device state.		

Options Summary		
Platform Hierarchy	Enabled	Optimal Default, Failsafe Default
	Disabled	
Enable or Disable Platform Hierarchy.		
Storage Hierarchy	Enabled	Optimal Default, Failsafe Default
	Disabled	
Enable or Disable Storage Hierarchy.		
Endorsement Hierarchy	Enabled	Optimal Default, Failsafe Default
	Disabled	
Enable or Disable Endorsement Hierarchy.		
Physical Presence Spec Version	1.3	Optimal Default, Failsafe Default
	1.2	
Select whether to instruct the operating system to use PPI Specification Version 1.2 or 1.3. Note that some HCK tests may not support Version 1.3.		
Device Select	Auto	
	TPM 1.2	
	TPM 2.0	Optimal Default, Failsafe Default
TPM 1.2 will restrict support to TPM 1.2 devices. TPM 2.0 will restrict support to TPM 2.0 devices. Auto will support both with the default set to TPM 2.0 devices if not found. TPM 1.2 devices will be enumerated.		

3.4.6 SATA Configuration

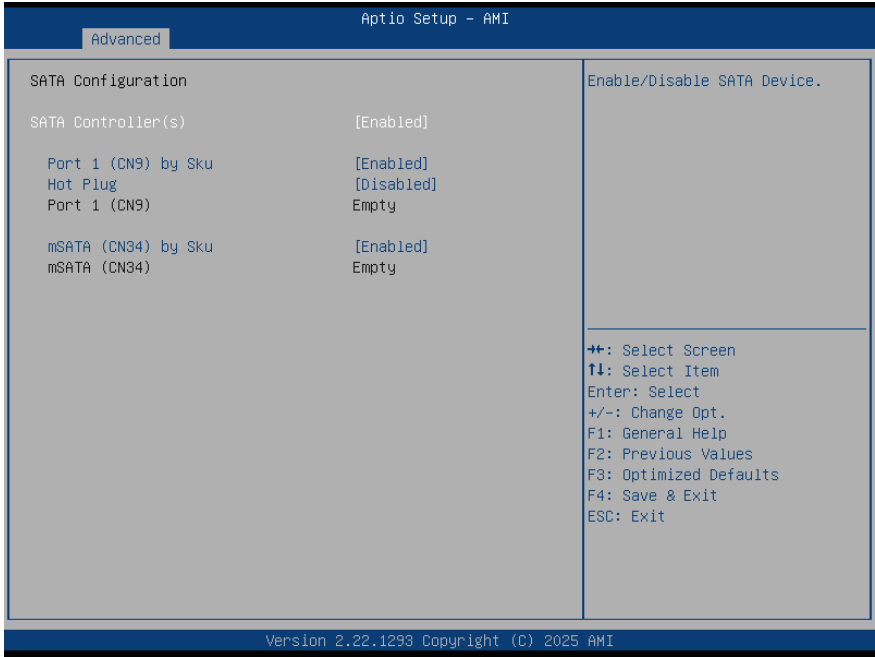

Options Summary		
SATA Controller(s)	Enabled	Optimal Default, Failsafe Default
	Disabled	
Enable/Disable SATA Device.		
Port 1 (CN9) by SKU	Enabled	Optimal Default, Failsafe Default
	Disabled	
Enable or Disable SATA Port.		
mSATA (CN34) by SKU	Enabled	Optimal Default, Failsafe Default
	Disabled	
Enable or Disable SATA Port.		

3.4.7 Hardware Monitor

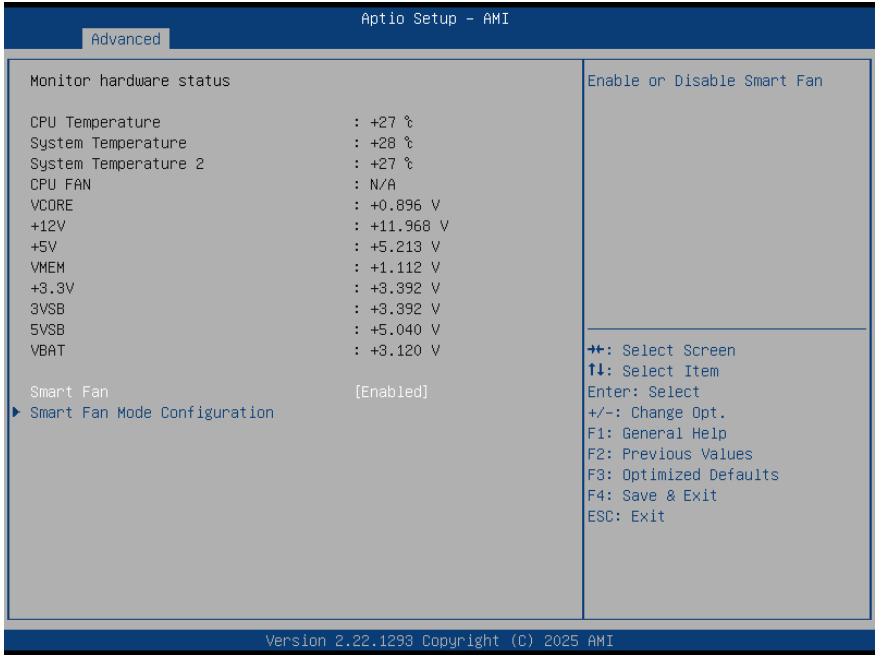

Options Summary		
Smart Fan	Disable	
	Enable	Optimal Default, Failsafe Default
Enables or Disables Smart Fan.		

3.4.7.1 Smart Fan Mode Configuration

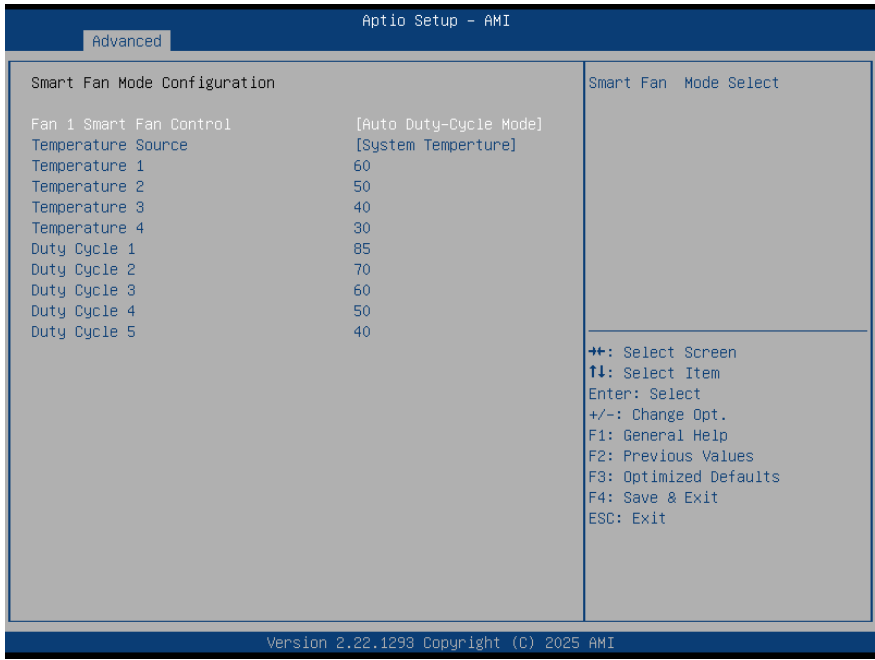

Options Summary		
Fan 1 Smart Fan Control	Manual Duty Mode	
	Auto Duty-Cycle Mode	Optimal Default, Failsafe Default
Smart Fan Mode Select.		
Temperature Source	CPU Temperature	Optimal Default, Failsafe Default
	System Temperature	
	System Temperature 2	
Select the monitored temperature source for this fan.		
Temperature 1	86	
Duty Cycle 1	100	
Enables automatic fan speed control. The fan speed adjusts according to temperature using a duty cycle between 1% and 100%.		

3.4.8 SIO Configuration

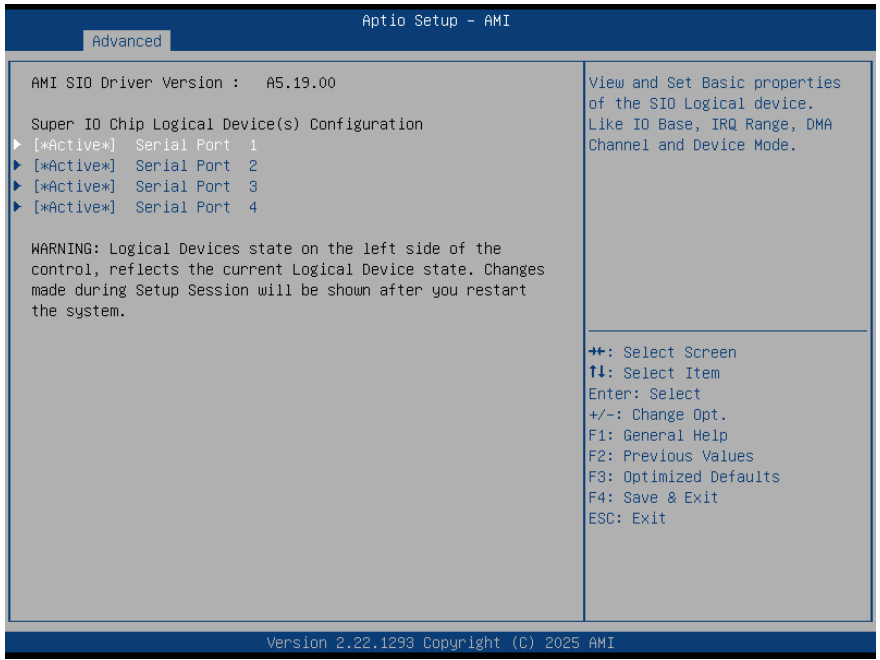

3.4.8.1 Serial Port 1 Configuration

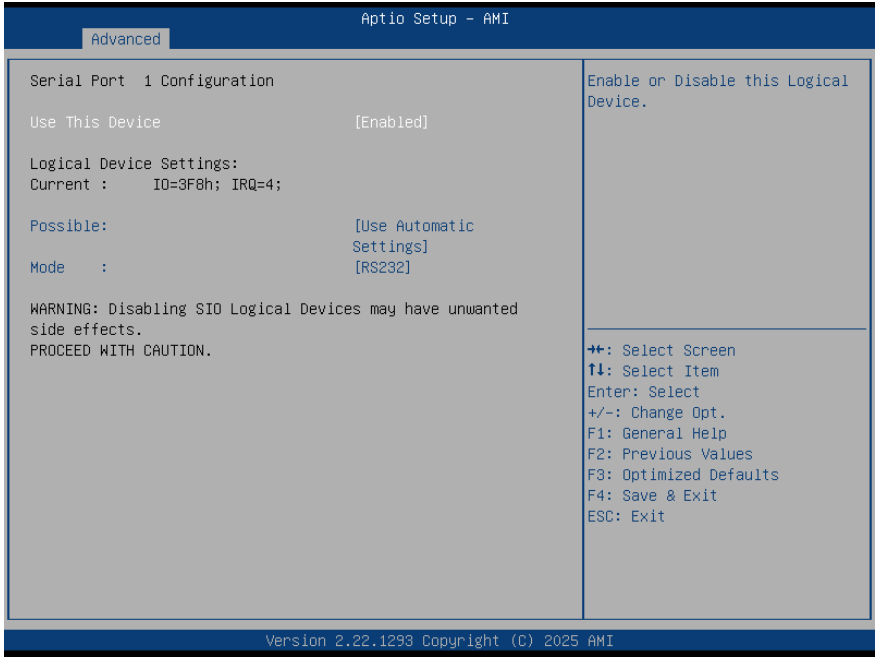

Options Summary		
Use This Device	Disable	
	Enable	Optimal Default, Failsafe Default
Enable or Disable this Logical Device.		
Possible:	Use Automatic Settings	Optimal Default, Failsafe Default
	IO=3F8h; IRQ=4	
	IO=2F8h; IRQ=3	
Allows user to change Device's Resource settings. New settings will be reflected on This Setup Page after System restarts.		
Mode:	RS232	Optimal Default, Failsafe Default
	RS422	
	RS485	
UART RS232, 422, 485 selection.		

3.4.8.2 Serial Port 2 Configuration



Options Summary		
Use This Device	Disable	
	Enable	Optimal Default, Failsafe Default
Enable or Disable this Logical Device.		
Possible:	Use Automatic Settings	Optimal Default, Failsafe Default
	IO=2F8h; IRQ=3	
	IO=3F8h; IRQ=4	
Allows user to change Device's Resource settings. New settings will be reflected on This Setup Page after System restarts.		
Mode:	RS232	Optimal Default, Failsafe Default
	RS422	
	RS485	
UART RS232, 422, 485 selection.		

3.4.8.3 Serial Port 3 Configuration

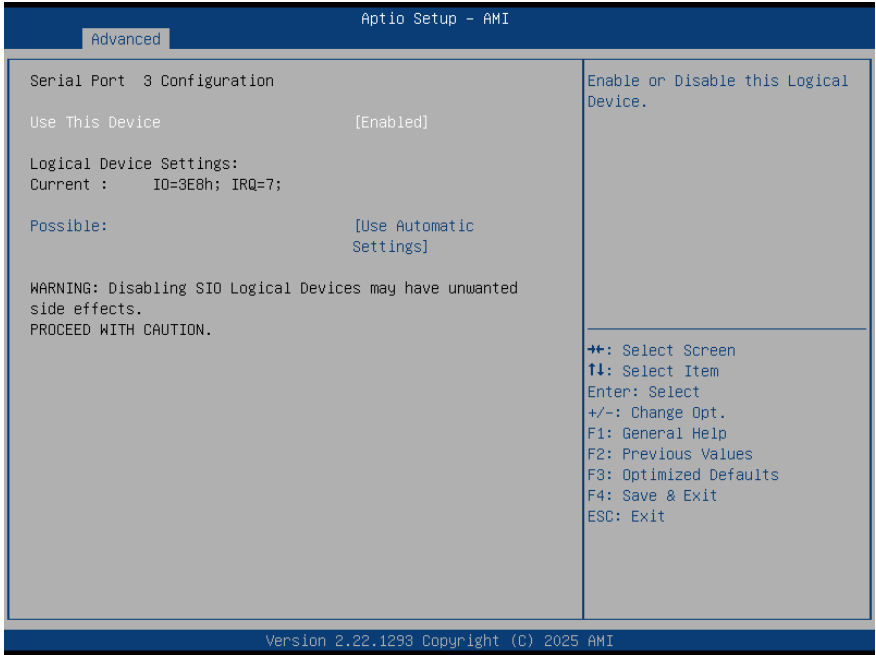

Options Summary		
Use This Device	Disable	
	Enable	Optimal Default, Failsafe Default
Enable or Disable this Logical Device.		
Possible:	Use Automatic Settings	Optimal Default, Failsafe Default
	IO=3E8h; IRQ=7	
	IO=2E8h; IRQ=8	
Allows user to change Device's Resource settings. New settings will be reflected on This Setup Page after System restarts.		

3.4.8.4 Serial Port 4 Configuration

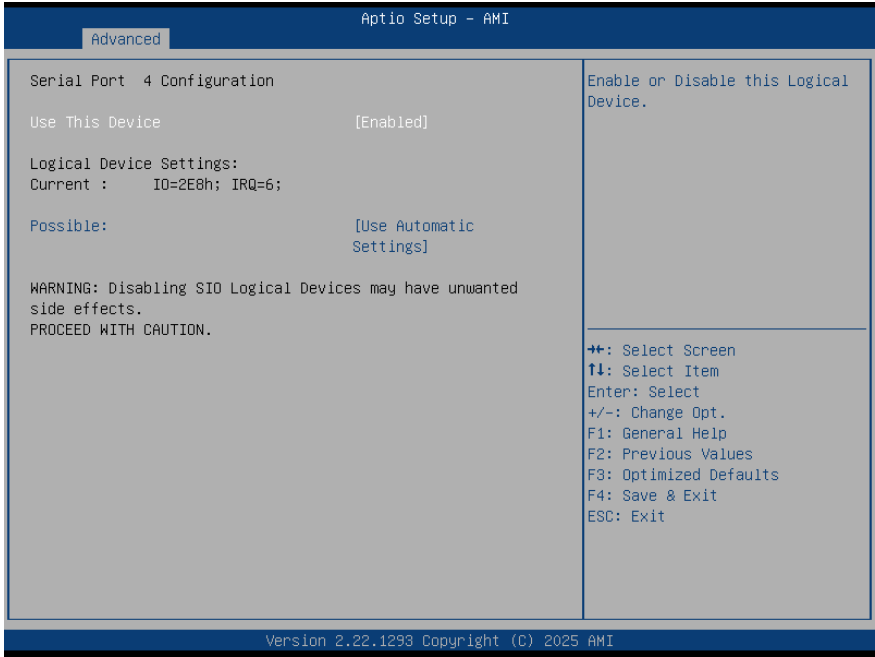

Options Summary		
Use This Device	Disable	
	Enable	Optimal Default, Failsafe Default
Enable or Disable this Logical Device.		
Possible:	Use Automatic Settings	Optimal Default, Failsafe Default
	IO=2E8h; IRQ=6	
	IO=3E8h; IRQ=7	
Allows user to change Device's Resource settings. New settings will be reflected on This Setup Page after System restarts.		

3.4.9 Serial Port Console Redirection

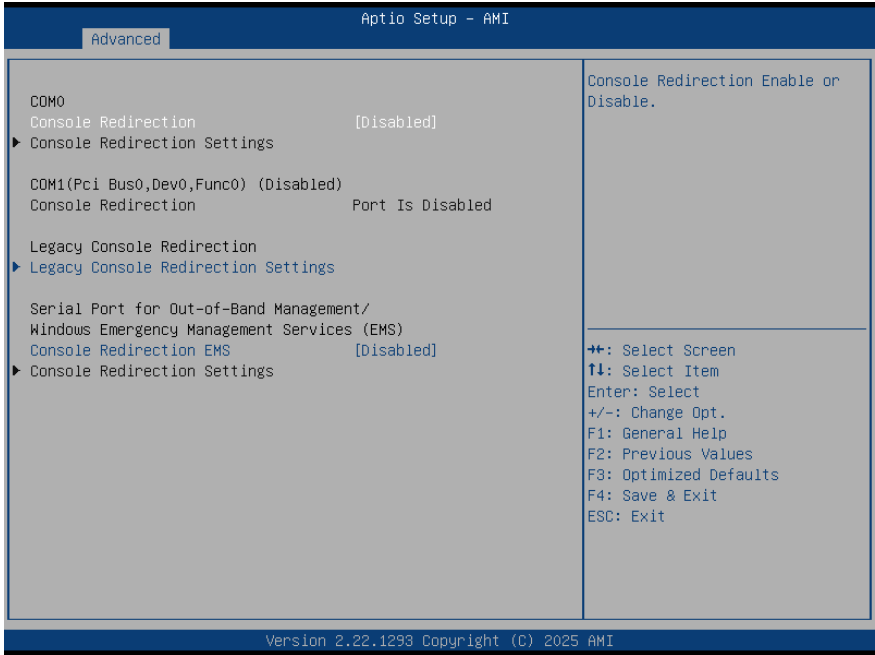

Options Summary		
Console Redirection	Disabled	Optimal Default, Failsafe Default
	Enabled	
Enable or Disable Console Redirection.		
Console Redirection EMS	Disabled	Optimal Default, Failsafe Default
	Enabled	
Enable or Disable Console Redirection EMS.		

3.4.10 Legacy Console Redirection Settings

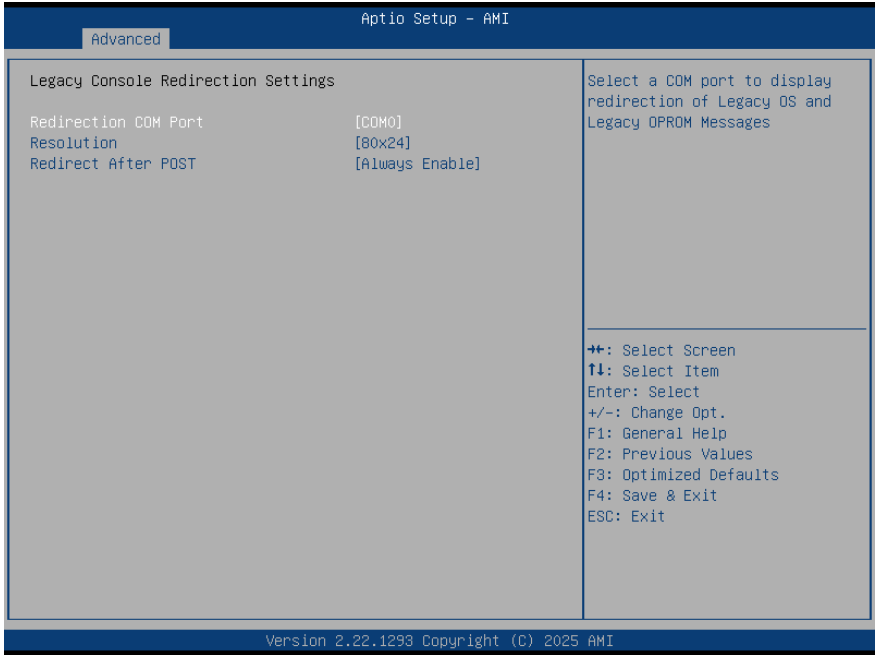

Options Summary		
Redirection COM port	COM0	Optimal Default, Failsafe Default
	COM1(Pci Bus0, Dev0, Func0) (Disabled)	
Select a COM port for displaying redirection messages from the Legacy OS and Legacy Option ROM (OPROM).		
Resolution	80x24	Optimal Default, Failsafe Default
	80x25	
Specifies the number of rows and columns supported for console redirection on a Legacy OS.		
Redirect After POST	Always Enable	Optimal Default, Failsafe Default
	BootLoader	
Bootloader: Disables Legacy Console Redirection before booting to a legacy OS. Always Enable: Keeps Legacy Console Redirection enabled for a legacy OS (default).		

3.4.11 AAEON BIOS Robot

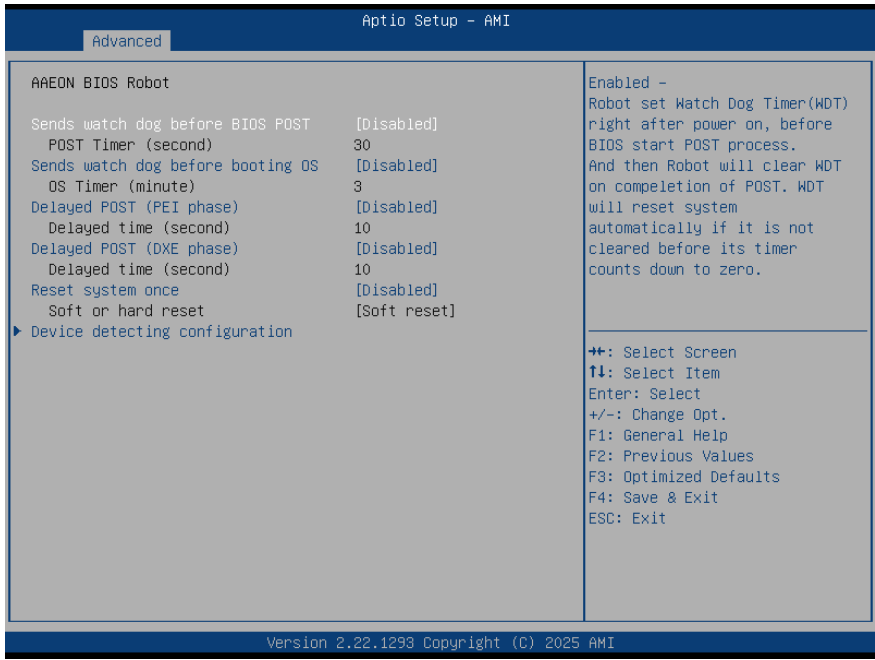

Options Summary		
Sends watch dog before BIOS POST	Disabled	Optimal Default, Failsafe Default
	Enabled	
<p>Enabled – The system sets the Watchdog Timer (WDT) immediately after power-on, before the BIOS begins the POST process. The WDT is cleared automatically upon POST completion. If the WDT is not cleared before the timer reaches zero, the system will reset automatically.</p>		
POST Timer (second)	30	Optimal Default, Failsafe Default
<p>Specifies the timer duration for the Watchdog Timer (WDT) during POST.</p> <p>Warning: Do not set the timer to a value equal to or shorter than the normal POST time, as this may prevent the system from completing POST unless BIOS settings are cleared. A timer value greater than twice the normal POST duration is recommended.</p>		
Sends watch dog before booting OS	Disabled	Optimal Default, Failsafe Default
	Enabled	
<p>Enabled – The system sets the Watchdog Timer (WDT) after POST completes, before the BIOS transfers control to the operating system.</p>		

Options Summary		
Warning: Before enabling this feature, ensure that an OS program is responsible for clearing the WDT. This function should be disabled if the OS will perform an update.		
OS Timer (minute)	3	Optimal Default, Failsafe Default
Specifies the timer duration for the Watchdog Timer (WDT) during OS loading.		
Delayed POST (PEI phase)	Disabled	Optimal Default, Failsafe Default
	Enabled	
Enabled – The system delays the start of BIOS POST immediately after power-on. This allows POST to begin with stable power or after the system has physically warmed up. Note: This delay occurs before the Watchdog Timer is activated.		
Delayed time (second)	10	Optimal Default, Failsafe Default
Period of time for Robot to hold BIOS from POST.		
Delayed POST (DXE phase)	Disabled	Optimal Default, Failsafe Default
	Enabled	
Enabled – The system delays BIOS POST before its completion, allowing POST to start with stable power or after the system has physically warmed up. Note: This delay occurs after the Watchdog Timer is activated prior to BIOS POST.		
Delayed time (second)	10	Optimal Default, Failsafe Default
Specifies the duration for which the system delays BIOS POST.		
Reset system once	Disabled	Optimal Default, Failsafe Default
	Enabled	
Enabled – The system performs a one-time reset on each boot. This sends a soft or hard reset to onboard devices, helping ensure they start in a stable state.		
Soft or hard reset	Soft reset	Optimal Default, Failsafe Default
	Hard reset"	
Select the type of reset the system should perform on each boot.		

3.4.11.1 Device Detecting Configuration



Options Summary		
Action	Reset System	Optimal Default, Failsafe Default
	Hold System	
Select action that robot should do.		
Soft or hard reset	Soft	Optimal Default, Failsafe Default
	Hard	
Select reset type robot should send on each boot.		
Retry-Count	30	Optimal Default, Failsafe Default
Fill retry counter here. Robot will reset system at most counter times, and then let system continue its POST.		
At time	After show logo	Optimal Default, Failsafe Default
	Before show logo	
Select the timing for the robot action during system boot.		
After Show Logo: The robot performs the action after the logo is displayed. At this stage, most system devices are initialized and ready.		

Options Summary

Before Show Logo: The robot performs the action before the logo is displayed. Some system devices may not yet be fully initialized.

3.4.11.2 Device #1 ~ #5 Detecting Configuration

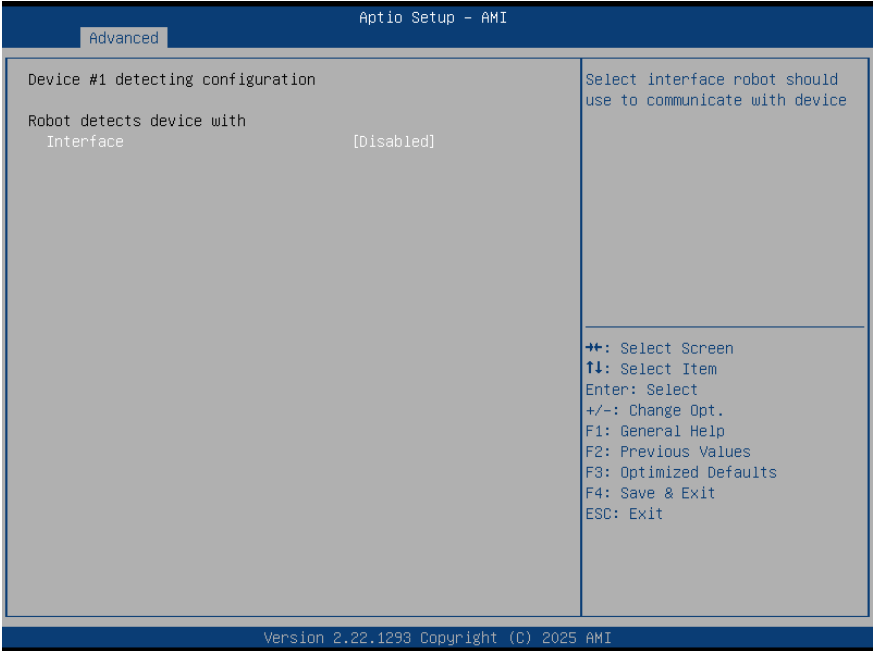

Options Summary

Interface	Disable	Optimal Default, Failsafe Default
	PCI	
	DIO	
	SMBUS	
	Legacy I/O	
	Super I/O	
	MMIO	

Select interface robot should use to communicate with device.

3.4.12 Power Management

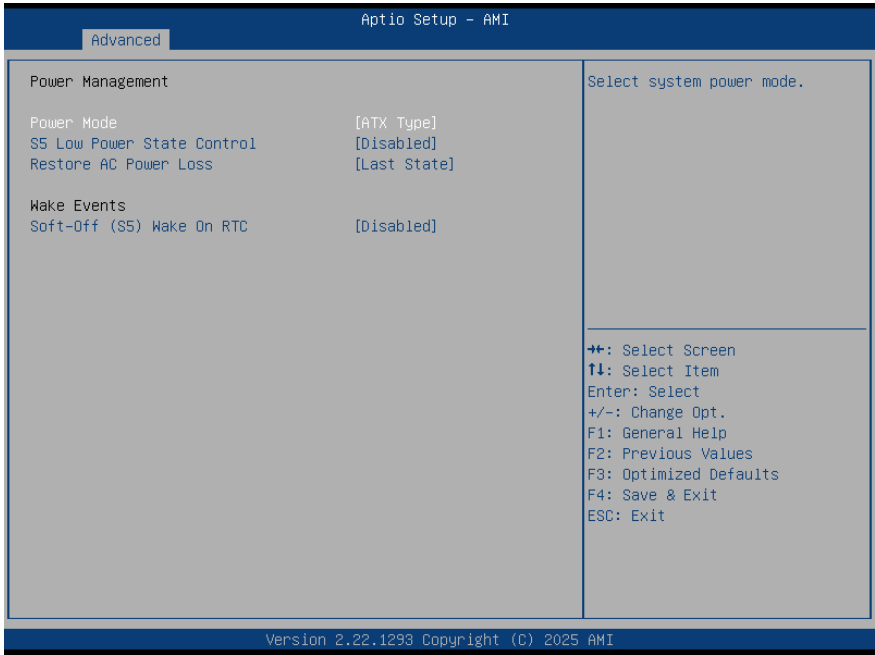

Options Summary		
Power Mode	ATX Type	Optimal Default, Failsafe Default
	AT Type	
Select power supply mode.		
Power Saving (ERP) Control	Disabled	Optimal Default, Failsafe Default
	Enabled	
Select power state when power is re-applied after a power failure.		
Restore AC Power Loss	Last State	Optimal Default, Failsafe Default
	Always On	
	Always Off	
Select power state when power is re-applied after a power failure.		
Soft-Off (S5) Wake On RTC	Disabled	Optimal Default, Failsafe Default
	By Date	
	By Weekday	
	Bypass	
By Date: The system will wake on the specified date at the designated hour, minute,		

Options Summary

and second.

By Weekday: The system will wake on the selected weekdays at the designated hour, minute, and second.

Bypass: BIOS will not control the RTC wake function.

3.4.13 GPIO Port Configuration



Options Summary

GPIO Port*	Output	
	Input	
Set GPIO as Input or Output.		
Output Level	High	
	Low	
Set output level when GPIO pin is Output.		

3.5 Setup Submenu: Chipset

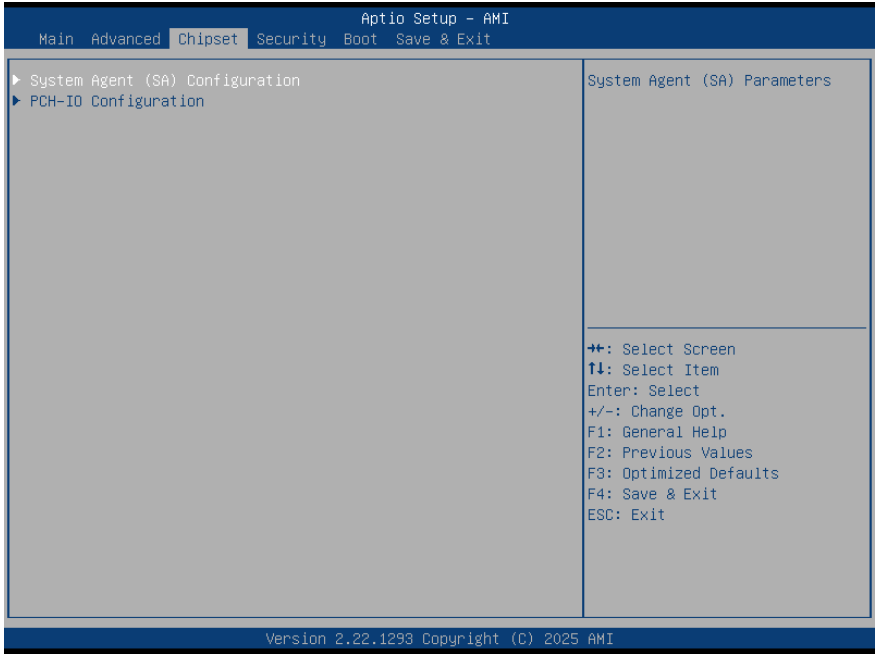

3.5.1 System Agent (SA) Configuration

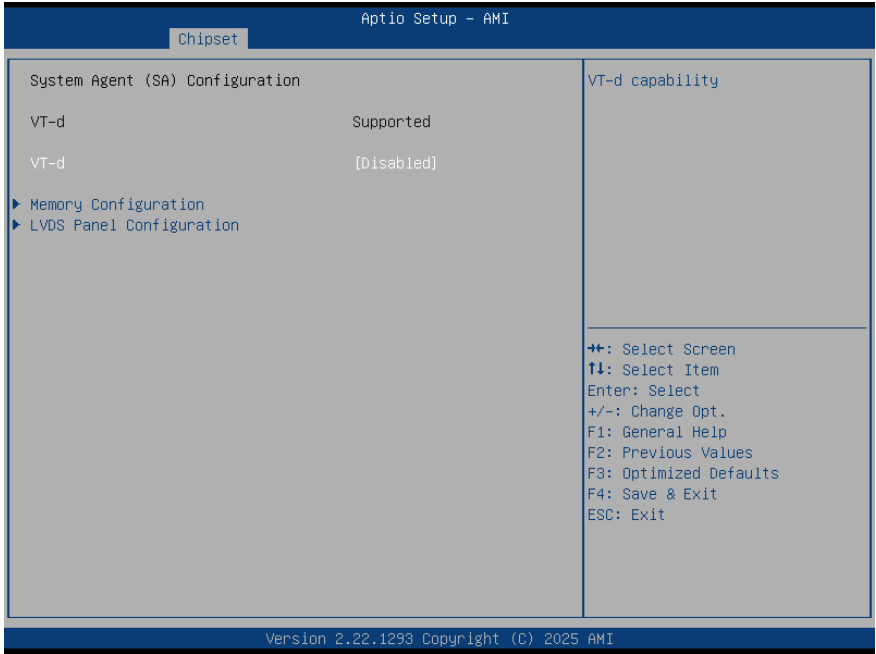

Options Summary		
VT-d	Disabled	Optimal Default, Failsafe Default
	Enabled	
VT-d capability.		

3.5.2 Memory Configuration

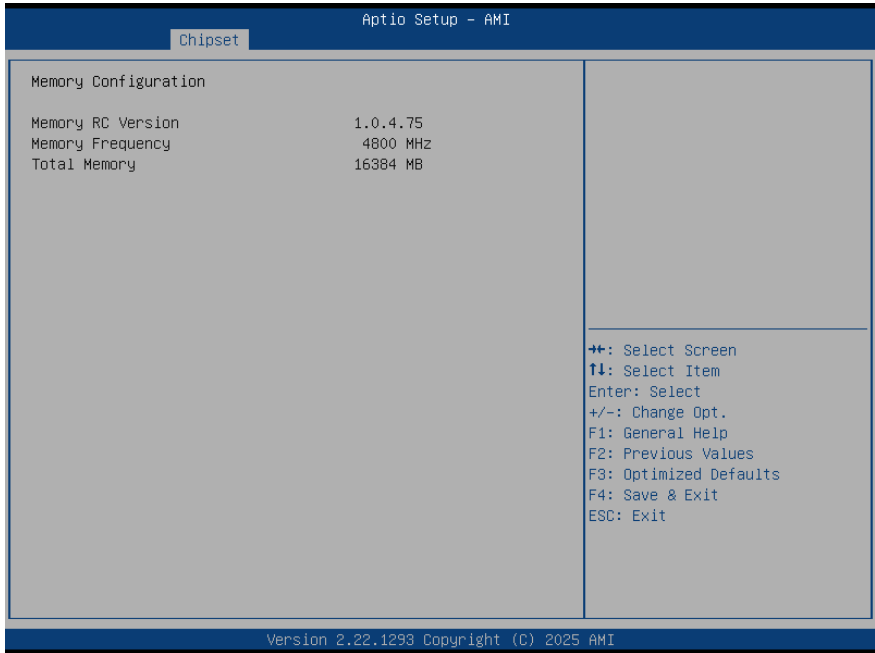

3.5.3 LVDS Panel Configuration

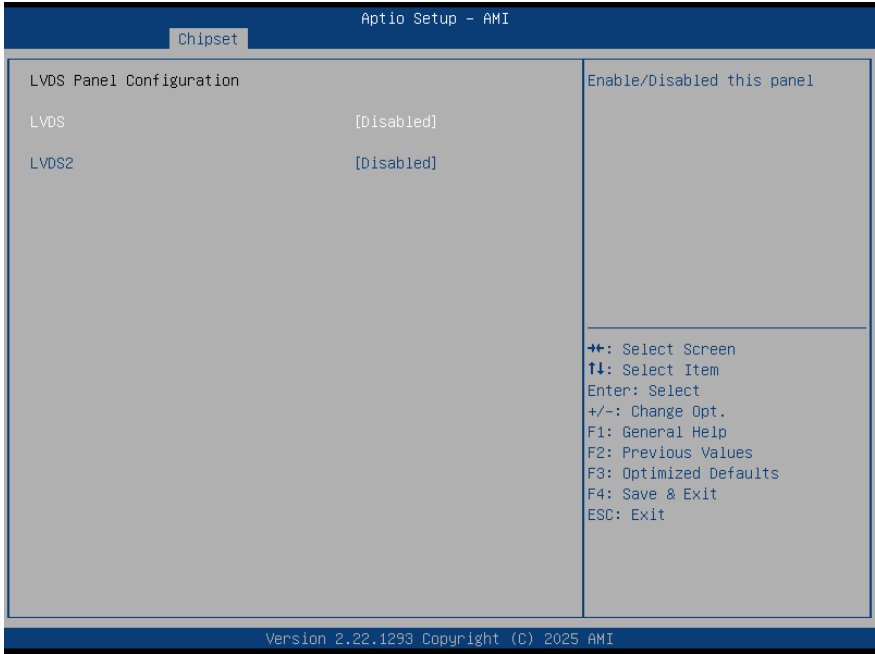

Options Summary		
LVDS	Disabled	
	Enabled	Optimal Default, Failsafe Default
Enable/Disabled this panel.		
LVDS Panel Type	640x480,18bit,60Hz	
	800x480,18bit,60Hz	
	800x600,18bit,60Hz	
	1024x600,18bit,60Hz	
	1024x768,18bit,60Hz	
	1024x768,24bit,60Hz	Optimal Default, Failsafe Default
	1280x768,24bit,60Hz	
	1280x1024,48bit,60Hz	
	1366x768,24bit,60Hz	
	1440x900,48bit,60Hz	
	1600x1200,48bit,60Hz	
1920x1080,48bit,60Hz		

Options Summary		
LVDS Panel Type Cont.	1920x1200,48bit,60Hz	
Select LCD panel used by Internal Graphics Device by selecting the appropriate setup item.		
Color Depth	18-bit	Optimal Default, Failsafe Default
	24-bit	
	36-bit	
	48-bit	
Select panel type.		
Backlight Mode	BIOS & Application	
	Windows Slider	Optimal Default, Failsafe Default
Select backlight control signal type.		
LVDS2	Disabled	
	Enabled	Optimal Default, Failsafe Default
Enable/Disabled this panel.		
LVDS2 Panel Type	640x480,18bit,60Hz	
	800x480,18bit,60Hz	
	800x600,18bit,60Hz	
	1024x600,18bit,60Hz	
	1024x768,18bit,60Hz	
	1024x768,24bit,60Hz	Optimal Default, Failsafe Default
	1280x768,24bit,60Hz	
	1280x1024,48bit,60Hz	
	1366x768,24bit,60Hz	
	1440x900,48bit,60Hz	
	1600x1200,48bit,60Hz	
	1920x1080,48bit,60Hz	
1920x1200,48bit,60Hz		
Select LCD panel used by Internal Graphics Device by selecting the appropriate setup item.		
Color Depth	18-bit	Optimal Default, Failsafe Default
	24-bit	
	36-bit	
	48-bit	
Select panel type.		
Backlight Mode	Inverter	
	Normal	Optimal Default, Failsafe Default
Select backlight control signal type.		

3.5.4 PCH-IO Configuration

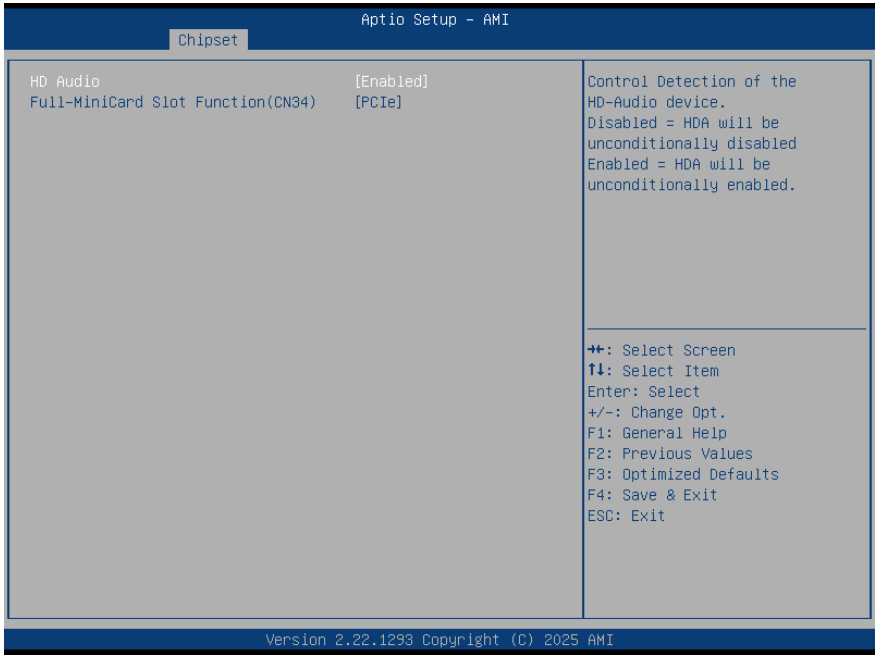

Options Summary		
HD Audio	Disabled	
	Enabled	Optimal Default, Failsafe Default
Controls the detection of the HD-Audio (HDA) device: Disabled: HDA is always disabled. Enabled: HDA is always enabled.		
Full-Mini Card Slot Function (CN34)	SATA	
	PCIe	Optimal Default, Failsafe Default
Select the function to be enabled for the Full-Mini Card (CN34) slot.		

3.6 Setup Submenu: Security

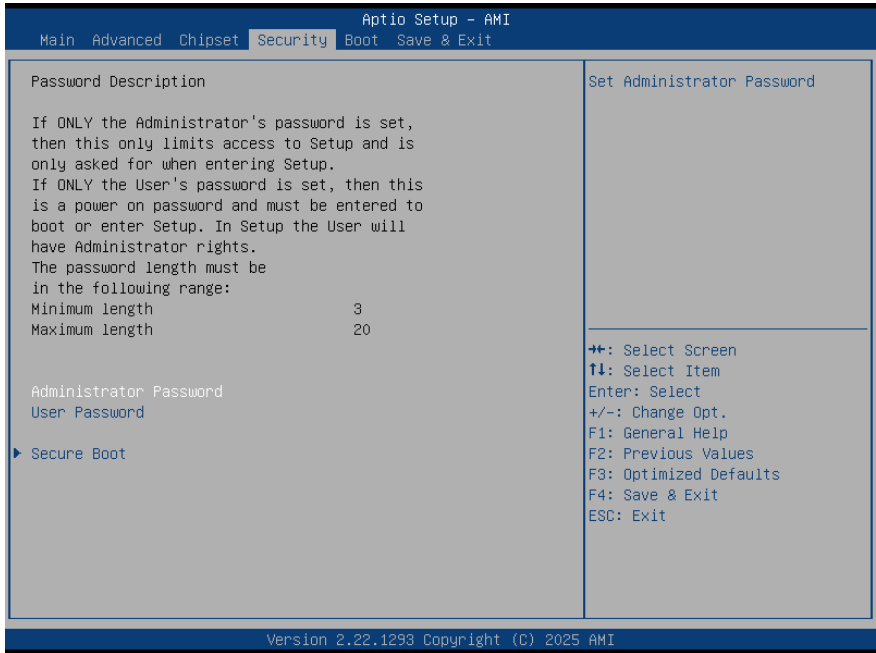

Change User/Supervisor Password

You can install a Supervisor password, and if you install a supervisor password, you can then install a user password. A user password does not provide access to many of the features in the Setup utility.

If you highlight these items and press Enter, a dialog box appears which lets you enter a password. You can enter no more than six letters or numbers. Press Enter after you have typed in the password. A second dialog box asks you to retype the password for confirmation. Press Enter after you have retyped it correctly. The password is required at boot time, or when the user enters the Setup utility.

Removing the Password

Highlight this item and type in the current password. At the next dialog box press Enter to disable password protection.

3.6.1 Secure Boot

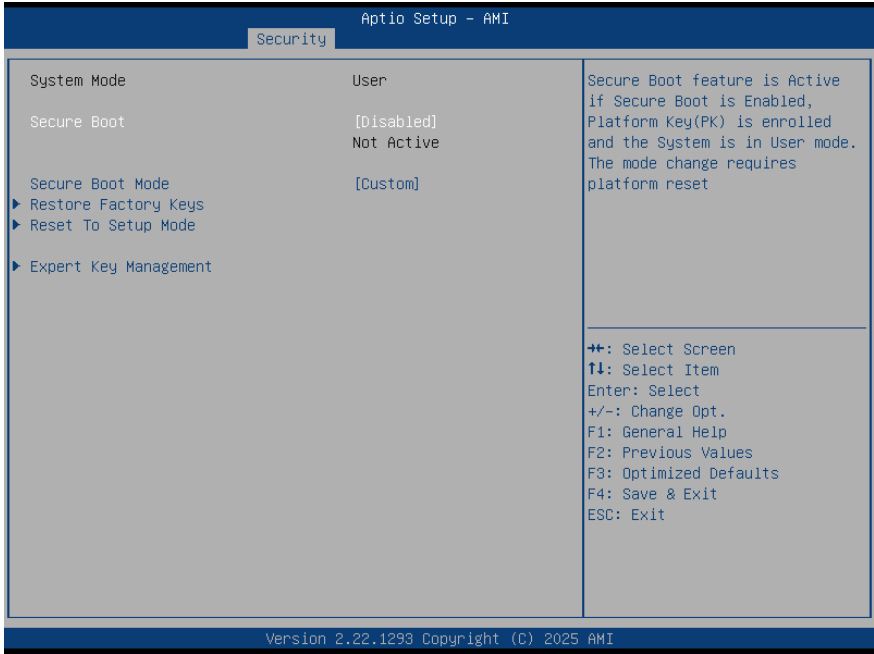

Options Summary		
Secure Boot	Disabled	Optimal Default, Failsafe Default
	Enabled	
The Secure Boot feature is active when Secure Boot is enabled, the Platform Key (PK) is enrolled, and the system is in User mode. Changing the mode requires a platform reset.		
Secure Boot Mode	Custom	Optimal Default, Failsafe Default
	Standard	
Secure Boot mode options: Standard or Custom . In Custom mode, a physically present user can configure Secure Boot Policy variables without full authentication.		
Restore Factory Keys		
Forces the system into User Mode and installs the factory default Secure Boot key databases.		
Reset to Setup Mode		
Deletes all Secure Boot key databases from NVRAM.		

3.6.2 Key Management



Options Summary		
Factory Key Provision	Disabled	Optimal Default, Failsafe Default
	Enabled	
The Secure Boot feature is active when Secure Boot is enabled, the Platform Key (PK) is enrolled, and the system is in User mode. Changing the mode requires a platform reset.		
Restore Factory Keys		
Forces the system into User Mode and installs the factory default Secure Boot key databases.		
Reset to Setup Mode		
Delete all Secure Boot key databases from NVRAM.		
Export Secure Boot variables		
Copies the NVRAM contents of Secure Boot variables to files in the root directory of a file system device.		
Enroll Efi Image		

Options Summary	
Allows the image to run in Secure Boot mode by enrolling the SHA-256 hash certificate of a PE image into the Authorized Signature Database (db).	
Remove 'UEFI CA' from DB	
A Device Guard-ready system must not include the "Microsoft UEFI CA" certificate in the Authorized Signature Database (db).	
Restore DB defaults	
Restore DB variable to factory defaults.	
Platform Key (PK)	Details
	Export
	Update
	Delete
Key Exchange Keys	Details
	Export
	Update
	Append
	Delete
Authorized Signatures	Details
	Export
	Update
	Append
	Delete
Forbidden Signatures	Details
	Export
	Update
	Append
	Delete
Authorized TimeStamps	Update
	Append
OsRecovery Signatures	Update
	Append
Enroll Factory Defaults or load certificates from a file:	
1.Public Key Certificate:	
a) EFI_SIGNATURE_LIST	
b) EFI_CERT_X509 (DER)	
c) EFI_CERT_RSA2048 (bin)	
d) EFI_CERT_SHAXXX	
2.Authenticated UEFI Variable	
3.EFI PE/COFF Image (SHA256)	
Key Source: Factory, External, Mixed	

3.7 Setup Submenu: Boot

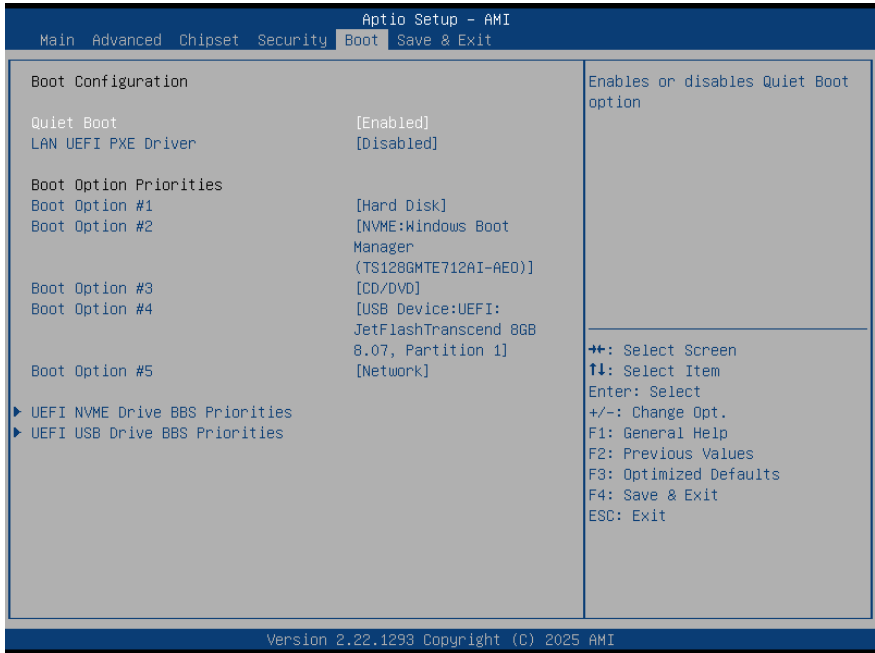

Options Summary		
Quiet Boot	Disabled	
	Enabled	Optimal Default, Failsafe Default
Enable or Disable Quiet Boot option.		
UEFI PXE Support	Disabled	Optimal Default, Failsafe Default
	Enabled	
Enable/Disable UEFI Network Stack.		
FIXED BOOT ORDER Priorities		
Sets the system boot order.		

3.7.1 BBS Priorities



3.8 Setup Submenu: Save & Exit

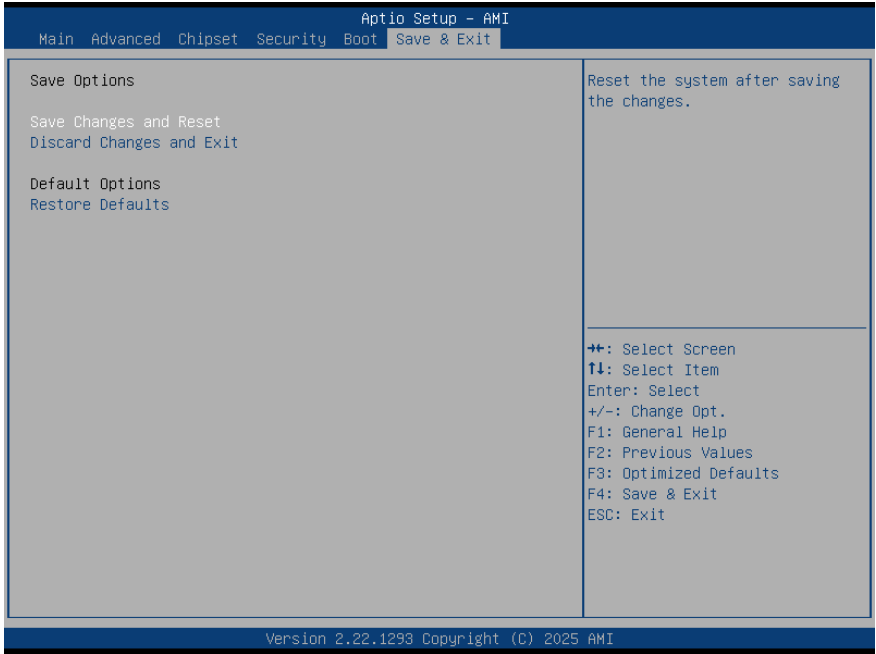

Options Summary	
Save Changes and Reset	Reset the system after saving the changes.
Discard Changes and Exit	Exit system setup without saving any changes.
Restore Defaults	Restore/Load Default values for all the setup options.

Chapter 4

Driver Installation

4.1 Driver Download/Installation

Drivers for the GENE-TWL7 can be downloaded from the product page on the AAEON website by following this link:

https://www.aaeon.com/en/product/detail/subcompact_boards_gene-tw17/download

Download the driver(s) you need and follow the steps below to install them.

Chipset Driver

1. Open the folder where you unzipped the **Chipset Drivers**.
2. Run the **SetupChipset.exe** file in the folder.
3. Follow the instructions.
4. Driver will be installed automatically.

Graphics Driver

1. Open the **Graphics Driver** folder
2. Run the **Installer.exe** file in the folder.
3. Follow the instructions.
4. Driver will be installed automatically.

LAN Drivers

1. **Open the folder** where you unzipped the LAN driver package (for example, 638910-I225-I226-NDIS-Win-x64-1.1.4.42.zip).
2. Verify the LAN driver files are present:
 - **e2f.inf** – Setup Information
 - **e2f.sys** – System file
 - **e2fmsg.dll** – Application extension
 - **e2f.cat** – Security Catalog
3. Open **Device Manager**, press **Windows + X**, then select **Device Manager** to locate the Ethernet controller. Expand **Network adapters** or **Other devices** (the device may appear as **Ethernet Controller** or **Unknown device**).
4. Right-click the Ethernet controller and select **Update driver**.
 - Choose **Browse my computer for drivers**.
 - Click **Browse**, then navigate to the folder containing **e2f.inf**.
 - Click **Next** to install the driver.
5. Confirm the Intel® Ethernet adapter appears under **Network adapters** with no warning icons.

Install Intel Smart Sound Driver

1. Open the **Intel Smart Sound** folder
2. Navigate the folder as follows: **Production** > **Drivers**, then follow the below instructions to install the BUS Driver (IntcAudioBus.inf) and OED Driver (IntcOED.inf).

Install BUS driver (IntcAudioBus.inf)

- a. Press Right Key -> Install

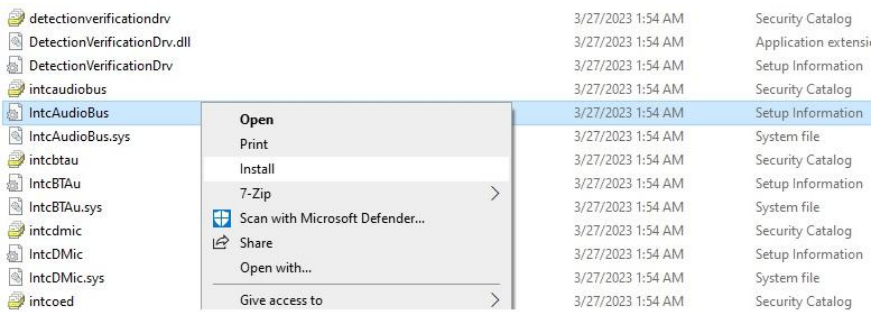

Install OED driver (IntcOED.inf)

- b. Press Right Key -> Install

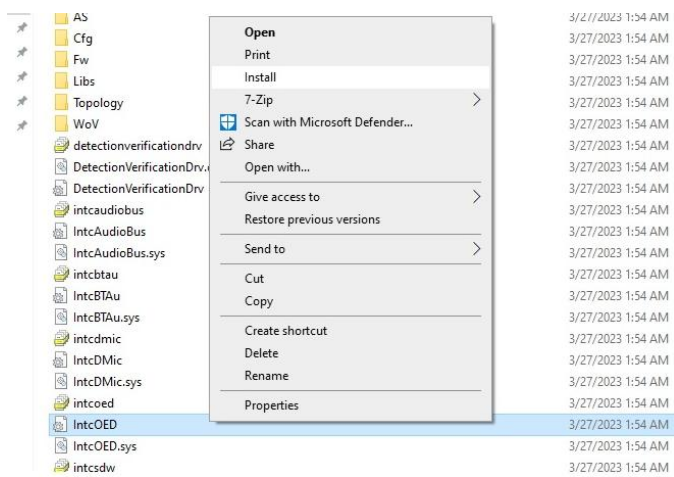

Install ReakTek Audio Driver

1. Open the **ReakTek Audio** folder
2. Run the **Setup.exe** file in the folder.
3. Follow the instructions.
4. Driver will be installed automatically.

Install Cmedia Audio Driver

1. Open the **Cmedia Audio** folder
2. Run the **CM9825_AAEON_Audio_Driver_Setup_1.0.2.exe** file in the folder.
3. Follow the instructions.
4. Driver will be installed automatically.

Install Intel ME Driver

1. Open the **Intel CSME** folder and select your OS
2. Open the **SetupME.exe** file
3. Follow the instructions
4. Drivers will be installed automatically

































Install Peripheral Serial I/O Driver















1. Open the **Peripheral Driver** folder
2. Open the **SetupSerialIO.exe** file
3. Follow the instructions
4. Drivers will be installed automatically

Appendix A

I/O Information

A.1 I/O Address Map

Input/output (I/O)	
	[0000000000000000 - 000000000000CF7] PCI Express Root Complex
	[0000000000000020 - 0000000000000021] Programmable interrupt controller
	[0000000000000024 - 0000000000000025] Programmable interrupt controller
	[0000000000000028 - 0000000000000029] Programmable interrupt controller
	[000000000000002C - 000000000000002D] Programmable interrupt controller
	[000000000000002E - 000000000000002F] Motherboard resources
	[0000000000000030 - 0000000000000031] Programmable interrupt controller
	[0000000000000034 - 0000000000000035] Programmable interrupt controller
	[0000000000000038 - 0000000000000039] Programmable interrupt controller
	[000000000000003C - 000000000000003D] Programmable interrupt controller
	[0000000000000040 - 0000000000000043] System timer
	[000000000000004E - 000000000000004F] Motherboard resources
	[0000000000000050 - 0000000000000053] System timer
	[0000000000000061 - 0000000000000061] Motherboard resources
	[0000000000000063 - 0000000000000063] Motherboard resources
	[0000000000000065 - 0000000000000065] Motherboard resources
	[0000000000000067 - 0000000000000067] Motherboard resources
	[0000000000000070 - 0000000000000070] Motherboard resources
	[0000000000000080 - 0000000000000080] Motherboard resources
	[0000000000000092 - 0000000000000092] Motherboard resources
	[00000000000000A0 - 00000000000000A1] Programmable interrupt controller
	[00000000000000A4 - 00000000000000A5] Programmable interrupt controller
	[00000000000000A8 - 00000000000000A9] Programmable interrupt controller
	[00000000000000AC - 00000000000000AD] Programmable interrupt controller
	[00000000000000B0 - 00000000000000B1] Programmable interrupt controller
	[00000000000000B2 - 00000000000000B3] Motherboard resources
	[00000000000000B4 - 00000000000000B5] Programmable interrupt controller
	[00000000000000B8 - 00000000000000B9] Programmable interrupt controller
	[00000000000000BC - 00000000000000BD] Programmable interrupt controller
	[00000000000002E8 - 00000000000002EF] Communications Port (COM4)
	[00000000000002F8 - 00000000000002FF] Communications Port (COM2)
	[00000000000003E8 - 00000000000003EF] Communications Port (COM3)

	[00000000000003F8 - 00000000000003FF]	Communications Port (COM1)
	[00000000000004D0 - 00000000000004D1]	Programmable interrupt controller
	[0000000000000680 - 000000000000069F]	Motherboard resources
	[0000000000000A00 - 0000000000000A0F]	Motherboard resources
	[0000000000000A10 - 0000000000000A1F]	Motherboard resources
	[0000000000000A20 - 0000000000000A2F]	Motherboard resources
	[0000000000000D00 - 000000000000FFFF]	PCI Express Root Complex
	[000000000000164E - 000000000000164F]	Motherboard resources
	[0000000000001854 - 0000000000001857]	Motherboard resources
	[0000000000002000 - 00000000000020FE]	Motherboard resources
	[0000000000003060 - 000000000000307F]	Standard SATA AHCI Controller
	[0000000000003080 - 0000000000003083]	Standard SATA AHCI Controller
	[0000000000003090 - 0000000000003097]	Standard SATA AHCI Controller
	[000000000000EFA0 - 000000000000EFBF]	SMBus - 54A3
	[000000000000FFC0 - 000000000000FFFF]	Intel(R) UHD Graphics

A.2 Large Memory



Large Memory





































































[0000004000000000 - 0000007FFFFFFFFF] PCI Express Root Complex

































A.3 Memory Address Map

































Memory	
[0000000000A0000 - 0000000000BFFFFF]	PCI Express Root Complex
[0000000080400000 - 00000000804FFFFF]	Intel(R) Ethernet Controller I226-V #2
[0000000080400000 - 00000000805FFFFF]	PCI Express Root Port #4 - 54B8
[0000000080400000 - 00000000BFFFFFFF]	PCI Express Root Complex
[0000000080500000 - 0000000080503FFF]	Intel(R) Ethernet Controller I226-V #2
[0000000080600000 - 00000000806FFFFF]	Intel(R) Ethernet Controller I226-V
[0000000080600000 - 00000000807FFFFF]	PCI Express Root Port #3 - 54BA
[0000000080700000 - 0000000080703FFF]	Intel(R) Ethernet Controller I226-V
[0000000080800000 - 0000000080803FFF]	Standard NVM Express Controller
[0000000080800000 - 00000000808FFFFF]	PCI Express Root Port #9 - 54B0
[0000000080900000 - 0000000080901FFF]	Standard SATA AHCI Controller
[0000000080902000 - 00000000809027FF]	Standard SATA AHCI Controller
[0000000080903000 - 00000000809030FF]	Standard SATA AHCI Controller
[00000000C0000000 - 00000000CFFFFFFF]	Motherboard resources
[00000000FD690000 - 00000000FD69FFFFF]	Intel(R) Serial IO GPIO Host Controller - INTC1057
[00000000FD6A0000 - 00000000FD6AFFFFF]	Intel(R) Serial IO GPIO Host Controller - INTC1057
[00000000FD6D0000 - 00000000FD6DFFFFF]	Intel(R) Serial IO GPIO Host Controller - INTC1057
[00000000FD6E0000 - 00000000FD6EFFFFF]	Intel(R) Serial IO GPIO Host Controller - INTC1057
[00000000FE010000 - 00000000FE010FFF]	SPI (flash) Controller - 54A4
[00000000FED00000 - 00000000FED003FF]	High precision event timer
[00000000FED20000 - 00000000FED27FFF]	Motherboard resources
[00000000FED45000 - 00000000FED48FFF]	Motherboard resources
[00000000FED90000 - 00000000FED93FFF]	Motherboard resources
[00000000FEDA0000 - 00000000FEDA0FFF]	Motherboard resources
[00000000FEDA1000 - 00000000FEDA1FFF]	Motherboard resources
[00000000FEDC0000 - 00000000FEDC7FFF]	Motherboard resources
[00000000FEE00000 - 00000000FEE0FFFFF]	Motherboard resources
[0000004000000000 - 000000400000FFFFF]	Intel(R) UHD Graphics
[0000006000000000 - 000000600000FFFFF]	Intel(R) UHD Graphics
[0000006001100000 - 000000600110FFFFF]	Intel(R) USB 3.1 eXtensible Host Controller - 1.20 (Microsoft)
[0000006001110000 - 0000006001117FFF]	Intel(R) Platform Monitoring Technology Driver
[0000006001128000 - 00000060011280FF]	SMBus - 54A3
[0000007FFFEF8000 - 0000007FFFEF8FFF]	Intel(R) Serial IO I2C Host Controller - 54C5
[0000007FFFEF8000 - 0000007FFFEF8FFF]	Intel(R) Serial IO I2C Host Controller - 54C5
[0000007FFFEF9000 - 0000007FFFEF9FFF]	Intel(R) Management Engine Interface #1
[0000007FFFEFA000 - 0000007FFFEFAFFF]	Intel(R) Serial IO I2C Host Controller - 54E8
[0000007FFFEFB000 - 0000007FFFEFBFFF]	Intel(R) Serial IO UART Host Controller - 54A8
[0000007FFFEFC000 - 0000007FFFEFCFFF]	Intel® Smart Sound Technology BUS
[0000007FFFEF0000 - 0000007FFFEF0FFF]	Intel® Smart Sound Technology BUS

































A.3 IRQ Mapping Chart

































Interrupt request (IRQ)	
 (ISA) 0x00000000 (00)	System timer
 (ISA) 0x00000003 (03)	Communications Port (COM2)
 (ISA) 0x00000004 (04)	Communications Port (COM1)
 (ISA) 0x00000006 (06)	Communications Port (COM4)
 (ISA) 0x00000007 (07)	Communications Port (COM3)
 (ISA) 0x0000000E (14)	Intel(R) Serial IO GPIO Host Controller - INTC1057
 (ISA) 0x00000037 (55)	Microsoft ACPI-Compliant System
 (ISA) 0x00000038 (56)	Microsoft ACPI-Compliant System
 (ISA) 0x00000039 (57)	Microsoft ACPI-Compliant System
 (ISA) 0x0000003A (58)	Microsoft ACPI-Compliant System
 (ISA) 0x0000003B (59)	Microsoft ACPI-Compliant System
 (ISA) 0x0000003C (60)	Microsoft ACPI-Compliant System
 (ISA) 0x0000003D (61)	Microsoft ACPI-Compliant System
 (ISA) 0x0000003E (62)	Microsoft ACPI-Compliant System
 (ISA) 0x0000003F (63)	Microsoft ACPI-Compliant System
 (ISA) 0x00000040 (64)	Microsoft ACPI-Compliant System
 (ISA) 0x00000041 (65)	Microsoft ACPI-Compliant System
 (ISA) 0x00000042 (66)	Microsoft ACPI-Compliant System
 (ISA) 0x00000043 (67)	Microsoft ACPI-Compliant System
 (ISA) 0x00000044 (68)	Microsoft ACPI-Compliant System
 (ISA) 0x00000045 (69)	Microsoft ACPI-Compliant System
 (ISA) 0x00000046 (70)	Microsoft ACPI-Compliant System
 (ISA) 0x00000047 (71)	Microsoft ACPI-Compliant System
 (ISA) 0x00000048 (72)	Microsoft ACPI-Compliant System
 (ISA) 0x00000049 (73)	Microsoft ACPI-Compliant System
 (ISA) 0x0000004A (74)	Microsoft ACPI-Compliant System
 (ISA) 0x0000004B (75)	Microsoft ACPI-Compliant System
 (ISA) 0x0000004C (76)	Microsoft ACPI-Compliant System
 (ISA) 0x0000004D (77)	Microsoft ACPI-Compliant System
 (ISA) 0x0000004E (78)	Microsoft ACPI-Compliant System
 (ISA) 0x0000004F (79)	Microsoft ACPI-Compliant System
 (ISA) 0x00000050 (80)	Microsoft ACPI-Compliant System
 (ISA) 0x00000051 (81)	Microsoft ACPI-Compliant System

































 (ISA) 0x00000052 (82)	Microsoft ACPI-Compliant System
 (ISA) 0x00000053 (83)	Microsoft ACPI-Compliant System
 (ISA) 0x00000054 (84)	Microsoft ACPI-Compliant System
 (ISA) 0x00000055 (85)	Microsoft ACPI-Compliant System
 (ISA) 0x00000056 (86)	Microsoft ACPI-Compliant System
 (ISA) 0x00000057 (87)	Microsoft ACPI-Compliant System
 (ISA) 0x00000058 (88)	Microsoft ACPI-Compliant System
 (ISA) 0x00000059 (89)	Microsoft ACPI-Compliant System
 (ISA) 0x0000005A (90)	Microsoft ACPI-Compliant System
 (ISA) 0x0000005B (91)	Microsoft ACPI-Compliant System
 (ISA) 0x0000005C (92)	Microsoft ACPI-Compliant System
 (ISA) 0x0000005D (93)	Microsoft ACPI-Compliant System
 (ISA) 0x0000005E (94)	Microsoft ACPI-Compliant System
 (ISA) 0x0000005F (95)	Microsoft ACPI-Compliant System
 (ISA) 0x00000060 (96)	Microsoft ACPI-Compliant System
 (ISA) 0x00000061 (97)	Microsoft ACPI-Compliant System
 (ISA) 0x00000062 (98)	Microsoft ACPI-Compliant System
 (ISA) 0x00000063 (99)	Microsoft ACPI-Compliant System
 (ISA) 0x00000064 (100)	Microsoft ACPI-Compliant System
 (ISA) 0x00000065 (101)	Microsoft ACPI-Compliant System
 (ISA) 0x00000066 (102)	Microsoft ACPI-Compliant System
 (ISA) 0x00000067 (103)	Microsoft ACPI-Compliant System
 (ISA) 0x00000068 (104)	Microsoft ACPI-Compliant System
 (ISA) 0x00000069 (105)	Microsoft ACPI-Compliant System
 (ISA) 0x0000006A (106)	Microsoft ACPI-Compliant System
 (ISA) 0x0000006B (107)	Microsoft ACPI-Compliant System
 (ISA) 0x0000006C (108)	Microsoft ACPI-Compliant System
 (ISA) 0x0000006D (109)	Microsoft ACPI-Compliant System
 (ISA) 0x0000006E (110)	Microsoft ACPI-Compliant System
 (ISA) 0x0000006F (111)	Microsoft ACPI-Compliant System
 (ISA) 0x00000070 (112)	Microsoft ACPI-Compliant System
 (ISA) 0x00000071 (113)	Microsoft ACPI-Compliant System
 (ISA) 0x00000072 (114)	Microsoft ACPI-Compliant System

































 (ISA) 0x00000073 (115)	Microsoft ACPI-Compliant System
 (ISA) 0x00000074 (116)	Microsoft ACPI-Compliant System
 (ISA) 0x00000075 (117)	Microsoft ACPI-Compliant System
 (ISA) 0x00000076 (118)	Microsoft ACPI-Compliant System
 (ISA) 0x00000077 (119)	Microsoft ACPI-Compliant System
 (ISA) 0x00000078 (120)	Microsoft ACPI-Compliant System
 (ISA) 0x00000079 (121)	Microsoft ACPI-Compliant System
 (ISA) 0x0000007A (122)	Microsoft ACPI-Compliant System
 (ISA) 0x0000007B (123)	Microsoft ACPI-Compliant System
 (ISA) 0x0000007C (124)	Microsoft ACPI-Compliant System
 (ISA) 0x0000007D (125)	Microsoft ACPI-Compliant System
 (ISA) 0x0000007E (126)	Microsoft ACPI-Compliant System
 (ISA) 0x0000007F (127)	Microsoft ACPI-Compliant System
 (ISA) 0x00000080 (128)	Microsoft ACPI-Compliant System
 (ISA) 0x00000081 (129)	Microsoft ACPI-Compliant System
 (ISA) 0x00000082 (130)	Microsoft ACPI-Compliant System
 (ISA) 0x00000083 (131)	Microsoft ACPI-Compliant System
 (ISA) 0x00000084 (132)	Microsoft ACPI-Compliant System
 (ISA) 0x00000085 (133)	Microsoft ACPI-Compliant System
 (ISA) 0x00000086 (134)	Microsoft ACPI-Compliant System
 (ISA) 0x00000087 (135)	Microsoft ACPI-Compliant System
 (ISA) 0x00000088 (136)	Microsoft ACPI-Compliant System
 (ISA) 0x00000089 (137)	Microsoft ACPI-Compliant System
 (ISA) 0x0000008A (138)	Microsoft ACPI-Compliant System
 (ISA) 0x0000008B (139)	Microsoft ACPI-Compliant System
 (ISA) 0x0000008C (140)	Microsoft ACPI-Compliant System
 (ISA) 0x0000008D (141)	Microsoft ACPI-Compliant System
 (ISA) 0x0000008E (142)	Microsoft ACPI-Compliant System
 (ISA) 0x0000008F (143)	Microsoft ACPI-Compliant System
 (ISA) 0x00000090 (144)	Microsoft ACPI-Compliant System
 (ISA) 0x00000091 (145)	Microsoft ACPI-Compliant System
 (ISA) 0x00000092 (146)	Microsoft ACPI-Compliant System
 (ISA) 0x00000093 (147)	Microsoft ACPI-Compliant System

































 (ISA) 0x00000094 (148)	Microsoft ACPI-Compliant System
 (ISA) 0x00000095 (149)	Microsoft ACPI-Compliant System
 (ISA) 0x00000096 (150)	Microsoft ACPI-Compliant System
 (ISA) 0x00000097 (151)	Microsoft ACPI-Compliant System
 (ISA) 0x00000098 (152)	Microsoft ACPI-Compliant System
 (ISA) 0x00000099 (153)	Microsoft ACPI-Compliant System
 (ISA) 0x0000009A (154)	Microsoft ACPI-Compliant System
 (ISA) 0x0000009B (155)	Microsoft ACPI-Compliant System
 (ISA) 0x0000009C (156)	Microsoft ACPI-Compliant System
 (ISA) 0x0000009D (157)	Microsoft ACPI-Compliant System
 (ISA) 0x0000009E (158)	Microsoft ACPI-Compliant System
 (ISA) 0x0000009F (159)	Microsoft ACPI-Compliant System
 (ISA) 0x000000A0 (160)	Microsoft ACPI-Compliant System
 (ISA) 0x000000A1 (161)	Microsoft ACPI-Compliant System
 (ISA) 0x000000A2 (162)	Microsoft ACPI-Compliant System
 (ISA) 0x000000A3 (163)	Microsoft ACPI-Compliant System
 (ISA) 0x000000A4 (164)	Microsoft ACPI-Compliant System
 (ISA) 0x000000A5 (165)	Microsoft ACPI-Compliant System
 (ISA) 0x000000A6 (166)	Microsoft ACPI-Compliant System
 (ISA) 0x000000A7 (167)	Microsoft ACPI-Compliant System
 (ISA) 0x000000A8 (168)	Microsoft ACPI-Compliant System
 (ISA) 0x000000A9 (169)	Microsoft ACPI-Compliant System
 (ISA) 0x000000AA (170)	Microsoft ACPI-Compliant System
 (ISA) 0x000000AB (171)	Microsoft ACPI-Compliant System
 (ISA) 0x000000AC (172)	Microsoft ACPI-Compliant System
 (ISA) 0x000000AD (173)	Microsoft ACPI-Compliant System
 (ISA) 0x000000AE (174)	Microsoft ACPI-Compliant System
 (ISA) 0x000000AF (175)	Microsoft ACPI-Compliant System
 (ISA) 0x000000B0 (176)	Microsoft ACPI-Compliant System
 (ISA) 0x000000B1 (177)	Microsoft ACPI-Compliant System
 (ISA) 0x000000B2 (178)	Microsoft ACPI-Compliant System
 (ISA) 0x000000B3 (179)	Microsoft ACPI-Compliant System
 (ISA) 0x000000B4 (180)	Microsoft ACPI-Compliant System

































 (ISA) 0x000000B5 (181)	Microsoft ACPI-Compliant System
 (ISA) 0x000000B6 (182)	Microsoft ACPI-Compliant System
 (ISA) 0x000000B7 (183)	Microsoft ACPI-Compliant System
 (ISA) 0x000000B8 (184)	Microsoft ACPI-Compliant System
 (ISA) 0x000000B9 (185)	Microsoft ACPI-Compliant System
 (ISA) 0x000000BA (186)	Microsoft ACPI-Compliant System
 (ISA) 0x000000BB (187)	Microsoft ACPI-Compliant System
 (ISA) 0x000000BC (188)	Microsoft ACPI-Compliant System
 (ISA) 0x000000BD (189)	Microsoft ACPI-Compliant System
 (ISA) 0x000000BE (190)	Microsoft ACPI-Compliant System
 (ISA) 0x000000BF (191)	Microsoft ACPI-Compliant System
 (ISA) 0x000000C0 (192)	Microsoft ACPI-Compliant System
 (ISA) 0x000000C1 (193)	Microsoft ACPI-Compliant System
 (ISA) 0x000000C2 (194)	Microsoft ACPI-Compliant System
 (ISA) 0x000000C3 (195)	Microsoft ACPI-Compliant System
 (ISA) 0x000000C4 (196)	Microsoft ACPI-Compliant System
 (ISA) 0x000000C5 (197)	Microsoft ACPI-Compliant System
 (ISA) 0x000000C6 (198)	Microsoft ACPI-Compliant System
 (ISA) 0x000000C7 (199)	Microsoft ACPI-Compliant System
 (ISA) 0x000000C8 (200)	Microsoft ACPI-Compliant System
 (ISA) 0x000000C9 (201)	Microsoft ACPI-Compliant System
 (ISA) 0x000000CA (202)	Microsoft ACPI-Compliant System
 (ISA) 0x000000CB (203)	Microsoft ACPI-Compliant System
 (ISA) 0x000000CC (204)	Microsoft ACPI-Compliant System
 (ISA) 0x00000100 (256)	Microsoft ACPI-Compliant System
 (ISA) 0x00000101 (257)	Microsoft ACPI-Compliant System
 (ISA) 0x00000102 (258)	Microsoft ACPI-Compliant System
 (ISA) 0x00000103 (259)	Microsoft ACPI-Compliant System
 (ISA) 0x00000104 (260)	Microsoft ACPI-Compliant System
 (ISA) 0x00000105 (261)	Microsoft ACPI-Compliant System
 (ISA) 0x00000106 (262)	Microsoft ACPI-Compliant System
 (ISA) 0x00000107 (263)	Microsoft ACPI-Compliant System
 (ISA) 0x00000108 (264)	Microsoft ACPI-Compliant System

































 (ISA) 0x00000109 (265)	Microsoft ACPI-Compliant System
 (ISA) 0x0000010A (266)	Microsoft ACPI-Compliant System
 (ISA) 0x0000010B (267)	Microsoft ACPI-Compliant System
 (ISA) 0x0000010C (268)	Microsoft ACPI-Compliant System
 (ISA) 0x0000010D (269)	Microsoft ACPI-Compliant System
 (ISA) 0x0000010E (270)	Microsoft ACPI-Compliant System
 (ISA) 0x0000010F (271)	Microsoft ACPI-Compliant System
 (ISA) 0x00000110 (272)	Microsoft ACPI-Compliant System
 (ISA) 0x00000111 (273)	Microsoft ACPI-Compliant System
 (ISA) 0x00000112 (274)	Microsoft ACPI-Compliant System
 (ISA) 0x00000113 (275)	Microsoft ACPI-Compliant System
 (ISA) 0x00000114 (276)	Microsoft ACPI-Compliant System
 (ISA) 0x00000115 (277)	Microsoft ACPI-Compliant System
 (ISA) 0x00000116 (278)	Microsoft ACPI-Compliant System
 (ISA) 0x00000117 (279)	Microsoft ACPI-Compliant System
 (ISA) 0x00000118 (280)	Microsoft ACPI-Compliant System
 (ISA) 0x00000119 (281)	Microsoft ACPI-Compliant System
 (ISA) 0x0000011A (282)	Microsoft ACPI-Compliant System
 (ISA) 0x0000011B (283)	Microsoft ACPI-Compliant System
 (ISA) 0x0000011C (284)	Microsoft ACPI-Compliant System
 (ISA) 0x0000011D (285)	Microsoft ACPI-Compliant System
 (ISA) 0x0000011E (286)	Microsoft ACPI-Compliant System
 (ISA) 0x0000011F (287)	Microsoft ACPI-Compliant System
 (ISA) 0x00000120 (288)	Microsoft ACPI-Compliant System
 (ISA) 0x00000121 (289)	Microsoft ACPI-Compliant System
 (ISA) 0x00000122 (290)	Microsoft ACPI-Compliant System
 (ISA) 0x00000123 (291)	Microsoft ACPI-Compliant System
 (ISA) 0x00000124 (292)	Microsoft ACPI-Compliant System
 (ISA) 0x00000125 (293)	Microsoft ACPI-Compliant System
 (ISA) 0x00000126 (294)	Microsoft ACPI-Compliant System
 (ISA) 0x00000127 (295)	Microsoft ACPI-Compliant System
 (ISA) 0x00000128 (296)	Microsoft ACPI-Compliant System
 (ISA) 0x00000129 (297)	Microsoft ACPI-Compliant System

































 (ISA) 0x0000012A (298)	Microsoft ACPI-Compliant System
 (ISA) 0x0000012B (299)	Microsoft ACPI-Compliant System
 (ISA) 0x0000012C (300)	Microsoft ACPI-Compliant System
 (ISA) 0x0000012D (301)	Microsoft ACPI-Compliant System
 (ISA) 0x0000012E (302)	Microsoft ACPI-Compliant System
 (ISA) 0x0000012F (303)	Microsoft ACPI-Compliant System
 (ISA) 0x00000130 (304)	Microsoft ACPI-Compliant System
 (ISA) 0x00000131 (305)	Microsoft ACPI-Compliant System
 (ISA) 0x00000132 (306)	Microsoft ACPI-Compliant System
 (ISA) 0x00000133 (307)	Microsoft ACPI-Compliant System
 (ISA) 0x00000134 (308)	Microsoft ACPI-Compliant System
 (ISA) 0x00000135 (309)	Microsoft ACPI-Compliant System
 (ISA) 0x00000136 (310)	Microsoft ACPI-Compliant System
 (ISA) 0x00000137 (311)	Microsoft ACPI-Compliant System
 (ISA) 0x00000138 (312)	Microsoft ACPI-Compliant System
 (ISA) 0x00000139 (313)	Microsoft ACPI-Compliant System
 (ISA) 0x0000013A (314)	Microsoft ACPI-Compliant System
 (ISA) 0x0000013B (315)	Microsoft ACPI-Compliant System
 (ISA) 0x0000013C (316)	Microsoft ACPI-Compliant System
 (ISA) 0x0000013D (317)	Microsoft ACPI-Compliant System
 (ISA) 0x0000013E (318)	Microsoft ACPI-Compliant System
 (ISA) 0x0000013F (319)	Microsoft ACPI-Compliant System
 (ISA) 0x00000140 (320)	Microsoft ACPI-Compliant System
 (ISA) 0x00000141 (321)	Microsoft ACPI-Compliant System
 (ISA) 0x00000142 (322)	Microsoft ACPI-Compliant System
 (ISA) 0x00000143 (323)	Microsoft ACPI-Compliant System
 (ISA) 0x00000144 (324)	Microsoft ACPI-Compliant System
 (ISA) 0x00000145 (325)	Microsoft ACPI-Compliant System
 (ISA) 0x00000146 (326)	Microsoft ACPI-Compliant System
 (ISA) 0x00000147 (327)	Microsoft ACPI-Compliant System
 (ISA) 0x00000148 (328)	Microsoft ACPI-Compliant System
 (ISA) 0x00000149 (329)	Microsoft ACPI-Compliant System
 (ISA) 0x0000014A (330)	Microsoft ACPI-Compliant System

































 (ISA) 0x0000014B (331)	Microsoft ACPI-Compliant System
 (ISA) 0x0000014C (332)	Microsoft ACPI-Compliant System
 (ISA) 0x0000014D (333)	Microsoft ACPI-Compliant System
 (ISA) 0x0000014E (334)	Microsoft ACPI-Compliant System
 (ISA) 0x0000014F (335)	Microsoft ACPI-Compliant System
 (ISA) 0x00000150 (336)	Microsoft ACPI-Compliant System
 (ISA) 0x00000151 (337)	Microsoft ACPI-Compliant System
 (ISA) 0x00000152 (338)	Microsoft ACPI-Compliant System
 (ISA) 0x00000153 (339)	Microsoft ACPI-Compliant System
 (ISA) 0x00000154 (340)	Microsoft ACPI-Compliant System
 (ISA) 0x00000155 (341)	Microsoft ACPI-Compliant System
 (ISA) 0x00000156 (342)	Microsoft ACPI-Compliant System
 (ISA) 0x00000157 (343)	Microsoft ACPI-Compliant System
 (ISA) 0x00000158 (344)	Microsoft ACPI-Compliant System
 (ISA) 0x00000159 (345)	Microsoft ACPI-Compliant System
 (ISA) 0x0000015A (346)	Microsoft ACPI-Compliant System
 (ISA) 0x0000015B (347)	Microsoft ACPI-Compliant System
 (ISA) 0x0000015C (348)	Microsoft ACPI-Compliant System
 (ISA) 0x0000015D (349)	Microsoft ACPI-Compliant System
 (ISA) 0x0000015E (350)	Microsoft ACPI-Compliant System
 (ISA) 0x0000015F (351)	Microsoft ACPI-Compliant System
 (ISA) 0x00000160 (352)	Microsoft ACPI-Compliant System
 (ISA) 0x00000161 (353)	Microsoft ACPI-Compliant System
 (ISA) 0x00000162 (354)	Microsoft ACPI-Compliant System
 (ISA) 0x00000163 (355)	Microsoft ACPI-Compliant System
 (ISA) 0x00000164 (356)	Microsoft ACPI-Compliant System
 (ISA) 0x00000165 (357)	Microsoft ACPI-Compliant System
 (ISA) 0x00000166 (358)	Microsoft ACPI-Compliant System
 (ISA) 0x00000167 (359)	Microsoft ACPI-Compliant System
 (ISA) 0x00000168 (360)	Microsoft ACPI-Compliant System
 (ISA) 0x00000169 (361)	Microsoft ACPI-Compliant System
 (ISA) 0x0000016A (362)	Microsoft ACPI-Compliant System
 (ISA) 0x0000016B (363)	Microsoft ACPI-Compliant System



















 (ISA) 0x0000016C (364)	Microsoft ACPI-Compliant System
 (ISA) 0x0000016D (365)	Microsoft ACPI-Compliant System
 (ISA) 0x0000016E (366)	Microsoft ACPI-Compliant System
 (ISA) 0x0000016F (367)	Microsoft ACPI-Compliant System
 (ISA) 0x00000170 (368)	Microsoft ACPI-Compliant System
 (ISA) 0x00000171 (369)	Microsoft ACPI-Compliant System
 (ISA) 0x00000172 (370)	Microsoft ACPI-Compliant System
 (ISA) 0x00000173 (371)	Microsoft ACPI-Compliant System
 (ISA) 0x00000174 (372)	Microsoft ACPI-Compliant System
 (ISA) 0x00000175 (373)	Microsoft ACPI-Compliant System
 (ISA) 0x00000176 (374)	Microsoft ACPI-Compliant System
 (ISA) 0x00000177 (375)	Microsoft ACPI-Compliant System
 (ISA) 0x00000178 (376)	Microsoft ACPI-Compliant System
 (ISA) 0x00000179 (377)	Microsoft ACPI-Compliant System
 (ISA) 0x0000017A (378)	Microsoft ACPI-Compliant System
 (ISA) 0x0000017B (379)	Microsoft ACPI-Compliant System
 (ISA) 0x0000017C (380)	Microsoft ACPI-Compliant System
 (ISA) 0x0000017D (381)	Microsoft ACPI-Compliant System
 (ISA) 0x0000017E (382)	Microsoft ACPI-Compliant System
 (ISA) 0x0000017F (383)	Microsoft ACPI-Compliant System
 (ISA) 0x00000180 (384)	Microsoft ACPI-Compliant System
 (ISA) 0x00000181 (385)	Microsoft ACPI-Compliant System
 (ISA) 0x00000182 (386)	Microsoft ACPI-Compliant System
 (ISA) 0x00000183 (387)	Microsoft ACPI-Compliant System
 (ISA) 0x00000184 (388)	Microsoft ACPI-Compliant System
 (ISA) 0x00000185 (389)	Microsoft ACPI-Compliant System
 (ISA) 0x00000186 (390)	Microsoft ACPI-Compliant System
 (ISA) 0x00000187 (391)	Microsoft ACPI-Compliant System
 (ISA) 0x00000188 (392)	Microsoft ACPI-Compliant System
 (ISA) 0x00000189 (393)	Microsoft ACPI-Compliant System
 (ISA) 0x0000018A (394)	Microsoft ACPI-Compliant System
 (ISA) 0x0000018B (395)	Microsoft ACPI-Compliant System
 (ISA) 0x0000018C (396)	Microsoft ACPI-Compliant System

 (ISA) 0x0000018D (397)	Microsoft ACPI-Compliant System
 (ISA) 0x0000018E (398)	Microsoft ACPI-Compliant System
 (ISA) 0x0000018F (399)	Microsoft ACPI-Compliant System
 (ISA) 0x00000190 (400)	Microsoft ACPI-Compliant System
 (ISA) 0x00000191 (401)	Microsoft ACPI-Compliant System
 (ISA) 0x00000192 (402)	Microsoft ACPI-Compliant System
 (ISA) 0x00000193 (403)	Microsoft ACPI-Compliant System
 (ISA) 0x00000194 (404)	Microsoft ACPI-Compliant System
 (ISA) 0x00000195 (405)	Microsoft ACPI-Compliant System
 (ISA) 0x00000196 (406)	Microsoft ACPI-Compliant System
 (ISA) 0x00000197 (407)	Microsoft ACPI-Compliant System
 (ISA) 0x00000198 (408)	Microsoft ACPI-Compliant System
 (ISA) 0x00000199 (409)	Microsoft ACPI-Compliant System
 (ISA) 0x0000019A (410)	Microsoft ACPI-Compliant System
 (ISA) 0x0000019B (411)	Microsoft ACPI-Compliant System
 (ISA) 0x0000019C (412)	Microsoft ACPI-Compliant System
 (ISA) 0x0000019D (413)	Microsoft ACPI-Compliant System
 (ISA) 0x0000019E (414)	Microsoft ACPI-Compliant System
 (ISA) 0x0000019F (415)	Microsoft ACPI-Compliant System
 (ISA) 0x000001A0 (416)	Microsoft ACPI-Compliant System
 (ISA) 0x000001A1 (417)	Microsoft ACPI-Compliant System
 (ISA) 0x000001A2 (418)	Microsoft ACPI-Compliant System
 (ISA) 0x000001A3 (419)	Microsoft ACPI-Compliant System
 (ISA) 0x000001A4 (420)	Microsoft ACPI-Compliant System
 (ISA) 0x000001A5 (421)	Microsoft ACPI-Compliant System
 (ISA) 0x000001A6 (422)	Microsoft ACPI-Compliant System
 (ISA) 0x000001A7 (423)	Microsoft ACPI-Compliant System
 (ISA) 0x000001A8 (424)	Microsoft ACPI-Compliant System
 (ISA) 0x000001A9 (425)	Microsoft ACPI-Compliant System
 (ISA) 0x000001AA (426)	Microsoft ACPI-Compliant System
 (ISA) 0x000001AB (427)	Microsoft ACPI-Compliant System
 (ISA) 0x000001AC (428)	Microsoft ACPI-Compliant System
 (ISA) 0x000001AD (429)	Microsoft ACPI-Compliant System

 (ISA) 0x000001AE (430)	Microsoft ACPI-Compliant System
 (ISA) 0x000001AF (431)	Microsoft ACPI-Compliant System
 (ISA) 0x000001B0 (432)	Microsoft ACPI-Compliant System
 (ISA) 0x000001B1 (433)	Microsoft ACPI-Compliant System
 (ISA) 0x000001B2 (434)	Microsoft ACPI-Compliant System
 (ISA) 0x000001B3 (435)	Microsoft ACPI-Compliant System
 (ISA) 0x000001B4 (436)	Microsoft ACPI-Compliant System
 (ISA) 0x000001B5 (437)	Microsoft ACPI-Compliant System
 (ISA) 0x000001B6 (438)	Microsoft ACPI-Compliant System
 (ISA) 0x000001B7 (439)	Microsoft ACPI-Compliant System
 (ISA) 0x000001B8 (440)	Microsoft ACPI-Compliant System
 (ISA) 0x000001B9 (441)	Microsoft ACPI-Compliant System
 (ISA) 0x000001BA (442)	Microsoft ACPI-Compliant System
 (ISA) 0x000001BB (443)	Microsoft ACPI-Compliant System
 (ISA) 0x000001BC (444)	Microsoft ACPI-Compliant System
 (ISA) 0x000001BD (445)	Microsoft ACPI-Compliant System
 (ISA) 0x000001BE (446)	Microsoft ACPI-Compliant System
 (ISA) 0x000001BF (447)	Microsoft ACPI-Compliant System
 (ISA) 0x000001C0 (448)	Microsoft ACPI-Compliant System
 (ISA) 0x000001C1 (449)	Microsoft ACPI-Compliant System
 (ISA) 0x000001C2 (450)	Microsoft ACPI-Compliant System
 (ISA) 0x000001C3 (451)	Microsoft ACPI-Compliant System
 (ISA) 0x000001C4 (452)	Microsoft ACPI-Compliant System
 (ISA) 0x000001C5 (453)	Microsoft ACPI-Compliant System
 (ISA) 0x000001C6 (454)	Microsoft ACPI-Compliant System
 (ISA) 0x000001C7 (455)	Microsoft ACPI-Compliant System
 (ISA) 0x000001C8 (456)	Microsoft ACPI-Compliant System
 (ISA) 0x000001C9 (457)	Microsoft ACPI-Compliant System
 (ISA) 0x000001CA (458)	Microsoft ACPI-Compliant System
 (ISA) 0x000001CB (459)	Microsoft ACPI-Compliant System
 (ISA) 0x000001CC (460)	Microsoft ACPI-Compliant System
 (ISA) 0x000001CD (461)	Microsoft ACPI-Compliant System
 (ISA) 0x000001CE (462)	Microsoft ACPI-Compliant System

 (ISA) 0x000001CF (463)	Microsoft ACPI-Compliant System
 (ISA) 0x000001D0 (464)	Microsoft ACPI-Compliant System
 (ISA) 0x000001D1 (465)	Microsoft ACPI-Compliant System
 (ISA) 0x000001D2 (466)	Microsoft ACPI-Compliant System
 (ISA) 0x000001D3 (467)	Microsoft ACPI-Compliant System
 (ISA) 0x000001D4 (468)	Microsoft ACPI-Compliant System
 (ISA) 0x000001D5 (469)	Microsoft ACPI-Compliant System
 (ISA) 0x000001D6 (470)	Microsoft ACPI-Compliant System
 (ISA) 0x000001D7 (471)	Microsoft ACPI-Compliant System
 (ISA) 0x000001D8 (472)	Microsoft ACPI-Compliant System
 (ISA) 0x000001D9 (473)	Microsoft ACPI-Compliant System
 (ISA) 0x000001DA (474)	Microsoft ACPI-Compliant System
 (ISA) 0x000001DB (475)	Microsoft ACPI-Compliant System
 (ISA) 0x000001DC (476)	Microsoft ACPI-Compliant System
 (ISA) 0x000001DD (477)	Microsoft ACPI-Compliant System
 (ISA) 0x000001DE (478)	Microsoft ACPI-Compliant System
 (ISA) 0x000001DF (479)	Microsoft ACPI-Compliant System
 (ISA) 0x000001E0 (480)	Microsoft ACPI-Compliant System
 (ISA) 0x000001E1 (481)	Microsoft ACPI-Compliant System
 (ISA) 0x000001E2 (482)	Microsoft ACPI-Compliant System
 (ISA) 0x000001E3 (483)	Microsoft ACPI-Compliant System
 (ISA) 0x000001E4 (484)	Microsoft ACPI-Compliant System
 (ISA) 0x000001E5 (485)	Microsoft ACPI-Compliant System
 (ISA) 0x000001E6 (486)	Microsoft ACPI-Compliant System
 (ISA) 0x000001E7 (487)	Microsoft ACPI-Compliant System
 (ISA) 0x000001E8 (488)	Microsoft ACPI-Compliant System
 (ISA) 0x000001E9 (489)	Microsoft ACPI-Compliant System
 (ISA) 0x000001EA (490)	Microsoft ACPI-Compliant System
 (ISA) 0x000001EB (491)	Microsoft ACPI-Compliant System
 (ISA) 0x000001EC (492)	Microsoft ACPI-Compliant System
 (ISA) 0x000001ED (493)	Microsoft ACPI-Compliant System
 (ISA) 0x000001EE (494)	Microsoft ACPI-Compliant System
 (ISA) 0x000001EF (495)	Microsoft ACPI-Compliant System

 (ISA) 0x000001F0 (496)	Microsoft ACPI-Compliant System
 (ISA) 0x000001F1 (497)	Microsoft ACPI-Compliant System
 (ISA) 0x000001F2 (498)	Microsoft ACPI-Compliant System
 (ISA) 0x000001F3 (499)	Microsoft ACPI-Compliant System
 (ISA) 0x000001F4 (500)	Microsoft ACPI-Compliant System
 (ISA) 0x000001F5 (501)	Microsoft ACPI-Compliant System
 (ISA) 0x000001F6 (502)	Microsoft ACPI-Compliant System
 (ISA) 0x000001F7 (503)	Microsoft ACPI-Compliant System
 (ISA) 0x000001F8 (504)	Microsoft ACPI-Compliant System
 (ISA) 0x000001F9 (505)	Microsoft ACPI-Compliant System
 (ISA) 0x000001FA (506)	Microsoft ACPI-Compliant System
 (ISA) 0x000001FB (507)	Microsoft ACPI-Compliant System
 (ISA) 0x000001FC (508)	Microsoft ACPI-Compliant System
 (ISA) 0x000001FD (509)	Microsoft ACPI-Compliant System
 (ISA) 0x000001FE (510)	Microsoft ACPI-Compliant System
 (ISA) 0x000001FF (511)	Microsoft ACPI-Compliant System
 (PCI) 0x00000010 (16)	Intel(R) Serial IO UART Host Controller - 54A8
 (PCI) 0x0000001B (27)	Intel(R) Serial IO I2C Host Controller - 54E8
 (PCI) 0x0000001F (31)	Intel(R) Serial IO I2C Host Controller - 54C5
 (PCI) 0xFFFFFDFD (-33)	Intel(R) Management Engine Interface #1
 (PCI) 0xFFFFFE0 (-32)	Intel® Smart Sound Technology BUS
 (PCI) 0xFFFFFE1 (-31)	Intel(R) Ethernet Controller I226-V
 (PCI) 0xFFFFFE2 (-30)	Intel(R) Ethernet Controller I226-V
 (PCI) 0xFFFFFE3 (-29)	Intel(R) Ethernet Controller I226-V
 (PCI) 0xFFFFFE4 (-28)	Intel(R) Ethernet Controller I226-V
 (PCI) 0xFFFFFE5 (-27)	Intel(R) Ethernet Controller I226-V
 (PCI) 0xFFFFFE6 (-26)	Intel(R) Ethernet Controller I226-V
 (PCI) 0xFFFFFE7 (-25)	Intel(R) Ethernet Controller I226-V
 (PCI) 0xFFFFFE8 (-24)	Intel(R) Ethernet Controller I226-V
 (PCI) 0xFFFFFE9 (-23)	Intel(R) Ethernet Controller I226-V
 (PCI) 0xFFFFFEA (-22)	Intel(R) Ethernet Controller I226-V #2
 (PCI) 0xFFFFFEB (-21)	Intel(R) Ethernet Controller I226-V #2
 (PCI) 0xFFFFFEC (-20)	Intel(R) Ethernet Controller I226-V #2

	(PCI) 0xFFFFFEEC (-20)	Intel(R) Ethernet Controller I226-V #2
	(PCI) 0xFFFFFEED (-19)	Intel(R) Ethernet Controller I226-V #2
	(PCI) 0xFFFFFEE E (-18)	Intel(R) Ethernet Controller I226-V #2
	(PCI) 0xFFFFFE EF (-17)	Intel(R) Ethernet Controller I226-V #2
	(PCI) 0xFFFFFFF0 (-16)	Intel(R) Ethernet Controller I226-V #2
	(PCI) 0xFFFFFFF1 (-15)	Intel(R) Ethernet Controller I226-V #2
	(PCI) 0xFFFFFFF2 (-14)	Intel(R) Ethernet Controller I226-V #2
	(PCI) 0xFFFFFFF3 (-13)	Intel(R) USB 3.10 eXtensible Host Controller - 1.20 (Microsoft)
	(PCI) 0xFFFFFFF4 (-12)	Intel(R) UHD Graphics
	(PCI) 0xFFFFFFF5 (-11)	Standard NVM Express Controller
	(PCI) 0xFFFFFFF6 (-10)	Standard NVM Express Controller
	(PCI) 0xFFFFFFF7 (-9)	Standard NVM Express Controller
	(PCI) 0xFFFFFFF8 (-8)	Standard NVM Express Controller
	(PCI) 0xFFFFFFF9 (-7)	Standard NVM Express Controller
	(PCI) 0xFFFFFFFA (-6)	Standard NVM Express Controller
	(PCI) 0xFFFFFFF B (-5)	Standard NVM Express Controller
	(PCI) 0xFFFFFFF C (-4)	Standard NVM Express Controller
	(PCI) 0xFFFFFFF D (-3)	Standard NVM Express Controller
	(PCI) 0xFFFFFFF E (-2)	Standard SATA AHCI Controller

Appendix B

Mating Connectors and Cables

B.1 Mating Connectors and Cables

Label	Function	Mating Connector		Available Cable	Cable P/N
		Vendor	Model no		
CN1	USB 2.0 Connector (5Pin*1 Board to Wire)	Molex	51021-0500	USB 2.0 Cable	1700050207
CN2	FAN	Molex	51021-0400		
CN4	SATA Power Connector	Molex	51021-0200		
CN5	Debug Card Connector	JST	SHR-10V-S-B	eSPI Debug Cable	1703100133
CN6	BIOS	Molex	501330-0700		
CN7	Front Panel	JST	SHR-10V-S-B	Front Panel Cable	170X000603
CN8	I2C/SMBus Header	JST	SHR-05V-S-B	I2C/SMBus Cable	170X000743
CN9	SATA Conn	Molex	88750-5318		
CN10	Audio Pin Header	Aces	50247-012H0H0-001	AUDIO Cable	170X000517
CN11	USB 2.0 Connector (5Pin*1 Board to Wire)	Molex	51021-0500	USB 2.0 Cable	1700050207
CN15	GPIO	Molex	51110-1050		
CN16	COM	Molex	51021-0900	COM Cable	1701090150
CN17	COM	Molex	51021-0900	COM Cable	1701090150
CN18	COM	Molex	51021-0900	COM Cable	1701090150
CN19	COM	Molex	51021-0900	COM Cable	1701090150
CN21	LVDS1	Hirose	DF13-30DS-1.25C	NA	NA
CN22	LVDS BKLT	JST	SHR-04V-S-B	LVDS Backlight Cable	170X000870
CN23	CMOS Battery	Molex	51021-0200	CMOS Cable	175011301K
CN24	USB 2.0 Connector (5Pin*1 Board to Wire)	Molex	51021-0500	USB 2.0 Cable	1700050207
CN25	USB 2.0 Connector (5Pin*1 Board to Wire)	Molex	51021-0500	USB 2.0 Cable	1700050207
CN31	LVDS_BKLT2	JST	SHR-04V-S-B	LVDS Backlight Cable	170X000870
CN32	LVDS2	Hirose	DF13-30DS-1.25C	NA	NA
CN25	USB 2.0 Connector (5Pin*1 Board to Wire)	PINREX	712-91-055W60.NY9T	USB 2.0 Cable	1700050207
CN26	HDMI	ASTRON	3690019-016-R		
CN27	DP	Ling yang	DPS21BAA-C001-GB		

Label	Function	Mating Connector		Available Cable	Cable P/N
		Vendor	Model no		
CN28	Dual RJ-45	SPEEDTECH	RNDAAN-FWH3-N3H-0R		
CN29	USB 3.2 Gen 2 *2 Dual Port	LOTES	AUSB0516-K013C		