

GENE-RAP6

3.5" Subcompact Board

User's Manual 1st Ed

Copyright Notice

This document is copyrighted, 2023. All rights are reserved. The original manufacturer reserves the right to make improvements to the products described in this manual at any time without notice.

No part of this manual may be reproduced, copied, translated, or transmitted in any form or by any means without the prior written permission of the original manufacturer. Information provided in this manual is intended to be accurate and reliable. However, the original manufacturer assumes no responsibility for its use, or for any infringements upon the rights of third parties that may result from its use.

The material in this document is for product information only and is subject to change without notice. While reasonable efforts have been made in the preparation of this document to assure its accuracy, AAEMON assumes no liabilities resulting from errors or omissions in this document, or from the use of the information contained herein.

AAEMON reserves the right to make changes in the product design without notice to its users.

Acknowledgements

All other products' name or trademarks are properties of their respective owners.

- Microsoft Windows® is a registered trademark of Microsoft Corp.
- Intel® and Iris® Xe are registered trademarks of Intel Corporation
- Core™ is a trademark of Intel Corporation
- Realtek is a trademark of Realtek Semiconductor Corporation.
- Ubuntu and Canonical are registered trademarks of Canonical Ltd.
- Linux® is the registered trademark of Linus Torvalds in the U.S. and other countries

All other product names or trademarks are properties of their respective owners.

Packing List

Before setting up your product, please make sure the following items have been shipped:

Item	Quantity
GENE-RAP6 MB	1

If any of these items are missing or damaged, please contact your distributor or sales representative immediately.

About this Document

This User's Manual contains all the essential information, such as detailed descriptions and explanations on the product's hardware and software features (if any), its specifications, dimensions, jumper/connector settings/definitions, and driver installation instructions (if any), to facilitate users in setting up their product.

Users may refer to the product page at AAEON.com for the latest version of this document.

Safety Precautions

Please read the following safety instructions carefully. It is advised that you keep this manual for future references

1. All cautions and warnings on the device should be noted.
2. Make sure the power source matches the power rating of the device.
3. Position the power cord so that people cannot step on it. Do not place anything over the power cord.
4. Always completely disconnect the power before working on the system's hardware.
5. No connections should be made when the system is powered as a sudden rush of power may damage sensitive electronic components.
6. If the device is not to be used for a long time, disconnect it from the power supply to avoid damage by transient over-voltage.
7. Always disconnect this device from any AC supply before cleaning.
8. While cleaning, use a damp cloth instead of liquid or spray detergents.
9. Make sure the device is installed near a power outlet and is easily accessible.
10. Keep this device away from humidity.
11. Place the device on a solid surface during installation to prevent falls
12. Do not cover the openings on the device to ensure optimal heat dissipation.
13. Watch out for high temperatures when the system is running.
14. Do not touch the heat sink or heat spreader when the system is running
15. Never pour any liquid into the openings. This could cause fire or electric shock.
16. As most electronic components are sensitive to static electrical charge, be sure to ground yourself to prevent static charge when installing the internal components. Use a grounding wrist strap and contain all electronic components in any static-shielded containers.

17. If any of the following situations arises, please the contact our service personnel:
 - i. Damaged power cord or plug
 - ii. Liquid intrusion to the device
 - iii. Exposure to moisture
 - iv. Device is not working as expected or in a manner as described in this manual
 - v. The device is dropped or damaged
 - vi. Any obvious signs of damage displayed on the device
18. **DO NOT LEAVE THIS DEVICE IN AN UNCONTROLLED ENVIRONMENT WITH TEMPERATURES BEYOND THE DEVICE'S PERMITTED STORAGE TEMPERATURES (SEE CHAPTER 1) TO PREVENT DAMAGE.**

Warning!



This device complies with Part 15 FCC Rules. Operation is subject to the following two conditions: (1) this device may not cause harmful interference, and (2) this device must accept any interference received including interference that may cause undesired operation.

Caution:

There is a danger of explosion if the battery is incorrectly replaced. Replace only with the same or equivalent type recommended by the manufacturer. Dispose of used batteries according to the manufacturer's instructions and your local government's recycling or disposal directives.

Attention:

Il y a un risque d'explosion si la batterie est remplacée de façon incorrecte. Ne la remplacer qu'avec le même modèle ou équivalent recommandé par le constructeur. Recycler les batteries usées en accord avec les instructions du fabricant et les directives gouvernementales de recyclage.

China RoHS Requirements (CN)

产品中有毒有害物质或元素名称及含量

AAEON Main Board/ Daughter Board/ Backplane

部件名称	有毒有害物质或元素					
	铅 (Pb)	汞 (Hg)	镉 (Cd)	六价铬 (Cr(VI))	多溴联苯 (PBB)	多溴二苯醚 (PBDE)
印刷电路板 及其电子组件	X	X	○	○	○	○
外部信号 连接器及线材	X	X	○	○	○	○
<p>○: 表示该有毒有害物质在该部件所有均质材料中的含量均在 SJ/T 11363-2006 标准规定的限量要求以下。</p> <p>X: 表示该有毒有害物质至少在该部件的某一均质材料中的含量超出 SJ/T 11363-2006 标准规定的限量要求。</p> <p>备注: 此产品所标示之环保使用期限, 系指在一般正常使用状况下。</p>						

China RoHS Requirement (EN)

Poisonous or Hazardous Substances or Elements in Products

AAEON Main Board/ Daughter Board/ Backplane

Component	Poisonous or Hazardous Substances or Elements					
	Lead (Pb)	Mercury (Hg)	Cadmium (Cd)	Hexavalent Chromium (Cr(VI))	Polybrominated Biphenyls (PBB)	Polybrominated Diphenyl Ethers (PBDE)
PCB & Other Components	X	X	○	○	○	○
Wires & Connectors for External Connections	X	X	○	○	○	○
<p>O: The quantity of poisonous or hazardous substances or elements found in each of the component's parts is below the SJ/T 11363-2006-stipulated requirement.</p> <p>X: The quantity of poisonous or hazardous substances or elements found in at least one of the component's parts is beyond the SJ/T 11363-2006-stipulated requirement.</p> <p>Note: The Environment Friendly Use Period as labeled on this product is applicable under normal usage only</p>						

Table of Contents

Chapter 1 - Product Specifications	1
1.1 Specifications	2
1.2 Block Diagram	6
Chapter 2 – Hardware Information	7
2.1 Dimensions	8
2.2 Jumpers and Connectors.....	10
2.3 List of Jumpers	12
2.3.1 Auto Power Button Enable/Disable Selection (JP1).....	12
2.3.2 COM 1 Pin 9 Function Selection (JP2).....	13
2.3.3 COM 2 Pin 9 Function Selection (JP3)	13
2.3.4 LVDS Backlight Inverter Voltage Selection (JP4).....	13
2.3.5 LVDS Operating Voltage Selection (JP4)	14
2.3.6 Clear CMOS Jumper (JP5).....	14
2.3.7 LVDS Backlight Lightness Control Mode Selection (JP6)	14
2.4 List of Connectors.....	15
2.4.1 +5V Output for SATA HDD (CN1).....	16
2.4.2 SATA Port (CN2)	17
2.4.3 External +12V Input (Optional) (CN3).....	18
2.4.4 External Power Input (CN4)	18
2.4.5 Audio I/O Port (CN5)	19
2.4.6 M.2 3052/3042/2242 B-Key Connector (CN6).....	20
2.4.7 DDR5 SO-DIMM Channel 1 (CN7).....	20
2.4.8 Front Panel (CN9).....	21
2.4.9 DDR5 SO-DIMM Channel 2 (CN10)	21
2.4.10 COM Port 3/Port 4 (CN11).....	22
2.4.10.1 COM Port 3 RS-RS-422/RS-485	23

2.4.10.2	COM Port 4 RS-422/RS-485.....	24
2.4.11	COM Port 1/Port 2 (CN12).....	25
2.4.11.1	COM Port 1 RS-422/RS-485	26
2.4.11.2	COM Port 2 RS-422/RS-485.....	27
2.4.12	USB 2.0 Port 5/Port 6 (CN13)	28
2.4.13	GPIO Port (CN14).....	29
2.4.14	USB 2.0 Port 7/Port 8 (CN15).....	30
2.4.15	SPI Flash Programming Port (CN16)	31
2.4.16	LVDS Inverter/Backlight Connector (CN17)	32
2.4.17	M.2 2230 E-Key Connector (CN18)	33
2.4.18	M.2 2280 M-Key Connector (CN19).....	33
2.4.19	eDP Connector (CN20).....	34
2.4.20	LVDS Connector (CN21).....	36
2.4.21	Port 80 Debug Port (CN22)	38
2.4.22	Nano SIM Card Socket (CN23)	39
2.4.23	RTC Battery Connector (CN24).....	40
2.4.24	4-Pin FAN Connector (CN26).....	40
2.4.25	LAN (RJ-45) Port 1/Port 2 (CN27).....	41
2.4.26	LAN Port 1 LED Connector (CN28)	42
2.4.27	USB 3.2/USB 2.0 Port 3 (CN29).....	43
2.4.28	USB 3.2/USB 2.0 Port 1/Port 2 (CN30).....	44
2.4.29	DP Connector (CN31).....	45
2.4.30	HDMI Connector (CN33).....	46
2.4.31	USB Type C (CN34).....	47
2.4.32	FPC Connector (CN35)	48
2.4.33	LAN Port 2 LED Connector (CN36).....	51
2.5	Thermal Solutions.....	52
2.5.1	Active Cooling Fan - GENE-ADP6-FAN01.....	52

2.5.2	Heatspreader - GENE-ADP6-HSP01	54
Chapter 3 - AMI BIOS Setup		56
3.1	System Test and Initialization	57
3.2	AMI BIOS Setup	58
3.3	Setup Submenu: Main	59
3.4	Setup Submenu: Advanced.....	60
3.4.1	CPU Configuration.....	61
3.4.2	PCH-FW Configuration.....	62
3.4.3	Firmware Update Configuration	63
3.4.4	PTT Configuration.....	64
3.4.5	Trusted Computing.....	65
3.4.6	SATA Configuration.....	67
3.4.7	Hardware Monitor	68
3.4.7.1	Smart Fan Mode Configuration	69
3.4.8	SIO Configuration	70
3.4.8.1	Serial Port 1 Configuration	71
3.4.8.2	Serial Port 2 Configuration	72
3.4.8.3	Serial Port 3 Configuration	73
3.4.8.4	Serial Port 4 Configuration	74
3.4.9	Serial Port Console Redirection	75
3.4.10	Legacy Console Redirection Settings.....	76
3.4.11	AAEON BIOS Robot	77
3.4.12	Power Management.....	79
3.4.13	GPIO Port Configuration	80
3.4.14	AAEON Smart Boost.....	81
3.5	Setup Submenu: Chipset	82
3.5.1	System Agent (SA) Configuration.....	83
3.5.2	Memory Configuration.....	84

3.5.3	LVDS Panel Configuration	85
3.5.4	PCH-IO Configuration	87
3.6	Setup Submenu: Security	88
3.6.1	Secure Boot	89
3.6.2	Key Management	90
3.7	Setup Submenu: Boot	92
3.7.1	BBS Priorities	93
3.8	Setup Submenu: Save & Exit	94
3.9	Setup Submenu: Firmware Update	95
3.10	Setup Submenu: MEBx	96
3.10.1	Intel® AMT Configuration	97
3.10.2	Redirection features	98
3.10.3	User Consent	99
3.10.4	Power Control	100
Chapter 4	– Driver Installation	101
4.1	Driver Download/Installation	102
Appendix A	- I/O Information	104
A.1	I/O Address Map	105
A.2	Memory Address Map	107
A.3	IRQ Mapping Chart	108
Appendix B	– Mating Connectors and Cables	111
B.1	Mating Connectors and Cables	112

Chapter 1

Product Specifications

1.1 Specifications

System

Form Factor	3.5" SubCompact Board
CPU	Intel® 13th Generation Core™/ U-series Processors: Intel® Core™ i7-1370PE (6PC+8EC/20T, 1.90 GHz, 28W) Intel® Core™ i7-1370PRE (6PC+8EC/20T, 1.90 GHz, 28W) Intel® Core™ i5-1340PE (4PC+8EC/16T, 1.80 GHz, 28W) Intel® Core™ i5-1335UE (2PC+8EC/12T, 1.30 GHz, 15W) Intel® Core™ i3-1320PE (4PC+4EC/12T, 1.70 GHz, 28W) Intel® Processor U300E (1PC+4EC/6T, 1.10 GHz, 15W)
Chipset	Integrated with Intel® SoC
Memory Type	DDR5 4800, Dual Channel SODIMM x 2, Max. 64GB, Non-ECC
BIOS	UEFI
Wake on LAN	Yes
Watchdog Timer	255 Levels
Security	TPM 2.0 (Optional)
RTC Battery	Lithium Battery 3V/240mAH
Dimension	5.75" x 4" (146mm x 101.7mm)
Weight	0.94 lb. (0.43Kg)
OS Support	Windows® 10/11 (64-bit) Ubuntu 22.04.2/5.19.0-32-generic

Power

Power Requirement	+9V ~ 36V (Optional: +12V)
Power Supply Type	AT/ATX
Connector	2-pin Phoenix Connector
Power Consumption	Intel® Core™ i7-1370PE, DDR5 32GB x 2, 5.33A @+12V (Typical)
	Intel® Core™ i7-1370PE, DDR5 32GB x 2, 8.55A @+12V (Max)

Display

Controller	Intel® Iris® Xe Graphics Intel® UHD Graphics
LVDS/eDP	LVDS x 1, Dual Channel 18/24-bit, up to 1920 x 1080 eDP 1.4 x 1, up to 3840 x 2160 (Optional)
Display Interface	HDMI 2.1 x 1, up to 8K x 4K @60Hz or 4K x 2K @120Hz DP 1.4 x 1, up to 7680 x 4320 @60Hz 30bpp (supports DP++)
Multiple Display	Up to 4 Simultaneous Displays

Audio

Codec	Realtek ALC897
Audio Interface	Line-In/Line-Out/Mic
Speaker	—

External I/O

Ethernet	Intel® I219 1GbE, RJ-45 x 1
	Intel® I226 2.5GbE, RJ-45 x 1
USB	USB 3.2 Gen 2 x 3
	USB Type-C x 1 (USB 3.2 Gen 2, DP 1.4, PD 5V/3A)
Serial Port	—
Video	HDMI 2.1 x 1
	DP 1.4 x 1

Internal I/O

USB	USB 2.0 x 4
Serial Port	COM 1, COM 2 (RS-232/422/485, supports 5V/12V/RI)
	COM 3, COM 4 (RS-232/422/485)
Video	LVDS x 1
	eDP x 1
	Inverter x 1 (12V/2A)
SATA	SATA 6Gb/s x 1
	+5V SATA Power Connector x 1
Audio	Audio Header x 1 (Optional)
DIO/GPIO	GPIO 8-bit
SMBus/I2C	SMBus/I2C x 1 (Default: SMBus)
Touch	—
Fan	4-pin Smart Fan x 1
SIM	Nano SIM x 1
Front Panel	HDD LED, PWR LED, Power Button, Buzzer, Reset
Others	—

Expansion

Mini PCIe/mSATA	—
M.2	M.2 2280 M-Key x 1 (PCIe 4.0 [x4] x 1) M.2 3052/3042/2242 B-Key x 1 (PCIe 3.0 [x2]/SATA + USB 3.2), Default: SATA, selected by BIOS M.2 2230 E-Key x 1 (PCIe 3.0 [x1] + USB 2.0)
Others	FPC x 1 (PCIe 4.0 [x4] x 1), only supports Graphic or NVME

Environmental

Operating Temperature	32°F ~ 140°F (0°C ~ 60°C)
Storage Temperature	-40°F ~ 185°F (-40°C ~ 85°C)
Operating Humidity	0% ~ 90% relative humidity, non-condensing
MTBF (Hours)	338,172
EMC	CE/FCC Class A

1.2 Block Diagram

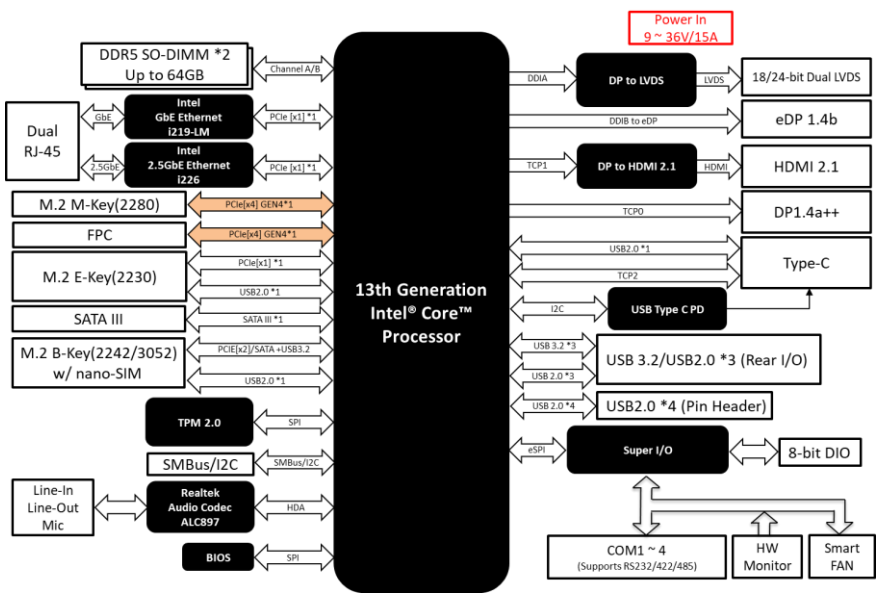

Chapter 2

Hardware Information

2.1 Dimensions

Component Side:

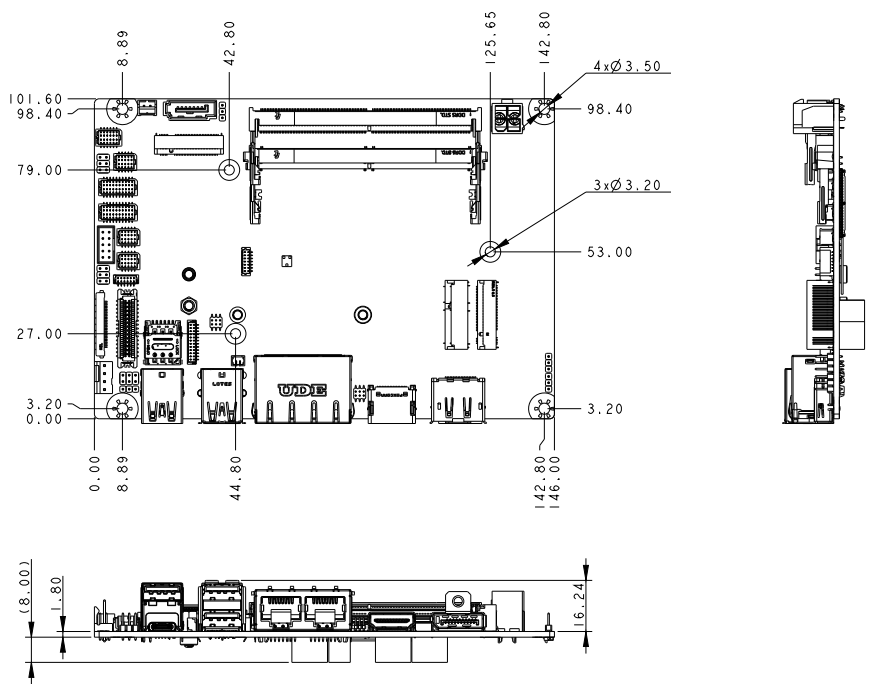

Solder Side:

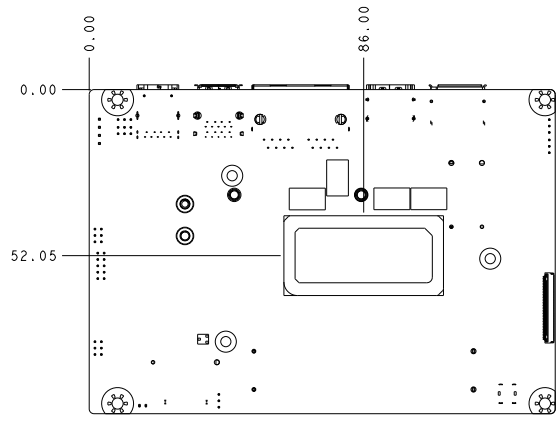

2.2 Jumpers and Connectors

Top View

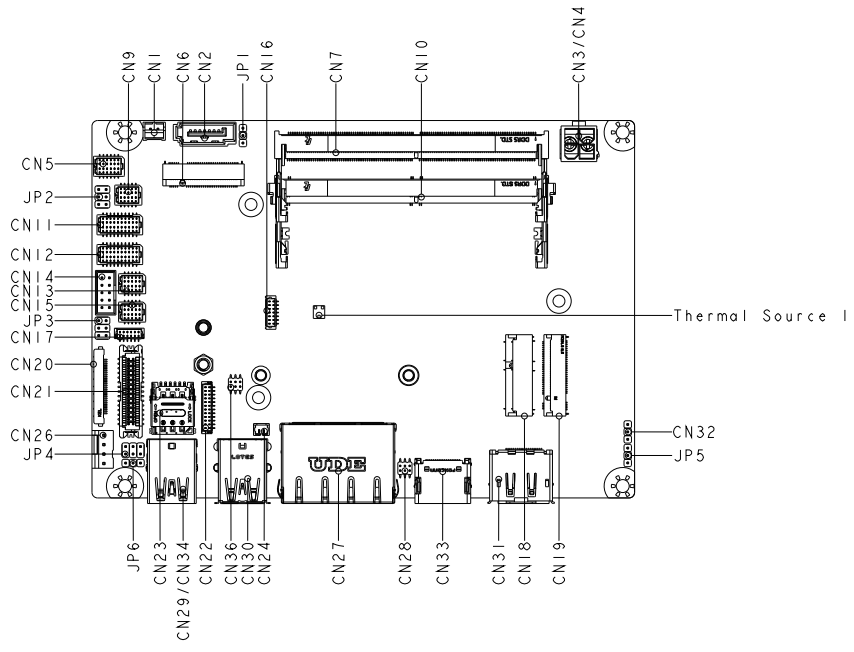

Front I/O View

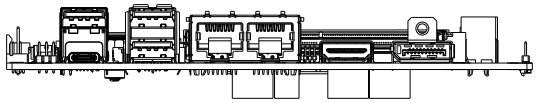

Bottom View

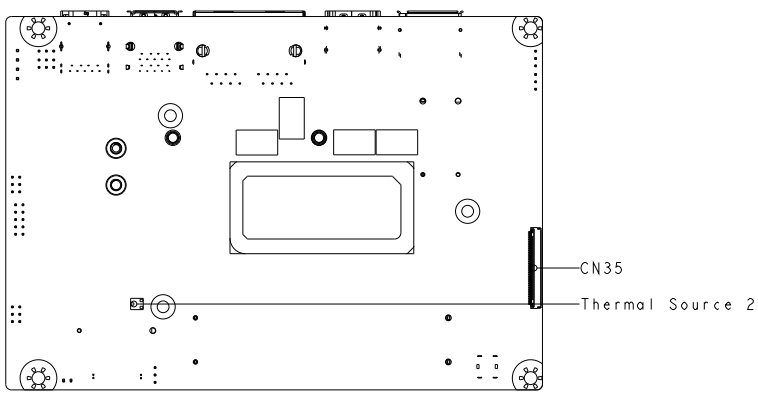

2.3 List of Jumpers

Please refer to the table below for all of the board's jumpers that you can configure for your application

Label	Function
JP1	Auto Power Button Enable/Disable Selection
JP2	COM 1 Pin 9 Function Selection
JP3	COM 2 Pin 9 Function Selection
JP4	LVDS Operating Voltage Selection LVDS Backlight Inverter Voltage Selection
JP5	Clear CMOS Jumper
JP6	LVDS Backlight Lightness Control Mode Selection

2.3.1 Auto Power Button Enable/Disable Selection (JP1)

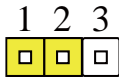

Disable Auto Power Button

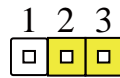

Enable Auto Power Button (**Default**)

2.3.2 COM 1 Pin 9 Function Selection (JP2)

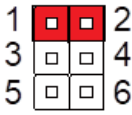

+12V

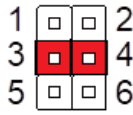

Ring (Default)

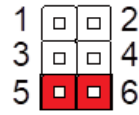

+5V

2.3.3 COM 2 Pin 9 Function Selection (JP3)

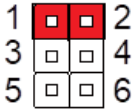

+12V

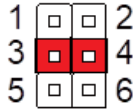

Ring (Default)

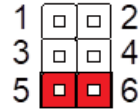

+5V

2.3.4 LVDS Backlight Inverter Voltage Selection (JP4)

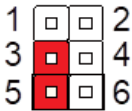

+5V (Default)

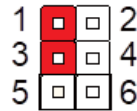

+12V

2.3.5 LVDS Operating Voltage Selection (JP4)

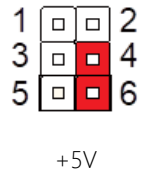
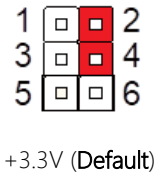

2.3.6 Clear CMOS Jumper (JP5)

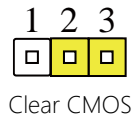
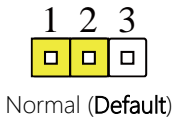

2.3.7 LVDS Backlight Lightness Control Mode Selection (JP6)

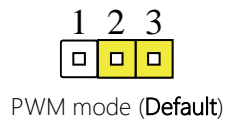
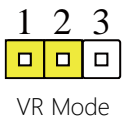

2.4 List of Connectors

Please refer to the table below for all of the board's connectors that you can configure for your application

Label	Function
CN1	+5V Output for SATA HDD
CN2	SATA Port
CN3	External +12V Input (Optional)
CN4	External Power Input
CN5	Audio I/O Port
CN6	M.2 3052/3042/2242 B-Key Connector
CN7	DDR5 SODIMM Channel 1
CN9	Front Panel
CN10	SODIMM Channel 2
CN11	COM Port 3/Port 4
CN12	COM Port 1/Port 2
CN13	USB 2.0 Port 5/Port 6
CN14	GPIO Port
CN15	USB 2.0 Port 7/Port 8
CN16	SPI Flash Programming Port
CN17	LVDS Inverter/Backlight Connector
CN18	M.2 2230 E-Key Connector
CN19	M.2 2280 M-Key Connector
CN20	eDP Connector
CN21	LVDS Connector
CN22	Port 80 Debug Port
CN23	Nano SIM Card Socket
CN24	RTC Battery Connector

Label	Function
CN25	3-pin Fan Connector (Optional)
CN26	4-pin Fan Connector
CN27	RJ-45 LAN Port 1/Port 2
CN28	LAN Port 1 LED Connector
CN29	USB 3.2/USB 2.0 Port 3
CN30	USB 3.2/USB 2.0 Port 1/Port 2
CN31	DP Connector
CN33	HDMI Connector
CN34	USB Type C
CN35	FPC Connector
CN36	LAN Port 2 LED Connector

2.4.1 +5V Output for SATA HDD (CN1)

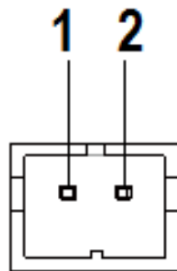

Pin	Pin Name	Signal Type	Signal Level
1	+V5S	PWR	+5V
2	GND	GND	-

Note: The driving current of +V5S supports up to 2A.

2.4.2 SATA Port (CN2)

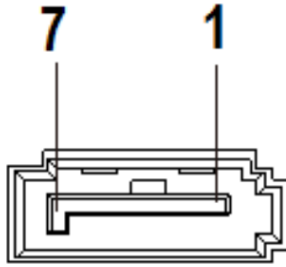

Pin	Pin Name	Signal Type	Signal Level
1	GND	GND	GND
2	SATA_TX+	DIFF	-
3	SATA_TX-	DIFF	-
4	GND	GND	GND
5	SATA_RX-	DIFF	-
6	SATA_RX+	DIFF	-
7	GND	GND	GND

2.4.3 External +12V Input (Optional) (CN3)

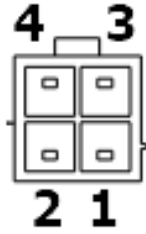

Pin	Pin Name	Signal Type	Signal Level
1	GND	GND	GND
2	GND	GND	GND
3	+12V	PWR	+12V
4	+12V	PWR	+12V

2.4.4 External Power Input (CN4)

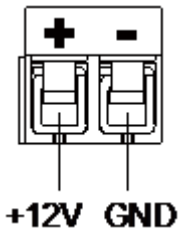

Pin	Pin Name	Signal Type	Signal Level
1	+12V	PWR	+12V
2	GND	GND	GND

2.4.5 Audio I/O Port (CN5)

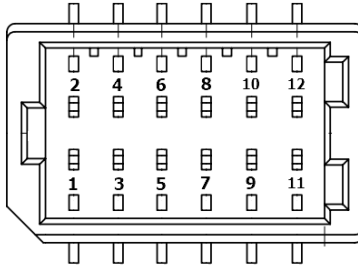

Pin	Pin Name	Signal Type	Signal Level
1	RIGHT_OUT	OUT	-
2	MIC_R	IN	-
3	LEFT_OUT	OUT	-
4	MIC_L	IN	-
5	JD_LOUT	IN	-
6	JD_MIC	IN	-
7	GND_AUDIO	GND	-
8	GND_AUDIO	GND	-
9	JD_LIN	IN	-
10	LINE_R_IN	IN	-
11	+5V_AUDIO	PWR	+5V
12	LINE_L_IN	IN	-

2.4.6 M.2 3052/3042/2242 B-Key Connector (CN6)

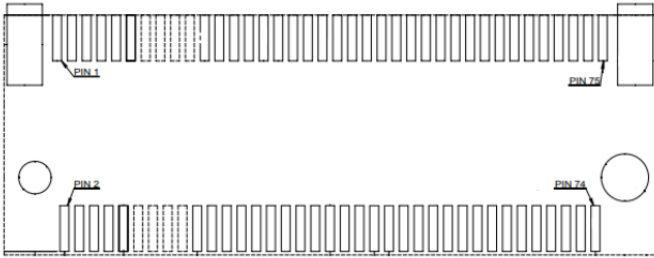

Standard specifications.

2.4.7 DDR5 SO-DIMM Channel 1 (CN7)

Standard specifications.

2.4.8 Front Panel (CN9)

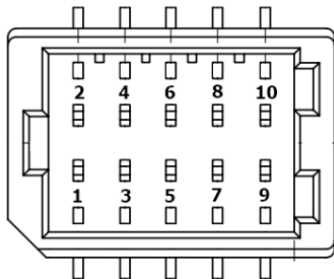

Pin	Pin Name	Signal Type	Signal Level
1	GND	GND	GND
2	EXT_PWRBTN#	IN	-
3	SATA_LED-	OUT	-
4	SATA_LED+	OUT	-
5	BUZZER-	OUT	-
6	BUZZER+	OUT	-
7	GND	GND	GND
8	PWR_LED+	OUT	-
9	GND	GND	GND
10	HWRST#	IN	-

2.4.9 DDR5 SO-DIMM Channel 2 (CN10)

Standard Specifications.

2.4.10 COM Port 3/Port 4 (CN11)

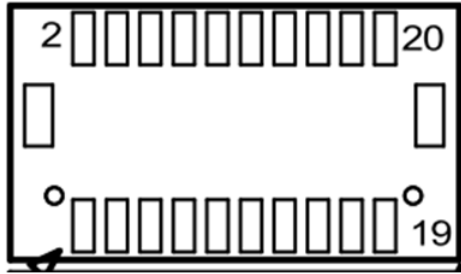

COM Port 3/Port 4 RS-232 (Default)

Pin	Pin Name	Signal Type	Signal Level
1	DCD3	IN	-
2	DCD4	IN	-
3	RX3	IN	-
4	RX4	IN	-
5	TX3	OUT	±9V
6	TX4	OUT	±9V
7	DTR3	OUT	±9V
8	DTR4	OUT	±9V
9	GND	GND	GND
10	GND	GND	GND
11	DSR3	IN	-
12	DSR4	IN	-
13	RTS3	OUT	±9V
14	RTS4	OUT	±9V
15	CTS3	IN	-
16	CTS4	IN	-

COM Port 3/Port 4 RS-232 (Default)

Pin	Pin Name	Signal Type	Signal Level
17	RI3/ +5V/ +12V	IN/ PWR	+5V/+12V
18	RI4/ +5V/ +12V	IN/ PWR	+5V/+12V
19	NC	NC	NC
20	NC	NC	NC

2.4.10.1 COM Port 3 RS-RS-422/RS-485

COM Port 3 RS-422

Pin	Pin Name	Signal Type	Signal Level
9	GND	GND	GND
1	RS422_TX-	OUT	±9V
3	RS422_TX+	OUT	±9V
5	RS422_RX+	IN	-
7	RS422_RX-	IN	-

COM Port 3 RS-485

Pin	Pin Name	Signal Type	Signal Level
9	GND	GND	GND
1	RS485_D-	I/O	±9V
3	RS485_D+	I/O	±9V

Note: COM 3 RS-232/422/485 can be set by BIOS setting. Default is RS-232.

2.4.10.2 COM Port 4 RS-422/RS-485

COM Port 4 RS-422			
Pin	Pin Name	Signal Type	Signal Level
10	GND	GND	GND
2	RS422_TX-	OUT	±9V
4	RS422_TX+	OUT	±9V
6	RS422_RX+	IN	-
8	RS422_RX-	IN	-

COM Port 4 RS-485			
Pin	Pin Name	Signal Type	Signal Level
10	GND	GND	GND
2	RS485_D-	I/O	±9V
4	RS485_D+	I/O	±9V

Note: COM 4 RS-232/422/485 can be set by BIOS setting. Default is RS-232.

2.4.11 COM Port 1/Port 2 (CN12)

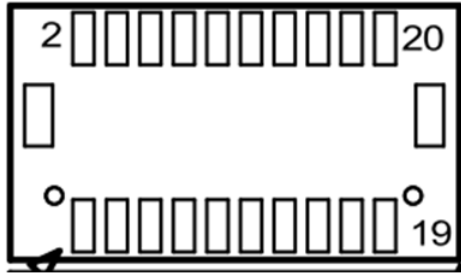

COM Port 1/Port 2 RS-232 (Default)

Pin	Pin Name	Signal Type	Signal Level
1	DCD1	IN	-
2	DCD2	IN	-
3	RX1	IN	-
4	RX2	IN	-
5	TX1	OUT	±9V
6	TX2	OUT	±9V
7	DTR1	OUT	±9V
8	DTR2	OUT	±9V
9	GND	GND	GND
10	GND	GND	GND
11	DSR1	IN	-
12	DSR2	IN	-
13	RTS1	OUT	±9V
14	RTS2	OUT	±9V
15	CTS1	IN	-
16	CTS2	IN	-

COM Port 1/Port 2 RS-232 (Default)

Pin	Pin Name	Signal Type	Signal Level
17	RI1/ +5V/ +12V	IN/ PWR	+5V/+12V
18	RI2/ +5V/ +12V	IN/ PWR	+5V/+12V
19	NC	NC	NC
20	NC	NC	NC

2.4.11.1 COM Port 1 RS-422/RS-485

COM Port 1 RS-422

Pin	Pin Name	Signal Type	Signal Level
9	GND	GND	GND
1	RS422_TX-	OUT	±9V
3	RS422_TX+	OUT	±9V
5	RS422_RX+	IN	-
7	RS422_RX-	IN	-

COM Port 1 RS-485

Pin	Pin Name	Signal Type	Signal Level
9	GND	GND	GND
1	RS485_D-	I/O	±9V
3	RS485_D+	I/O	±9V

Note: COM 1 RS-232/422/485 can be set by BIOS setting. Default is RS-232.

Note: Pin 17 function can be set by JP2.

2.4.11.2 COM Port 2 RS-422/RS-485

COM Port 2 RS-422			
Pin	Pin Name	Signal Type	Signal Level
10	GND	GND	GND
2	RS422_TX-	OUT	±9V
4	RS422_TX+	OUT	±9V
6	RS422_RX+	IN	
8	RS422_RX-	IN	

COM Port 2 RS-485			
Pin	Pin Name	Signal Type	Signal Level
10	GND	GND	GND
2	RS485_D-	I/O	±9V
4	RS485_D+	I/O	±9V

Note: COM 2 RS-232/422/485 can be set by BIOS setting. Default is RS-232.

Note: Pin 18 function can be set by JP3.

2.4.12 USB 2.0 Port 5/Port 6 (CN13)

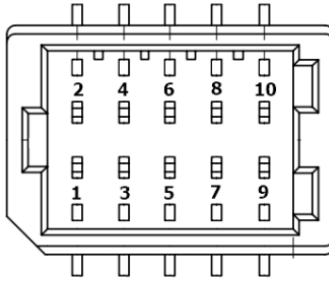

Pin	Pin Name	Signal Type	Signal Level
1	+5VSB	PWR	+5V
2	+5VSB	PWR	+5V
3	USB2_5_DN	DIFF	-
4	USB2_6_DN	DIFF	-
5	USB2_5_DP	DIFF	-
6	USB2_6_DP	DIFF	-
7	GND	GND	GND
8	GND	GND	GND
9	GND	GND	GND
10	GND	GND	GND

Note: The driving current of +5VSB supports up to 0.5A/Port.

2.4.13 GPIO Port (CN14)

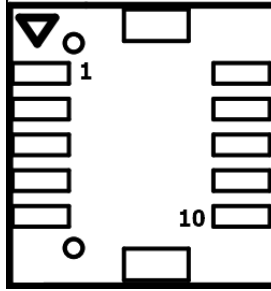

Pin	Pin Name	Signal Type	Signal Level
1	GPIO_0	IN/OUT	-
2	GPIO_1	IN/OUT	-
3	GPIO_2	IN/OUT	-
4	GPIO_3	IN/OUT	-
5	GPIO_4	IN/OUT	-
6	GPIO_5	IN/OUT	-
7	GPIO_6	IN/OUT	-
8	GPIO_7	IN/OUT	-
9	+V5S	PWR	+5V
10	GND	GND	GND

Note: The driving current of +V5S supports up to 0.5A.

2.4.14 USB 2.0 Port 7/Port 8 (CN15)

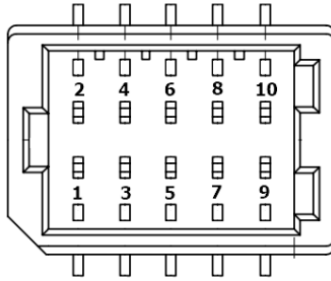

Pin	Pin Name	Signal Type	Signal Level
1	+5VSB	PWR	+5V
2	+5VSB	PWR	+5V
3	USB2_7_DN	DIFF	-
4	USB2_8_DN	DIFF	-
5	USB2_7_DP	DIFF	-
6	USB2_8_DP	DIFF	-
7	GND	GND	GND
8	GND	GND	GND
9	GND	GND	GND
10	GND	GND	GND

Note: The driving current of +5VSB supports up to 0.5A/Port.

2.4.15 SPI Flash Programming Port (CN16)

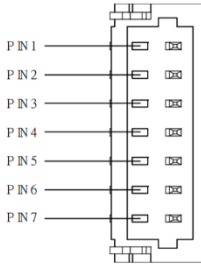

Pin	Pin Name	Signal Type	Signal Level
1	SPI_MISO	OUT	-
2	GND	GND	GND
3	SPI_CLK	IN	-
4	+V3P3A_SPI	PWR	+3.3V
5	SPI_MOSI	IN	-
6	SPI_CS	IN	-
7	NC	-	-

2.4.16 LVDS Inverter/Backlight Connector (CN17)

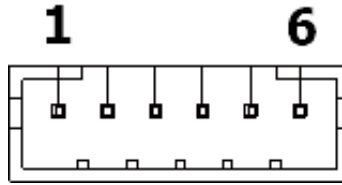

Pin	Pin Name	Signal Type	Signal Level
1	BKL_PWR	PWR	+5V(Default)/+12V
2	BKL_PWR	PWR	+5V(Default)/+12V
3	BKL_CONTROL	OUT	-
4	GND	GND	-
5	GND	GND	-
6	BKL_ENABLE	OUT	+3.3V

Note: LVDS/BKL_PWR can be set to +12V or +5V by JP4.

Note: LVDS/BKL_CONTROL can be set by JP6.

Note: The driving current of BKL_PWR supports up to 2A.

2.4.17 M.2 2230 E-Key Connector (CN18)

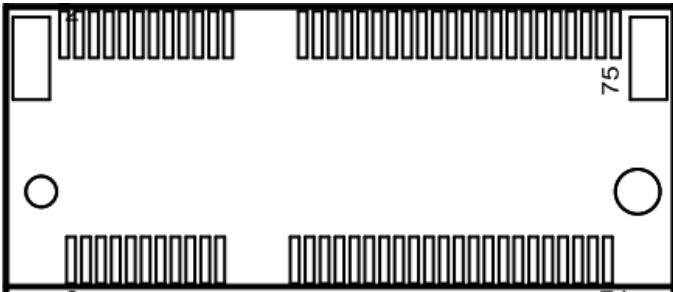

Standard specifications.

2.4.18 M.2 2280 M-Key Connector (CN19)

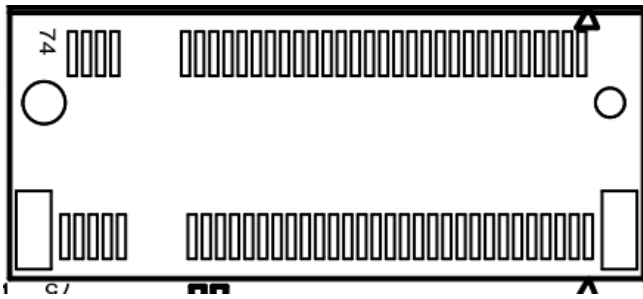

Standard specifications.

2.4.19 eDP Connector (CN20)

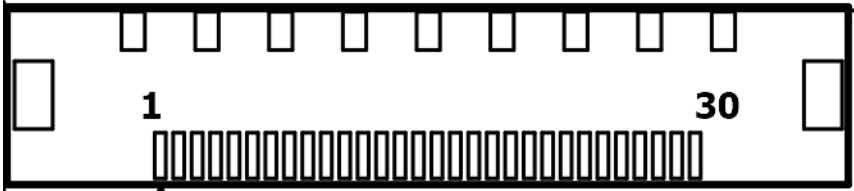

Pin	Pin Name	Signal Type	Signal Level
1	+VDD	PWR	+3.3V
2	+VDD	PWR	+3.3V
3	+VDD	PWR	+3.3V
4	GND	GND	-
5	EDP_LANE2_DN	DIFF	-
6	EDP_LANE2_DP	DIFF	-
7	GND	GND	-
8	EDP_LANE1_DN	DIFF	-
9	EDP_LANE1_DP	DIFF	-
10	GND	GND	-
11	EDP_LANE0_DN	DIFF	-
12	EDP_LANE0_DP	DIFF	-
13	GND	GND	-
14	EDP_LANE3_DN	DIFF	-
15	EDP_LANE3_DP	DIFF	-
16	GND	GND	-
17	EDP_AUX_DN	DIFF	-
18	EDP_AUX_DP	DIFF	-
19	GND	GND	-

Pin	Pin Name	Signal Type	Signal Level
20	EDP_BKLTCTL		-
21	N/A		-
22	EDP_BKLT_EN		-
23	EDP_HPD		-
24	GND	GND	-
25	GND	GND	-
26	GND	GND	-
27	+VCC_EDP_BKLT	PWR	+12V
28	+VCC_EDP_BKLT	PWR	+12V
29	+VCC_EDP_BKLT	PWR	+12V
30	+VCC_EDP_BKLT	PWR	+12V

Note: The driving current of +VCC_EDP_BKLT supports up to 1.2A.

Note: The driving current of +VDD supports up to 1A.

2.4.20 LVDS Connector (CN21)

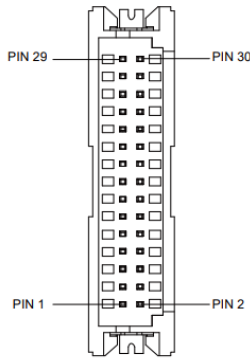

Pin	Pin Name	Signal Type	Signal Level
1	BKL_ENABLE	OUT	-
2	BKL_CONTROL	OUT	-
3	LCD_PWR	PWR	+3.3V/+5V
4	GND	GND	-
5	LVDS_A_CLK-	DIFF	-
6	LVDS_A_CLK+	DIFF	-
7	LCD_PWR	PWR	+3.3V/+5V
8	GND	GND	-
9	LVDS_DA0-	DIFF	-
10	LVDS_DA0+	DIFF	-
11	LVDS_DA1-	DIFF	-
12	LVDS_DA1+	DIFF	-
13	LVDS_DA2-	DIFF	-
14	LVDS_DA2+	DIFF	-
15	LVDS_DA3-	DIFF	-

Pin	Pin Name	Signal Type	Signal Level
16	LVDS_DA3+	DIFF	-
17	DDC_DATA	I/O	+3.3V
18	DDC_CLK	I/O	+3.3V
19	LVDS_DB0-	DIFF	-
20	LVDS_DB0+	DIFF	-
21	LVDS_DB1-	DIFF	-
22	LVDS_DB1+	DIFF	-
23	LVDS_DB2-	DIFF	-
24	LVDS_DB2+	DIFF	-
25	LVDS_DB3-	DIFF	-
26	LVDS_DB3+	DIFF	-
27	LCD_PWR	PWR	+3.3V/+5V
28	GND	GND	-
29	LVDS_B_CLK-	DIFF	-
30	LVDS_B_CLK+	DIFF	-

2.4.21 Port 80 Debug Port (CN22)

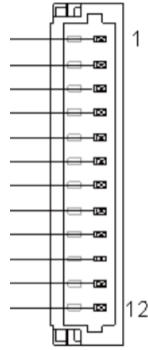

Pin	Pin Name	Signal Type	Signal Level
1	ESP_IO0	I/O	+1.8V
2	ESP_IO1	I/O	+1.8V
3	ESP_IO2	I/O	+1.8V
4	ESP_IO3	I/O	+1.8V
5	+V3P3S	PWR	+3.3V
6	ESPI_CS	IN	-
7	ESPI_RST	OUT	+3.3V
8	GND	GND	GND
9	ESPI_CLK	OUT	+1.8V
10	SMB_DATA/ I2C_SDA	I/O	+3.3V
11	SMB_CLK/ I2C_CLK	OUT	+3.3V
12	SMB_ALERT/ INT_SERIRQ	IN	+3.3V

2.4.22 Nano SIM Card Socket (CN23)

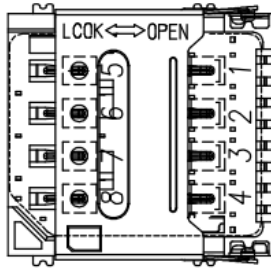

Pin	Pin Name	Signal Type	Signal Level
1	UIM_PWR	PWR	-
2	UIM_RST	IN	-
3	UIM_CLK	IN	-
4	N/A	N/A	-
5	GND	GND	GND
6	UIM_VPP	PWR	-
7	UIM_DATA	I/O	-
8	N/A	N/A	-

2.4.23 RTC Battery Connector (CN24)

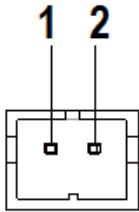

Pin	Pin Name	Signal Type	Signal Level
1	+3.3V	PWR	+3.3V
2	GND	GND	GND

2.4.24 4-Pin FAN Connector (CN26)

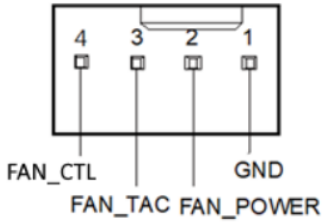

Pin	Pin Name	Signal Type	Signal Level
1	GND	GND	GND
2	FAN_POWER	PWR	+12V
3	FAN_TAC	IN	-
4	FAN_CTL	-	-

Note: The driving current of FAN_POWER supports up to 1A.

2.4.25 LAN (RJ-45) Port 1/Port 2 (CN27)

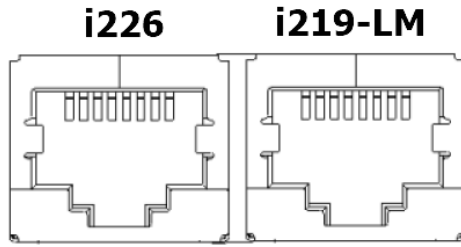

Pin	Pin Name	Signal Type	Signal Level
1P1	LAN2_MDI0_P	DIFF	-
1P2	LAN2_MDI0_N	DIFF	-
1P3	LAN2_MDI1_P	DIFF	-
1P4	LAN2_MDI1_N	DIFF	-
1P7	LAN2_MDI2_P	DIFF	-
1P8	LAN2_MDI2_N	DIFF	-
1P9	LAN2_MDI3_P	DIFF	-
1P10	LAN2_MDI3_N	DIFF	-
2P1	LAN1_MDI0_P	DIFF	-
2P2	LAN1_MDI0_N	DIFF	-
2P3	LAN1_MDI1_P	DIFF	-
2P4	LAN1_MDI1_N	DIFF	-
2P7	LAN1_MDI2_P	DIFF	-
2P8	LAN1_MDI2_N	DIFF	-
2P9	LAN1_MDI3_P	DIFF	-
2P10	LAN1_MDI3_N	DIFF	-

2.4.26 LAN Port 1 LED Connector (CN28)

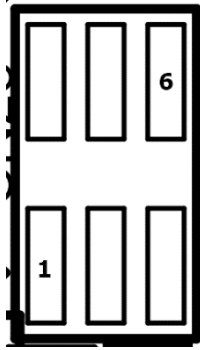

Pin	Pin Name	Signal Type	Signal Level
1	LINK1_ACT#	I/O	-
2	+V3P3A	PWR	+3.3V
3	LAN1_1000#	I/O	-
4	LAN1_100#	I/O	-
5	LAN1_100#	I/O	-
6	LAN1_1000#	I/O	-

2.4.27 USB 3.2/USB 2.0 Port 3 (CN29)

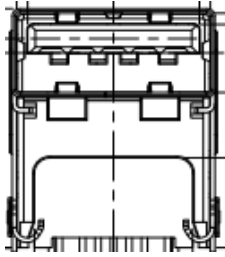

Pin	Pin Name	Signal Type	Signal Level
1	+5VSB	PWR	+5V
2	USB2_3_DN	DIFF	-
3	USB2_3_DP	DIFF	-
4	GND	GND	GND
5	USB3_3_RXN	DIFF	-
6	USB3_3_RXP	DIFF	-
7	GND	GND	GND
8	USB3_3_TXN	DIFF	-
9	USB3_3_TXP	DIFF	-

Note: The driving current of +5VSB supports up to 0.9A.

2.4.28 USB 3.2/USB 2.0 Port 1/Port 2 (CN30)

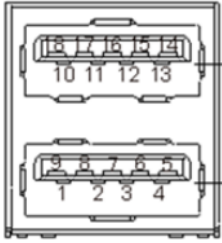

Pin	Pin Name	Signal Type	Signal Level
1	+5VSB	PWR	+5V
2	USB2_1_DN	DIFF	-
3	USB2_1_DP	DIFF	-
4	GND	GND	GND
5	USB3_1_RXN	DIFF	-
6	USB3_1_RXP	DIFF	-
7	GND	GND	GND
8	USB3_1_TXN	DIFF	-
9	USB3_1_TXP	DIFF	-
10	+5VSB	PWR	+5V
11	USB2_2_DN	DIFF	-
12	USB2_2_DP	DIFF	-
13	GND	GND	GND
14	USB3_2_RXN	DIFF	-
15	USB3_2_RXP	DIFF	-
16	GND	GND	GND
17	USB3_2_TXN	DIFF	-
18	USB3_2_TXP	DIFF	-

Note: The driving current of +5VSB supports up to 0.9A/Port.

2.4.29 DP Connector (CN31)

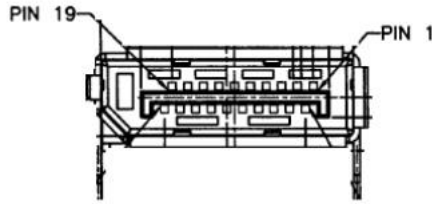

Pin	Pin Name	Signal Type	Signal Level
1	DP_TX0_DP	DIFF	-
2	GND	GND	GND
3	DP_TX0_DN	DIFF	-
4	DP_TX1_DP	DIFF	-
5	GND	GND	GND
6	DP_TX1_DN	DIFF	-
7	DP_TX2_DP	DIFF	-
8	GND	GND	GND
9	DP_TX2_DN	DIFF	-
10	DP_TX3_DP	DIFF	-
11	GND	GND	GND
12	DP_TX3_DN	DIFF	-
13	DP_OB_AUX_EN	IN	-
14	GND	GND	GND
15	DP_AUX_DP	I/O	-
16	GND	GND	GND
17	DP_AUX_DN	I/O	-
18	DP_HPD	I/O	-
19	GND	GND	GND
20	+3.3V	PWR	+3.3V

2.4.30 HDMI Connector (CN33)

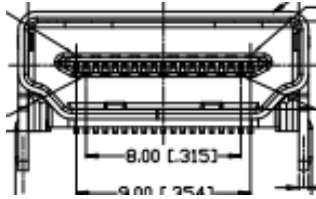

Pin	Pin Name	Signal Type	Signal Level
1	HDMI_TX2+	DIFF	-
2	GND	GND	GND
3	HDMI_TX2-	DIFF	-
4	HDMI_TX1+	DIFF	-
5	GND	GND	GND
6	HDMI_TX1-	DIFF	-
7	HDMI_TX0+	DIFF	-
8	GND	GND	GND
9	HDMI_TX0-	DIFF	-
10	HDMI_CLK+	DIFF	-
11	GND	GND	GND
12	HDMI_CLK-	DIFF	-
13	N/A	N/A	N/A
14	N/A	N/A	N/A
15	DDC_CLK	I/O	-
16	DDC_DATA	I/O	-
17	GND	GND	GND
18	+V5S	PWR	+5V
19	HDMI_HPD	IN	-

2.4.31 USB Type C (CN34)

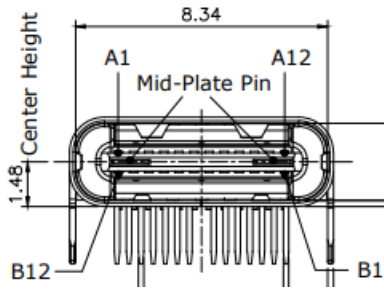

Pin	Pin Name	Signal Type	Signal Level
A1	GND	GND	GND
A2	TCP2_TX0_DP	DIFF	-
A3	TCP2_TX0_DN	DIFF	-
A4	+5VSB	PWR	+5V
A5	CONN_CC1	IN	-
A6	USB2_10_DP	DIFF	-
A7	USB2_10_DN	DIFF	-
A8	CONN_TYPEC1_SBU1	DIFF	-
A9	+5VSB	PWR	+5V
A10	TCP2_TXRX1_DN	DIFF	-
A11	TCP2_TXRX1_DP	DIFF	-
A12	GND	GND	GND
B1	GND	GND	GND
B2	TCP2_TX1_DP	DIFF	-
B3	TCP2_TX1_DN	DIFF	-
B4	+5VSB	PWR	+5V
B5	CONN_TYPEC1_CC2	IN	-

Pin	Pin Name	Signal Type	Signal Level
B6	USB2_10_DP	DIFF	-
B7	USB2_10_DN	DIFF	-
B8	CONN_TYPEC1_SBU2	DIFF	-
B9	+5VSB	PWR	+5V
B10	TCP2_TXRX0_DN	DIFF	-
B11	TCP2_TXRX0_DP	DIFF	-
B12	GND	GND	GND

Note: The driving current of +5VSB supports up to 3A.

2.4.32 FPC Connector (CN35)



Pin	Pin Name	Signal Type	Signal Level
1	+V3P3S	PWR	+3.3V
2	+V3P3S	PWR	+3.3V
3	+V3P3S	PWR	+3.3V
4	SMB_DATA	I/O	-
5	SMB_CLK	OUT	+3.3V
6	BUF_PLT_RST#	OUT	+3.3V
7	+V3P3A	PWR	+3.3V
8	GND	GND	GND
9	PCIE4_B_1_RXP	DIFF	-

Pin	Pin Name	Signal Type	Signal Level
10	PCIE4_B_1_RXN	DIFF	-
11	GND	GND	GND
12	PCIE4_B_3_RXP	DIFF	-
13	PCIE4_B_3_RXN	DIFF	-
14	GND	GND	GND
15	PCIE4_B_2_RXP	DIFF	-
16	PCIE4_B_2_RXN	DIFF	-
17	GND	GND	GND
18	PCIE4_B_0_RXP	DIFF	-
19	PCIE4_B_0_RXN	DIFF	-
20	GND	GND	GND
21	PCIE4_B_3_TXN	DIFF	-
22	PCIE4_B_3_TXP	DIFF	-
23	GND	GND	GND
24	PCIE4_B_2_TXN	DIFF	-
25	PCIE4_B_2_TXP	DIFF	-
26	GND	GND	GND
27	PCIE4_B_1_TXN	DIFF	-
28	PCIE4_B_1_TXP	DIFF	-
29	GND	GND	GND
30	PCIE_3_GEN4_CLK_DN	DIFF	-
31	PCIE_3_GEN4_CLK_DP	DIFF	-
32	GND	GND	GND
33	PCIE4_B_0_TXN	DIFF	-
34	PCIE4_B_0_TXP	DIFF	-
35	GND	GND	GND

Pin	Pin Name	Signal Type	Signal Level
36	+V12S	PWR	+12V
37	+V12S	PWR	+12V
38	+V12S	PWR	+12V
39	+V12S	PWR	+12V
40	+V12S	PWR	+12V

Note: The driving current of +V12S supports up to 2.1A.

Note: The driving current of +V3P3A supports up to 0.375A.

Note: The driving current of +V3P3S supports up to 3A.

2.4.33 LAN Port 2 LED Connector (CN36)

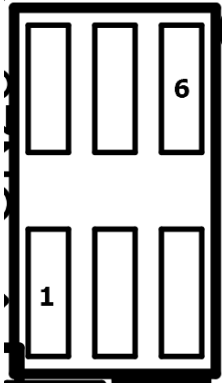

Pin	Pin Name	Signal Type	Signal Level
1	LINK2_ACT#	I/O	-
2	+V3P3A	PWR	+3.3V
3	LAN2_1000#	I/O	-
4	LAN2_2500#	I/O	-
5	LAN2_2500#	I/O	-
6	LAN2_1000#	I/O	-

2.5 Thermal Solutions

2.5.1 Active Cooling Fan - GENE-ADP6-FAN01

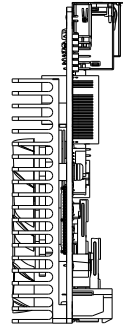
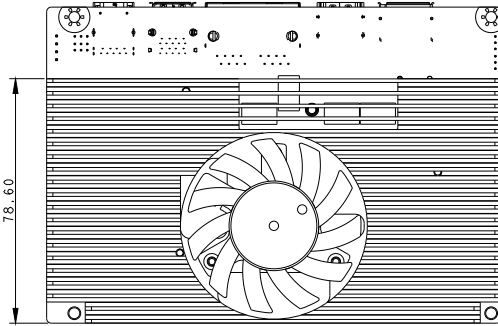
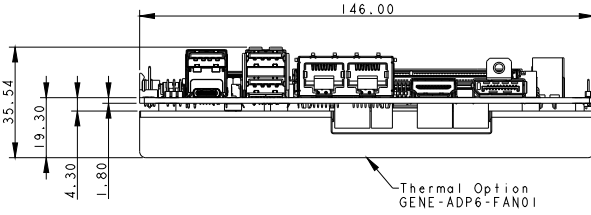

GENE-ADP6-FAN01 Assembly

3.5" Subcompact Board

GENE-RAP6

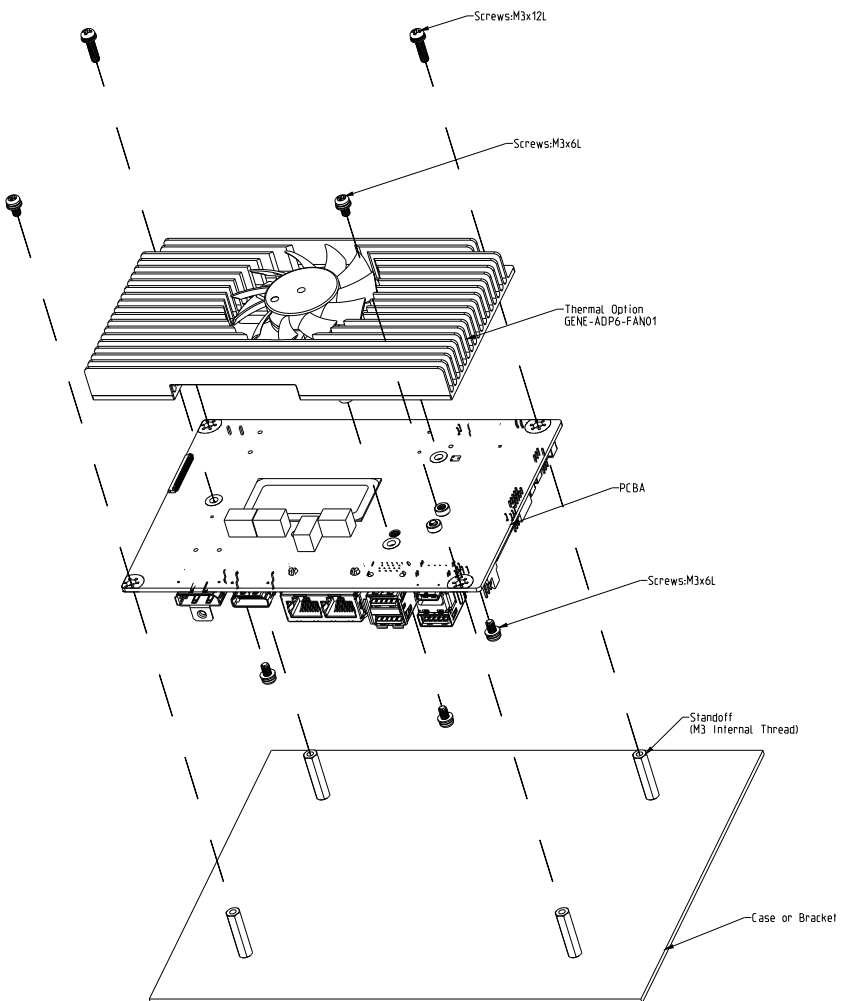

2.5.2 Heatspreader - GENE-ADP6-HSP01

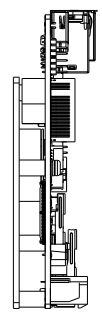
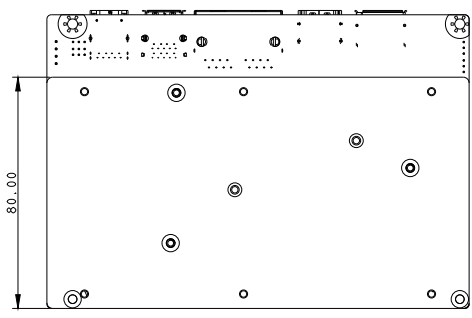
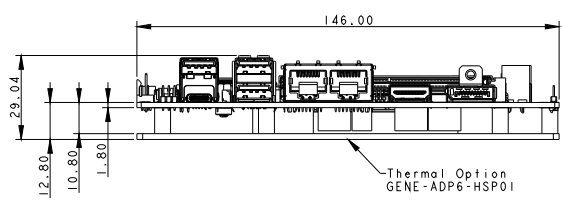

GENE-ADP6-HSP01 Assembly

3.5" Subcompact Board

GENE-RAP6

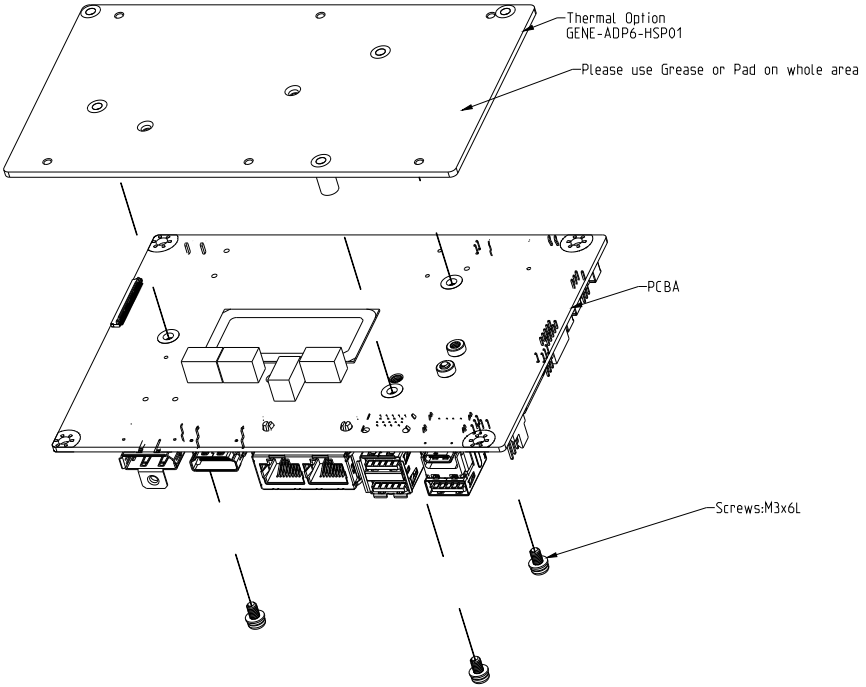

Chapter 3

AMI BIOS Setup

3.1 System Test and Initialization

These routines test and initialize board hardware. If the routines encounter an error during the tests, you will either hear a few short beeps or see an error message on the screen. There are two kinds of errors: fatal and non-fatal. The system can usually continue the boot up sequence with non-fatal errors.

System configuration verification

These routines check the current system configuration stored in the CMOS memory and BIOS NVRAM. If system configuration is not found or system configuration data error is detected, system will load optimized default and re-boot with this default system configuration automatically.

There are four situations in which you will need to setup system configuration:

1. You are starting your system for the first time
2. You have changed the hardware attached to your system
3. The system configuration is reset by Clear-CMOS jumper
4. The CMOS memory has lost power and the configuration information has been erased.

The GENE-ADP6 CMOS memory has an integral lithium battery backup for data retention. However, you will need to replace the complete unit when it finally runs down.

3.2 AMI BIOS Setup

AMI BIOS ROM has a built-in Setup program that allows users to modify the basic system configuration. This type of information is stored in battery-backed CMOS RAM and BIOS NVRAM so that it retains the Setup information when the power is turned off.

Entering Setup

Power on the computer and press or <ESC> immediately. This will allow you to enter Setup.

Main

Set the date, use tab to switch between date elements.

Advanced

Enable/disable boot option for legacy network devices.

Chipset

Host bridge parameters.

Security

Set setup administrator password.

Boot

Enables/disables quiet boot option.

Save & Exit

Exit system setup after saving the changes.

Intel® AMT Configuration

Configure user content preferences.

3.3 Setup Submenu: Main



3.4 Setup Submenu: Advanced

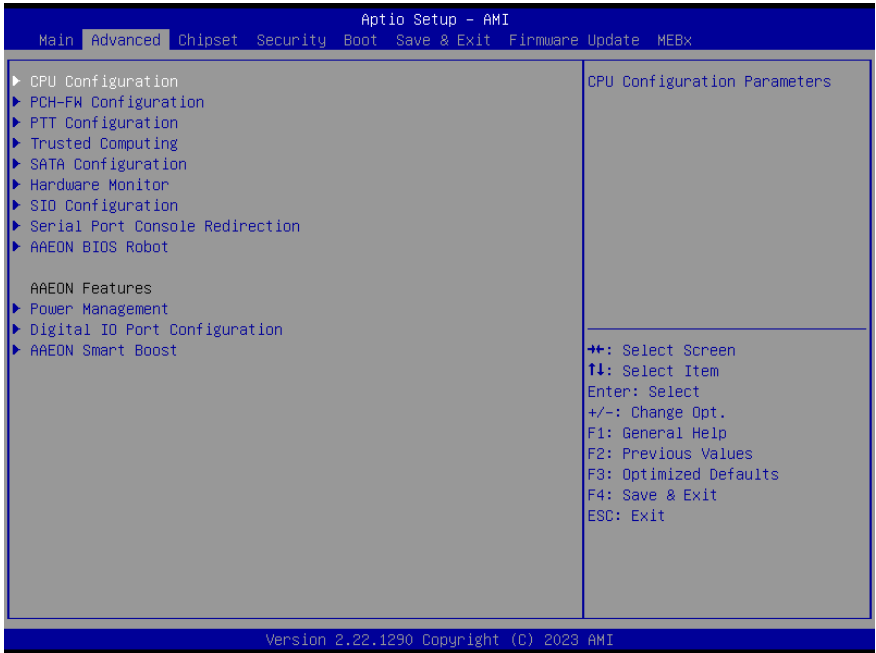

3.4.1 CPU Configuration

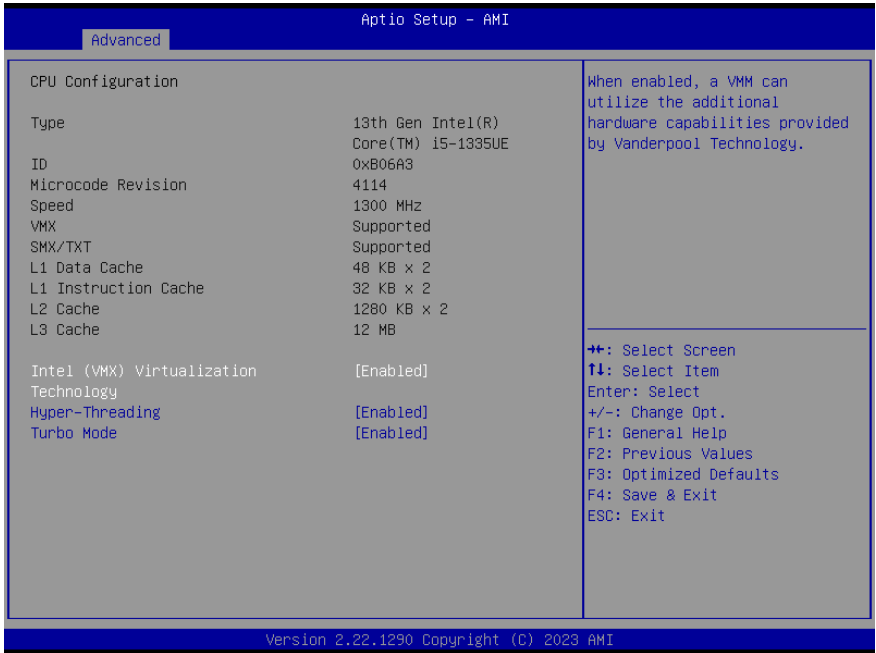

Options Summary		
Intel (VMX) Virtualization Technology	Disabled	
	Enabled	Optimal Default, Failsafe Default
When enabled, a VMM can utilize the additional hardware capabilities provided by Vanderpool Technology.		
Hyper-Threading	Disabled	
	Enabled	Optimal Default, Failsafe Default
Enable or Disable Hyper-Threading Technology.		
Turbo Mode	Disabled	
	Enabled	Optimal Default, Failsafe Default
Enable or Disable processor Turbo Mode (requires EMTTM enable too). AUTO means enabled		

3.4.2 PCH-FW Configuration

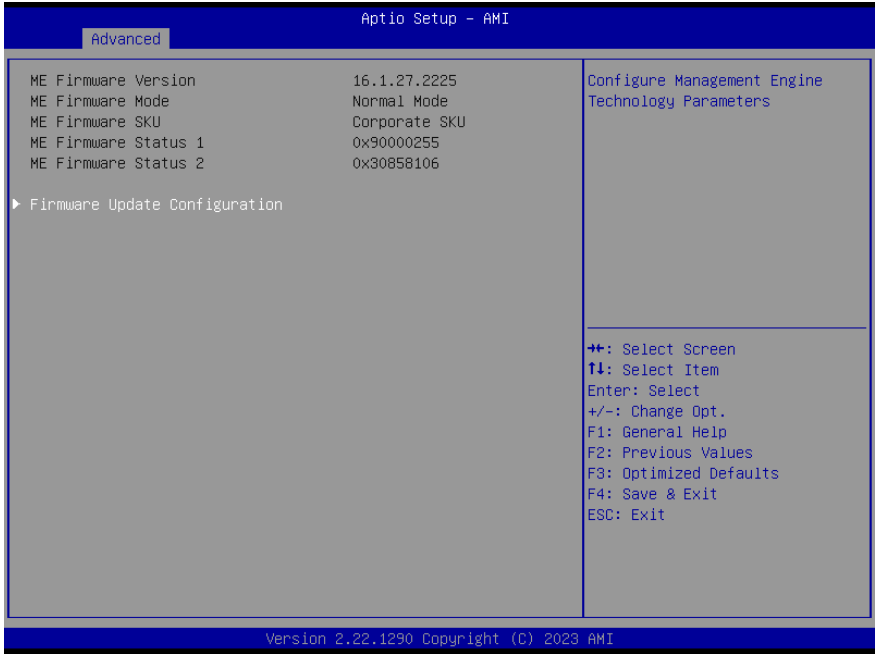

3.4.3 Firmware Update Configuration

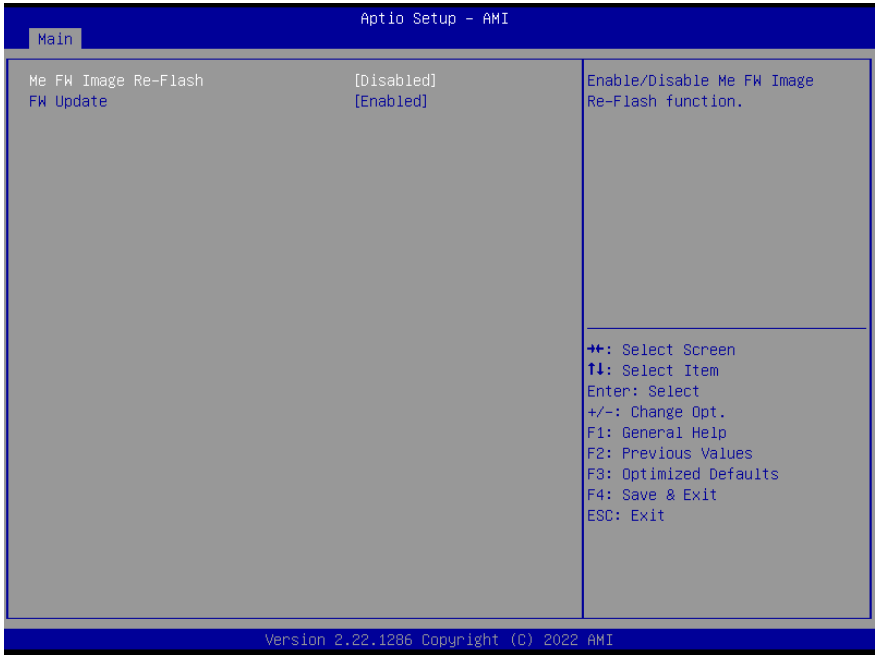

Options Summary		
Me FW Image Re-Flash	Enabled	
	Disabled	Optimal Default, Failsafe Default
Enable/Disable Me FW Image Re-Flash function.		
FW Update	Disabled	
	Enabled	Optimal Default, Failsafe Default
Enable/Disable ME FW Update function.		

3.4.4 PTT Configuration



Options Summary		
TPM Device Selection	dTPM	Optimal Default, Failsafe Default
	PTT	
<p>Selects TPM device: PTT or discrete TPM. PTT - enables PTT in SkuMgr dTPM - disables PTT in SkuMgr. Warning: PTT/dTPM will be disabled and all data saved on it will be lost.</p>		

3.4.5 Trusted Computing



Options Summary		
Security Device Support	Enable	Optimal Default, Failsafe Default
	Disable	
Enables or Disables BIOS support for security device. O.S. will not show Security Device. TCG EFI protocol and INT1A interface will not be available.		
SHA256 PCR Bank	Enabled	Optimal Default, Failsafe Default
	Disabled	
Enable or Disable SHA256 PCR Bank.		
SHA384 PCR Bank	Enabled	Optimal Default, Failsafe Default
	Disabled	
Enable or Disable SHA384 PCR Bank.		
Pending operation	None	Optimal Default, Failsafe Default
	TPM Clear	
Schedule an Operation for the Security Device. NOTE: Your Computer will reboot during restart in order to change State of Security Device.		

Options Summary		
Platform Hierarchy	Enabled	Optimal Default, Failsafe Default
	Disabled	
Enable or Disable Platform Hierarchy		
Storage Hierarchy	Enabled	Optimal Default, Failsafe Default
	Disabled	
Enable or Disable Storage Hierarchy		
Endorsement Hierarchy	Enabled	Optimal Default, Failsafe Default
	Disabled	
Enable or Disable Endorsement Hierarchy		
Physical Presence Spec Version	1.3	Optimal Default, Failsafe Default
	1.2	
Select to Tell O.S. to support PPI Spec Version 1.2 or 1.3. Note some HCK tests might not support 1.3		
Device Select	Auto	
	TPM 1.2	
	TPM 2.0	Optimal Default, Failsafe Default
TPM 1.2 will restrict support to TPM 1.2 devices, TPM 2.0 will restrict support to TPM 2.0 devices, Auto will support both with the default set to TPM 2.0 devices if not found, TPM 1.2 devices will be enumerated.		

3.4.6 SATA Configuration

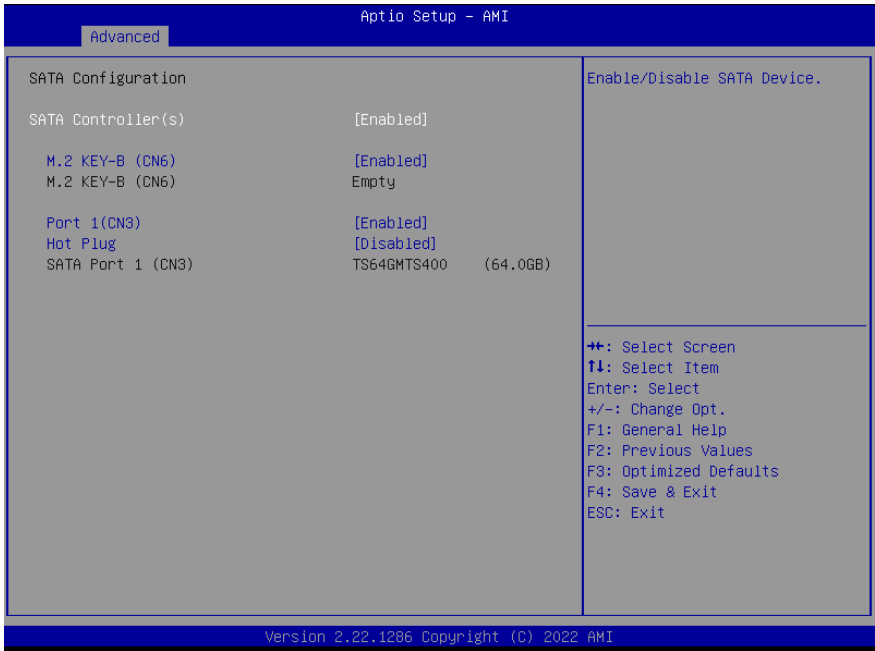

Options Summary		
SATA Controller(s)	Enabled	Optimal Default, Failsafe Default
	Disabled	
Enable/Disable SATA Device.		
M.2 KEY-B(CN6)	Enabled	Optimal Default, Failsafe Default
	Disabled	
Enable or Disable SATA Port.		
Port 1(CN3)	Enabled	Optimal Default, Failsafe Default
	Disabled	
Enable or Disable SATA Port.		
Hot Plug	Disabled	Optimal Default, Failsafe Default
	Enabled	
Designates this port as Hot Pluggable.		

3.4.7 Hardware Monitor

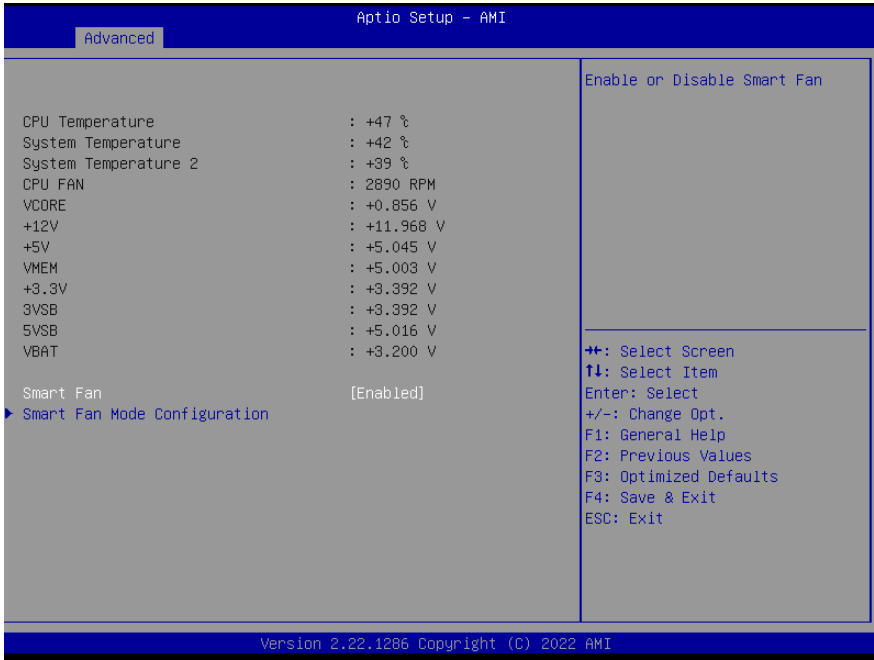

Options Summary		
Smart Fan	Disable	
	Enable	Optimal Default, Failsafe Default
Enables or Disables Smart Fan.		

3.4.7.1 Smart Fan Mode Configuration

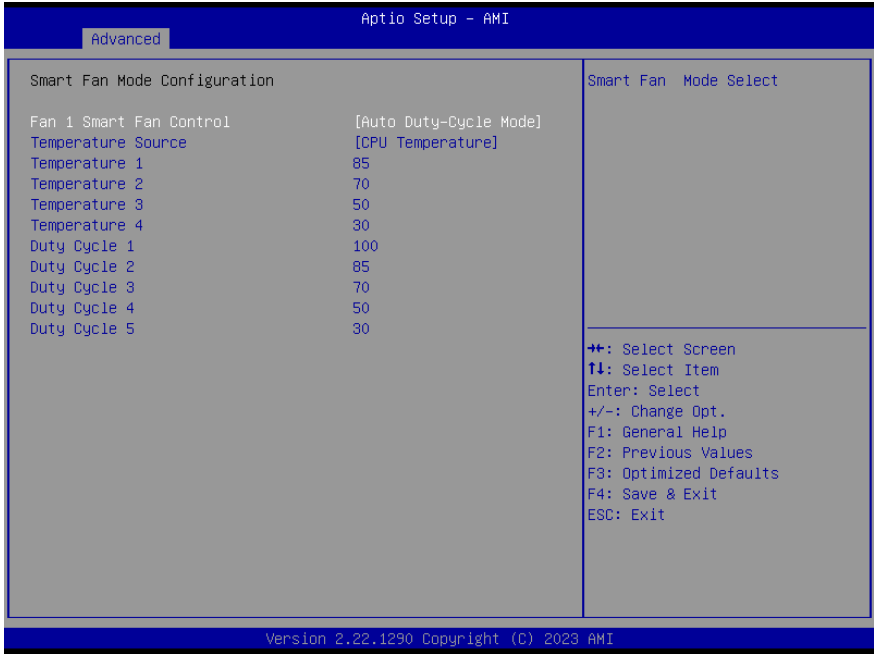

Options Summary		
Fan 1 Smart Fan Control	Manual Duty Mode	
	Auto Duty-Cycle Mode	Optimal Default, Failsafe Default
Smart Fan Mode Select.		
Temperature Source	CPU Temperature	
	System Temperature	
	System Temperature 2	Optimal Default, Failsafe Default
Select the monitored temperature source for this fan.		
Temperature 1	60	
Duty Cycle 1	85	
Auto fan speed control. Fan speed will follow different temperature by different duty cycle 1-100.		

3.4.8 SIO Configuration

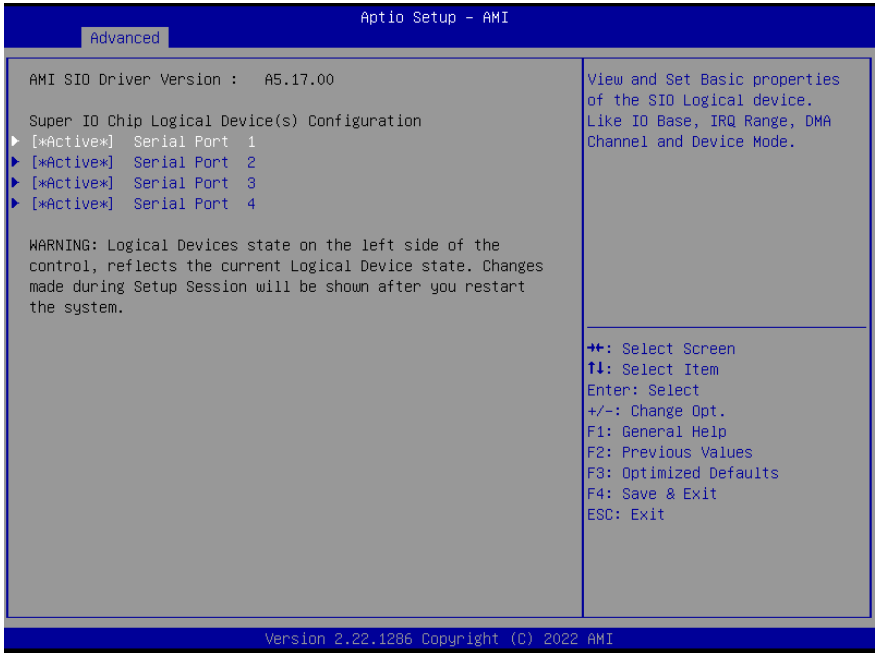

3.4.8.1 Serial Port 1 Configuration

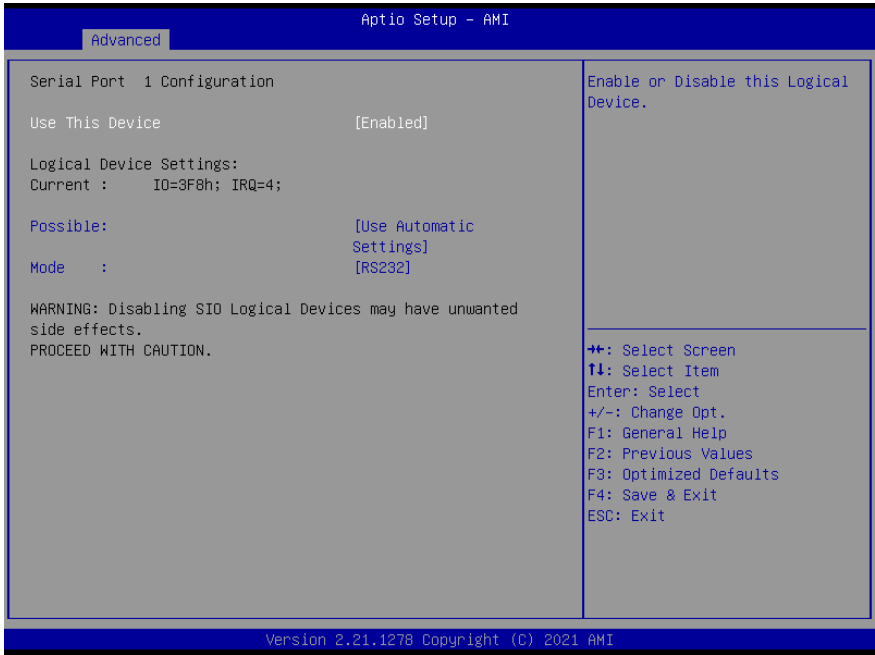

Options Summary		
Use This Device	Disable	
	Enable	Optimal Default, Failsafe Default
Enable or Disable this Logical Device.		
Possible:	Use Automatic Settings	Optimal Default, Failsafe Default
	IO=3F8h; IRQ=4	
	IO=2F8h; IRQ=3	
Allows user to change Device's Resource settings. New settings will be reflected on This Setup Page after System restarts.		
Mode:	RS232	Optimal Default, Failsafe Default
	RS422	
	RS485	
UART RS232, 422, 485 selection.		

3.4.8.2 Serial Port 2 Configuration

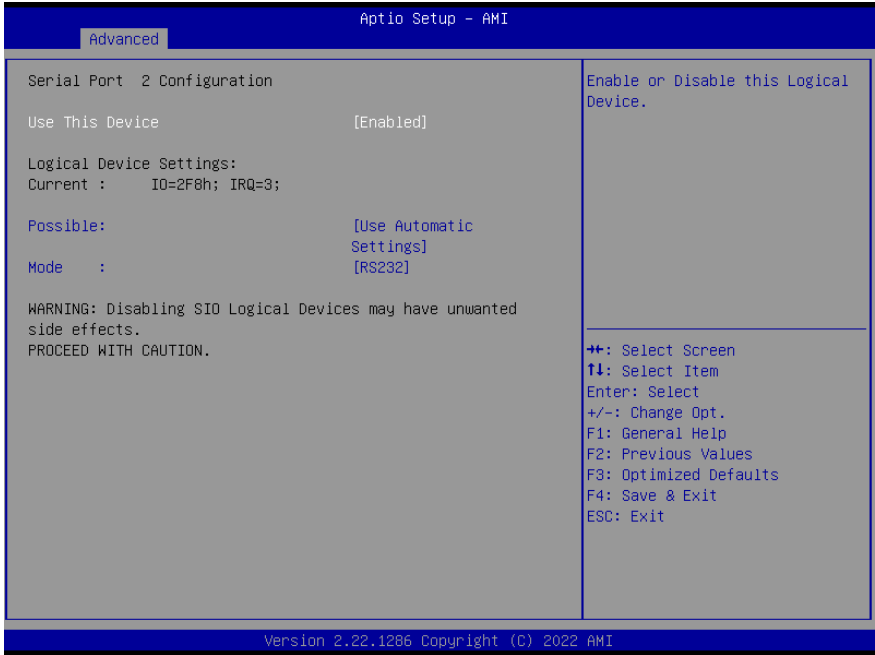

Options Summary		
Use This Device	Disable	
	Enable	Optimal Default, Failsafe Default
Enable or Disable this Logical Device.		
Possible:	Use Automatic Settings	Optimal Default, Failsafe Default
	IO=3F8h; IRQ=4	
	IO=2F8h; IRQ=3	
Allows user to change Device's Resource settings. New settings will be reflected on This Setup Page after System restarts.		
Mode:	RS232	Optimal Default, Failsafe Default
	RS422	
	RS485	
UART RS232, 422, 485 selection.		

3.4.8.3 Serial Port 3 Configuration

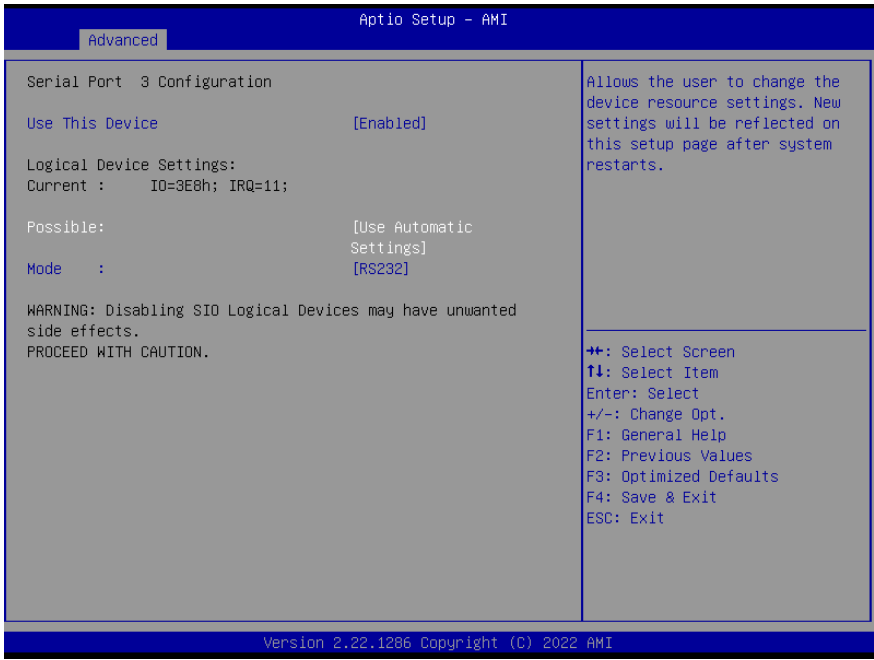

Options Summary		
Use This Device	Disable	
	Enable	Optimal Default, Failsafe Default
Enable or Disable this Logical Device.		
Possible:	Use Automatic Settings	Optimal Default, Failsafe Default
	IO=3E8h; IRQ=11	
	IO=2E8h; IRQ=11	
Allows user to change Device's Resource settings. New settings will be reflected on This Setup Page after System restarts.		
Mode:	RS232	Optimal Default, Failsafe Default
	RS422	
	RS485	
UART RS232, 422, 485 selection.		

3.4.8.4 Serial Port 4 Configuration

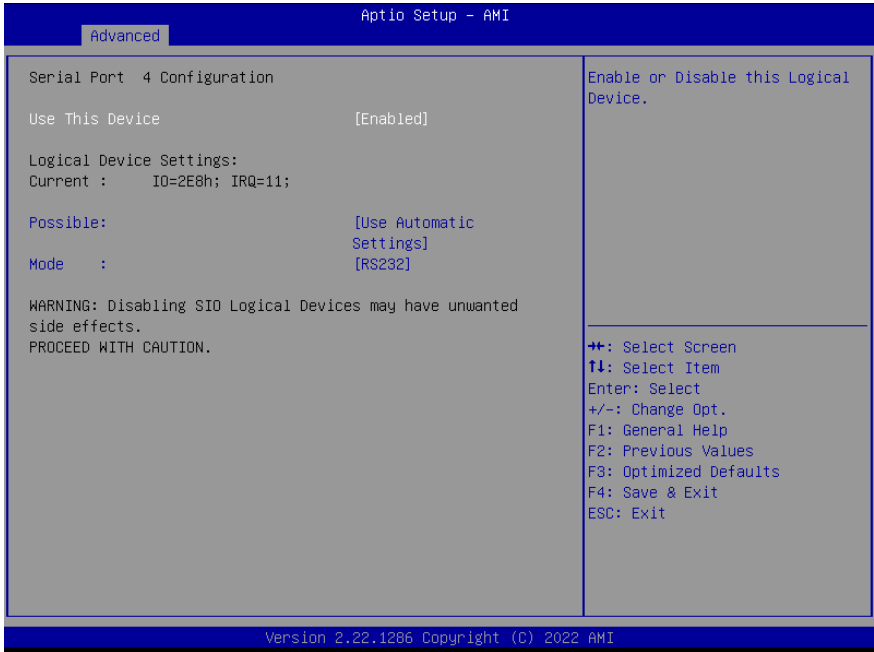

Options Summary		
Use This Device	Disable	
	Enable	Optimal Default, Failsafe Default
Enable or Disable this Logical Device.		
Possible:	Use Automatic Settings	Optimal Default, Failsafe Default
	IO=2E8h; IRQ=11	
	IO=3E8h; IRQ=11	
Allows user to change Device's Resource settings. New settings will be reflected on This Setup Page after System restarts.		
Mode:	RS232	Optimal Default, Failsafe Default
	RS422	
	RS485	
UART RS232, 422, 485 selection.		

3.4.9 Serial Port Console Redirection

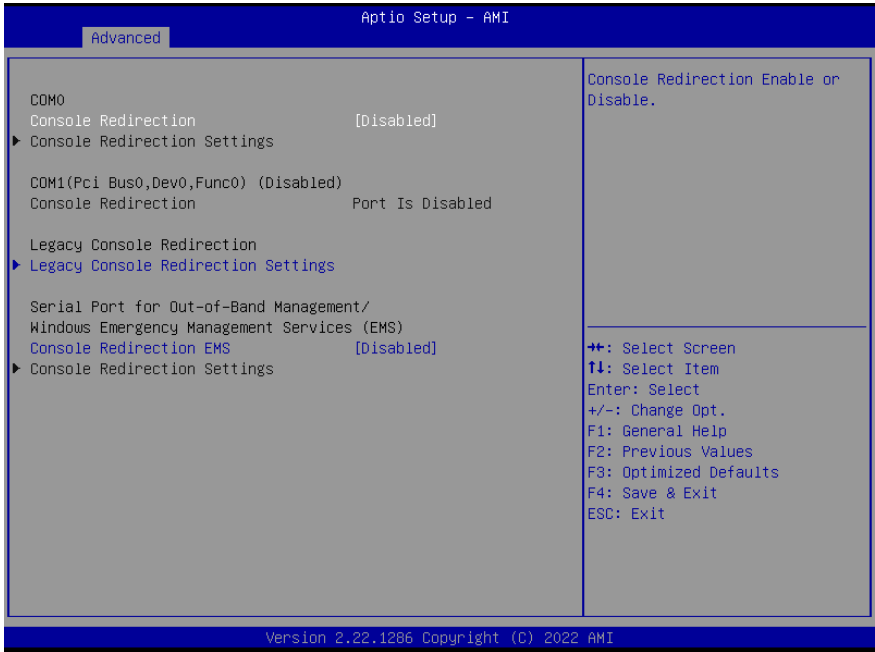

Options Summary		
Console Redirection	Disabled	Optimal Default, Failsafe Default
	Enabled	
Console Redirection Enable or Disable.		
Console Redirection EMS	Disabled	Optimal Default, Failsafe Default
	Enabled	
Console Redirection Enable or Disable.		

3.4.10 Legacy Console Redirection Settings

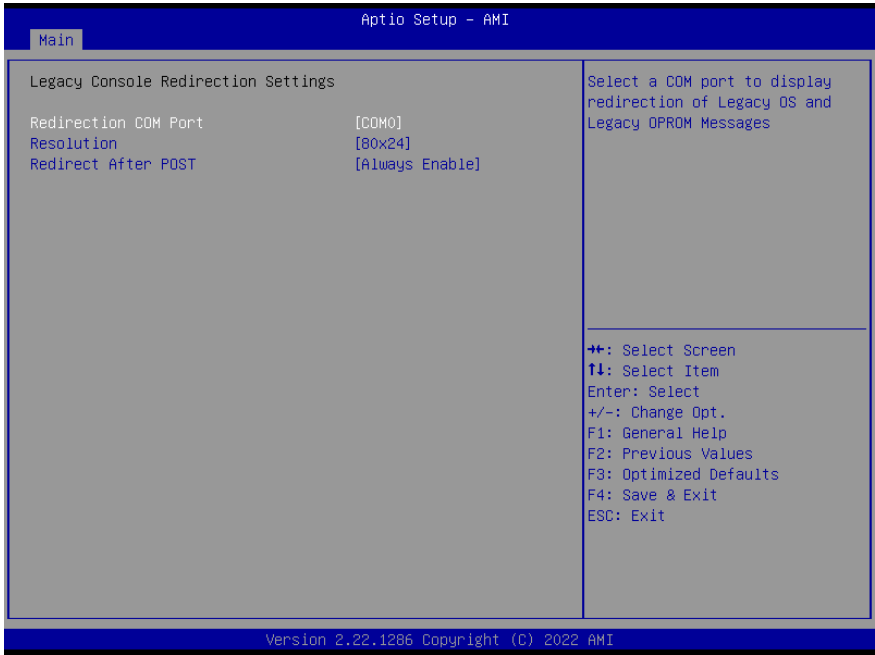

Options Summary		
Redirection COM Port	COM0	Optimal Default, Failsafe Default
	COM1(Pci Bus0, Dev0, Func0) (Disabled)	
Select a COM Port to display redirection of Legacy OS and Legacy OPRM message.		
Resolution	80x24	Optimal Default, Failsafe Default
	80x25	
On Legacy OS, the number of Rows and Columns supported redirection.		
Redirect After POST	Always Enable	Optimal Default, Failsafe Default
	BootLoader	
When Bootloader is selected, then Legacy Console Redirection is disabled before booting to legacy OS. When Always Enable is selected, then Legacy Console Redirection is enabled for legacy OS. Default setting for this option is set to Always Enable.		

3.4.11 AAEON BIOS Robot

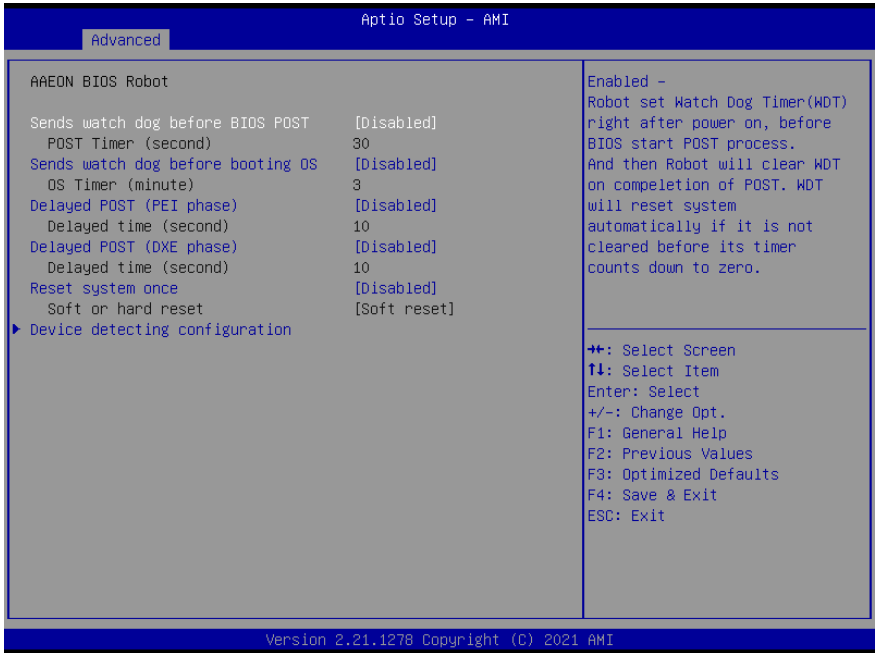

Options Summary		
Sends watch dog before BIOS POST	Disabled	Optimal Default, Failsafe Default
	Enabled	
Enabled - Robot set Watch Dog Timer (WDT) right after power on, before BIOS start POST process. Then Robot will clear WDT on completion of POST. WDT will reset system automatically if it is not cleared before its timer counts down to zero.		
POST Timer (second)	30	Optimal Default, Failsafe Default
Timer count set to Watch Dog Timer for POST. WARNING: Do not set to a value equal or shorter than normal POST time, otherwise system may never complete POST unless clearing BIOS settings. More than 2x normal POST time is suggested.		
Sends watch dog before booting OS	Disabled	Optimal Default, Failsafe Default
	Enabled	

Options Summary		
Enabled - Robot set Watch Dog Timer (WDT) after POST completion, before BIOS transfer control to OS. WARNING: Before enabling this function, a program in OS must be in responsible for clearing WDT. Also, this function should be disabled if OS is going to update itself.		
OS Timer (minute)	3	Optimal Default, Failsafe Default
Timer count set to Watch Dog Timer for OS loading.		
Delayed POST (PEI phase)	Disabled	Optimal Default, Failsafe Default
	Enabled	
Enabled - Robot holds BIOS from starting POST, right after power on. This allows BIOS POST to start with stable power or start after system is physically warmed-up. Note: Robot does this before 'Sends watch dog'.		
Delayed time (second)	10	Optimal Default, Failsafe Default
Period of time for Robot to hold BIOS from POST.		
Delayed POST (DXE phase)	Disabled	Optimal Default, Failsafe Default
	Enabled	
Enabled - Robot holds BIOS before POST completion. This allows BIOS POST to start with stable power or start after system is physically warmed-up. Note: Robot does this after 'Sends watch dog before BIOS POST'.		
Delayed time (second)	10	Optimal Default, Failsafe Default
Period of time for Robot to hold BIOS from POST.		
Reset system once	Disabled	Optimal Default, Failsafe Default
	Enabled	
Enabled - Robot resets system for one time on each boot. This will send a soft or hard reset to onboard devices, thus puts devices to more stable state.		
Soft or hard reset	Soft reset	Optimal Default, Failsafe Default
	Hard reset"	
Select reset type robot should send on each boot.		

3.4.12 Power Management

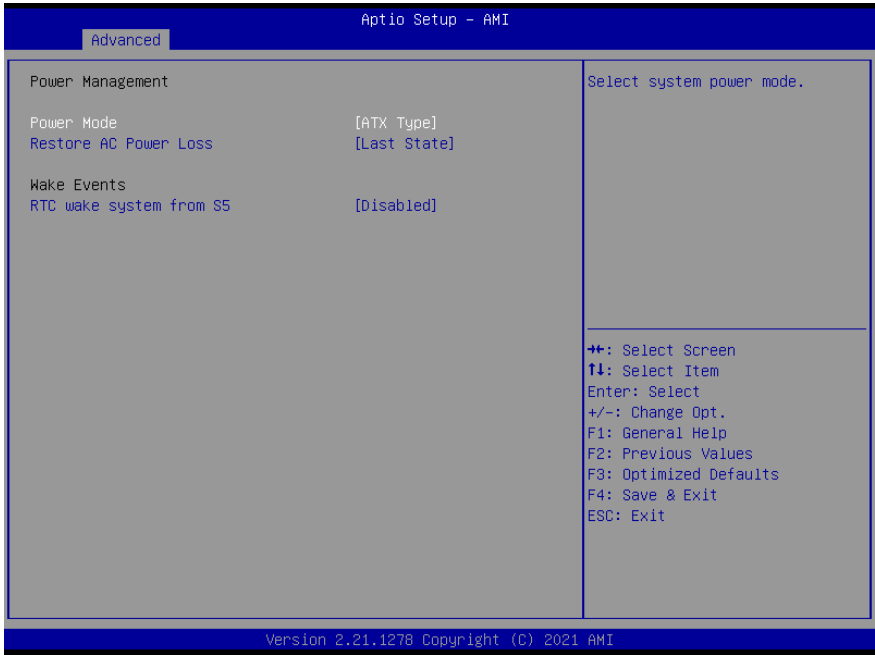

Options Summary		
Power Mode	ATX Type	Optimal Default, Failsafe Default
	AT Type	
Select power supply mode.		
Restore AC Power Loss	Last State	Optimal Default, Failsafe Default
	Always On	
	Always Off	
Select power state when power is re-applied after a power failure.		
RTC wake system from S5	Disable	Optimal Default, Failsafe Default
	Fixed Time	
	Bypass	
Fixed Time: System will wake on the hr::min::sec specified. Bypass: BIOS will not control RTC wake function during system shutdown.		

3.4.13 GPIO Port Configuration



Options Summary		
GPIO Port*	Output	
	Input	
Set GPIO as Input or Output.		
Output Level	High	
	Low	
Set output level when GPIO pin is output.		

3.4.14 AAEON Smart Boost

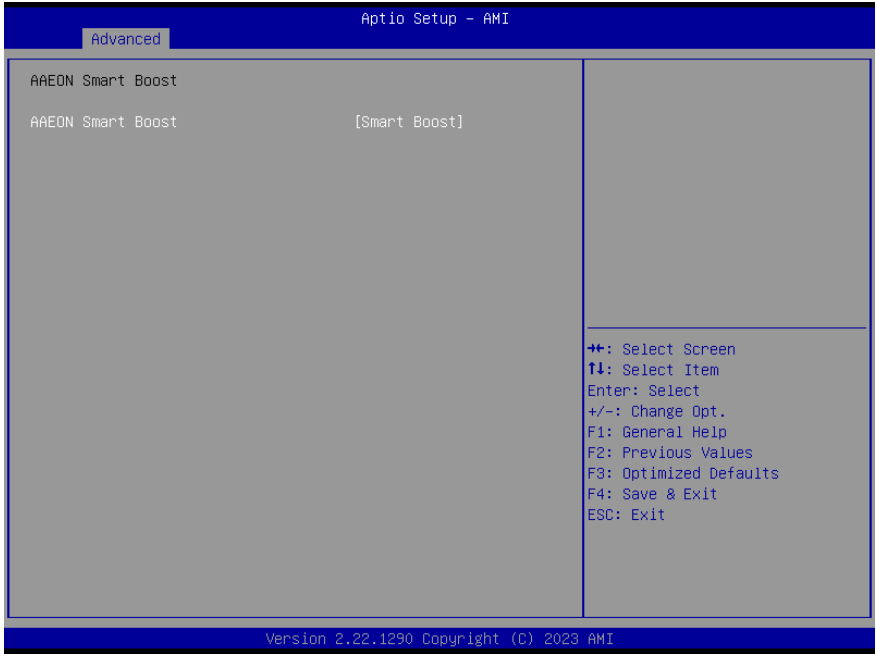

Options Summary		
AAEON Smart Boost	Smart Boost	Optimal Default, Failsafe Default
	Maximum Performance	
	Good Stability	
	Disable	
Control AAEON Smart Boost feature.		

3.5 Setup Submenu: Chipset

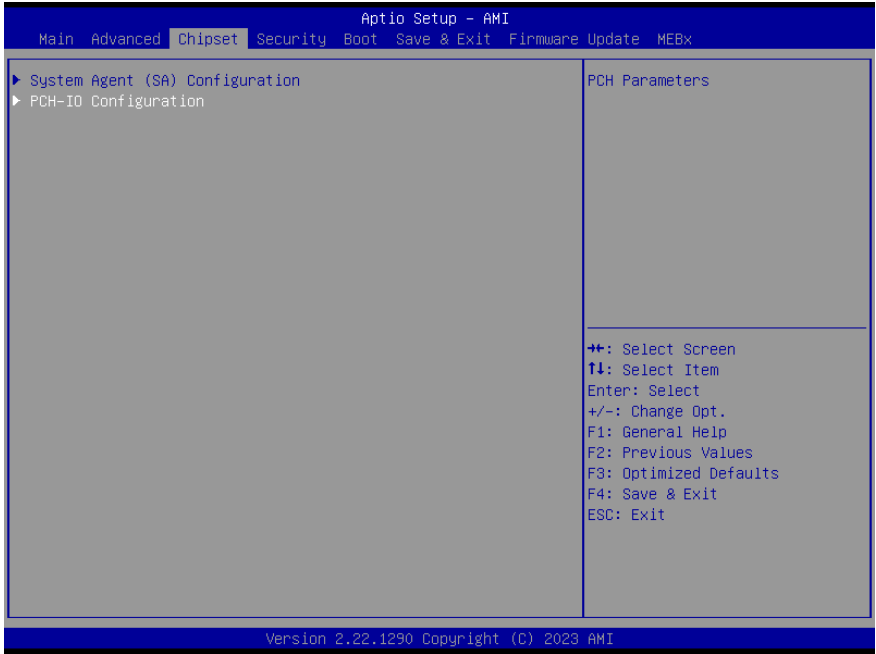

3.5.1 System Agent (SA) Configuration

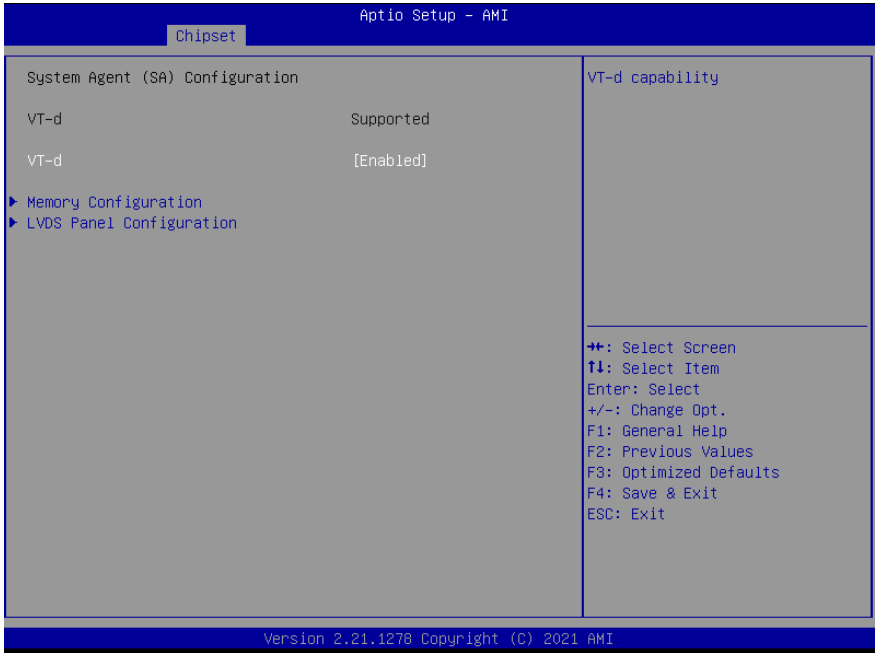

Options Summary		
VT-d	Disabled	Optimal Default, Failsafe Default
	Enabled	
VT-d capability.		

3.5.2 Memory Configuration

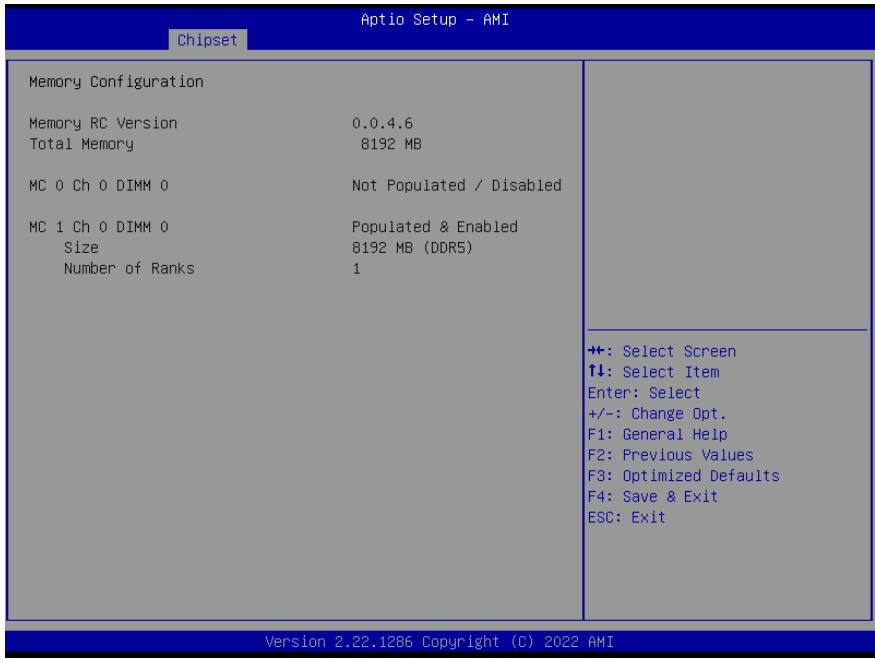

3.5.3 LVDS Panel Configuration

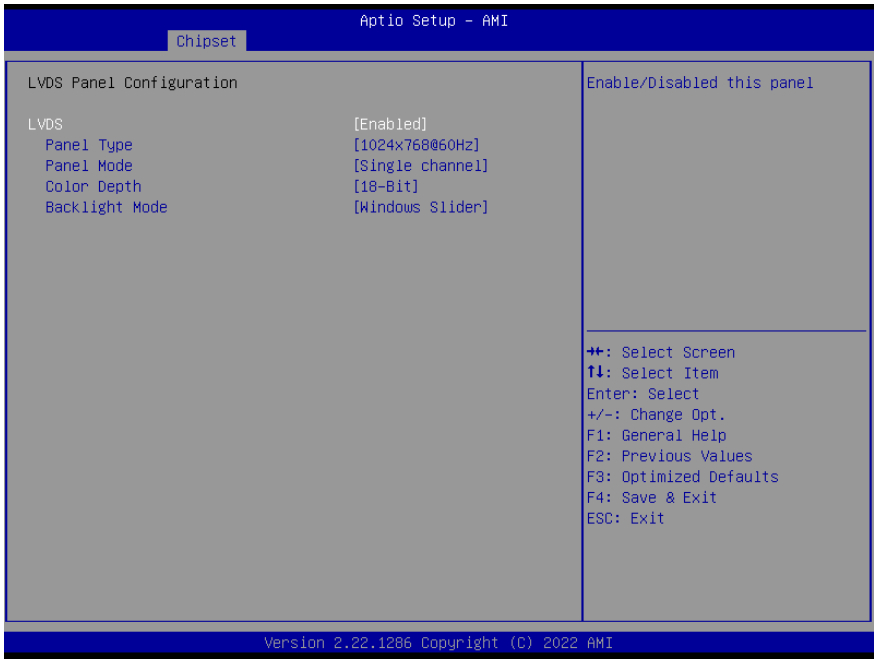

Options Summary		
LVDS	Disabled	
	Enabled	Optimal Default, Failsafe Default
Enable/Disabled this panel.		
LVDS Panel Type	640x480,18bit,60Hz	
	800x480,18bit,60Hz	
	800x600,18bit,60Hz	
	1024x600,18bit,60Hz	
	1024x768,18bit,60Hz	
	1024x768,24bit,60Hz	Optimal Default, Failsafe Default
	1280x768,24bit,60Hz	
	1280x1024,48bit,60Hz	
	1366x768,24bit,60Hz	
	1440x900,48bit,60Hz	
	1600x1200,48bit,60Hz	
	1920x1080,48bit,60Hz	

Options Summary		
	1920x1200,48bit,60Hz	
Select LCD panel used by Internal Graphics Device by selecting the appropriate setup item.		
Panel Mode	Single Channel	Optimal Default, Failsafe Default
	Dual Channel	
Panel mode selection for Single channel or Dual channel.		
Color Depth	18-bit	Optimal Default, Failsafe Default
	24-bit	
	36-bit	
	48-bit	
Select panel type.		
Backlight Mode	BIOS & Application	
	Windows Slider	Optimal Default, Failsafe Default
Select backlight control signal type.		

3.5.4 PCH-IO Configuration

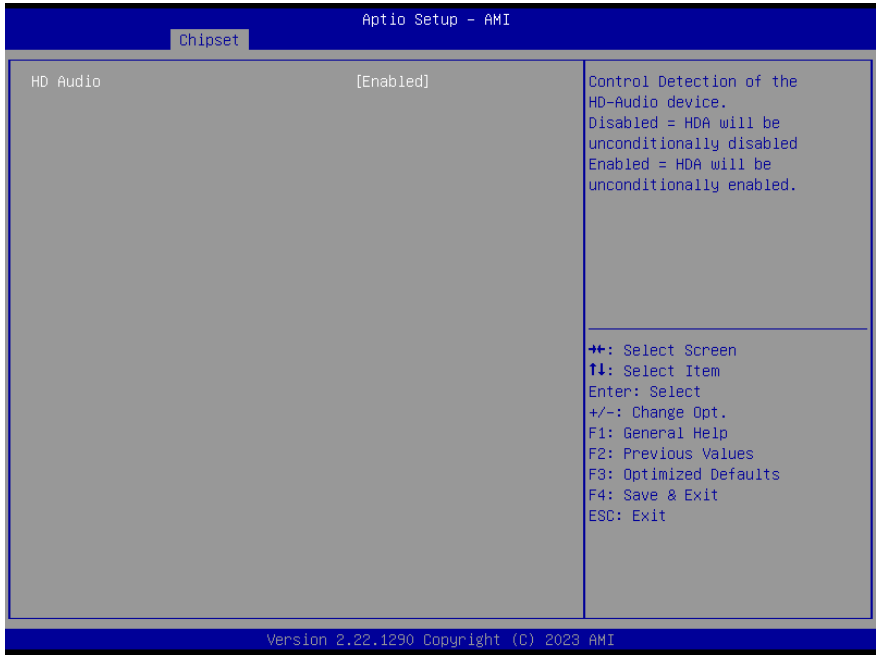

Options Summary		
HD Audio	Disabled	
	Enabled	Optimal Default, Failsafe Default
Control Detection of the HD-Audio device. Disabled = HDA will be unconditionally disabled. Enabled = HDA will be unconditionally enabled.		

3.6 Setup Submenu: Security



Change User/Supervisor Password

You can install a Supervisor password, and if you install a supervisor password, you can then install a user password. A user password does not provide access to many of the features in the Setup utility.

If you highlight these items and press Enter, a dialog box appears which lets you enter a password. You can enter no more than six letters or numbers. Press Enter after you have typed in the password. A second dialog box asks you to retype the password for confirmation. Press Enter after you have retyped it correctly. The password is required at boot time, or when the user enters the Setup utility.

Removing the Password

Highlight this item and type in the current password. At the next dialog box press Enter to disable password protection.

3.6.1 Secure Boot

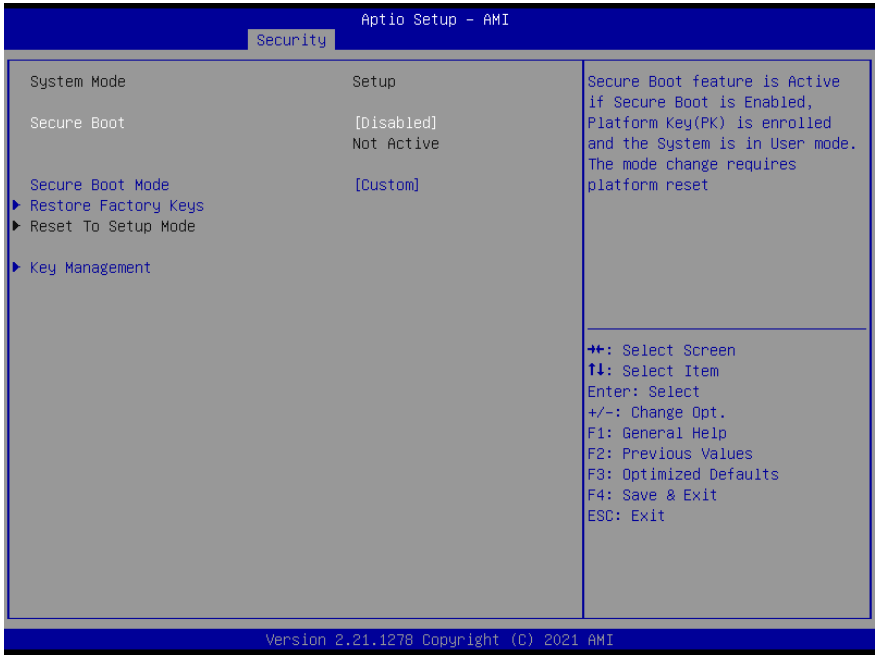

Options Summary		
Secure Boot	Disabled	Optimal Default, Failsafe Default
	Enabled	
Secure Boot feature is Active if Secure Boot is Enabled, Platform Key (PK) is enrolled and the System is in User mode. The mode change requires platform reset		
Secure Boot Mode	Custom	Optimal Default, Failsafe Default
	Standard	
Secure Boot mode options: Standard or Custom. In Custom mode, Secure Boot Policy variables can be configured by a physically present user without full authentication		
Restore Factory Keys		
Force System to User Mode. Install factory default Secure Boot key databases		
Reset to Setup Mode		
Delete all Secure Boot key databases from NVRAM		

3.6.2 Key Management

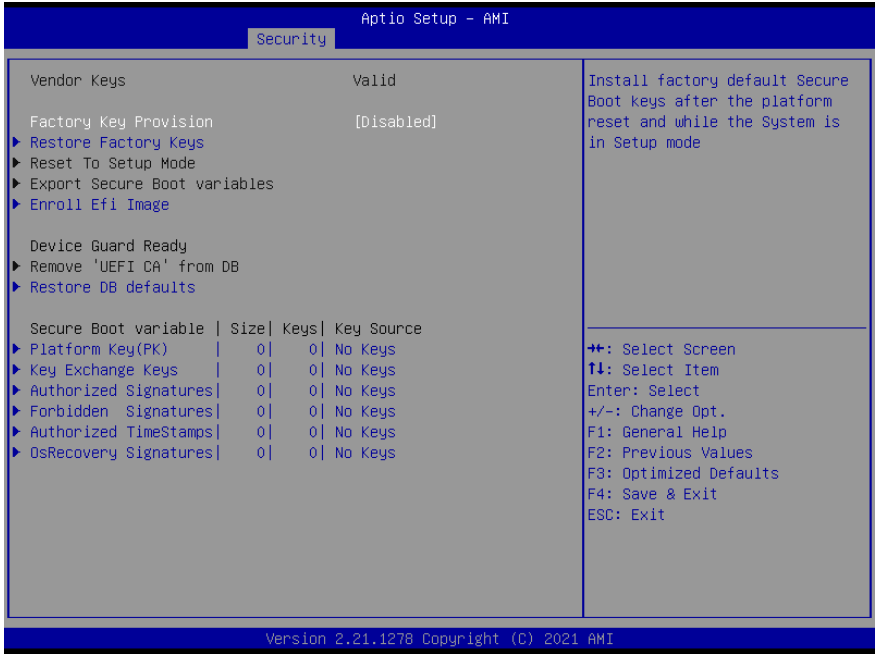

Options Summary		
Factory Key Provision	Disabled	Optimal Default, Failsafe Default
	Enabled	
Secure Boot feature is Active if Secure Boot is Enabled, Platform Key (PK) is enrolled and the System is in User mode. The mode change requires platform reset.		
Restore Factory Keys		
Force System to User Mode. Install factory default Secure Boot key databases.		
Reset to Setup Mode		
Delete all Secure Boot key databases from NVRAM.		
Export Secure Boot variables		
Copy NVRAM content of Secure Boot variables to files in a root folder on a file system device.		
Enroll Efi Image		
Allow the image to run in Secure Boot mode. Enroll SHA256 Hash certificate of a PE image into Authorized Signature Database (db).		
Remove 'UEFI CA' from DB		

Options Summary	
Device Guard ready system must not list 'Microsoft UEFI CA' Certificate in Authorized Signature database (db).	
Restore DB defaults	
Restore DB variable to factory defaults.	
Platform Key (PK)	Details
	Export
	Update
	Delete
Key Exchange Keys	Details
	Export
	Update
	Append
	Delete
Authorized Signatures	Details
	Export
	Update
	Append
	Delete
Forbidden Signatures	Details
	Export
	Update
	Append
	Delete
Authorized TimeStamps	Update
	Append
OsRecovery Signatures	Update
	Append
Enroll Factory Defaults or load certificates from a file: <ol style="list-style-type: none"> Public Key Certificate: <ol style="list-style-type: none"> EFI_SIGNATURE_LIST EFI_CERT_X509 (DER) EFI_CERT_RSA2048 (bin) EFI_CERT_SHAXXX Authenticated UEFI Variable EFI PE/COFF Image (SHA256) Key Source: Factory, External, Mixed.	

3.7 Setup Submenu: Boot

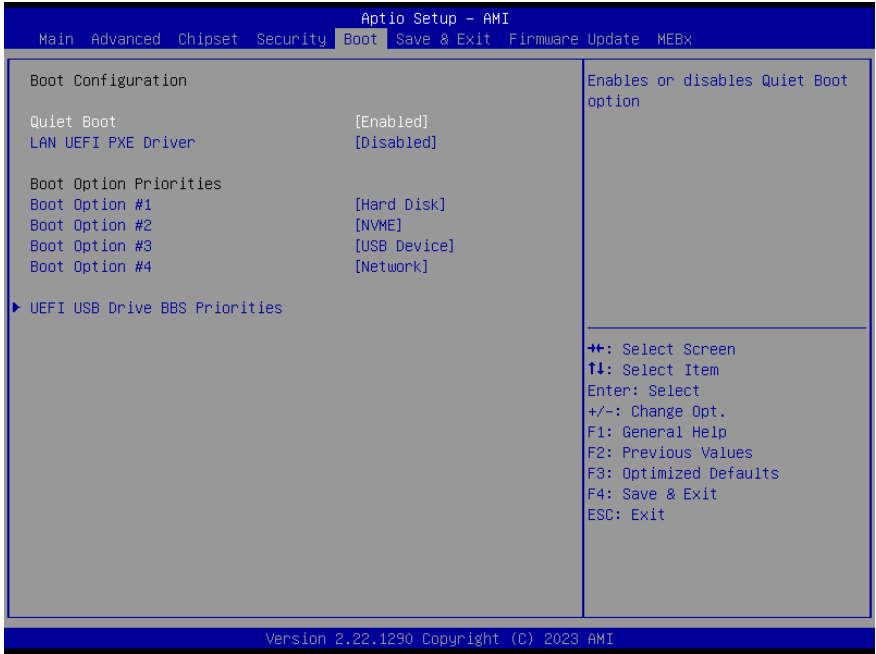

Options Summary		
Quiet Boot	Disabled	
	Enabled	Optimal Default, Failsafe Default
Enable or Disable Quiet Boot option.		
UEFI PXE Support	Disabled	Optimal Default, Failsafe Default
	Enabled	
Enable/Disable UEFI Network Stack.		
FIXED BOOT ORDER Priorities		
Sets the system boot order.		

3.7.1 BBS Priorities



3.8 Setup Submenu: Save & Exit

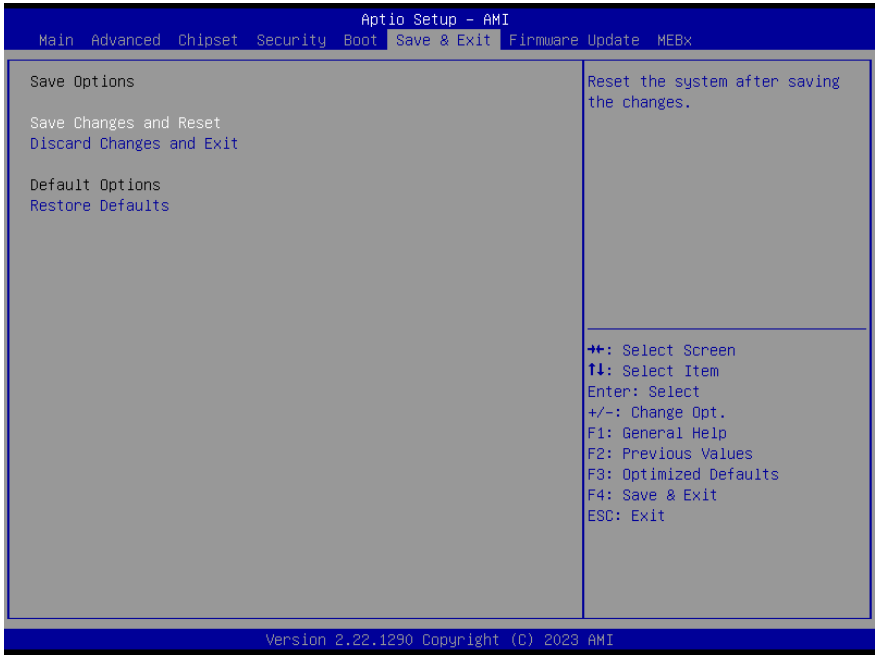

Options Summary	
Save Changes and Reset	Reset the system after saving the changes.
Discard Changes and Exit	Exit system setup without saving any changes.
Restore Defaults	Restore/Load Default values for all the setup options.

3.9 Setup Submenu: Firmware Update



Options Summary	
Select Image file	Select Image file for Firmware Update.
Update Image	Update selected firmware file to update.

3.10 Setup Submenu: MEBx



3.10.1 Intel® AMT Configuration

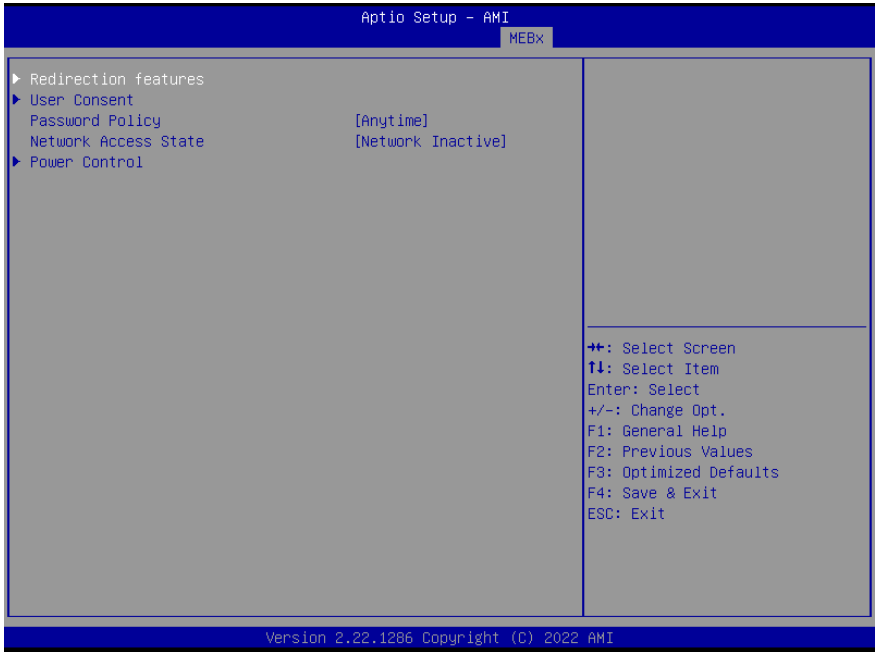

Options Summary

Password Policy	Default Password Only	
	During Setup and Configuration	
	Anytime	Optimal Default, Failsafe Default
Network Access State	Network Active	
	Network Inactive	Optimal Default, Failsafe Default
	Full Unprovision	

Changes network state of ME. When disabling, it will also clear some other settings.

3.10.2 Redirection features

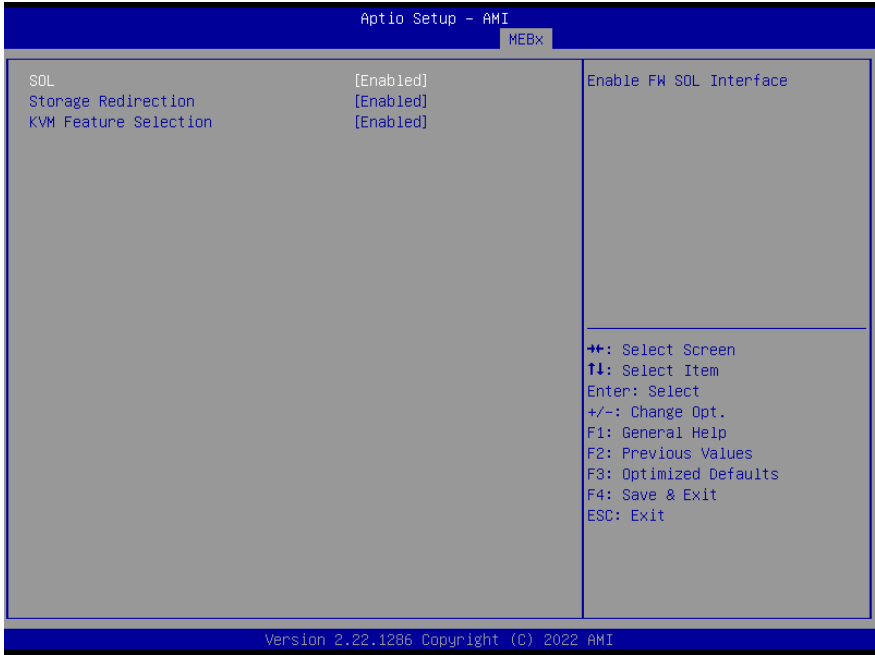

Options Summary		
SOL	Disabled	
	Enabled	Optimal Default, Failsafe Default
Enable FW SOL Interface.		
Storage Redirection	Disabled	
	Enabled	Optimal Default, Failsafe Default
Enable FW Remote – Storage Redirection.		
KVM Features Selection	Disabled	
	Enabled	Optimal Default, Failsafe Default
Enable FW KVM Feature.		

3.10.3 User Consent

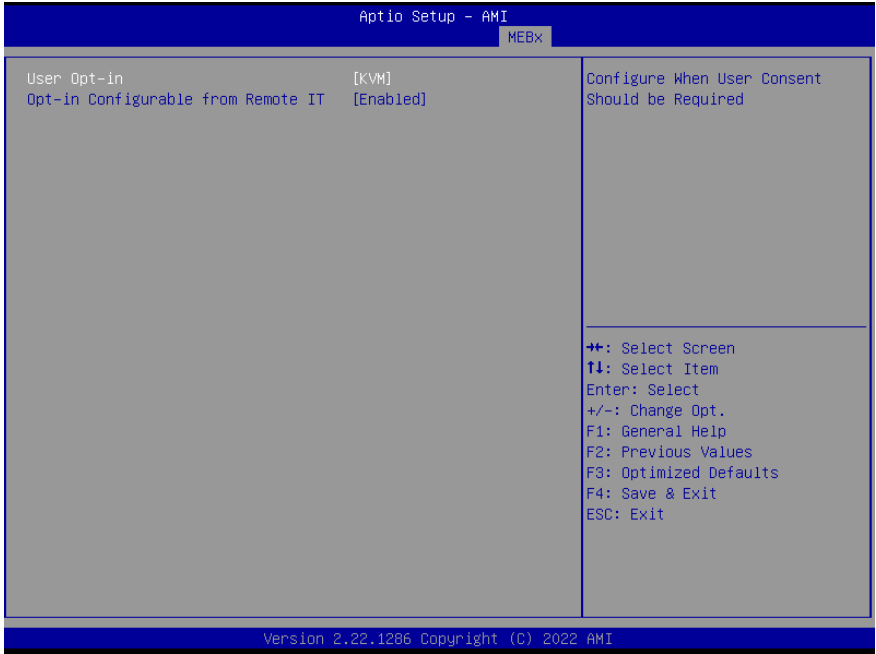

Options Summary		
User Opt-in	None	
	KVM	Optimal Default, Failsafe Default
	ALL	
Configure When User Consent Should be Required.		
Opt-in Configurable from Remote IT	Disabled	
	Enabled	Optimal Default, Failsafe Default
Enable/Disable Remote Change Capability of User Consent Feature.		

3.10.4 Power Control

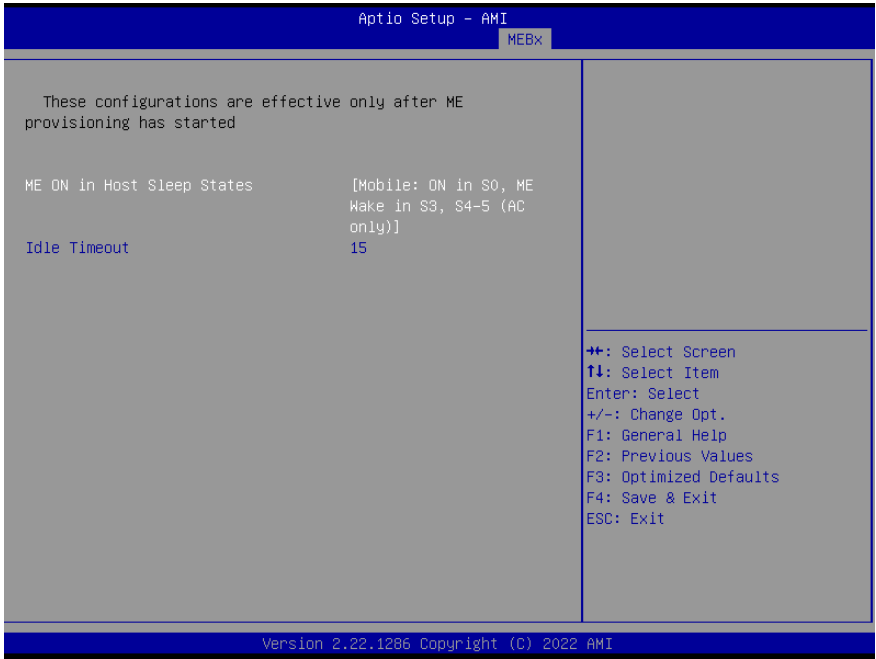

Options Summary		
ME ON in Host Sleep States	Mobile: ON in S0	Optimal Default, Failsafe Default
	Mobile: ON in S0, ME Wake in S3, S4-5(AC only)	
Idle Timeout	15	
Timeout Value (1-65536).		

Chapter 4

Driver Installation

4.1 Driver Download/Installation

Drivers for the GENE-RAP6 can be downloaded from the product page on the AAEON website by following this link:

<https://www.aaeon.com/en/p/sub-compact-boards-gene-rap6>

Download the driver(s) you need and follow the steps below to install them.

Audio Driver

1. Open the folder where you unzipped the **Audio Drivers**.
2. Run the **Setup.exe** in the folder.
3. Follow the instructions.
4. Drivers will be installed automatically.

Chipset Driver

1. Open the folder where you unzipped the **Chipset Drivers**.
2. Run the **SetupChipset.exe** file in the folder.
3. Follow the instructions.
4. Drivers will be installed automatically.

Graphics Driver

1. Open the folder where you unzipped the **Graphics Drivers**.
2. Run the **gfx_win_101.4502.exe** file in the folder.
3. Follow the instructions.
4. Drivers will be installed automatically.

LAN Drivers

1. Open the folder where you unzipped the **LAN Drivers**.
2. Run the **Autorun.exe** file in the folder.
3. Follow the instructions.
4. Drivers will be installed automatically.

Peripheral Drivers

A. Serial IO Driver

1. Open the folder where you unzipped the **Peripheral Drivers**.
2. Run the **SetupSerialIO.exe** file in the folder.
3. Follow the instructions.
4. Drivers will be installed automatically.

B. SST Drivers

1. Open the folder where you unzipped the **SST Drivers**.
2. Follow the instructions contained within the user guides.

ME & TXE Drivers

1. Open the folder where you unzipped the **ME & TXE Drivers**.
2. Run the **SetupME.exe** file in the folder.
3. Follow the instructions.
4. Drivers will be installed automatically.

Linux Peripheral Driver















1. Open the folder where you unzipped the **Linux Peripheral Drivers**.
2. Follow the instructions contained within the user guides.

Appendix A

I/O Information

A.1 I/O Address Map



































Input/output (IO)	
[0000000000000000 - 000000000000CF7]	PCI Express Root Complex
[0000000000000020 - 000000000000021]	Programmable interrupt controller
[0000000000000024 - 000000000000025]	Programmable interrupt controller
[0000000000000028 - 000000000000029]	Programmable interrupt controller
[000000000000002C - 00000000000002D]	Programmable interrupt controller
[000000000000002E - 00000000000002F]	Motherboard resources
[0000000000000030 - 000000000000031]	Programmable interrupt controller
[0000000000000034 - 000000000000035]	Programmable interrupt controller
[0000000000000038 - 000000000000039]	Programmable interrupt controller
[000000000000003C - 00000000000003D]	Programmable interrupt controller
[0000000000000040 - 000000000000043]	System timer
[000000000000004E - 00000000000004F]	Motherboard resources
[0000000000000050 - 000000000000053]	System timer
[0000000000000061 - 000000000000061]	Motherboard resources
[0000000000000063 - 000000000000063]	Motherboard resources
[0000000000000065 - 000000000000065]	Motherboard resources
[0000000000000067 - 000000000000067]	Motherboard resources
[0000000000000070 - 000000000000070]	Motherboard resources
[0000000000000080 - 000000000000080]	Motherboard resources
[0000000000000092 - 000000000000092]	Motherboard resources
[00000000000000A0 - 0000000000000A1]	Programmable interrupt controller
[00000000000000A4 - 0000000000000A5]	Programmable interrupt controller
[00000000000000A8 - 0000000000000A9]	Programmable interrupt controller
[00000000000000AC - 0000000000000AD]	Programmable interrupt controller
[00000000000000B0 - 0000000000000B1]	Programmable interrupt controller
[00000000000000B2 - 0000000000000B3]	Motherboard resources
[00000000000000B4 - 0000000000000B5]	Programmable interrupt controller
[00000000000000B8 - 0000000000000B9]	Programmable interrupt controller
[00000000000000BC - 0000000000000BD]	Programmable interrupt controller
[00000000000002E8 - 00000000000002EF]	Communications Port (COM4)
[00000000000002F8 - 00000000000002FF]	Communications Port (COM2)
[00000000000003E8 - 00000000000003EF]	Communications Port (COM3)
[00000000000003F8 - 00000000000003FF]	Communications Port (COM1)
[00000000000004D0 - 00000000000004D1]	Programmable interrupt controller
[0000000000000680 - 000000000000069F]	Motherboard resources
[0000000000000A00 - 0000000000000A0F]	Motherboard resources
[0000000000000A10 - 0000000000000A1F]	Motherboard resources
[0000000000000A20 - 0000000000000A2F]	Motherboard resources
[0000000000000D00 - 000000000000FFFF]	PCI Express Root Complex
[000000000000164E - 000000000000164F]	Motherboard resources



































	[000000000000680 - 00000000000069F] Motherboard resources
	[000000000000A00 - 000000000000A0F] Motherboard resources
	[000000000000A10 - 000000000000A1F] Motherboard resources
	[000000000000A20 - 000000000000A2F] Motherboard resources
	[000000000000D00 - 000000000000FFFF] PCI Express Root Complex
	[000000000000164E - 000000000000164F] Motherboard resources
	[0000000000001854 - 0000000000001857] Motherboard resources
	[0000000000002000 - 00000000000020FE] Motherboard resources
	[0000000000003000 - 000000000000303F] Intel(R) UHD Graphics
	[0000000000003060 - 000000000000307F] Standard SATA AHCI Controller
	[0000000000003080 - 0000000000003083] Standard SATA AHCI Controller
	[0000000000003090 - 0000000000003097] Standard SATA AHCI Controller
	[000000000000EFA0 - 000000000000EFBF] Intel(R) SMBus - 51A3
	[000000000000FFF8 - 000000000000FFFF] Intel(R) Active Management Technology - SOL (COM5)



































A.2 Memory Address Map

Memory	
[00000000000A0000 - 0000000000BFFFFF]	PCI Express Root Complex
[0000000050400000 - 00000000504FFFFF]	Intel(R) Ethernet Controller (3) I225-LM
[0000000050400000 - 00000000505FFFFF]	Intel(R) PCI Express Root Port #8 - 51BF
[0000000050400000 - 00000000BFFFFFFF]	PCI Express Root Complex
[0000000050500000 - 0000000050503FFF]	Intel(R) Ethernet Controller (3) I225-LM
[0000000050600000 - 000000005061FFFF]	Intel(R) Ethernet Connection (16) I219-LM
[0000000050620000 - 0000000050621FFF]	Standard SATA AHCI Controller
[0000000050622000 - 00000000506227FF]	Standard SATA AHCI Controller
[0000000050623000 - 00000000506230FF]	Standard SATA AHCI Controller
[00000000BFFFF000 - 00000000BFFFFFFF]	Intel(R) Active Management Technology - SOL (COM5)
[00000000C0000000 - 00000000CFFFFFFF]	Motherboard resources
[00000000FD690000 - 00000000FD69FFFF]	Intel(R) Serial IO GPIO Host Controller - INTC1055
[00000000FD6A0000 - 00000000FD6AFFFF]	Intel(R) Serial IO GPIO Host Controller - INTC1055
[00000000FD6D0000 - 00000000FD6DFFFF]	Intel(R) Serial IO GPIO Host Controller - INTC1055
[00000000FD6E0000 - 00000000FD6EFFFF]	Intel(R) Serial IO GPIO Host Controller - INTC1055
[00000000FE010000 - 00000000FE010FFF]	Intel(R) SPI (flash) Controller - 51A4
[00000000FED00000 - 00000000FED003FF]	High precision event timer
[00000000FED20000 - 00000000FED7FFFF]	Motherboard resources
[00000000FED40000 - 00000000FED44FFF]	Trusted Platform Module 2.0
[00000000FED45000 - 00000000FED8FFFF]	Motherboard resources
[00000000FED90000 - 00000000FED93FFF]	Motherboard resources
[00000000FEDA0000 - 00000000FEDA0FFF]	Motherboard resources
[00000000FEDA1000 - 00000000FEDA1FFF]	Motherboard resources
[00000000FEDC0000 - 00000000FEDC7FFF]	Motherboard resources
[00000000FEE00000 - 00000000FEEFFFFFFF]	Motherboard resources
[0000004000000000 - 000000400FFFFFFF]	Intel(R) UHD Graphics
[0000006000000000 - 0000006000FFFFFFF]	Intel(R) UHD Graphics
[0000006001100000 - 000000600110FFFF]	Intel(R) USB 3.10 eXtensible Host Controller - 1.20 (Microsoft)
[0000006001110000 - 000000600111FFFF]	Intel(R) USB 3.20 eXtensible Host Controller - 1.20 (Microsoft)
[0000006001120000 - 0000006001127FFF]	Performance Monitor
[0000006001130000 - 00000060011300FF]	Intel(R) SMBus - 51A3
[0000007FFFEF8000 - 0000007FFFEF8FFF]	Intel(R) Serial IO I2C Host Controller - 51E8
[0000007FFFEF9000 - 0000007FFFEF9FFF]	Intel(R) Serial IO I2C Host Controller - 51E9
[0000007FFFEFA000 - 0000007FFFEFAFFF]	Intel(R) Serial IO I2C Host Controller - 51E8
[0000007FFFEFB000 - 0000007FFFEFBFFF]	Intel(R) Management Engine Interface #1
[0000007FFFEFC000 - 0000007FFFEFFFFF]	Intel® Smart Sound Technology BUS
[0000007FFFEF0000 - 0000007FFFEFFFFF]	Intel® Smart Sound Technology BUS

A.3 IRQ Mapping Chart

▼  Interrupt request (IRQ)	
 (ISA) 0x00000000 (00)	System timer
 (ISA) 0x00000003 (03)	Communications Port (COM2)
 (ISA) 0x00000004 (04)	Communications Port (COM1)
 (ISA) 0x0000000B (11)	Communications Port (COM3)
 (ISA) 0x0000000B (11)	Communications Port (COM4)
 (ISA) 0x0000000E (14)	Intel(R) Serial IO GPIO Host Controller - INTC1055
 (ISA) 0x00000029 (41)	Trusted Platform Module 2.0
 (ISA) 0x00000037 (55)	Microsoft ACPI-Compliant System
 (ISA) 0x00000038 (56)	Microsoft ACPI-Compliant System
 (ISA) 0x00000039 (57)	Microsoft ACPI-Compliant System
 (ISA) 0x0000003A (58)	Microsoft ACPI-Compliant System
 (ISA) 0x0000003B (59)	Microsoft ACPI-Compliant System
 (ISA) 0x0000003C (60)	Microsoft ACPI-Compliant System
 (ISA) 0x0000003D (61)	Microsoft ACPI-Compliant System
 (ISA) 0x0000003E (62)	Microsoft ACPI-Compliant System
 (ISA) 0x0000003F (63)	Microsoft ACPI-Compliant System
 (ISA) 0x00000040 (64)	Microsoft ACPI-Compliant System
 (ISA) 0x00000041 (65)	Microsoft ACPI-Compliant System
 (ISA) 0x00000042 (66)	Microsoft ACPI-Compliant System
 (ISA) 0x00000043 (67)	Microsoft ACPI-Compliant System
 (ISA) 0x00000044 (68)	Microsoft ACPI-Compliant System
 (ISA) 0x00000045 (69)	Microsoft ACPI-Compliant System
 (ISA) 0x00000046 (70)	Microsoft ACPI-Compliant System
 (ISA) 0x00000047 (71)	Microsoft ACPI-Compliant System
 (ISA) 0x00000048 (72)	Microsoft ACPI-Compliant System
 (ISA) 0x00000049 (73)	Microsoft ACPI-Compliant System
 (ISA) 0x0000004A (74)	Microsoft ACPI-Compliant System
 (ISA) 0x0000004B (75)	Microsoft ACPI-Compliant System
 (ISA) 0x0000004C (76)	Microsoft ACPI-Compliant System
 (ISA) 0x0000004D (77)	Microsoft ACPI-Compliant System
 (ISA) 0x0000004E (78)	Microsoft ACPI-Compliant System
 (ISA) 0x0000004F (79)	Microsoft ACPI-Compliant System
 (ISA) 0x00000050 (80)	Microsoft ACPI-Compliant System
 (ISA) 0x00000051 (81)	Microsoft ACPI-Compliant System

 (ISA) 0x00000056 (86)	Microsoft ACPI-Compliant System
 (ISA) 0x00000057 (87)	Microsoft ACPI-Compliant System
 (ISA) 0x00000058 (88)	Microsoft ACPI-Compliant System
 (ISA) 0x00000059 (89)	Microsoft ACPI-Compliant System
 (ISA) 0x0000005A (90)	Microsoft ACPI-Compliant System
 (ISA) 0x0000005B (91)	Microsoft ACPI-Compliant System
 (ISA) 0x0000005C (92)	Microsoft ACPI-Compliant System
 (ISA) 0x0000005D (93)	Microsoft ACPI-Compliant System
 (ISA) 0x0000005E (94)	Microsoft ACPI-Compliant System
 (ISA) 0x0000005F (95)	Microsoft ACPI-Compliant System
 (ISA) 0x00000060 (96)	Microsoft ACPI-Compliant System
 (ISA) 0x00000061 (97)	Microsoft ACPI-Compliant System
 (ISA) 0x00000062 (98)	Microsoft ACPI-Compliant System
 (ISA) 0x00000063 (99)	Microsoft ACPI-Compliant System
 (ISA) 0x00000064 (100)	Microsoft ACPI-Compliant System
 (ISA) 0x00000065 (101)	Microsoft ACPI-Compliant System
 (ISA) 0x00000066 (102)	Microsoft ACPI-Compliant System
 (ISA) 0x00000067 (103)	Microsoft ACPI-Compliant System
 (ISA) 0x00000068 (104)	Microsoft ACPI-Compliant System
 (ISA) 0x00000069 (105)	Microsoft ACPI-Compliant System
 (ISA) 0x0000006A (106)	Microsoft ACPI-Compliant System
 (ISA) 0x0000006B (107)	Microsoft ACPI-Compliant System
 (ISA) 0x0000006C (108)	Microsoft ACPI-Compliant System
 (ISA) 0x0000006D (109)	Microsoft ACPI-Compliant System
 (ISA) 0x0000006E (110)	Microsoft ACPI-Compliant System
 (ISA) 0x0000006F (111)	Microsoft ACPI-Compliant System
 (ISA) 0x00000070 (112)	Microsoft ACPI-Compliant System
 (ISA) 0x00000071 (113)	Microsoft ACPI-Compliant System
 (ISA) 0x00000072 (114)	Microsoft ACPI-Compliant System
 (ISA) 0x00000073 (115)	Microsoft ACPI-Compliant System
 (ISA) 0x00000074 (116)	Microsoft ACPI-Compliant System
 (ISA) 0x00000075 (117)	Microsoft ACPI-Compliant System
 (ISA) 0x00000076 (118)	Microsoft ACPI-Compliant System
 (ISA) 0x00000077 (119)	Microsoft ACPI-Compliant System
 (ISA) 0x00000078 (120)	Microsoft ACPI-Compliant System

 (ISA) 0x00000077 (119)	Microsoft ACPI-Compliant System
 (ISA) 0x00000078 (120)	Microsoft ACPI-Compliant System
 (ISA) 0x00000079 (121)	Microsoft ACPI-Compliant System
 (ISA) 0x0000007A (122)	Microsoft ACPI-Compliant System
 (ISA) 0x0000007B (123)	Microsoft ACPI-Compliant System
 (ISA) 0x0000007C (124)	Microsoft ACPI-Compliant System
 (ISA) 0x0000007D (125)	Microsoft ACPI-Compliant System
 (ISA) 0x0000007E (126)	Microsoft ACPI-Compliant System
 (ISA) 0x0000007F (127)	Microsoft ACPI-Compliant System
 (ISA) 0x00000080 (128)	Microsoft ACPI-Compliant System
 (ISA) 0x00000081 (129)	Microsoft ACPI-Compliant System
 (ISA) 0x00000082 (130)	Microsoft ACPI-Compliant System
 (ISA) 0x00000083 (131)	Microsoft ACPI-Compliant System
 (ISA) 0x00000084 (132)	Microsoft ACPI-Compliant System
 (ISA) 0x00000085 (133)	Microsoft ACPI-Compliant System
 (ISA) 0x00000086 (134)	Microsoft ACPI-Compliant System
 (ISA) 0x00000087 (135)	Microsoft ACPI-Compliant System
 (ISA) 0x00000088 (136)	Microsoft ACPI-Compliant System
 (ISA) 0x00000089 (137)	Microsoft ACPI-Compliant System
 (ISA) 0x0000008A (138)	Microsoft ACPI-Compliant System
 (ISA) 0x0000008B (139)	Microsoft ACPI-Compliant System
 (ISA) 0x0000008C (140)	Microsoft ACPI-Compliant System
 (ISA) 0x0000008D (141)	Microsoft ACPI-Compliant System
 (ISA) 0x0000008E (142)	Microsoft ACPI-Compliant System
 (ISA) 0x0000008F (143)	Microsoft ACPI-Compliant System
 (ISA) 0x00000090 (144)	Microsoft ACPI-Compliant System
 (ISA) 0x00000091 (145)	Microsoft ACPI-Compliant System
 (ISA) 0x00000092 (146)	Microsoft ACPI-Compliant System
 (ISA) 0x00000093 (147)	Microsoft ACPI-Compliant System
 (ISA) 0x00000094 (148)	Microsoft ACPI-Compliant System
 (ISA) 0x00000095 (149)	Microsoft ACPI-Compliant System
 (ISA) 0x00000096 (150)	Microsoft ACPI-Compliant System
 (ISA) 0x00000097 (151)	Microsoft ACPI-Compliant System
 (ISA) 0x00000098 (152)	Microsoft ACPI-Compliant System
 (ISA) 0x00000099 (153)	Microsoft ACPI-Compliant System

Appendix B

Mating Connectors and Cables

B.1 Mating Connectors and Cables

Label	Function	Mating Connector		Cable P/N
		Vendor	Model no	
CN1	SATA Power	JST	PHR-2	1702150155
CN2	SATA	Molex	887505318	N/A
CN4	Power	N/A	N/A	170204010R
CN5	Audio with detect	Aces	50247-012H0H0-001	170X000156
CN9	Front Panel	ACES	50247-010H0H0-001	1709100108
CN11	COM Port 3/4	JST	SHDR-20V-S-B	170X000231
CN12	COM Port 1/2	JST	SHDR-20V-S-B	170X000231
CN13	USB Port 1/2	ACES	50247-010H0H0-001	170010010D
CN14	GPIO	MOLEX	51110-1050	N/A
CN15	USB Port 3/4	ACES	50247-010H0H0-001	170010010D
CN17	LVDS Inverter	JST	SHR-06V-S-B	170X000152
CN20	eDP	KEL	SSL20-30S	N/A
CN21	LVDS	Hirose	DF13-30DS-1.25C	170430030Y
CN22	I2C/SMBUS/Debug	JST	SHR-12V-S-B	1703120130
CN24	External RTC	Molex	51021-0200	175011301K
CN26	CPU FAN	Molex	47054-1000	N/A
CN28	LAN1 LED	Samtec	SFMC-103-01-L-D	N/A
CN35	FPC	N/A	N/A	170X000367
CN36	LAN2 LED	Samtec	SFMC-103-01-L-D	N/A