

GENE-KBU6

3.5" Subcompact Board

User's Manual 1st Ed

Copyright Notice

This document is copyrighted, 2021. All rights are reserved. The original manufacturer reserves the right to make improvements to the products described in this manual at any time without notice.

No part of this manual may be reproduced, copied, translated, or transmitted in any form or by any means without the prior written permission of the original manufacturer. Information provided in this manual is intended to be accurate and reliable. However, the original manufacturer assumes no responsibility for its use, or for any infringements upon the rights of third parties that may result from its use.

The material in this document is for product information only and is subject to change without notice. While reasonable efforts have been made in the preparation of this document to assure its accuracy, AAEMON assumes no liabilities resulting from errors or omissions in this document, or from the use of the information contained herein.

AAEMON reserves the right to make changes in the product design without notice to its users.

Acknowledgement

All other products' name or trademarks are properties of their respective owners.

- Microsoft Windows is a registered trademark of Microsoft Corp.
- Intel® and Celeron® are registered trademarks of Intel Corporation
- Intel Core™ is a trademark of Intel Corporation
- ITE is a trademark of Integrated Technology Express, Inc.
- IBM, PC/AT, PS/2, and VGA are trademarks of International Business Machines Corporation.

All other product names or trademarks are properties of their respective owners.

Packing List

Before setting up your product, please make sure the following items have been shipped:

Item	Quantity
GENE-KBU6MB	1
Heat Spreader	1

If any of these items are missing or damaged, please contact your distributor or sales representative immediately.

About this Document

This User's Manual contains all the essential information, such as detailed descriptions and explanations on the product's hardware and software features (if any), its specifications, dimensions, jumper/connector settings/definitions, and driver installation instructions (if any), to facilitate users in setting up their product.

Users may refer to the product page at AAEON.com for the latest version of this document.

Safety Precautions

Please read the following safety instructions carefully. It is advised that you keep this manual for future references

1. All cautions and warnings on the device should be noted.
2. Make sure the power source matches the power rating of the device.
3. Position the power cord so that people cannot step on it. Do not place anything over the power cord.
4. Always completely disconnect the power before working on the system's hardware.
5. No connections should be made when the system is powered as a sudden rush of power may damage sensitive electronic components.
6. If the device is not to be used for a long time, disconnect it from the power supply to avoid damage by transient over-voltage.
7. Always disconnect this device from any AC supply before cleaning.
8. While cleaning, use a damp cloth instead of liquid or spray detergents.
9. Make sure the device is installed near a power outlet and is easily accessible.
10. Keep this device away from humidity.
11. Place the device on a solid surface during installation to prevent falls
12. Do not cover the openings on the device to ensure optimal heat dissipation.
13. Watch out for high temperatures when the system is running.
14. Do not touch the heat sink or heat spreader when the system is running
15. Never pour any liquid into the openings. This could cause fire or electric shock.
16. As most electronic components are sensitive to static electrical charge, be sure to ground yourself to prevent static charge when installing the internal components. Use a grounding wrist strap and contain all electronic components in any static-shielded containers.

17. If any of the following situations arises, please contact our service personnel:
 - i. Damaged power cord or plug
 - ii. Liquid intrusion to the device
 - iii. Exposure to moisture
 - iv. Device is not working as expected or in a manner as described in this manual
 - v. The device is dropped or damaged
 - vi. Any obvious signs of damage displayed on the device
18. **DO NOT LEAVE THIS DEVICE IN AN UNCONTROLLED ENVIRONMENT WITH TEMPERATURES BEYOND THE DEVICE'S PERMITTED STORAGE TEMPERATURES (SEE CHAPTER 1) TO PREVENT DAMAGE.**

FCC Statement

Warning!



This device complies with Part 15 FCC Rules. Operation is subject to the following two conditions: (1) this device may not cause harmful interference, and (2) this device must accept any interference received including interference that may cause undesired operation.

Caution:

There is a danger of explosion if the battery is incorrectly replaced. Replace only with the same or equivalent type recommended by the manufacturer. Dispose of used batteries according to the manufacturer's instructions and your local government's recycling or disposal directives.

Attention:

Il y a un risque d'explosion si la batterie est remplacée de façon incorrecte. Ne la remplacer qu'avec le même modèle ou équivalent recommandé par le constructeur. Recycler les batteries usées en accord avec les instructions du fabricant et les directives gouvernementales de recyclage.

China RoHS Requirements (CN)

产品中有毒有害物质或元素名称及含量

AAEON Main Board/Daughter Board/Backplane

部件名称	有毒有害物质或元素					
	铅 (Pb)	汞 (Hg)	镉 (Cd)	六价铬 (Cr(VI))	多溴联苯 (PBB)	多溴二苯醚 (PBDE)
印刷电路板 及其电子组件	○	○	○	○	○	○
外部信号 连接器及线材	○	○	○	○	○	○
<p>○：表示该有毒有害物质在该部件所有均质材料中的含量均在 SJ/T 11363-2006 标准规定的限量要求以下。</p> <p>X：表示该有毒有害物质至少在该部件的某一均质材料中的含量超出 SJ/T 11363-2006 标准规定的限量要求。</p> <p>备注：此产品所标示之环保使用期限，系指在一般正常使用状况下。</p>						

China RoHS Requirement (EN)

Poisonous or Hazardous Substances or Elements in Products
AAEON Main Board/Daughter Board/Backplane

Component	Poisonous or Hazardous Substances or Elements					
	Lead (Pb)	Mercury (Hg)	Cadmium (Cd)	Hexavalent Chromium (Cr(VI))	Polybrominated Biphenyls (PBB)	Polybrominated Diphenyl Ethers (PBDE)
PCB & Other Components	○	○	○	○	○	○
Wires & Connectors for External Connections	○	○	○	○	○	○
<p>O: The quantity of poisonous or hazardous substances or elements found in each of the component's parts is below the SJ/T 11363-2006-stipulated requirement.</p> <p>X: The quantity of poisonous or hazardous substances or elements found in at least one of the component's parts is beyond the SJ/T 11363-2006-stipulated requirement.</p> <p>Note: The Environment Friendly Use Period as labeled on this product is applicable under normal usage only</p>						

Table of Contents

Chapter 1 - Product Specifications	1
1.1 Specifications	2
1.2 Block Diagram	5
Chapter 2 – Hardware Information	6
2.1 Dimensions	7
2.2 Jumpers and Connectors	9
2.3 List of Jumpers	10
2.3.1 Clear CMOS Jumper (JP1)	10
2.3.2 LVDS Port Backlight Inverter VCC Selection (JP2).....	10
2.3.3 LVDS Port Backlight Lightness Control Mode Selection (JP3).....	11
2.3.4 LVDS Port Operating VDD Selection (JP4)	11
2.3.5 mSATA/ Mini- Card Operating VCC Selection (JP5)	11
2.3.6 Touch Screen 4,5,8 Wire Selection (JP6)	11
2.3.7 Auto Power Button Enable/Disable Selection (JP7)	11
2.3.8 COM3 Pin8 Function Selection (JP8).....	12
2.3.9 COM2 Pin8 Function Selection (JP9).....	12
2.3.10 Front Panel Connector (JP10).....	12
2.3.11 COM4 Pin8 Function Selection (JP11)	13
2.4 List of Connectors.....	14
2.4.1 Battery (CN1)	15
2.4.2 DVI-I (Digital and Analog) (CN3).....	15
2.4.3 DP Port (CN5).....	16
2.4.4 LVDS Port (CN6)	18
2.4.5 LVDS Port Inverter / Backlight Connector (CN7).....	19
2.4.6 SPI Debug Port (CN8)	20
2.4.7 LAN (RJ-45) Port1 (CN9)	21

2.4.8	LAN (RJ-45) Port2 (CN10)	21
2.4.9	Mini-Card Slot (Full-Mini Card) (CN11)	22
2.4.10	Micro SIM Card Socket (CN12)	24
2.4.11	Mini-Card Slot (Half-Mini Card) (CN13)	25
2.4.12	SATA Port 1 (CN14)	27
2.4.13	+5V Output for SATA HDD (CN15).....	28
2.4.14	USB 3.0 Ports (CN18).....	28
2.4.15	USB 3.0 Ports (CN19).....	29
2.4.16	USB 2.0 Port (CN20).....	31
2.4.17	USB 2.0 Port (CN21)	31
2.4.18	Audio I/O Port (CN22).....	32
2.4.19	Touchscreen Connector (CN23)	33
2.4.20	Digital I/O Port (CN24)	36
2.4.21	COM Port 1 (CN25)	37
2.4.22	COM Port 4 (CN26).....	38
2.4.23	COM Port 2 (CN27).....	41
2.4.24	COM Port 3 (CN28).....	44
2.4.25	LPC Port (CN29)	47
2.4.26	External Power Input (CN30)	48
2.4.27	+5VSB Output w/SMBus (CN32).....	48
2.4.28	External +5VSB Input (CN33)	49
2.4.29	BIO Connector (CN35).....	49
2.4.30	CPU Fan (CN36)	53
2.5	Thermal Solutions	54
2.5.1	GENE-KBU6-HSK02.....	54
2.5.2	GENE-KBU6-FAN01.....	56
2.5.3	GENE-KBU6-HSK03.....	58

Chapter 3 - AMI BIOS Setup.....	59
--	-----------

3.1	System Test and Initialization	60
3.2	AMI BIOS Setup.....	61
3.3	Setup Submenu: Main.....	62
3.4	Setup Submenu: Advanced	63
3.4.1	CPU Configuration	64
3.4.2	Trusted Computing	65
3.4.3	SATA Configuration	67
3.4.4	Hardware Monitor.....	69
3.4.4.1	Smart Fan Mode Configuration	70
3.4.5	SIO Configuration	72
3.4.5.1	Serial Port 1 Configuration	73
3.4.5.2	Serial Port 2 Configuration.....	74
3.4.5.3	Serial Port 3 Configuration.....	75
3.4.5.4	Serial Port 4 Configuration.....	76
3.4.6	USB Configuration.....	77
3.4.7	Digital IO Port Configuration.....	78
3.4.8	Power Management.....	79
3.4.9	Compatibility Support Module Configuration	81
3.5	Setup Submenu: Chipset.....	82
3.5.1	System Agent (SA) Configuration	83
3.5.1.1	Graphics Configuration	84
3.5.2	PCH-IO Configuration	87
3.6	Setup Submenu: Security	89
3.6.1	Secure Boot.....	90
3.6.1.1	Key Management	91
3.7	Setup submenu: Boot.....	92
3.8	Setup submenu: Save & Exit	93
Chapter 4 – Drivers Installation		94

4.1	Driver Download/Installation	95
4.2	Note on EHCI.....	97
Appendix A - Watchdog Timer Programming		98
A.1	Watchdog Timer Registers.....	99
A.2	Watchdog Sample Program	100
Appendix B - I/O Information		103
B.1	I/O Address Map.....	104
B.2	Memory Address Map.....	106
B.3	IRQ Mapping Chart.....	107
Appendix C – Electrical Specifications for I/O Ports		118
C.1	Electrical Specifications for I/O Ports.....	119
Appendix D – Digital I/O Ports.....		120
D.1	Electrical Specifications for Digital I/O Ports	121
D.2	DI/O Programming	122
D.3	Digital I/O Register	123
D.4	Digital I/O Sample Program.....	124
Appendix E – Mating Connectors and Cables.....		127
E.1	Mating Connectors and Cables	128

Chapter 1

Product Specifications

1.1 Specifications

System

Form Factor	3.5" Sub-Compact Board
CPU	7th Generation Intel® Core™/ Celeron® Processor: Core i7-7600U (2C/4T 2.80 GHz, up to 3.90 GHz) Core i5-7300U (2C/4T 2.60 GHz, up to 3.50 GHz) Core i3-7100U (2C/4T, 2.40 GHz) Celeron® 3965U (2C/2T, 2.20 GHz)
CPU TDP	Core i7-7600U: 15W up to 25W Core i5-7300U: 15W up to 25W Core i3-7100U: 15W Celeron® 3965U: 15W
Chipset	Integrated with Intel® SoC
Memory Type	DDR4 up to 2133MHz, SODIMM x 1, up to 16GB, Non-ECC
BIOS	UEFI
Wake on LAN	Yes
Watchdog Timer	255 Levels
Security	TPM 2.0 (Optional)
RTC Battery	Lithium Battery 3V/240 mAh
Dimensions (L x W)	5.75" x 4" (146mm x 101.7mm)

Power

Power Requirement	+9~36V (Optional: +12V)
Power Supply Type	AT/ATX
Connector	Phoenix 2-pin Connector

Power

Power Consumption (Typical)	3.26A at +12V with Intel® Core™ i7-7600U, DDR4 2666MHz 32GB
Power Consumption (Max)	4.22A at +12V with Intel® Core™ i7-7600U, DDR4 2666MHz 32GB

Display

Controller	Intel® HD Graphics 510/620
LVDS/eDP	LVDS Dual Channel 18/24-bit x 1
Display Interface	DP1.2 x 1 + DVI-D x 1 (default) Optional: DVI-I x 1 (with VGA signal)
Multiple Display Support	Up to 3 Simultaneous Displays

Audio

Codec	Realtek ALC897/892
Audio Interface	Line-in/Line-out/Mic
Speaker	—

External I/O

Ethernet	Intel® i210/i211, 10/100/1000 Base-TX, RJ-45 x 2
USB	USB3.2 Gen 1 x 4
Serial Port	—
Video	DP1.2 x 1 DVI-D x 1

Internal I/O

USB	USB2.0 x 2
Serial Port	COM1 (RS232) COM2, COM3, COM4 (RS232/422/485, supports 5V/12V/RI)
Video	LVDS x 1
SATA	SATA III x 1 +5V SATA Power Connector x 1
Audio	Audio Header x 1
DIO/GPIO	8-bit
SMBus/I2C	SMBus x 1
Touch	4/5/8-wire Touch Controller x 1 (optional)
Fan	DC Fan x 1 (optional: Smart Fan)
SIM	Micro SIM x 1 (optional)
Front Panel	HDD LED, Power LED, Power Button, Buzzer, Reset Button
Others	—

Expansion

Mini PCIe/ mSATA	Full-Size mPCIe x 1 Half-Size mSATA/mPCIe x 1 (Default mSATA, select by BIOS)
M.2	—
BIO	BIO x 1

Environment

Operating Temperature	32°F ~ 140°F (0°C ~ 60°C)
Storage Temperature	-40°F ~ 176°F (-40°C ~ 80°C)

Environment

Operating Humidity	0% ~ 90% relative humidity, non-condensing
MTBF (Hours)	375,577
EMC Certification	CE/FCC Class A

1.2 Block Diagram

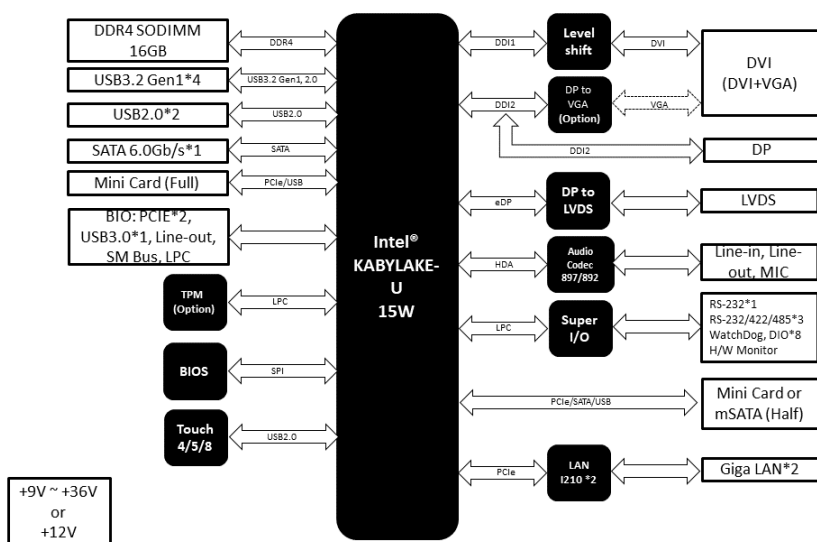

Chapter 2

Hardware Information

2.1 Dimensions

Component Side

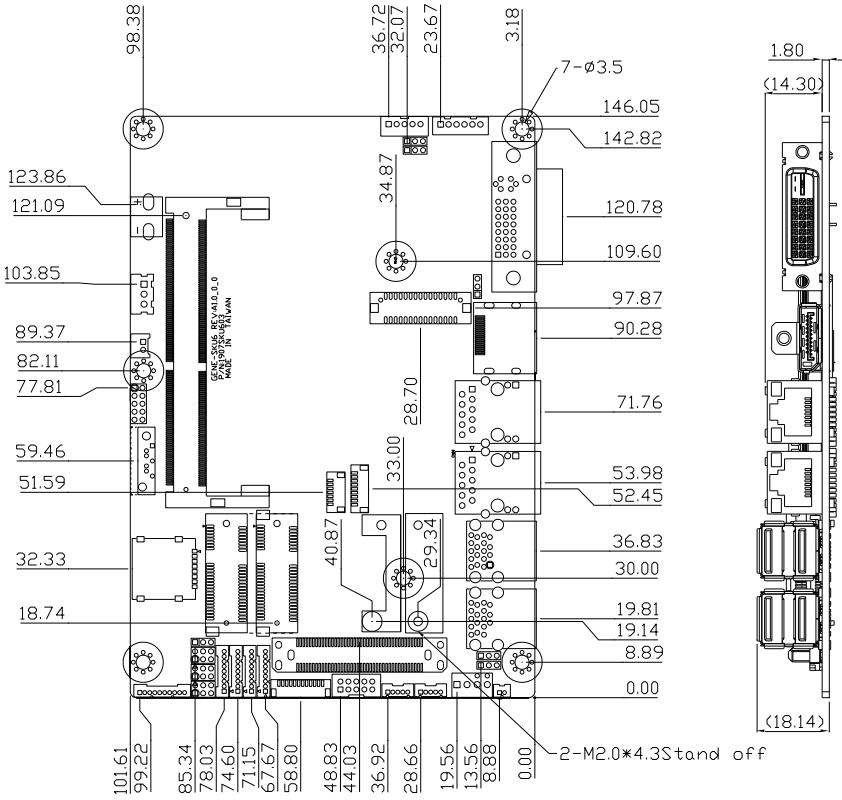

Solder Side (with heat spreader)

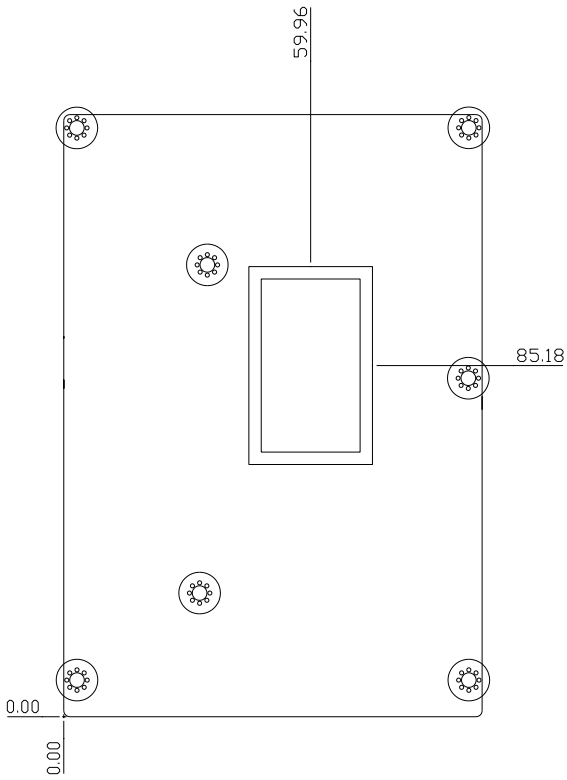

Solder Side

2.2 Jumpers and Connectors

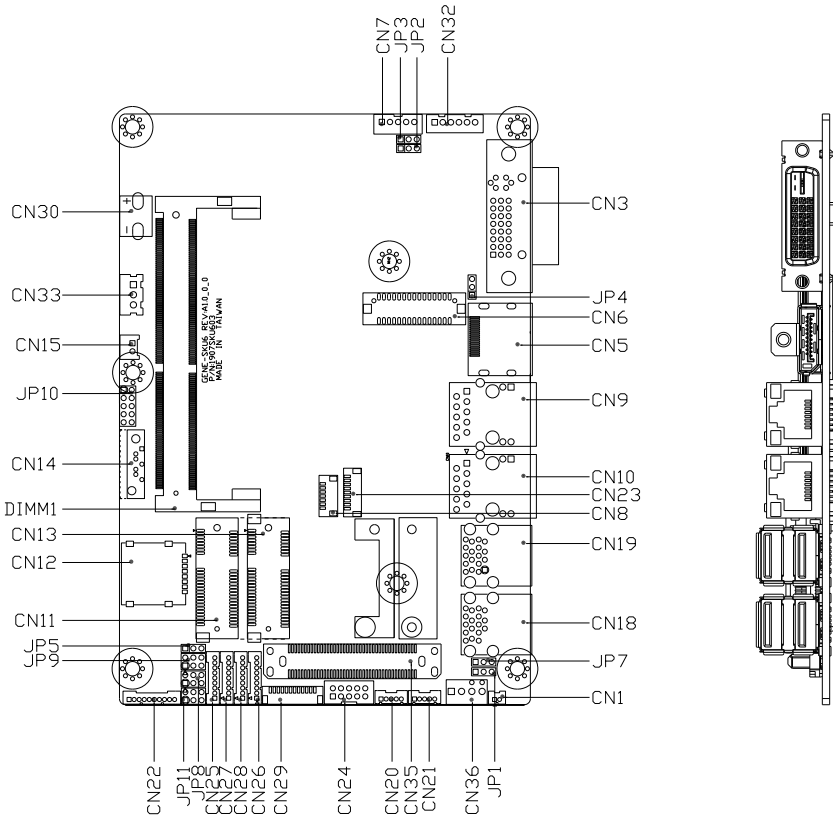

2.3 List of Jumpers

Please refer to the table below for all of the board's jumpers that you can configure for your application

Label	Function
JP1	Clear CMOS Jumper
JP2	LVDS Port Backlight Inverter VCC Selection
JP3	LVDS Port Backlight Lightness Control Mode Selection
JP4	LVDS Port Operating VDD Selection
JP5	mSATA/Mini-Card Operating VCC Selection
JP6	Touch Screen 4/5/8-wire Mode Selection
JP7	Auto Power Button Enable/Disable Selection
JP8	COM3 Pin8 Function Selection
JP9	COM2 Pin8 Function Selection
JP10	Front Panel Connector
JP11	COM4 Pin8 Function Selection

2.3.1 Clear CMOS Jumper (JP1)

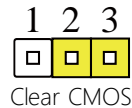
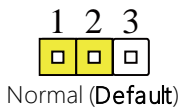

2.3.2 LVDS Port Backlight Inverter VCC Selection (JP2)

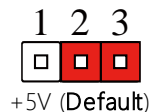
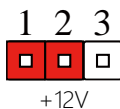

2.3.3 LVDS Port Backlight Lightness Control Mode Selection (JP3)

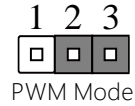
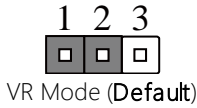

2.3.4 LVDS Port Operating VDD Selection (JP4)

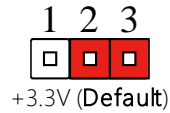
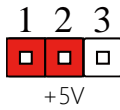

2.3.5 mSATA/ Mini-Card Operating VCC Selection (JP5)

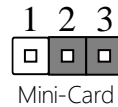
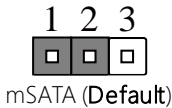

2.3.6 Touch Screen 4,5,8 Wire Selection (JP6)

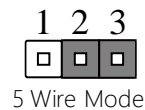
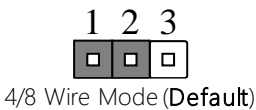

2.3.7 Auto Power Button Enable/Disable Selection (JP7)

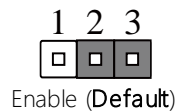
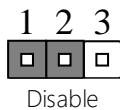

Note: When disabled, use power button JP10(1-2) to power on the system.

2.3.8 COM3 Pin8 Function Selection (JP8)

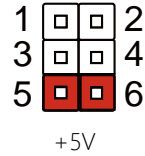
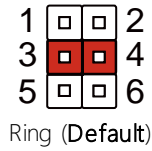
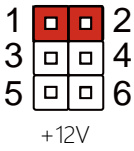

2.3.9 COM2 Pin8 Function Selection (JP9)

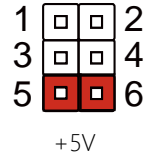
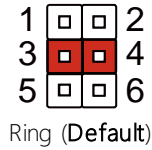
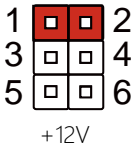

2.3.10 Front Panel Connector (JP10)

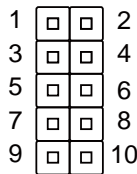

Pin	Pin Name	Pin	Pin Name
1	PWR_BTN-	2	PWR_BTN+
3	HDD_LED-	4	HDD_LED+
5	BUZZER-	6	BUZZER+
7	PWR_LED-	8	PWR_LED+
9	H/W RESET-	10	H/W RESET+

2.3.11 COM4 Pin8 Function Selection (JP11)

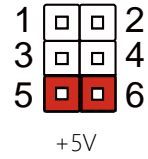
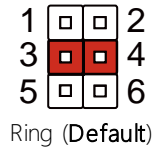
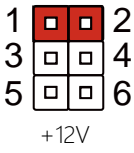

2.4 List of Connectors

Please refer to the table below for all of the board's connectors that you can configure for your application

Label	Function
CN1	Battery
CN3	DVI-I (Digital and Analog)
CN5	DP Port
CN6	LVDS Port
CN7	LVDS Port Inverter / Backlight Connector
CN8	SPI Debug Port
CN9	LAN (RJ-45) Port1
CN10	LAN (RJ-45) Port2
CN11	Mini-Card Slot (Full-Mini Card)
CN12	Micro SIM Card Socket
CN13	Mini-Card Slot (Half-Mini Card)
CN14	SATA Port
CN15	+5V Output for SATA HDD
CN18	USB 3.0 Ports
CN19	USB 3.0 Ports
CN20	USB 2.0 Port
CN21	USB 2.0 Port
CN22	Audio I/O Port
CN23	Touch Screen Connector
CN24	Digital IO Port
CN25	COM Port 1
CN26	COM Port 4
CN27	COM Port 2

Label	Function
CN28	COM Port 3
CN29	LPC Port
CN30	External Power Input
CN32	+5VSB Output w/SMBus
CN33	External +5VSB Input
CN35	BIO Connector
CN36	CPU FAN

2.4.1 Battery (CN1)

Pin	Pin Name	Signal Type	Signal Level
1	+3.3V	PWR	3.3V
2	GND	GND	

2.4.2 DVI-I (Digital and Analog) (CN3)

Pin	Pin Name	Signal Type	Signal Level
1	DVI_D2-	OUT	
2	DVI_D2+	OUT	
3	GND	GND	
4	VGA_DDC_CLK	I/O	
5	VGA_DDC_DAT	I/O	
6	SCL	I/O	
7	SDA	I/O	
8	VGA_VSYNC	OUT	
9	DVI_D1-	OUT	
10	DVI_D1+	OUT	

Pin	Pin Name	Signal Type	Signal Level
11	GND	GND	
12	NC		
13	NC		
14	+5V	PWR	+5V
15	GND	GND	
16	HPD	IN	
17	DVI_D0-	OUT	
18	DVI_D0+	OUT	
19	GND	GND	
20	NC		
21	NC		
22	GND	GND	
23	DVI_CLK+	OUT	
24	DVI_CLK-	OUT	
C1	VGA_RED	OUT	
C2	VGA_GREEN	OUT	
C3	VGA_BLUE	OUT	
C4	VGA_HSYNC	OUT	

2.4.3 DP Port (CN5)

Pin	Pin Name	Signal Type	Signal Level
1	DP_D0+	DIFF	
2	GND	GND	
3	DP_D0-	DIFF	
4	DP_D1+	DIFF	
5	GND	GND	

Pin	Pin Name	Signal Type	Signal Level
6	DP_D1-	DIFF	
7	DP_D2+	DIFF	
8	GND	GND	
9	DP_D2-	DIFF	
10	DP_D3+	DIFF	
11	GND	GND	
12	DP_D3-	DIFF	
13	GND	GND	
14	GND	GND	
15	DP_AUX+	DIFF	
16	GND	GND	
17	DP_AUX-	DIFF	
18	HPLG_DETECT	IN	
19	GND	GND	
20	+5V	I/O	+5V

2.4.4 LVDS Port (CN6)

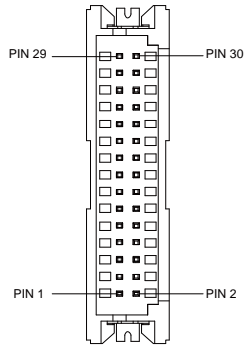

Note: LVDS_LCD_PWR can be set to +3.3V or +5V by JP4. Driving Current supports up to 1.5A

Pin	Pin Name	Signal Type	Signal Level
1	BKL_ENABLE	OUT	
2	BKL_CONTROL	OUT	
3	LCD_PWR	PWR	+3.3V/+5V
4	GND	GND	
5	LVDS_A_CLK-	DIFF	
6	LVDS_A_CLK+	DIFF	
7	LCD_PWR	PWR	+3.3V/+5V
8	GND	GND	
9	LVDS_DA0-	DIFF	
10	LVDS_DA0+	DIFF	
11	LVDS_DA1-	DIFF	
12	LVDS_DA1+	DIFF	
13	LVDS_DA2-	DIFF	
14	LVDS_DA2+	DIFF	

Pin	Pin Name	Signal Type	Signal Level
15	LVDS_DA3-	DIFF	
16	LVDS_DA3+	DIFF	
17	DDC_DATA	I/O	+3.3V
18	DDC_CLK	I/O	+3.3V
19	LVDS_DB0-	DIFF	
20	LVDS_DB0+	DIFF	
21	LVDS_DB1-	DIFF	
22	LVDS_DB1+	DIFF	
23	LVDS_DB2-	DIFF	
24	LVDS_DB2+	DIFF	
25	LVDS_DB3-	DIFF	
26	LVDS_DB3+	DIFF	
27	LCD_PWR	PWR	+3.3V/+5V
28	GND	GND	
29	LVDS_B_CLK-	DIFF	
30	LVDS_B_CLK+	DIFF	

2.4.5 LVDS Port Inverter / Backlight Connector (CN7)

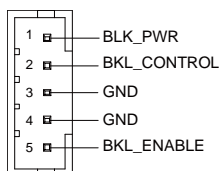

Pin	Pin Name	Signal Type	Signal Level
1	BKL_PWR	PWR	+5V / +12V
2	BKL_CONTROL	OUT	

Pin	Pin Name	Signal Type	Signal Level
3	GND	GND	
4	GND	GND	
5	BKL_ENABLE	OUT	+5V

Note 1: LVDS BKL_PWR can be set to +5V or +12V by JP2. Driving current supports up to 2A.

Note 2: LVDS BKL_CONTROL can be set by JP3

2.4.6 SPI Debug Port (CN8)

Pin	Pin Name	Signal Type	Signal Level
1	SPI_MISO	OUT	
2	GND	GND	
3	SPI_CLK	IN	
4	+3.3VSB	PWR	+3.3V
5	SPI_MOSI	IN	
6	SPI_CS	IN	
7	NC		

2.4.7 LAN (RJ-45) Port1 (CN9)

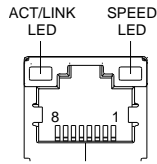

Pin	Pin Name	Signal Type	Signal level
1	MDI0+	DIFF	
2	MDI0-	DIFF	
3	MDI1+	DIFF	
4	MDI2+	DIFF	
5	MDI2-	DIFF	
6	MDI1-	DIFF	
7	MDI3+	DIFF	
8	MDI3-	DIFF	

2.4.8 LAN (RJ-45) Port2 (CN10)

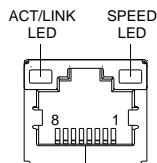

Pin	Pin Name	Signal Type	Signal level
1	MDI0+	DIFF	
2	MDI0-	DIFF	
3	MDI1+	DIFF	

Pin	Pin Name	Signal Type	Signal level
4	MDI2+	DIFF	
5	MDI2-	DIFF	
6	MDI1-	DIFF	
7	MDI3+	DIFF	
8	MDI3-	DIFF	

2.4.9 Mini-Card Slot (Full-Mini Card) (CN11)

Pin	Pin Name	Signal Type	Signal Level
1	PCIE_WAKE#	IN	
2	+3.3VSB	PWR	+3.3V
3	NC		
4	GND	GND	
5	NC		
6	+1.5V	PWR	+1.5V
7	PCIE_CLK_REQ#	IN	
8	UIM_PWR	PWR	
9	GND	GND	
10	UIM_DATA	I/O	
11	PCIE_REF_CLK-	DIFF	
12	UIM_CLK	IN	
13	PCIE_REF_CLK+	DIFF	
14	UIM_RST	IN	
15	GND	GND	
16	UIM_VPP	PWR	
17	NC		

Pin	Pin Name	Signal Type	Signal Level
18	GND	GND	
19	NC		
20	W_DISABLE#	OUT	+3.3V
21	GND	GND	
22	PCIE_RST#	OUT	+3.3V
23	PCIE_RX-	DIFF	
24	+3.3VSB	PWR	+3.3V
25	PCIE_RX+	DIFF	
26	GND	GND	
27	GND	GND	
28	+1.5V	PWR	+1.5V
29	GND	GND	
30	SMB_CLK	I/O	+3.3V
31	PCIE_TX-	DIFF	
32	SMB_DATA	I/O	+3.3V
33	PCIE_TX+	DIFF	
34	GND	GND	
35	GND	GND	
36	USB_D-	DIFF	
37	GND	GND	
38	USB_D+	DIFF	
39	+3.3VSB	PWR	+3.3V
40	GND	GND	
41	+3.3VSB	PWR	+3.3V
42	NC		
43	GND	GND	

Pin	Pin Name	Signal Type	Signal Level
44	NC		
45	NC		
46	NC		
47	NC		
48	+1.5V	PWR	+1.5V
49	NC		
50	GND	GND	
51	NC		
52	+3.3VSB	PWR	+3.3V

2.4.10 Micro SIM Card Socket (CN12)

Pin	Pin Name	Signal Type	Signal Level
1	UIM_PWR	PWR	
2	UIM_RST	IN	
3	UIM_CLK	IN	
4	NC		
5	GND	GND	
6	UIM_VPP	PWR	
7	UIM_DATA	I/O	
8	NC		

2.4.11 Mini-Card Slot (Half-Mini Card) (CN13)

Pin	Pin Name	Signal Type	Signal Level
1	PCIE_WAKE#	IN	
2	+3.3VSB	PWR	+3.3V
3	NC		
4	GND	GND	
5	NC		
6	+1.5V	PWR	+1.5V
7	PCIE_CLK_REQ#	IN	
8	NC		
9	GND	GND	
10	NC		
11	PCIE_REF_CLK-	DIFF	
12	NC		
13	PCIE_REF_CLK+	DIFF	
14	NC		
15	GND	GND	
16	NC		
17	NC		
18	GND	GND	
19	NC		
20	W_DISABLE#	OUT	+3.3V
21	GND	GND	
22	PCIE_RST#	OUT	+3.3V
23	PCIE_RX-/mSATA_RX+	DIFF	
24	+3.3VSB	PWR	+3.3V

Pin	Pin Name	Signal Type	Signal Level
25	PCIE_RX+/mSATA_RX-	DIFF	
26	GND	GND	
27	GND	GND	
28	+1.5V	PWR	+1.5V
29	GND	GND	
30	SMB_CLK	I/O	+3.3V
31	PCIE_TX-/mSATA_TX-	DIFF	
32	SMB_DATA	I/O	+3.3V
33	PCIE_TX+/mSATA_TX+	DIFF	
34	GND	GND	
35	GND	GND	
36	USB_D-	DIFF	
37	GND	GND	
38	USB_D+	DIFF	
39	+3.3VSB	PWR	+3.3V
40	GND	GND	
41	+3.3VSB	PWR	+3.3V
42	NC		
43	GND	GND	
44	NC		
45	NC		
46	NC		
47	NC		
48	+1.5V	PWR	+1.5V
49	NC		
50	GND	GND	

Pin	Pin Name	Signal Type	Signal Level
51	NC		
52	+3.3VSB	PWR	+3.3V

Note: CN13 can be selected for Mini-Card or mSATA by changing BIOS

2.4.12 SATA Port 1 (CN14)

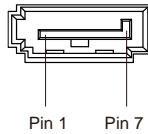

Pin	Pin Name	Signal Type	Signal Level
1	GND	GND	
2	SATA_TX+	DIFF	
3	SATA_TX-	DIFF	
4	GND	GND	
5	SATA_RX-	DIFF	
6	SATA_RX+	DIFF	
7	GND	GND	

2.4.13 +5V Output for SATA HDD (CN15)

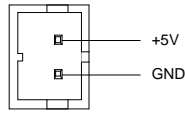

Pin	Pin Name	Signal Type	Signal Level
1	+5V	PWR	+5V
2	GND	GND	

Note: +5V Output for SATA HDD, driving current supports up to 1A

2.4.14 USB 3.0 Ports (CN18)

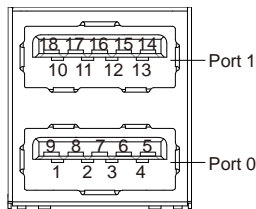

Pin	Pin Name	Signal Type	Signal Level
1	+5VSB	PWR	+5V
2	USB_D-	DIFF	
3	USB_D+	DIFF	
4	GND	GND	
5	USB_SSRX-	DIFF	
6	USB_SSRX+	DIFF	
7	GND	GND	

Pin	Pin Name	Signal Type	Signal Level
8	USB_SSTX-	DIFF	
9	USB_SSTX+	DIFF	
10	+5VSB	PWR	+5V
11	USB_D-	DIFF	
12	USB_D+	DIFF	
13	GND	GND	
14	USB_SSRX-	DIFF	
15	USB_SSRX+	DIFF	
16	GND	GND	
17	USB_SSTX-	DIFF	
18	USB_SSTX+	DIFF	

Note: USB3.0 Ports support current up to 0.9A

2.4.15 USB 3.0 Ports (CN19)

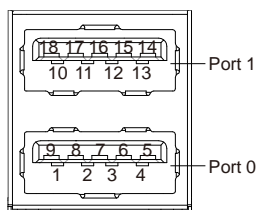

Pin	Pin Name	Signal Type	Signal Level
1	+5VSB	PWR	+5V
2	USB_D-	DIFF	
3	USB_D+	DIFF	
4	GND	GND	

Pin	Pin Name	Signal Type	Signal Level
5	USB_SSRX-	DIFF	
6	USB_SSRX+	DIFF	
7	GND	GND	
8	USB_SSTX-	DIFF	
9	USB_SSTX+	DIFF	
10	+5VSB	PWR	+5V
11	USB_D-	DIFF	
12	USB_D+	DIFF	
13	GND	GND	
14	USB_SSRX-	DIFF	
15	USB_SSRX+	DIFF	
16	GND	GND	
17	USB_SSTX-	DIFF	
18	USB_SSTX+	DIFF	

Note: USB3.0 Ports support current up to 0.9A

2.4.16 USB 2.0 Port (CN20)

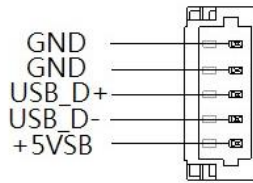

Pin	Pin Name	Signal Type	Signal Level
1	+5VSB	PWR	+5V
2	USB_D-	DIFF	
3	USB_D+	DIFF	
4	GND	GND	
5	GND	GND	

Note: USB2.0 Ports support current up to 0.5A

2.4.17 USB 2.0 Port (CN21)

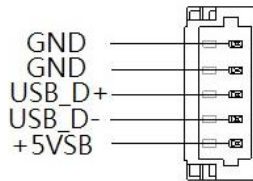

Pin	Pin Name	Signal Type	Signal Level
1	+5VSB	PWR	+5V
2	USB_D-	DIFF	
3	USB_D+	DIFF	
4	GND	GND	
5	GND	GND	

Note: USB2.0 Ports support current up to 0.5A

2.4.18 Audio I/O Port (CN22)

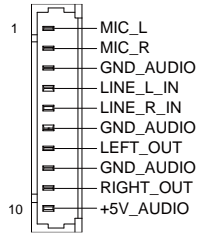

Pin	Pin Name	Signal Type	Signal Level
1	MIC_L	IN	
2	MIC_R	IN	
3	GND_AUDIO	GND	
4	LINE_L_IN	IN	
5	LINE_R_IN	IN	
6	GND_AUDIO	GND	
7	LEFT_OUT	OUT	
8	GND_AUDIO	GND	
9	RIGHT_OUT	OUT	
10	+5V_AUDIO	PWR	+5V

2.4.19 Touchscreen Connector (CN23)

Note: Touch mode can be set by JP6

4-wire Mode:

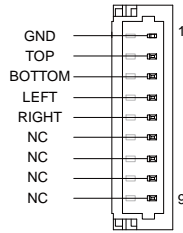

Pin	Pin Name	Signal Type	Signal Level
1	GND	GND	
2	TOP	IN	
3	BOTTOM	IN	
4	LEFT	IN	
5	RIGHT	IN	
6	NC		
7	NC		
8	NC		
9	NC		

5-wire Mode

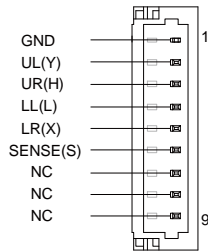

Pin	Pin Name	Signal Type	Signal Level
1	GND	GND	
2	UL(Y)	IN	
3	UR(H)	IN	
4	LL(L)	IN	
5	LR(X)	IN	
6	SENSE(S)	IN	
7	NC		
8	NC		
9	NC		

8-wire Mode

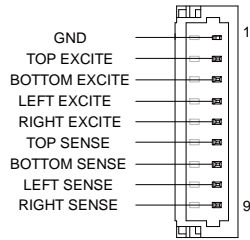

Pin	Pin Name	Signal Type	Signal Level
1	GND	GND	
2	TOP EXCITE	IN	
3	BOTTOM EXCITE	IN	
4	LEFT EXCITE	IN	
5	RIGHT EXCITE	IN	
6	TOP SENSE	IN	
7	BOTTOM SENSE	IN	
8	LEFT SENSE	IN	
9	RIGHT SENSE	IN	

2.4.20 Digital I/O Port (CN24)

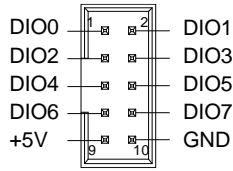

Pin	Pin Name	Signal Type	Signal Level
1	DIO0	I/O	+5V
2	DIO1	I/O	+5V
3	DIO2	I/O	+5V
4	DIO3	I/O	+5V
5	DIO4	I/O	+5V
6	DIO5	I/O	+5V
7	DIO6	I/O	+5V
8	DIO7	I/O	+5V
9	+5V	PWR	+5V
10	GND	GND	

Note: Digital I/O port supports current up to 0.5A

2.4.21 COM Port 1 (CN25)

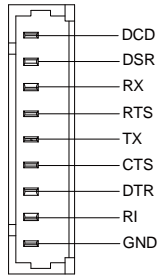

Pin	Pin Name	Signal Type	Signal Level
1	DCD	IN	
2	DSR	IN	
3	RX	IN	
4	RTS	OUT	±9V
5	TX	OUT	±9V
6	CTS	IN	
7	DTR	OUT	±9V
8	RI	IN	
9	GND	GND	

2.4.22 COM Port 4 (CN26)

RS-232 Mode

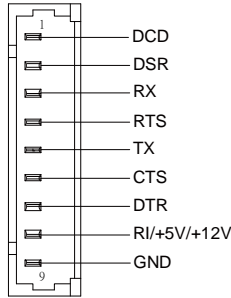

Pin	Pin Name	Signal Type	Signal Level
1	DCD	IN	
2	DSR	IN	
3	RX	IN	
4	RTS	OUT	±5V
5	TX	OUT	±5V
6	CTS	IN	
7	DTR	OUT	±5V
8	RI/+5V/+12V	IN/PWR	+5V/+12V
9	GND	GND	

RS-422 Mode

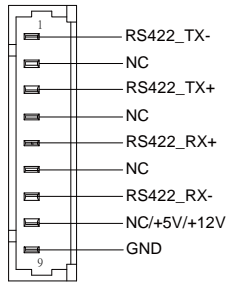

Pin	Pin Name	Signal Type	Signal Level
1	RS422_TX-	OUT	±5V
2	NC		
3	RS422_TX+	OUT	±5V
4	NC		
5	RS422_RX+	IN	
6	NC		
7	RS422_RX-	IN	
8	NC/+5V/+12V	PWR	+5V/+12V
9	GND	GND	

RS-485 Mode

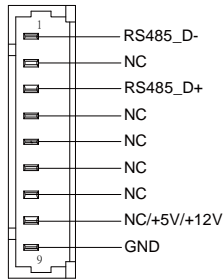

Pin	Pin Name	Signal Type	Signal Level
1	RS485_D-	I/O	±5V
2	NC		
3	RS485_D+	I/O	±5V
4	NC		
5	NC		
6	NC		
7	NC		
8	NC/+5V/+12V	PWR	+5V/+12V
9	GND	GND	

Note 1: COM4RS-232/422/485 can be set by BIOS. Default is RS-232.

Note 2: Pin 8 function can be set by JP11. Maximum driving current in power supply mode is 0.5A

2.4.23 COM Port 2 (CN27)

RS-232 Mode

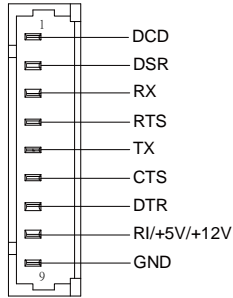

Pin	Pin Name	Signal Type	Signal Level
1	DCD	IN	
2	DSR	IN	
3	RX	IN	
4	RTS	OUT	±5V
5	TX	OUT	±5V
6	CTS	IN	
7	DTR	OUT	±5V
8	RI/+5V/+12V	IN/PWR	+5V/+12V
9	GND	GND	

RS-422 Mode

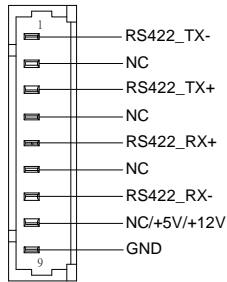

Pin	Pin Name	Signal Type	Signal Level
1	RS422_TX-	OUT	±5V
2	NC		
3	RS422_TX+	OUT	±5V
4	NC		
5	RS422_RX+	IN	
6	NC		
7	RS422_RX-	IN	
8	NC/+5V/+12V	PWR	+5V/+12V
9	GND	GND	

RS-485 Mode

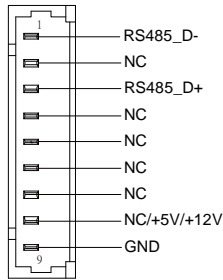

Pin	Pin Name	Signal Type	Signal Level
1	RS485_D-	I/O	±5V
2	NC		
3	RS485_D+	I/O	±5V
4	NC		
5	NC		
6	NC		
7	NC		
8	NC/+5V/+12V	PWR	+5V/+12V
9	GND	GND	

Note 1: COM2 RS-232/422/485 can be set by BIOS setting. Default is RS-232.

Note 2: Pin 8 function can be set by JP9. Maximum driving current in power supply mode is 0.5A

2.4.24 COM Port 3 (CN28)

RS-232 Mode

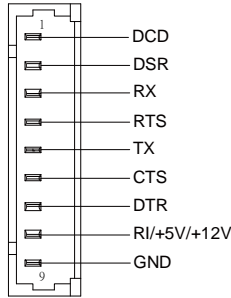

Pin	Pin Name	Signal Type	Signal Level
1	DCD	IN	
2	DSR	IN	
3	RX	IN	
4	RTS	OUT	±5V
5	TX	OUT	±5V
6	CTS	IN	
7	DTR	OUT	±5V
8	RI/+5V/+12V	IN/PWR	+5V/+12V
9	GND	GND	

RS-422 Mode

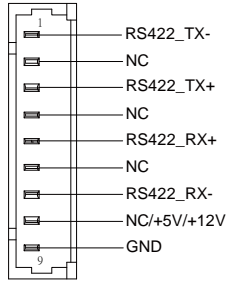

Pin	Pin Name	Signal Type	Signal Level
1	RS422_TX-	OUT	±5V
2	NC		
3	RS422_TX+	OUT	±5V
4	NC		
5	RS422_RX+	IN	
6	NC		
7	RS422_RX-	IN	
8	NC/+5V/+12V	PWR	+5V/+12V
9	GND	GND	

RS-485 Mode

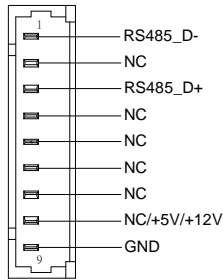

Pin	Pin Name	Signal Type	Signal Level
1	RS485_D-	I/O	±5V
2	NC		
3	RS485_D+	I/O	±5V
4	NC		
5	NC		
6	NC		
7	NC		
8	NC/+5V/+12V	PWR	+5V/+12V
9	GND	GND	

Note 1: COM3 RS-232/422/485 can be set by BIOS setting. Default is RS-232.

Note 2: Pin 8 function can be set by JP8. Maximum driving current in power supply mode is 0.5A

2.4.25 LPC Port (CN29)

Pin	Pin Name	Signal Type	Signal Level
1	LAD0	I/O	+3.3V
2	LAD1	I/O	+3.3V
3	LAD2	I/O	+3.3V
4	LAD3	I/O	+3.3V
5	+3.3V	PWR	+3.3V
6	LFRAME#	IN	
7	LRESET#	OUT	+3.3V
8	GND	GND	
9	LCLK	OUT	
10	I2C_SDA	I/O	
11	I2C_SCL	I/O	
12	SERIRQ	I/O	+3.3V

2.4.26 External Power Input (CN30)

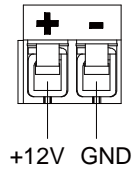

Pin	Pin Name	Signal Type	Signal Level
1	+12V	PWR	+9~+36V (or +12V)
2	GND	GND	

Note: Pin 1/ Vin maximum current rating is 7A.

2.4.27 +5VSB Output w/SMBus (CN32)

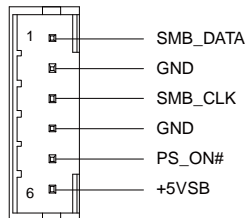

Pin	Pin Name	Signal Type	Signal Level
1	SMB_DATA	I/O	+3.3V
2	GND	GND	
3	SMB_CLK	I/O	+3.3V
4	GND	GND	
5	PS_ON#	OUT	+3.3V
6	+5VSB	PWR	+5V

2.4.28 External +5VSB Input (CN33)

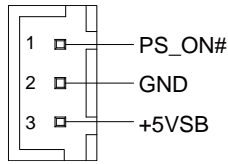

Pin	Pin Name	Signal Type	Signal Level
1	PS_ON#	OUT	+3.3V
2	GND	GND	
3	+5VSB	PWR	+5V

Note: Maximum current rating of Pin#3/+5VSB is 2A

2.4.29 BIO Connector (CN35)

Pin	Pin Name	Signal Type	Signal Level
1	+12V_Dual	PWR	+12V
2	GND	GND	
3	GND	GND	
4	PCIE1_TX-	I/O	
5	PCIE1_RX-	I/O	
6	PCIE1_TX+	I/O	
7	PCIE1_RX+	I/O	
8	GND	GND	
9	GND	GND	
10	PCIE2_TX-	I/O	

Pin	Pin Name	Signal Type	Signal Level
11	PCIE2_RX-	I/O	
12	PCIE2_TX+	I/O	
13	PCIE2_RX+	I/O	
14	GND	GND	
15	GND	GND	
16	PS_ON#	OUT	
17	NC		
18	NC		
19	+5V_Dual	PWR	+5V
20	+5V_Dual	PWR	+5V
21	+5V_Dual	PWR	+5V
22	+5V_Dual	PWR	+5V
23	PCIE_CLK+	OUT	
24	PLT_RST#	OUT	
25	PCIE_CLK-	OUT	
26	GND	GND	
27	GND	GND	
28	NC		
29	NC		
30	NC		
31	NC		
32	GND	GND	
33	GND	GND	
34	NC		
35	NC		
36	NC		

Pin	Pin Name	Signal Type	Signal Level
37	NC		
38	GND	GND	
39	GND	GND	
40	NC		
41	NC		
42	GND	GND	
43	NC		
44	USB 3.0_TX-	I/O	
45	GND	GND	
46	USB 3.0_TX+	I/O	
47	USB 2.0_D-	I/O	
48	GND	GND	
49	USB 2.0_D+	I/O	
50	USB 3.0_RX-	I/O	
51	GND	GND	
52	USB 3.0_RX+	I/O	
53	SMB_CLK	I/O	
54	GND	GND	
55	SMB_DATA	I/O	
56	PCIE_WAKE#	IN	
57	GND	GND	
58	USB 2.0_OC#	IN	
59	+5V	PWR	+5V
60	USB 2.0_OC#	IN	
61	+5V	PWR	+5V
62	+5V	PWR	+5V

Pin	Pin Name	Signal Type	Signal Level
63	+5V	PWR	+5V
64	+5V	PWR	+5V
65	LPC_AD0	I/O	
66	LPC_FRAME#	I/O	
67	LPC_AD1	I/O	
68	SERIRQ#	I/O	
69	LPC_AD2	I/O	
70	NC		
71	LPC_AD3	I/O	
72	GPIO	I/O	
73	GND	GND	
74	Audio_GND	GND	
75	LPC_CLK	OUT	
76	Audio_OUT_L	OUT	
77	PME#	IN	
78	Audio_OUT_R	OUT	
79	GND	GND	
80	GND	GND	

2.4.30 CPU Fan (CN36)

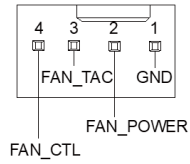

Pin	Pin Name	Signal Type	Signal Level
1	GND	GND	
2	FAN_POWER	PWR	+12V
3	FAN_TAC	IN	
4	FAN_CTL	OUT	+3.3V

Note: +12V Output for FAN power. Driving current supports up to 2A

2.5 Thermal Solutions

2.5.1 GENE-KBU6-HSK02

Single-piece heatsink does not require heatspreader.

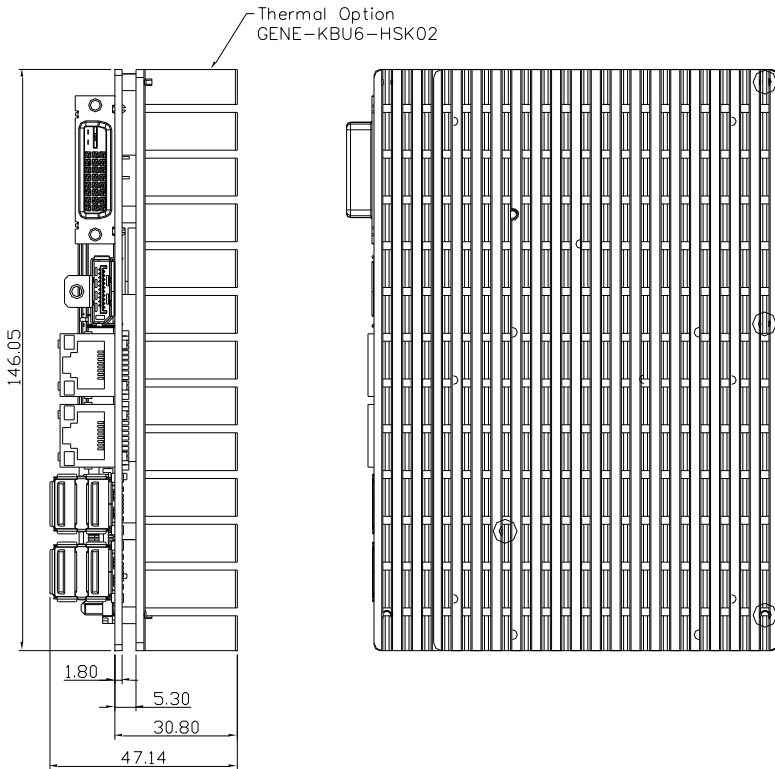

Extended temperature SKUs are tested using GENE-SKU6-HSK02 thermal solution and under UEFI mode.

GENE-KBU6-HSK02 Assembly

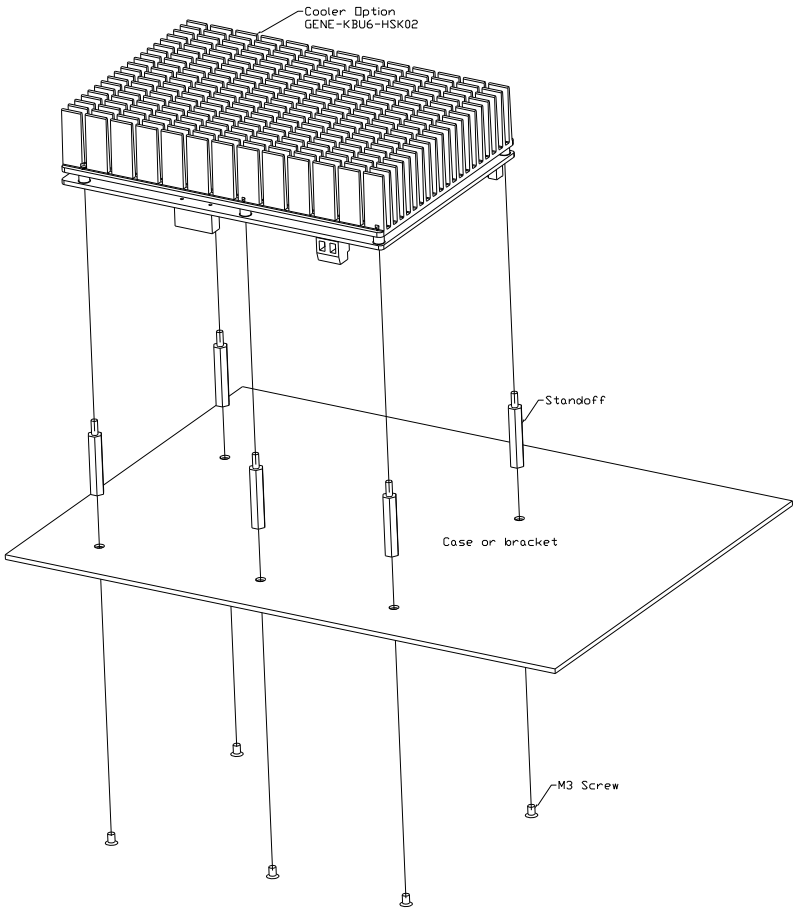

2.5.2 GENE-KBU6-FAN01

Active cooler used with heat spreader.

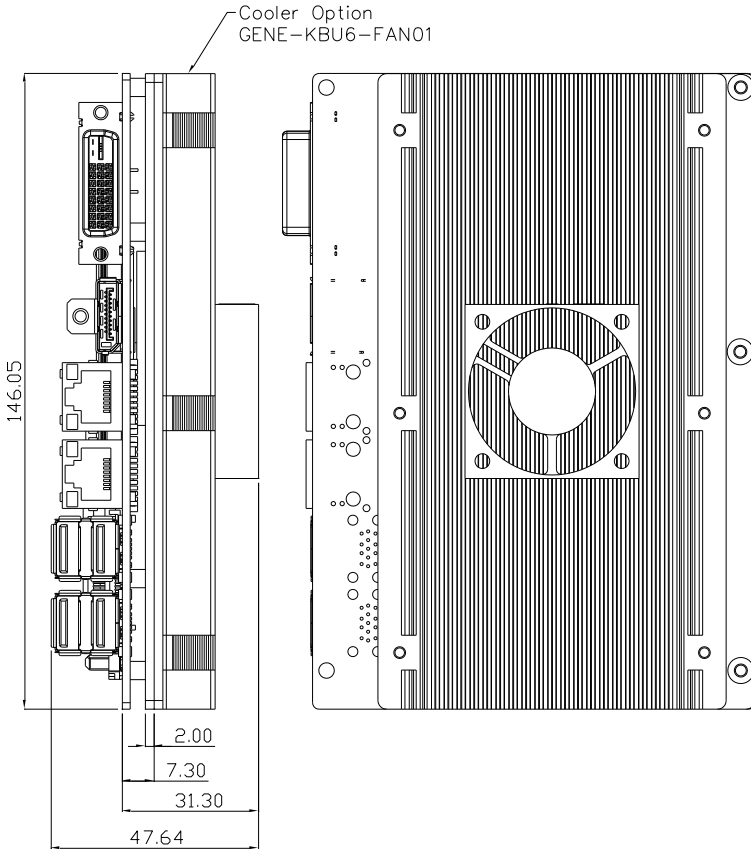

GENE-KBU6-FAN01 Assembly

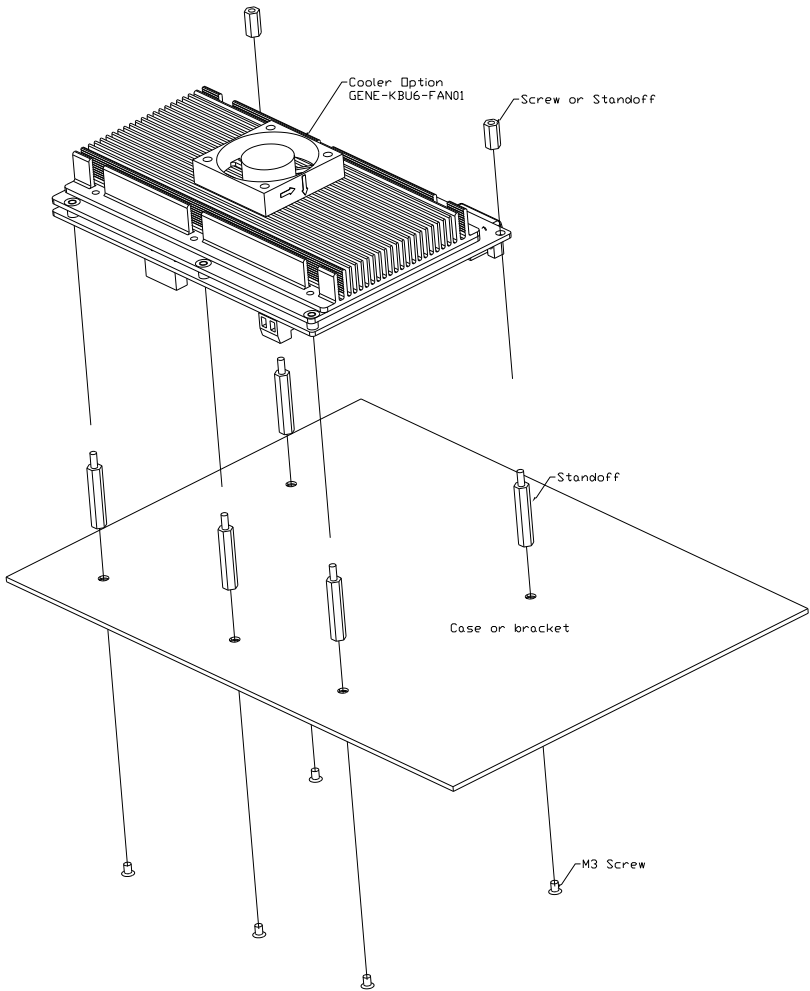

2.5.3 GENE-KBU6-HSK03

Heatsink for DRAM.

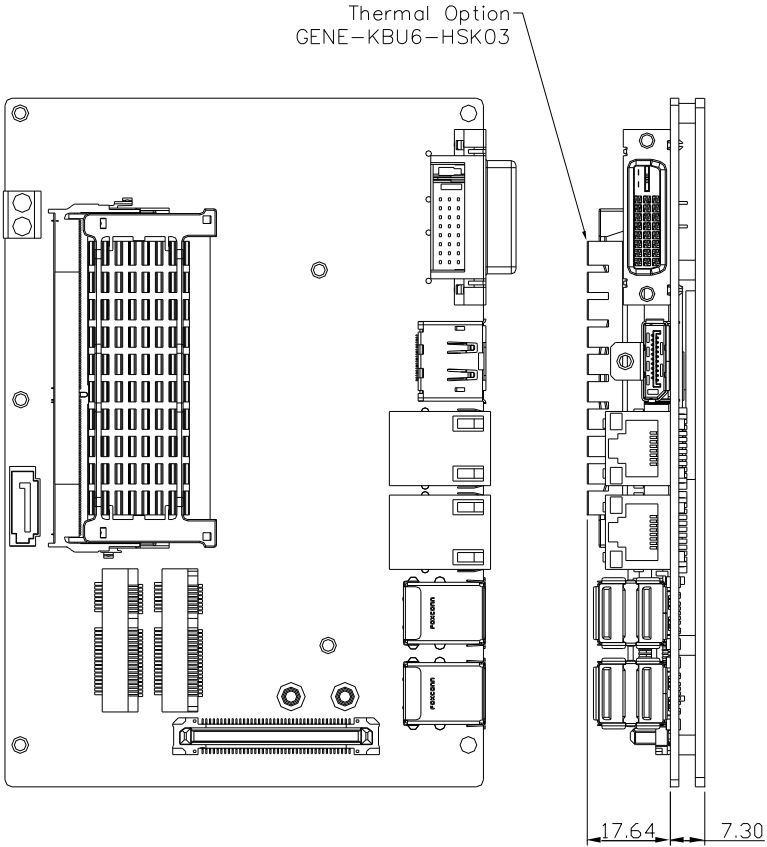

Chapter 3

AMI BIOS Setup

3.1 System Test and Initialization

The board uses certain routines to perform testing and initialization during the boot up sequence. If an error, fatal or non-fatal, is encountered, the system will output a few short beeps or an error message. The board can usually continue the boot up sequence with non-fatal errors.

The system configuration verification routines check the current system configuration against the values stored in the CMOS memory. If they do not match, an error message will be output, and the BIOS setup program will need to be run to set the configuration information in memory.

There are three situations in which the CMOS settings will need to be set or changed:

- Starting the system for the first time
- The system hardware has been changed
- The CMOS memory has lost power and the configuration information is erased

The system's CMOS memory uses a backup battery for data retention. The battery must be replaced when it runs down.

3.2 AMI BIOS Setup

The AMI BIOS ROM has a pre-installed Setup program that allows users to modify basic system configurations, which is stored in the battery-backed CMOS RAM and BIOS NVRAM so that the information is retained when the power is turned off.

To enter BIOS Setup, press or <F2> immediately while your computer is powering up.

The function for each interface can be found below.

Main – Date and time can be set here. Press <Tab> to switch between date elements

Advanced – Access advanced hardware settings and options

Chipset – Chipset settings and options

Security – Set admin and user passwords, access secure boot option

Boot – Boot options including BBS priority and Quiet Boot options

Save & Exit – Save your changes and exit the program

3.3 Setup Submenu: Main

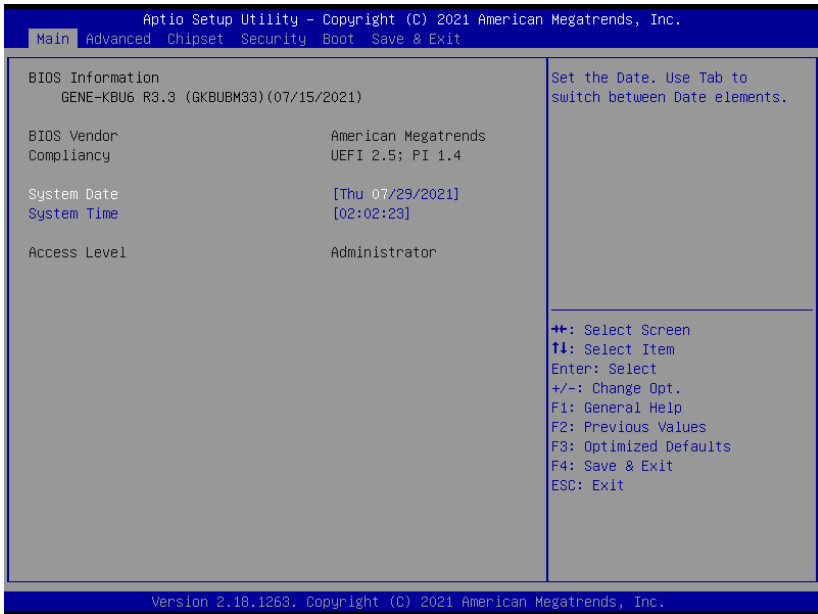

3.4 Setup Submenu: Advanced

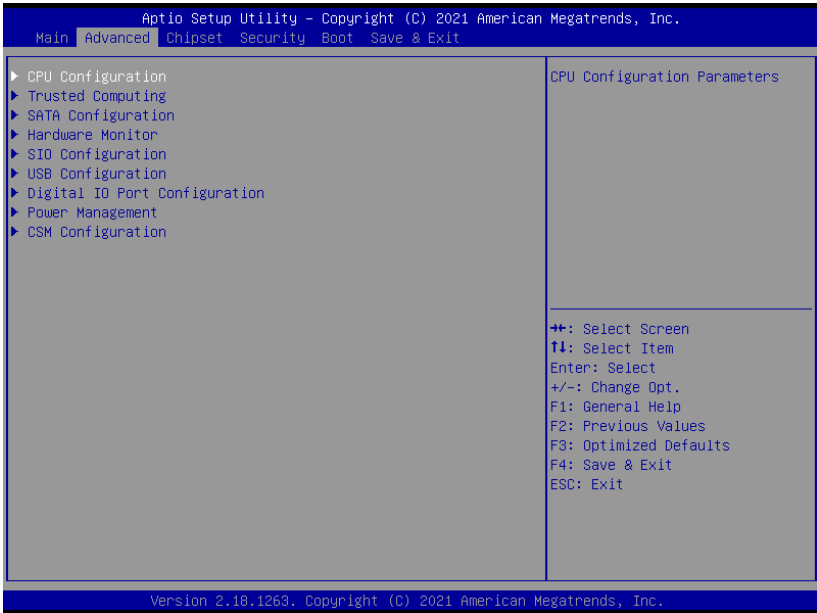

3.4.1 CPU Configuration

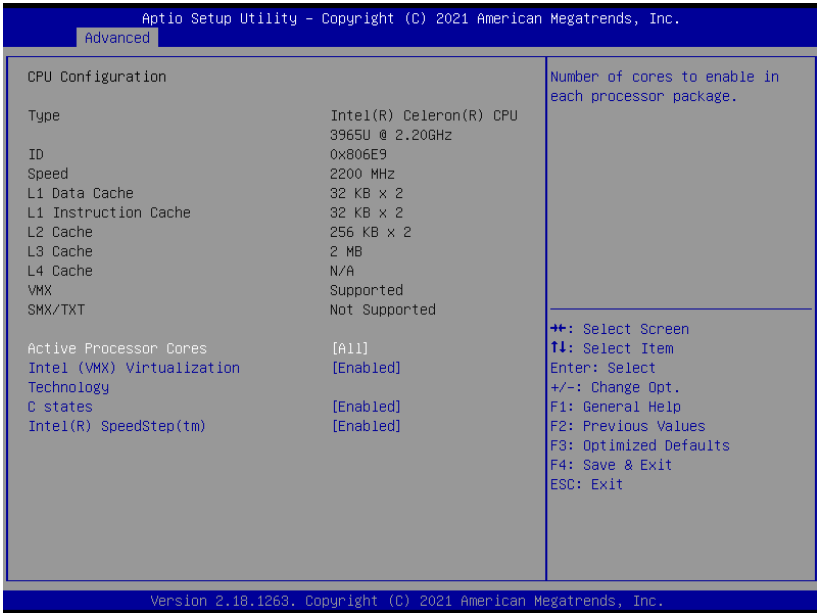

Options Summary		
Active Processor Cores	All	Optimal Default, Failsafe Default
	1	
Number of cores to enable in each processor package.		
Intel (VMX) Virtualization Technology	Disabled	Optimal Default, Failsafe Default
	Enabled	
When enabled, a VMM can utilize the additional hardware capabilities provided by Vanderpool Technology.		
CPU C states	Disabled	Optimal Default, Failsafe Default
	Enabled	
Enable/Disable CPU Power Management. Allows CPU to go to C states when it's not 100% utilized.		
Intel(R) SpeedStep(tm)	Disabled	Optimal Default, Failsafe Default
	Enabled	
Allows more than two frequency ranges to be supported.		

3.4.2 Trusted Computing

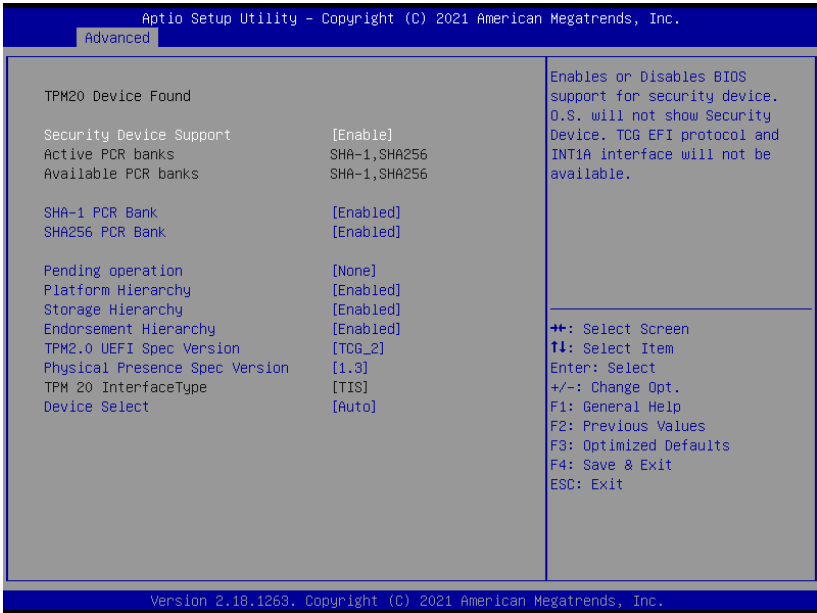

Options Summary		
Security Device Support	Disable	Optimal Default, Failsafe Default
	Enable	
Enables or Disables BIOS support for security device. O.S. will not show Security Device. TCG EFI protocol and INT1A interface will not be available.		
SHA-1 PCR Bank	Disable	Optimal Default, Failsafe Default
	Enable	
Enable or Disable SHA-1 PCR Bank		
SHA256 PCR Bank	Disable	Optimal Default, Failsafe Default
	Enable	
Enable or Disable SHA256 PCR Bank		
Pending operation	None	Optimal Default, Failsafe Default
	TPM Clear	
Schedule an Operation for the Security Device. NOTE: Your Computer will reboot during restart in order to change state of Security Device.		

Options Summary		
Platform Hierarchy	Disable	Optimal Default, Failsafe Default
	Enable	
Enable or Disable Platform Hierarchy		
Storage Hierarchy	Disable	Optimal Default, Failsafe Default
	Enable	
Enable or Disable Storage Hierarchy		
Endorsement Hierarchy	Disable	Optimal Default, Failsafe Default
	Enable	
Enable or Disable Endorsement Hierarchy		
TPM2.0 UEFI Spec Version	TCG_1_2	Optimal Default, Failsafe Default
	TCG_2	
Select the TCG2 Spec Version Support, TCG_1_2: the Compatible mode for Win8/Win10, TCG_2: Support new TCG2 protocol and event format for Win10 or later		
Physical Presence Spec Version	1.2	Optimal Default, Failsafe Default
	1.3	
Select to Tell O.S. to support PPI Spec Version 1.2 or 1.3. Note some HCK tests might not support 1.3.		
Device Select	TPM 1.2	Optimal Default, Failsafe Default
	TPM 2.0	
	Auto	
TPM 1.2 will restrict support to TPM 1.2 devices, TPM 2.0 will restrict support to TPM 2.0 devices, Auto will support both with the default set to TPM 2.0 devices if not found, TPM 1.2 devices will be enumerated.		

3.4.3 SATA Configuration

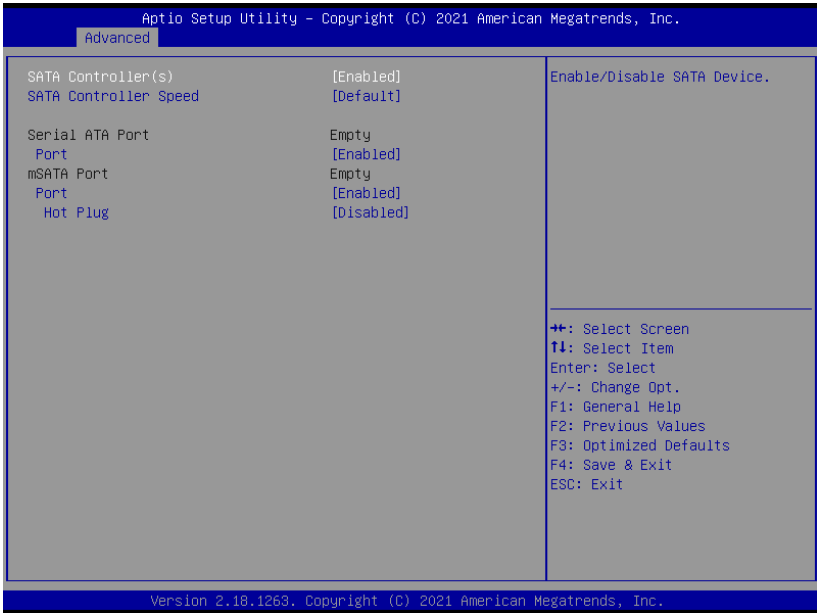

Options Summary		
SATA Controller(s)	Enabled	Optimal Default, Failsafe Default
	Disabled	
Enable/Disable SATA Device.		
SATA Controller Speed	Default	Optimal Default, Failsafe Default
	Gen1	
	Gen2	
	Gen3	
Indicates the maximum speed the SATA controller can support.		
Port	Disabled	Optimal Default, Failsafe Default
	Enabled	
Enable or Disable SATA Port.		
Port	Disabled	Optimal Default, Failsafe Default
	Enabled	
Enable or Disable SATA Port.		

Table Continues on Next Page...

Options Summary		
Hot Plug	Disabled	Optimal Default, Failsafe Default
	Enabled	
Designates this port as Hot Pluggable.		

3.4.4 Hardware Monitor

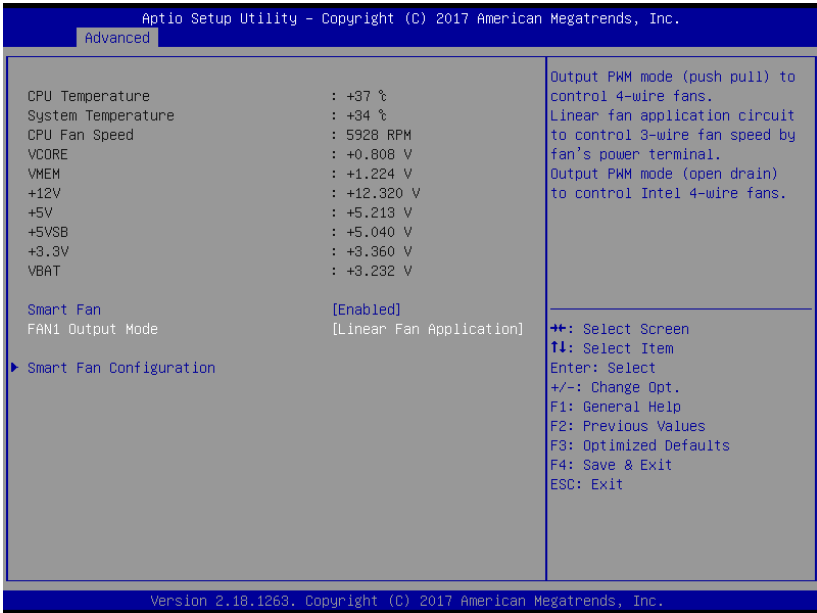

Options Summary		
Smart Fan	Disabled	Optimal Default, Failsafe Default
	Enabled	
Enable or Disable Smart Fan		
FAN1 Output Mode	Output PWM mode (open drain)	Optimal Default, Failsafe Default
	Linear Fan Application	
	Output PWM mode (push pull)	
Output PWM mode (push pull) to control 4-wire fans. Linear fan application circuit to control 3-wire fan speed by fan's power terminal. Output PWM mode (open drain) to control Intel 4-wire fans.		

Note: Optional support for PWM mode is available on request.

3.4.4.1 Smart Fan Mode Configuration

Auto RPM Mode

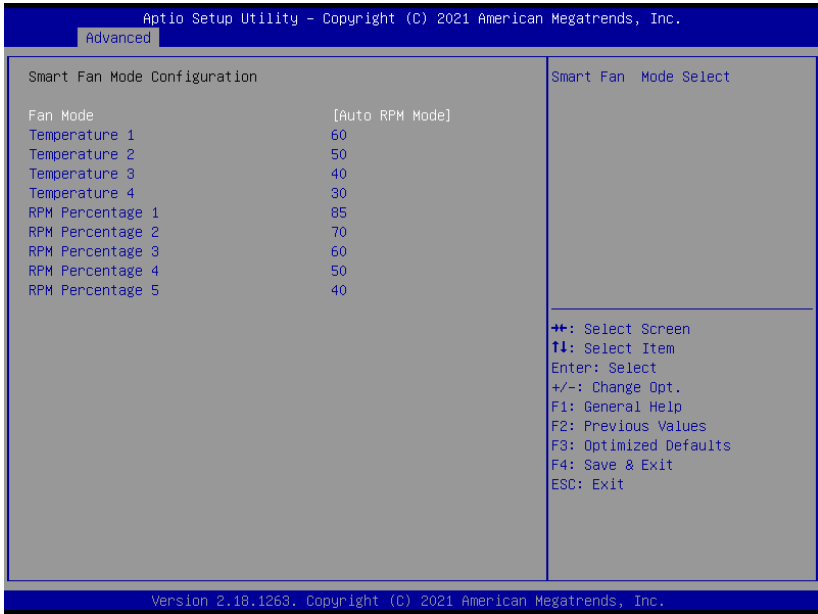

Options Summary		
Fan Mode	Manual RPM Mode	Optimal Default, Failsafe Default
	Auto RPM Mode	
Smart Fan Mode Select		
Temperature 1	60	The settings shown in this section are the Optimal Default, Failsafe Default settings
Temperature 2	50	
Temperature 3	40	
Temperature 4	30	
RPM Percentage 1	85	
RPM Percentage 2	70	
RPM Percentage 3	60	
RPM Percentage 4	50	
RPM Percentage 5	40	
Auto fan speed control. Fan speed will follow different temperature by different RPM1-100		

Manual RPM Mode



Options Summary		
Manual RPM Mode	3000	Optimal Default; Failsafe Default
Manual mode fan control, user can write expected RPM count 500 - 1000		

3.4.5 SIO Configuration

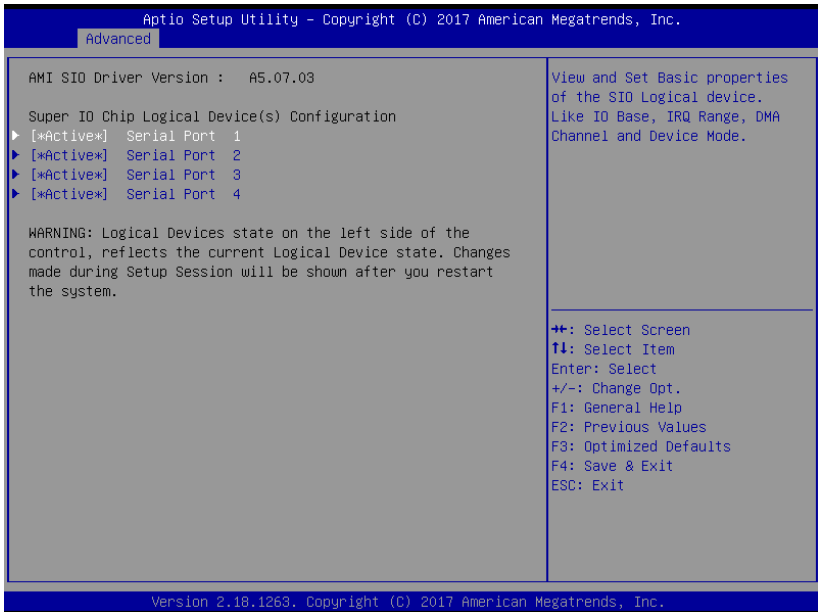

3.4.5.1 Serial Port1 Configuration

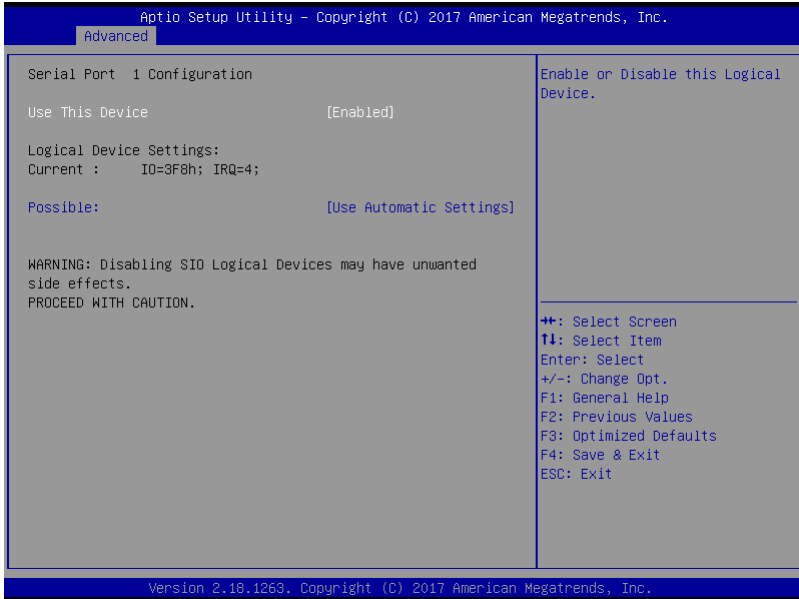

Options Summary		
Use This Device	Disabled	Optimal Default, Failsafe Default
	Enabled	
Enable or Disable this Logical Device.		
Possible:	Use Automatic Settings	Optimal Default, Failsafe Default
	IO=3F8h; IRQ=4;	
	IO=2F8h; IRQ=3;	
Allows the user to change the device resource settings. New settings will be reflected on this setup page after system restarts.		

3.4.5.2 Serial Port2 Configuration

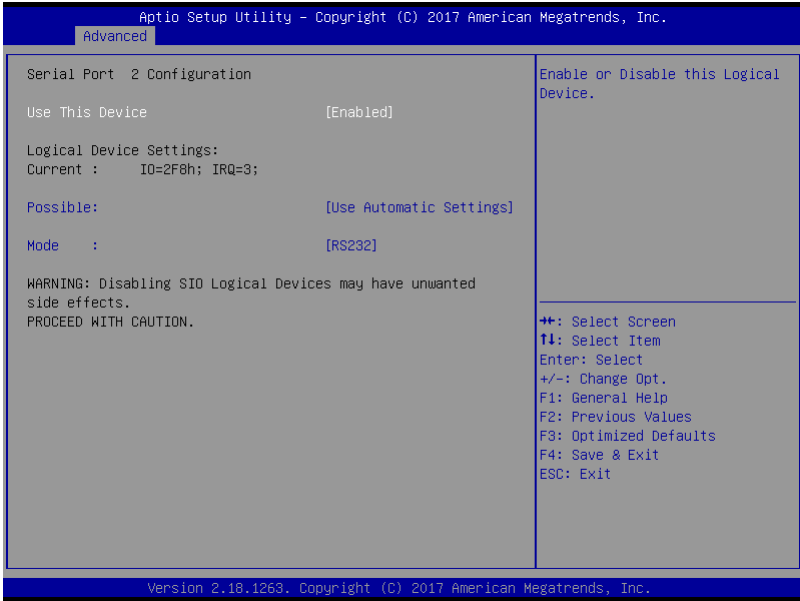

Options Summary		
Use This Device	Disabled	Optimal Default, Failsafe Default
	Enabled	
Enable or Disable this Logical Device.		
Possible:	Use Automatic Settings	Optimal Default, Failsafe Default
	IO=2F8h; IRQ=3;	
	IO=3F8h; IRQ=4;	
Allows the user to change the device resource settings. New settings will be reflected on this setup page after system restarts.		
Mode:	RS232	Optimal Default, Failsafe Default
	RS422	
	RS485	
UART RS232, 422, 485 selection		

3.4.5.3 Serial Port3 Configuration

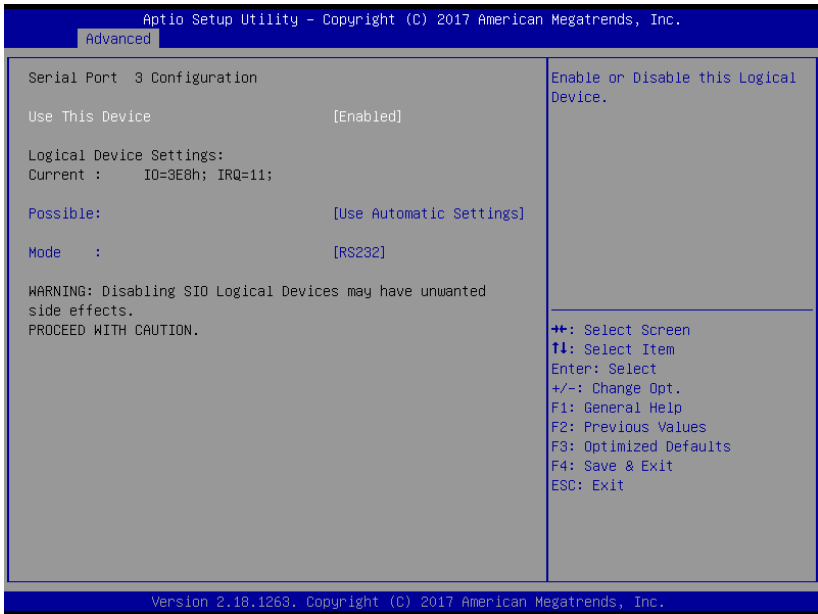

Options Summary		
Use This Device	Disabled	Optimal Default, Failsafe Default
	Enabled	
Enable or Disable this Logical Device.		
Possible:	Use Automatic Settings	Optimal Default, Failsafe Default
	IO=3E8h; IRQ=11;	
	IO=2E8h; IRQ=11;	
Allows the user to change the device resource settings. New settings will be reflected on this setup page after system restarts.		
Mode:	RS232	Optimal Default, Failsafe Default
	RS422	
	RS485	
UART RS232, 422, 485 selection		

3.4.5.4 Serial Port4 Configuration

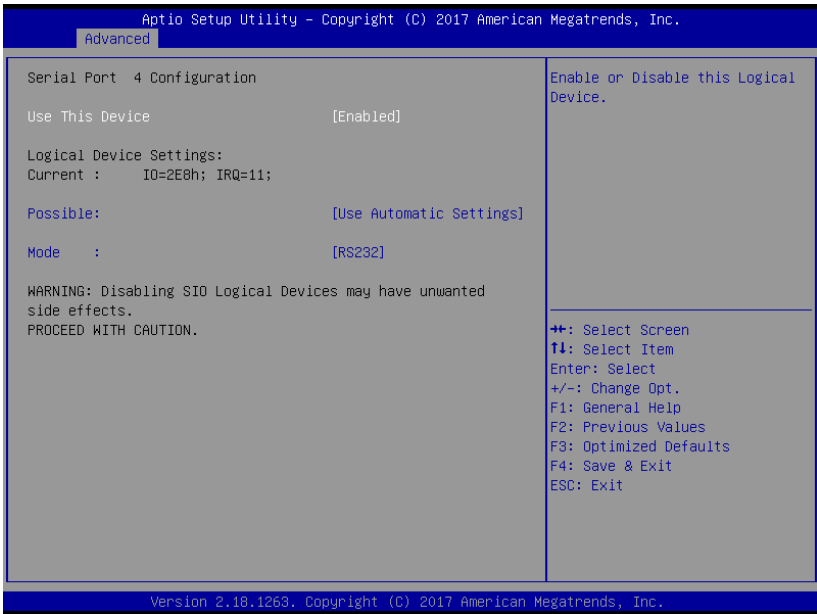

Options Summary		
Use This Device	Disabled	Optimal Default, Failsafe Default
	Enabled	
Enable or Disable this Logical Device.		
Possible:	Use Automatic Settings	Optimal Default, Failsafe Default
	IO=2E8h; IRQ=11;	
	IO=3E8h; IRQ=11;	
Allows the user to change the device resource settings. New settings will be reflected on this setup page after system restarts.		
Mode:	RS232	Optimal Default, Failsafe Default
	RS422	
	RS485	
UART RS232, 422, 485 selection		

3.4.6 USB Configuration

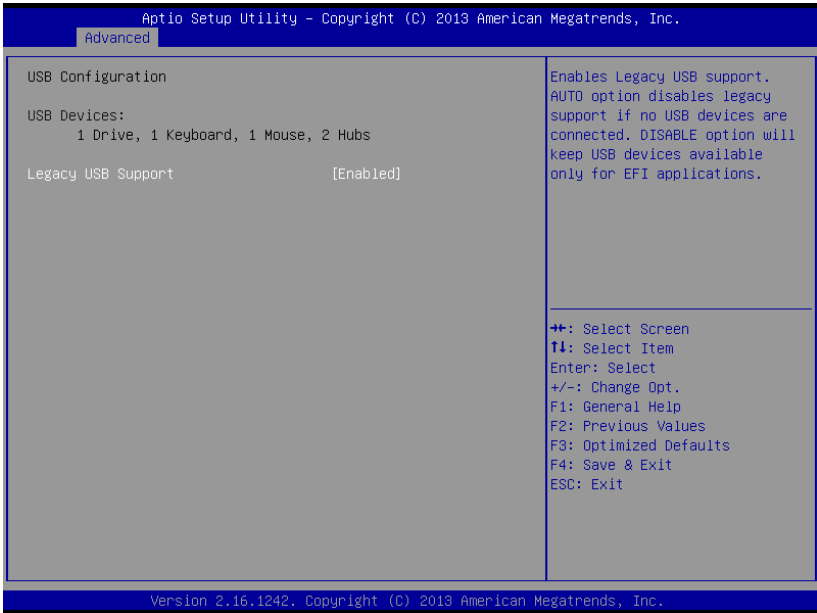

Options Summary		
Legacy USB Support	Enabled	Optimal Default, Failsafe Default
	Disabled	
	Auto	
Enables Legacy USB support. Auto option disables legacy support if no USB devices are connected. DISABLE option will keep USB devices available only for EFI applications.		

3.4.7 Digital IO Port Configuration

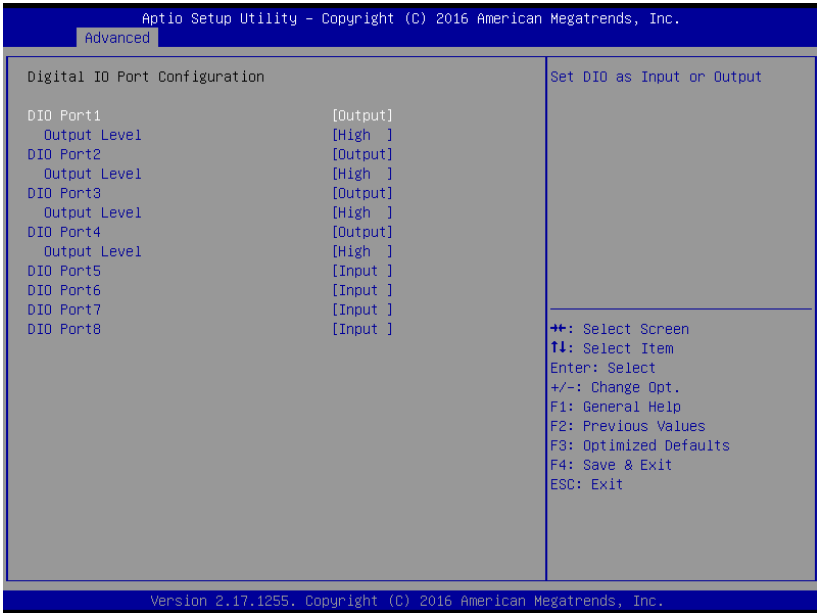

Options Summary		
DIO Port#	Output	
	Input	
Set DIO as Input or Output		
Output Level	High	Optimal Default, Failsafe Default
	Low	
Set output level when DIO pin is output		

3.4.8 Power Management



Options Summary		
Power Mode	ATX Type	Optimal Default, Failsafe Default
	AT Type	
Select system power mode.		
Power Saving (ERP) Control	Disabled	Optimal Default, Failsafe Default
	Enabled	
Configure power mode for power saving function.		
Restore on Power Loss	Last State	Optimal Default, Failsafe Default
	Always On	
	Always Off	
Determine the system turn on or off after AC resume from G3 to S5 state.		
RTC wake system from S5	Disabled	Optimal Default, Failsafe Default
	Fixed Time	
Fixed Time: System will wake on the hr.:min.:sec specified.		
Resume from PCIE	Disabled	Optimal Default, Failsafe Default
	Enabled	
Enable/Disable Resume from PCIE		

Options Summary		
Resume from LAN/RI	Disabled	Optimal Default, Failsafe Default
	Enabled	
Enable/Disable Resume from LAN/RI		

3.4.9 Compatibility Support Module Configuration

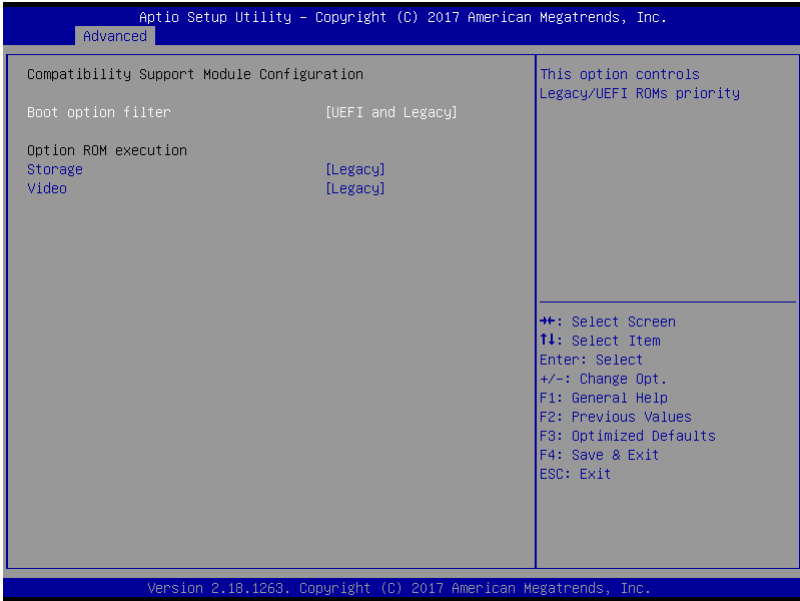

Options Summary		
Boot option filter	UEFI and Legacy	Optimal Default, Failsafe Default
	Legacy only	
	UEFI only	
This option controls Legacy/UEFI ROMs priority		
Storage	Do not launch	Optimal Default, Failsafe Default
	UEFI	
	Legacy	
Controls the execution of UEFI and Legacy Storage OpROM		
Video	Do not launch	Optimal Default, Failsafe Default
	UEFI	
	Legacy	
Controls the execution of UEFI and Legacy Video OpROM		

3.5 Setup Submenu: Chipset

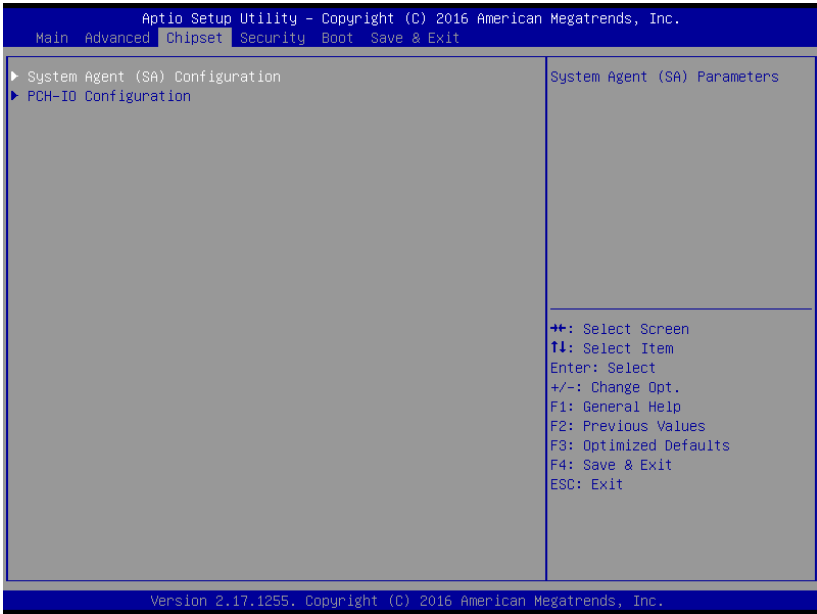

3.5.1 System Agent (SA) Configuration

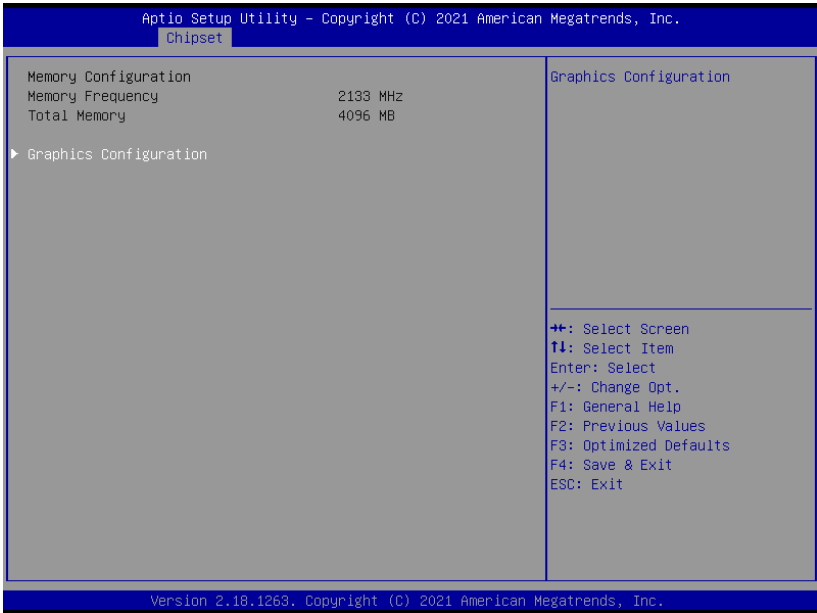

3.5.1.1 Graphics Configuration

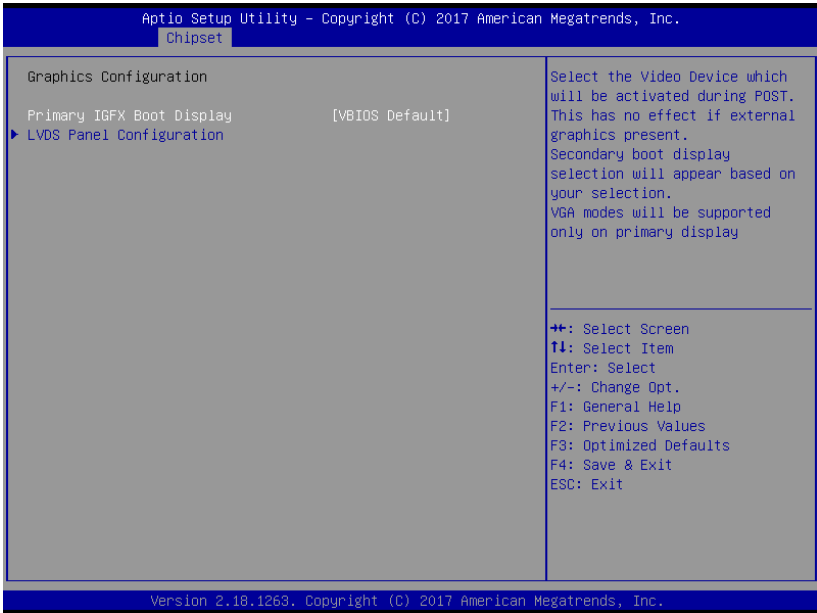

Options Summary		
Primary IGFX Boot Display	VBIOS Default	Optimal Default, Failsafe Default
	DVI	
	CRT/DP	
	LVDS	
<p>Select the Video Device which will be activated during POST. This has no effect if external graphics present.</p> <p>Secondary boot display selection will appear based on your selection.</p> <p>VGA modes will be supported only on primary display</p>		

3.5.11.1 Graphics Configuration: LVDS Panel Configuration

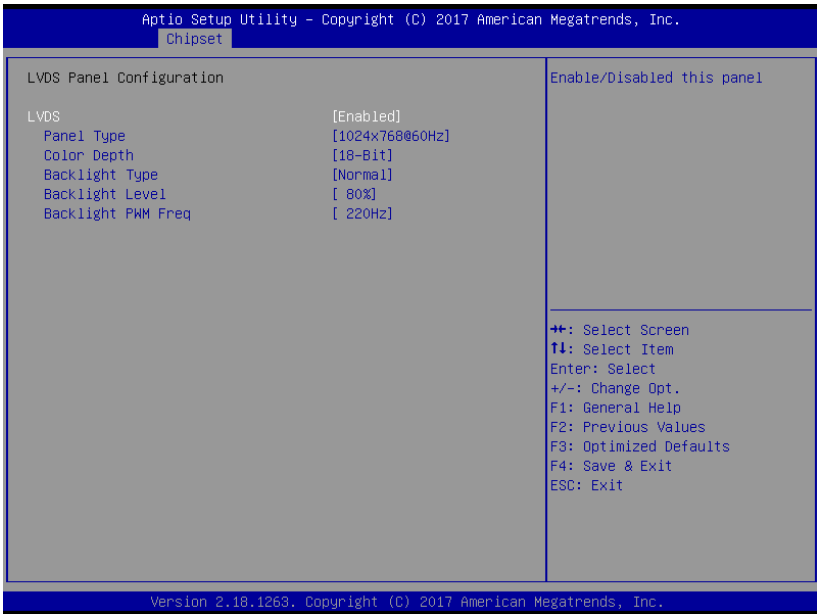

Options Summary		
LVDS	Disabled	Optimal Default, Failsafe Default
	Enabled	
Enable/Disabled this panel.		
LVDS Panel Type	640x480@60Hz	Optimal Default, Failsafe Default
	800x480@60Hz	
	800x600@60Hz	
	1024x600@60Hz	
	1024x768@60Hz	
	1024x768@60Hz	
	1280x800@60Hz	
	1280x1024@60Hz	
	1366x768@60Hz	
	1440x900@60Hz	
	1600x1200@60Hz	
	1920x1080@60Hz	
1920x1200@60Hz		
Select panel type		

Options Summary		
Color Depth	18-bit	Optimal Default, Failsafe Default
	24-bit	
	36-bit	
	48-bit	
Select panel Depth		
Backlight Type	Normal	Optimal Default, Failsafe Default
	Inverted	
Select backlight control signal type		
Backlight Level	0%	Optimal Default, Failsafe Default
	10%	
	20%	
	30%	
	40%	
	50%	
	60%	
	70%	
	80%	
	100%	
Select backlight control level		
Backlight PWM Freq	100Hz	Optimal Default, Failsafe Default
	200Hz	
	220Hz	
	500Hz	
	1KHz	
	2.2KHz	
	6.5KHz	
Select PWM frequency of backlight control signal		

3.5.2 PCH-IO Configuration

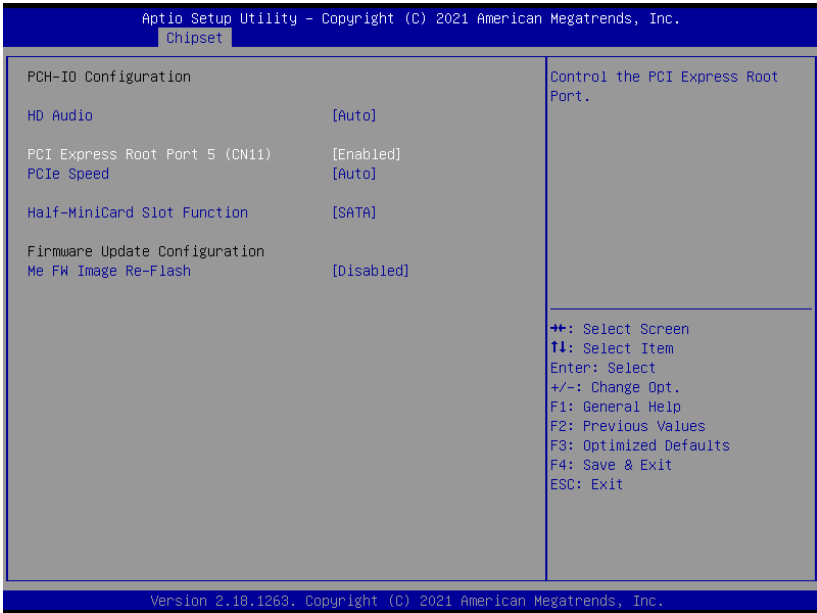

Options Summary		
HD Audio	Disabled	Optimal Default, Failsafe Default
	Enabled	
	Auto	
Control Detection of the HD-Audio device. Disabled = HDA will be unconditionally disabled Enabled = HDA will be unconditionally enabled Auto = HDA will be enabled if present, disabled otherwise.		
PCI Express Root Port 5 (CN11)	Enabled	Optimal Default, Failsafe Default
	Disabled	
Control the PCI Express Root Port.		
PCIe Speed	Auto	Optimal Default, Failsafe Default
	Gen1	
	Gen2	
	Gen3	
Configure PCIe speed.		

Options Summary		
Half-MiniCard Slot Function	SATA	Optimal Default, Failsafe Default
	PCIe	
Select function enabled for Half-MiniCard(CN13) slot		
Me FW Image Re-Flash	Disabled	Optimal Default, Failsafe Default
	Enabled	
Enable/Disable Me FW Image Re-Flash function.		

3.6 Setup Submenu: Security

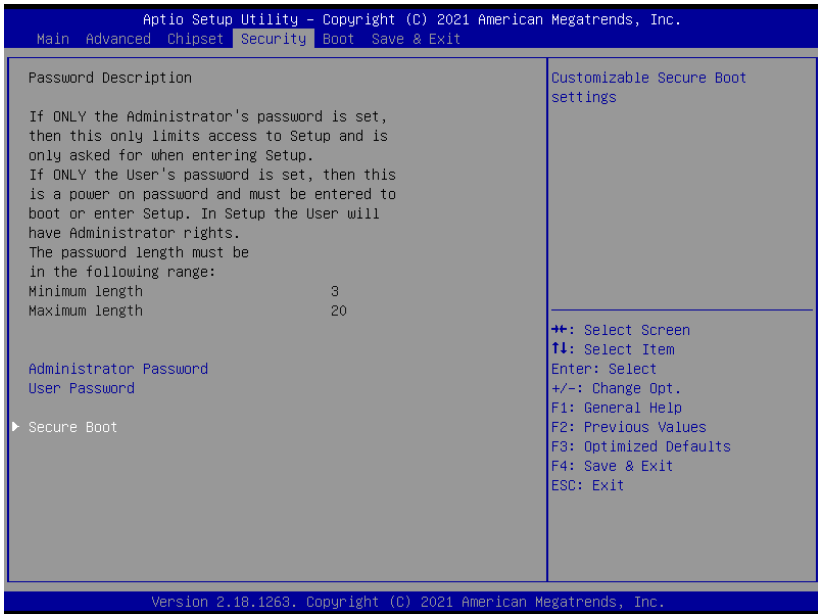

Change User/Administrator Password

You can set an Administrator Password or User Password. An Administrator Password must be set before you can set a User Password. The password will be required during boot up, or when the user enters the Setup utility. A User Password does not provide access to many of the features in the Setup utility.

Select the password you wish to set, and press Enter. In the dialog box, enter your password (must be between 3 and 20 letters or numbers). Press Enter and retype your password to confirm. Press Enter again to set the password.

Removing the Password

Select the password you want to remove and enter the current password. At the next dialog box press Enter to disable password protection.

3.6.1 Secure Boot

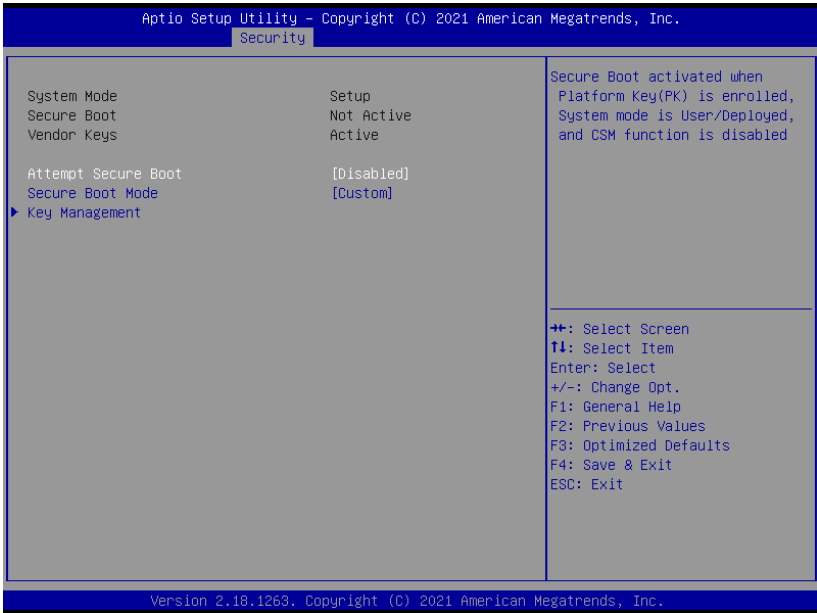

Options Summary		
Attempt Secure Boot	Disabled	Optimal Default, Failsafe Default
	Enabled	
Secure Boot activated when Platform Key(PK) is enrolled, System mode is User/Deployed, and CSM function is disable		
Secure Boot Mode	Standard	Optimal Default, Failsafe Default
	Custom	
Secure Boot Mode selector: Standard/Custom. In Custom mode Secure Boot Variables can be configured without authentication		

3.6.11 Key Management

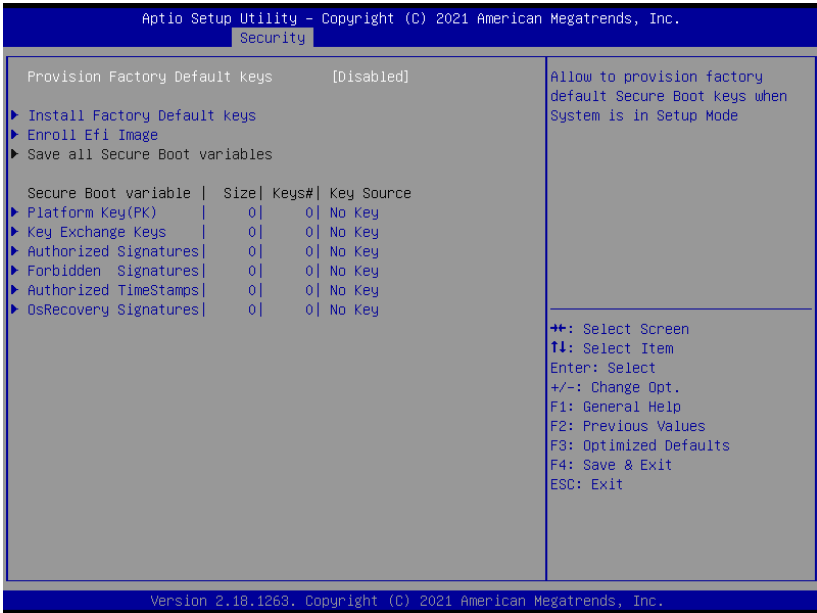

Options Summary		
Provision Factory Default	Disabled	Optimal Default, Failsafe Default
	Enabled	
Allow to provision factory default Secure Boot keys when System is in Setup Mode		

3.7 Setup submenu: Boot

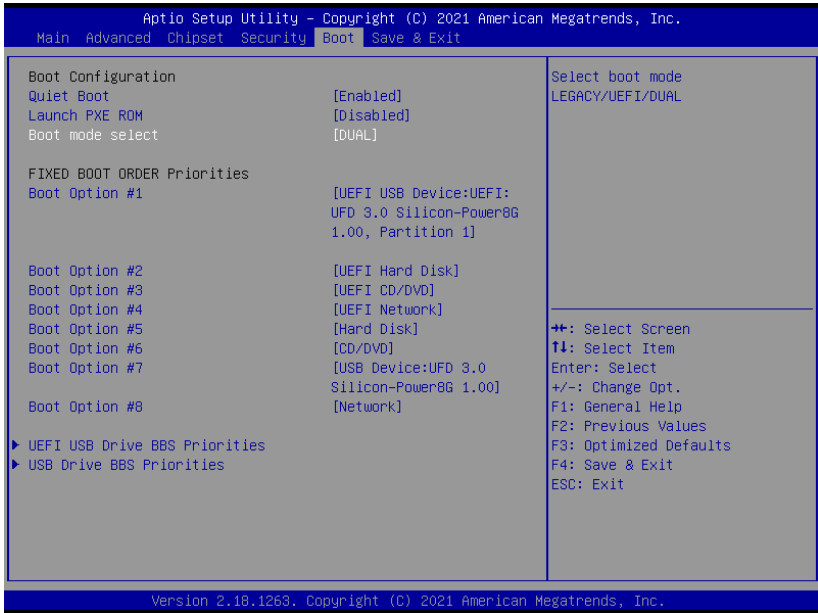

Options Summary		
Quiet Boot	Disabled	Optimal Default, Failsafe Default
	Enabled	
Enables or Disables Quiet Boot option.		
Launch PXE ROM	Disabled	Optimal Default, Failsafe Default
	Enabled	
Controls the execution of Legacy PXE OpROM		
Boot mode select	LEGACY	Optimal Default, Failsafe Default
	UEFI	
	DUAL	
Select boot mode Legacy/UEFI/DUAL		

3.8 Setup submenu: Save & Exit

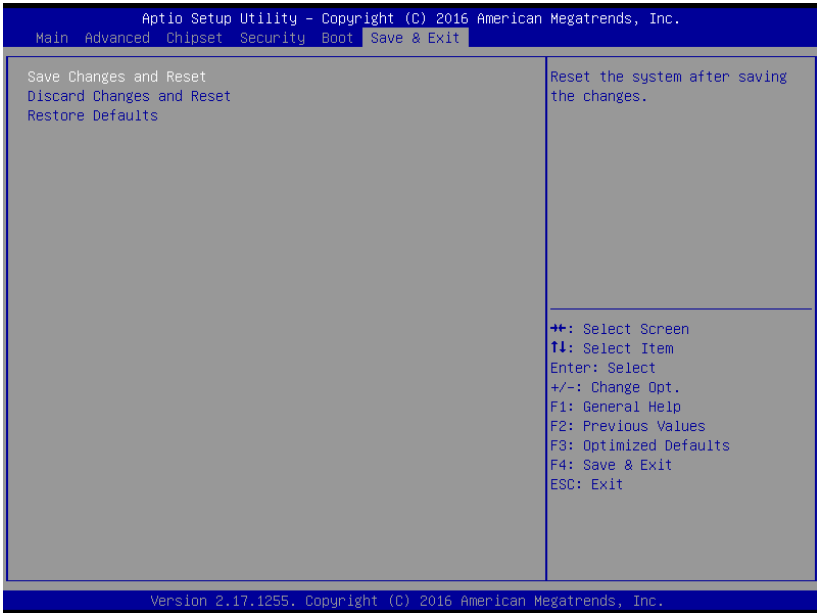

Chapter 4

Drivers Installation

4.1 Driver Download/Installation

Drivers for the GENE-KBU6 can be downloaded from the product page on the AAEON website by following this link:

<https://www.aaeon.com/en/p/3-and-half-inches-subcompact-boards-gene-kbu6>

Download the driver(s) you need and follow the steps below to install them.

Step 1 – Install Chipset Drivers

1. Open the **Step1 - Chipset** folder followed by **SetupChipset.exe**
2. Follow the instructions
3. Drivers will be installed automatically

Step 2 – Install Graphics Drivers

1. Open the **Step2 - Graphic** folder and select your OS
2. Open the **Setup.exe** file in the folder
3. Follow the instructions
4. Drivers will be installed automatically

Step 3 – Install LAN Drivers

1. Click on the **Step3 - LAN** folder and select your OS
2. Open the **.exe** file in the folder
3. Follow the instructions
4. Drivers will be installed automatically

Step 4 – Install Audio Drivers

1. Open the **Step4 - Audio** folder and select your OS
2. Open the **.exe** file in the folder
3. Follow the instructions
4. Drivers will be installed automatically

Step 5 – Install PenMount Touch 6000 Driver

1. Open the **Step5 – PenMount Touch 6000** folder followed by **Setup.exe**
2. Follow the instructions
3. Drivers will be installed automatically

Step 6 – Install Serial Port Drivers (Optional)

1. Open the **Step6 – Serial Port Driver (Optional)** folder followed by **setup.exe**
2. Follow the instructions
3. Drivers will be installed automatically

4.2 Note on EHCI

With the EHCI controller no longer available on the 6th Gen Intel® Core™ platforms, it is recommended to install Windows 7 through a SATA bus, e.g. SATA DVD-ROM, or patch the xHCI driver onto an installation media for Windows 7. More information can be found in the links below.

[Windows 7 USB 3.0 Creator Utility](#)

[Read me](#)

For input devices, please use an add-on standard EHCI controller expansion card, such as PCIe to USB 2.0 conversion card.

Appendix A

Watchdog Timer Programming

A.1 Watchdog Timer Registers

Table 1 : Watch dog relative IO address		
	Default Value	Note
I/O Base Address	0xA10	I/O Base address for Watchdog operation. This address is assigned by SIO LDN7, register 0x60-0x61.

Table 2 : Watchdog relative register table				
Register	Offset	BitNum	Value	Note
Watchdog WDRST# Enable	0x00	7	1	Enable/Disable time out output via WDRST# 0: Disable 1: Enable
Pulse Width	0x05	0:1	01	Width of Pulse signal 00: 1ms (do not use) 01: 25ms 10: 125ms 11: 5s Pulse width is must longer then 16ms.
Signal Polarity	0x05	2	0	0: low active 1: high active Must set this bit to 0
Counting Unit	0x05	3	0	Select time unit. 0: second 1: minute
Output Signal Type	0x05	4	1	0: Level 1: Pulse Must set this bit to 1
Watchdog Timer Enable	0x05	5	1	0: Disable 1: Enable
Timeout Status	0x05	6	1	1: timeout occurred. Write a 1 to clear timeout status
Timer Counter	0x06			Time of watchdog timer (0~255)

A.2 Watchdog Sample Program

```
*****
// WDT I/O operation relative definition (Please reference to Table 1)
#define WDTAddr    0x510 // WDT I/O base address
Void  WDTWriteByte(byte Register, byte Value);
byte  WDTReadByte(byte Register);
Void  WDTSetReg(byte Register, byte Bit, byte Val);
// Watch Dog relative definition (Please reference to Table 2)
#define DevReg     0x00 // Device configuration register
    #define WDRstBit 0x80 // Watchdog WDTRST# (Bit7)
    #define WDRstVal 0x80 // Enabled WDTRST#
#define TimerReg   0x05 // Timer register
    #define PSWidthBit 0x00 // WDTRST# Pulse width (Bit0:1)
    #define PSWidthVal 0x01 // 25ms for WDTRST# pulse
    #define PolarityBit 0x02 // WDTRST# Signal polarity (Bit2)
    #define PolarityVal 0x00 // Low active for WDTRST#
    #define UnitBit    0x03 // Unit for timer (Bit3)
    #define ModeBit    0x04 // WDTRST# mode (Bit4)
    #define ModeVal    0x01 // 0:level 1: pulse
    #define EnableBit  0x05 // WDT timer enable (Bit5)
    #define EnableVal  0x01 // 1: enable
    #define StatusBit  0x06 // WDT timer status (Bit6)
#define CounterReg 0x06 // Timer counter register
*****

*****
VOID  Main(){
    // Procedure : AaeonWDTConfig
    // (byte)Timer : Counter of WDT timer.(0x00~0xFF)
    // (boolean)Unit : Select time unit(0: second, 1: minute).
    AaeonWDTConfig(Counter, Unit);

    // Procedure : AaeonWDTEnable
    // This procedure will enable the WDT counting.
    AaeonWDTEnable();
}
*****
```

```

*****
// Procedure : AaeonWDTEnable
VOID AaeonWDTEnable (){
    WDTEnableDisable(1);
}

// Procedure : AaeonWDTConfig
VOID AaeonWDTConfig (byte Counter, BOOLEAN Unit){
    // Disable WDT counting
    WDTEnableDisable(0);
    // Clear Watchdog Timeout Status
    WDTClearTimeoutStatus();
    // WDT relative parameter setting
    WDTParameterSetting(Timer, Unit);
}

VOID WDTEnableDisable(byte Value){
    If (Value == 1)
        WDTSetBit(TimerReg, EnableBit, 1);
    else
        WDTSetBit(TimerReg, EnableBit, 0);
}

VOID WDTParameterSetting(byte Counter, BOOLEAN Unit){
    // Watchdog Timer counter setting
    WDTWriteByte(CounterReg, Counter);
    // WDT counting unit setting
    WDTSetBit(TimerReg, UnitBit, Unit);
    // WDT output mode set to pulse
    WDTSetBit(TimerReg, ModeBit, ModeVal);
    // WDT output mode set to active low
    WDTSetBit(TimerReg, PolarityBit, PolarityVal);
    // WDT output pulse width is 25ms
    WDTSetBit(TimerReg, PSWidthBit, PSWidthVal);
    // Watchdog WDTRST# Enable
    WDTSetBit(DevReg, WDTRstBit, WDTRstVal);
}

VOID WDTClearTimeoutStatus() {
    WDTSetBit(TimerReg, StatusBit, 1);
}
*****

```

```
*****
VOID  WDTWriteByte(byte Register, byte Value){
    IOWriteByte(WDTAddr+Register, Value);
}

byte  WDTReadByte(byte Register){
    return IOWriteByte(WDTAddr+Register);
}

VOID  WDTSetBit(byte Register, byte Bit, byte Val){
    byte TmpValue;

    TmpValue = WDTReadByte(Register);
    TmpValue &= ~(1 << Bit);
    TmpValue |= Val << Bit;
    WDTWriteByte(Register, TmpValue);
}

*****
```



















Appendix B

I/O Information

B.1 I/O Address Map

The screenshot displays the Windows Device Manager window for a system named 'DESKTOP-SD36472'. The 'Input/output (IO)' category is expanded, showing a list of hardware devices with their corresponding I/O address ranges. The devices include various interrupt controllers, motherboard resources, system timers, PS/2 mice, and communication ports. The address ranges are listed in hexadecimal format, such as [0000000000000000 - 000000000000CF7] for the PCI Express Root Complex and [0000000000000000 - 0000000000000000] for the Programmable interrupt controller.

Device Name	I/O Address Range
PCI Express Root Complex	[0000000000000000 - 000000000000CF7]
Programmable interrupt controller	[0000000000000020 - 0000000000000021]
Programmable interrupt controller	[0000000000000024 - 0000000000000025]
Programmable interrupt controller	[0000000000000028 - 0000000000000029]
Programmable interrupt controller	[000000000000002C - 000000000000002D]
Motherboard resources	[000000000000002E - 000000000000002F]
Programmable interrupt controller	[0000000000000030 - 0000000000000031]
Programmable interrupt controller	[0000000000000034 - 0000000000000035]
Programmable interrupt controller	[0000000000000038 - 0000000000000039]
Programmable interrupt controller	[000000000000003C - 000000000000003D]
System timer	[0000000000000040 - 0000000000000043]
Motherboard resources	[000000000000004E - 000000000000004F]
System timer	[0000000000000050 - 0000000000000053]
PS/2 Compatible Mouse	[0000000000000060 - 0000000000000060]
Motherboard resources	[0000000000000061 - 0000000000000061]
Motherboard resources	[0000000000000063 - 0000000000000063]
PS/2 Compatible Mouse	[0000000000000064 - 0000000000000064]
Motherboard resources	[0000000000000065 - 0000000000000065]
Motherboard resources	[0000000000000067 - 0000000000000067]
Motherboard resources	[0000000000000070 - 0000000000000070]
System CMOS/real time clock	[0000000000000070 - 0000000000000077]
Motherboard resources	[0000000000000080 - 0000000000000080]
Motherboard resources	[0000000000000092 - 0000000000000092]
Programmable interrupt controller	[00000000000000A0 - 00000000000000A1]
Programmable interrupt controller	[00000000000000A4 - 00000000000000A5]
Programmable interrupt controller	[00000000000000A8 - 00000000000000A9]
Programmable interrupt controller	[00000000000000AC - 00000000000000AD]
Programmable interrupt controller	[00000000000000B0 - 00000000000000B1]
Motherboard resources	[00000000000000B2 - 00000000000000B3]
Programmable interrupt controller	[00000000000000B4 - 00000000000000B5]
Programmable interrupt controller	[00000000000000B8 - 00000000000000B9]
Programmable interrupt controller	[00000000000000BC - 00000000000000BD]
Communications Port (COM4)	[00000000000002E8 - 00000000000002EF]
Communications Port (COM2)	[00000000000002F8 - 00000000000002FF]
Intel(R) HD Graphics 610	[00000000000003B0 - 00000000000003BB]
Intel(R) HD Graphics 610	[00000000000003C0 - 00000000000003DF]
Communications Port (COM3)	[00000000000003E8 - 00000000000003EF]
Communications Port (COM1)	[00000000000003F8 - 00000000000003FF]
Programmable interrupt controller	[00000000000004D0 - 00000000000004D1]
Motherboard resources	[0000000000000680 - 000000000000069F]











































	[0000000000000680 - 000000000000069F] Motherboard resources
	[000000000000A00 - 000000000000A0F] Motherboard resources
	[000000000000A10 - 000000000000A1F] Motherboard resources
	[000000000000A20 - 000000000000A2F] Motherboard resources
	[000000000000D00 - 000000000000FFFF] PCI Express Root Complex
	[000000000000164E - 000000000000164F] Motherboard resources
	[0000000000001800 - 00000000000018FE] Motherboard resources
	[0000000000001854 - 0000000000001857] Motherboard resources
	[000000000000D000 - 000000000000DFFF] Mobile 6th/7th Generation Intel(R) Processor Family I/O PCI Express Root Port #4 - 9D13
	[000000000000E000 - 000000000000EFFF] Mobile 6th/7th Generation Intel(R) Processor Family I/O PCI Express Root Port #3 - 9D12
	[000000000000F000 - 000000000000F03F] Intel(R) HD Graphics 610
	[000000000000F040 - 000000000000F05F] Mobile 6th/7th Generation Intel(R) Processor Family I/O SMBUS - 9D23
	[000000000000F060 - 000000000000F07F] Standard SATA AHCI Controller
	[000000000000F080 - 000000000000F083] Standard SATA AHCI Controller
	[000000000000F090 - 000000000000F097] Standard SATA AHCI Controller
	[000000000000FF00 - 000000000000FFFE] Motherboard resources
	[000000000000FFFF - 000000000000FFFF] Motherboard resources
	[000000000000FFFF - 000000000000FFFF] Motherboard resources











































B.2 Memory Address Map











































Address Range	Device Name
[0000000000A0000 - 0000000000BFFFF]	Intel(R) HD Graphics 610
[0000000000A0000 - 0000000000BFFFF]	PCI Express Root Complex
[0000000090000000 - 00000000DFFFFFF]	PCI Express Root Complex
[00000000C0000000 - 00000000CFFFFFF]	Intel(R) HD Graphics 610
[00000000DE000000 - 00000000EFFFFFF]	Intel(R) HD Graphics 610
[00000000DF000000 - 00000000DF0FFFF]	Intel(R) I210 Gigabit Network Connection #2
[00000000DF000000 - 00000000DF0FFFF]	Mobile 6th/7th Generation Intel(R) Processor Family I/O PCI Express Root Port #4 - 9D13
[00000000DF020000 - 00000000DF03FFF]	Intel(R) I210 Gigabit Network Connection #2
[00000000DF100000 - 00000000DF1FFFF]	Intel(R) I210 Gigabit Network Connection
[00000000DF100000 - 00000000DF1FFFF]	Mobile 6th/7th Generation Intel(R) Processor Family I/O PCI Express Root Port #3 - 9D12
[00000000DF120000 - 00000000DF123FFF]	Intel(R) I210 Gigabit Network Connection
[00000000DF210000 - 00000000DF21FFFF]	Intel(R) USB 3.0 eXtensible Host Controller - 1.0 (Microsoft)
[00000000DF228000 - 00000000DF229FFF]	Standard SATA AHCI Controller
[00000000DF22A000 - 00000000DF22A0FF]	Mobile 6th/7th Generation Intel(R) Processor Family I/O SMBUS - 9D23
[00000000DF22B000 - 00000000DF22B7FF]	Standard SATA AHCI Controller
[00000000DF22C000 - 00000000DF22C0FF]	Standard SATA AHCI Controller
[00000000DF22D000 - 00000000DF22DFFF]	Mobile 6th/7th Generation Intel(R) Processor Family I/O Thermal subsystem - 9D31
[00000000DFFE0000 - 00000000DFFFFFF]	Motherboard resources
[00000000E0000000 - 00000000EFFFFFF]	Motherboard resources
[00000000FD000000 - 00000000FDABFFF]	Motherboard resources
[00000000FD000000 - 00000000FE7FFFF]	PCI Express Root Complex
[00000000FDAC0000 - 00000000FDACFFF]	Motherboard resources
[00000000FDAD0000 - 00000000FDADFFF]	Motherboard resources
[00000000FDAE0000 - 00000000FDAEFFF]	Motherboard resources
[00000000FDAF0000 - 00000000FDAFFFF]	Motherboard resources
[00000000FDB00000 - 00000000FDBFFFF]	Motherboard resources
[00000000FE000000 - 00000000FE01FFF]	Motherboard resources
[00000000FE028000 - 00000000FE028FFF]	Motherboard resources
[00000000FE029000 - 00000000FE029FFF]	Motherboard resources
[00000000FE030000 - 00000000FE033FFF]	High Definition Audio Controller
[00000000FE036000 - 00000000FE03BFFF]	Motherboard resources
[00000000FE03D000 - 00000000FE3FFFF]	Motherboard resources
[00000000FE400000 - 00000000FE40FFFF]	High Definition Audio Controller
[00000000FE410000 - 00000000FE7FFFF]	Motherboard resources
[00000000FED00000 - 00000000FED003FF]	High precision event timer
[00000000FED10000 - 00000000FED17FFF]	Motherboard resources
[00000000FED18000 - 00000000FED18FFF]	Motherboard resources
[00000000FED19000 - 00000000FED19FFF]	Motherboard resources
[00000000FED20000 - 00000000FED3FFFF]	Motherboard resources
[00000000FED40000 - 00000000FED44FFF]	Trusted Platform Module 2.0
[00000000FED45000 - 00000000FED8FFFF]	Motherboard resources
[00000000FED90000 - 00000000FED93FFF]	Motherboard resources
[00000000FEE00000 - 00000000FEEFFFF]	Motherboard resources
[00000000FF000000 - 00000000FFFFFFF]	Legacy device
[00000000FF000000 - 00000000FFFFFFF]	Motherboard resources











































B.3 IRQ Mapping Chart











































IRQ	Device
(ISA) 0x00000000 (00)	System timer
(ISA) 0x00000003 (03)	Communications Port (COM2)
(ISA) 0x00000004 (04)	Communications Port (COM1)
(ISA) 0x00000008 (08)	System CMOS/real time clock
(ISA) 0x0000000B (11)	Communications Port (COM3)
(ISA) 0x0000000B (11)	Communications Port (COM4)
(ISA) 0x0000000C (12)	PS/2 Compatible Mouse
(ISA) 0x0000000E (14)	Motherboard resources
(ISA) 0x00000036 (54)	Microsoft ACPI-Compliant System
(ISA) 0x00000037 (55)	Microsoft ACPI-Compliant System
(ISA) 0x00000038 (56)	Microsoft ACPI-Compliant System
(ISA) 0x00000039 (57)	Microsoft ACPI-Compliant System
(ISA) 0x0000003A (58)	Microsoft ACPI-Compliant System
(ISA) 0x0000003B (59)	Microsoft ACPI-Compliant System
(ISA) 0x0000003C (60)	Microsoft ACPI-Compliant System
(ISA) 0x0000003D (61)	Microsoft ACPI-Compliant System
(ISA) 0x0000003E (62)	Microsoft ACPI-Compliant System
(ISA) 0x0000003F (63)	Microsoft ACPI-Compliant System
(ISA) 0x00000040 (64)	Microsoft ACPI-Compliant System
(ISA) 0x00000041 (65)	Microsoft ACPI-Compliant System
(ISA) 0x00000042 (66)	Microsoft ACPI-Compliant System
(ISA) 0x00000043 (67)	Microsoft ACPI-Compliant System
(ISA) 0x00000044 (68)	Microsoft ACPI-Compliant System
(ISA) 0x00000045 (69)	Microsoft ACPI-Compliant System
(ISA) 0x00000046 (70)	Microsoft ACPI-Compliant System
(ISA) 0x00000047 (71)	Microsoft ACPI-Compliant System
(ISA) 0x00000048 (72)	Microsoft ACPI-Compliant System
(ISA) 0x00000049 (73)	Microsoft ACPI-Compliant System
(ISA) 0x0000004A (74)	Microsoft ACPI-Compliant System
(ISA) 0x0000004B (75)	Microsoft ACPI-Compliant System
(ISA) 0x0000004C (76)	Microsoft ACPI-Compliant System
(ISA) 0x0000004D (77)	Microsoft ACPI-Compliant System
(ISA) 0x0000004E (78)	Microsoft ACPI-Compliant System
(ISA) 0x0000004F (79)	Microsoft ACPI-Compliant System
(ISA) 0x00000050 (80)	Microsoft ACPI-Compliant System
(ISA) 0x00000051 (81)	Microsoft ACPI-Compliant System
(ISA) 0x00000052 (82)	Microsoft ACPI-Compliant System
(ISA) 0x00000053 (83)	Microsoft ACPI-Compliant System
(ISA) 0x00000054 (84)	Microsoft ACPI-Compliant System
(ISA) 0x00000055 (85)	Microsoft ACPI-Compliant System
(ISA) 0x00000056 (86)	Microsoft ACPI-Compliant System











































 (ISA) 0x0000007F (127)	Microsoft ACPI-Compliant System
 (ISA) 0x00000080 (128)	Microsoft ACPI-Compliant System
 (ISA) 0x00000081 (129)	Microsoft ACPI-Compliant System
 (ISA) 0x00000082 (130)	Microsoft ACPI-Compliant System
 (ISA) 0x00000083 (131)	Microsoft ACPI-Compliant System
 (ISA) 0x00000084 (132)	Microsoft ACPI-Compliant System
 (ISA) 0x00000085 (133)	Microsoft ACPI-Compliant System
 (ISA) 0x00000086 (134)	Microsoft ACPI-Compliant System
 (ISA) 0x00000087 (135)	Microsoft ACPI-Compliant System
 (ISA) 0x00000088 (136)	Microsoft ACPI-Compliant System
 (ISA) 0x00000089 (137)	Microsoft ACPI-Compliant System
 (ISA) 0x0000008A (138)	Microsoft ACPI-Compliant System
 (ISA) 0x0000008B (139)	Microsoft ACPI-Compliant System
 (ISA) 0x0000008C (140)	Microsoft ACPI-Compliant System
 (ISA) 0x0000008D (141)	Microsoft ACPI-Compliant System
 (ISA) 0x0000008E (142)	Microsoft ACPI-Compliant System
 (ISA) 0x0000008F (143)	Microsoft ACPI-Compliant System
 (ISA) 0x00000090 (144)	Microsoft ACPI-Compliant System
 (ISA) 0x00000091 (145)	Microsoft ACPI-Compliant System
 (ISA) 0x00000092 (146)	Microsoft ACPI-Compliant System
 (ISA) 0x00000093 (147)	Microsoft ACPI-Compliant System
 (ISA) 0x00000094 (148)	Microsoft ACPI-Compliant System
 (ISA) 0x00000095 (149)	Microsoft ACPI-Compliant System
 (ISA) 0x00000096 (150)	Microsoft ACPI-Compliant System
 (ISA) 0x00000097 (151)	Microsoft ACPI-Compliant System
 (ISA) 0x00000098 (152)	Microsoft ACPI-Compliant System
 (ISA) 0x00000099 (153)	Microsoft ACPI-Compliant System
 (ISA) 0x0000009A (154)	Microsoft ACPI-Compliant System
 (ISA) 0x0000009B (155)	Microsoft ACPI-Compliant System
 (ISA) 0x0000009C (156)	Microsoft ACPI-Compliant System
 (ISA) 0x0000009D (157)	Microsoft ACPI-Compliant System
 (ISA) 0x0000009E (158)	Microsoft ACPI-Compliant System
 (ISA) 0x0000009F (159)	Microsoft ACPI-Compliant System
 (ISA) 0x000000A0 (160)	Microsoft ACPI-Compliant System
 (ISA) 0x000000A1 (161)	Microsoft ACPI-Compliant System
 (ISA) 0x000000A2 (162)	Microsoft ACPI-Compliant System
 (ISA) 0x000000A3 (163)	Microsoft ACPI-Compliant System
 (ISA) 0x000000A4 (164)	Microsoft ACPI-Compliant System
 (ISA) 0x000000A5 (165)	Microsoft ACPI-Compliant System
 (ISA) 0x000000A6 (166)	Microsoft ACPI-Compliant System
 (ISA) 0x000000A7 (167)	Microsoft ACPI-Compliant System
 (ISA) 0x000000A8 (168)	Microsoft ACPI-Compliant System











































 (ISA) 0x00000056 (86)	Microsoft ACPI-Compliant System
 (ISA) 0x00000057 (87)	Microsoft ACPI-Compliant System
 (ISA) 0x00000058 (88)	Microsoft ACPI-Compliant System
 (ISA) 0x00000059 (89)	Microsoft ACPI-Compliant System
 (ISA) 0x0000005A (90)	Microsoft ACPI-Compliant System
 (ISA) 0x0000005B (91)	Microsoft ACPI-Compliant System
 (ISA) 0x0000005C (92)	Microsoft ACPI-Compliant System
 (ISA) 0x0000005D (93)	Microsoft ACPI-Compliant System
 (ISA) 0x0000005E (94)	Microsoft ACPI-Compliant System
 (ISA) 0x0000005F (95)	Microsoft ACPI-Compliant System
 (ISA) 0x00000060 (96)	Microsoft ACPI-Compliant System
 (ISA) 0x00000061 (97)	Microsoft ACPI-Compliant System
 (ISA) 0x00000062 (98)	Microsoft ACPI-Compliant System
 (ISA) 0x00000063 (99)	Microsoft ACPI-Compliant System
 (ISA) 0x00000064 (100)	Microsoft ACPI-Compliant System
 (ISA) 0x00000065 (101)	Microsoft ACPI-Compliant System
 (ISA) 0x00000066 (102)	Microsoft ACPI-Compliant System
 (ISA) 0x00000067 (103)	Microsoft ACPI-Compliant System
 (ISA) 0x00000068 (104)	Microsoft ACPI-Compliant System
 (ISA) 0x00000069 (105)	Microsoft ACPI-Compliant System
 (ISA) 0x0000006A (106)	Microsoft ACPI-Compliant System
 (ISA) 0x0000006B (107)	Microsoft ACPI-Compliant System
 (ISA) 0x0000006C (108)	Microsoft ACPI-Compliant System
 (ISA) 0x0000006D (109)	Microsoft ACPI-Compliant System
 (ISA) 0x0000006E (110)	Microsoft ACPI-Compliant System
 (ISA) 0x0000006F (111)	Microsoft ACPI-Compliant System
 (ISA) 0x00000070 (112)	Microsoft ACPI-Compliant System
 (ISA) 0x00000071 (113)	Microsoft ACPI-Compliant System
 (ISA) 0x00000072 (114)	Microsoft ACPI-Compliant System
 (ISA) 0x00000073 (115)	Microsoft ACPI-Compliant System
 (ISA) 0x00000074 (116)	Microsoft ACPI-Compliant System
 (ISA) 0x00000075 (117)	Microsoft ACPI-Compliant System
 (ISA) 0x00000076 (118)	Microsoft ACPI-Compliant System
 (ISA) 0x00000077 (119)	Microsoft ACPI-Compliant System
 (ISA) 0x00000078 (120)	Microsoft ACPI-Compliant System
 (ISA) 0x00000079 (121)	Microsoft ACPI-Compliant System
 (ISA) 0x0000007A (122)	Microsoft ACPI-Compliant System
 (ISA) 0x0000007B (123)	Microsoft ACPI-Compliant System
 (ISA) 0x0000007C (124)	Microsoft ACPI-Compliant System
 (ISA) 0x0000007D (125)	Microsoft ACPI-Compliant System
 (ISA) 0x0000007E (126)	Microsoft ACPI-Compliant System
 (ISA) 0x0000007F (127)	Microsoft ACPI-Compliant System











































 (ISA) 0x000000A8 (168)	Microsoft ACPI-Compliant System
 (ISA) 0x000000A9 (169)	Microsoft ACPI-Compliant System
 (ISA) 0x000000AA (170)	Microsoft ACPI-Compliant System
 (ISA) 0x000000AB (171)	Microsoft ACPI-Compliant System
 (ISA) 0x000000AC (172)	Microsoft ACPI-Compliant System
 (ISA) 0x000000AD (173)	Microsoft ACPI-Compliant System
 (ISA) 0x000000AE (174)	Microsoft ACPI-Compliant System
 (ISA) 0x000000AF (175)	Microsoft ACPI-Compliant System
 (ISA) 0x000000B0 (176)	Microsoft ACPI-Compliant System
 (ISA) 0x000000B1 (177)	Microsoft ACPI-Compliant System
 (ISA) 0x000000B2 (178)	Microsoft ACPI-Compliant System
 (ISA) 0x000000B3 (179)	Microsoft ACPI-Compliant System
 (ISA) 0x000000B4 (180)	Microsoft ACPI-Compliant System
 (ISA) 0x000000B5 (181)	Microsoft ACPI-Compliant System
 (ISA) 0x000000B6 (182)	Microsoft ACPI-Compliant System
 (ISA) 0x000000B7 (183)	Microsoft ACPI-Compliant System
 (ISA) 0x000000B8 (184)	Microsoft ACPI-Compliant System
 (ISA) 0x000000B9 (185)	Microsoft ACPI-Compliant System
 (ISA) 0x000000BA (186)	Microsoft ACPI-Compliant System
 (ISA) 0x000000BB (187)	Microsoft ACPI-Compliant System
 (ISA) 0x000000BC (188)	Microsoft ACPI-Compliant System
 (ISA) 0x000000BD (189)	Microsoft ACPI-Compliant System
 (ISA) 0x000000BE (190)	Microsoft ACPI-Compliant System
 (ISA) 0x000000BF (191)	Microsoft ACPI-Compliant System
 (ISA) 0x000000C0 (192)	Microsoft ACPI-Compliant System
 (ISA) 0x000000C1 (193)	Microsoft ACPI-Compliant System
 (ISA) 0x000000C2 (194)	Microsoft ACPI-Compliant System
 (ISA) 0x000000C3 (195)	Microsoft ACPI-Compliant System
 (ISA) 0x000000C4 (196)	Microsoft ACPI-Compliant System
 (ISA) 0x000000C5 (197)	Microsoft ACPI-Compliant System
 (ISA) 0x000000C6 (198)	Microsoft ACPI-Compliant System
 (ISA) 0x000000C7 (199)	Microsoft ACPI-Compliant System
 (ISA) 0x000000C8 (200)	Microsoft ACPI-Compliant System
 (ISA) 0x000000C9 (201)	Microsoft ACPI-Compliant System
 (ISA) 0x000000CA (202)	Microsoft ACPI-Compliant System
 (ISA) 0x000000CB (203)	Microsoft ACPI-Compliant System
 (ISA) 0x000000CC (204)	Microsoft ACPI-Compliant System
 (ISA) 0x00000100 (256)	Microsoft ACPI-Compliant System
 (ISA) 0x00000101 (257)	Microsoft ACPI-Compliant System
 (ISA) 0x00000102 (258)	Microsoft ACPI-Compliant System
 (ISA) 0x00000103 (259)	Microsoft ACPI-Compliant System
 (ISA) 0x00000104 (260)	Microsoft ACPI-Compliant System











































 (ISA) 0x00000104 (260)	Microsoft ACPI-Compliant System
 (ISA) 0x00000105 (261)	Microsoft ACPI-Compliant System
 (ISA) 0x00000106 (262)	Microsoft ACPI-Compliant System
 (ISA) 0x00000107 (263)	Microsoft ACPI-Compliant System
 (ISA) 0x00000108 (264)	Microsoft ACPI-Compliant System
 (ISA) 0x00000109 (265)	Microsoft ACPI-Compliant System
 (ISA) 0x0000010A (266)	Microsoft ACPI-Compliant System
 (ISA) 0x0000010B (267)	Microsoft ACPI-Compliant System
 (ISA) 0x0000010C (268)	Microsoft ACPI-Compliant System
 (ISA) 0x0000010D (269)	Microsoft ACPI-Compliant System
 (ISA) 0x0000010E (270)	Microsoft ACPI-Compliant System
 (ISA) 0x0000010F (271)	Microsoft ACPI-Compliant System
 (ISA) 0x00000110 (272)	Microsoft ACPI-Compliant System
 (ISA) 0x00000111 (273)	Microsoft ACPI-Compliant System
 (ISA) 0x00000112 (274)	Microsoft ACPI-Compliant System
 (ISA) 0x00000113 (275)	Microsoft ACPI-Compliant System
 (ISA) 0x00000114 (276)	Microsoft ACPI-Compliant System
 (ISA) 0x00000115 (277)	Microsoft ACPI-Compliant System
 (ISA) 0x00000116 (278)	Microsoft ACPI-Compliant System
 (ISA) 0x00000117 (279)	Microsoft ACPI-Compliant System
 (ISA) 0x00000118 (280)	Microsoft ACPI-Compliant System
 (ISA) 0x00000119 (281)	Microsoft ACPI-Compliant System
 (ISA) 0x0000011A (282)	Microsoft ACPI-Compliant System
 (ISA) 0x0000011B (283)	Microsoft ACPI-Compliant System
 (ISA) 0x0000011C (284)	Microsoft ACPI-Compliant System
 (ISA) 0x0000011D (285)	Microsoft ACPI-Compliant System
 (ISA) 0x0000011E (286)	Microsoft ACPI-Compliant System
 (ISA) 0x0000011F (287)	Microsoft ACPI-Compliant System
 (ISA) 0x00000120 (288)	Microsoft ACPI-Compliant System
 (ISA) 0x00000121 (289)	Microsoft ACPI-Compliant System
 (ISA) 0x00000122 (290)	Microsoft ACPI-Compliant System
 (ISA) 0x00000123 (291)	Microsoft ACPI-Compliant System
 (ISA) 0x00000124 (292)	Microsoft ACPI-Compliant System
 (ISA) 0x00000125 (293)	Microsoft ACPI-Compliant System
 (ISA) 0x00000126 (294)	Microsoft ACPI-Compliant System
 (ISA) 0x00000127 (295)	Microsoft ACPI-Compliant System
 (ISA) 0x00000128 (296)	Microsoft ACPI-Compliant System
 (ISA) 0x00000129 (297)	Microsoft ACPI-Compliant System
 (ISA) 0x0000012A (298)	Microsoft ACPI-Compliant System
 (ISA) 0x0000012B (299)	Microsoft ACPI-Compliant System
 (ISA) 0x0000012C (300)	Microsoft ACPI-Compliant System
 (ISA) 0x0000012D (301)	Microsoft ACPI-Compliant System



























 (ISA) 0x0000012D (301)	Microsoft ACPI-Compliant System
 (ISA) 0x0000012E (302)	Microsoft ACPI-Compliant System
 (ISA) 0x0000012F (303)	Microsoft ACPI-Compliant System
 (ISA) 0x00000130 (304)	Microsoft ACPI-Compliant System
 (ISA) 0x00000131 (305)	Microsoft ACPI-Compliant System
 (ISA) 0x00000132 (306)	Microsoft ACPI-Compliant System
 (ISA) 0x00000133 (307)	Microsoft ACPI-Compliant System
 (ISA) 0x00000134 (308)	Microsoft ACPI-Compliant System
 (ISA) 0x00000135 (309)	Microsoft ACPI-Compliant System
 (ISA) 0x00000136 (310)	Microsoft ACPI-Compliant System
 (ISA) 0x00000137 (311)	Microsoft ACPI-Compliant System
 (ISA) 0x00000138 (312)	Microsoft ACPI-Compliant System
 (ISA) 0x00000139 (313)	Microsoft ACPI-Compliant System
 (ISA) 0x0000013A (314)	Microsoft ACPI-Compliant System
 (ISA) 0x0000013B (315)	Microsoft ACPI-Compliant System
 (ISA) 0x0000013C (316)	Microsoft ACPI-Compliant System
 (ISA) 0x0000013D (317)	Microsoft ACPI-Compliant System
 (ISA) 0x0000013E (318)	Microsoft ACPI-Compliant System
 (ISA) 0x0000013F (319)	Microsoft ACPI-Compliant System
 (ISA) 0x00000140 (320)	Microsoft ACPI-Compliant System
 (ISA) 0x00000141 (321)	Microsoft ACPI-Compliant System
 (ISA) 0x00000142 (322)	Microsoft ACPI-Compliant System
 (ISA) 0x00000143 (323)	Microsoft ACPI-Compliant System
 (ISA) 0x00000144 (324)	Microsoft ACPI-Compliant System
 (ISA) 0x00000145 (325)	Microsoft ACPI-Compliant System
 (ISA) 0x00000146 (326)	Microsoft ACPI-Compliant System
 (ISA) 0x00000147 (327)	Microsoft ACPI-Compliant System
 (ISA) 0x00000148 (328)	Microsoft ACPI-Compliant System
 (ISA) 0x00000149 (329)	Microsoft ACPI-Compliant System
 (ISA) 0x0000014A (330)	Microsoft ACPI-Compliant System
 (ISA) 0x0000014B (331)	Microsoft ACPI-Compliant System
 (ISA) 0x0000014C (332)	Microsoft ACPI-Compliant System
 (ISA) 0x0000014D (333)	Microsoft ACPI-Compliant System
 (ISA) 0x0000014E (334)	Microsoft ACPI-Compliant System
 (ISA) 0x0000014F (335)	Microsoft ACPI-Compliant System
 (ISA) 0x00000150 (336)	Microsoft ACPI-Compliant System
 (ISA) 0x00000151 (337)	Microsoft ACPI-Compliant System
 (ISA) 0x00000152 (338)	Microsoft ACPI-Compliant System
 (ISA) 0x00000153 (339)	Microsoft ACPI-Compliant System
 (ISA) 0x00000154 (340)	Microsoft ACPI-Compliant System
 (ISA) 0x00000155 (341)	Microsoft ACPI-Compliant System
 (ISA) 0x00000156 (342)	Microsoft ACPI-Compliant System

	(ISA) 0x00000156 (342)	Microsoft ACPI-Compliant System
	(ISA) 0x00000157 (343)	Microsoft ACPI-Compliant System
	(ISA) 0x00000158 (344)	Microsoft ACPI-Compliant System
	(ISA) 0x00000159 (345)	Microsoft ACPI-Compliant System
	(ISA) 0x0000015A (346)	Microsoft ACPI-Compliant System
	(ISA) 0x0000015B (347)	Microsoft ACPI-Compliant System
	(ISA) 0x0000015C (348)	Microsoft ACPI-Compliant System
	(ISA) 0x0000015D (349)	Microsoft ACPI-Compliant System
	(ISA) 0x0000015E (350)	Microsoft ACPI-Compliant System
	(ISA) 0x0000015F (351)	Microsoft ACPI-Compliant System
	(ISA) 0x00000160 (352)	Microsoft ACPI-Compliant System
	(ISA) 0x00000161 (353)	Microsoft ACPI-Compliant System
	(ISA) 0x00000162 (354)	Microsoft ACPI-Compliant System
	(ISA) 0x00000163 (355)	Microsoft ACPI-Compliant System
	(ISA) 0x00000164 (356)	Microsoft ACPI-Compliant System
	(ISA) 0x00000165 (357)	Microsoft ACPI-Compliant System
	(ISA) 0x00000166 (358)	Microsoft ACPI-Compliant System
	(ISA) 0x00000167 (359)	Microsoft ACPI-Compliant System
	(ISA) 0x00000168 (360)	Microsoft ACPI-Compliant System
	(ISA) 0x00000169 (361)	Microsoft ACPI-Compliant System
	(ISA) 0x0000016A (362)	Microsoft ACPI-Compliant System
	(ISA) 0x0000016B (363)	Microsoft ACPI-Compliant System
	(ISA) 0x0000016C (364)	Microsoft ACPI-Compliant System
	(ISA) 0x0000016D (365)	Microsoft ACPI-Compliant System
	(ISA) 0x0000016E (366)	Microsoft ACPI-Compliant System
	(ISA) 0x0000016F (367)	Microsoft ACPI-Compliant System
	(ISA) 0x00000170 (368)	Microsoft ACPI-Compliant System
	(ISA) 0x00000171 (369)	Microsoft ACPI-Compliant System
	(ISA) 0x00000172 (370)	Microsoft ACPI-Compliant System
	(ISA) 0x00000173 (371)	Microsoft ACPI-Compliant System
	(ISA) 0x00000174 (372)	Microsoft ACPI-Compliant System
	(ISA) 0x00000175 (373)	Microsoft ACPI-Compliant System
	(ISA) 0x00000176 (374)	Microsoft ACPI-Compliant System
	(ISA) 0x00000177 (375)	Microsoft ACPI-Compliant System
	(ISA) 0x00000178 (376)	Microsoft ACPI-Compliant System
	(ISA) 0x00000179 (377)	Microsoft ACPI-Compliant System
	(ISA) 0x0000017A (378)	Microsoft ACPI-Compliant System
	(ISA) 0x0000017B (379)	Microsoft ACPI-Compliant System
	(ISA) 0x0000017C (380)	Microsoft ACPI-Compliant System
	(ISA) 0x0000017D (381)	Microsoft ACPI-Compliant System
	(ISA) 0x0000017E (382)	Microsoft ACPI-Compliant System
	(ISA) 0x0000017F (383)	Microsoft ACPI-Compliant System

 (ISA) 0x0000017F (383)	Microsoft ACPI-Compliant System
 (ISA) 0x00000180 (384)	Microsoft ACPI-Compliant System
 (ISA) 0x00000181 (385)	Microsoft ACPI-Compliant System
 (ISA) 0x00000182 (386)	Microsoft ACPI-Compliant System
 (ISA) 0x00000183 (387)	Microsoft ACPI-Compliant System
 (ISA) 0x00000184 (388)	Microsoft ACPI-Compliant System
 (ISA) 0x00000185 (389)	Microsoft ACPI-Compliant System
 (ISA) 0x00000186 (390)	Microsoft ACPI-Compliant System
 (ISA) 0x00000187 (391)	Microsoft ACPI-Compliant System
 (ISA) 0x00000188 (392)	Microsoft ACPI-Compliant System
 (ISA) 0x00000189 (393)	Microsoft ACPI-Compliant System
 (ISA) 0x0000018A (394)	Microsoft ACPI-Compliant System
 (ISA) 0x0000018B (395)	Microsoft ACPI-Compliant System
 (ISA) 0x0000018C (396)	Microsoft ACPI-Compliant System
 (ISA) 0x0000018D (397)	Microsoft ACPI-Compliant System
 (ISA) 0x0000018E (398)	Microsoft ACPI-Compliant System
 (ISA) 0x0000018F (399)	Microsoft ACPI-Compliant System
 (ISA) 0x00000190 (400)	Microsoft ACPI-Compliant System
 (ISA) 0x00000191 (401)	Microsoft ACPI-Compliant System
 (ISA) 0x00000192 (402)	Microsoft ACPI-Compliant System
 (ISA) 0x00000193 (403)	Microsoft ACPI-Compliant System
 (ISA) 0x00000194 (404)	Microsoft ACPI-Compliant System
 (ISA) 0x00000195 (405)	Microsoft ACPI-Compliant System
 (ISA) 0x00000196 (406)	Microsoft ACPI-Compliant System
 (ISA) 0x00000197 (407)	Microsoft ACPI-Compliant System
 (ISA) 0x00000198 (408)	Microsoft ACPI-Compliant System
 (ISA) 0x00000199 (409)	Microsoft ACPI-Compliant System
 (ISA) 0x0000019A (410)	Microsoft ACPI-Compliant System
 (ISA) 0x0000019B (411)	Microsoft ACPI-Compliant System
 (ISA) 0x0000019C (412)	Microsoft ACPI-Compliant System
 (ISA) 0x0000019D (413)	Microsoft ACPI-Compliant System
 (ISA) 0x0000019E (414)	Microsoft ACPI-Compliant System
 (ISA) 0x0000019F (415)	Microsoft ACPI-Compliant System
 (ISA) 0x000001A0 (416)	Microsoft ACPI-Compliant System
 (ISA) 0x000001A1 (417)	Microsoft ACPI-Compliant System
 (ISA) 0x000001A2 (418)	Microsoft ACPI-Compliant System
 (ISA) 0x000001A3 (419)	Microsoft ACPI-Compliant System
 (ISA) 0x000001A4 (420)	Microsoft ACPI-Compliant System
 (ISA) 0x000001A5 (421)	Microsoft ACPI-Compliant System
 (ISA) 0x000001A6 (422)	Microsoft ACPI-Compliant System
 (ISA) 0x000001A7 (423)	Microsoft ACPI-Compliant System
 (ISA) 0x000001A8 (424)	Microsoft ACPI-Compliant System

 (ISA) 0x000001A8 (424)	Microsoft ACPI-Compliant System
 (ISA) 0x000001A9 (425)	Microsoft ACPI-Compliant System
 (ISA) 0x000001AA (426)	Microsoft ACPI-Compliant System
 (ISA) 0x000001AB (427)	Microsoft ACPI-Compliant System
 (ISA) 0x000001AC (428)	Microsoft ACPI-Compliant System
 (ISA) 0x000001AD (429)	Microsoft ACPI-Compliant System
 (ISA) 0x000001AE (430)	Microsoft ACPI-Compliant System
 (ISA) 0x000001AF (431)	Microsoft ACPI-Compliant System
 (ISA) 0x000001B0 (432)	Microsoft ACPI-Compliant System
 (ISA) 0x000001B1 (433)	Microsoft ACPI-Compliant System
 (ISA) 0x000001B2 (434)	Microsoft ACPI-Compliant System
 (ISA) 0x000001B3 (435)	Microsoft ACPI-Compliant System
 (ISA) 0x000001B4 (436)	Microsoft ACPI-Compliant System
 (ISA) 0x000001B5 (437)	Microsoft ACPI-Compliant System
 (ISA) 0x000001B6 (438)	Microsoft ACPI-Compliant System
 (ISA) 0x000001B7 (439)	Microsoft ACPI-Compliant System
 (ISA) 0x000001B8 (440)	Microsoft ACPI-Compliant System
 (ISA) 0x000001B9 (441)	Microsoft ACPI-Compliant System
 (ISA) 0x000001BA (442)	Microsoft ACPI-Compliant System
 (ISA) 0x000001BB (443)	Microsoft ACPI-Compliant System
 (ISA) 0x000001BC (444)	Microsoft ACPI-Compliant System
 (ISA) 0x000001BD (445)	Microsoft ACPI-Compliant System
 (ISA) 0x000001BE (446)	Microsoft ACPI-Compliant System
 (ISA) 0x000001BF (447)	Microsoft ACPI-Compliant System
 (ISA) 0x000001C0 (448)	Microsoft ACPI-Compliant System
 (ISA) 0x000001C1 (449)	Microsoft ACPI-Compliant System
 (ISA) 0x000001C2 (450)	Microsoft ACPI-Compliant System
 (ISA) 0x000001C3 (451)	Microsoft ACPI-Compliant System
 (ISA) 0x000001C4 (452)	Microsoft ACPI-Compliant System
 (ISA) 0x000001C5 (453)	Microsoft ACPI-Compliant System
 (ISA) 0x000001C6 (454)	Microsoft ACPI-Compliant System
 (ISA) 0x000001C7 (455)	Microsoft ACPI-Compliant System
 (ISA) 0x000001C8 (456)	Microsoft ACPI-Compliant System
 (ISA) 0x000001C9 (457)	Microsoft ACPI-Compliant System
 (ISA) 0x000001CA (458)	Microsoft ACPI-Compliant System
 (ISA) 0x000001CB (459)	Microsoft ACPI-Compliant System
 (ISA) 0x000001CC (460)	Microsoft ACPI-Compliant System
 (ISA) 0x000001CD (461)	Microsoft ACPI-Compliant System
 (ISA) 0x000001CE (462)	Microsoft ACPI-Compliant System
 (ISA) 0x000001CF (463)	Microsoft ACPI-Compliant System
 (ISA) 0x000001D0 (464)	Microsoft ACPI-Compliant System
 (ISA) 0x000001D1 (465)	Microsoft ACPI-Compliant System

 (ISA) 0x000001D1 (465)	Microsoft ACPI-Compliant System
 (ISA) 0x000001D2 (466)	Microsoft ACPI-Compliant System
 (ISA) 0x000001D3 (467)	Microsoft ACPI-Compliant System
 (ISA) 0x000001D4 (468)	Microsoft ACPI-Compliant System
 (ISA) 0x000001D5 (469)	Microsoft ACPI-Compliant System
 (ISA) 0x000001D6 (470)	Microsoft ACPI-Compliant System
 (ISA) 0x000001D7 (471)	Microsoft ACPI-Compliant System
 (ISA) 0x000001D8 (472)	Microsoft ACPI-Compliant System
 (ISA) 0x000001D9 (473)	Microsoft ACPI-Compliant System
 (ISA) 0x000001DA (474)	Microsoft ACPI-Compliant System
 (ISA) 0x000001DB (475)	Microsoft ACPI-Compliant System
 (ISA) 0x000001DC (476)	Microsoft ACPI-Compliant System
 (ISA) 0x000001DD (477)	Microsoft ACPI-Compliant System
 (ISA) 0x000001DE (478)	Microsoft ACPI-Compliant System
 (ISA) 0x000001DF (479)	Microsoft ACPI-Compliant System
 (ISA) 0x000001E0 (480)	Microsoft ACPI-Compliant System
 (ISA) 0x000001E1 (481)	Microsoft ACPI-Compliant System
 (ISA) 0x000001E2 (482)	Microsoft ACPI-Compliant System
 (ISA) 0x000001E3 (483)	Microsoft ACPI-Compliant System
 (ISA) 0x000001E4 (484)	Microsoft ACPI-Compliant System
 (ISA) 0x000001E5 (485)	Microsoft ACPI-Compliant System
 (ISA) 0x000001E6 (486)	Microsoft ACPI-Compliant System
 (ISA) 0x000001E7 (487)	Microsoft ACPI-Compliant System
 (ISA) 0x000001E8 (488)	Microsoft ACPI-Compliant System
 (ISA) 0x000001E9 (489)	Microsoft ACPI-Compliant System
 (ISA) 0x000001EA (490)	Microsoft ACPI-Compliant System
 (ISA) 0x000001EB (491)	Microsoft ACPI-Compliant System
 (ISA) 0x000001EC (492)	Microsoft ACPI-Compliant System
 (ISA) 0x000001ED (493)	Microsoft ACPI-Compliant System
 (ISA) 0x000001EE (494)	Microsoft ACPI-Compliant System
 (ISA) 0x000001EF (495)	Microsoft ACPI-Compliant System
 (ISA) 0x000001F0 (496)	Microsoft ACPI-Compliant System
 (ISA) 0x000001F1 (497)	Microsoft ACPI-Compliant System
 (ISA) 0x000001F2 (498)	Microsoft ACPI-Compliant System
 (ISA) 0x000001F3 (499)	Microsoft ACPI-Compliant System
 (ISA) 0x000001F4 (500)	Microsoft ACPI-Compliant System
 (ISA) 0x000001F5 (501)	Microsoft ACPI-Compliant System
 (ISA) 0x000001F6 (502)	Microsoft ACPI-Compliant System
 (ISA) 0x000001F7 (503)	Microsoft ACPI-Compliant System
 (ISA) 0x000001F8 (504)	Microsoft ACPI-Compliant System
 (ISA) 0x000001F9 (505)	Microsoft ACPI-Compliant System
 (ISA) 0x000001FA (506)	Microsoft ACPI-Compliant System

	(ISA) 0x000001FA (506)	Microsoft ACPI-Compliant System
	(ISA) 0x000001FB (507)	Microsoft ACPI-Compliant System
	(ISA) 0x000001FC (508)	Microsoft ACPI-Compliant System
	(ISA) 0x000001FD (509)	Microsoft ACPI-Compliant System
	(ISA) 0x000001FE (510)	Microsoft ACPI-Compliant System
	(ISA) 0x000001FF (511)	Microsoft ACPI-Compliant System
	(PCI) 0x0000000B (11)	Mobile 6th/7th Generation Intel(R) Processor Family I/O Thermal subsystem - 9D31
	(PCI) 0x0000000B (11)	Mobile 6th/7th Generation Intel(R) Processor Family I/O SMBUS - 9D23
	(PCI) 0x00000010 (16)	High Definition Audio Controller
	(PCI) 0xFFFFFFFFE (-18)	Intel(R) I210 Gigabit Network Connection #2
	(PCI) 0xFFFFFFFFF (-17)	Intel(R) I210 Gigabit Network Connection #2
	(PCI) 0xFFFFFFFF0 (-16)	Intel(R) I210 Gigabit Network Connection #2
	(PCI) 0xFFFFFFFF1 (-15)	Intel(R) I210 Gigabit Network Connection #2
	(PCI) 0xFFFFFFFF2 (-14)	Intel(R) I210 Gigabit Network Connection #2
	(PCI) 0xFFFFFFFF3 (-13)	Intel(R) I210 Gigabit Network Connection #2
	(PCI) 0xFFFFFFFF4 (-12)	Intel(R) I210 Gigabit Network Connection
	(PCI) 0xFFFFFFFF5 (-11)	Intel(R) I210 Gigabit Network Connection
	(PCI) 0xFFFFFFFF6 (-10)	Intel(R) I210 Gigabit Network Connection
	(PCI) 0xFFFFFFFF7 (-9)	Intel(R) I210 Gigabit Network Connection
	(PCI) 0xFFFFFFFF8 (-8)	Intel(R) I210 Gigabit Network Connection
	(PCI) 0xFFFFFFFF9 (-7)	Intel(R) I210 Gigabit Network Connection
	(PCI) 0xFFFFFFFFFA (-6)	Intel(R) USB 3.0 eXtensible Host Controller - 1.0 (Microsoft)
	(PCI) 0xFFFFFFFFFB (-5)	Intel(R) HD Graphics 610
	(PCI) 0xFFFFFFFFFC (-4)	Standard SATA AHCI Controller
	(PCI) 0xFFFFFFFFFD (-3)	Mobile 6th/7th Generation Intel(R) Processor Family I/O PCI Express Root Port #4 - 9D13
	(PCI) 0xFFFFFFFFFE (-2)	Mobile 6th/7th Generation Intel(R) Processor Family I/O PCI Express Root Port #3 - 9D12

Appendix C

Electrical Specifications for I/O Ports

C.1 Electrical Specifications for I/O Ports

I/O	Reference	Signal Name	Rate Output
DVI Port	CN3	+5V	+5V/1A (reserved)
DP port	CN5	+3.3V	+3.3V/1A
LVDS Port	CN6	+3.3V/+5V	+3.3V/2A or +5V/2A
LVDS Port Inverter / Backlight Connector	CN7	+5V/+12V	+5V/1.5A or +12V/1.5A
Mini-Card Slot (Full-Mini Card)	CN11	+3.3VSB +1.5V	+3.3V/1.1A +1.5V/0.375A
Mini-Card Slot (Half-Mini Card)	CN13	+3.3VSB +1.5V	+3.3V/1.1A +1.5V/0.375A
+5V Output for SATA HDD	CN15	+5V	+5V/1A
USB 3.0 Ports	CN18	+5VSB	+5V/1A (per channel)
USB 3.0 Ports	CN19	+5VSB	+5V/1A (per channel)
USB 2.0 Ports	CN20	+5VSB	+5V/0.5A (per channel)
USB 2.0 Ports	CN21	+5VSB	+5V/0.5A (per channel)
Audio I/O Port	CN22	+5V	+5V/1A
Digital IO Port	CN24	+5V	+5V/1A
COM Port 4	CN26	+5V/+12V	+5V/0.5A or +12V/0.5A
COM Port 2	CN27	+5V/+12V	+5V/0.5A or +12V/0.5A
COM Port 3	CN28	+5V/+12V	+5V/0.5A or +12V/0.5A
LPC Port	CN29	+3.3V	+3.3V/0.5A
CPU FAN	CN36	+12V	+12V/0.5A

Appendix D

Digital I/O Ports

D.1 Electrical Specifications for Digital I/O Ports

Table 1 : Digital Input/Output Pin Electrical Specification

Pin	Type	Input Threshold Voltage		Output Voltage		Note
		Low	High	Low	High	
DIO0	I/O	0.8	2.0	0	5	
DIO1	I/O	0.8	2.0	0	5	
DIO2	I/O	0.8	2.0	0	5	
DIO3	I/O	0.8	2.0	0	5	
DIO4	I/O	0.8	2.0	0	5	
DIO5	I/O	0.8	2.0	0	5	
DIO6	I/O	0.8	2.0	0	5	
DIO7	I/O	0.8	2.0	0	5	

Note: All DIO pins are 5V tolerant in input mode.

D.2 DI/O Programming

GENE-KBU6 utilizes FINTEK F81866D chipset as its Digital I/O controller. Below are the procedures to complete its configuration and the AAEON initial DI/O program is also attached, based on which you can develop customized program to fit your application.

There are three steps to complete the configuration setup:

- (1) Enter the MB PnP Mode
- (2) Modify the data of configuration registers
- (3) Exit the MB PnP Mode. Undesired result may occur if the MB PnP Mode is not exited normally.

D.3 Digital I/O Register

Table 2 : SuperIO relative register table		
	Default Value	Note
Index	0x2E	SIO MB PnP Mode Index Register 0x2E or 0x4E
Data	0x2F)	SIO MB PnP Mode Data Register 0x2F or 0x4F

Table 3 : Digital Input/Output relative register table				
	LDN	Register	Bit	Note
DIO0 Direction	0x06	0xA0	0	0:input, 1: output
DIO1 Direction	0x06	0xA0	1	
DIO2 Direction	0x06	0xA0	2	
DIO3 Direction	0x06	0xA0	3	
DIO4 Direction	0x06	0xA0	4	
DIO5 Direction	0x06	0xA0	5	
DIO6 Direction	0x06	0xA0	6	
DIO7 Direction	0x06	0xA0	7	
DIO0 Output Level	0x06	0xA1	0	0:low, 1: high
DIO1 Output Level	0x06	0xA1	1	
DIO2 Output Level	0x06	0xA1	2	
DIO3 Output Level	0x06	0xA1	3	
DIO4 Output Level	0x06	0xA1	4	
DIO5 Output Level	0x06	0xA1	5	
DIO6 Output Level	0x06	0xA1	6	
DIO7 Output Level	0x06	0xA1	7	
DIO0 Status	0x06	0xA2	0	0:low, 1: high
DIO1 Status	0x06	0xA2	1	
DIO2 Status	0x06	0xA2	2	
DIO3 Status	0x06	0xA2	3	
DIO4 Status	0x06	0xA2	4	
DIO5 Status	0x06	0xA2	5	
DIO6 Status	0x06	0xA2	6	
DIO7 Status	0x06	0xA2	7	

D.4 Digital I/O Sample Program

```

*****
// SuperIO relative definition (Please reference to Table 2)
#define SIOIndex 0x2E
#define SIOData 0x2F
#define DIOLDN 0x06
IOWriteByte(byte IOPort, byte Value);
IOReadByte(byte IOPort);
// DIO relative definition (Please reference to Table 3)
#define DirReg 0xA0 // 0:input, 1: output
    #define InputPin 0x00
    #define OutputPin 0x01
#define OutputReg 0xA1 // 0:low, 1: high
#define StatusReg 0xA2 // 0:low, 1: high
    #define PinLow 0x00
    #define PinHigh 0x01
#define Pin0Bit 0x00
#define Pin1Bit 0x01
#define Pin2Bit 0x02
#define Pin3Bit 0x03
#define Pin4Bit 0x04
#define Pin5Bit 0x05
#define Pin6Bit 0x06
#define Pin7Bit 0x07
*****

*****

VOID Main(){
    Boolean PinStatus ;

    // Procedure : AaeonReadPinStatus
    // Input :
    // Example, Read Digital I/O Pin 3 status
    // Output :
    // InputStatus :
    // 0: Digital I/O Pin level is low
    // 1: Digital I/O Pin level is High
    PinStatus = AaeonReadPinStatus(Pin3Bit);

    // Procedure : AaeonSetOutputLevel

```

```

// Input :
// Example, Set Digital I/O Pin 2 to high level
AaeonSetOutputLevel(Pin2Bit, PinHigh);
}
*****

*****

Boolean AaeonReadPinStatus(byte PinBit){
    Boolean PinStatus ;
    PinStatus = SIOBitRead(DIOLDN, StatusReg, PinBit);
    Return PinStatus ;
}
VOID AaeonSetOutputLevel(byte PinBit, byte Value){
    ConfigDioMode(PinBit, OutputPin);
    SIOBitSet(DIOLDN, OutputReg, PinBit, Value);
}
*****

*****VOID
SIOEnterMBPnPMode(){
    IOWriteByte(SIOIndex, 0x87);
    IOWriteByte(SIOIndex, 0x87);
}

VOID SIOExitMBPnPMode(){
    IOWriteByte(SIOIndex, 0xAA);
}

VOID SIOSelectLDN(byte LDN){
    IOWriteByte(SIOIndex, 0x07); // SIO LDN Register Offset = 0x07
    IOWriteByte(SIOData, LDN);
}

VOID SIOBitSet(byte LDN, byte Register, byte BitNum, byte Value){
    Byte TmpValue;

    SIOEnterMBPnPMode();
    SIOSelectLDN(LDN);
    IOWriteByte(SIOIndex, Register);
    TmpValue = IOReadByte(SIOData);
    TmpValue &= ~(1 << BitNum);
    TmpValue |= (Value << BitNum);
}

```

```

        IOWriteByte(SIOData, TmpValue);
        SIOExitMBPnPMode();
    }

VOID  SIOByteSet(byte LDN, byte Register, byte Value){
    SIOEnterMBPnPMode();
    SIOSelectLDN(LDN);
    IOWriteByte(SIOIndex, Register);
    IOWriteByte(SIOData, Value);
    SIOExitMBPnPMode();
}

*****

*****

Boolean  SIOBitRead(byte LDN, byte Register, byte BitNum){
    Byte TmpValue;

    SIOEnterMBPnPMode();
    SIOSelectLDN(LDN);
    IOWriteByte(SIOIndex, Register);
    TmpValue = IOReadByte(SIOData);
    TmpValue &= (1 << BitNum);
    SIOExitMBPnPMode();
    If(TmpValue == 0)
        Return 0;
    Return 1;
}

VOID  ConfigDioMode(byte PinBit, byte Mode){
    Byte TmpValue;

    SIOEnterMBPnPMode();
    SIOSelectLDN(DIOLDN);
    IOWriteByte(SIOIndex, DirReg);
    TmpValue = IOReadByte(SIOData);
    TmpValue |= (Mode << PinBit);
    IOWriteByte(SIOData, DirReg);
    SIOExitMBPnPMode();
}

*****

```

Appendix E

Mating Connectors and Cables

E.1 Mating Connectors and Cables

Connector Label	Function	Mating Connector		Available Cable	Cable P/N
		Vendor	Model no		
CN1	External RTC Connector	Molex	51021-0200	Battery Cable	175011901C
CN6	LVDS Connector	HIROSE	DF13-30DS-1.25C	N/A	N/A
CN7	LVDS Inverter Connector	JST	PHR-5	N/A	N/A
CN14	SATA Connector	Molex	88750-5318	SATA Cable	1709070500
CN15	+5Vout Connector	JST	PHR-2	2 Pins For HDD Power	1702150155
CN20	USB Port Connector	Molex	51021-0500	USB Wafer Cable	1700050207
CN21	USB Port Connector	Molex	51021-0500	USB Wafer Cable	1700050207
CN22	Audio Connector	Molex	51021-1000	Audio Cable	1709100254
CN23	Touch Screen Connector	JST	SHR-9V-S-B	N/A	N/A
CN24	Digital I/O Connector	Neltron	2026B-10	N/A	N/A
CN25	COM Port 1 Connector	Molex	51021-0900	Serial Port Cable	1701090150
CN26	COM Port 4 Connector	Molex	51021-0900	Serial Port Cable	1701090150
CN27	COM Port 2 Connector	Molex	51021-0900	Serial Port Cable	1701090150
CN28	COM Port 3 Connector	Molex	51021-0900	Serial Port Cable	1701090150

Connector Label	Function	Mating Connector		Available Cable	Cable P/N
		Vendor	Model no		
CN30	+9~36V Vin Connector	N/A	N/A	Power Cable	1702002010
CN32	External +5VSB Power output and PS_ON#	Catch Electronics	2418HJ-06	N/A	N/A
CN33	External +5VSB Power Input and PS_ON#	JST	PHR-3	ATX Cable	170220020B
CN36	CPU Fan Connector	Molex	22-01-2035	N/A	N/A