

GENE-BT05 A1.1

3.5" Subcompact Board

User's Manual 9th Ed

Copyright Notice

This document is copyrighted, 2019. All rights are reserved. The original manufacturer reserves the right to make improvements to the products described in this manual at any time without notice.

No part of this manual may be reproduced, copied, translated, or transmitted in any form or by any means without the prior written permission of the original manufacturer. Information provided in this manual is intended to be accurate and reliable. However, the original manufacturer assumes no responsibility for its use, or for any infringements upon the rights of third parties that may result from its use.

The material in this document is for product information only and is subject to change without notice. While reasonable efforts have been made in the preparation of this document to assure its accuracy, AAEMON assumes no liabilities resulting from errors or omissions in this document, or from the use of the information contained herein.

AAEMON reserves the right to make changes in the product design without notice to its users.

Acknowledgement

All other products' name or trademarks are properties of their respective owners.

- Microsoft Windows is a registered trademark of Microsoft Corp.
- Intel, Pentium, Celeron, and Xeon are registered trademarks of Intel Corporation
- Core, Atom are trademarks of Intel Corporation
- ITE is a trademark of Integrated Technology Express, Inc.
- IBM, PC/AT, PS/2, and VGA are trademarks of International Business Machines Corporation.

All other product names or trademarks are properties of their respective owners.

Packing List

Before setting up your product, please make sure the following items have been shipped:

Item	Quantity
GENE-BT05 A1.1 with Passive Heatsink	1

If any of these items are missing or damaged, please contact your distributor or sales representative immediately.

About this Document

This User's Manual contains all the essential information, such as detailed descriptions and explanations on the product's hardware and software features (if any), its specifications, dimensions, jumper/connector settings/definitions, and driver installation instructions (if any), to facilitate users in setting up their product.

Users may refer to the product page at AAEON.com for the latest version of this document.

Safety Precautions

Please read the following safety instructions carefully. It is advised that you keep this manual for future references

1. All cautions and warnings on the device should be noted.
2. Make sure the power source matches the power rating of the device.
3. Position the power cord so that people cannot step on it. Do not place anything over the power cord.
4. Always completely disconnect the power before working on the system's hardware.
5. No connections should be made when the system is powered as a sudden rush of power may damage sensitive electronic components.
6. If the device is not to be used for a long time, disconnect it from the power supply to avoid damage by transient over-voltage.
7. Always disconnect this device from any AC supply before cleaning.
8. While cleaning, use a damp cloth instead of liquid or spray detergents.
9. Make sure the device is installed near a power outlet and is easily accessible.
10. Keep this device away from humidity.
11. Place the device on a solid surface during installation to prevent falls
12. Do not cover the openings on the device to ensure optimal heat dissipation.
13. Watch out for high temperatures when the system is running.
14. Do not touch the heat sink or heat spreader when the system is running
15. Never pour any liquid into the openings. This could cause fire or electric shock.
16. As most electronic components are sensitive to static electrical charge, be sure to ground yourself to prevent static charge when installing the internal components. Use a grounding wrist strap and contain all electronic components in any static-shielded containers.

17. If any of the following situations arises, please the contact our service personnel:
 - i. Damaged power cord or plug
 - ii. Liquid intrusion to the device
 - iii. Exposure to moisture
 - iv. Device is not working as expected or in a manner as described in this manual
 - v. The device is dropped or damaged
 - vi. Any obvious signs of damage displayed on the device
18. **DO NOT LEAVE THIS DEVICE IN AN UNCONTROLLED ENVIRONMENT WITH TEMPERATURES BEYOND THE DEVICE'S PERMITTED STORAGE TEMPERATURES (SEE CHAPTER 1) TO PREVENT DAMAGE.**

Warning!



This device complies with Part 15 FCC Rules. Operation is subject to the following two conditions: (1) this device may not cause harmful interference, and (2) this device must accept any interference received including interference that may cause undesired operation.

Caution:

There is a danger of explosion if the battery is incorrectly replaced. Replace only with the same or equivalent type recommended by the manufacturer. Dispose of used batteries according to the manufacturer's instructions and your local government's recycling or disposal directives.

Attention:

Il y a un risque d'explosion si la batterie est remplacée de façon incorrecte. Ne la remplacer qu'avec le même modèle ou équivalent recommandé par le constructeur. Recycler les batteries usées en accord avec les instructions du fabricant et les directives gouvernementales de recyclage.

China RoHS Requirements (CN)

产品中有毒有害物质或元素名称及含量

AAEON Main Board/ Daughter Board/ Backplane

部件名称	有毒有害物质或元素					
	铅 (Pb)	汞 (Hg)	镉 (Cd)	六价铬 (Cr(VI))	多溴联苯 (PBB)	多溴二苯醚 (PBDE)
印刷电路板 及其电子组件	○	○	○	○	○	○
外部信号 连接器及线材	○	○	○	○	○	○
<p>O: 表示该有毒有害物质在该部件所有均质材料中的含量均在 SJ/T 11363-2006 标准规定的限量要求以下。</p> <p>X: 表示该有毒有害物质至少在该部件的某一均质材料中的含量超出 SJ/T 11363-2006 标准规定的限量要求。</p> <p>备注: 此产品所标示之环保使用期限, 系指在一般正常使用状况下。</p>						

China RoHS Requirement (EN)

Poisonous or Hazardous Substances or Elements in Products

AAEON Main Board/ Daughter Board/ Backplane

Component	Poisonous or Hazardous Substances or Elements					
	Lead (Pb)	Mercury (Hg)	Cadmium (Cd)	Hexavalent Chromium (Cr(VI))	Polybrominated Biphenyls (PBB)	Polybrominated Diphenyl Ethers (PBDE)
PCB & Other Components	○	○	○	○	○	○
Wires & Connectors for External Connections	○	○	○	○	○	○
<p>O: The quantity of poisonous or hazardous substances or elements found in each of the component's parts is below the SJ/T 11363-2006-stipulated requirement.</p> <p>X: The quantity of poisonous or hazardous substances or elements found in at least one of the component's parts is beyond the SJ/T 11363-2006-stipulated requirement.</p> <p>Note: The Environment Friendly Use Period as labeled on this product is applicable under normal usage only</p>						

Table of Contents

Chapter 1 - Product Specifications	1
1.1 Specifications	2
Chapter 2 – Hardware Information	4
2.1 Dimensions	5
2.2 Jumpers and Connectors	9
2.3 List of Jumpers	13
2.3.1 LVDS Port Backlight Inverter VCC Selection (JP1).....	14
2.3.2 LVDS Port Backlight Lightness Control Mode Selection (JP3)	14
2.3.3 LVDS Port Operating VDD Selection (JP4)	15
2.3.4 COM3 Pin8 Function Selection (JP8).....	15
2.3.5 COM2 Pin8 Function Selection (JP9).....	16
2.3.6 Auto Power Button Enable/Disable Selection (JP17)	16
2.3.7 Front Panel Connector (JP19)	17
2.3.8 Touchscreen 4/ 5/ 8 Wire Selection (JP20)	17
2.3.9 Clear CMOS Jumper (JP21)	18
2.4 List of Connectors	19
2.4.1 +5VSB Output w/SMBus (CN1).....	21
2.4.2 LVDS Port Inverter / Backlight Connector (CN3)	22
2.4.3 +5V Output for SATA HDD (CN4).....	22
2.4.4 External +5VSB Input (CN5)	23
2.4.5 SATA Port (CN6).....	24
2.4.6 External +12V Input (CN7)	24
2.4.7 LVDS Port (CN8)	25
2.4.8 Audio I/O Port (CN9)	27
2.4.9 Mini-Card Slot (Half Mini-Card) (CN10).....	28
2.4.10 LPC Port (CN11).....	31

2.4.11	COM Port 2 (CN12)	32
2.4.12	COM Port 3 (CN14)	35
2.4.13	COM Port 4 (CN15)	38
2.4.14	Digital I/O Port (CN16)	39
2.4.15	USB 2.0 Port 3 (CN17)	40
2.4.16	USB 2.0 Port 2 (CN18)	40
2.4.17	BIOS Debug Port (CN19)	41
2.4.18	PS/2 Keyboard/Mouse Combo Port (CN22)	42
2.4.19	Touchscreen Connector (CN23)	42
2.4.20	CPU FAN (Optional) (CN24)	45
2.4.21	USB Ports 0 and 1 (CN25)	45
2.4.22	LAN (RJ-45) Port2 (CN26)	46
2.4.23	LAN (RJ-45) Port1 (CN27)	47
2.4.24	COM Port 1 (D-SUB 9) (CN28)	47
2.4.25	HDMI Port (CN29)	48
2.4.26	VGA Port (CN30)	49
2.4.27	Battery (CN31)	50
2.4.28	CFast Slot (CN33)	50
2.4.29	DDR3L SO-DIMM Slot (CN34)	51
2.4.30	UIM Card Socket (CN35)	51
2.4.31	Mini-Card Slot (Full Mini-Card) (CN37)	52
2.5	Function Block	54
Chapter 3 - AMI BIOS Setup		55
3.1	System Test and Initialization	56
3.2	AMI BIOS Setup	57
3.3	Setup submenu: Main	58
3.4	Setup submenu: Advanced	59
3.4.1	Advanced: Power Management	60

3.4.1.1	Power Management: S5 RTC Wake Settings.....	62
3.4.2	Advanced: Super IO Configuration	63
3.4.2.1	Serial Port 1 Configuration.....	64
3.4.2.2	Serial Port 2 Configuration	65
3.4.2.3	Serial Port 3 Configuration	66
3.4.2.4	Serial Port 4 Configuration	67
3.4.2.5	Smart Fan Mod Configuration.....	68
3.4.3	Advanced: Digital IO	69
3.4.4	Advanced: H/W Monitor	70
3.4.5	Advanced: CPU Configuration.....	71
3.4.5.1	Socket 0 CPU Information	72
3.4.6	Advanced: IDE Configuration.....	73
3.4.7	Advanced: CSM Configuration	74
3.4.8	Advanced: Trusted Computing	76
3.4.9	Advanced: USB Configuration	77
3.4.10	Advanced: Touch Device	78
3.5	Setup submenu: Chipset	79
3.5.1	Chipset: Host Bridge.....	80
3.5.1.1	Host Bridge: IGD – LCD Control.....	81
3.5.2	Chipset: South Bridge	83
3.5.2.1	South Bridge: Azallia HD Audio	84
3.5.2.2	South Bridge: USB Configuration	85
3.5.2.3	South Bridge: PCI Express Configuration	86
3.6	Setup submenu: Security	87
3.7	Setup submenu: Boot	88
3.8	Setup submenu: Save & Exit	89
Chapter 4 – Drivers Installation.....		90
4.1	Driver Download/Installation	91

Appendix A - Watchdog Timer Programming	99
A.1 Watchdog Timer Registers.....	100
A.2 Watchdog Sample Program.....	101
Appendix B - I/O Information	104
B.1 I/O Address Map.....	105
B.2 Memory Address Map.....	106
B.3 IRQ Mapping Chart	107
B.4 DMA Channel Assignments.....	110
Appendix C – Mating Connectors	111
C.1 List of Mating Connectors and Cables	112
Appendix D – Electrical Specifications for I/O Ports	114
D.1 Electrical Specifications for I/O Ports	115

Chapter 1

Product Specifications

1.1 Specifications

System

Form Factor	3.5" Subcompact Board
CPU	Intel® N2930/N2807/J1900/E3845/E3825
CPU Frequency	Up to 2.0GHz
Chipset	Intel® N2930/N2807/J1900/E3845/E3825
Memory Type	DDR3L 1066/1333, SODIMM x 1
Max. Memory Capacity	Up to 8G
BIOS	UEFI
Wake on LAN	Yes
Watchdog Timer	255 Levels
Power Requirement	+12V
Power Supply Type	AT/ATX
Power Consumption (Typical)	Intel® N2930, DDR3L 1600MHz 8G, 0.65A@+12V
Dimension (L x W)	5.75" x 4" (146mm x 101.6mm)
Operating Temperature	32°F ~ 140°F (0°C ~ 60°C)
Storage Temperature	-40°F ~ 176°F (-40°C ~ 80°C)
Operating Humidity	0% ~ 90% relative humidity, non-condensing
MTBF (Hours)	111,000
Certification	CE/FCC

Display

VGA/LCD Controller	Intel® N2930/N2807/J1900/E3845/E3825
Video Output	CRT+LVDS, HDMI+LVDS, CRT+HDMI
Backlight inverter supply	Up to 24-bit dual-channel LVDS x 1

I/O

Ethernet	Intel® I211 (or 210), 10/100/1000Base-TX, RJ-45 x 2
Audio	High definition audio interface
USB Port	USB2.0 x 3, USB 3.0 x 1
Serial Port	RS-232 x 2, RS-232/422/485 x 2
Parallel Port	—
HDD Interface	SATA 2.0 x 1
FDD Interface	—
SSD	CFast™ (alternative with mSATA by BOM and also occupy one Mini-Card location)
Expansion Slot	Mini-Card x 2(Full-size x 1, Half-size x 1)
DIO	8-bit
SIM	x 1
TPM	x 1
Touch	x 1

Note: Audio may not function properly in harsh environments

Chapter 2

Hardware Information

2.1 Dimensions

Standard Version (Component Side)

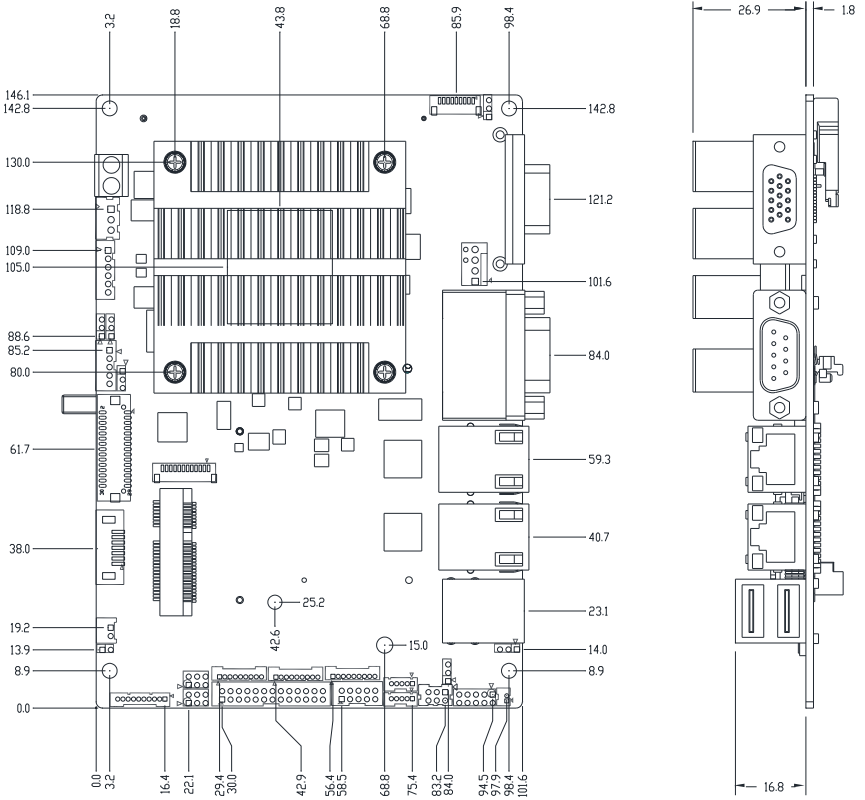

Standard Version (Solder Side)

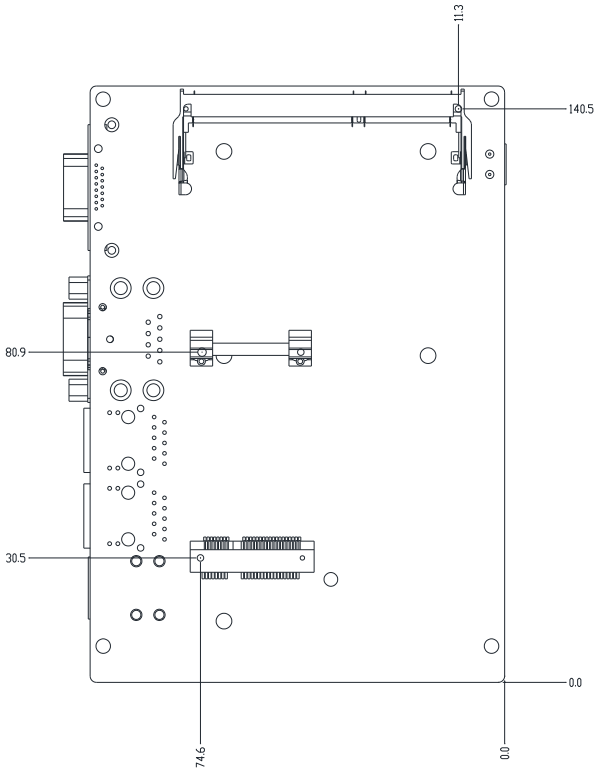

Advanced Version (Component Side)

3.5" Subcompact Board

GENE-BT05 A1.1

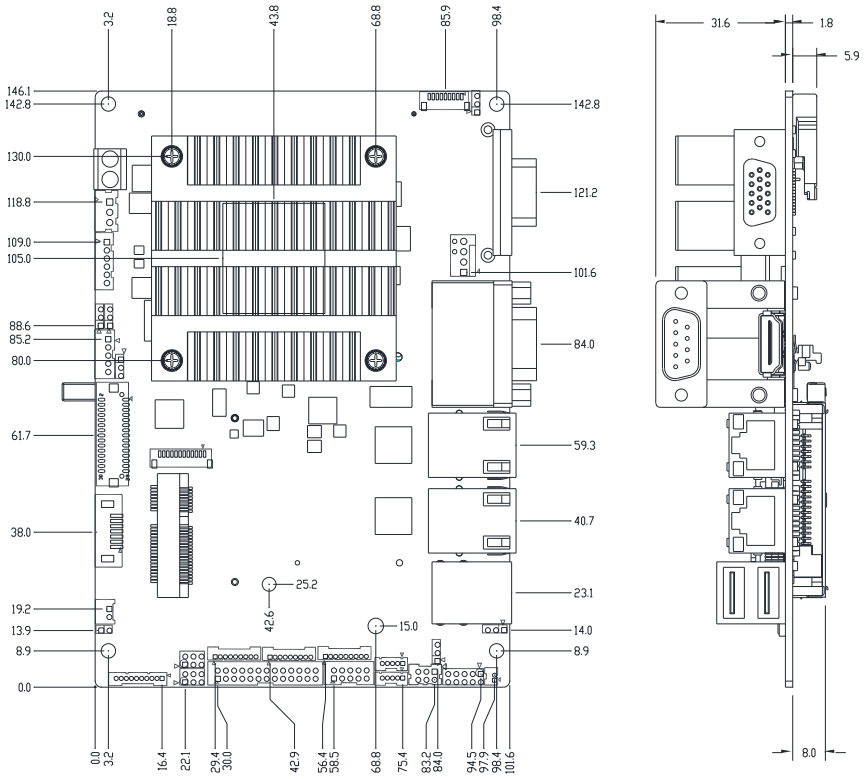

Advanced Version (Solder Side)

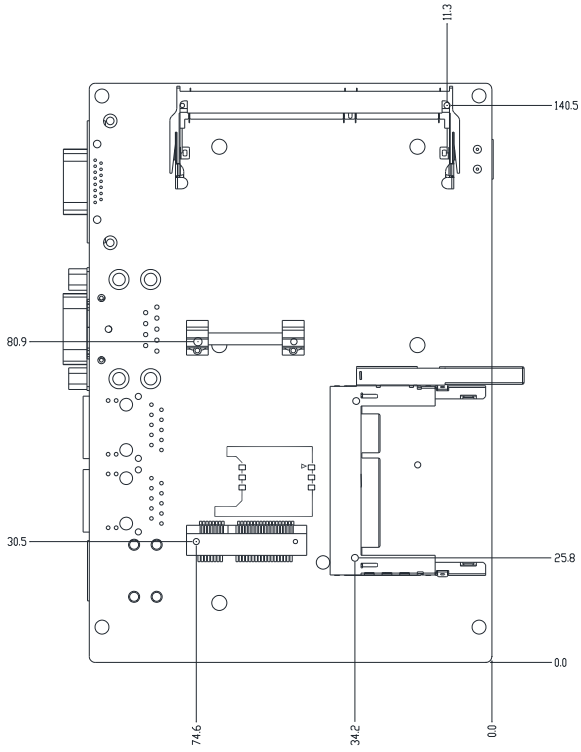

2.2 Jumpers and Connectors

Standard Version (Component Side)

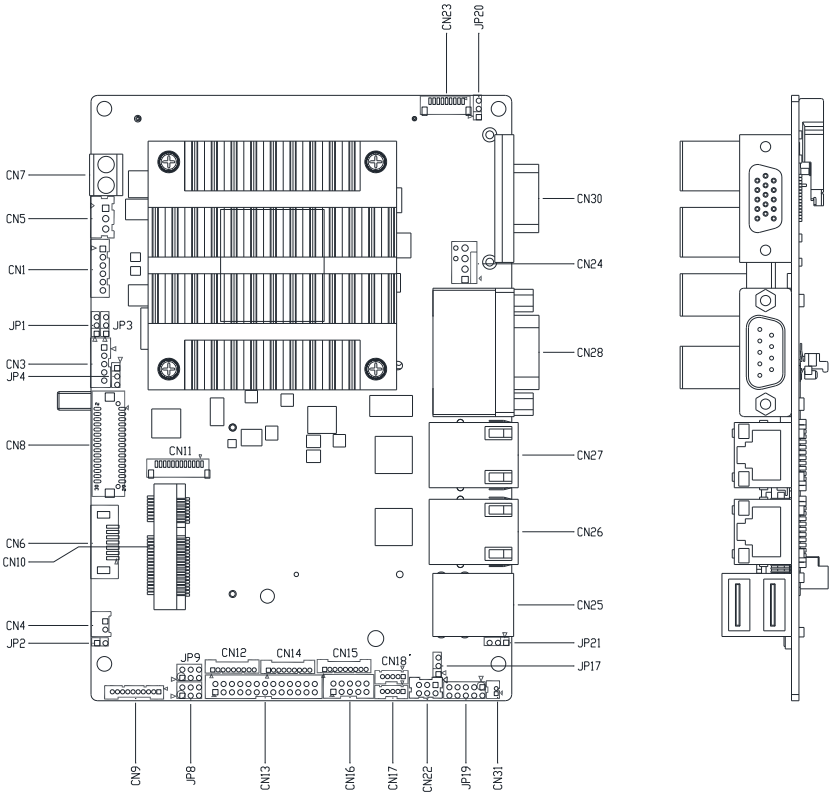

Standard Version (Solder Side)

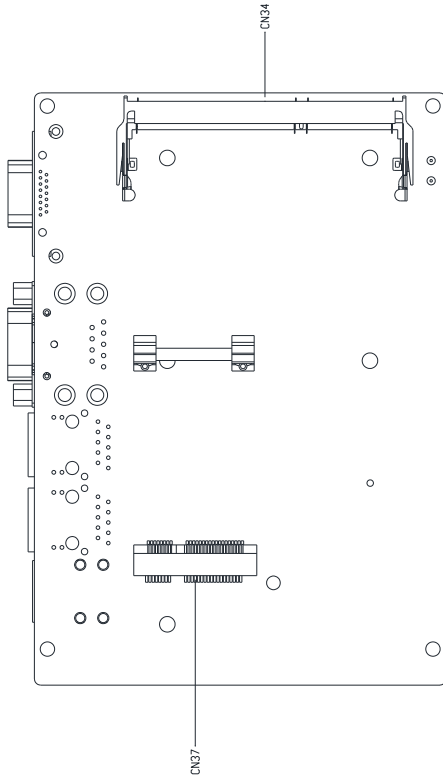

Advanced Version (Component Side)

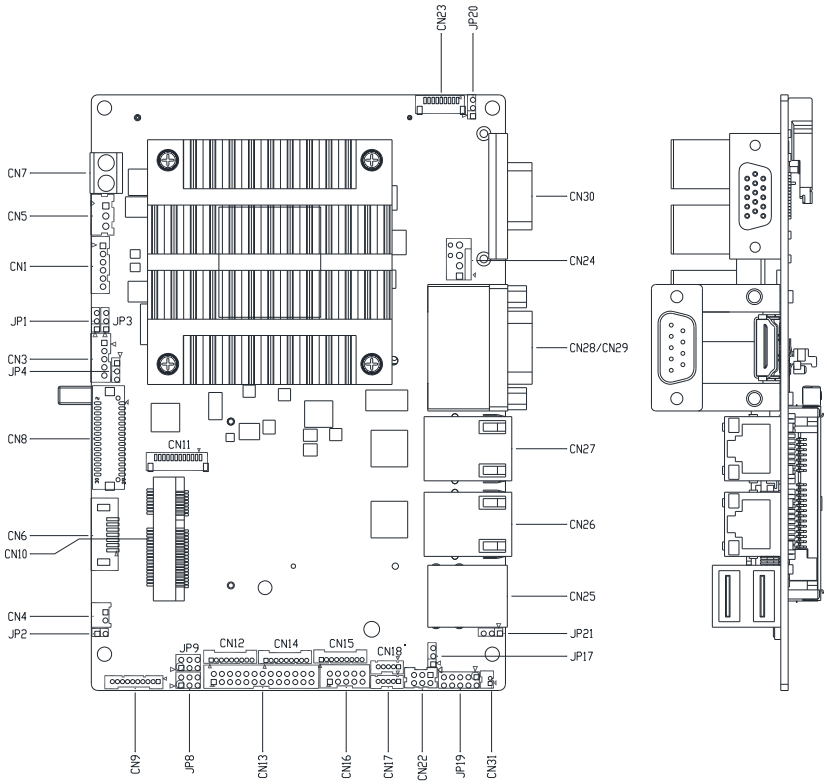

Advanced Version (Solder Side)

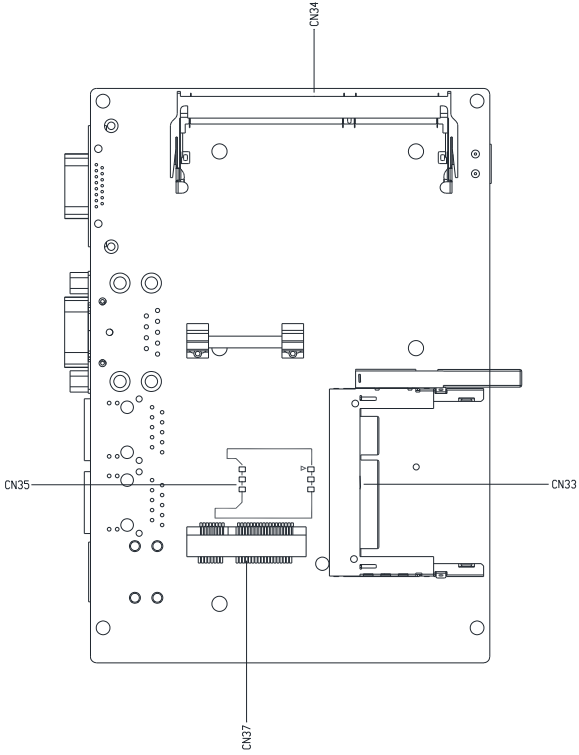

2.3 List of Jumpers

Please refer to the table below for all of the board's jumpers that you can configure for your application

Label	Function
JP1	LVDS Port Backlight Inverter VCC Selection
JP3	LVDS Port Backlight Lightness Control Mode Selection
JP4	LVDS Port Operating VDD Selection
JP8	COM3 Pin8 Function Selection
JP9	COM2 Pin8 Function Selection
JP17	Auto Power Button Enable/Disable Selection
JP19	Front Panel Connector
JP20	Touch Screen 4/5/8-wire Mode Selection
JP21	Clear CMOS Jumper

2.3.1 LVDS Port Backlight Inverter VCC Selection (JP1)

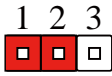

+12 V

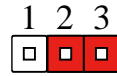

+5 V (Default)

Pin	Function
1-2	+12V
2-3	+5V (Default)

2.3.2 LVDS Port Backlight Lightness Control Mode Selection (JP3)

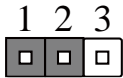

VR Mode (Default)

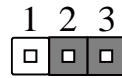

PWM Mode

Pin	Function
1-2	VR Mode (Default)
2-3	PWM Mode

2.3.3 LVDS Port Operating VDD Selection (JP4)

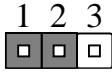

+5 V

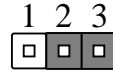

+3.3 V (Default)

Pin	Function
1-2	+5 V
2-3	+3.3 V (Default)

2.3.4 COM3 Pin8 Function Selection (JP8)

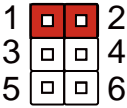

+12 V

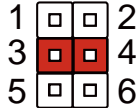

Ring (Default)

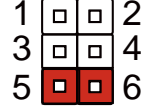

+5 V

Pin	Function
1-2	+12 V
3-4	Ring (Default)
5-6	+5 V

2.3.5 COM2 Pin8 Function Selection (JP9)

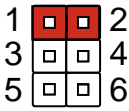

+12 V

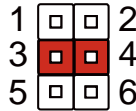

Ring (Default)

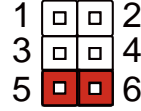

+5 V

Pin	Function
1-2	+12 V
3-4	Ring (Default)
5-6	+5 V

2.3.6 Auto Power Button Enable/Disable Selection (JP17)

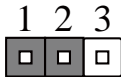

Disable

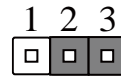

Enable (Default)

Pin	Function
1-2	Disable
2-3	Enable (Default)

Note: When disabled, use power button JP19 (1-2) to power on the system

2.3.7 Front Panel Connector (JP19)

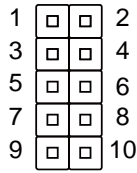

Pin	Function
1	PWR_BTN-
2	PWR_BTN+
3	HDD_LED-
4	HDD_LED+
5	SPEAKER-
6	SPEAKER+
7	PWR_LED-
8	PWR_LED+
9	H/W RESET-
10	H/W RESET+

2.3.8 Touchscreen 4/ 5/ 8 Wire Selection (JP20)

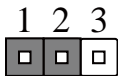

4/8 Wires Mode (Default)

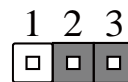

5 Wires Mode

JP20	Function
1-2	4/8 Wires Mode (Default)
2-3	5 Wires Mode

2.3.9 Clear CMOS Jumper (JP21)

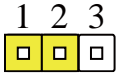

Normal (Default)

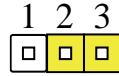

Clear CMOS

JP20	Function
1-2	Normal (Default)
2-3	Clear CMOS

2.4 List of Connectors

Please refer to the table below for all of the board's connectors that you can configure for your application

Label	Function
CN1	+5VSB Output w/SMBus
CN3	LVDS Port Inverter / Backlight Connector
CN4	+5V Output for SATA HDD
CN5	External +5VSB Input
CN6	SATA Port
CN7	External +12V Input
CN8	LVDS Port
CN9	Audio I/O Port
CN10	Mini-Card Slot (Half Mini-Card)
CN11	LPC Port
CN12	COM Port 2
CN14	COM Port 3
CN15	COM Port 4
CN16	Digital IO Port
CN17	USB 2.0 Port 3
CN18	USB 2.0 Port 2
CN19	SPI Debug Port
CN22	PS/2 Keyboard/Mouse Combo Port
CN23	Touchscreen Connector
CN24	CPU FAN (Optional)
CN25	USB Ports 0 and 1
CN26	LAN (RJ-45) Port2
CN27	LAN (RJ-45) Port1

Label	Function
CN28	COM Port 1 (D-SUB 9)
CN29	HDMI Port
CN30	VGA Port
CN31	Battery
CN33	CFast Slot
CN34	DDR3L SO-DIMM Slot
CN35	UIM Card Socket
CN37	Mini-Card Slot (Full Mini Card)

2.4.1 +5VSB Output w/SMBus (CN1)

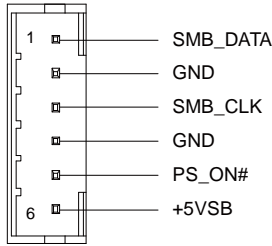

Pin	Pin Name	Signal Type	Signal Level
1	SMB_DATA	I/O	+3.3V
2	GND	GND	
3	SMB_CLK	I/O	+3.3V
4	GND	GND	
5	PS_ON#	OUT	+5V
6	+5VSB	PWR	+5V

2.4.2 LVDS Port Inverter / Backlight Connector (CN3)

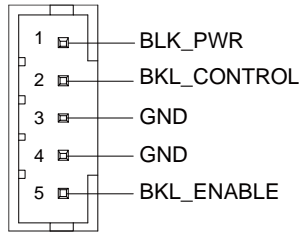

Pin	Pin Name	Signal Type	Signal Level
1	BKL_PWR	PWR	+5V / +12V
2	BKL_CONTROL	OUT	
3	GND	GND	
4	GND	GND	
5	BKL_ENABLE	OUT	+3.3V

Note 1: LVDS BKL_PWR can be set to +5V or +12V by JP1.

Note 2: LVDS BKL_CONTROL can be set by JP3.

2.4.3 +5V Output for SATA HDD (CN4)

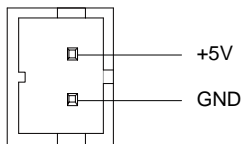

Pin	Pin Name	Signal Type	Signal Level
1	+5V	PWR	+5V
2	GND	GND	

2.4.4 External +5VSB Input (CN5)

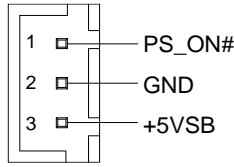

Pin	Pin Name	Signal Type	Signal Level
1	PS_ON#	OUT	+3.3V
2	GND	GND	
3	+5VSB	PWR	+5V

※ Since every power supply discharge design is different, we recommend restart after power off 3seconds to make sure ATX power is full discharge. Or make sure 5V standby power have been discharged under 2V.

2.4.5 SATA Port (CN6)

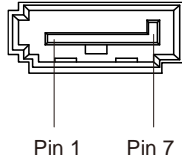

Pin	Pin Name	Signal Type	Signal Level
1	GND	GND	
2	SATA_TX+	DIFF	
3	SATA_TX-	DIFF	
4	GND	GND	
5	SATA_RX-	DIFF	
6	SATA_RX+	DIFF	
7	GND	GND	

2.4.6 External +12V Input (CN7)

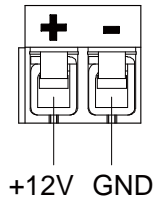

Pin	Pin Name	Signal Type	Signal Level
1	+12V	PWR	+12V
2	GND	GND	

2.4.7 LVDS Port (CN8)

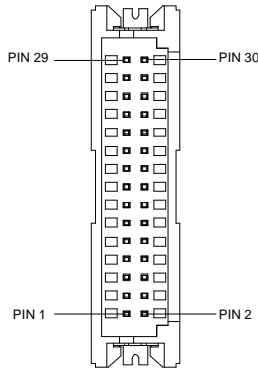

Pin	Pin Name	Signal Type	Signal Level
1	BKL_ENABLE	OUT	
2	BKL_CONTROL	OUT	
3	LCD_PWR	PWR	+3.3V/+5V
4	GND	GND	
5	LVDS_A_CLK-	DIFF	
6	LVDS_A_CLK+	DIFF	
7	LCD_PWR	PWR	+3.3V/+5V
8	GND	GND	
9	LVDS_DA0-	DIFF	
10	LVDS_DA0+	DIFF	
11	LVDS_DA1-	DIFF	
12	LVDS_DA1+	DIFF	
13	LVDS_DA2-	DIFF	
14	LVDS_DA2+	DIFF	
15	LVDS_DA3-	DIFF	

Pin	Pin Name	Signal Type	Signal Level
16	LVDS_DA3+	DIFF	
17	DDC_DATA	I/O	+3.3V
18	DDC_CLK	I/O	+3.3V
19	LVDS_DB0-	DIFF	
20	LVDS_DB0+	DIFF	
21	LVDS_DB1-	DIFF	
22	LVDS_DB1+	DIFF	
23	LVDS_DB2-	DIFF	
24	LVDS_DB2+	DIFF	
25	LVDS_DB3-	DIFF	
26	LVDS_DB3+	DIFF	
27	LCD_PWR	PWR	+3.3V/+5V
28	GND	GND	
29	LVDS_B_CLK-	DIFF	
30	LVDS_B_CLK+	DIFF	

Note: LVDS LCD_PWR can be set to +3.3V or +5V by JP4.

2.4.8 Audio I/O Port (CN9)

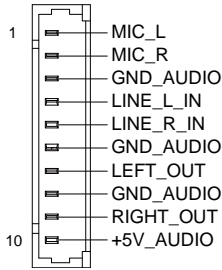

Pin	Pin Name	Signal Type	Signal Level
1	MIC_L	IN	
2	MIC_R	IN	
3	GND_AUDIO	GND	
4	LINE_L_IN	IN	
5	LINE_R_IN	IN	
6	GND_AUDIO	GND	
7	LEFT_OUT	OUT	
8	GND_AUDIO	GND	
9	RIGHT_OUT	OUT	
10	+5V_AUDIO	PWR	+5V

2.4.9 Mini-Card Slot (Half Mini-Card) (CN10)

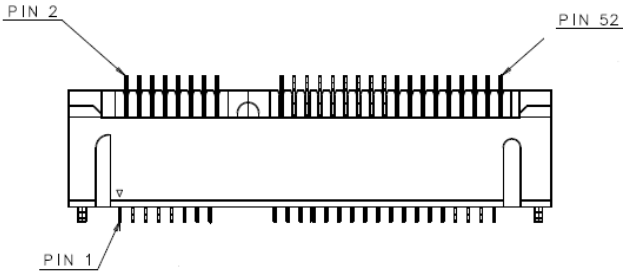

Pin	Pin Name	Signal Type	Signal Level
1	PCIE_WAKE#	IN	
2	+3.3VSB/+3.3V	PWR	+3.3V
3	NC		
4	GND	GND	
5	NC		
6	+1.5V	PWR	+1.5V
7	PCIE_CLK_REQ#	IN	
8	NC		
9	GND	GND	
10	NC		
11	PCIE_REF_CLK-	DIFF	
12	NC		
13	PCIE_REF_CLK+	DIFF	
14	NC		
15	GND	GND	
16	NC		

Pin	Pin Name	Signal Type	Signal Level
17	NC		
18	GND	GND	
19	NC		
20	W_DISABLE#	OUT	+3.3V
21	GND	GND	
22	PCIE_RST#	OUT	+3.3V
23	PCIE_RX-/mSATARX+	DIFF	
24	+3.3VSB/+3.3V	PWR	+3.3V
25	PCIE_RX+/mSATARX-	DIFF	
26	GND	GND	
27	GND	GND	
28	+1.5V	PWR	+1.5V
29	GND	GND	
30	SMB_CLK	I/O	+3.3V
31	PCIE_TX-/mSATATX-	DIFF	
32	SMB_DATA	I/O	+3.3V
33	PCIE_TX+/mSATATX+	DIFF	
34	GND	GND	
35	GND	GND	
36	USB_D-	DIFF	
37	GND	GND	
38	USB_D+	DIFF	
39	+3.3VSB/+3.3V	PWR	+3.3V
40	GND	GND	
41	+3.3VSB/+3.3V	PWR	+3.3V
42	NC		

Pin	Pin Name	Signal Type	Signal Level
43	GND	GND	
44	NC		
45	NC		
46	NC		
47	NC		
48	+1.5V	PWR	+1.5V
49	NC		
50	GND	GND	
51	NC		
52	+3.3VSB/+3.3V	PWR	+3.3V

Note 1: CN10 can be selected for Mini-Card or mSATA by changing BOM.

Note 2: You can choose the function either from mSATA or from CFast on the motherboard

2.4.10 LPC Port (CN11)

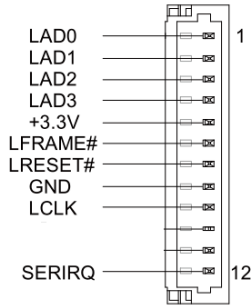

Pin	Pin Name	Signal Type	Signal Level
1	LAD0	I/O	+3.3V
2	LAD1	I/O	+3.3V
3	LAD2	I/O	+3.3V
4	LAD3	I/O	+3.3V
5	+3.3V	PWR	+3.3V
6	LFRAME#	IN	
7	LRESET#	OUT	+3.3V
8	GND	GND	
9	LCLK	OUT	
10	NC		
11	NC		
12	SERIRQ	I/O	+3.3V

2.4.11 COM Port 2 (CN12)

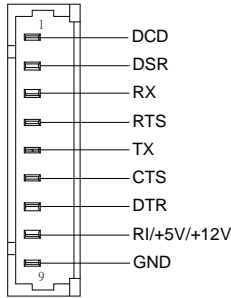

RS-232			
Pin	Pin Name	Signal Type	Signal Level
1	DCD	IN	
2	DSR	IN	
3	RX	IN	
4	RTS	OUT	±5V
5	TX	OUT	±5V
6	CTS	IN	
7	DTR	OUT	±5V
8	RI/+5V/+12V	IN/ PWR	+5V/+12V
9	GND	GND	

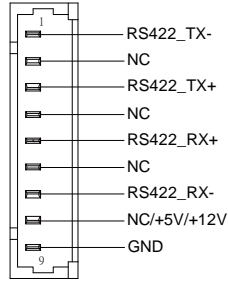

RS-422			
Pin	Pin Name	Signal Type	Signal Level
1	RS422_TX-	OUT	±5V
2	NC		
3	RS422_TX+	OUT	±5V
4	NC		
5	RS422_RX+	IN	
6	NC		
7	RS422_RX-	IN	
8	NC/+5V/+12V	PWR	+5V/+12V
9	GND	GND	

Note 1: COM2 RS-232/422/485 can be set by BIOS setting. Default is RS-232.

Note 2: Pin 8 function can be set by JP9.

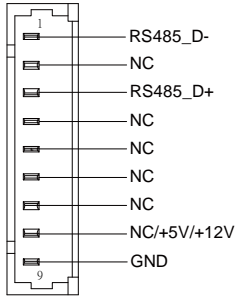

RS-485

Pin	Pin Name	Signal Type	Signal Level
1	RS485_D-	I/O	±5V
2	NC		
3	RS485_D+	I/O	±5V
4	NC		
5	NC		
6	NC		
7	NC		
8	NC/+5V/+12V	PWR	+5V/+12V
9	GND	GND	

2.4.12 COM Port 3 (CN14)

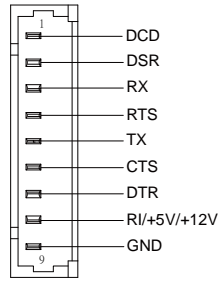

RS-232

Pin	Pin Name	Signal Type	Signal Level
1	DCD	IN	
2	DSR	IN	
3	RX	IN	
4	RTS	OUT	±5V
5	TX	OUT	±5V
6	CTS	IN	
7	DTR	OUT	±5V
8	RI/+5V/+12V	IN/ PWR	+5V/+12V
9	GND	GND	

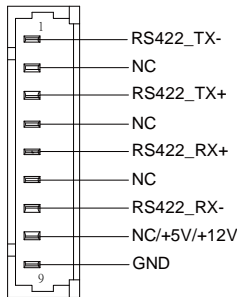

RS-422

Pin	Pin Name	Signal Type	Signal Level
1	RS422_TX-	OUT	±5V
2	NC		
3	RS422_TX+	OUT	±5V
4	NC		
5	RS422_RX+	IN	
6	NC		
7	RS422_RX-	IN	
8	NC/+5V/+12V	PWR	+5V/+12V
9	GND	GND	

Note 1: COM3 RS-232/422/485 can be set by BIOS setting. Default is RS-232.

Note 2: Pin 8 function can be set by JP8.

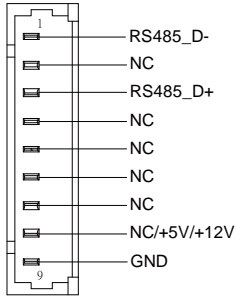

RS-485

Pin	Pin Name	Signal Type	Signal Level
1	RS485_D-	I/O	±5V
2	NC		
3	RS485_D+	I/O	±5V
4	NC		
5	NC		
6	NC		
7	NC		
8	NC/+5V/+12V	PWR	+5V/+12V
9	GND	GND	

2.4.13 COM Port 4 (CN15)

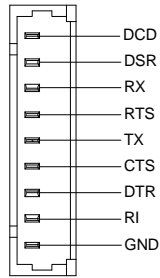

Pin	Pin Name	Signal Type	Signal Level
1	DCD	IN	
2	DSR	IN	
3	RX	IN	
4	RTS	OUT	±9V
5	TX	OUT	±9V
6	CTS	IN	
7	DTR	OUT	±9V
8	RI	IN	
9	GND	GND	

2.4.14 Digital I/O Port (CN16)

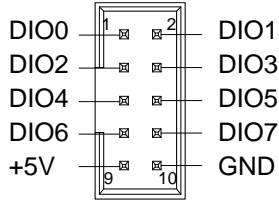

Pin	Pin Name	Signal Type	Signal Level
1	DIO0	I/O	+5V
2	DIO1	I/O	+5V
3	DIO2	I/O	+5V
4	DIO3	I/O	+5V
5	DIO4	I/O	+5V
6	DIO5	I/O	+5V
7	DIO6	I/O	+5V
8	DIO7	I/O	+5V
9	+5V	PWR	+5V
10	GND	GND	

2.4.15 USB 2.0 Port 3 (CN17)

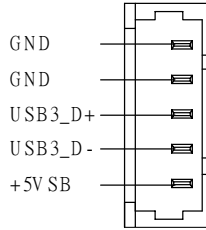

Pin	Pin Name	Signal Type	Signal Level
1	+5VSB	PWR	+5V
2	USB3_D-	DIFF	
3	USB3_D+	DIFF	
4	GND	GND	
5	GND	GND	

2.4.16 USB 2.0 Port 2 (CN18)

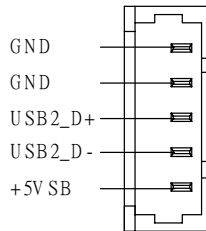

Pin	Pin Name	Signal Type	Signal Level
1	+5VSB	PWR	+5V
2	USB2_D-	DIFF	
3	USB2_D+	DIFF	
4	GND	GND	
5	GND	GND	

2.4.17 BIOS Debug Port (CN19)

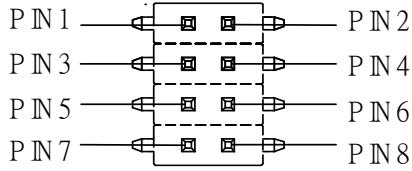

Pin	Pin Name	Signal Type	Signal Level
1	+3.3VSB	PWR	+3.3V
2	GND	GND	
3	SPI_CS	IN	
4	SPI_CLK	IN	
5	SPI_MISO	OUT	
6	SPI_MOSI	IN	
7	NC		
8	NC		

2.4.18 PS/2 Keyboard/Mouse Combo Port (CN22)

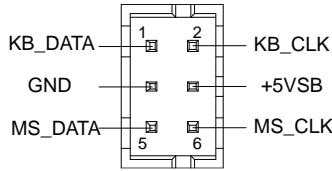

Pin	Pin Name	Signal Type	Signal Level
1	KB_DATA	I/O	+5V
2	KB_CLK	I/O	+5V
3	GND	GND	
4	+5VSB	PWR	+5V
5	MS_DATA	I/O	+5V
6	MS_CLK	I/O	+5V

2.4.19 Touchscreen Connector (CN23)

4 Wires

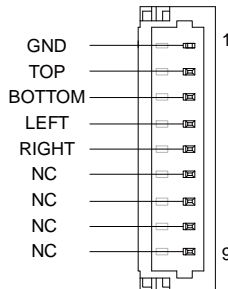

Pin	Pin Name	Signal Type	Signal Level
1	GND	GND	
2	TOP	IN	
3	BOTTOM	IN	

Pin	Pin Name	Signal Type	Signal Level
4	LEFT	IN	
5	RIGHT	IN	
6	NC		
7	NC		
8	NC		
9	NC		

5 Wires

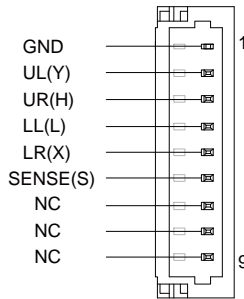

Pin	Pin Name	Signal Type	Signal Level
1	GND	GND	
2	UL(Y)	IN	
3	UR(H)	IN	
4	LL(L)	IN	
5	LR(X)	IN	
6	SENSE(S)	IN	
7	NC		
8	NC		
9	NC		

Note: Touch mode can be set by JP20

8 Wires

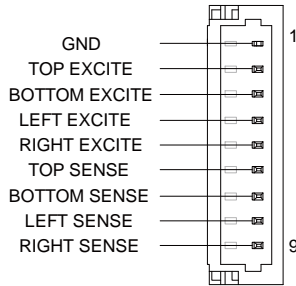

Pin	Pin Name	Signal Type	Signal Level
1	GND	GND	
2	TOP EXCITE	IN	
3	BOTTOM EXCITE	IN	
4	LEFT EXCITE	IN	
5	RIGHT EXCITE	IN	
6	TOP SENSE	IN	
7	BOTTOM SENSE	IN	
8	LEFT SENSE	IN	
9	RIGHT SENSE	IN	

2.4.20 CPU FAN (Optional) (CN24)

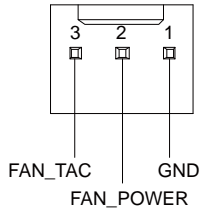

Pin	Pin Name	Signal Type	Signal Level
1	GND	GND	
2	FAN_POWER	PWR	+12V
3	FAN_TAC	IN	

2.4.21 USB Ports 0 and 1 (CN25)

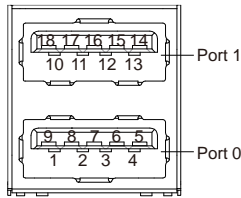

Pin	Pin Name	Signal Type	Signal Level
1	+5VSB	PWR	+5V
2	USB0_D-	DIFF	
3	USB0_D+	DIFF	
4	GND	GND	
5	USB0_SSRX-	DIFF	
6	USB0_SSRX+	DIFF	
7	GND	GND	
8	USB0_SSTX-	DIFF	
9	USB0_SSTX+	DIFF	
10	+5VSB	PWR	+5V

Pin	Pin Name	Signal Type	Signal Level
11	USB1_D-	DIFF	
12	USB1_D+	DIFF	
13	GND	GND	
14	NC		
15	NC		
16	GND	GND	
17	NC		
18	NC		

Note: Only Port0 supports USB 3.0.

2.4.22 LAN (RJ-45) Port2 (CN26)

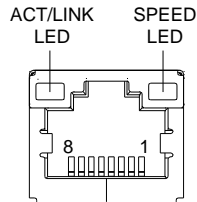

Pin	Pin Name	Signal Type	Signal Level
1	MDI0+	DIFF	
2	MDI0-	DIFF	
3	MDI1+	DIFF	
4	MDI2+	DIFF	
5	MDI2-	DIFF	
6	MDI1-	DIFF	
7	MDI3+	DIFF	
8	MDI3-	DIFF	

2.4.23 LAN (RJ-45) Port1 (CN27)

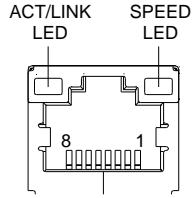

Pin	Pin Name	Signal Type	Signal Level
1	MDI0+	DIFF	
2	MDI0-	DIFF	
3	MDI1+	DIFF	
4	MDI2+	DIFF	
5	MDI2-	DIFF	
6	MDI1-	DIFF	
7	MDI3+	DIFF	
8	MDI3-	DIFF	

2.4.24 COM Port 1 (D-SUB 9) (CN28)

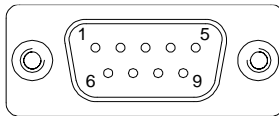

Pin	Pin Name	Signal Type	Signal Level
1	DCD	IN	
2	RX	IN	
3	TX	OUT	±9V
4	DTR	OUT	±9V

Pin	Pin Name	Signal Type	Signal Level
5	GND	GND	
6	DSR	IN	
7	RTS	OUT	±9V
8	CTS	IN	
9	RI	IN	

2.4.25 HDMI Port (CN29)



Pin	Pin Name	Signal Type	Signal Level
1	TMDS_DAT2+	DIFF	
2	GND	GND	
3	TMDS_DAT2-	DIFF	
4	TMDS_DAT1+	DIFF	
5	GND	GND	
6	TMDS_DAT1-	DIFF	
7	TMDS_DAT0+	DIFF	
8	GND	GND	
9	TMDS_DAT0-	DIFF	
10	TMDS_CLK+	DIFF	
11	GND	GND	
12	TMDS_CLK-	DIFF	

Pin	Pin Name	Signal Type	Signal Level
13	NC		
14	NC		
15	DDC_CLK	I/O	+5V
16	DDC_DATA	I/O	+5V
17	GND	GND	
18	+5V	PWR	+5V
19	HPLG_DETECT	IN	

2.4.26 VGA Port (CN30)

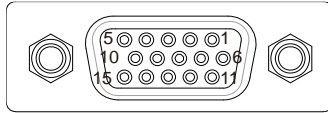

Pin	Pin Name	Signal Type	Signal Level
1	RED	OUT	
2	GREEN	OUT	
3	BLUE	OUT	
4	NC		
5	GND	GND	
6	RED_GND_RTN	GND	
7	GREEN_GND_RTN	GND	
8	BLUE_GND_RTN	GND	
9	+5V	PWR	+5V
10	CRT_PLUG#		
11	NC		

Pin	Pin Name	Signal Type	Signal Level
12	DDC_DATA	I/O	+5V
13	HSYNC	OUT	
14	VSYNC	OUT	
15	DDC_CLK	I/O	+5V

2.4.27 Battery (CN31)

Pin	Pin Name	Signal Type	Signal Level
1	+3.3V	PWR	+3.3V
2	GND	GND	

2.4.28 CFast Slot (CN33)

Pin	Pin Name	Signal Type	Signal Level
S1	GND	GND	
S2	SATA_TX+	DIFF	
S3	SATA_TX-	DIFF	
S4	GND	GND	
S5	SATA_RX-	DIFF	
S6	SATA_RX+	DIFF	
S7	GND	GND	
PC1	NC		
PC2	GND	GND	
PC3	NC		
PC4	NC		
PC5	NC		

Pin	Pin Name	Signal Type	Signal Level
PC6	NC		
PC7	GND	GND	
PC8	NC		
PC9	NC		
PC10	NC		
PC11	NC		
PC12	NC		
PC13	+3.3V	PWR	+3.3V
PC14	+3.3V	PWR	+3.3V
PC15	GND	GND	
PC16	GND	GND	
PC17	NC		

2.4.29 DDR3L SO-DIMM Slot (CN34)

Standard Specifications

2.4.30 UIM Card Socket (CN35)

Pin	Pin Name	Signal Type	Signal Level
1	UIM_PWR	PWR	
2	UIM_RST	IN	
3	UIM_CLK	IN	
4	GND	GND	
5	UIM_VPP	PWR	
6	UIM_DATA	I/O	

2.4.31 Mini-Card Slot (Full Mini-Card) (CN37)

Pin	Pin Name	Signal Type	Signal Level
1	PCIE_WAKE#	IN	
2	+3.3VSB	PWR	+3.3V
3	NC		
4	GND	GND	
5	NC		
6	+1.5V	PWR	+1.5V
7	PCIE_CLK_REQ#	IN	
8	UIM_PWR	PWR	
9	GND	GND	
10	UIM_DATA	I/O	
11	PCIE_REF_CLK-	DIFF	
12	UIM_CLK	IN	
13	PCIE_REF_CLK+	DIFF	
14	UIM_RST	IN	
15	GND	GND	
16	UIM_VPP	PWR	
17	NC		
18	GND	GND	
19	NC		
20	W_DISABLE#	OUT	+3.3V
21	GND	GND	
22	PCIE_RST#	OUT	+3.3V
23	PCIE_RX-	DIFF	
24	+3.3VSB	PWR	+3.3V

Pin	Pin Name	Signal Type	Signal Level
25	PCIE_RX+	DIFF	
26	GND	GND	
27	GND	GND	
28	+1.5V	PWR	+1.5V
29	GND	GND	
30	SMB_CLK	I/O	+3.3V
31	PCIE_TX-	DIFF	
32	SMB_DATA	I/O	+3.3V
33	PCIE_TX+	DIFF	
34	GND	GND	
35	GND	GND	
36	USB_D-	DIFF	
37	GND	GND	
38	USB_D+	DIFF	
39	+3.3VSB	PWR	+3.3V
40	GND	GND	
41	+3.3VSB	PWR	+3.3V
42	NC		
43	GND	GND	
44	NC		
45	NC		
46	NC		
47	NC		
48	+1.5V	PWR	+1.5V
49	NC		
50	GND	GND	

Pin	Pin Name	Signal Type	Signal Level
51	NC		
52	+3.3VSB	PWR	+3.3V

2.5 Function Block

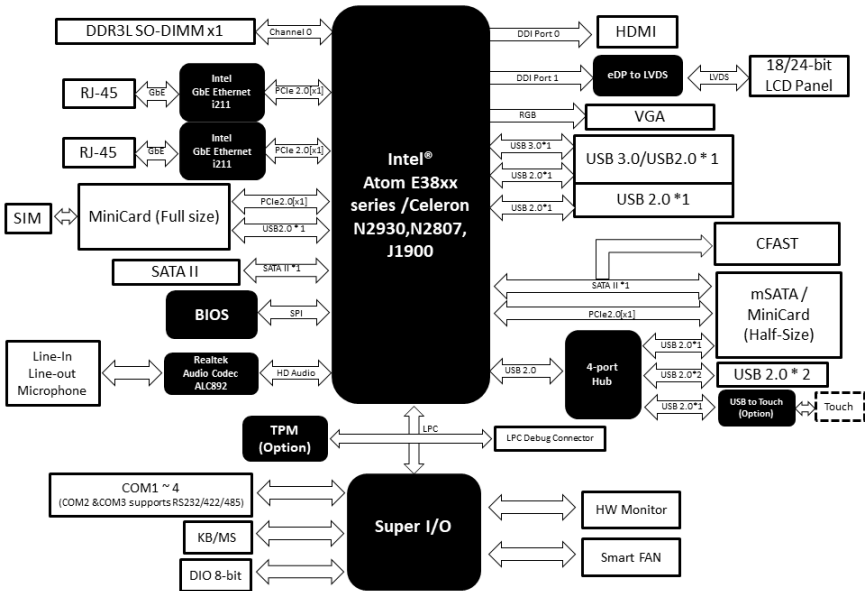

Chapter 3

AMI BIOS Setup

3.1 System Test and Initialization

The board uses certain routines to perform testing and initialization. If an error, fatal or non-fatal, is encountered, a few short beeps or an error message will be outputted. The board can usually continue the boot up sequence with non-fatal errors.

The system configuration verification routines check the current system configuration against the values stored in the CMOS memory. If they do not match, an error message will be outputted, in which case you will need to run the BIOS setup program to set the configuration information in memory.

There are three situations in which you will need to change the CMOS settings:

- You are starting your system for the first time
- You have changed your system's hardware
- The CMOS memory has lost power and the configuration information is erased

The system's CMOS memory uses a backup battery for data retention, which is to be replaced once emptied.

3.2 AMI BIOS Setup

The AMI BIOS ROM has a pre-installed Setup program that allows users to modify basic system configurations, which is stored in the battery-backed CMOS RAM and BIOS NVRAM so that the information is retained when the power is turned off.

To enter BIOS Setup, press or <F2> immediately while your computer is powering up.

The function for each interface can be found below.

Main – Date and time can be set here. Press <Tab> to switch between date elements

Advanced – Enable/ Disable boot option for legacy network devices

Chipset – For hosting bridge parameters

Security – The setup administrator password can be set here

Boot – Enable/ Disable quiet Boot Option

Save & Exit – Save your changes and exit the program

3.3 Setup submenu: Main

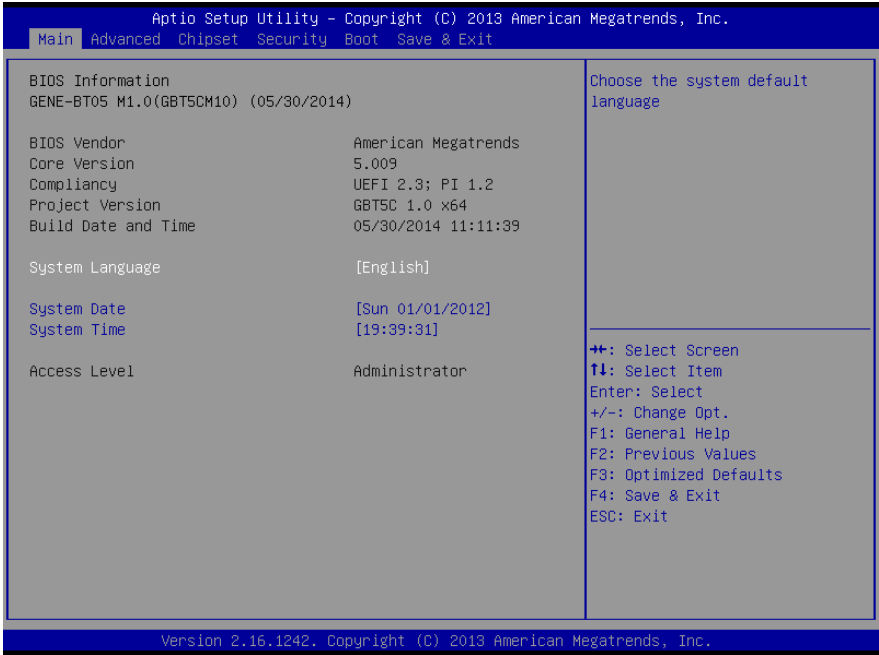

3.4 Setup submenu: Advanced

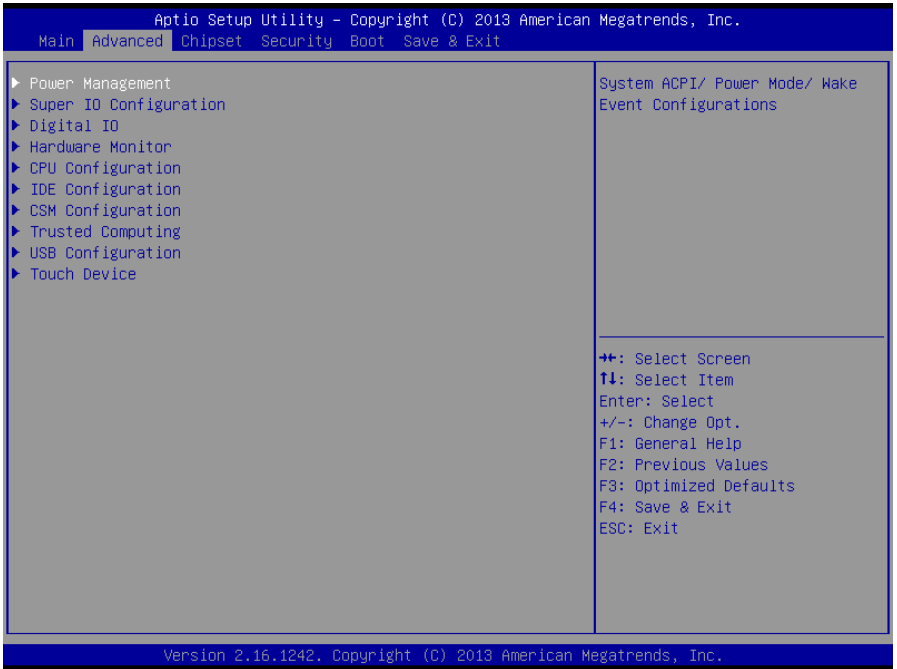

3.4.1 Advanced: Power Management

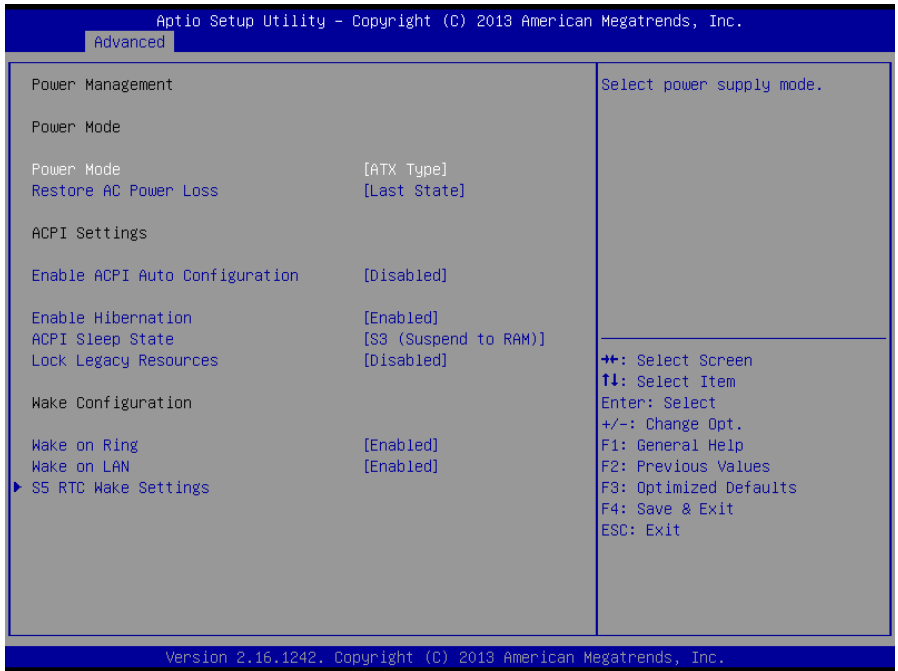

Options Summary		
Power Mode	ATX Type	Optimal Default, Failsafe Default
	AT Type	
Select power supply mode		
Restore AC Power Loss	Last State	Optimal Default, Failsafe Default
	Power On	
	Power Off	
Select AC power state when power is re-applied after a power failure		
Enable ACPI Auto Configuration	Enable	
	Disable	Optimal Default, Failsafe Default
Enables or Disables BIOS ACPI Auto Configuration		
Enable Hibernation	Enable	Optimal Default, Failsafe Default
	Disable	
Enables or Disables System ability to Hibernate (OS/S4 Sleep State). This option may be not effective with some OS		

Options Summary		
Lock Legacy Resources	Enable	
	Disable	Optimal Default, Failsafe Default
Enables or Disables Lock of Legacy Resources		
Wake on Ring	Enable	Optimal Default, Failsafe Default
	Disable	
Enabled/Disabled wake from Ring		
Wake on LAN	Enable	Optimal Default, Failsafe Default
	Disable	
Enabled/Disabled wake from LAN		

3.4.1.1 Power Management: S5 RTC Wake Settings

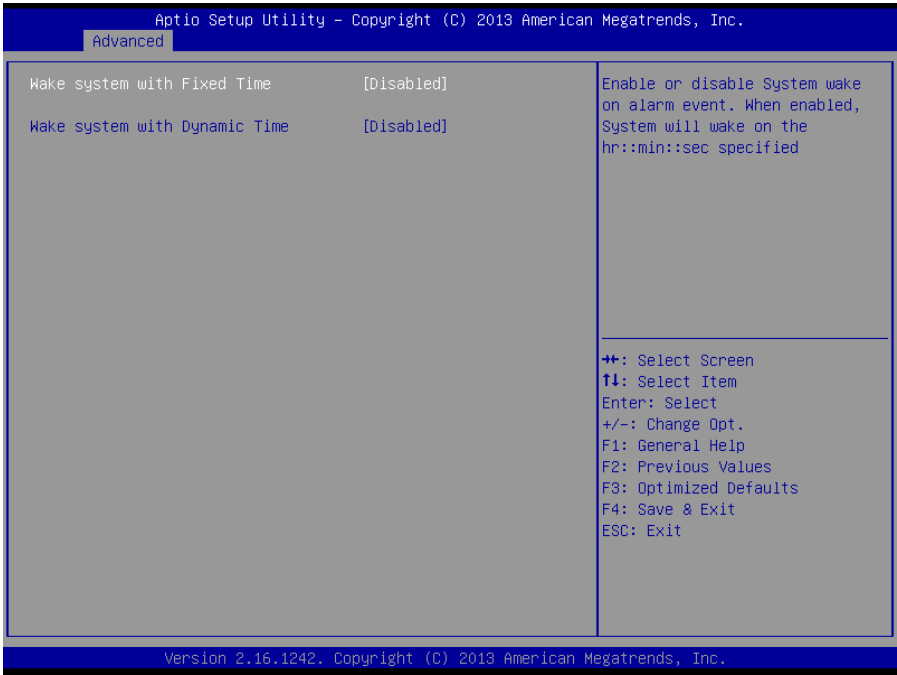

Options Summary		
Wake system with Fixed Time	Enable	
	Disable	Optimal Default, Failsafe Default
	Wake up hour	0
	Wake up minute	0
	Wake up second	0
Wake system with Dynamic Time	Enable	
	Disable	Optimal Default, Failsafe Default
	Wake up minute increase	0
Select RTC wake mode		

3.4.2 Advanced: Super IO Configuration

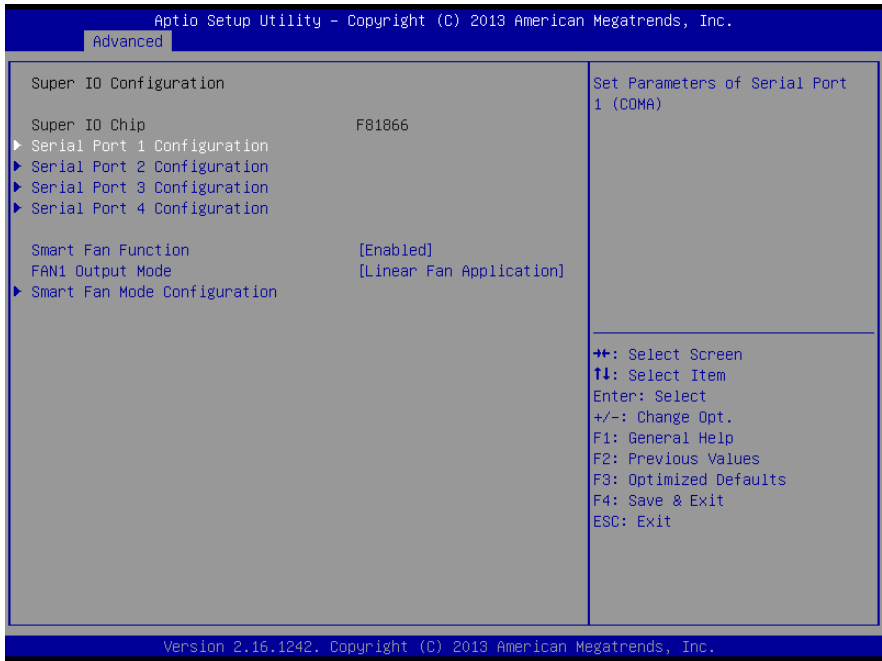

Options Summary		
Smart Fan Function	Enabled	Optimal Default, Failsafe Default
	Disabled	
Enable or Disable Smart Fan		
FAN1 Output Mode	Output PWM mode (open drain)	
	Linear Fan Application	Optimal Default, Failsafe Default
	Output PWM mode (push pull)	
FAN1 Output Mode selection		

3.4.2.1 Serial Port 1 Configuration

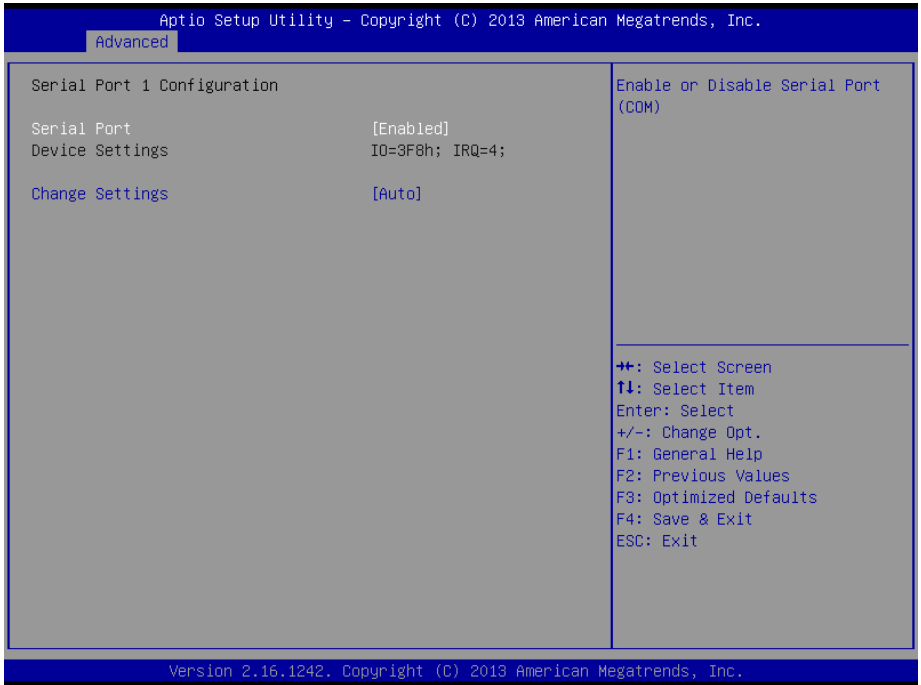

3.4.2.2 Serial Port 2 Configuration

The screenshot shows the Aptio Setup Utility interface. At the top, it reads "Aptio Setup Utility - Copyright (C) 2013 American Megatrends, Inc." and "Advanced". The main area is titled "Serial Port 2 Configuration" and contains the following settings:

Serial Port	[Enabled]
Device Settings	ID=2FBh; IRQ=3;
Change Settings	[Auto]
Working model	[RS232]

To the right of the settings is a vertical panel with the text "Enable or Disable Serial Port (COM)". Below this panel is a legend of navigation keys:

- +/: Select Screen
- ↑↓: Select Item
- Enter: Select
- +/-: Change Opt.
- F1: General Help
- F2: Previous Values
- F3: Optimized Defaults
- F4: Save & Exit
- ESC: Exit

At the bottom of the screen, it displays "Version 2.16.1242. Copyright (C) 2013 American Megatrends, Inc."

3.4.2.3 Serial Port 3 Configuration

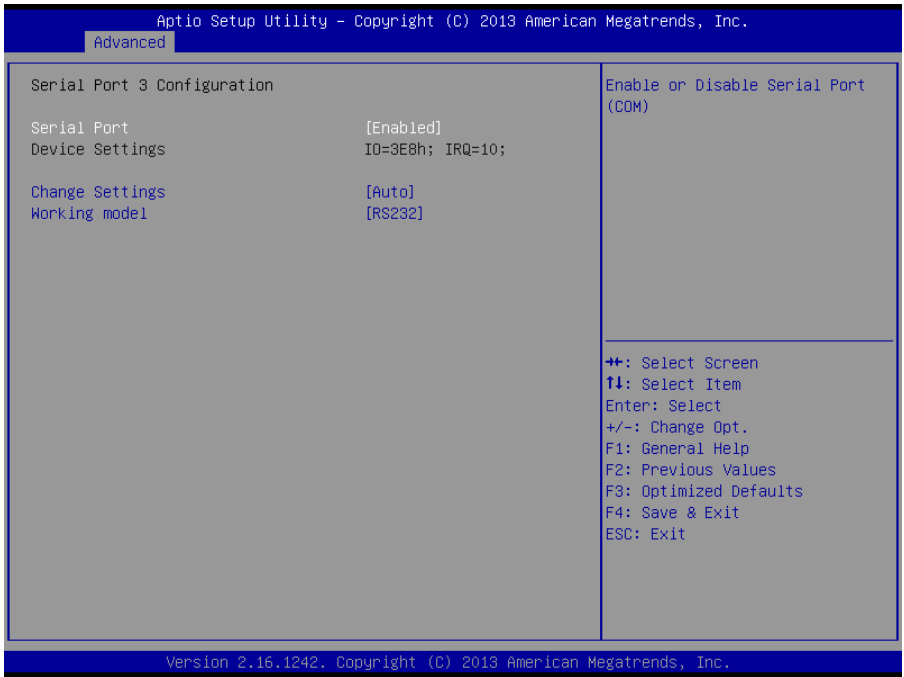

3.4.2.4 Serial Port 4 Configuration

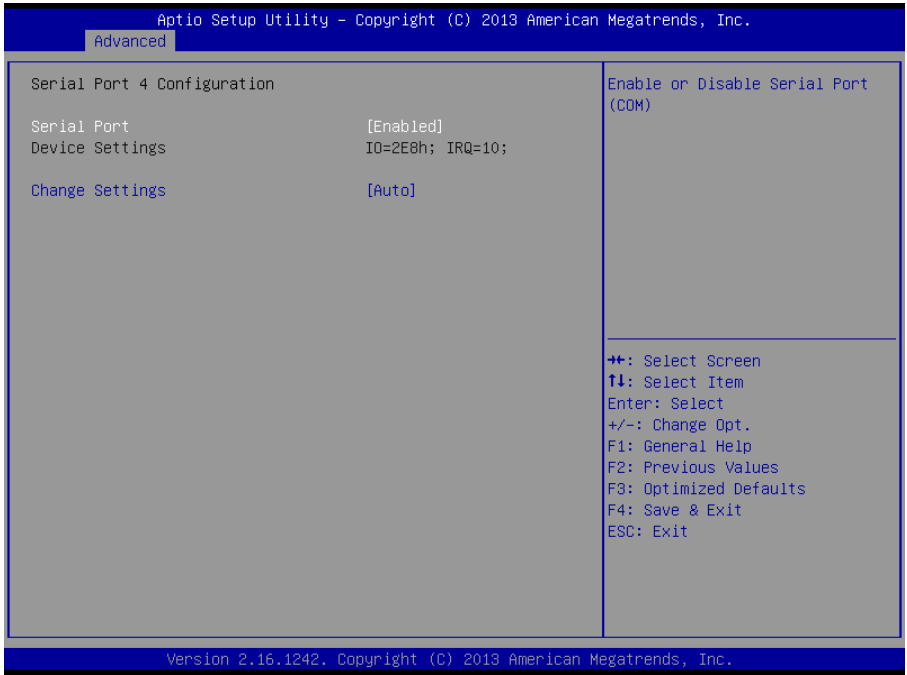

3.4.2.5 Smart Fan Mod Configuration

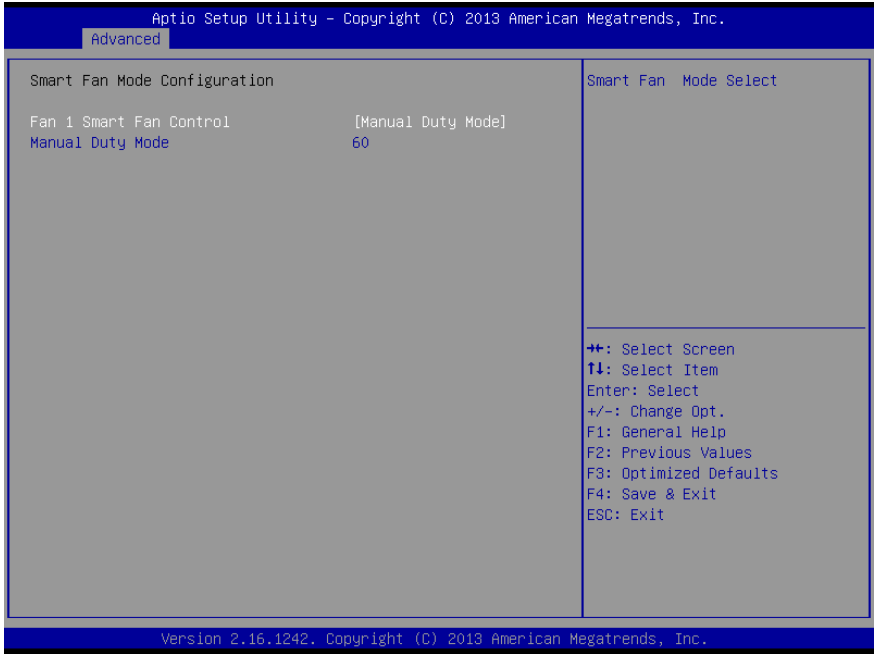

Options Summary		
Fan Mode	Manual Duty Mode	Optimal Default, Failsafe Default
	Auto Duty-Cycle Mode	
Smart Fan Mode Select		
Manual Duty Mode	60	Optimal Default, Failsafe Default
Manual mode fan control, user can write expected duty cycle (PWM fan type) 1-100		

3.4.3 Advanced: Digital IO

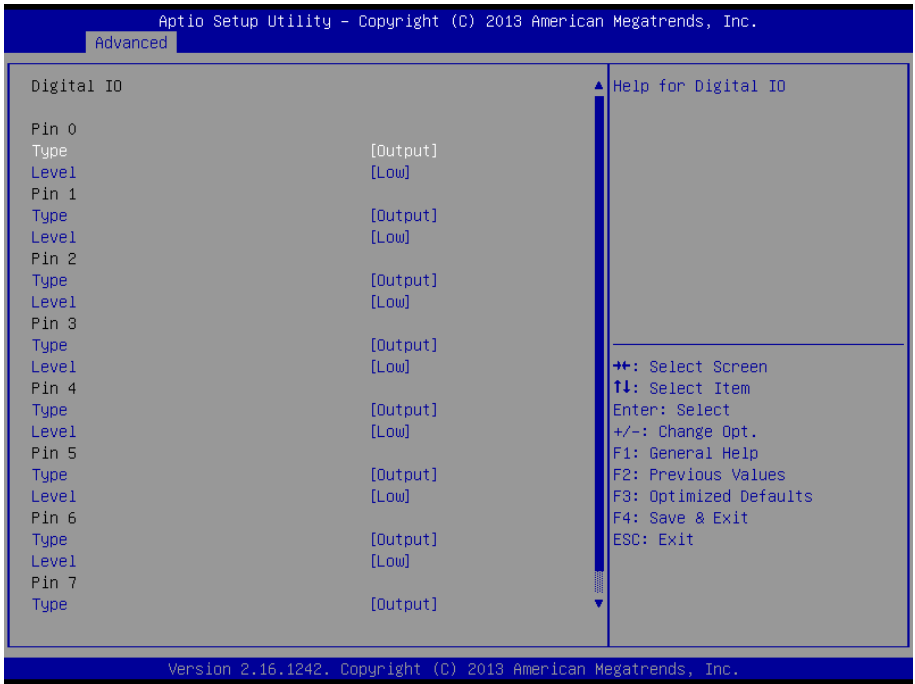

Options Summary		
Type	Output	
	Input	
Help for Digital IO		
Level	Low	
	Hi	
Help for Digital IO		

3.4.4 Advanced: H/W Monitor

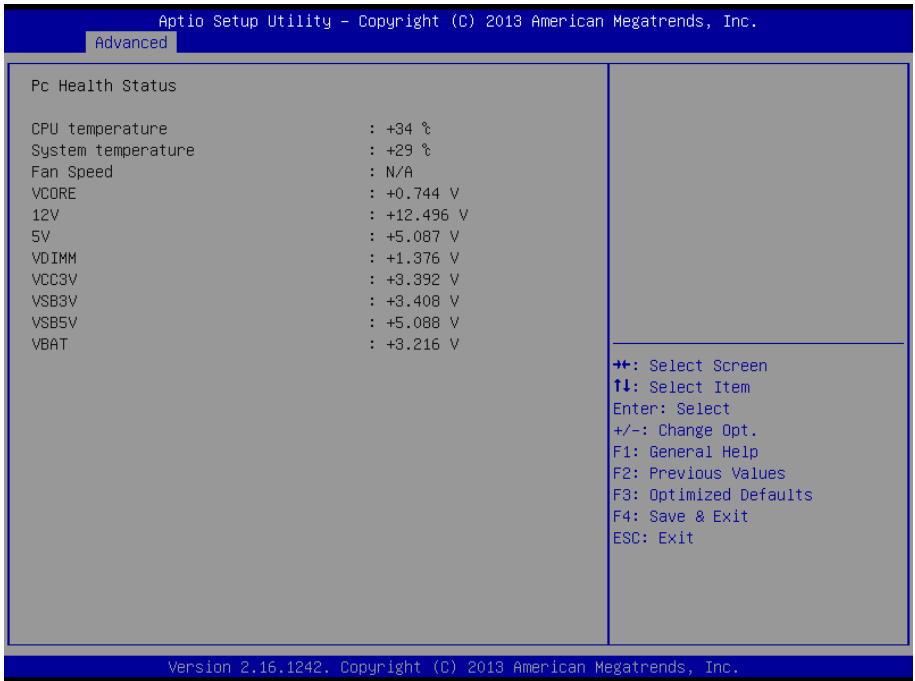

3.4.5 Advanced: CPU Configuration

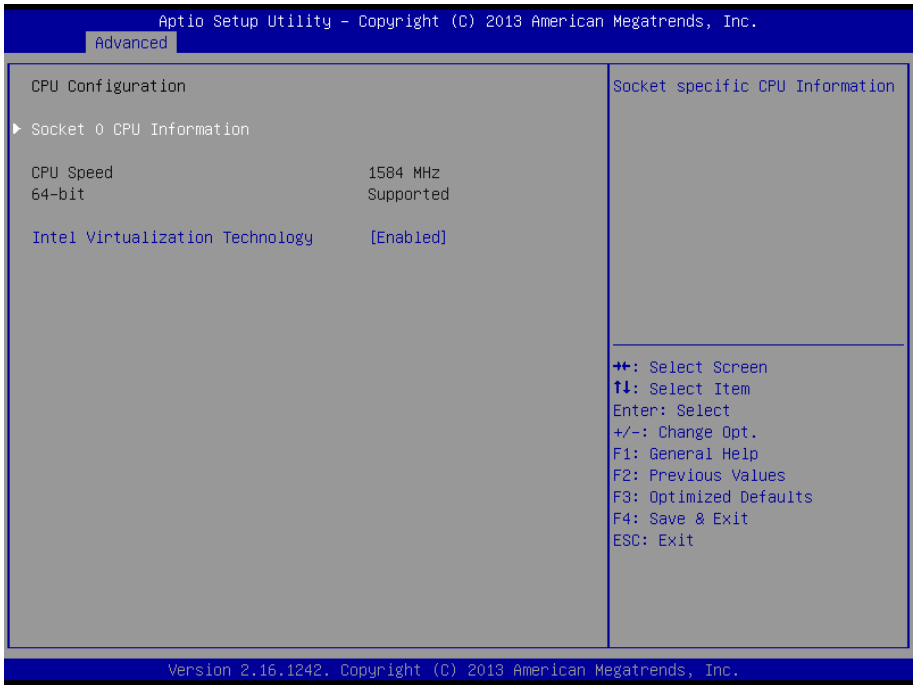

Options Summary		
Intel Virtualization Technology	Disabled	Optimal Default, Failsafe Default
	Enabled	
When enabled, a VMM can utilize the additional hardware capabilities provided by Vander pool Technology		

3.4.5.1 Socket 0 CPU Information

Aptio Setup Utility - Copyright (C) 2013 American Megatrends, Inc.

Advanced

Socket 0 CPU Information

Intel(R) Celeron(R) CPU N2807 @ 1.58GHz	
CPU Signature	30678
Microcode Patch	815
Max CPU Speed	1580 MHz
Min CPU Speed	500 MHz
Processor Cores	2
Intel HT Technology	Not Supported
Intel VT-x Technology	Supported
L1 Data Cache	24 kB x 2
L1 Code Cache	32 kB x 2
L2 Cache	1024 kB x 1
L3 Cache	Not Present

++: Select Screen
↑↓: Select Item
Enter: Select
+/-: Change Opt.
F1: General Help
F2: Previous Values
F3: Optimized Defaults
F4: Save & Exit
ESC: Exit

Version 2.16.1242. Copyright (C) 2013 American Megatrends, Inc.

3.4.6 Advanced: IDE Configuration

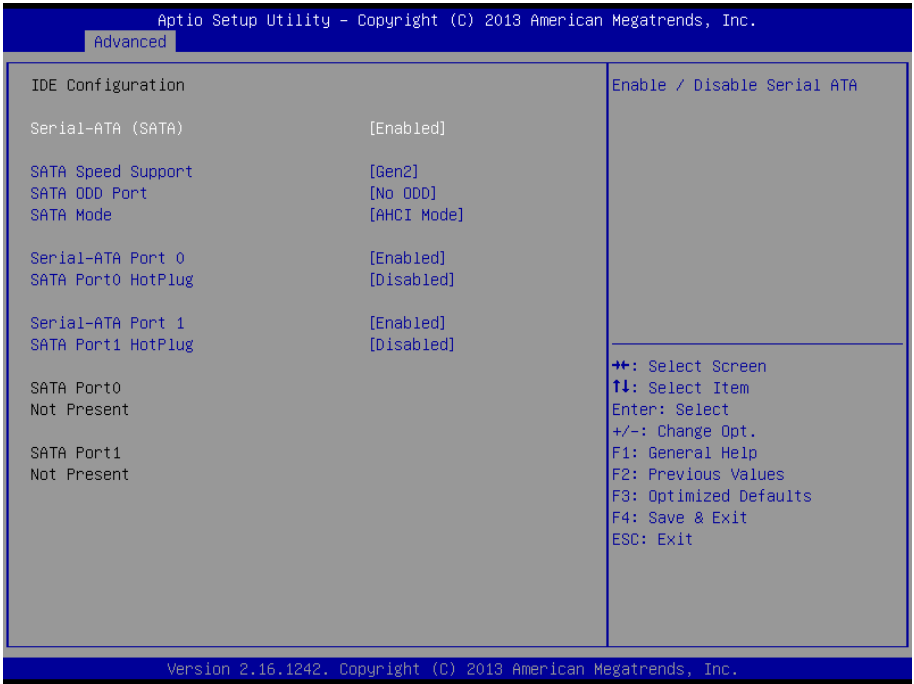

Options Summary		
SATA Mode	IDE	Default
	AHCI	
Enable/ Disable SATA Port		
IDE: Configure SATA controllers as legacy IDE		
AHCI: Configure SATA controllers to operate in AHCI mode		

3.4.7 Advanced: CSM Configuration

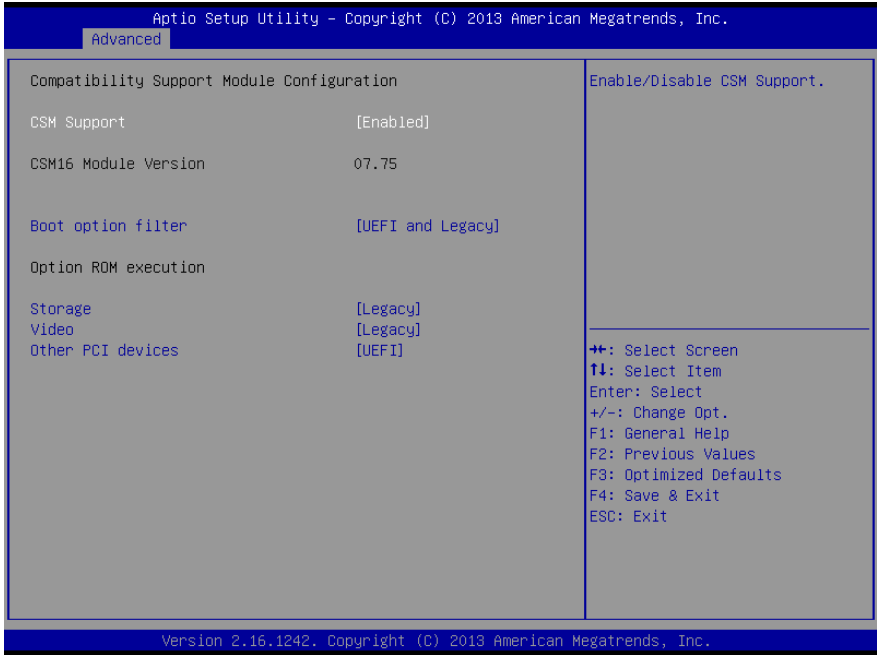

Options Summary		
CSM Support	Disabled	
	Enabled	Optimal Default, Failsafe Default
Enable/ Disable CSM		
Boot option filter	UEFI and Legacy	Optimal Default, Failsafe Default
	Legacy only	
	UEFI only	
This option controls Legacy/ UEFI ROMs priority		
Storage	Do not launch	Optimal Default, Failsafe Default
	UEFI	
	Legacy	
Controls the execution of UEFI and Legacy Storage OpROM		
Video	Do not launch	Optimal Default, Failsafe Default
	UEFI	
Controls the execution of UEFI and Legacy Video OpROM		

Options Summary		
Other PCI devices	UEFI	Optimal Default, Failsafe Default
	Legacy	
Controls the execution of UEFI and Legacy Video OpROM		

3.4.8 Advanced: Trusted Computing

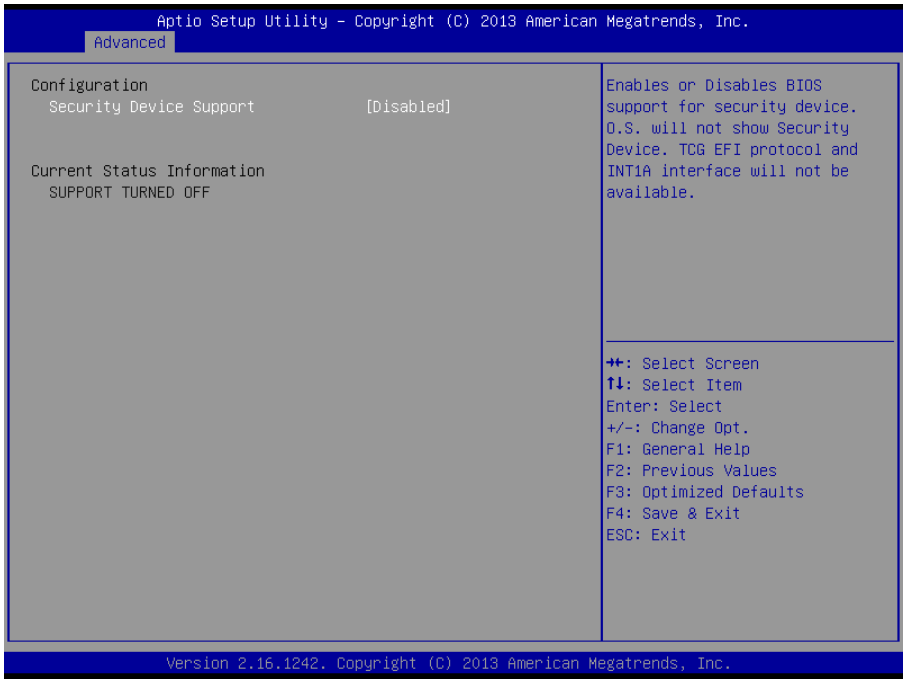

3.4.9 Advanced: USB Configuration

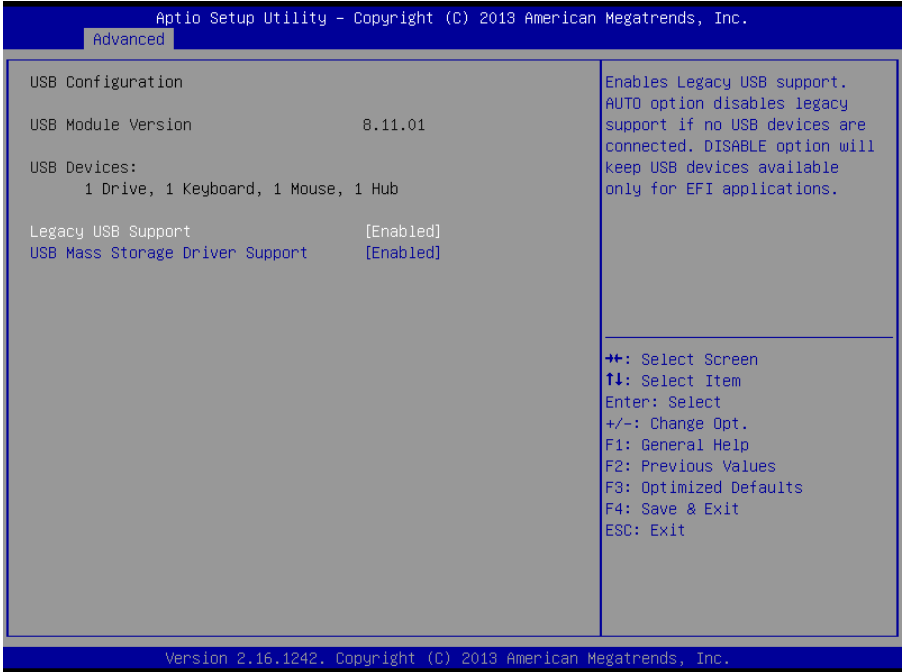

Options Summary		
Legacy USB Support	Enabled	Optimal Default, Failsafe Default
	Disabled	
	Auto	
Enables BIOS Support for Legacy USB Support. When enabled, USB can be functional in legacy environment like DOS. AUTO option disables legacy support if no USB devices are connected		
Device Name (Emulation Type)	Auto	Optimal Default, Failsafe Default
	Floppy	
	Forced FDD	
	Hard Disk	
	CDROM	
If Auto. USB devices less than 530MB will be emulated as Floppy and remaining as Floppy and remaining as hard drive. Forced FDD option can be used to force a HDD formatted drive to boot as FDD(Ex. ZIP drive)		

3.4.10 Advanced: Touch Device

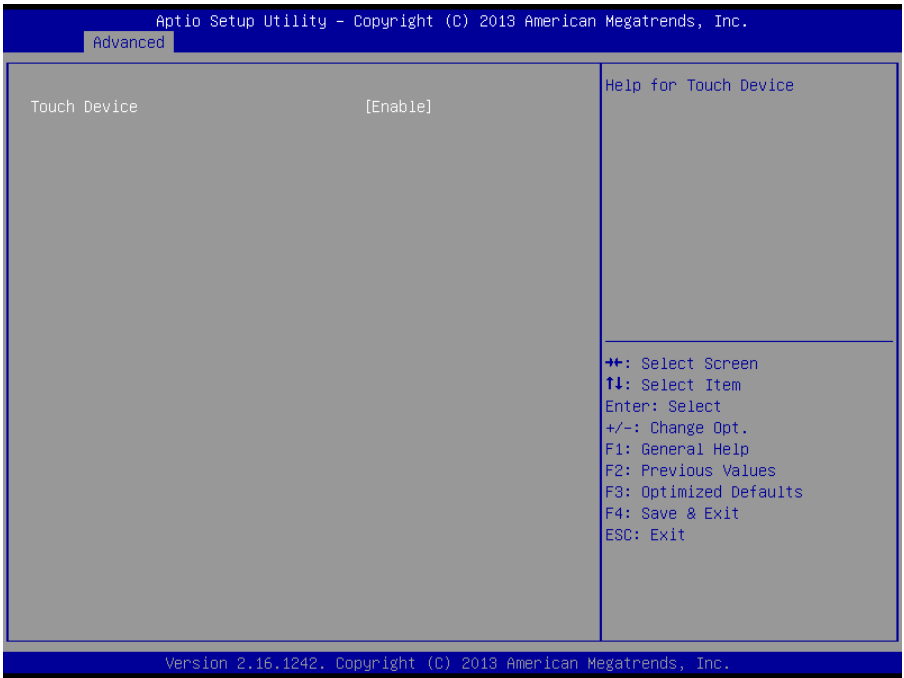

Options Summary		
Touch Device	Enabled	Optimal Default, Failsafe Default
	Disabled	

3.5 Setup submenu: Chipset

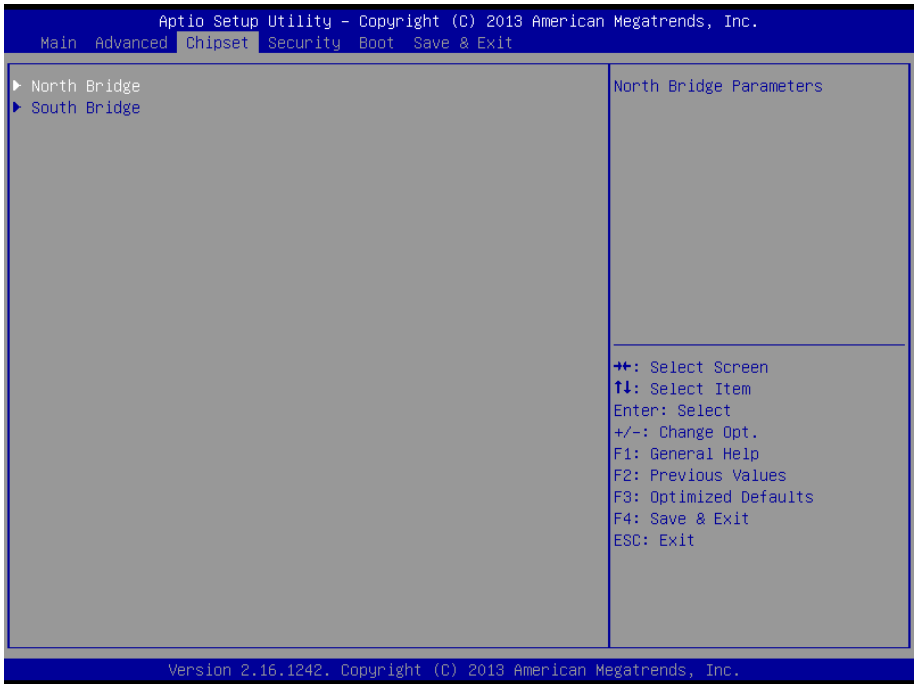

3.5.1 Chipset: Host Bridge

The screenshot shows the Aptio Setup Utility interface with the following content:

Aptio Setup Utility - Copyright (C) 2013 American Megatrends, Inc.
Chipset

Memory Information		
Total Memory	2048 MB (LPDDR3)	Select the Video Device which will be activated during POST. This has no effect if external graphics present. Secondary boot display selection will appear based on your selection. VGA modes will be supported only on primary display
Memory Slot0	2048 MB (LPDDR3)	
Primary Boot Display	[VBIOS Default]	
▶ LVDS Panel Configuration		

Legend:

- ↔: Select Screen
- ↑↓: Select Item
- Enter: Select
- +/-: Change Opt.
- F1: General Help
- F2: Previous Values
- F3: Optimized Defaults
- F4: Save & Exit
- ESC: Exit

Version 2.16.1242. Copyright (C) 2013 American Megatrends, Inc.

3.5.1.1 Host Bridge: IGD – LCD Control

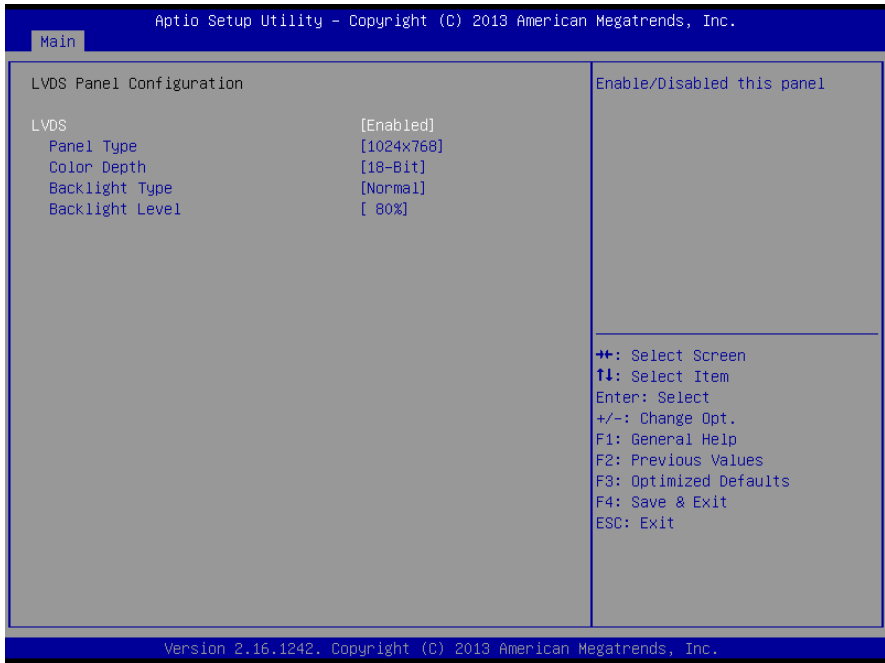

Options Summary		
LVDS	Disabled	Optimal Default, Failsafe Default
	Enabled	
Enable/ Disable LVDS		
Panel Type	640x480	Optimal Default, Failsafe Default
	800x480	
	800x600	
	1024x600	
	1024x768	
	1280x768	
	1280x800	
	1280x1024	
	1366x768	
	1440x900	
	1600x1200	

Options Summary		
Panel Type	1920x1080	
	1920x1200	
Select Panel Type		
Color Depth	18-Bit	Optimal Default, Failsafe Default
	24-Bit	
	36-Bit	
	48-Bit	
Select Color Depth		
Backlight Type	Normal	Optimal Default, Failsafe Default
	Inverted	
Select Backlight Type		
Backlight Level	0%	Optimal Default, Failsafe Default
	10%	
	20%	
	30%	
	40%	
	50%	
	60%	
	70%	
	80%	
	90%	
100%		
Backlight Level		

3.5.2 Chipset: South Bridge



3.5.2.1 South Bridge: Azalia HD Audio

Aptio Setup Utility - Copyright (C) 2013 American Megatrends, Inc.

Chipset

<p>Audio Configuration</p> <p>Audio Controller [Enabled]</p> <p> Azalia HDMI Codec [Enabled]</p> <p> HDMI Port [Enabled]</p>	<p>Control Detection of the Azalia device. Disabled = Azalia will be unconditionally disabled. Enabled = Azalia will be unconditionally Enabled. Auto = Azalia will be enabled if present disabled otherwise.</p>
<p> +*: Select Screen ↑↓: Select Item Enter: Select +/-: Change Opt. F1: General Help F2: Previous Values F3: Optimized Defaults F4: Save & Exit ESC: Exit </p>	

Version 2.16.1242. Copyright (C) 2013 American Megatrends, Inc.

Options Summary		
Azalia HD Audio	Disabled	Optimal Default, Failsafe Default
	HD Audio	
Enabling/Disabling HD Audio controller.		

3.5.2.2 South Bridge: USB Configuration

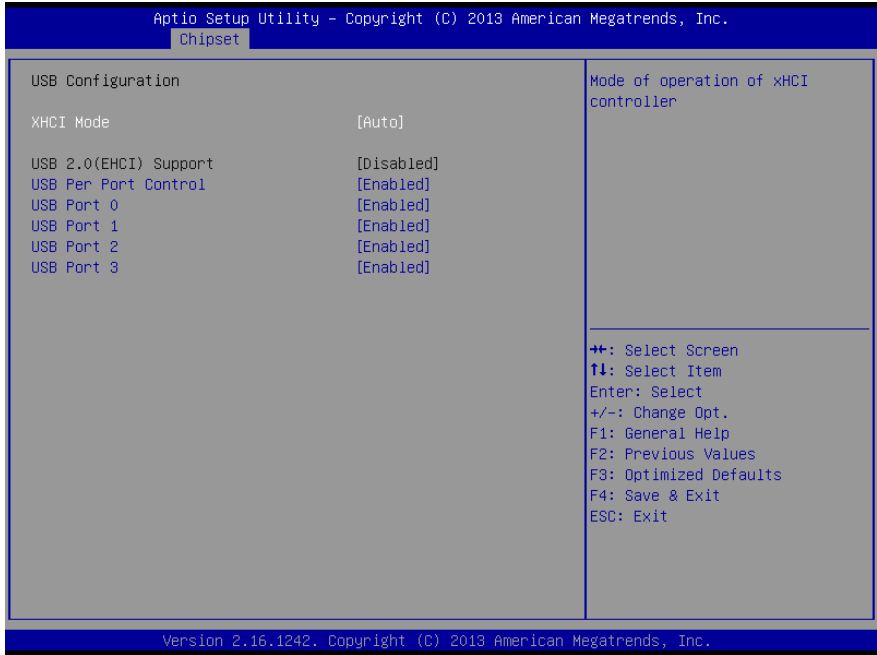

3.5.2.3 South Bridge: PCI Express Configuration

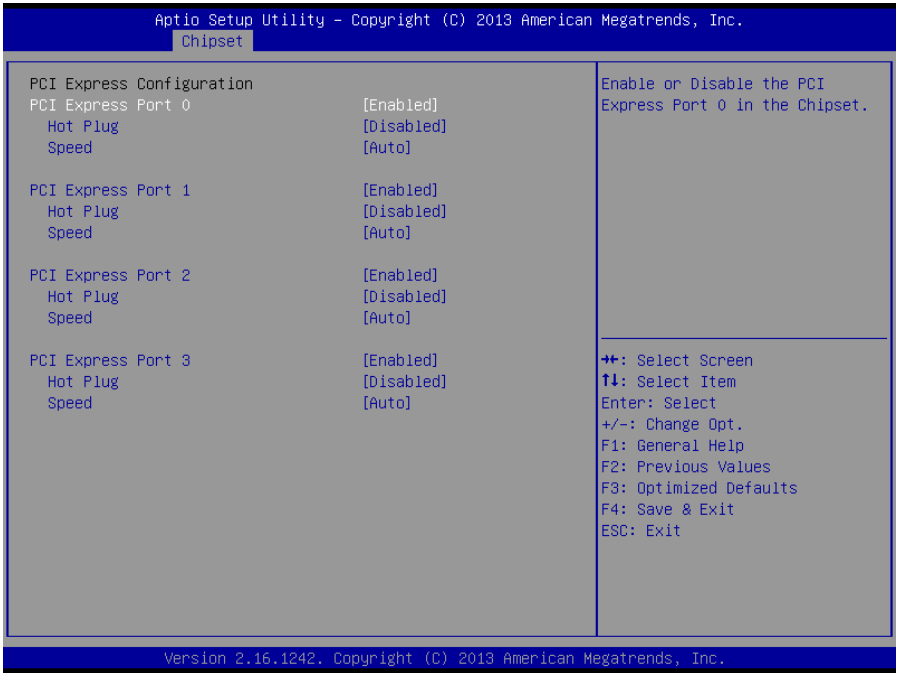

Options Summary		
PCI Express Root Port 0	Disabled	Optimal Default, Failsafe Default
	Enabled	
Enable/ Disable PCI Express root ports		
PCI Express Root Port (#)	Disabled	Optimal Default, Failsafe Default
	Enabled	
	Auto	
Enable/ Disable PCI Express root ports		

3.6 Setup submenu: Security

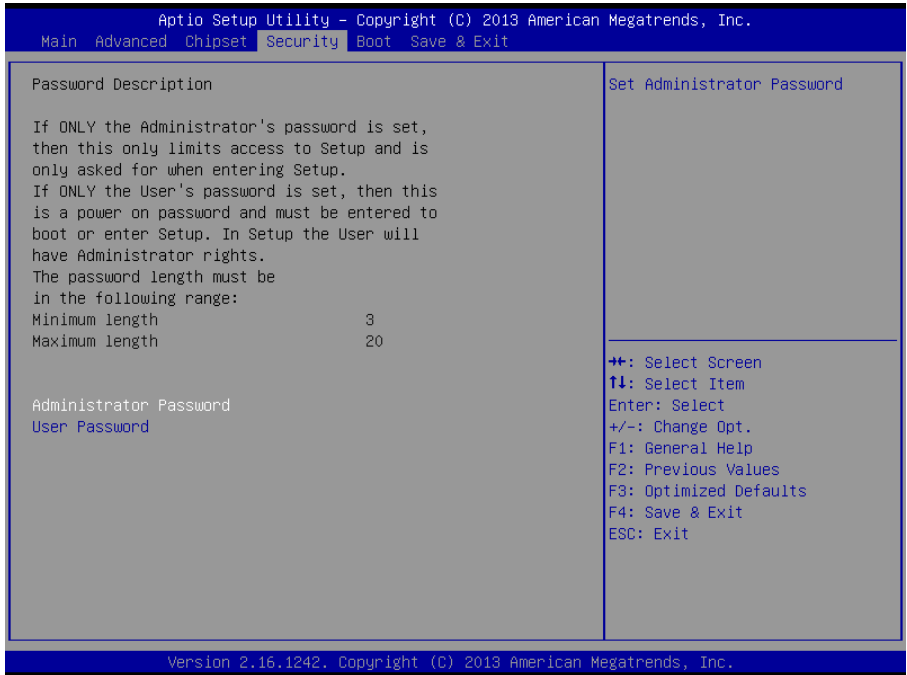

Change User/Administrator Password

You can set an Administrator Password or User Password. An Administrator Password must be set before you can set a User Password. The password will be required during boot up, or when the user enters the Setup utility. A User Password does not provide access to many of the features in the Setup utility.

Select the password you wish to set, and press Enter. In the dialog box, enter your password (must be between 3 and 20 letters or numbers). Press Enter and retype your password to confirm. Press Enter again to set the password.

Removing the Password

Select the password you want to remove and enter the current password. At the next dialog box press Enter to disable password protection.

3.7 Setup submenu: Boot

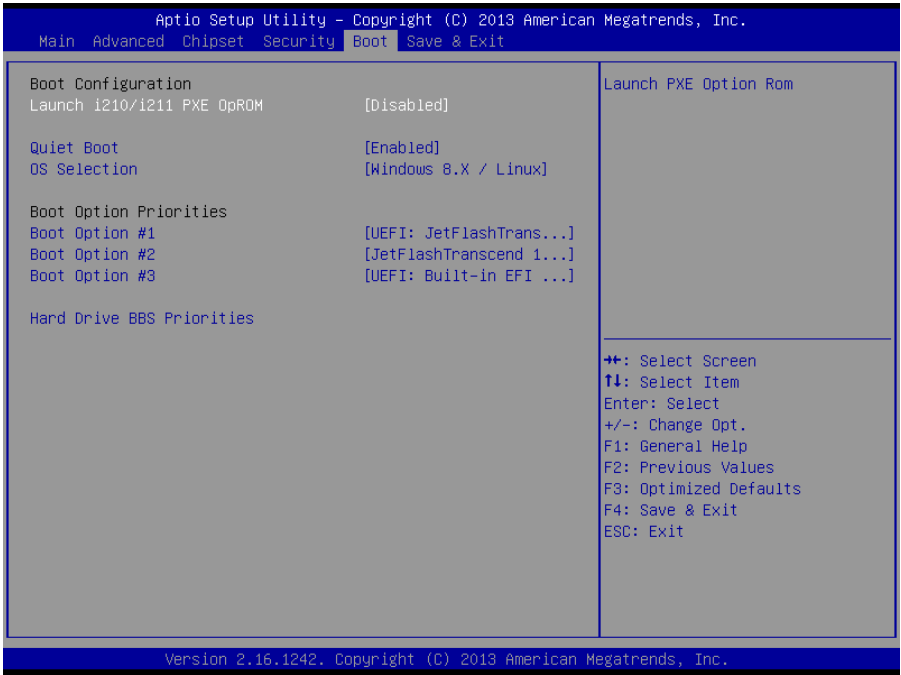

Options Summary		
Quiet Boot	Disabled	Default
	Enabled	
Enable/ Disable showing boot logo.		
Launch 8111E PXE OpROM	Disabled	Default
	Enabled	
Enable/ Disable PXE boot for 8111E LAN		

3.8 Setup submenu: Save & Exit

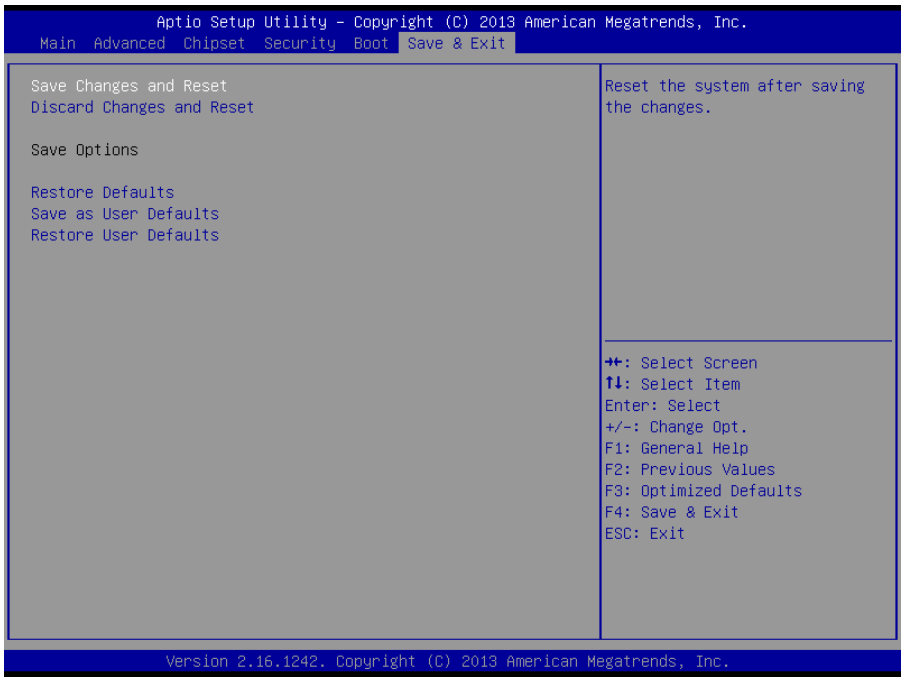

Chapter 4

Drivers Installation

4.1 Driver Download/Installation

Drivers for the GENE-BT05 A1.1 can be downloaded from the product page on the AAeon website by following this link:

<https://www.aaeon.com/en/p/3-and-half-inches-subcompact-boards-gene-bt05>

Download the driver(s) you need and follow the steps below to install them.

Step 1 – Install Chipset Drivers

1. Open the **Step1 - Chipset** folder and select your OS
2. Open the **.exe** file in the folder
3. Follow the instructions
4. Drivers will be installed automatically

Step 2 – Install Graphics Driver

1. Open the **Step2 - Graphic** folder and select your OS
2. Open the **Setup.exe** file in the folder
3. Follow the instructions
4. Drivers will be installed automatically

Step 3 – Install LAN Driver

1. Click on the **Step3 - LAN** folder and select your OS
2. Open the **.exe** file in the folder
3. Follow the instructions
4. Drivers will be installed automatically

Step 4 – Install Audio Driver (Windows 8 only)

1. Open the **Step4 - Audio** folder and select your OS
2. Open the **.exe** file in the folder

3. Follow the instructions
4. Drivers will be installed automatically

Step 5 – Install TXE Drivers

1. Open the **Step5 - TXE** folder select your OS
2. Open the **.exe** file in the folder
3. Follow the instructions
4. Drivers will be installed automatically

Step 6 – Install PenMount Touch 6000 Driver

1. Open the **Step6 - PenMount Touch 6000** folder and select your OS
2. Open the **Setup.exe** file in the folder
3. Follow the instructions
4. Drivers will be installed automatically

Step 7 – Install TPM Driver

1. Open the **Step7 - TPM** folder followed by the **Atmel TPM Driver Installer 3.0.3.15.exe** file
2. Follow the instructions
3. Drivers will be installed automatically

Step 8 – Install MBI Driver

1. Open the **Step8 - MBI** folder and select your OS
2. Open the **Setup.exe** file in the folder
3. Follow the instructions
4. Drivers will be installed automatically

Step 9 – Install USB 3.0 Driver (Windows 7 only)

1. Open the **Step9 - USB3.0** folder followed by the **Setup.exe** file
2. Follow the instructions
3. Drivers will be installed automatically

Step 10 – Install Serial Port Driver (Optional)

For Windows 7:

1. Change User Account Control settings to **Never notify**

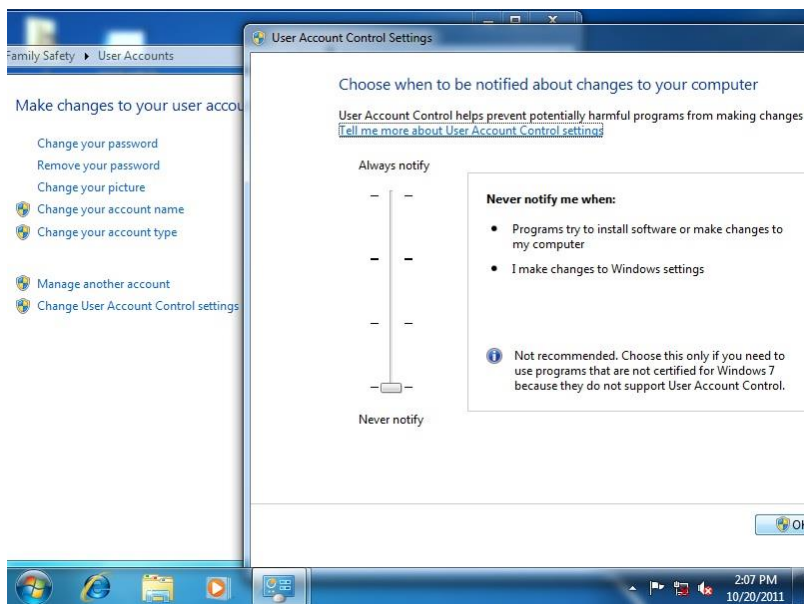

2. Reboot and log in as administrator

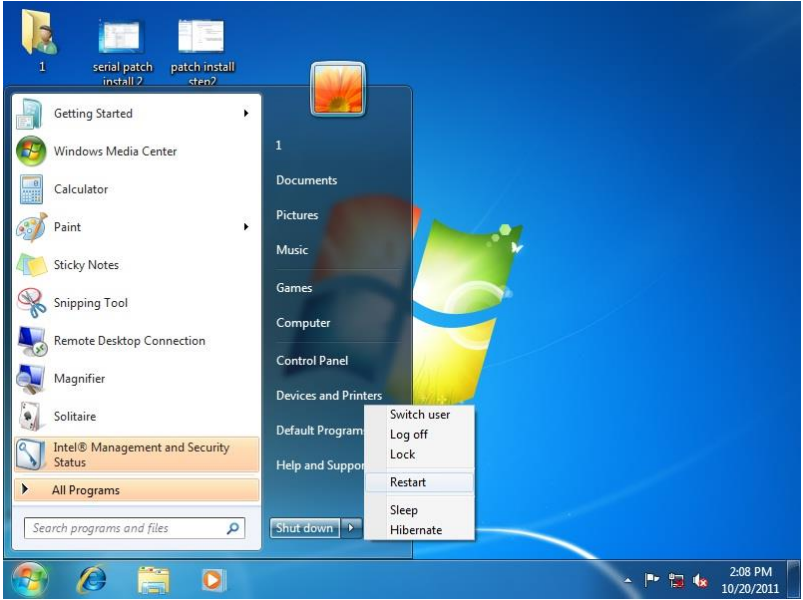

3. Run patch.bat as administrator

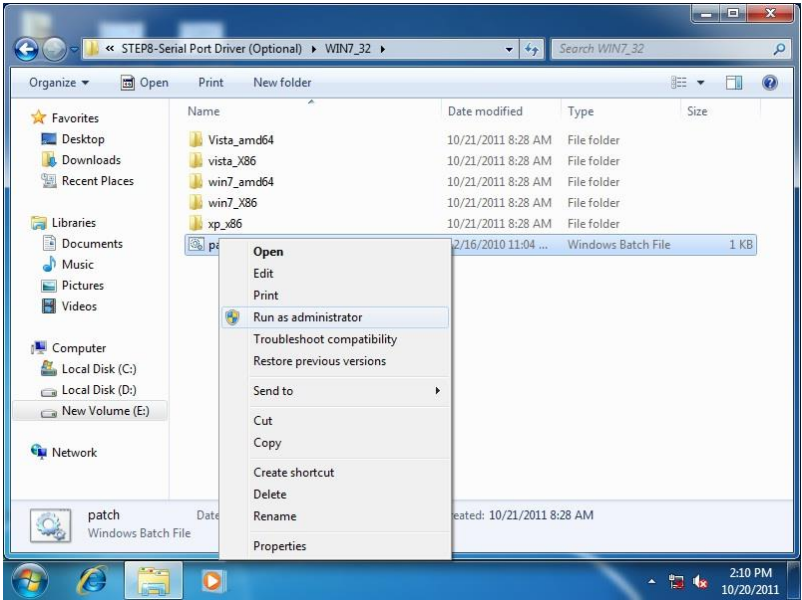

For Windows 8/ Windows 10:

1. Open the Apps Screen, right click on the **Command Prompt** tile and select **Run as Administrator**

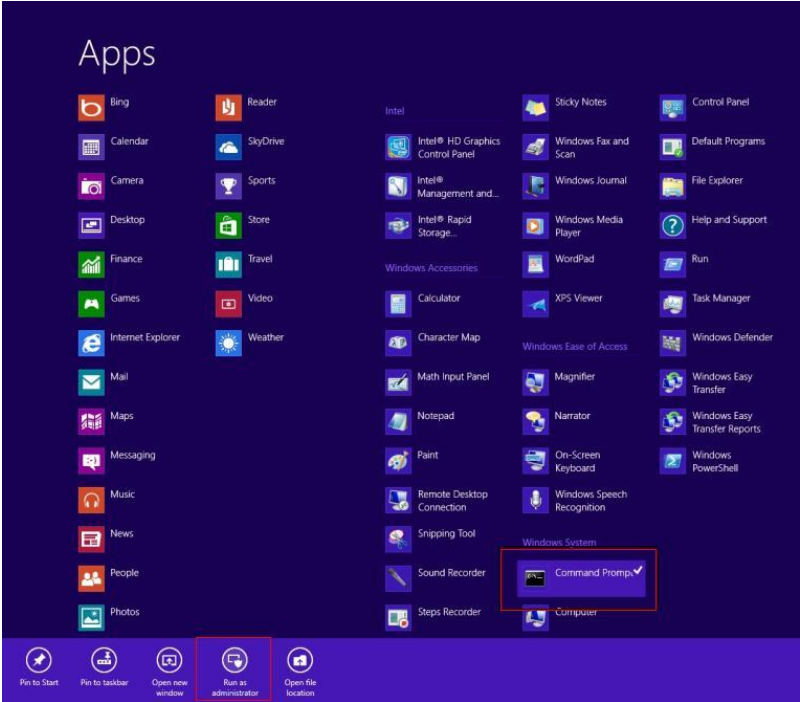

- To install the driver (patch.bat), you will first have to locate the file in command prompt. To do that, first go to the directory which contains the file by entering **<drive letter>**: eg. if the driver is in D drive, enter **D:**
- You are now at the directory containing the installation file. Next, go to the folder in which the file resides by entering **cd <folder>** eg: if the file is in a folder named abc, enter **cd <abc>**.
- You are now at the folder where the file is located. Enter the **patch.bat** to open and install the drivers. If your file is in a subfolder, enter the **cd <folder>** command again to access the subfolder (screenshot below is for reference only).

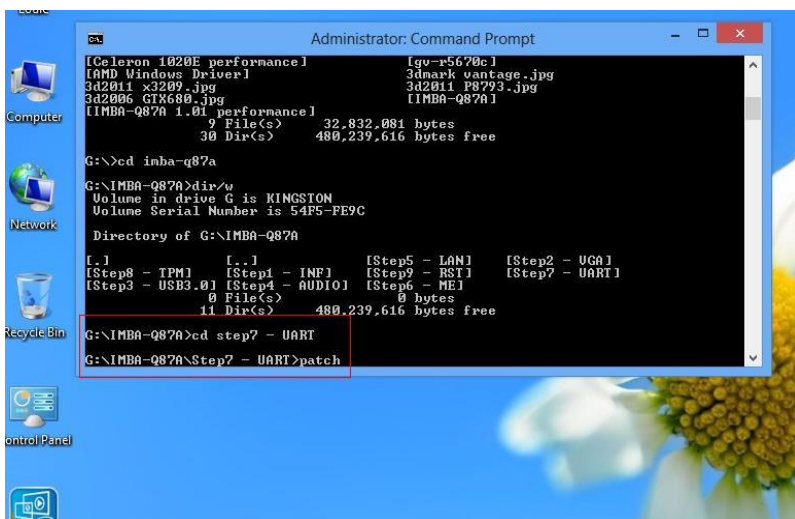

- Reboot after installation completes.
- To confirm the installation, go to Device Manager, expand the Ports (COM & LPT) tree and double click on any of the COM ports to open its properties. Go to the Driver tab, select Driver Details and click on **serial.sys**, you should see its provider as **Windows (R) Win 7 DDK Provider**.

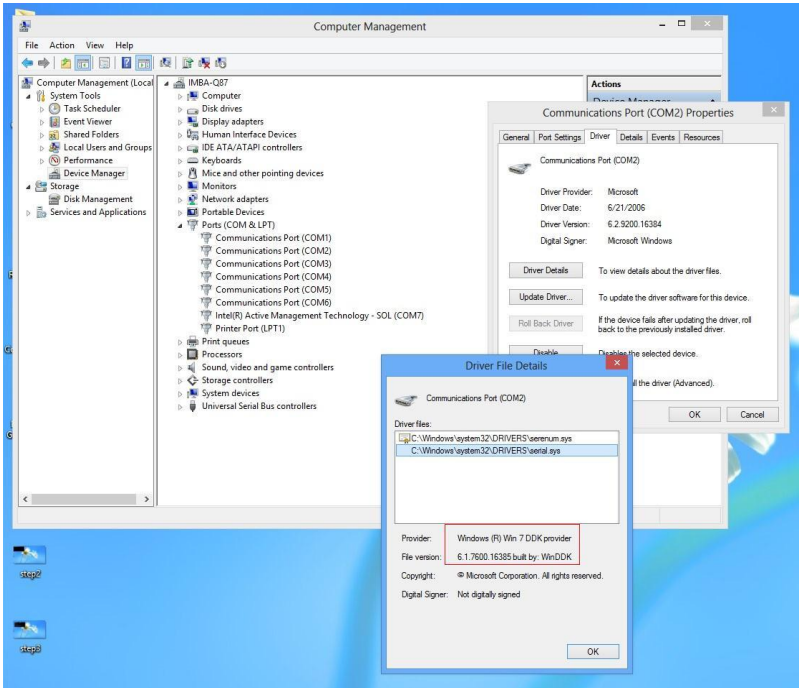

Appendix A

Watchdog Timer Programming

A.1 Watchdog Timer Registers

Table 1 : Watch dog relative IO address

I/O Base Address	Default Value	Note
	0xA00	I/O Base address for Watchdog operation. This address is assigned by SIO LDN7, register 0x60-0x61.

Table 2 : Watchdog relative register table

Register	Offset	BitNum	Value	Note
Watchdog WDTRST# Enable	0x00	7	1	Enable/Disable time out output via WDTRST# 0: Disable 1: Enable
Pulse Width	0x05	0:1	01	Width of Pulse signal 00: 1ms (do not use) 01: 25ms 10: 125ms 11: 5s <i>Pulse width is must longer than 16ms.</i>
Signal Polarity	0x05	2	0	0: low active 1: high active <i>Must set this bit to 0</i>
Counting Unit	0x05	3	0	Select time unit. 0: second 1: minute
Output Signal Type	0x05	4	1	0: Level 1: Pulse <i>Must set this bit to 1</i>
Watchdog Timer Enable	0x05	5	1	0: Disable 1: Enable
Timeout Status	0x05	6	1	1: timeout occurred. Write a 1 to clear timeout status
Timer Counter	0x06			Time of watchdog timer (0~255)

A.2 Watchdog Sample Program

```

*****// WDT I/O
operation relative definition (Please reference to Table 1)
#define WDTAddr 0xA00 // WDT I/O base address
Void WDTWriteByte(byte Register, byte Value);
byte WDTReadByte(byte Register);
Void WDTSetReg(byte Register, byte Bit, byte Val);
// Watch Dog relative definition (Please reference to Table 2)
#define DevReg 0x00 // Device configuration register
#define WDRstBit 0x80 // Watchdog WDTRST# (Bit7)
#define WDRstVal 0x80 // Enabled WDTRST#
#define TimerReg 0x05 // Timer register
#define PSWidthBit 0x00 // WDTRST# Pulse width (Bit0:1)
#define PSWidthVal 0x01 // 25ms for WDTRST# pulse
#define PolarityBit 0x02 // WDTRST# Signal polarity (Bit2)
#define PolarityVal 0x00 // Low active for WDTRST#
#define UnitBit 0x03 // Unit for timer (Bit3)
#define ModeBit 0x04 // WDTRST# mode (Bit4)
#define ModeVal 0x01 // 0:level 1: pulse
#define EnableBit 0x05 // WDT timer enable (Bit5)
#define EnableVal 0x01 // 1: enable
#define StatusBit 0x06 // WDT timer status (Bit6)
#define CounterReg 0x06 // Timer counter register
*****

```

```
*****
VOID Main(){
// Procedure : AaeonWDTConfig
// (byte)Timer : Counter of WDT timer.(0x00~0xFF)
// (boolean)Unit : Select time unit(0: second, 1: minute).
AaeonWDTConfig(Counter, Unit);
// Procedure : AaeonWDTEnable
// This procedure will enable the WDT counting.
WDTSetBit(TimerReg, PSWidthBit, PSWidthVal);
// Watchdog WDRST# Enable
WDTSetBit(DevReg, WDTRstBit, WDTRstVal);
}
VOID WDTClearTimeoutStatus(){
WDTSetBit(TimerReg, StatusBit, 1);
}
*****
```

```
*****
VOID WDTWriteByte(byte Register, byte Value){
  IOWriteByte(WDTAddr+Register, Value);
}
byte WDTReadByte(byte Register){
  return IOReadByte(WDTAddr+Register);
}
VOID WDTSetBit(byte Register, byte Bit, byte Val){
  byte TmpValue;
  TmpValue = WDTReadByte(Register);
  TmpValue &= ~(1 << Bit);
  TmpValue |= Val << Bit;
  WDTWriteByte(Register, TmpValue);
}
*****
```

Appendix B

I/O Information

B.1 I/O Address Map



































Input/output (IO)	
[0000000000000000] - 000000000000006F	PCI bus
[0000000000000020] - 0000000000000021	Programmable interrupt controller
[0000000000000024] - 0000000000000025	Programmable interrupt controller
[0000000000000028] - 0000000000000029	Programmable interrupt controller
[000000000000002C] - 000000000000002D	Programmable interrupt controller
[000000000000002E] - 000000000000002F	Motherboard resources
[0000000000000030] - 0000000000000031	Programmable interrupt controller
[0000000000000034] - 0000000000000035	Programmable interrupt controller
[0000000000000038] - 0000000000000039	Programmable interrupt controller
[000000000000003C] - 000000000000003D	Programmable interrupt controller
[0000000000000040] - 0000000000000043	System timer
[000000000000004E] - 000000000000004F	Motherboard resources
[0000000000000050] - 0000000000000053	System timer
[0000000000000061] - 0000000000000061	Motherboard resources
[0000000000000063] - 0000000000000063	Motherboard resources
[0000000000000065] - 0000000000000065	Motherboard resources
[0000000000000067] - 0000000000000067	Motherboard resources
[0000000000000070] - 0000000000000070	Motherboard resources
[0000000000000070] - 0000000000000077	System CMOS/real time clock
[0000000000000078] - 000000000000007F	PCI bus
[0000000000000080] - 000000000000008F	Motherboard resources
[0000000000000092] - 0000000000000092	Motherboard resources
[00000000000000A0] - 00000000000000A1	Programmable interrupt controller
[00000000000000A4] - 00000000000000A5	Programmable interrupt controller
[00000000000000A8] - 00000000000000A9	Programmable interrupt controller
[00000000000000AC] - 00000000000000AD	Programmable interrupt controller
[00000000000000B0] - 00000000000000B1	Programmable interrupt controller
[00000000000000B2] - 00000000000000B3	Motherboard resources
[00000000000000B4] - 00000000000000B5	Programmable interrupt controller
[00000000000000B8] - 00000000000000B9	Programmable interrupt controller
[00000000000000BC] - 00000000000000BD	Programmable interrupt controller
[000000000000002E8] - 000000000000002EF	Communications Port (COM4)
[000000000000002F8] - 000000000000002FF	Communications Port (COM2)
[00000000000000378] - 0000000000000037F	Printer Port (LPT1)
[000000000000003B0] - 000000000000003BB	Intel(R) Atom(TM) Processor E3800 Series/Intel(R) Celeron(R) Processor N2920/J1900
[000000000000003C0] - 000000000000003DF	Intel(R) Atom(TM) Processor E3800 Series/Intel(R) Celeron(R) Processor N2920/J1900
[000000000000D000] - 000000000000DFFF	Intel(R) Atom(TM)/Celeron(R)/Pentium(R) Processor PCI Express - Root Port 2 - 0F4A
[000000000000E000] - 000000000000EFFF	Intel(R) Atom(TM)/Celeron(R)/Pentium(R) Processor PCI Express - Root Port 1 - 0F48
[000000000000F000] - 000000000000F01F	Intel(R) Atom(TM)/Celeron(R)/Pentium(R) Processor Platform Control Unit - SMBus Port
[000000000000F020] - 000000000000F03F	Intel(R) Atom(TM)/Celeron(R)/Pentium(R) Processor AHCI - 0F23
[000000000000F040] - 000000000000F043	Intel(R) Atom(TM)/Celeron(R)/Pentium(R) Processor AHCI - 0F23
[000000000000F050] - 000000000000F057	Intel(R) Atom(TM)/Celeron(R)/Pentium(R) Processor AHCI - 0F23
[000000000000F060] - 000000000000F063	Intel(R) Atom(TM)/Celeron(R)/Pentium(R) Processor AHCI - 0F23
[000000000000F070] - 000000000000F077	Intel(R) Atom(TM)/Celeron(R)/Pentium(R) Processor AHCI - 0F23
[000000000000F080] - 000000000000F087	Intel(R) Atom(TM) Processor E3800 Series/Intel(R) Celeron(R) Processor N2920/J1900

















































B.2 Memory Address Map

Memory		
[000000000000A0000 - 000000000000BFFFFF]	Intel(R) Atom(TM) Processor E3800 Series/Intel(R) Celeron(R) Processor N2920/J1900	
[000000000000A0000 - 000000000000BFFFFF]	PCI bus	
[000000000000C0000 - 000000000000DFFFFF]	PCI bus	
[000000000000E0000 - 000000000000FFFFFFF]	PCI bus	
[000000000C0000000 - 000000000CFFFFFFF]	Intel(R) Atom(TM) Processor E3800 Series/Intel(R) Celeron(R) Processor N2920/J1900	
[000000000C0000000 - 000000000D0816FFF]	PCI bus	
[000000000D0000000 - 000000000D03FFFFF]	Intel(R) Atom(TM) Processor E3800 Series/Intel(R) Celeron(R) Processor N2920/J1900	
[000000000D0400000 - 000000000D04FFFFF]	Intel(R) Atom(TM)/Celeron(R)/Pentium(R) Processor Trusted Execution Engine Interface -	
[000000000D0500000 - 000000000D05FFFFF]	Intel(R) Atom(TM)/Celeron(R)/Pentium(R) Processor Trusted Execution Engine Interface -	
[000000000D0600000 - 000000000D061FFFF]	Intel(R) I211 Gigabit Network Connection	
[000000000D0600000 - 000000000D06FFFFFFF]	Intel(R) Atom(TM)/Celeron(R)/Pentium(R) Processor PCI Express - Root Port 2 - 0F4A	
[000000000D0620000 - 000000000D0623FFF]	Intel(R) I211 Gigabit Network Connection	
[000000000D0700000 - 000000000D071FFFF]	Intel(R) I211 Gigabit Network Connection #2	
[000000000D0700000 - 000000000D07FFFFFFF]	Intel(R) Atom(TM)/Celeron(R)/Pentium(R) Processor PCI Express - Root Port 1 - 0F48	
[000000000D0720000 - 000000000D0723FFF]	Intel(R) I211 Gigabit Network Connection #2	
[000000000D0800000 - 000000000D080FFFFF]	Intel(R) USB 3.0 eXtensible Host Controller	
[000000000D0810000 - 000000000D0813FFF]	High Definition Audio Controller	
[000000000D0814000 - 000000000D081401F]	Intel(R) Atom(TM)/Celeron(R)/Pentium(R) Processor Platform Control Unit - SMBus Port	
[000000000D0816000 - 000000000D08167FF]	Intel(R) Atom(TM)/Celeron(R)/Pentium(R) Processor AHCI - 0F23	
[000000000E0000000 - 000000000EFFFFFFF]	Motherboard resources	
[000000000FED00000 - 000000000FED003FF]	High precision event timer	
[000000000FED01000 - 000000000FED01FFF]	Motherboard resources	
[000000000FED03000 - 000000000FED03FFF]	Motherboard resources	
[000000000FED04000 - 000000000FED04FFF]	Motherboard resources	
[000000000FED08000 - 000000000FED08FFF]	Motherboard resources	
[000000000FED0C000 - 000000000FED0FFFF]	Motherboard resources	
[000000000FED1C000 - 000000000FED1CFFF]	Motherboard resources	
[000000000FEE00000 - 000000000FEEFFFFFFF]	Motherboard resources	
[000000000FEF00000 - 000000000FEFFFFFFF]	Motherboard resources	
[000000000FF000000 - 000000000FFFFFFFFF]	Intel(R) 82802 Firmware Hub Device	

B.3 IRQ Mapping Chart

Device	IRQ
System timer	(ISA) 0x00000000 (00)
Communications Port (COM2)	(ISA) 0x00000003 (03)
Communications Port (COM1)	(ISA) 0x00000004 (04)
High precision event timer	(ISA) 0x00000008 (08)
Communications Port (COM3)	(ISA) 0x0000000A (10)
Communications Port (COM4)	(ISA) 0x0000000A (10)
Microsoft ACPI-Compliant System	(ISA) 0x00000051 (81)
Microsoft ACPI-Compliant System	(ISA) 0x00000052 (82)
Microsoft ACPI-Compliant System	(ISA) 0x00000053 (83)
Microsoft ACPI-Compliant System	(ISA) 0x00000054 (84)
Microsoft ACPI-Compliant System	(ISA) 0x00000055 (85)
Microsoft ACPI-Compliant System	(ISA) 0x00000056 (86)
Microsoft ACPI-Compliant System	(ISA) 0x00000057 (87)
Microsoft ACPI-Compliant System	(ISA) 0x00000058 (88)
Microsoft ACPI-Compliant System	(ISA) 0x00000059 (89)
Microsoft ACPI-Compliant System	(ISA) 0x0000005A (90)
Microsoft ACPI-Compliant System	(ISA) 0x0000005B (91)
Microsoft ACPI-Compliant System	(ISA) 0x0000005C (92)
Microsoft ACPI-Compliant System	(ISA) 0x0000005D (93)
Microsoft ACPI-Compliant System	(ISA) 0x0000005E (94)
Microsoft ACPI-Compliant System	(ISA) 0x0000005F (95)
Microsoft ACPI-Compliant System	(ISA) 0x00000060 (96)
Microsoft ACPI-Compliant System	(ISA) 0x00000061 (97)
Microsoft ACPI-Compliant System	(ISA) 0x00000062 (98)
Microsoft ACPI-Compliant System	(ISA) 0x00000063 (99)
Microsoft ACPI-Compliant System	(ISA) 0x00000064 (100)
Microsoft ACPI-Compliant System	(ISA) 0x00000065 (101)
Microsoft ACPI-Compliant System	(ISA) 0x00000066 (102)
Microsoft ACPI-Compliant System	(ISA) 0x00000067 (103)
Microsoft ACPI-Compliant System	(ISA) 0x00000068 (104)
Microsoft ACPI-Compliant System	(ISA) 0x00000069 (105)
Microsoft ACPI-Compliant System	(ISA) 0x0000006A (106)
Microsoft ACPI-Compliant System	(ISA) 0x0000006B (107)
Microsoft ACPI-Compliant System	(ISA) 0x0000006C (108)
Microsoft ACPI-Compliant System	(ISA) 0x0000006D (109)
Microsoft ACPI-Compliant System	(ISA) 0x0000006E (110)
Microsoft ACPI-Compliant System	(ISA) 0x0000006F (111)
Microsoft ACPI-Compliant System	(ISA) 0x00000070 (112)
Microsoft ACPI-Compliant System	(ISA) 0x00000071 (113)

	(ISA) 0x0000007E (126)	Microsoft ACPI-Compliant System
	(ISA) 0x0000007F (127)	Microsoft ACPI-Compliant System
	(ISA) 0x00000080 (128)	Microsoft ACPI-Compliant System
	(ISA) 0x00000081 (129)	Microsoft ACPI-Compliant System
	(ISA) 0x00000082 (130)	Microsoft ACPI-Compliant System
	(ISA) 0x00000083 (131)	Microsoft ACPI-Compliant System
	(ISA) 0x00000084 (132)	Microsoft ACPI-Compliant System
	(ISA) 0x00000085 (133)	Microsoft ACPI-Compliant System
	(ISA) 0x00000086 (134)	Microsoft ACPI-Compliant System
	(ISA) 0x00000087 (135)	Microsoft ACPI-Compliant System
	(ISA) 0x00000088 (136)	Microsoft ACPI-Compliant System
	(ISA) 0x00000089 (137)	Microsoft ACPI-Compliant System
	(ISA) 0x0000008A (138)	Microsoft ACPI-Compliant System
	(ISA) 0x0000008B (139)	Microsoft ACPI-Compliant System
	(ISA) 0x0000008C (140)	Microsoft ACPI-Compliant System
	(ISA) 0x0000008D (141)	Microsoft ACPI-Compliant System
	(ISA) 0x0000008E (142)	Microsoft ACPI-Compliant System
	(ISA) 0x0000008F (143)	Microsoft ACPI-Compliant System
	(ISA) 0x00000090 (144)	Microsoft ACPI-Compliant System
	(ISA) 0x00000091 (145)	Microsoft ACPI-Compliant System
	(ISA) 0x00000092 (146)	Microsoft ACPI-Compliant System
	(ISA) 0x00000093 (147)	Microsoft ACPI-Compliant System
	(ISA) 0x00000094 (148)	Microsoft ACPI-Compliant System
	(ISA) 0x00000095 (149)	Microsoft ACPI-Compliant System
	(ISA) 0x00000096 (150)	Microsoft ACPI-Compliant System
	(ISA) 0x00000097 (151)	Microsoft ACPI-Compliant System
	(ISA) 0x00000098 (152)	Microsoft ACPI-Compliant System
	(ISA) 0x00000099 (153)	Microsoft ACPI-Compliant System
	(ISA) 0x0000009A (154)	Microsoft ACPI-Compliant System
	(ISA) 0x0000009B (155)	Microsoft ACPI-Compliant System
	(ISA) 0x0000009C (156)	Microsoft ACPI-Compliant System
	(ISA) 0x0000009D (157)	Microsoft ACPI-Compliant System
	(ISA) 0x0000009E (158)	Microsoft ACPI-Compliant System
	(ISA) 0x0000009F (159)	Microsoft ACPI-Compliant System
	(ISA) 0x000000A0 (160)	Microsoft ACPI-Compliant System

	(ISA) 0x000000A1 (161)	Microsoft ACPI-Compliant System
	(ISA) 0x000000A2 (162)	Microsoft ACPI-Compliant System
	(ISA) 0x000000A3 (163)	Microsoft ACPI-Compliant System
	(ISA) 0x000000A4 (164)	Microsoft ACPI-Compliant System
	(ISA) 0x000000A5 (165)	Microsoft ACPI-Compliant System
	(ISA) 0x000000A6 (166)	Microsoft ACPI-Compliant System
	(ISA) 0x000000A7 (167)	Microsoft ACPI-Compliant System
	(ISA) 0x000000A8 (168)	Microsoft ACPI-Compliant System
	(ISA) 0x000000A9 (169)	Microsoft ACPI-Compliant System
	(ISA) 0x000000AA (170)	Microsoft ACPI-Compliant System
	(ISA) 0x000000AB (171)	Microsoft ACPI-Compliant System
	(ISA) 0x000000AC (172)	Microsoft ACPI-Compliant System
	(ISA) 0x000000AD (173)	Microsoft ACPI-Compliant System
	(ISA) 0x000000AE (174)	Microsoft ACPI-Compliant System
	(ISA) 0x000000AF (175)	Microsoft ACPI-Compliant System
	(ISA) 0x000000B0 (176)	Microsoft ACPI-Compliant System
	(ISA) 0x000000B1 (177)	Microsoft ACPI-Compliant System
	(ISA) 0x000000B2 (178)	Microsoft ACPI-Compliant System
	(ISA) 0x000000B3 (179)	Microsoft ACPI-Compliant System
	(ISA) 0x000000B4 (180)	Microsoft ACPI-Compliant System
	(ISA) 0x000000B5 (181)	Microsoft ACPI-Compliant System
	(ISA) 0x000000B6 (182)	Microsoft ACPI-Compliant System
	(ISA) 0x000000B7 (183)	Microsoft ACPI-Compliant System
	(ISA) 0x000000B8 (184)	Microsoft ACPI-Compliant System
	(ISA) 0x000000B9 (185)	Microsoft ACPI-Compliant System
	(ISA) 0x000000BA (186)	Microsoft ACPI-Compliant System
	(ISA) 0x000000BB (187)	Microsoft ACPI-Compliant System
	(ISA) 0x000000BC (188)	Microsoft ACPI-Compliant System
	(ISA) 0x000000BD (189)	Microsoft ACPI-Compliant System
	(ISA) 0x000000BE (190)	Microsoft ACPI-Compliant System
	(PCI) 0x0000000B (11)	Intel(R) Atom(TM)/Celeron(R)/Pentium(R) Processor Platform Control Unit - SMBus Port - 0F12
	(PCI) 0x00000010 (16)	Intel(R) Atom(TM)/Celeron(R)/Pentium(R) Processor PCI Express - Root Port 1 - 0F48
	(PCI) 0x00000011 (17)	Intel(R) Atom(TM)/Celeron(R)/Pentium(R) Processor PCI Express - Root Port 2 - 0F4A
	(PCI) 0x00000013 (19)	Intel(R) Atom(TM)/Celeron(R)/Pentium(R) Processor AHCI - 0F23
	(PCI) 0x00000016 (22)	High Definition Audio Controller
	(PCI) 0xFFFFFFFF1 (-15)	Intel(R) I211 Gigabit Network Connection
	(PCI) 0xFFFFFFFF2 (-14)	Intel(R) I211 Gigabit Network Connection
	(PCI) 0xFFFFFFFF3 (-13)	Intel(R) I211 Gigabit Network Connection
	(PCI) 0xFFFFFFFF4 (-12)	Intel(R) I211 Gigabit Network Connection
	(PCI) 0xFFFFFFFF5 (-11)	Intel(R) I211 Gigabit Network Connection
	(PCI) 0xFFFFFFFF6 (-10)	Intel(R) I211 Gigabit Network Connection
	(PCI) 0xFFFFFFFF7 (-9)	Intel(R) I211 Gigabit Network Connection #2
	(PCI) 0xFFFFFFFF8 (-8)	Intel(R) I211 Gigabit Network Connection #2
	(PCI) 0xFFFFFFFF9 (-7)	Intel(R) I211 Gigabit Network Connection #2
	(PCI) 0xFFFFFFFFFA (-6)	Intel(R) I211 Gigabit Network Connection #2
	(PCI) 0xFFFFFFFFFB (-5)	Intel(R) I211 Gigabit Network Connection #2
	(PCI) 0xFFFFFFFFFC (-4)	Intel(R) I211 Gigabit Network Connection #2
	(PCI) 0xFFFFFFFFFD (-3)	Intel(R) USB 3.0 eXtensible Host Controller
	(PCI) 0xFFFFFFFFFE (-2)	Intel(R) Atom(TM) Processor E3800 Series/Intel(R) Celeron(R) Processor N2920/1900

B.4 DMA Channel Assignments

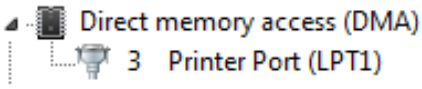

Appendix C

Mating Connectors

C.1 List of Mating Connectors and Cables

Connector Label	Function	Mating Connector		Available Cable	Cable P/N
		Vendor	Model no		
CN1	External AUX Power and PS_ON#	JST	PHR-6	N/A	N/A
CN3	LVDS Inverter Connector	JST	PHR-5	N/A	N/A
CN4	+5Vout Connector	JST	PHR-2	2 Pins For SATA HDD Power	1702150155
CN5	External +5VSB Power Input and PS_ON#	JST	XHP-3	ATX Cable	170220020B
CN6	SATA Connector	Molex	887505318	SATA Cable	1709070500
CN7	+12V Vin Connector	Molex	19211-0003	Power Cable	170204010R
CN8	LVDS Connector	HIROSE	DF13-30DS-1.25C	N/A	N/A
CN9	Audio Connector	Molex	51021-1000	Audio Cable	1709100254
CN11	LPC Connector	JST	SHR-12V-S-B	AAEON LPC Cable	1703120130
CN12	COM Port #2 Connector	Molex	51021-0900	Serial Port Cable	1701090150

Connector Label	Function	Mating Connector		Available Cable	Cable P/N
		Vendor	Model no		
CN13	LPT Connector	Molex	51110-2650	Parallel Port Cable	1701260200
CN14	COM Port #3 Connector	Molex	51021-0900	Serial Port Cable	1701090150
CN15	COM Port #4 Connector	Molex	51021-0900	Serial Port Cable	1701090150
CN16	Digital IO Connector	Molex	51110-1050	N/A	N/A
CN17	USB Port #3 Connector	Molex	51021-0500	USB Cable	1700050207
CN18	USB Port #2 Connector	Molex	51021-0500	USB Cable	1700050207
CN22	PS/2 KB/MS Connector	JST	PHDR-06VS	PS/2 KB/MS Cable	1700060152
CN23	Touch Screen Connector	JST	SHR-9V-S-B	N/A	N/A
CN24	CPU Fan Connector	Molex	22-01-2035	N/A	N/A
CN31	External RTC Connector	Molex	51021-0200	Battery Cable	175011901M

Appendix D

Electrical Specifications for I/O Ports

D.1 Electrical Specifications for I/O Ports

I/O	Reference	Signal Name	Rate Output
LVDS Port Inverter / Backlight Connector	CN3	+5V/+12V	+5V/1.5A or +12V/1.5A
+5V Output for SATA HDD	CN4	+5V	+5V/1A
LVDS Port	CN8	+3.3V/+5V	+3.3V/2A or +5V/2A
Audio I/O Port	CN9	+5V	+5V/1A
Mini-Card Slot (Half-Mini Card)	CN10	+3.3VSB +1.5V	+3.3V/1.1A +1.5V/0.375A
LPC Port	CN11	+3.3V	+3.3V/0.5A
COM Port 2	CN12	+5V/+12V	+5V/1A or +12V/1A
COM Port 3	CN14	+5V/+12V	+5V/1A or +12V/1A
Digital IO Port	CN16	+5V	+5V/1A
USB 2.0 Ports 3	CN17	+5VSB	+5V/0.5A (per channel)
USB 2.0 Ports 2	CN18	+5VSB	
PS/2 Keyboard/Mouse Combo Port	CN22	+5VSB	+5V/1A

I/O	Reference	Signal Name	Rate Output
CPU FAN	CN24	+12V	+12V/0.5A
USB Ports 0 and 1	CN25	+5VSB	+5V/1A (per channel)
HDMI Port	CN29	+5V	+5V/1A
VGA Port	CN30	+5V	+5V/1A (reserved)
CFast Slot	CN33	+3.3V	+3.3V/0.5A
Mini-Card Slot (Full-Mini Card)	CN37	+3.3VSB +1.5V	+3.3V/1.1A +1.5V/0.375A
LVDS Port Inverter / Backlight Connector	CN3	+5V/+12V	+5V/1.5A or +12V/1.5A
+5V Output for SATA HDD	CN4	+5V	+5V/1A
LVDS Port	CN8	+3.3V/+5V	+3.3V/2A or +5V/2A