

GENE-BT04

3.5" Subcompact Board

User's Manual 4th Ed

Copyright Notice

This document is copyrighted, 2019. All rights are reserved. The original manufacturer reserves the right to make improvements to the products described in this manual at any time without notice.

No part of this manual may be reproduced, copied, translated, or transmitted in any form or by any means without the prior written permission of the original manufacturer. Information provided in this manual is intended to be accurate and reliable. However, the original manufacturer assumes no responsibility for its use, or for any infringements upon the rights of third parties that may result from its use.

The material in this document is for product information only and is subject to change without notice. While reasonable efforts have been made in the preparation of this document to assure its accuracy, AAEMON assumes no liabilities resulting from errors or omissions in this document, or from the use of the information contained herein.

AAEMON reserves the right to make changes in the product design without notice to its users.

Acknowledgement

All other products' name or trademarks are properties of their respective owners.

- Microsoft Windows is a registered trademark of Microsoft Corp.
- Intel, Pentium, Celeron, and Xeon are registered trademarks of Intel Corporation
- Core, Atom are trademarks of Intel Corporation
- ITE is a trademark of Integrated Technology Express, Inc.
- IBM, PC/AT, PS/2, and VGA are trademarks of International Business Machines Corporation.

All other product names or trademarks are properties of their respective owners.

Packing List

Before setting up your product, please make sure the following items have been shipped:

| Item | Quantity |
|----------------------------------|----------|
| ● GENE-BT04 (with heat spreader) | 1 |
| ● Power Cable | 1 |

If any of these items are missing or damaged, please contact your distributor or sales representative immediately.

About this Document

This User's Manual contains all the essential information, such as detailed descriptions and explanations on the product's hardware and software features (if any), its specifications, dimensions, jumper/connector settings/definitions, and driver installation instructions (if any), to facilitate users in setting up their product.

Users may refer to the AAEON.com for the latest version of this document.

Safety Precautions

Please read the following safety instructions carefully. It is advised that you keep this manual for future references

1. All cautions and warnings on the device should be noted.
2. Make sure the power source matches the power rating of the device.
3. Position the power cord so that people cannot step on it. Do not place anything over the power cord.
4. Always completely disconnect the power before working on the system's hardware.
5. No connections should be made when the system is powered as a sudden rush of power may damage sensitive electronic components.
6. If the device is not to be used for a long time, disconnect it from the power supply to avoid damage by transient over-voltage.
7. Always disconnect this device from any AC supply before cleaning.
8. While cleaning, use a damp cloth instead of liquid or spray detergents.
9. Make sure the device is installed near a power outlet and is easily accessible.
10. Keep this device away from humidity.
11. Place the device on a solid surface during installation to prevent falls
12. Do not cover the openings on the device to ensure optimal heat dissipation.
13. Watch out for high temperatures when the system is running.
14. Do not touch the heat sink or heat spreader when the system is running
15. Never pour any liquid into the openings. This could cause fire or electric shock.
16. As most electronic components are sensitive to static electrical charge, be sure to ground yourself to prevent static charge when installing the internal components. Use a grounding wrist strap and contain all electronic components in any static-shielded containers.

17. If any of the following situations arises, please the contact our service personnel:
 - i. Damaged power cord or plug
 - ii. Liquid intrusion to the device
 - iii. Exposure to moisture
 - iv. Device is not working as expected or in a manner as described in this manual
 - v. The device is dropped or damaged
 - vi. Any obvious signs of damage displayed on the device
18. **DO NOT LEAVE THIS DEVICE IN AN UNCONTROLLED ENVIRONMENT WITH TEMPERATURES BEYOND THE DEVICE'S PERMITTED STORAGE TEMPERATURES (SEE CHAPTER 1) TO PREVENT DAMAGE.**

Warning!



This device complies with Part 15 FCC Rules. Operation is subject to the following two conditions: (1) this device may not cause harmful interference, and (2) this device must accept any interference received including interference that may cause undesired operation.

Caution:

There is a danger of explosion if the battery is incorrectly replaced. Replace only with the same or equivalent type recommended by the manufacturer. Dispose of used batteries according to the manufacturer's instructions and your local government's recycling or disposal directives.

Attention:

Il y a un risque d'explosion si la batterie est remplacée de façon incorrecte. Ne la remplacer qu'avec le même modèle ou équivalent recommandé par le constructeur. Recycler les batteries usées en accord avec les instructions du fabricant et les directives gouvernementales de recyclage.

China RoHS Requirements (CN)

产品中有毒有害物质或元素名称及含量

AAEON Main Board/ Daughter Board/ Backplane

| 部件名称 | 有毒有害物质或元素 | | | | | |
|--|-----------|-----------|-----------|-----------------|---------------|-----------------|
| | 铅 (Pb) | 汞 (Hg) | 镉 (Cd) | 六价铬 (Cr(VI)) | 多溴联苯 (PBB) | 多溴二苯醚 (PBDE) |
| 印刷电路板 及其电子组件 | × | ○ | ○ | ○ | ○ | ○ |
| 外部信号 连接器及线材 | × | ○ | ○ | ○ | ○ | ○ |
| <p>○: 表示该有毒有害物质在该部件所有均质材料中的含量均在 SJ/T 11363-2006 标准规定的限量要求以下。</p> <p>X: 表示该有毒有害物质至少在该部件的某一均质材料中的含量超出 SJ/T 11363-2006 标准规定的限量要求。</p> <p>备注: 此产品所标示之环保使用期限, 系指在一般正常使用状况下。</p> | | | | | | |

China RoHS Requirement (EN)

Poisonous or Hazardous Substances or Elements in Products

AAEON Main Board/ Daughter Board/ Backplane

| Component | Poisonous or Hazardous Substances or Elements | | | | | |
|---|---|--------------|--------------|------------------------------|--------------------------------|---------------------------------------|
| | Lead (Pb) | Mercury (Hg) | Cadmium (Cd) | Hexavalent Chromium (Cr(VI)) | Polybrominated Biphenyls (PBB) | Polybrominated Diphenyl Ethers (PBDE) |
| PCB & Other Components | X | ○ | ○ | ○ | ○ | ○ |
| Wires & Connectors for External Connections | X | ○ | ○ | ○ | ○ | ○ |
| <p>O: The quantity of poisonous or hazardous substances or elements found in each of the component's parts is below the SJ/T 11363-2006-stipulated requirement.</p> <p>X: The quantity of poisonous or hazardous substances or elements found in at least one of the component's parts is beyond the SJ/T 11363-2006-stipulated requirement.</p> <p>Note: The Environment Friendly Use Period as labeled on this product is applicable under normal usage only</p> | | | | | | |

Table of Contents

| | |
|---|----------|
| Chapter 1 - Product Specifications | 1 |
| 1.1 Specifications | 2 |
| Chapter 2 – Hardware Information | 4 |
| 2.1 Dimensions | 5 |
| 2.2 Jumpers and Connectors..... | 7 |
| 2.3 Block Diagram..... | 9 |
| 2.4 List of Jumpers | 10 |
| 2.4.1 Clear CMOS Jumper (CN12, Pin 1,3,5) | 11 |
| 2.4.2 Auto Power Button Enable/Disable Selection (JP12, Pin 2,4,6)... | 11 |
| 2.4.3 Push POWER Button with Orange LED (SW4)..... | 11 |
| 2.5 List of Connectors..... | 13 |
| 2.5.1 COM Port RS-232 (CN1) | 14 |
| 2.5.2 +12 V Input (CN2) | 14 |
| 2.5.3 LAN Port 1/2/3/4 (RJ-45) (CN3,4,5,6) | 15 |
| 2.5.4 +5 V Output for SATA HDD (CN7) | 15 |
| 2.5.5 SATA Port (CN8)..... | 16 |
| 2.5.6 DDR3L SODIMM Slot (CN9)..... | 16 |
| 2.5.7 Digital I/O Port (CN10) | 16 |
| 2.5.8 CFast Card Connector (CN11) | 17 |
| 2.5.9 MiniCard Slot (USB Port2 only) (CN13)..... | 18 |
| 2.5.10 Battery (CN14)..... | 21 |
| 2.5.11 Buzzer Connector (CN15)..... | 21 |
| 2.5.12 Front Panel Connector (CN16)..... | 21 |
| 2.5.13 USB 3.0 Port 0 (CN17) | 22 |
| 2.5.14 USB 2.0 Port 3 and 1 (CN18/ 19)..... | 23 |
| 2.5.15 HDMI Port 1 and 2 (CN20/ 21)..... | 23 |

| | | |
|---|---|-----------|
| 2.5.16 | LPC Port (CN22) | 24 |
| 2.5.17 | SPI Programming Header (CN23) | 25 |
| Chapter 3 - AMI BIOS Setup | | 26 |
| 3.1 | System Test and Initialization | 27 |
| 3.2 | AMI BIOS Setup | 28 |
| 3.3 | Setup submenu: Main | 29 |
| 3.4 | Setup submenu: Advanced | 30 |
| 3.4.1 | Advanced: ACPI Settings | 31 |
| 3.4.2 | Advanced: F81801 Super IO Configuration | 33 |
| 3.4.2.1 | F81801 Super IO Configuration: Serial Port 1 Configuration | 34 |
| 3.4.3 | Advanced: H/W Monitor | 36 |
| 3.4.4 | Advanced: CPU Configuration | 37 |
| 3.4.4.1 | CPU Configuration: Socket 0 CPU Configuration | 38 |
| 3.4.5 | Advanced: IDE Configuration | 39 |
| 3.4.6 | Advanced: Dynamic Digital IO Configuration | 41 |
| 3.4.7 | Advanced: USB Configuration | 42 |
| 3.5 | Setup Submenu: Chipset | 44 |
| 3.5.1 | Chipset: Host Bridge | 45 |
| 3.5.1.1 | Host Bridge: LCD Control | 46 |
| 3.5.2 | Chipset: South Bridge | 47 |
| 3.5.2.1 | South Bridge: USB Configuration | 48 |
| 3.5.2.2 | South Bridge: PCI Express Configuration | 50 |
| 3.6 | Setup submenu: Security | 51 |
| 3.6.1 | Security: Secure Boot | 53 |
| 3.7 | Setup submenu: Boot | 54 |
| 3.8 | Setup submenu: Save & Exit | 55 |
| Chapter 4 – Drivers Installation | | 56 |

| | | |
|--|--|-----------|
| 4.1 | Driver Download/Installation | 57 |
| Appendix A - Watchdog Timer Programming..... | | 59 |
| A.1 | Watchdog Timer Registers | 60 |
| A.2 | Watchdog Sample Program..... | 61 |
| Appendix B - I/O Information | | 64 |
| B.1 | I/O Address Map | 65 |
| B.2 | Memory Address Map | 67 |
| B.3 | IRQ Mapping Chart..... | 68 |
| Appendix C – Mating Connectors | | 80 |
| C.1 | List of Mating Connectors and Cables..... | 81 |
| Appendix D – Electrical Specifications for I/O Ports..... | | 82 |
| D.1 | Electrical Specifications for I/O Ports..... | 83 |
| Appendix E – Digital I/O Ports | | 84 |
| E.1 | Electrical Specifications for Digital I/O Ports..... | 85 |
| E.2 | D/I/O Programming | 86 |
| E.3 | Digital I/O Register..... | 87 |
| E.4 | Digital I/O Sample Program..... | 88 |

Chapter 1

Product Specifications

1.1 Specifications

System

| | |
|-----------------------------|--|
| Form Factor | 3.5" SubCompact Board |
| CPU | Intel® Celeron® J1900/ N2807 Processor SoC |
| CPU Frequency | Up to 2.0GHz |
| Chipset | Intel® Celeron® J1900/ N2807 Processor SoC |
| Memory Type | DDR3L 1333, SODIMM x 1 |
| Max. Memory Capacity | Up to 8G |
| BIOS | UEFI |
| Wake on LAN | Yes |
| Watchdog Timer | 255 Levels |
| Power Requirement | +12V ~ +24V |
| Power Supply Type | ATX mode |
| Power Consumption (Typical) | Intel® N2807, DDR3L 1600MHz 4G, 0.65A@ +12V |
| Dimension (L x W) | 5.75" x 4" (146mm x 101.6mm) |
| Operating Temperature | 32°F ~ 140°F (0°C ~ 60°C) |
| Storage Temperature | -40°F ~ 176°F (-40°C ~ 80°C) |
| Operating Humidity | 0% ~ 90% relative humidity, non-condensing |
| MTBF (Hours) | 155,000 |

| | |
|---------------|--------|
| Certification | CE/FCC |
|---------------|--------|

Display

| | |
|---------------------------|--|
| VGA/LCD Controller | Intel® Celeron® J1900/ N2807 Processor SoC |
| Video Output | HDMI x 2: HDMI 1(w/Audio), HDMI 2(w/o Audio) |
| Backlight inverter supply | — |

I/O

| | |
|----------------|---|
| Ethernet | Intel® I211AT(or 210), 10/100/1000Base-TX, RJ-45 x 4 |
| Audio | High definition audio interface |
| USB Port | USB2.0 x 2 , USB 3.0 x 1 |
| Serial Port | RS-232 x 1 |
| Parallel Port | — |
| HDD Interface | SATA 2.0 x 1 |
| FDD Interface | — |
| SSD | CFast™ x 1 |
| Expansion Slot | Mini-Card x 1 (for USB only) |
| DIO | 4 Bit |
| SIM | x 1 |
| TPM | x 1 |
| Touch | — |

Chapter 2

Hardware Information

2.1 Dimensions

Component Side

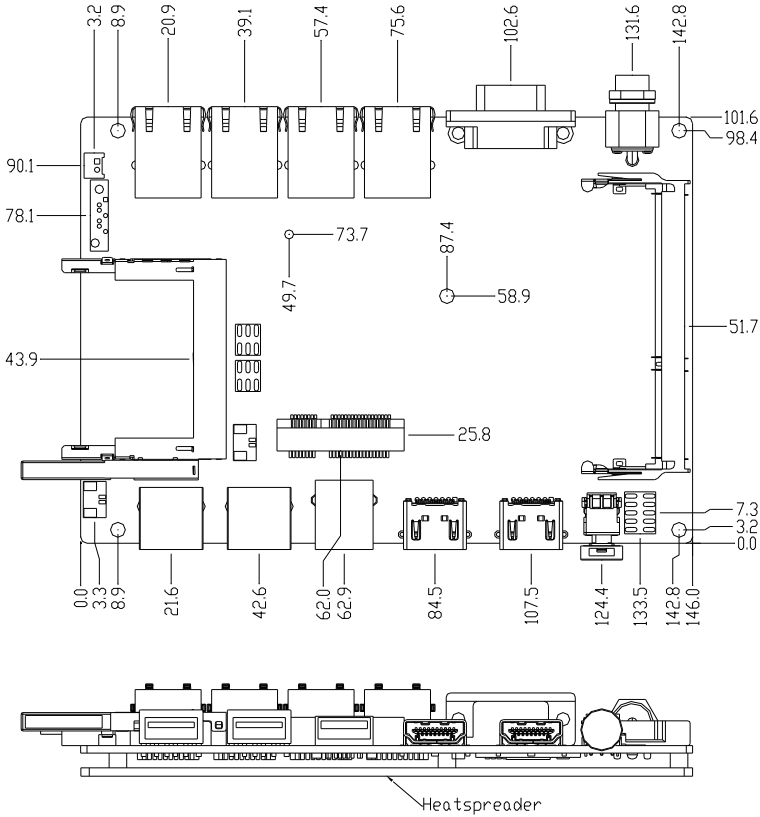

Solder Side

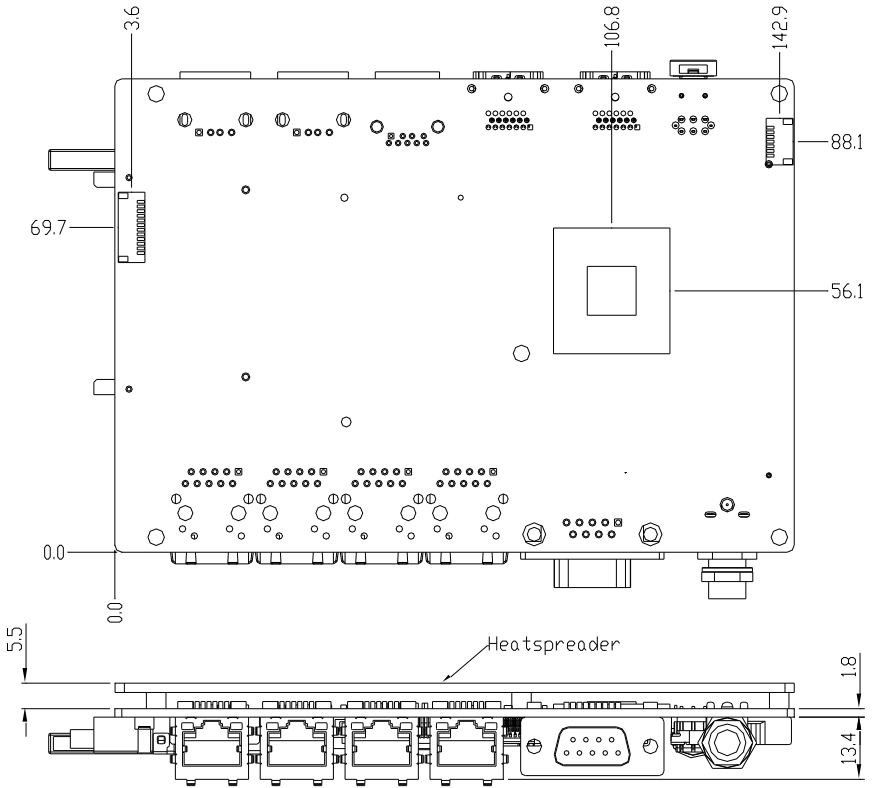

2.2 Jumpers and Connectors

Component Side

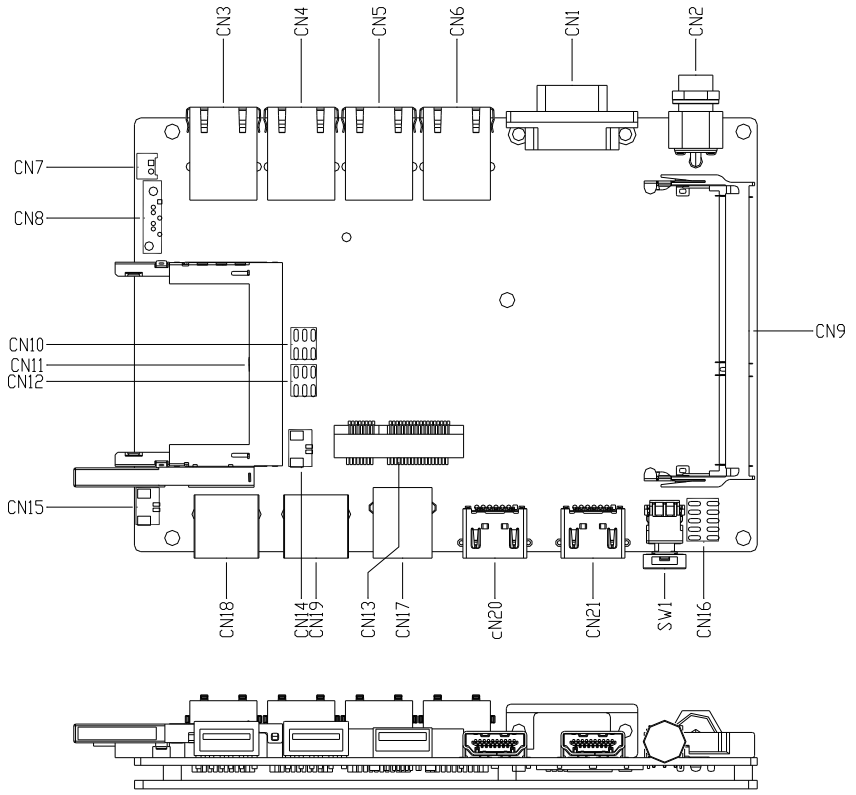

Solder Side

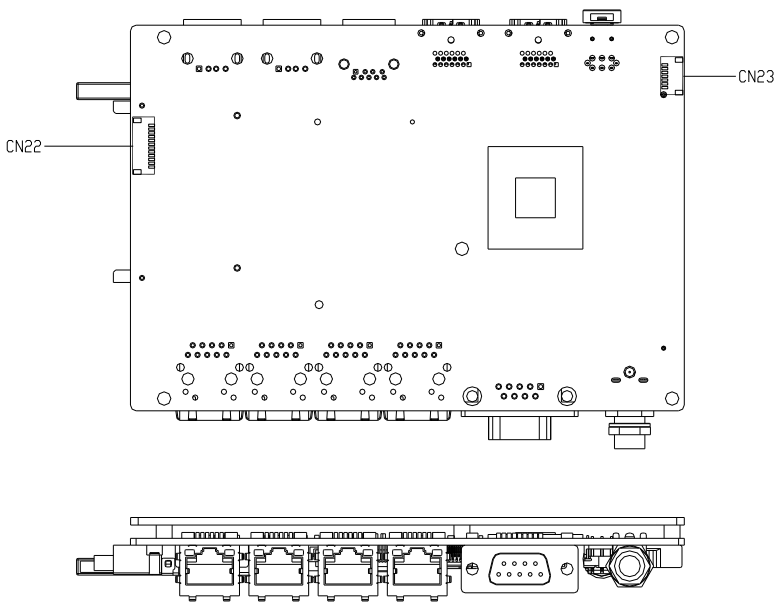

2.3 Block Diagram

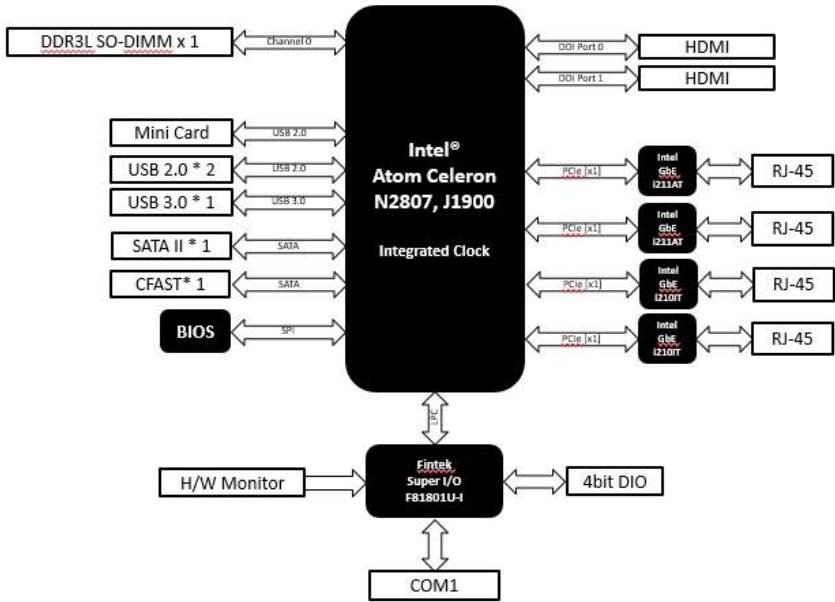

2.4 List of Jumpers

Please refer to the table below for all of the board's jumpers that you can configure for your application

| Label | Function |
|--------------|--|
| CN12 (1,3,5) | Clear CMOS Jumper |
| CN12 (2,4,6) | Auto Power Button Enable/Disable Selection |
| SW1 | Push Power Button With Orange LED |

2.4.1 Clear CMOS Jumper (CN12, Pin 1,3,5)

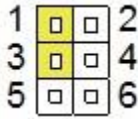

Normal (Default)

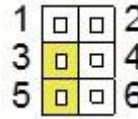

Clear CMOS

2.4.2 Auto Power Button Enable/Disable Selection (JP12, Pin 2,4,6)

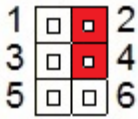

Enable (Default)

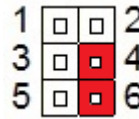

Disable

2.4.3 Push POWER Button with Orange LED (SW4)

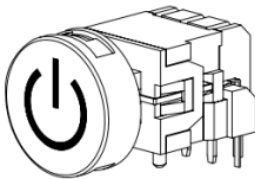

CIRCUIT

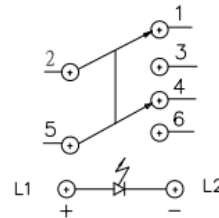

| Pin | Pin Name | Signal Type | Signal level |
|-----|----------|-------------|--------------|
| L1 | +V5S | IN | +5V |

| | | | |
|----|---------|-----|-----|
| L2 | GND | GND | GND |
| 1 | NC | | |
| 2 | PWRBTN# | OUT | |
| 3 | GND | GND | GND |
| 4 | NC | | |
| 5 | NC | | |
| 6 | NC | | |

2.5 List of Connectors

Please refer to the table below for all of the board's connectors that you can configure for your application

| Label | Function |
|-------|-------------------------------------|
| CN1 | COM port RS-232 |
| CN2 | +12V Input |
| CN3 | LAN (RJ-45) Port |
| CN4 | LAN (RJ-45) Port |
| CN5 | LAN (RJ-45) Port |
| CN6 | LAN (RJ-45) Port |
| CN7 | +5V Output for SATA HDD |
| CN8 | SATA Port |
| CN9 | DDR3L SO-DIMM Slot |
| CN10 | Digital IO Port |
| CN11 | C-FAST CARD Connector |
| CN13 | Mini-Card Slot (USB2.0 port 2 ONLY) |
| CN14 | Battery |
| CN15 | Buzzer connector |
| CN16 | Front Panel Connector |
| CN17 | USB3.0 port 0 |
| CN18 | USB2.0 port 3 |
| CN19 | USB2.0 port 1 |
| CN20 | HDMI1 Port |
| CN21 | HDMI2 Port |
| CN22 | LPC Expansion Connector |
| CN23 | SPI Programming Header |

2.5.1 COM Port RS-232 (CN1)

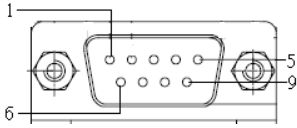

| Pin | Pin Name | Signal Type | Signal level |
|-----|----------|-------------|--------------|
| 1 | DCD | IN | |
| 2 | RX | IN | |
| 3 | TX | OUT | ±9V |
| 4 | DTR | OUT | ±9V |
| 5 | GND | GND | |
| 6 | DSR | IN | |
| 7 | RTS | OUT | ±9V |
| 8 | CTS | IN | |
| 9 | RI | IN | |

2.5.2 +12 V Input (CN2)

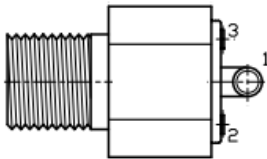

| Pin | Pin Name | Signal Type | Signal Level |
|-----|----------|-------------|--------------|
| 1 | +12V | PWR | +12V |
| 2-3 | GND | GND | |

2.5.3 LAN Port 1/2/3/4 (RJ-45) (CN3,4,5,6)

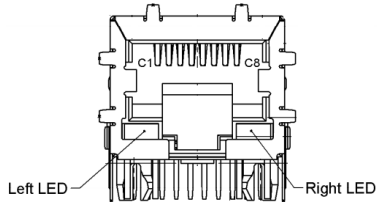

| Pin | Pin Name | Signal Type | Signal Level |
|-----|----------|-------------|--------------|
| C1 | MDI0+ | DIFF | |
| C2 | MDI0- | DIFF | |
| C3 | MDI1+ | DIFF | |
| C4 | MDI2+ | DIFF | |
| C5 | MDI2- | DIFF | |
| C6 | MDI1- | DIFF | |
| C7 | MDI3+ | DIFF | |
| C8 | MDI3- | DIFF | |

2.5.4 +5 V Output for SATA HDD (CN7)

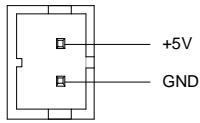

| Pin | Pin Name | Signal Type | Signal Level |
|-----|----------|-------------|--------------|
| 1 | +V5S | PWR | +5V |
| 2 | GND | GND | |

2.5.5 SATA Port (CN8)

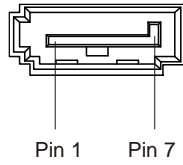

| Pin | Pin Name | Signal Type | Signal Level |
|-----|-----------|-------------|--------------|
| 1 | GND | GND | |
| 2 | SATA_TXP1 | DIFF | |
| 3 | SATA_TXN1 | DIFF | |
| 4 | GND | GND | |
| 5 | SATA_RXN1 | DIFF | |
| 6 | SATA_RXP1 | DIFF | |
| 7 | GND | GND | |

2.5.6 DDR3L SODIMM Slot (CN9)

Standard specification

2.5.7 Digital I/O Port (CN10)

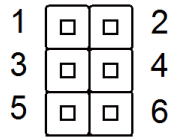

| Pin | Pin Name | Signal Type | Signal Level |
|-----|----------|-------------|--------------|
| 1 | +V5S | PWR | +5V |
| 2 | DIO0 | I/O | +5V |
| 3 | DIO1 | I/O | +5V |

| | | | |
|---|------|-----|-----|
| 4 | DIO2 | I/O | +5V |
| 5 | DIO3 | I/O | +5V |
| 6 | GND | GND | |

2.5.8 CFast Card Connector (CN11)

| Pin | Pin Name | Signal Type | Signal level |
|-----|-----------|-------------|--------------|
| S1 | GND | GND | |
| S2 | SATA_TXP0 | DIFF | |
| S3 | SATA_TXN0 | DIFF | |
| S4 | GND | GND | |
| S5 | SATA_RXN0 | DIFF | |
| S6 | SATA_RXP0 | DIFF | |
| S7 | GND | GND | |
| P1 | NC | | |
| P2 | GND | GND | |
| P3 | NC | | |
| P4 | NC | | |
| P5 | NC | | |
| P6 | NC | | |
| P7 | GND | GND | |
| P8 | CFD_LED# | OUT | +3.3V |
| P9 | NC | | |
| P10 | NC | | |
| P11 | NC | | |

| | | | |
|-----|--------|-----|-------|
| P12 | NC | | |
| P13 | +V3.3S | PWR | +3.3V |
| P14 | +V3.3S | PWR | +3.3V |
| P15 | GND | GND | |
| P16 | GND | GND | |
| P17 | NC | | |

2.5.9 MiniCard Slot (USB Port2 only) (CN13)

| Pin | Pin Name | Signal Type | Signal level |
|-----|-----------------|-------------|--------------|
| 1 | WAKE_PCIE0#_3P3 | IN | |
| 2 | +V3.3A | PWR | +3.3V |
| 3 | NC | | |
| 4 | GND | GND | |
| 5 | NC | | |
| 6 | +V1.5S | PWR | +1.5V |
| 7 | NC | IN | |
| 8 | NC | PWR | |
| 9 | GND | GND | |
| 10 | NC | I/O | |
| 11 | NC | DIFF | |
| 12 | NC | IN | |
| 13 | NC | DIFF | |
| 14 | NC | IN | |
| 15 | GND | GND | |
| 16 | NC | PWR | |

| Pin | Pin Name | Signal Type | Signal level |
|-----|-----------------|-------------|--------------|
| 17 | NC | | |
| 18 | GND | GND | |
| 19 | NC | | |
| 20 | WL_DISABLE0# | OUT | +3.3V |
| 21 | GND | GND | |
| 22 | BUF_PLT_RST# | OUT | +3.3V |
| 23 | NC | DIFF | |
| 24 | +V3.3A | PWR | +3.3V |
| 25 | NC | DIFF | |
| 26 | GND | GND | |
| 27 | GND | GND | |
| 28 | +V1.5S | PWR | +1.5V |
| 29 | GND | GND | |
| 30 | SMB_CLK_3P3_FA | I/O | +3.3V |
| 31 | NC | DIFF | |
| 32 | SMB_DATA_3P3_FA | I/O | +3.3V |
| 33 | NC | DIFF | |
| 34 | GND | GND | |
| 35 | GND | GND | |
| 36 | USB_DN2 | DIFF | |
| 37 | GND | GND | |
| 38 | USB_DP2 | DIFF | |
| 39 | +V3.3A | PWR | +3.3V |
| 40 | GND | GND | |
| 41 | +V3.3A | PWR | +3.3V |

| Pin | Pin Name | Signal Type | Signal level |
|-----|----------|-------------|--------------|
| 42 | NC | | |
| 43 | NC | | |
| 44 | NC | | |
| 45 | NC | | |
| 46 | NC | | |
| 47 | NC | | |
| 48 | +V1.5S | PWR | +1.5V |
| 49 | NC | | |
| 50 | GND | GND | |
| 51 | NC | | |
| 52 | +V3.3A | PWR | +3.3V |

2.5.10 Battery (CN14)

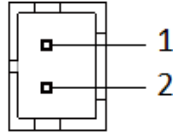

| Pin | Pin Name | Signal Type | Signal Level |
|-----|----------|-------------|--------------|
| 1 | +3.3V | PWR | 3.3V |
| 2 | GND | GND | |

2.5.11 Buzzer Connector (CN15)

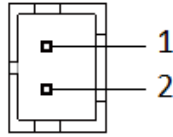

| Pin | Pin Name | Signal Type | Signal Level |
|-----|-----------|-------------|--------------|
| 1 | +V3.3S | PWR | 3.3V |
| 2 | FP_BUZZER | OUT | 3.3V |

2.5.12 Front Panel Connector (CN16)

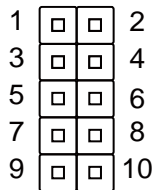

| Pin | Pin Name | Signal Type | Signal Level |
|-----|----------|-------------|--------------|
| 1 | GND | GND | |
| 2 | PWR_BTN# | IN | |
| 3 | IDELED# | OUT | |

| | | | |
|----|--------|-----|-------|
| 4 | +V3.3S | PWR | +3.3V |
| 5 | BUZZER | OUT | |
| 6 | +V5S | PWR | +5V |
| 7 | GND | GND | |
| 8 | +V3.3S | PWR | +3.3V |
| 9 | GND | GND | |
| 10 | HWRST# | IN | |

2.5.13 USB 3.0 Port 0 (CN17)

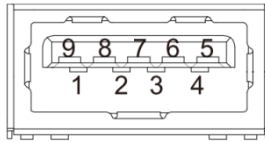

| Pin | Pin Name | Signal Type | Signal Level |
|-----|------------|-------------|--------------|
| 1 | +5VSB | PWR | +5V |
| 2 | USB0_D- | DIFF | |
| 3 | USB0_D+ | DIFF | |
| 4 | GND | GND | |
| 5 | USB0_SSRX- | DIFF | |
| 6 | USB0_SSRX+ | DIFF | |
| 7 | GND | GND | |
| 8 | USB0_SSTX- | DIFF | |
| 9 | USB0_SSTX+ | DIFF | |

2.5.14 USB 2.0 Port 3 and 1 (CN18/ 19)

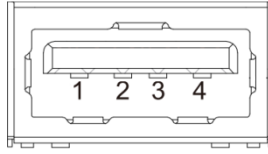

| Pin | Pin Name | Signal Type | Signal Level |
|-----|----------|-------------|--------------|
| 1 | +5VSB | PWR | +5V |
| 2 | USB1_D- | DIFF | |
| 3 | USB1_D+ | DIFF | |
| 4 | GND | GND | |

2.5.15 HDMI Port 1 and 2 (CN20/ 21)

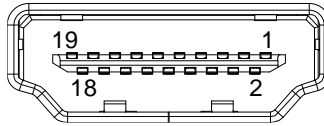

| Pin | Pin Name | Signal Type | Signal Level |
|-----|------------|-------------|--------------|
| 1 | TMDS_DAT2+ | DIFF | |
| 2 | GND | GND | |
| 3 | TMDS_DAT2- | DIFF | |
| 4 | TMDS_DAT1+ | DIFF | |
| 5 | GND | GND | |
| 6 | TMDS_DAT1- | DIFF | |
| 7 | TMDS_DAT0+ | DIFF | |
| 8 | GND | GND | |
| 9 | TMDS_DAT0- | DIFF | |

| | | | |
|----|-------------|------|-----|
| 10 | TMDS_CLK+ | DIFF | |
| 11 | GND | GND | |
| 12 | TMDS_CLK- | DIFF | |
| 13 | NC | | |
| 14 | NC | | |
| 15 | DDC_CLK | I/O | +5V |
| 16 | DDC_DATA | I/O | +5V |
| 17 | GND | GND | |
| 18 | +5V | I/O | +5V |
| 19 | HPLG_DETECT | IN | |

2.5.16LPC Port (CN22)

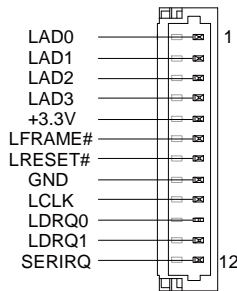

| Pin | Pin Name | Signal Type | Signal Level |
|-----|----------|-------------|--------------|
| 1 | LAD0 | I/O | +3.3V |
| 2 | LAD1 | I/O | +3.3V |
| 3 | LAD2 | I/O | +3.3V |
| 4 | LAD3 | I/O | +3.3V |
| 5 | +V3.3S | PWR | +3.3V |
| 6 | LFRAME# | IN | |
| 7 | LRESET# | OUT | +3.3V |
| 8 | GND | GND | |

| | | | |
|----|--------|-----|-------|
| 9 | LCLK | OUT | |
| 10 | LDRQ0 | IN | |
| 11 | LDRQ1 | IN | |
| 12 | SERIRQ | I/O | +3.3V |

2.5.17 SPI Programming Header (CN23)

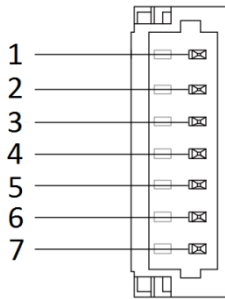

| Pin | Pin Name | Signal Type | Signal Level |
|-----|------------|-------------|--------------|
| 1 | SPI_SO_F | OUT | |
| 2 | GND | GND | |
| 3 | SPI_CLK_F | IN | |
| 4 | +V3.3A_SPI | PWR | +3.3V |
| 5 | SPI_SI_F | IN | |
| 6 | SPI_CS0#_F | IN | |
| 7 | NC | | |

Chapter 3

AMI BIOS Setup

3.1 System Test and Initialization

The board uses certain routines to perform testing and initialization. If an error, fatal or non-fatal, is encountered, a few short beeps or an error message will be outputted. The board can usually continue the boot up sequence with non-fatal errors.

The system configuration verification routines check the current system configuration against the values stored in the CMOS memory. If they do not match, an error message will be outputted, in which case you will need to run the BIOS setup program to set the configuration information in memory.

There are three situations in which you will need to change the CMOS settings:

- You are starting your system for the first time
- You have changed your system's hardware
- The CMOS memory has lost power and the configuration information is erased

The system's CMOS memory uses a backup battery for data retention, which is to be replaced once emptied.

3.2 AMI BIOS Setup

The AMI BIOS ROM has a pre-installed Setup program that allows users to modify basic system configurations, which is stored in the battery-backed CMOS RAM and BIOS NVRAM so that the information is retained when the power is turned off.

To enter BIOS Setup, press or <F2> immediately while your computer is powering up.

The function for each interface can be found below.

Main – Date and time can be set here. Press <Tab> to switch between date elements

Advanced – Enable/ Disable boot option for legacy network devices

Chipset – For hosting bridge parameters

Boot – Enable/ Disable quiet Boot Option

Security – The setup administrator password can be set here

Save & Exit – Save your changes and exit the program

3.3 Setup submenu: Main

Press 'Delete' Key to enter Setup

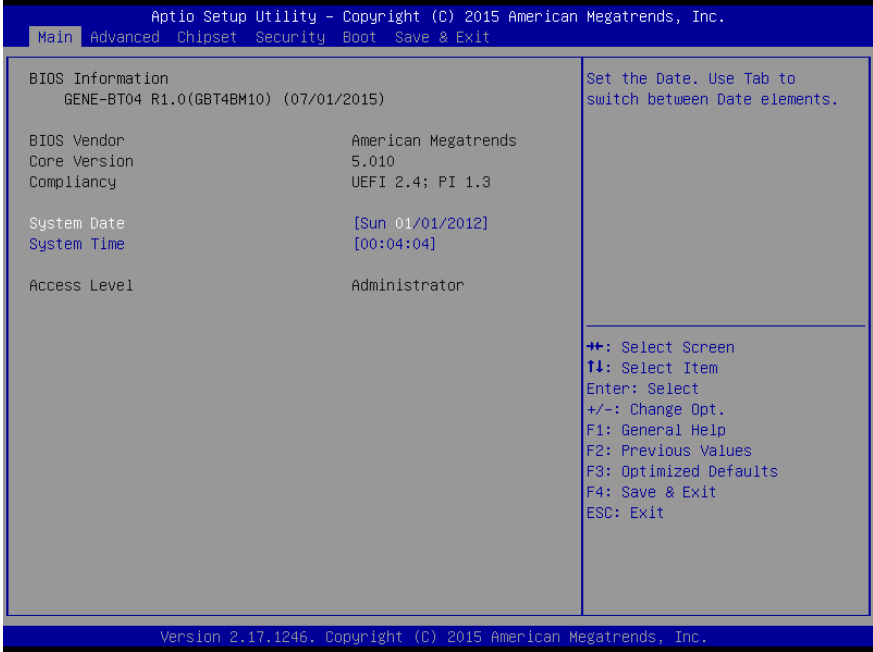

3.4 Setup submenu: Advanced

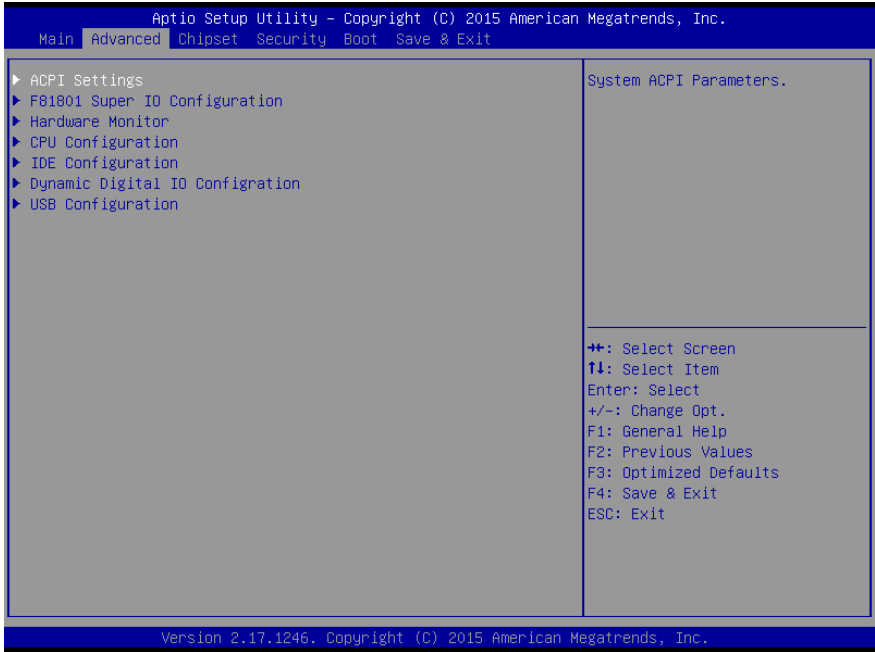

3.4.1 Advanced: ACPI Settings

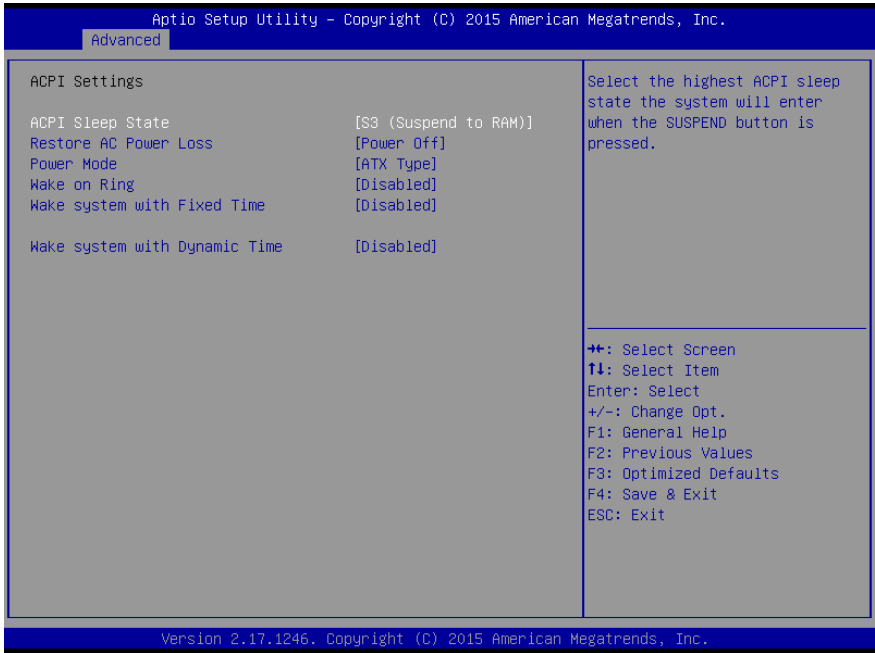

Options summary:

| | | |
|---|---------------------|-----------------------------------|
| ACPI Sleep State | Suspend Disabled | Optimal Default, Failsafe Default |
| | S3 (Suspend to RAM) | |
| Select the highest ACPI sleep state the system will enter when the SUSPEND button is pressed. | | |
| Restore AC Power | Power Off | Optimal Default, Failsafe Default |
| Loss | Power On | |
| | Last State | |
| Select AC power state when power is re-applied after a power failure | | |
| Power Mode | ATX Type | Optimal Default, Failsafe Default |

| | | |
|--|----------|-----------------------------------|
| | AT Type | |
| Select power supply mode | | |
| Wake on Ring | Disabled | Optimal Default, Failsafe Default |
| | Enabled | |
| En/Disabled wake from ring | | |
| Wake system with Fixed Time | Disabled | Optimal Default, Failsafe Default |
| | Enabled | |
| Enable or disable System wake on alarm event. Wake up time is setting by following settings. | | |
| Wake up day | 0-31 | |
| Select 0 for daily system wake up | | |
| Wake up hour | 0-23 | |
| | | |
| Wake up minute | 0-59 | |
| | | |
| Wake up second | 0-59 | |
| | | |
| Wake system with Dynamic Time | Disabled | Optimal Default, Failsafe Default |
| | Enabled | |
| Enable or disable System wake on alarm event. Wake up time is current time + Increase minutes. | | |
| Wake up minute increase | 1-5 | |

3.4.2 Advanced: F81801 Super IO Configuration

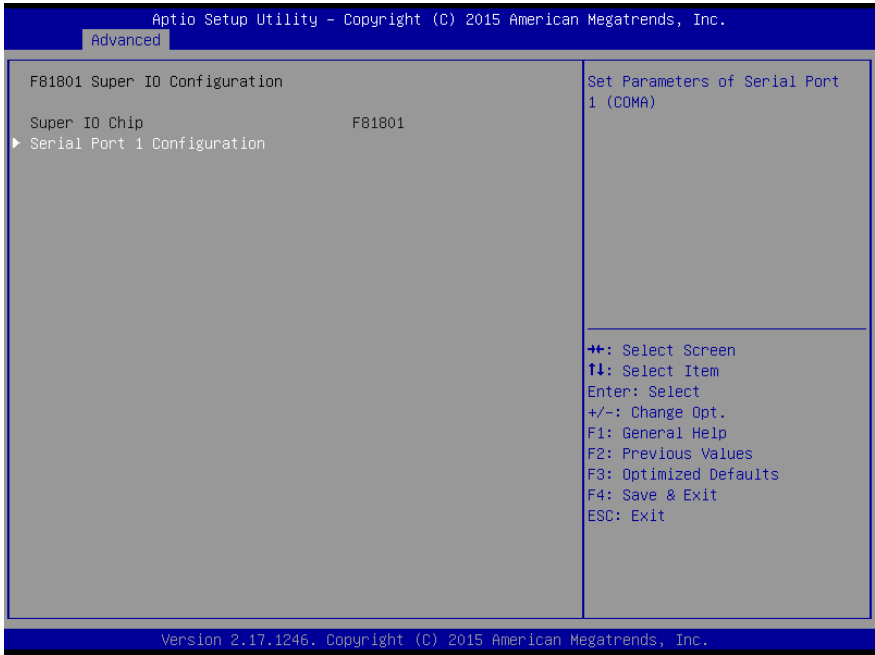

3.4.2.1 F81801 Super IO Configuration: Serial Port 1 Configuration

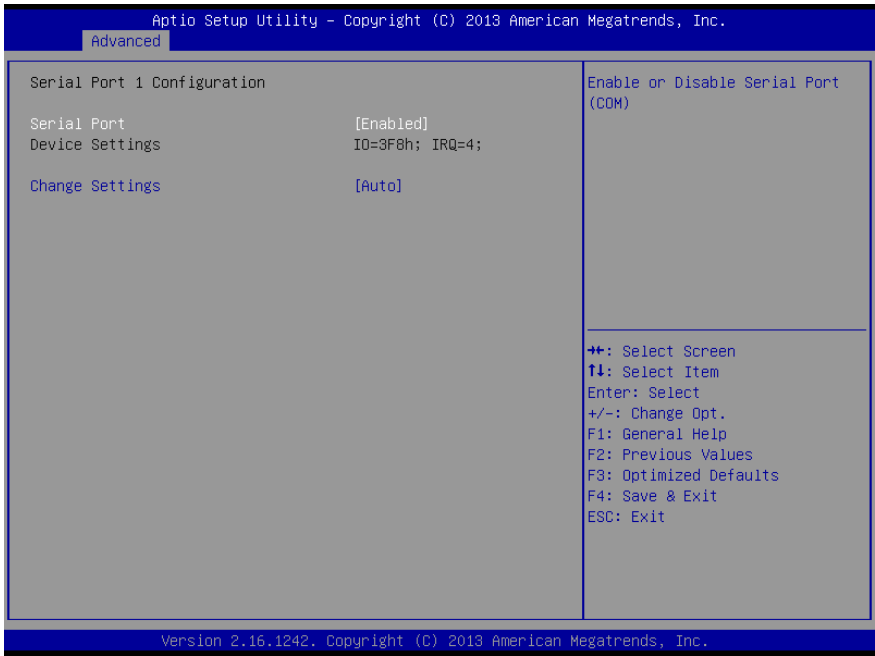

Options summary:

| | | |
|-------------------------------------|--|-----------------------------------|
| Serial Port | Disabled | Optimal Default, Failsafe Default |
| | Enabled | |
| Enable or Disable Serial Port (COM) | | |
| Change Settings | Auto | Optimal Default, Failsafe Default |
| | IO = 3F8h; IRQ = 4 | |
| | IO = 3F8h; IRQ = 3, 4, 5, 6, 7, 9, 10, 11, 12 | |
| | IO = 2F8h; IRQ = 3, 4, 5, 6, 7, 9, 10, 11, 12 | |

| | | |
|--|--|--|
| | IO = 3E8h; IRQ = 3, 4, 5, 6, 7, 9, 10, 11, 12 | |
| | IO = 2E8h; IRQ = 3, 4, 5, 6, 7, 9, 10, 11, 12 | |
| Select an optimal settings for Super IO Device | | |

3.4.3 Advanced: H/W Monitor

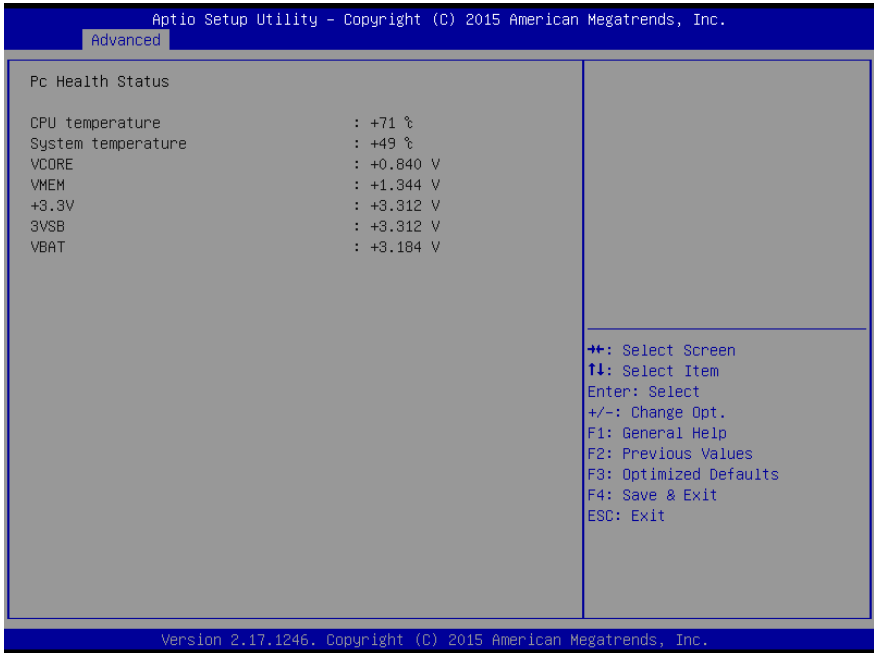

3.4.4 Advanced: CPU Configuration

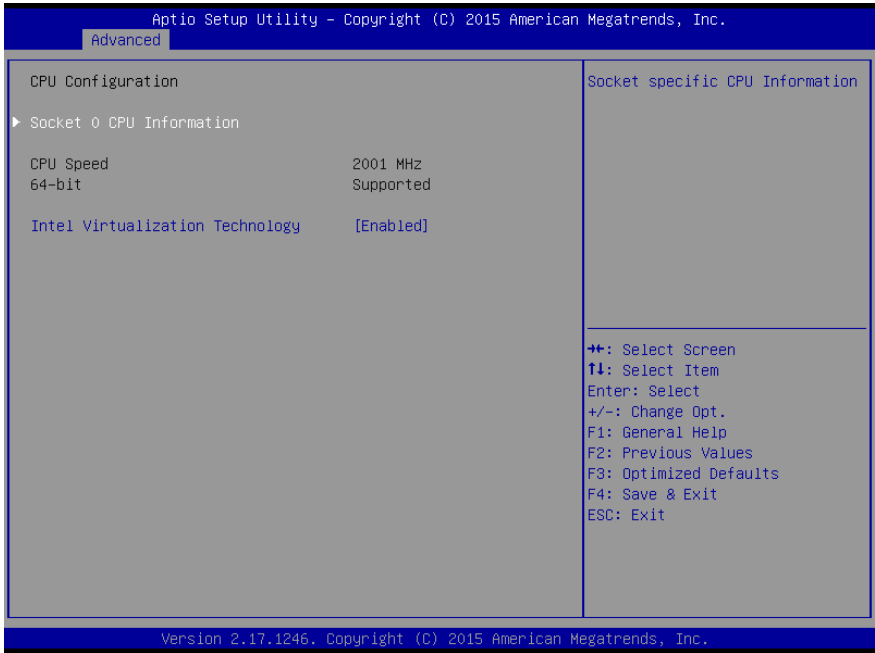

Options summary:

| | | |
|---|----------|-----------------------------------|
| Intel Virtualization | Disabled | Optimal Default, Failsafe Default |
| Technology | Enabled | |
| When enabled, a VMM can utilize the additional hardware capabilities provided by Vander pool Technology | | |

3.4.4.1 CPU Configuration: Socket 0 CPU Configuration

The screenshot shows the Aptio Setup Utility interface. At the top, it reads "Aptio Setup Utility - Copyright (C) 2015 American Megatrends, Inc." Below this is a blue bar with the word "Advanced" in white. The main area is a grey box with a blue border. On the left, under the heading "Socket 0 CPU Information", the following details are listed:

| | |
|---|---------------|
| Intel(R) Celeron(R) CPU J1900 @ 1.99GHz | |
| CPU Signature | 30678 |
| Microcode Patch | 829 |
| Max CPU Speed | 1990 MHz |
| Min CPU Speed | 1334 MHz |
| Processor Cores | 4 |
| Intel HT Technology | Not Supported |
| Intel VT-x Technology | Supported |
| L1 Data Cache | 24 kB x 4 |
| L1 Code Cache | 32 kB x 4 |
| L2 Cache | 1024 kB x 2 |
| L3 Cache | Not Present |

On the right side of the grey box, a legend lists the following navigation options:

- +/: Select Screen
- ↑↓: Select Item
- Enter: Select
- +/-: Change Opt.
- F1: General Help
- F2: Previous Values
- F3: Optimized Defaults
- F4: Save & Exit
- ESC: Exit

At the bottom of the screen, a blue bar contains the text "Version 2.17.1246. Copyright (C) 2015 American Megatrends, Inc."

3.4.5 Advanced: IDE Configuration



Options summary:

| | | |
|--|----------|---------|
| Serial-ATA (SATA) | Enabled | Default |
| | Disabled | |
| En/Disable SATA | | |
| SATA Speed Support | Gen1 | Default |
| | Gen2 | |
| SATA Speed Support Gen1 or Gen2 | | |
| SATA Mode | IDE | Default |
| | AHCI | |
| IDE: Configure SATA controllers as legacy IDE | | |
| AHCI: Configure SATA controllers to operate in AHCI mode | | |

| | | |
|------------------------------|----------|---------|
| Serial-ATA Port 0/1 | Enabled | Default |
| | Disabled | |
| En/Disable SATA Port | | |
| SATA Port 0/1 HotPlug | Enabled | Default |
| | Disabled | |
| En/Disable SATA Port Hotplug | | |

3.4.6 Advanced: Dynamic Digital IO Configuration

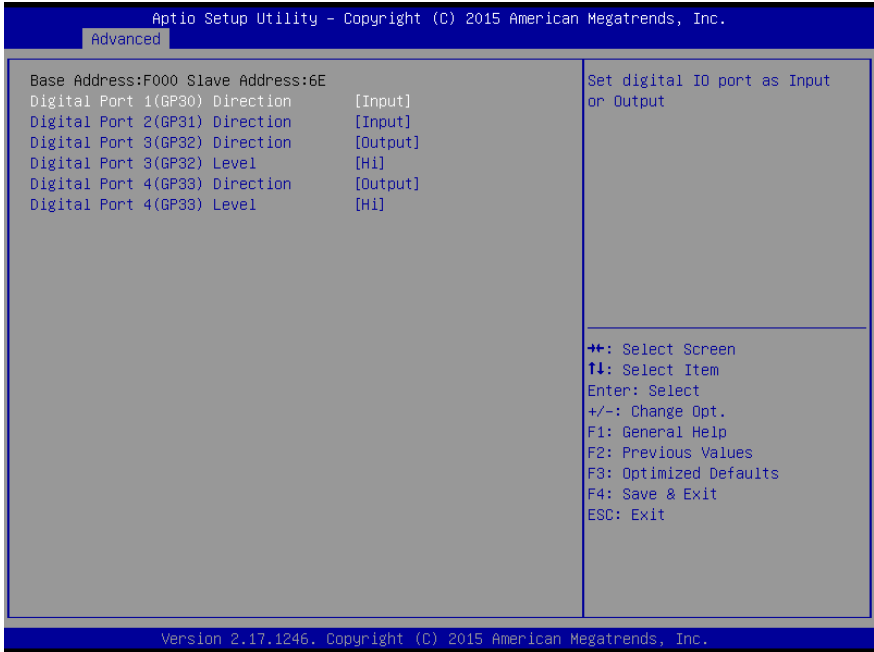

Options summary:

| | | |
|---|--------|---------|
| Digital Port 1 /2 (GP30/ GP31) | Input | Default |
| Direction | Output | |
| Set digital IO port as Input or Output | | |
| Digital Port 3 /4 (GP32/ GP33) Direction | Input | Default |
| | Output | |
| Set digital IO port as Input or Output | | |
| Digital Port 3 /4 (GP32/ GP33) Level | Hi | Default |
| | Low | |
| Set digital IO Output port as High or Low | | |

3.4.7 Advanced: USB Configuration

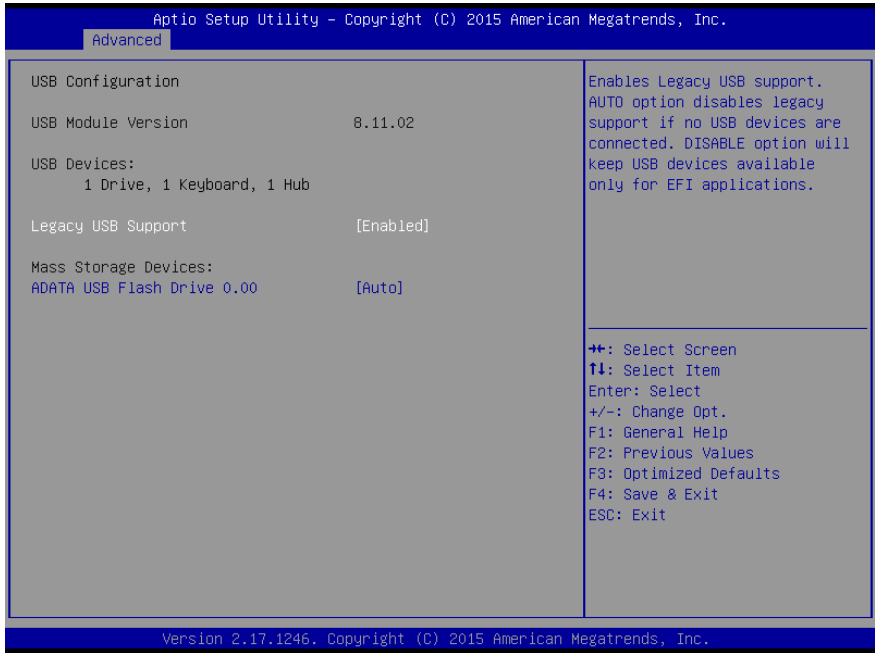

Options summary:

| | | |
|--|------------|-----------------------------------|
| Legacy USB Support | Enabled | Optimal Default, Failsafe Default |
| | Disabled | |
| | Auto | |
| <p>Enables BIOS Support for Legacy USB Support. When enabled, USB can be functional in legacy environment like DOS.</p> <p>AUTO option disables legacy support if no USB devices are connected</p> | | |
| Device Name (Emulation Type) | Auto | Optimal Default, Failsafe Default |
| | Floppy | |
| | Forced FDD | |
| | Hard Disk | |

| | | |
|---|-------|--|
| | CDROM | |
| If Auto. USB devices less than 530MB will be emulated as Floppy and remaining as Floppy and remaining as hard drive. Forced FDD option can be used to force a HDD formatted drive to boot as FDD(Ex. ZIP drive) | | |

3.5 Setup Submenu: Chipset

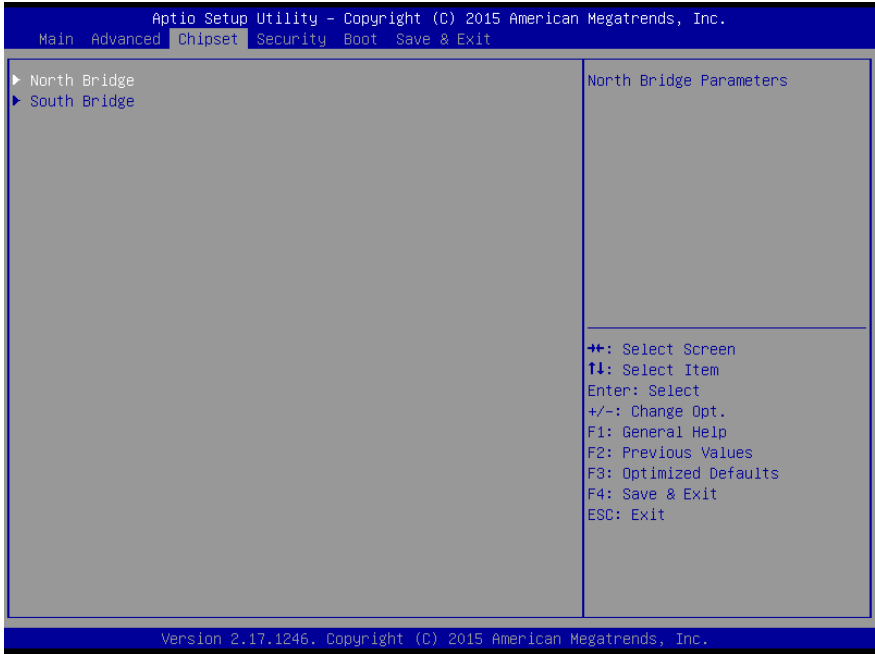

3.5.1 Chipset: Host Bridge

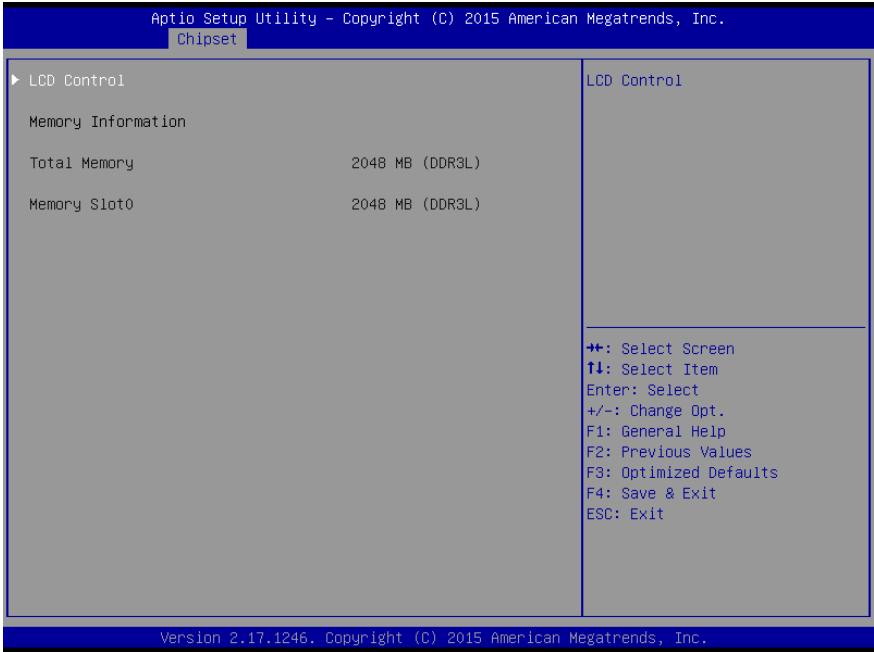

3.5.1.1 Host Bridge: LCD Control

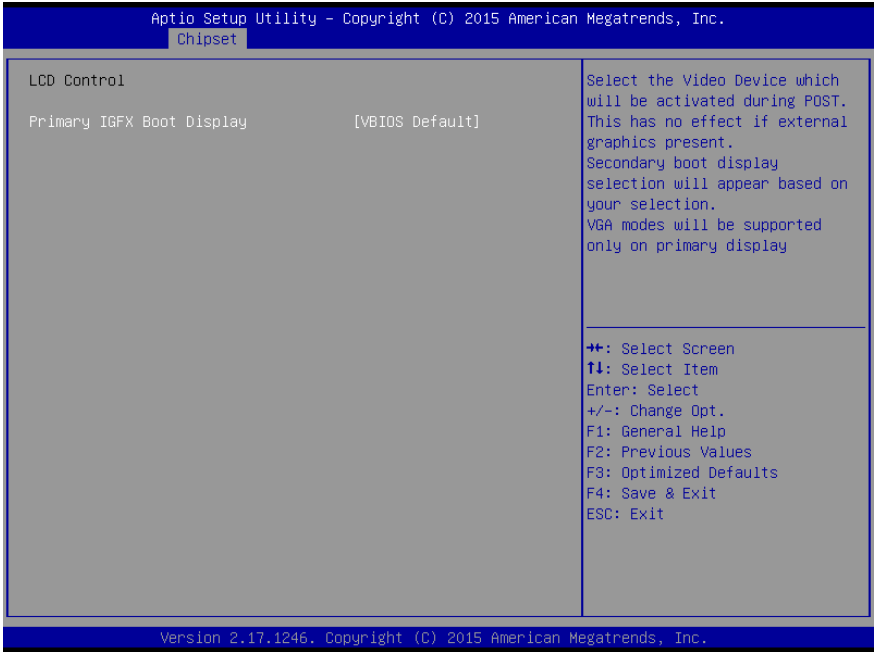

Options summary:

| | | |
|---------------------------|---------------|-----------------------------------|
| Primary IGFX Boot Display | VBIOS Default | Optimal Default, Failsafe Default |
| | HDMI1 | |
| | HDMI2 | |

Select the Video device which will be activated during POST.
 This has no effect if external graphics present.
 Secondary boot display selection will appear based on your selection.
 VGA modes will be supported only on primary display

3.5.2 Chipset: South Bridge

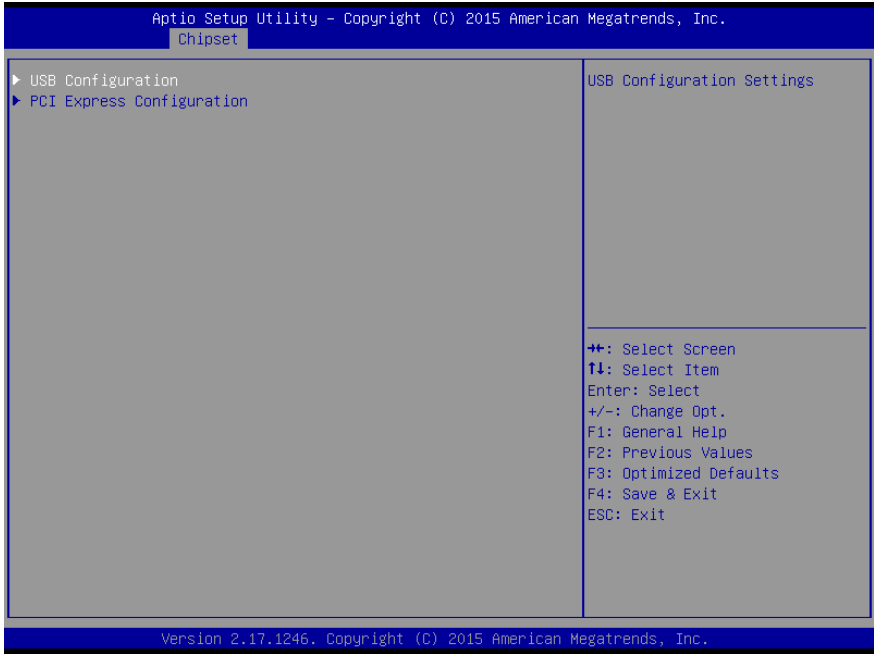

3.5.2.1 South Bridge: USB Configuration

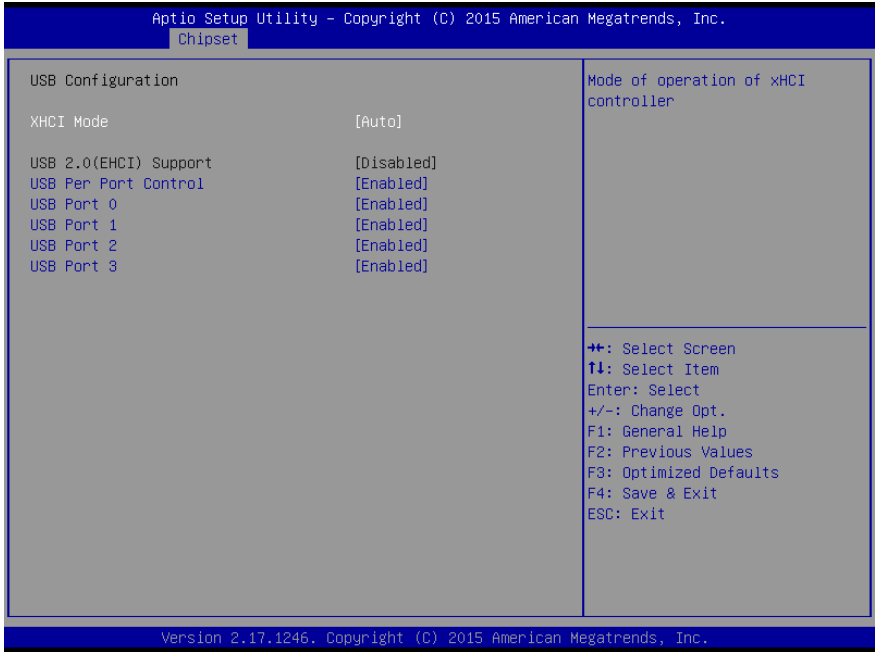

Options summary:

| | | |
|--------------------------------------|------------|-----------------------------------|
| XHCI Mode | Enabled | Optimal Default, Failsafe Default |
| | Disabled | |
| | Auto | |
| | Smart Auto | |
| Mode of operation of XHCI controller | | |
| USB Per Port Control | Enabled | Optimal Default, Failsafe Default |
| | Disabled | |
| Control each of the USB port(0~3) | | |
| Enable: Enable USB per port | | |
| Disable: Use USB port x settings | | |

| | | |
|-----------------------------|----------|-----------------------------------|
| USB Port 0/1/2/3 | Enabled | Optimal Default, Failsafe Default |
| | Disabled | |
| Enable/Disable USB Port 0~3 | | |

3.5.2.2 South Bridge: PCI Express Configuration

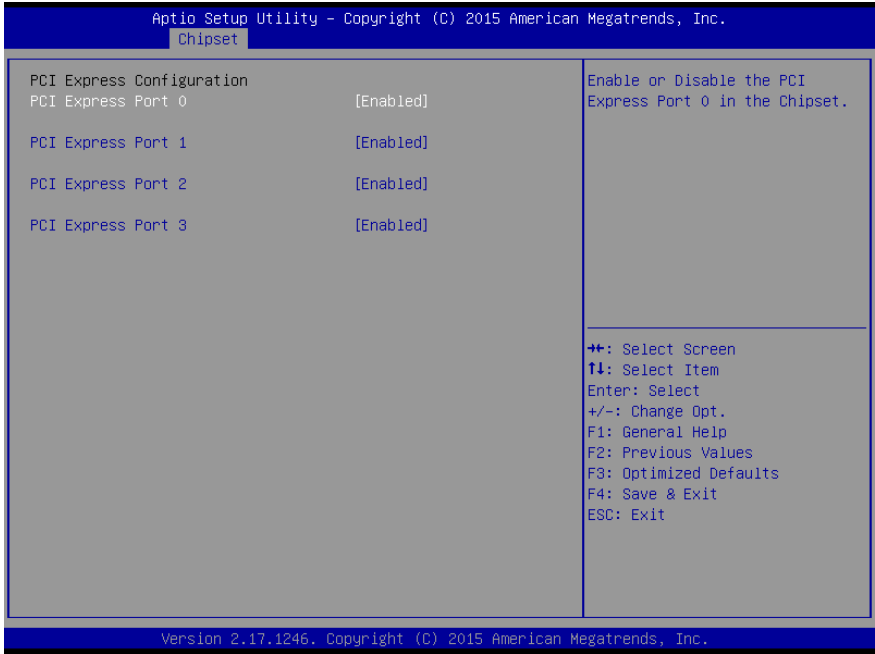

Options summary:

| | | |
|--|----------|-----------------------------------|
| PCI Express Port 0/1/2/3 | Enabled | Optimal Default, Failsafe Default |
| | Disabled | |
| Enable or Disable the PCI Express Port 0~3 in the Chipset. | | |

3.6 Setup submenu: Security

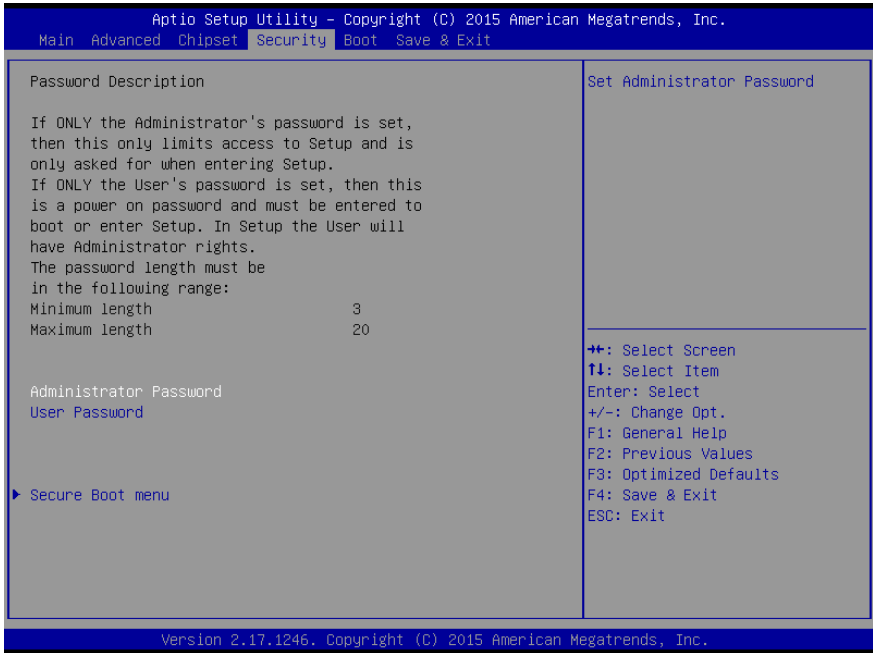

Change User/Administrator Password

You can set a User Password once an Administrator Password is set. The password will be required during boot up, or when the user enters the Setup utility. Please Note that a User Password does not provide access to many of the features in the Setup utility.

Select the password you wish to set, press Enter to open a dialog box to enter your password (you can enter no more than six letters or numbers). Press Enter to confirm your entry, after which you will be prompted to retype your password for a final confirmation. Press Enter again after you have retyped it correctly.

Removing the Password

Highlight this item and type in the current password. At the next dialog box press Enter to disable password protection.

3.6.1 Security: Secure Boot

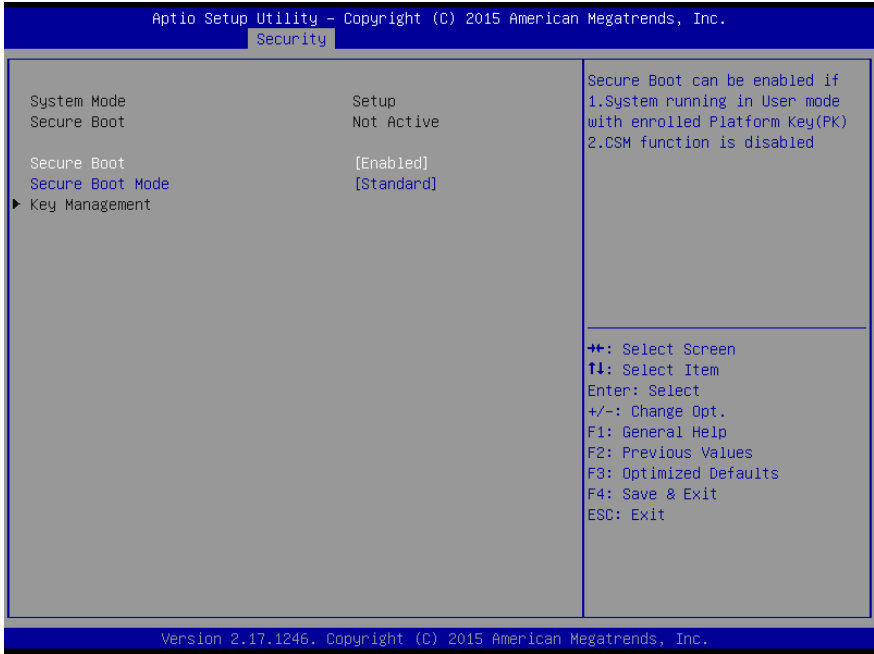

Options summary:

| | | |
|---|----------|-----------------------------------|
| Secure Boot | Disabled | Optimal Default, Failsafe Default |
| | Enabled | |
| Secure Boot can be enabled if | | |
| 1. System running in user mode with enrolled platform key (PK) | | |
| 2. CSM function is disabled | | |
| Secure Boot Mode | Standard | Optimal Default, Failsafe Default |
| | Custom | |
| Secure Boot mode selector. | | |
| 'Custom' Mode enables users to change Image Execution policy and manage Secure boot keys. | | |

3.7 Setup submenu: Boot

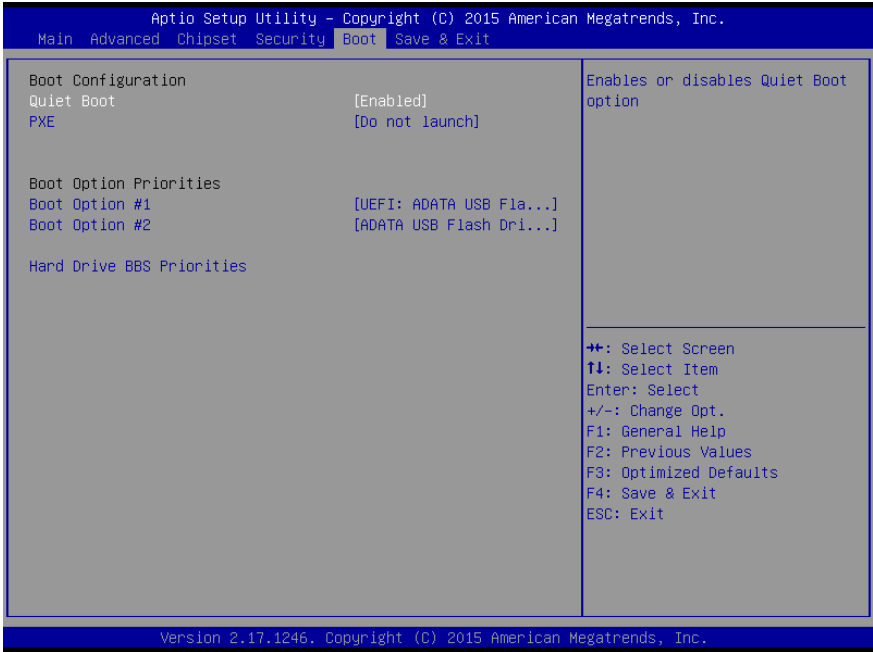

Options summary:

| | | |
|-------------------------------|---------------|---------|
| Quiet Boot | Disabled | Default |
| | Enabled | |
| En/Disable showing boot logo. | | |
| PXE | Do not launch | Default |
| | Enabled | |
| En/Disable PXE boot | | |

3.8 Setup submenu: Save & Exit

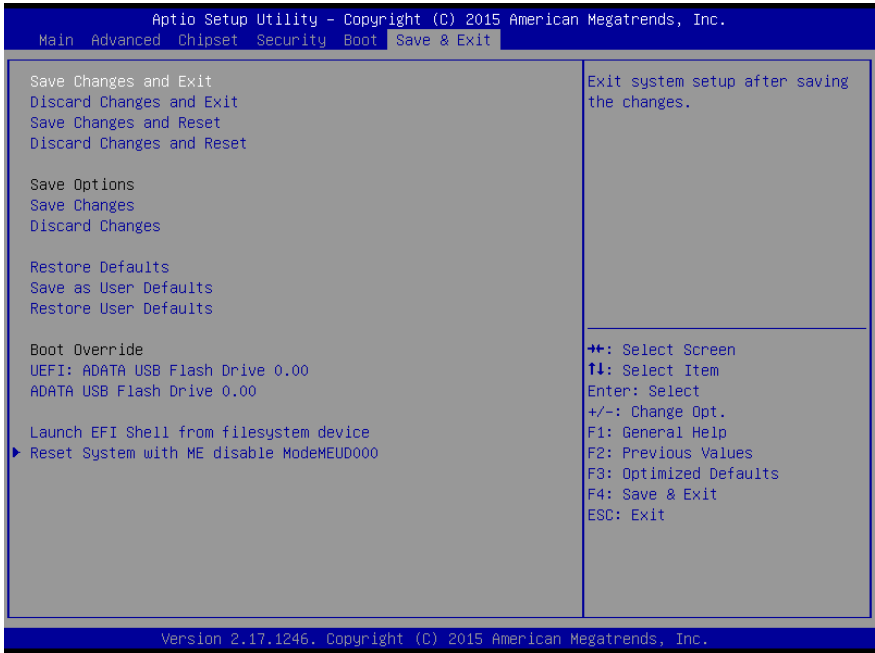

Chapter 4

Drivers Installation

4.1 Driver Download/Installation

Drivers for the GENE-BT04 can be downloaded from the product page on the AAEON website by following this link:

<https://www.aaeon.com/en/p/3-and-a-half-inch-subcompact-boards-gene-bt04>

Download the driver(s) you need and follow the steps below to install them.

Step 1 – Install Chipset Drivers

1. Open the **Step1 - Chipset** folder and select your OS
2. Open the **SetupChipset.exe** file in the folder
3. Follow the instructions
4. Drivers will be installed automatically

Step 2 – Install Graphics Driver

1. Open the **Step2 - VGA** folder and select your OS
2. Open the **Setup.exe** file in the folder
3. Follow the instructions
4. Drivers will be installed automatically

Step 3 – Install LAN Driver

1. Click on the **Step3 - LAN** folder and select your OS
2. Open the **.exe** file in the folder
3. Follow the instructions
4. Drivers will be installed automatically

Step 4 – Install TXE Drivers (Windows 8.1/10 only)

1. Open the **Step4 - TXE** folder and select your OS
2. Open the **SetupTXE.exe** file in the folder
3. Follow the instructions
4. Drivers will be installed automatically

Step 5 – Install USB 3.0 Driver (Windows 7 only)

1. Open the **Step5 - USB3.0** folder followed by **Setup.exe**
2. Follow the instructions
3. Drivers will be installed automatically

Step 6 – Install MBI Driver

1. Open the **Step6 - MBI** folder and select your OS
2. Open the **Setup.exe** file in the folder
3. Follow the instructions
4. Drivers will be installed automatically

Appendix A

Watchdog Timer Programming

A.1 Watchdog Timer Registers

Table 1 : Watch dog relative IO address

| | Default Value | Note |
|------------------|---------------|---|
| I/O Base Address | 0xA00 | I/O Base address for Watchdog operation. This address is assigned by SIO LDN7, register 0x60-0x61. |

Table 2 : Watchdog relative register table

| Register | Offset | BitNum | Value | Note |
|------------------------|--------|--------|-------|---|
| Watchdog WDRST# Enable | 0x00 | 7 | 1 | Enable/Disable time out output via WDRST# 0: Disable 1: Enable |
| Pulse Width | 0x05 | 0:1 | 01 | Width of Pulse signal 00: 1ms (do not use) 01: 25ms 10: 125ms 11: 5s <i>Pulse width is must longer then 16ms.</i> |
| Signal Polarity | 0x05 | 2 | 0 | 0: low active 1: high active <i>Must set this bit to 0</i> |
| Counting Unit | 0x05 | 3 | 0 | Select time unit. 0: second 1: minute |
| Output Signal Type | 0x05 | 4 | 1 | 0: Level 1: Pulse <i>Must set this bit to 1</i> |
| Watchdog Timer Enable | 0x05 | 5 | 1 | 0: Disable 1: Enable |
| Timeout Status | 0x05 | 6 | 1 | 1: timeout occurred. Write a 1 to clear timeout status |
| Timer Counter | 0x06 | | | Time of watchdog timer (0~255) |

A.2 Watchdog Sample Program

```
*****
// WDT I/O operation relative definition (Please reference to Table 1)
#define WDTAddr    0xA00 // WDT I/O base address
Void  WDTWriteByte(byte Register, byte Value);
byte  WDTReadByte(byte Register);
Void  WDTSetReg(byte Register, byte Bit, byte Val);
// Watch Dog relative definition (Please reference to Table 2)
#define DevReg     0x00 // Device configuration register
    #define WDTRstBit 0x80 // Watchdog WDTRST# (Bit7)
    #define WDTRstVal 0x80 // Enabled WDTRST#
#define TimerReg   0x05 // Timer register
    #define PSWidthBit 0x00 // WDTRST# Pulse width (Bit0:1)
    #define PSWidthVal 0x01 // 25ms for WDTRST# pulse
    #define PolarityBit 0x02 // WDTRST# Signal polarity (Bit2)
    #define PolarityVal 0x00 // Low active for WDTRST#
    #define UnitBit    0x03 // Unit for timer (Bit3)
    #define ModeBit    0x04 // WDTRST# mode (Bit4)
    #define ModeVal    0x01 // 0:level 1: pulse
    #define EnableBit  0x05 // WDT timer enable (Bit5)
    #define EnableVal  0x01 // 1: enable
    #define StatusBit  0x06 // WDT timer status (Bit6)
#define CounterReg 0x06 // Timer counter register
*****

VOID  Main(){
    // Procedure : AaeonWDTConfig
    // (byte)Timer : Counter of WDT timer.(0x00~0xFF)
    // (boolean)Unit : Select time unit(0: second, 1: minute).
    AaeonWDTConfig(Counter, Unit);

    // Procedure : AaeonWDTEnable
    // This procedure will enable the WDT counting.
    AaeonWDTEnable();
}
*****

// Procedure : AaeonWDTEnable
```

```

VOID AaeonWDTEnable (){
    WDTEnableDisable(1);
}

// Procedure : AaeonWDTConfig
VOID AaeonWDTConfig (byte Counter, BOOLEAN Unit){
    // Disable WDT counting
    WDTEnableDisable(0);
    // Clear Watchdog Timeout Status
    WDTClearTimeoutStatus();
    // WDT relative parameter setting
    WDTParameterSetting(Timer, Unit);
}

VOID WDTEnableDisable(byte Value){
    If (Value == 1)
        WDTSetBit(TimerReg, EnableBit, 1);
    else
        WDTSetBit(TimerReg, EnableBit, 0);
}

VOID WDTParameterSetting(byte Counter, BOOLEAN Unit){
    // Watchdog Timer counter setting
    WDTWriteByte(CounterReg, Counter);
    // WDT counting unit setting
    WDTSetBit(TimerReg, UnitBit, Unit);
    // WDT output mode set to pulse
    WDTSetBit(TimerReg, ModeBit, ModeVal);
    // WDT output mode set to active low
    WDTSetBit(TimerReg, PolarityBit, PolarityVal);
    // WDT output pulse width is 25ms
    WDTSetBit(TimerReg, PSWidthBit, PSWidthVal);
    // Watchdog WDTRST# Enable
    WDTSetBit(DevReg, WDTRstBit, WDTRstVal);
}

VOID WDTClearTimeoutStatus(){
    WDTSetBit(TimerReg, StatusBit, 1);
}

*****
*****

```

```
VOID  WDTWriteByte(byte Register, byte Value){
    IOWriteByte(WDTAddr+Register, Value);
}

byte  WDTReadByte(byte Register){
    return IOReadByte(WDTAddr+Register);
}

VOID  WDTSetBit(byte Register, byte Bit, byte Val){
    byte TmpValue;

    TmpValue = WDTReadByte(Register);
    TmpValue &= ~(1 << Bit);
    TmpValue |= Val << Bit;
    WDTWriteByte(Register, TmpValue);
}
```









































```
*****
```













Appendix B

I/O Information

B.1 I/O Address Map

Note: There is no PS/2 interface on the GENE-BT04, hence the exclamation marks

- ▼  Input/output (IO)
 -  [00000000 - 0000006F] PCI Express Root Complex
 -  [00000020 - 00000021] Programmable interrupt controller
 -  [00000024 - 00000025] Programmable interrupt controller
 -  [00000028 - 00000029] Programmable interrupt controller
 -  [0000002C - 0000002D] Programmable interrupt controller
 -  [0000002E - 0000002F] Motherboard resources
 -  [00000030 - 00000031] Programmable interrupt controller
 -  [00000034 - 00000035] Programmable interrupt controller
 -  [00000038 - 00000039] Programmable interrupt controller
 -  [0000003C - 0000003D] Programmable interrupt controller
 -  [00000040 - 00000043] System timer
 -  [0000004E - 0000004F] Motherboard resources
 -  [00000050 - 00000053] System timer
 -  [00000060 - 00000060] Standard PS/2 Keyboard
 -  [00000061 - 00000061] Motherboard resources
 -  [00000063 - 00000063] Motherboard resources
 -  [00000064 - 00000064] Standard PS/2 Keyboard
 -  [00000065 - 00000065] Motherboard resources
 -  [00000067 - 00000067] Motherboard resources
 -  [00000070 - 00000070] Motherboard resources
 -  [00000070 - 00000077] System CMOS/real time clock
 -  [00000078 - 0000CF7] PCI Express Root Complex
 -  [00000080 - 0000008F] Motherboard resources
 -  [00000092 - 00000092] Motherboard resources
 -  [000000A0 - 000000A1] Programmable interrupt controller
 -  [000000A4 - 000000A5] Programmable interrupt controller
 -  [000000A8 - 000000A9] Programmable interrupt controller
 -  [000000AC - 000000AD] Programmable interrupt controller
 -  [000000B0 - 000000B1] Programmable interrupt controller
 -  [000000B2 - 000000B3] Motherboard resources
 -  [000000B4 - 000000B5] Programmable interrupt controller
 -  [000000B8 - 000000B9] Programmable interrupt controller
 -  [000000BC - 000000BD] Programmable interrupt controller
 -  [000002C8 - 000002CF] Communications Port (COM10)
 -  [000002D8 - 000002DF] Communications Port (COM9)
 -  [000003B0 - 000003BB] Intel(R) HD Graphics
 -  [000003C0 - 000003DF] Intel(R) HD Graphics
 -  [000003F8 - 000003FF] Communications Port (COM1)
 -  [00000400 - 0000047F] Motherboard resources









































| | | |
|---|-----------------------|---|
|  | [000004D0 - 000004D1] | Programmable interrupt controller |
|  | [00000500 - 000005FE] | Motherboard resources |
|  | [00000600 - 0000061F] | Motherboard resources |
|  | [00000680 - 0000069F] | Motherboard resources |
|  | [00000A00 - 00000A0F] | Motherboard resources |
|  | [00000A10 - 00000A1F] | Motherboard resources |
|  | [00000D00 - 0000FFFF] | PCI Express Root Complex |
|  | [0000B000 - 0000BFFF] | Intel(R) Atom(TM)/Celeron(R)/Pentium(R) Processor PCI Express - Root Port 4 - 0F4E |
|  | [0000C000 - 0000CFFF] | Intel(R) Atom(TM)/Celeron(R)/Pentium(R) Processor PCI Express - Root Port 3 - 0F4C |
|  | [0000D000 - 0000DFFF] | Intel(R) Atom(TM)/Celeron(R)/Pentium(R) Processor PCI Express - Root Port 2 - 0F4A |
|  | [0000E000 - 0000EFFF] | Intel(R) Atom(TM)/Celeron(R)/Pentium(R) Processor PCI Express - Root Port 1 - 0F48 |
|  | [0000F000 - 0000F01F] | Intel(R) Atom(TM)/Celeron(R)/Pentium(R) Processor Platform Control Unit - SMBus Port - 0F12 |
|  | [0000F080 - 0000F087] | Intel(R) HD Graphics |







































B.2 Memory Address Map









































| Address Range | Device Name |
|-------------------------|---|
| [000A0000 - 000BFFFF] | Intel(R) HD Graphics |
| [000A0000 - 000BFFFF] | PCI Express Root Complex |
| [000C0000 - 000DFFFF] | PCI Express Root Complex |
| [000E0000 - 000FFFFFF] | PCI Express Root Complex |
| [C0000000 - CFFFFFFF] | Intel(R) HD Graphics |
| [C0000000 - D0A16FFF] | PCI Express Root Complex |
| [D0000000 - D03FFFFF] | Intel(R) HD Graphics |
| [D0400000 - D04FFFFF] | Intel(R) Trusted Execution Engine Interface |
| [D0500000 - D05FFFFF] | Intel(R) Trusted Execution Engine Interface |
| [D0600000 - D061FFFF] | Intel(R) I211 Gigabit Network Connection |
| [D0600000 - D06FFFFFF] | Intel(R) Atom(TM)/Celeron(R)/Pentium(R) Processor PCI Express - Root Port 4 - 0F4E |
| [D0620000 - D0623FFF] | Intel(R) I211 Gigabit Network Connection |
| [D0700000 - D071FFFF] | Intel(R) I211 Gigabit Network Connection #2 |
| [D0700000 - D07FFFFFF] | Intel(R) Atom(TM)/Celeron(R)/Pentium(R) Processor PCI Express - Root Port 3 - 0F4C |
| [D0710000 - D0713FFF] | High Definition Audio Controller |
| [D0720000 - D0723FFF] | Intel(R) I211 Gigabit Network Connection #2 |
| [D0800000 - D081FFFF] | Intel(R) I211 Gigabit Network Connection #3 |
| [D0800000 - D08FFFFFF] | Intel(R) Atom(TM)/Celeron(R)/Pentium(R) Processor PCI Express - Root Port 2 - 0F4A |
| [D0820000 - D0823FFF] | Intel(R) I211 Gigabit Network Connection #3 |
| [D0900000 - D091FFFF] | Intel(R) I211 Gigabit Network Connection #4 |
| [D0900000 - D09FFFFFF] | Intel(R) Atom(TM)/Celeron(R)/Pentium(R) Processor PCI Express - Root Port 1 - 0F48 |
| [D0920000 - D0923FFF] | Intel(R) I211 Gigabit Network Connection #4 |
| [D0A00000 - D0A0FFFF] | Intel(R) USB 3.0 eXtensible Host Controller - 1.0 (Microsoft) |
| [D0A10000 - D0A13FFF] | High Definition Audio Controller |
| [D0A14000 - D0A1401F] | Intel(R) Atom(TM)/Celeron(R)/Pentium(R) Processor Platform Control Unit - SMBus Port - 0F12 |
| [D0A16000 - D0A167FF] | Standard SATA AHCI Controller |
| [E0000000 - EFFFFFFF] | Motherboard resources |
| [E00000D0 - E00000DB] | Intel(R) Sideband Fabric Device |
| [FED00000 - FED003FF] | High precision event timer |
| [FED01000 - FED01FFF] | Motherboard resources |
| [FED03000 - FED03FFF] | Motherboard resources |
| [FED04000 - FED04FFF] | Motherboard resources |
| [FED08000 - FED08FFF] | Motherboard resources |
| [FED0C000 - FED0FFFF] | Motherboard resources |
| [FED1C000 - FED1CFFF] | Motherboard resources |
| [FEE00000 - FEEFFFFFFF] | Motherboard resources |
| [FEF00000 - FEFFFFFFFF] | Motherboard resources |
| [FF000000 - FFFFFFFF] | Device |











































B.3 IRQ Mapping Chart











































Note: There is no PS/2 interface on the GENE-BT04, hence the exclamation marks











































| | | |
|---|---|--|
| ▼ |  | Interrupt request (IRQ) |
| |  | (ISA) 0x00000000 (00) System timer |
| |  | (ISA) 0x00000001 (01) Standard PS/2 Keyboard |
| |  | (ISA) 0x00000003 (03) High Definition Audio Controller |
| |  | (ISA) 0x00000004 (04) Communications Port (COM1) |
| |  | (ISA) 0x00000008 (08) High precision event timer |
| |  | (ISA) 0x0000000A (10) Communications Port (COM10) |
| |  | (ISA) 0x0000000B (11) Communications Port (COM9) |
| |  | (ISA) 0x0000000C (12) PS/2 Compatible Mouse |
| |  | (ISA) 0x00000036 (54) Microsoft ACPI-Compliant System |
| |  | (ISA) 0x00000037 (55) Microsoft ACPI-Compliant System |
| |  | (ISA) 0x00000038 (56) Microsoft ACPI-Compliant System |
| |  | (ISA) 0x00000039 (57) Microsoft ACPI-Compliant System |
| |  | (ISA) 0x0000003A (58) Microsoft ACPI-Compliant System |
| |  | (ISA) 0x0000003B (59) Microsoft ACPI-Compliant System |
| |  | (ISA) 0x0000003C (60) Microsoft ACPI-Compliant System |
| |  | (ISA) 0x0000003D (61) Microsoft ACPI-Compliant System |
| |  | (ISA) 0x0000003E (62) Microsoft ACPI-Compliant System |
| |  | (ISA) 0x0000003F (63) Microsoft ACPI-Compliant System |
| |  | (ISA) 0x00000040 (64) Microsoft ACPI-Compliant System |
| |  | (ISA) 0x00000041 (65) Microsoft ACPI-Compliant System |
| |  | (ISA) 0x00000042 (66) Microsoft ACPI-Compliant System |
| |  | (ISA) 0x00000043 (67) Microsoft ACPI-Compliant System |
| |  | (ISA) 0x00000044 (68) Microsoft ACPI-Compliant System |
| |  | (ISA) 0x00000045 (69) Microsoft ACPI-Compliant System |
| |  | (ISA) 0x00000046 (70) Microsoft ACPI-Compliant System |
| |  | (ISA) 0x00000047 (71) Microsoft ACPI-Compliant System |
| |  | (ISA) 0x00000048 (72) Microsoft ACPI-Compliant System |
| |  | (ISA) 0x00000049 (73) Microsoft ACPI-Compliant System |
| |  | (ISA) 0x0000004A (74) Microsoft ACPI-Compliant System |
| |  | (ISA) 0x0000004B (75) Microsoft ACPI-Compliant System |
| |  | (ISA) 0x0000004C (76) Microsoft ACPI-Compliant System |
| |  | (ISA) 0x0000004D (77) Microsoft ACPI-Compliant System |
| |  | (ISA) 0x0000004E (78) Microsoft ACPI-Compliant System |
| |  | (ISA) 0x0000004F (79) Microsoft ACPI-Compliant System |
| |  | (ISA) 0x00000050 (80) Microsoft ACPI-Compliant System |
| |  | (ISA) 0x00000051 (81) Microsoft ACPI-Compliant System |
| |  | (ISA) 0x00000052 (82) Microsoft ACPI-Compliant System |
| |  | (ISA) 0x00000053 (83) Microsoft ACPI-Compliant System |
| |  | (ISA) 0x00000054 (84) Microsoft ACPI-Compliant System |
| |  | (ISA) 0x00000055 (85) Microsoft ACPI-Compliant System |











































| | |
|--|---------------------------------|
|  (ISA) 0x00000056 (86) | Microsoft ACPI-Compliant System |
|  (ISA) 0x00000057 (87) | Microsoft ACPI-Compliant System |
|  (ISA) 0x00000058 (88) | Microsoft ACPI-Compliant System |
|  (ISA) 0x00000059 (89) | Microsoft ACPI-Compliant System |
|  (ISA) 0x0000005A (90) | Microsoft ACPI-Compliant System |
|  (ISA) 0x0000005B (91) | Microsoft ACPI-Compliant System |
|  (ISA) 0x0000005C (92) | Microsoft ACPI-Compliant System |
|  (ISA) 0x0000005D (93) | Microsoft ACPI-Compliant System |
|  (ISA) 0x0000005E (94) | Microsoft ACPI-Compliant System |
|  (ISA) 0x0000005F (95) | Microsoft ACPI-Compliant System |
|  (ISA) 0x00000060 (96) | Microsoft ACPI-Compliant System |
|  (ISA) 0x00000061 (97) | Microsoft ACPI-Compliant System |
|  (ISA) 0x00000062 (98) | Microsoft ACPI-Compliant System |
|  (ISA) 0x00000063 (99) | Microsoft ACPI-Compliant System |
|  (ISA) 0x00000064 (100) | Microsoft ACPI-Compliant System |
|  (ISA) 0x00000065 (101) | Microsoft ACPI-Compliant System |
|  (ISA) 0x00000066 (102) | Microsoft ACPI-Compliant System |
|  (ISA) 0x00000067 (103) | Microsoft ACPI-Compliant System |
|  (ISA) 0x00000068 (104) | Microsoft ACPI-Compliant System |
|  (ISA) 0x00000069 (105) | Microsoft ACPI-Compliant System |
|  (ISA) 0x0000006A (106) | Microsoft ACPI-Compliant System |
|  (ISA) 0x0000006B (107) | Microsoft ACPI-Compliant System |
|  (ISA) 0x0000006C (108) | Microsoft ACPI-Compliant System |
|  (ISA) 0x0000006D (109) | Microsoft ACPI-Compliant System |
|  (ISA) 0x0000006E (110) | Microsoft ACPI-Compliant System |
|  (ISA) 0x0000006F (111) | Microsoft ACPI-Compliant System |
|  (ISA) 0x00000070 (112) | Microsoft ACPI-Compliant System |
|  (ISA) 0x00000071 (113) | Microsoft ACPI-Compliant System |
|  (ISA) 0x00000072 (114) | Microsoft ACPI-Compliant System |
|  (ISA) 0x00000073 (115) | Microsoft ACPI-Compliant System |
|  (ISA) 0x00000074 (116) | Microsoft ACPI-Compliant System |
|  (ISA) 0x00000075 (117) | Microsoft ACPI-Compliant System |
|  (ISA) 0x00000076 (118) | Microsoft ACPI-Compliant System |
|  (ISA) 0x00000077 (119) | Microsoft ACPI-Compliant System |
|  (ISA) 0x00000078 (120) | Microsoft ACPI-Compliant System |
|  (ISA) 0x00000079 (121) | Microsoft ACPI-Compliant System |
|  (ISA) 0x0000007A (122) | Microsoft ACPI-Compliant System |
|  (ISA) 0x0000007B (123) | Microsoft ACPI-Compliant System |
|  (ISA) 0x0000007C (124) | Microsoft ACPI-Compliant System |











































| | |
|--|---------------------------------|
|  (ISA) 0x0000007D (125) | Microsoft ACPI-Compliant System |
|  (ISA) 0x0000007E (126) | Microsoft ACPI-Compliant System |
|  (ISA) 0x0000007F (127) | Microsoft ACPI-Compliant System |
|  (ISA) 0x00000080 (128) | Microsoft ACPI-Compliant System |
|  (ISA) 0x00000081 (129) | Microsoft ACPI-Compliant System |
|  (ISA) 0x00000082 (130) | Microsoft ACPI-Compliant System |
|  (ISA) 0x00000083 (131) | Microsoft ACPI-Compliant System |
|  (ISA) 0x00000084 (132) | Microsoft ACPI-Compliant System |
|  (ISA) 0x00000085 (133) | Microsoft ACPI-Compliant System |
|  (ISA) 0x00000086 (134) | Microsoft ACPI-Compliant System |
|  (ISA) 0x00000087 (135) | Microsoft ACPI-Compliant System |
|  (ISA) 0x00000088 (136) | Microsoft ACPI-Compliant System |
|  (ISA) 0x00000089 (137) | Microsoft ACPI-Compliant System |
|  (ISA) 0x0000008A (138) | Microsoft ACPI-Compliant System |
|  (ISA) 0x0000008B (139) | Microsoft ACPI-Compliant System |
|  (ISA) 0x0000008C (140) | Microsoft ACPI-Compliant System |
|  (ISA) 0x0000008D (141) | Microsoft ACPI-Compliant System |
|  (ISA) 0x0000008E (142) | Microsoft ACPI-Compliant System |
|  (ISA) 0x0000008F (143) | Microsoft ACPI-Compliant System |
|  (ISA) 0x00000090 (144) | Microsoft ACPI-Compliant System |
|  (ISA) 0x00000091 (145) | Microsoft ACPI-Compliant System |
|  (ISA) 0x00000092 (146) | Microsoft ACPI-Compliant System |
|  (ISA) 0x00000093 (147) | Microsoft ACPI-Compliant System |
|  (ISA) 0x00000094 (148) | Microsoft ACPI-Compliant System |
|  (ISA) 0x00000095 (149) | Microsoft ACPI-Compliant System |
|  (ISA) 0x00000096 (150) | Microsoft ACPI-Compliant System |
|  (ISA) 0x00000097 (151) | Microsoft ACPI-Compliant System |
|  (ISA) 0x00000098 (152) | Microsoft ACPI-Compliant System |
|  (ISA) 0x00000099 (153) | Microsoft ACPI-Compliant System |
|  (ISA) 0x0000009A (154) | Microsoft ACPI-Compliant System |
|  (ISA) 0x0000009B (155) | Microsoft ACPI-Compliant System |
|  (ISA) 0x0000009C (156) | Microsoft ACPI-Compliant System |
|  (ISA) 0x0000009D (157) | Microsoft ACPI-Compliant System |
|  (ISA) 0x0000009E (158) | Microsoft ACPI-Compliant System |
|  (ISA) 0x0000009F (159) | Microsoft ACPI-Compliant System |
|  (ISA) 0x000000A0 (160) | Microsoft ACPI-Compliant System |
|  (ISA) 0x000000A1 (161) | Microsoft ACPI-Compliant System |
|  (ISA) 0x000000A2 (162) | Microsoft ACPI-Compliant System |
|  (ISA) 0x000000A3 (163) | Microsoft ACPI-Compliant System |
|  (ISA) 0x000000A4 (164) | Microsoft ACPI-Compliant System |











































| | |
|--|---------------------------------|
|  (ISA) 0x000000A5 (165) | Microsoft ACPI-Compliant System |
|  (ISA) 0x000000A6 (166) | Microsoft ACPI-Compliant System |
|  (ISA) 0x000000A7 (167) | Microsoft ACPI-Compliant System |
|  (ISA) 0x000000A8 (168) | Microsoft ACPI-Compliant System |
|  (ISA) 0x000000A9 (169) | Microsoft ACPI-Compliant System |
|  (ISA) 0x000000AA (170) | Microsoft ACPI-Compliant System |
|  (ISA) 0x000000AB (171) | Microsoft ACPI-Compliant System |
|  (ISA) 0x000000AC (172) | Microsoft ACPI-Compliant System |
|  (ISA) 0x000000AD (173) | Microsoft ACPI-Compliant System |
|  (ISA) 0x000000AE (174) | Microsoft ACPI-Compliant System |
|  (ISA) 0x000000AF (175) | Microsoft ACPI-Compliant System |
|  (ISA) 0x000000B0 (176) | Microsoft ACPI-Compliant System |
|  (ISA) 0x000000B1 (177) | Microsoft ACPI-Compliant System |
|  (ISA) 0x000000B2 (178) | Microsoft ACPI-Compliant System |
|  (ISA) 0x000000B3 (179) | Microsoft ACPI-Compliant System |
|  (ISA) 0x000000B4 (180) | Microsoft ACPI-Compliant System |
|  (ISA) 0x000000B5 (181) | Microsoft ACPI-Compliant System |
|  (ISA) 0x000000B6 (182) | Microsoft ACPI-Compliant System |
|  (ISA) 0x000000B7 (183) | Microsoft ACPI-Compliant System |
|  (ISA) 0x000000B8 (184) | Microsoft ACPI-Compliant System |
|  (ISA) 0x000000B9 (185) | Microsoft ACPI-Compliant System |
|  (ISA) 0x000000BA (186) | Microsoft ACPI-Compliant System |
|  (ISA) 0x000000BB (187) | Microsoft ACPI-Compliant System |
|  (ISA) 0x000000BC (188) | Microsoft ACPI-Compliant System |
|  (ISA) 0x000000BD (189) | Microsoft ACPI-Compliant System |
|  (ISA) 0x000000BE (190) | Microsoft ACPI-Compliant System |
|  (ISA) 0x000000BF (191) | Microsoft ACPI-Compliant System |
|  (ISA) 0x000000C0 (192) | Microsoft ACPI-Compliant System |
|  (ISA) 0x000000C1 (193) | Microsoft ACPI-Compliant System |
|  (ISA) 0x000000C2 (194) | Microsoft ACPI-Compliant System |
|  (ISA) 0x000000C3 (195) | Microsoft ACPI-Compliant System |
|  (ISA) 0x000000C4 (196) | Microsoft ACPI-Compliant System |
|  (ISA) 0x000000C5 (197) | Microsoft ACPI-Compliant System |
|  (ISA) 0x000000C6 (198) | Microsoft ACPI-Compliant System |
|  (ISA) 0x000000C7 (199) | Microsoft ACPI-Compliant System |
|  (ISA) 0x000000C8 (200) | Microsoft ACPI-Compliant System |
|  (ISA) 0x000000C9 (201) | Microsoft ACPI-Compliant System |
|  (ISA) 0x000000CA (202) | Microsoft ACPI-Compliant System |
|  (ISA) 0x000000CB (203) | Microsoft ACPI-Compliant System |
|  (ISA) 0x000000CC (204) | Microsoft ACPI-Compliant System |
|  (ISA) 0x00000100 (256) | Microsoft ACPI-Compliant System |
|  (ISA) 0x00000101 (257) | Microsoft ACPI-Compliant System |











































| | |
|--|---------------------------------|
|  (ISA) 0x000000A5 (165) | Microsoft ACPI-Compliant System |
|  (ISA) 0x000000A6 (166) | Microsoft ACPI-Compliant System |
|  (ISA) 0x000000A7 (167) | Microsoft ACPI-Compliant System |
|  (ISA) 0x000000A8 (168) | Microsoft ACPI-Compliant System |
|  (ISA) 0x000000A9 (169) | Microsoft ACPI-Compliant System |
|  (ISA) 0x000000AA (170) | Microsoft ACPI-Compliant System |
|  (ISA) 0x000000AB (171) | Microsoft ACPI-Compliant System |
|  (ISA) 0x000000AC (172) | Microsoft ACPI-Compliant System |
|  (ISA) 0x000000AD (173) | Microsoft ACPI-Compliant System |
|  (ISA) 0x000000AE (174) | Microsoft ACPI-Compliant System |
|  (ISA) 0x000000AF (175) | Microsoft ACPI-Compliant System |
|  (ISA) 0x000000B0 (176) | Microsoft ACPI-Compliant System |
|  (ISA) 0x000000B1 (177) | Microsoft ACPI-Compliant System |
|  (ISA) 0x000000B2 (178) | Microsoft ACPI-Compliant System |
|  (ISA) 0x000000B3 (179) | Microsoft ACPI-Compliant System |
|  (ISA) 0x000000B4 (180) | Microsoft ACPI-Compliant System |
|  (ISA) 0x000000B5 (181) | Microsoft ACPI-Compliant System |
|  (ISA) 0x000000B6 (182) | Microsoft ACPI-Compliant System |
|  (ISA) 0x000000B7 (183) | Microsoft ACPI-Compliant System |
|  (ISA) 0x000000B8 (184) | Microsoft ACPI-Compliant System |
|  (ISA) 0x000000B9 (185) | Microsoft ACPI-Compliant System |
|  (ISA) 0x000000BA (186) | Microsoft ACPI-Compliant System |
|  (ISA) 0x000000BB (187) | Microsoft ACPI-Compliant System |
|  (ISA) 0x000000BC (188) | Microsoft ACPI-Compliant System |
|  (ISA) 0x000000BD (189) | Microsoft ACPI-Compliant System |
|  (ISA) 0x000000BE (190) | Microsoft ACPI-Compliant System |
|  (ISA) 0x000000BF (191) | Microsoft ACPI-Compliant System |
|  (ISA) 0x000000C0 (192) | Microsoft ACPI-Compliant System |
|  (ISA) 0x000000C1 (193) | Microsoft ACPI-Compliant System |
|  (ISA) 0x000000C2 (194) | Microsoft ACPI-Compliant System |
|  (ISA) 0x000000C3 (195) | Microsoft ACPI-Compliant System |
|  (ISA) 0x000000C4 (196) | Microsoft ACPI-Compliant System |
|  (ISA) 0x000000C5 (197) | Microsoft ACPI-Compliant System |
|  (ISA) 0x000000C6 (198) | Microsoft ACPI-Compliant System |
|  (ISA) 0x000000C7 (199) | Microsoft ACPI-Compliant System |
|  (ISA) 0x000000C8 (200) | Microsoft ACPI-Compliant System |
|  (ISA) 0x000000C9 (201) | Microsoft ACPI-Compliant System |
|  (ISA) 0x000000CA (202) | Microsoft ACPI-Compliant System |
|  (ISA) 0x000000CB (203) | Microsoft ACPI-Compliant System |
|  (ISA) 0x000000CC (204) | Microsoft ACPI-Compliant System |
|  (ISA) 0x00000100 (256) | Microsoft ACPI-Compliant System |
|  (ISA) 0x00000101 (257) | Microsoft ACPI-Compliant System |











































| | |
|--|---------------------------------|
|  (ISA) 0x00000102 (258) | Microsoft ACPI-Compliant System |
|  (ISA) 0x00000103 (259) | Microsoft ACPI-Compliant System |
|  (ISA) 0x00000104 (260) | Microsoft ACPI-Compliant System |
|  (ISA) 0x00000105 (261) | Microsoft ACPI-Compliant System |
|  (ISA) 0x00000106 (262) | Microsoft ACPI-Compliant System |
|  (ISA) 0x00000107 (263) | Microsoft ACPI-Compliant System |
|  (ISA) 0x00000108 (264) | Microsoft ACPI-Compliant System |
|  (ISA) 0x00000109 (265) | Microsoft ACPI-Compliant System |
|  (ISA) 0x0000010A (266) | Microsoft ACPI-Compliant System |
|  (ISA) 0x0000010B (267) | Microsoft ACPI-Compliant System |
|  (ISA) 0x0000010C (268) | Microsoft ACPI-Compliant System |
|  (ISA) 0x0000010D (269) | Microsoft ACPI-Compliant System |
|  (ISA) 0x0000010E (270) | Microsoft ACPI-Compliant System |
|  (ISA) 0x0000010F (271) | Microsoft ACPI-Compliant System |
|  (ISA) 0x00000110 (272) | Microsoft ACPI-Compliant System |
|  (ISA) 0x00000111 (273) | Microsoft ACPI-Compliant System |
|  (ISA) 0x00000112 (274) | Microsoft ACPI-Compliant System |
|  (ISA) 0x00000113 (275) | Microsoft ACPI-Compliant System |
|  (ISA) 0x00000114 (276) | Microsoft ACPI-Compliant System |
|  (ISA) 0x00000115 (277) | Microsoft ACPI-Compliant System |
|  (ISA) 0x00000116 (278) | Microsoft ACPI-Compliant System |
|  (ISA) 0x00000117 (279) | Microsoft ACPI-Compliant System |
|  (ISA) 0x00000118 (280) | Microsoft ACPI-Compliant System |
|  (ISA) 0x00000119 (281) | Microsoft ACPI-Compliant System |
|  (ISA) 0x0000011A (282) | Microsoft ACPI-Compliant System |
|  (ISA) 0x0000011B (283) | Microsoft ACPI-Compliant System |
|  (ISA) 0x0000011C (284) | Microsoft ACPI-Compliant System |
|  (ISA) 0x0000011D (285) | Microsoft ACPI-Compliant System |
|  (ISA) 0x0000011E (286) | Microsoft ACPI-Compliant System |
|  (ISA) 0x0000011F (287) | Microsoft ACPI-Compliant System |
|  (ISA) 0x00000120 (288) | Microsoft ACPI-Compliant System |
|  (ISA) 0x00000121 (289) | Microsoft ACPI-Compliant System |
|  (ISA) 0x00000122 (290) | Microsoft ACPI-Compliant System |
|  (ISA) 0x00000123 (291) | Microsoft ACPI-Compliant System |
|  (ISA) 0x00000124 (292) | Microsoft ACPI-Compliant System |
|  (ISA) 0x00000125 (293) | Microsoft ACPI-Compliant System |
|  (ISA) 0x00000126 (294) | Microsoft ACPI-Compliant System |
|  (ISA) 0x00000127 (295) | Microsoft ACPI-Compliant System |
|  (ISA) 0x00000128 (296) | Microsoft ACPI-Compliant System |
|  (ISA) 0x00000129 (297) | Microsoft ACPI-Compliant System |
|  (ISA) 0x0000012A (298) | Microsoft ACPI-Compliant System |
|  (ISA) 0x0000012B (299) | Microsoft ACPI-Compliant System |

























| | |
|--|---------------------------------|
|  (ISA) 0x0000012C (300) | Microsoft ACPI-Compliant System |
|  (ISA) 0x0000012D (301) | Microsoft ACPI-Compliant System |
|  (ISA) 0x0000012E (302) | Microsoft ACPI-Compliant System |
|  (ISA) 0x0000012F (303) | Microsoft ACPI-Compliant System |
|  (ISA) 0x00000130 (304) | Microsoft ACPI-Compliant System |
|  (ISA) 0x00000131 (305) | Microsoft ACPI-Compliant System |
|  (ISA) 0x00000132 (306) | Microsoft ACPI-Compliant System |
|  (ISA) 0x00000133 (307) | Microsoft ACPI-Compliant System |
|  (ISA) 0x00000134 (308) | Microsoft ACPI-Compliant System |
|  (ISA) 0x00000135 (309) | Microsoft ACPI-Compliant System |
|  (ISA) 0x00000136 (310) | Microsoft ACPI-Compliant System |
|  (ISA) 0x00000137 (311) | Microsoft ACPI-Compliant System |
|  (ISA) 0x00000138 (312) | Microsoft ACPI-Compliant System |
|  (ISA) 0x00000139 (313) | Microsoft ACPI-Compliant System |
|  (ISA) 0x0000013A (314) | Microsoft ACPI-Compliant System |
|  (ISA) 0x0000013B (315) | Microsoft ACPI-Compliant System |
|  (ISA) 0x0000013C (316) | Microsoft ACPI-Compliant System |
|  (ISA) 0x0000013D (317) | Microsoft ACPI-Compliant System |
|  (ISA) 0x0000013E (318) | Microsoft ACPI-Compliant System |
|  (ISA) 0x0000013F (319) | Microsoft ACPI-Compliant System |
|  (ISA) 0x00000140 (320) | Microsoft ACPI-Compliant System |
|  (ISA) 0x00000141 (321) | Microsoft ACPI-Compliant System |
|  (ISA) 0x00000142 (322) | Microsoft ACPI-Compliant System |
|  (ISA) 0x00000143 (323) | Microsoft ACPI-Compliant System |
|  (ISA) 0x00000144 (324) | Microsoft ACPI-Compliant System |
|  (ISA) 0x00000145 (325) | Microsoft ACPI-Compliant System |
|  (ISA) 0x00000146 (326) | Microsoft ACPI-Compliant System |
|  (ISA) 0x00000147 (327) | Microsoft ACPI-Compliant System |
|  (ISA) 0x00000148 (328) | Microsoft ACPI-Compliant System |
|  (ISA) 0x00000149 (329) | Microsoft ACPI-Compliant System |
|  (ISA) 0x0000014A (330) | Microsoft ACPI-Compliant System |
|  (ISA) 0x0000014B (331) | Microsoft ACPI-Compliant System |
|  (ISA) 0x0000014C (332) | Microsoft ACPI-Compliant System |
|  (ISA) 0x0000014D (333) | Microsoft ACPI-Compliant System |
|  (ISA) 0x0000014E (334) | Microsoft ACPI-Compliant System |
|  (ISA) 0x0000014F (335) | Microsoft ACPI-Compliant System |
|  (ISA) 0x00000150 (336) | Microsoft ACPI-Compliant System |
|  (ISA) 0x00000151 (337) | Microsoft ACPI-Compliant System |
|  (ISA) 0x00000152 (338) | Microsoft ACPI-Compliant System |
|  (ISA) 0x00000153 (339) | Microsoft ACPI-Compliant System |
|  (ISA) 0x00000154 (340) | Microsoft ACPI-Compliant System |
|  (ISA) 0x00000155 (341) | Microsoft ACPI-Compliant System |

| | |
|--|---------------------------------|
|  (ISA) 0x00000156 (342) | Microsoft ACPI-Compliant System |
|  (ISA) 0x00000157 (343) | Microsoft ACPI-Compliant System |
|  (ISA) 0x00000158 (344) | Microsoft ACPI-Compliant System |
|  (ISA) 0x00000159 (345) | Microsoft ACPI-Compliant System |
|  (ISA) 0x0000015A (346) | Microsoft ACPI-Compliant System |
|  (ISA) 0x0000015B (347) | Microsoft ACPI-Compliant System |
|  (ISA) 0x0000015C (348) | Microsoft ACPI-Compliant System |
|  (ISA) 0x0000015D (349) | Microsoft ACPI-Compliant System |
|  (ISA) 0x0000015E (350) | Microsoft ACPI-Compliant System |
|  (ISA) 0x0000015F (351) | Microsoft ACPI-Compliant System |
|  (ISA) 0x00000160 (352) | Microsoft ACPI-Compliant System |
|  (ISA) 0x00000161 (353) | Microsoft ACPI-Compliant System |
|  (ISA) 0x00000162 (354) | Microsoft ACPI-Compliant System |
|  (ISA) 0x00000163 (355) | Microsoft ACPI-Compliant System |
|  (ISA) 0x00000164 (356) | Microsoft ACPI-Compliant System |
|  (ISA) 0x00000165 (357) | Microsoft ACPI-Compliant System |
|  (ISA) 0x00000166 (358) | Microsoft ACPI-Compliant System |
|  (ISA) 0x00000167 (359) | Microsoft ACPI-Compliant System |
|  (ISA) 0x00000168 (360) | Microsoft ACPI-Compliant System |
|  (ISA) 0x00000169 (361) | Microsoft ACPI-Compliant System |
|  (ISA) 0x0000016A (362) | Microsoft ACPI-Compliant System |
|  (ISA) 0x0000016B (363) | Microsoft ACPI-Compliant System |
|  (ISA) 0x0000016C (364) | Microsoft ACPI-Compliant System |
|  (ISA) 0x0000016D (365) | Microsoft ACPI-Compliant System |
|  (ISA) 0x0000016E (366) | Microsoft ACPI-Compliant System |
|  (ISA) 0x0000016F (367) | Microsoft ACPI-Compliant System |
|  (ISA) 0x00000170 (368) | Microsoft ACPI-Compliant System |
|  (ISA) 0x00000171 (369) | Microsoft ACPI-Compliant System |
|  (ISA) 0x00000172 (370) | Microsoft ACPI-Compliant System |
|  (ISA) 0x00000173 (371) | Microsoft ACPI-Compliant System |
|  (ISA) 0x00000174 (372) | Microsoft ACPI-Compliant System |
|  (ISA) 0x00000175 (373) | Microsoft ACPI-Compliant System |
|  (ISA) 0x00000176 (374) | Microsoft ACPI-Compliant System |
|  (ISA) 0x00000177 (375) | Microsoft ACPI-Compliant System |
|  (ISA) 0x00000178 (376) | Microsoft ACPI-Compliant System |
|  (ISA) 0x00000179 (377) | Microsoft ACPI-Compliant System |
|  (ISA) 0x0000017A (378) | Microsoft ACPI-Compliant System |
|  (ISA) 0x0000017B (379) | Microsoft ACPI-Compliant System |
|  (ISA) 0x0000017C (380) | Microsoft ACPI-Compliant System |
|  (ISA) 0x0000017D (381) | Microsoft ACPI-Compliant System |
|  (ISA) 0x0000017E (382) | Microsoft ACPI-Compliant System |
|  (ISA) 0x0000017F (383) | Microsoft ACPI-Compliant System |

| | |
|--|---------------------------------|
|  (ISA) 0x00000180 (384) | Microsoft ACPI-Compliant System |
|  (ISA) 0x00000181 (385) | Microsoft ACPI-Compliant System |
|  (ISA) 0x00000182 (386) | Microsoft ACPI-Compliant System |
|  (ISA) 0x00000183 (387) | Microsoft ACPI-Compliant System |
|  (ISA) 0x00000184 (388) | Microsoft ACPI-Compliant System |
|  (ISA) 0x00000185 (389) | Microsoft ACPI-Compliant System |
|  (ISA) 0x00000186 (390) | Microsoft ACPI-Compliant System |
|  (ISA) 0x00000187 (391) | Microsoft ACPI-Compliant System |
|  (ISA) 0x00000188 (392) | Microsoft ACPI-Compliant System |
|  (ISA) 0x00000189 (393) | Microsoft ACPI-Compliant System |
|  (ISA) 0x0000018A (394) | Microsoft ACPI-Compliant System |
|  (ISA) 0x0000018B (395) | Microsoft ACPI-Compliant System |
|  (ISA) 0x0000018C (396) | Microsoft ACPI-Compliant System |
|  (ISA) 0x0000018D (397) | Microsoft ACPI-Compliant System |
|  (ISA) 0x0000018E (398) | Microsoft ACPI-Compliant System |
|  (ISA) 0x0000018F (399) | Microsoft ACPI-Compliant System |
|  (ISA) 0x00000190 (400) | Microsoft ACPI-Compliant System |
|  (ISA) 0x00000191 (401) | Microsoft ACPI-Compliant System |
|  (ISA) 0x00000192 (402) | Microsoft ACPI-Compliant System |
|  (ISA) 0x00000193 (403) | Microsoft ACPI-Compliant System |
|  (ISA) 0x00000194 (404) | Microsoft ACPI-Compliant System |
|  (ISA) 0x00000195 (405) | Microsoft ACPI-Compliant System |
|  (ISA) 0x00000196 (406) | Microsoft ACPI-Compliant System |
|  (ISA) 0x00000197 (407) | Microsoft ACPI-Compliant System |
|  (ISA) 0x00000198 (408) | Microsoft ACPI-Compliant System |
|  (ISA) 0x00000199 (409) | Microsoft ACPI-Compliant System |
|  (ISA) 0x0000019A (410) | Microsoft ACPI-Compliant System |
|  (ISA) 0x0000019B (411) | Microsoft ACPI-Compliant System |
|  (ISA) 0x0000019C (412) | Microsoft ACPI-Compliant System |
|  (ISA) 0x0000019D (413) | Microsoft ACPI-Compliant System |
|  (ISA) 0x0000019E (414) | Microsoft ACPI-Compliant System |
|  (ISA) 0x0000019F (415) | Microsoft ACPI-Compliant System |
|  (ISA) 0x000001A0 (416) | Microsoft ACPI-Compliant System |
|  (ISA) 0x000001A1 (417) | Microsoft ACPI-Compliant System |
|  (ISA) 0x000001A2 (418) | Microsoft ACPI-Compliant System |
|  (ISA) 0x000001A3 (419) | Microsoft ACPI-Compliant System |
|  (ISA) 0x000001A4 (420) | Microsoft ACPI-Compliant System |
|  (ISA) 0x000001A5 (421) | Microsoft ACPI-Compliant System |
|  (ISA) 0x000001A6 (422) | Microsoft ACPI-Compliant System |
|  (ISA) 0x000001A7 (423) | Microsoft ACPI-Compliant System |
|  (ISA) 0x000001A8 (424) | Microsoft ACPI-Compliant System |
|  (ISA) 0x000001A9 (425) | Microsoft ACPI-Compliant System |

| | |
|--|---------------------------------|
|  (ISA) 0x000001AA (426) | Microsoft ACPI-Compliant System |
|  (ISA) 0x000001AB (427) | Microsoft ACPI-Compliant System |
|  (ISA) 0x000001AC (428) | Microsoft ACPI-Compliant System |
|  (ISA) 0x000001AD (429) | Microsoft ACPI-Compliant System |
|  (ISA) 0x000001AE (430) | Microsoft ACPI-Compliant System |
|  (ISA) 0x000001AF (431) | Microsoft ACPI-Compliant System |
|  (ISA) 0x000001B0 (432) | Microsoft ACPI-Compliant System |
|  (ISA) 0x000001B1 (433) | Microsoft ACPI-Compliant System |
|  (ISA) 0x000001B2 (434) | Microsoft ACPI-Compliant System |
|  (ISA) 0x000001B3 (435) | Microsoft ACPI-Compliant System |
|  (ISA) 0x000001B4 (436) | Microsoft ACPI-Compliant System |
|  (ISA) 0x000001B5 (437) | Microsoft ACPI-Compliant System |
|  (ISA) 0x000001B6 (438) | Microsoft ACPI-Compliant System |
|  (ISA) 0x000001B7 (439) | Microsoft ACPI-Compliant System |
|  (ISA) 0x000001B8 (440) | Microsoft ACPI-Compliant System |
|  (ISA) 0x000001B9 (441) | Microsoft ACPI-Compliant System |
|  (ISA) 0x000001BA (442) | Microsoft ACPI-Compliant System |
|  (ISA) 0x000001BB (443) | Microsoft ACPI-Compliant System |
|  (ISA) 0x000001BC (444) | Microsoft ACPI-Compliant System |
|  (ISA) 0x000001BD (445) | Microsoft ACPI-Compliant System |
|  (ISA) 0x000001BE (446) | Microsoft ACPI-Compliant System |
|  (ISA) 0x000001BF (447) | Microsoft ACPI-Compliant System |
|  (ISA) 0x000001C0 (448) | Microsoft ACPI-Compliant System |
|  (ISA) 0x000001C1 (449) | Microsoft ACPI-Compliant System |
|  (ISA) 0x000001C2 (450) | Microsoft ACPI-Compliant System |
|  (ISA) 0x000001C3 (451) | Microsoft ACPI-Compliant System |
|  (ISA) 0x000001C4 (452) | Microsoft ACPI-Compliant System |
|  (ISA) 0x000001C5 (453) | Microsoft ACPI-Compliant System |
|  (ISA) 0x000001C6 (454) | Microsoft ACPI-Compliant System |
|  (ISA) 0x000001C7 (455) | Microsoft ACPI-Compliant System |
|  (ISA) 0x000001C8 (456) | Microsoft ACPI-Compliant System |
|  (ISA) 0x000001C9 (457) | Microsoft ACPI-Compliant System |
|  (ISA) 0x000001CA (458) | Microsoft ACPI-Compliant System |
|  (ISA) 0x000001CB (459) | Microsoft ACPI-Compliant System |
|  (ISA) 0x000001CC (460) | Microsoft ACPI-Compliant System |
|  (ISA) 0x000001CD (461) | Microsoft ACPI-Compliant System |
|  (ISA) 0x000001CE (462) | Microsoft ACPI-Compliant System |
|  (ISA) 0x000001CF (463) | Microsoft ACPI-Compliant System |
|  (ISA) 0x000001D0 (464) | Microsoft ACPI-Compliant System |
|  (ISA) 0x000001D1 (465) | Microsoft ACPI-Compliant System |
|  (ISA) 0x000001D2 (466) | Microsoft ACPI-Compliant System |
|  (ISA) 0x000001D3 (467) | Microsoft ACPI-Compliant System |

| | |
|---|---------------------------------|
|  (ISA) 0x00001D4 (468) | Microsoft ACPI-Compliant System |
|  (ISA) 0x00001D5 (469) | Microsoft ACPI-Compliant System |
|  (ISA) 0x00001D6 (470) | Microsoft ACPI-Compliant System |
|  (ISA) 0x00001D7 (471) | Microsoft ACPI-Compliant System |
|  (ISA) 0x00001D8 (472) | Microsoft ACPI-Compliant System |
|  (ISA) 0x00001D9 (473) | Microsoft ACPI-Compliant System |
|  (ISA) 0x00001DA (474) | Microsoft ACPI-Compliant System |
|  (ISA) 0x00001DB (475) | Microsoft ACPI-Compliant System |
|  (ISA) 0x00001DC (476) | Microsoft ACPI-Compliant System |
|  (ISA) 0x00001DD (477) | Microsoft ACPI-Compliant System |
|  (ISA) 0x00001DE (478) | Microsoft ACPI-Compliant System |
|  (ISA) 0x00001DF (479) | Microsoft ACPI-Compliant System |
|  (ISA) 0x00001E0 (480) | Microsoft ACPI-Compliant System |
|  (ISA) 0x00001E1 (481) | Microsoft ACPI-Compliant System |
|  (ISA) 0x00001E2 (482) | Microsoft ACPI-Compliant System |
|  (ISA) 0x00001E3 (483) | Microsoft ACPI-Compliant System |
|  (ISA) 0x00001E4 (484) | Microsoft ACPI-Compliant System |
|  (ISA) 0x00001E5 (485) | Microsoft ACPI-Compliant System |
|  (ISA) 0x00001E6 (486) | Microsoft ACPI-Compliant System |
|  (ISA) 0x00001E7 (487) | Microsoft ACPI-Compliant System |
|  (ISA) 0x00001E8 (488) | Microsoft ACPI-Compliant System |
|  (ISA) 0x00001E9 (489) | Microsoft ACPI-Compliant System |
|  (ISA) 0x00001EA (490) | Microsoft ACPI-Compliant System |
|  (ISA) 0x00001EB (491) | Microsoft ACPI-Compliant System |
|  (ISA) 0x00001EC (492) | Microsoft ACPI-Compliant System |
|  (ISA) 0x00001ED (493) | Microsoft ACPI-Compliant System |
|  (ISA) 0x00001EE (494) | Microsoft ACPI-Compliant System |
|  (ISA) 0x00001EF (495) | Microsoft ACPI-Compliant System |
|  (ISA) 0x00001F0 (496) | Microsoft ACPI-Compliant System |
|  (ISA) 0x00001F1 (497) | Microsoft ACPI-Compliant System |
|  (ISA) 0x00001F2 (498) | Microsoft ACPI-Compliant System |
|  (ISA) 0x00001F3 (499) | Microsoft ACPI-Compliant System |
|  (ISA) 0x00001F4 (500) | Microsoft ACPI-Compliant System |
|  (ISA) 0x00001F5 (501) | Microsoft ACPI-Compliant System |
|  (ISA) 0x00001F6 (502) | Microsoft ACPI-Compliant System |
|  (ISA) 0x00001F7 (503) | Microsoft ACPI-Compliant System |
|  (ISA) 0x00001F8 (504) | Microsoft ACPI-Compliant System |
|  (ISA) 0x00001F9 (505) | Microsoft ACPI-Compliant System |
|  (ISA) 0x00001FA (506) | Microsoft ACPI-Compliant System |
|  (ISA) 0x00001FB (507) | Microsoft ACPI-Compliant System |
|  (ISA) 0x00001FC (508) | Microsoft ACPI-Compliant System |
|  (ISA) 0x00001FD (509) | Microsoft ACPI-Compliant System |

| | | |
|---|--------------------------|---|
|  | (ISA) 0x000001FE (510) | Microsoft ACPI-Compliant System |
|  | (ISA) 0x000001FF (511) | Microsoft ACPI-Compliant System |
|  | (PCI) 0x0000000A (10) | Intel(R) Atom(TM)/Celeron(R)/Pentium(R) Processor Platform Control Unit - SMBus Port - 0F12 |
|  | (PCI) 0x00000016 (22) | High Definition Audio Controller |
|  | (PCI) 0xFFFFFFFFB (-21) | Intel(R) Trusted Execution Engine Interface |
|  | (PCI) 0xFFFFFFFFEC (-20) | Intel(R) I211 Gigabit Network Connection #4 |
|  | (PCI) 0xFFFFFFFFED (-19) | Intel(R) I211 Gigabit Network Connection #3 |
|  | (PCI) 0xFFFFFFFFEE (-18) | Intel(R) I211 Gigabit Network Connection #2 |
|  | (PCI) 0xFFFFFFFFEF (-17) | Intel(R) I211 Gigabit Network Connection #2 |
|  | (PCI) 0xFFFFFFFFF0 (-16) | Intel(R) I211 Gigabit Network Connection #2 |
|  | (PCI) 0xFFFFFFFFF1 (-15) | Intel(R) I211 Gigabit Network Connection #2 |
|  | (PCI) 0xFFFFFFFFF2 (-14) | Intel(R) I211 Gigabit Network Connection #3 |
|  | (PCI) 0xFFFFFFFFF3 (-13) | Intel(R) I211 Gigabit Network Connection #3 |
|  | (PCI) 0xFFFFFFFFF4 (-12) | Intel(R) I211 Gigabit Network Connection #3 |
|  | (PCI) 0xFFFFFFFFF5 (-11) | Intel(R) I211 Gigabit Network Connection #4 |
|  | (PCI) 0xFFFFFFFFF6 (-10) | Intel(R) I211 Gigabit Network Connection #4 |
|  | (PCI) 0xFFFFFFFFF7 (-9) | Intel(R) I211 Gigabit Network Connection #4 |
|  | (PCI) 0xFFFFFFFFF8 (-8) | Intel(R) USB 3.0 eXtensible Host Controller - 1.0 (Microsoft) |
|  | (PCI) 0xFFFFFFFFF9 (-7) | Intel(R) HD Graphics |
|  | (PCI) 0xFFFFFFFFFA (-6) | Intel(R) I211 Gigabit Network Connection |
|  | (PCI) 0xFFFFFFFFFB (-5) | Intel(R) I211 Gigabit Network Connection |
|  | (PCI) 0xFFFFFFFFFC (-4) | Intel(R) I211 Gigabit Network Connection |
|  | (PCI) 0xFFFFFFFFFD (-3) | Intel(R) I211 Gigabit Network Connection |
|  | (PCI) 0xFFFFFFFFFE (-2) | Standard SATA AHCI Controller |

Appendix C

Mating Connectors

C.1 List of Mating Connectors and Cables

| Connector Label | Function | Mating Connector | | Available Cable | Cable P/N |
|-----------------|---------------------------|------------------|------------|---|------------|
| | | Vendor | Model no | | |
| CN8 | SATA | Molex | 88750-5318 | SATA CABLE.7P Pitch 1.27mm.50 cm | 1709070500 |
| CN7 | +5Vout Connector | JST | PHR-2 | 2 Pins For HDD Power | 1702150155 |
| CN10 | Digital IO Port Connector | Molex | 51110-0650 | n/a | n/a |
| CN16 | Front Panel Connector | Molex | 51110-1050 | n/a | n/a |
| CN15 | Buzzer connector | Molex | 51021-0200 | n/a | n/a |
| CN2 | 12V Power Connector | FLYINGWAY | FWAA801 | 2.5mm DC PLUG SCREW TYPE W/MOLDING to 5.08mm 1X4P HOUSING | 1702041004 |

Appendix D

Electrical Specifications for I/O Ports

D.1 Electrical Specifications for I/O Ports

| I/O | Reference | Signal name | Rate output |
|--------------------------------------|-----------|------------------|----------------------------|
| COM Port | CN1 | +5V/+12V | +5V/1A or +12V/1A |
| +5V Output for SATA HDD | CN7 | +5V | +5V/1A |
| Digital IO Port | CN10 | +5V | +5V/1A |
| C-Fast Slot | CN11 | +3.3V | +3.3V/0.5A |
| Mini-Card Slot USB 2.0 Port2 Only | CN13 | +3.3VSB +1.5V | +3.3V/1.1A +1.5V/0.375A |
| USB 3.0 Port 0 | CN17 | +5VSB | +5V/1A |
| USB 2.0 Port 3 | CN18 | +5VSB | +5V/0.5A |
| USB 2.0 Port 1 | CN19 | +5VSB | +5V/0.5A |
| HDMI Port | CN20,CN21 | +5V | +5V/1A |

Appendix E

Digital I/O Ports

E.1 Electrical Specifications for Digital I/O Ports

Table 1 : Digital Input/Output Pin Electrical Specification

| Pin | Type | Input Threshold Voltage | | Output Voltage | | Note |
|------|------|-------------------------|------|----------------|------|------|
| | | Low | High | Low | High | |
| DIO1 | I/O | 0.8 | 2.0 | 0 | 3.3 | |
| DIO2 | I/O | 0.8 | 2.0 | 0 | 3.3 | |
| DIO3 | I/O | 0.8 | 2.0 | 0 | 3.3 | |
| DIO4 | I/O | 0.8 | 2.0 | 0 | 3.3 | |

Note: All DI/O pins are 5V tolerant in input mode.

E.2 DI/O Programming

GENE-BT04 utilizes FINTEK F81801U chipset as its Digital I/O controller. Below are the procedures to complete its configuration and the AAEON initial DI/O program is also attached, based on which you can develop customized program to fit your application.

There are three steps to complete the configuration setup:

- (1) Enter the MB PnP Mode
- (2) Modify the data of configuration registers
- (3) Exit the MB PnP Mode. Undesired result may occur if the MB PnP Mode is not exited normally.

E.3 Digital I/O Register

Table 2 : SuperIO relative register table

| | Default Value | Note |
|-------|---------------|--|
| Index | 0x2E | SIO MB PnP Mode Index Register 0x2E or 0x4E |
| Data | 0x2F | SIO MB PnP Mode Data Register 0x2F or 0x4F |

Table 3 : Digital Input/Output relative register table

| | LDN | Register | Bit | Note |
|--------------------|------|----------|-----|--------------------|
| GPIO1 Direction | 0x06 | 0xC0 | 0 | 0:input, 1: output |
| GPIO2 Direction | 0x06 | 0xC0 | 1 | |
| GPIO3 Direction | 0x06 | 0xC0 | 2 | |
| GPIO4 Direction | 0x06 | 0xC0 | 3 | |
| GPIO1 Output Level | 0x06 | 0xC1 | 0 | 0:low, 1: high |
| GPIO2 Output Level | 0x06 | 0xC1 | 1 | |
| GPIO3 Output Level | 0x06 | 0xC1 | 2 | |
| GPIO4 Output Level | 0x06 | 0xC1 | 3 | |
| GPIO1 Status | 0x06 | 0xC2 | 0 | 0:low, 1: high |
| GPIO2 Status | 0x06 | 0xC2 | 1 | |
| GPIO3 Status | 0x06 | 0xC2 | 2 | |
| GPIO4 Status | 0x06 | 0xC2 | 3 | |

E.4 Digital I/O Sample Program

```

*****
// SuperIO relative definition (Please reference to Table 2)
#define SIOIndex 0x2E
#define SIOData 0x2F
#define DIOLDN 0x06
IOWriteByte(byte IOPort, byte Value);
IOReadByte(byte IOPort);
// DIO relative definition (Please reference to Table 3)
#define DirReg 0xC0 // 0:input, 1: output
    #define InputPin 0x00
    #define OutputPin 0x01
#define OutputReg 0xC1 // 0:low, 1: high
#define StatusReg 0xC2 // 0:low, 1: high
    #define PinLow 0x00
    #define PinHigh 0x01
#define Pin1Bit 0x00
#define Pin2Bit 0x01
#define Pin3Bit 0x02
#define Pin4Bit 0x03
*****

*****
VOID Main(){
    Boolean PinStatus ;

    // Procedure : AaeonReadPinStatus
    // Input :
    // Example, Read Digital I/O Pin 3 status
    // Output :
    // InputStatus :
    // 0: Digital I/O Pin level is low
    // 1: Digital I/O Pin level is High
    PinStatus = AaeonReadPinStatus(Pin3Bit);

    // Procedure : AaeonSetOutputLevel
    // Input :
    // Example, Set Digital I/O Pin 2 to high level
    AaeonSetOutputLevel(Pin2Bit, PinHigh);
}

```

```

*****
*****
Boolean  AaeonReadPinStatus(byte PinBit){
    Boolean PinStatus ;

        PinStatus = SIOBitRead(DIOLDN, StatusReg, PinBit);
        Return PinStatus ;
    }
VOID  AaeonSetOutputLevel(byte PinBit, byte Value){
    ConfigDioMode(PinBit, OutputPin);
    SIOBitSet(DIOLDN, OutputReg, PinBit, Value);
    }
*****

*****VOID
SIOEnterMBPnPMode(){
    IOWriteByte(SIOIndex, 0x87);
    IOWriteByte(SIOIndex, 0x87);
    }

VOID  SIOExitMBPnPMode(){
    IOWriteByte(SIOIndex, 0xAA);
    }

VOID  SIOSelectLDN(byte LDN){
    IOWriteByte(SIOIndex, 0x07); // SIO LDN Register Offset = 0x07
    IOWriteByte(SIOData, LDN);
    }

VOID  SIOBitSet(byte LDN, byte Register, byte BitNum, byte Value){
    Byte TmpValue;

    SIOEnterMBPnPMode();
    SIOSelectLDN(LDN);
    IOWriteByte(SIOIndex, Register);
    TmpValue = IOReadByte(SIOData);
    TmpValue &= ~(1 << BitNum);
    TmpValue |= (Value << BitNum);
    IOWriteByte(SIOData, TmpValue);
    SIOExitMBPnPMode();
    }

```

```

VOID  SIOByteSet(byte LDN, byte Register, byte Value){
    SIOEnterMBPnPMode();
    SIOSelectLDN(LDN);
    IOWriteByte(SIOIndex, Register);
    IOWriteByte(SIOData, Value);
    SIOExitMBPnPMode();
}
*****

*****

Boolean  SIOBitRead(byte LDN, byte Register, byte BitNum){
    Byte TmpValue;

    SIOEnterMBPnPMode();
    SIOSelectLDN(LDN);
    IOWriteByte(SIOIndex, Register);
    TmpValue = IOReadByte(SIOData);
    TmpValue &= (1 << BitNum);
    SIOExitMBPnPMode();
    If(TmpValue == 0)
        Return 0;
    Return 1;
}

VOID  ConfigDioMode(byte PinBit, byte Mode){
    Byte TmpValue;

    SIOEnterMBPnPMode();
    SIOSelectLDN(DIOLDN);
    IOWriteByte(SIOIndex, DirReg);
    TmpValue = IOReadByte(SIOData);
    TmpValue |= (Mode << PinBit);
    IOWriteByte(SIOData, DirReg);
    SIOExitMBPnPMode();
}
*****

```