

# GENE-BT04

---

3.5" Subcompact Board

User's Manual 3<sup>rd</sup> Ed

## Copyright Notice

---

This document is copyrighted, 2018. All rights are reserved. The original manufacturer reserves the right to make improvements to the products described in this manual at any time without notice.

No part of this manual may be reproduced, copied, translated, or transmitted in any form or by any means without the prior written permission of the original manufacturer. Information provided in this manual is intended to be accurate and reliable. However, the original manufacturer assumes no responsibility for its use, or for any infringements upon the rights of third parties that may result from its use.

The material in this document is for product information only and is subject to change without notice. While reasonable efforts have been made in the preparation of this document to assure its accuracy, AAEMON assumes no liabilities resulting from errors or omissions in this document, or from the use of the information contained herein.

AAEMON reserves the right to make changes in the product design without notice to its users.

## Acknowledgement

---

All other products' name or trademarks are properties of their respective owners.

- Microsoft Windows is a registered trademark of Microsoft Corp.
- Intel, Pentium, Celeron, and Xeon are registered trademarks of Intel Corporation
- Core, Atom are trademarks of Intel Corporation
- ITE is a trademark of Integrated Technology Express, Inc.
- IBM, PC/AT, PS/2, and VGA are trademarks of International Business Machines Corporation.

All other product names or trademarks are properties of their respective owners.

## Packing List

---

Before setting up your product, please make sure the following items have been shipped:

Item	Quantity
● GENE-BT04 (with heat spreader)	1
● Product DVD with User's Manual (in pdf) and drivers	1

If any of these items are missing or damaged, please contact your distributor or sales representative immediately.

## About this Document

---

This User's Manual contains all the essential information, such as detailed descriptions and explanations on the product's hardware and software features (if any), its specifications, dimensions, jumper/connector settings/definitions, and driver installation instructions (if any), to facilitate users in setting up their product.

Users may refer to the [AAEON.com](http://AAEON.com) for the latest version of this document.

## Safety Precautions

---

Please read the following safety instructions carefully. It is advised that you keep this manual for future references

1. All cautions and warnings on the device should be noted.
2. Make sure the power source matches the power rating of the device.
3. Position the power cord so that people cannot step on it. Do not place anything over the power cord.
4. Always completely disconnect the power before working on the system's hardware.
5. No connections should be made when the system is powered as a sudden rush of power may damage sensitive electronic components.
6. If the device is not to be used for a long time, disconnect it from the power supply to avoid damage by transient over-voltage.
7. Always disconnect this device from any AC supply before cleaning.
8. While cleaning, use a damp cloth instead of liquid or spray detergents.
9. Make sure the device is installed near a power outlet and is easily accessible.
10. Keep this device away from humidity.
11. Place the device on a solid surface during installation to prevent falls
12. Do not cover the openings on the device to ensure optimal heat dissipation.
13. Watch out for high temperatures when the system is running.
14. Do not touch the heat sink or heat spreader when the system is running
15. Never pour any liquid into the openings. This could cause fire or electric shock.
16. As most electronic components are sensitive to static electrical charge, be sure to ground yourself to prevent static charge when installing the internal components. Use a grounding wrist strap and contain all electronic components in any static-shielded containers.

17. If any of the following situations arises, please the contact our service personnel:
  - i. Damaged power cord or plug
  - ii. Liquid intrusion to the device
  - iii. Exposure to moisture
  - iv. Device is not working as expected or in a manner as described in this manual
  - v. The device is dropped or damaged
  - vi. Any obvious signs of damage displayed on the device
18. **DO NOT LEAVE THIS DEVICE IN AN UNCONTROLLED ENVIRONMENT WITH TEMPERATURES BEYOND THE DEVICE'S PERMITTED STORAGE TEMPERATURES (SEE CHAPTER 1) TO PREVENT DAMAGE.**

### **Warning!**



This device complies with Part 15 FCC Rules. Operation is subject to the following two conditions: (1) this device may not cause harmful interference, and (2) this device must accept any interference received including interference that may cause undesired operation.

### **Caution:**

*There is a danger of explosion if the battery is incorrectly replaced. Replace only with the same or equivalent type recommended by the manufacturer. Dispose of used batteries according to the manufacturer's instructions and your local government's recycling or disposal directives.*

### **Attention:**

*Il y a un risque d'explosion si la batterie est remplacée de façon incorrecte. Ne la remplacer qu'avec le même modèle ou équivalent recommandé par le constructeur. Recycler les batteries usées en accord avec les instructions du fabricant et les directives gouvernementales de recyclage.*



## China RoHS Requirements (CN)

产品中有毒有害物质或元素名称及含量

AAEON Main Board/ Daughter Board/ Backplane

部件名称	有毒有害物质或元素					
	铅 (Pb)	汞 (Hg)	镉 (Cd)	六价铬 (Cr(VI))	多溴联苯 (PBB)	多溴二苯醚 (PBDE)
印刷电路板 及其电子组件	×	○	○	○	○	○
外部信号 连接器及线材	×	○	○	○	○	○
<p>○: 表示该有毒有害物质在该部件所有均质材料中的含量均在 SJ/T 11363-2006 标准规定的限量要求以下。</p> <p>X: 表示该有毒有害物质至少在该部件的某一均质材料中的含量超出 SJ/T 11363-2006 标准规定的限量要求。</p> <p>备注: 此产品所标示之环保使用期限, 系指在一般正常使用状况下。</p>						

## China RoHS Requirement (EN)

Poisonous or Hazardous Substances or Elements in Products

AAEON Main Board/ Daughter Board/ Backplane

Component	Poisonous or Hazardous Substances or Elements					
	Lead (Pb)	Mercury (Hg)	Cadmium (Cd)	Hexavalent Chromium (Cr(VI))	Polybrominated Biphenyls (PBB)	Polybrominated Diphenyl Ethers (PBDE)
PCB & Other Components	X	○	○	○	○	○
Wires & Connectors for External Connections	X	○	○	○	○	○
<p>O: The quantity of poisonous or hazardous substances or elements found in each of the component's parts is below the SJ/T 11363-2006-stipulated requirement.</p> <p>X: The quantity of poisonous or hazardous substances or elements found in at least one of the component's parts is beyond the SJ/T 11363-2006-stipulated requirement.</p> <p><b>Note:</b> The Environment Friendly Use Period as labeled on this product is applicable under normal usage only</p>						

# Table of Contents

---

<b>Chapter 1 - Product Specifications</b> .....	<b>1</b>
1.1 Specifications .....	2
<b>Chapter 2 – Hardware Information</b> .....	<b>4</b>
2.1 Dimensions .....	5
2.2 Jumpers and Connectors.....	7
2.3 Block Diagram.....	9
2.4 List of Jumpers .....	10
2.4.1 Clear CMOS Jumper (CN12, Pin 1,3,5).....	11
2.4.2 Auto Power Button Enable/Disable Selection (JP12, Pin 2,4,6) 11	
2.4.3 Push POWER Button with Orange LED (SW4).....	11
2.5 List of Connectors.....	13
2.5.1 COM Port RS-232 (CN1).....	14
2.5.2 +12 V Input (CN2).....	14
2.5.3 LAN Port 1/2/3/4 (RJ-45) (CN3,4,5,6).....	15
2.5.4 +5 V Output for SATA HDD (CN7) .....	15
2.5.5 SATA Port (CN8) .....	16
2.5.6 DDR3L SODIMM Slot (CN9) .....	16
2.5.7 Digital I/O Port (CN10).....	16
2.5.8 CFast Card Connector (CN11).....	17
2.5.9 MiniCard Slot (USB Port2 only) (CN13).....	18
2.5.10 Battery (CN14) .....	21
2.5.11 Buzzer Connector (CN15).....	21
2.5.12 Front Panel Connector (CN16) .....	21
2.5.13 USB 3.0 Port 0 (CN17) .....	22
2.5.14 USB 2.0 Port 3 and 1 (CN18/ 19).....	23

2.5.15	HDMI Port 1 and 2 (CN20/ 21) .....	23
2.5.16	LPC Port (CN22) .....	24
2.5.17	SPI Programming Header (CN23) .....	25
<b>Chapter 3 - AMI BIOS Setup .....</b>		<b>26</b>
3.1	System Test and Initialization .....	27
3.2	AMI BIOS Setup .....	28
3.3	Setup submenu: Main .....	29
3.4	Setup submenu: Advanced .....	30
3.4.1	Advanced: ACPI Settings .....	31
3.4.2	Advanced: F81801 Super IO Configuration .....	33
3.4.2.1	F81801 Super IO Configuration: Serial Port 1 Configuration .....	34
3.4.3	Advanced: H/W Monitor .....	36
3.4.4	Advanced: CPU Configuration .....	37
3.4.4.1	CPU Configuration: Socket 0 CPU Configuration .....	38
3.4.5	Advanced: IDE Configuration .....	39
3.4.6	Advanced: Dynamic Digital IO Configuration .....	41
3.4.7	Advanced: USB Configuration .....	42
3.5	Setup Submenu: Chipset .....	44
3.5.1	Chipset: Host Bridge .....	45
3.5.1.1	Host Bridge: LCD Control .....	46
3.5.2	Chipset: South Bridge .....	47
3.5.2.1	South Bridge: USB Configuration .....	48
3.5.2.2	South Bridge: PCI Express Configuration .....	50
3.6	Setup submenu: Security .....	51
3.6.1	Security: Secure Boot .....	53
3.7	Setup submenu: Boot .....	54
3.8	Setup submenu: Save & Exit .....	55

<b>Chapter 4 – Drivers Installation</b> .....	<b>56</b>
4.1 Product CD/DVD .....	57
<b>Appendix A - Watchdog Timer Programming</b> .....	<b>59</b>
A.1 Watchdog Timer Registers .....	60
A.2 Watchdog Sample Program.....	61
<b>Appendix B - I/O Information</b> .....	<b>64</b>
B.1 I/O Address Map .....	65
B.2 Memory Address Map .....	67
B.3 IRQ Mapping Chart.....	68
<b>Appendix C – Mating Connectors</b> .....	<b>80</b>
C.1 List of Mating Connectors and Cables.....	81
<b>Appendix D – Electrical Specifications for I/O Ports</b> .....	<b>82</b>
D.1 Electrical Specifications for I/O Ports.....	83
<b>Appendix E – Digital I/O Ports</b> .....	<b>84</b>
E.1 Electrical Specifications for Digital I/O Ports.....	85
E.2 DI/O Programming .....	86
E.3 Digital I/O Register.....	87
E.4 Digital I/O Sample Program.....	88

# Chapter 1

---

Product Specifications

## 1.1 Specifications

---

### System

- **Form Factor** 3.5"
- **Processor** Intel® Atom™ N2807/ J1900 SoC (1.58/ 2.0 GHz)
- **System Memory** DDR3L 1333 MHz SODIMM x 1, up to 8GB
- **Chipset** Intel® Atom™ N2807/ J1900 SoC
- **I/O Chipset** Fintek 81801U
- **Ethernet** Intel LAN x4  
Intel(R) I211 X2, Intel(R) I210 X2  
Gigabit Ethernet,RJ-45 x 4
- **BIOS** AMI BIOS 64 MB SPI ROM
- **Watchdog Timer** 1 ~ 255 step by software program
- **H/W Status Monitoring** System temperature, voltage status
- **Expansion Interface** MiniCard x 1 (USB only)  
DIO 4-bit (2 in, 2 out) with box pin header  
LCP x 1
- **Power Requirement** DC 12V~24V, ATX mode
- **Board Size** 146 x 101.6 mm (5.75 x 4")
- **Gross Weight** 0.4 kg (0.88 lb)
- **Operating Temperature** 0 ~ 60°C (32 ~ 140°F)
- **Storage Temperature** -40 ~ 80°C (-40 ~ 176°F)

- **Operation Humidity** 0 ~ 90% Relative Humidity, Non-Condensing
- **EMI** CD & FCC class A

## Display

- **Chipset** Intel® Atom™ N2807/ J1900 SoC
- **Engine** Intel® Atom™ N2807/ J1900 SoC
- **Resolution** Up to 1920 X 1080 for HDMI
- **Output Interface** HDMI x 2 (HDMI1 with audio, HDMI2 without)

## I/O

- **Storage** CFast™ x 1  
SATA x 1
- **USB** USB 3.0 x 1  
USB 2.0 x 2
- **Serial Port** RS-232 x 1
- **DI/O** DIO 4-bit (2 in, 2 out) with box pin header
- **Switch** Power switch x 1 (with LED)



# Chapter 2

---

Hardware Information

## 2.1 Dimensions

### Component Side

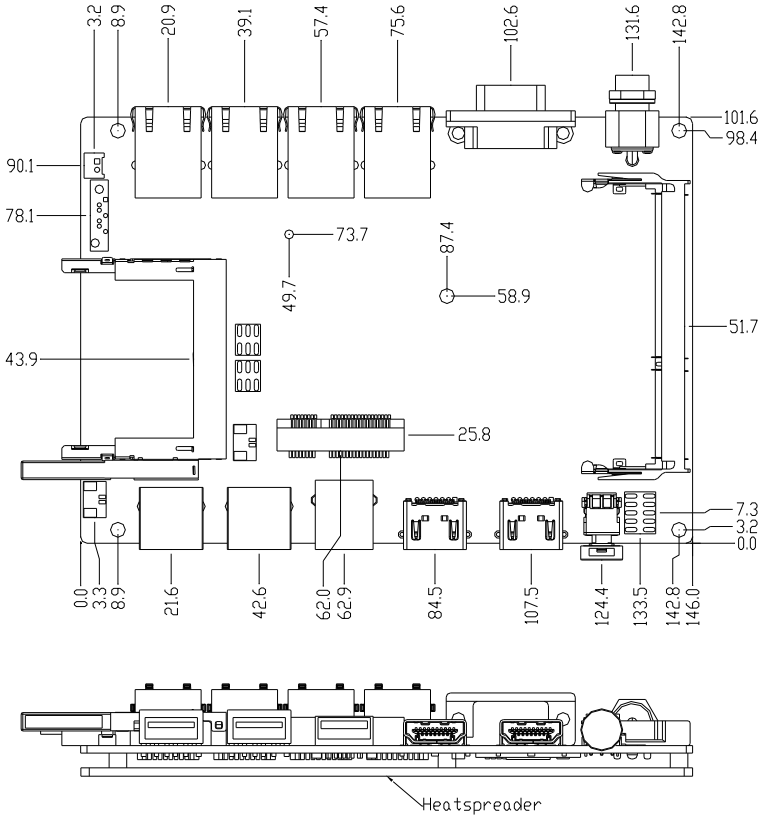

Solder Side

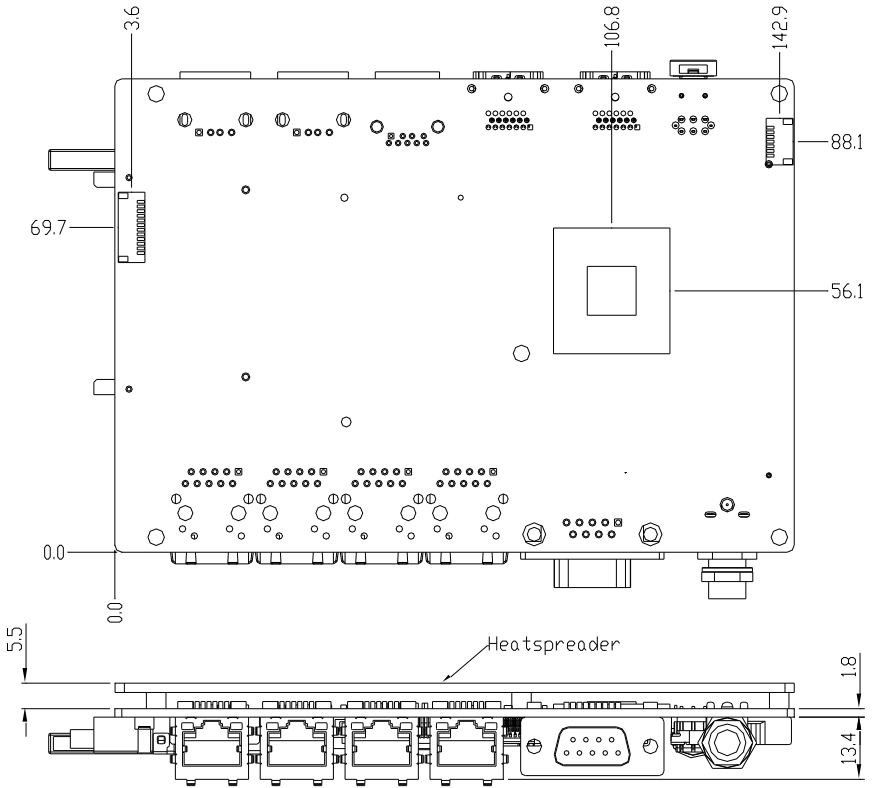

## 2.2 Jumpers and Connectors

### Component Side

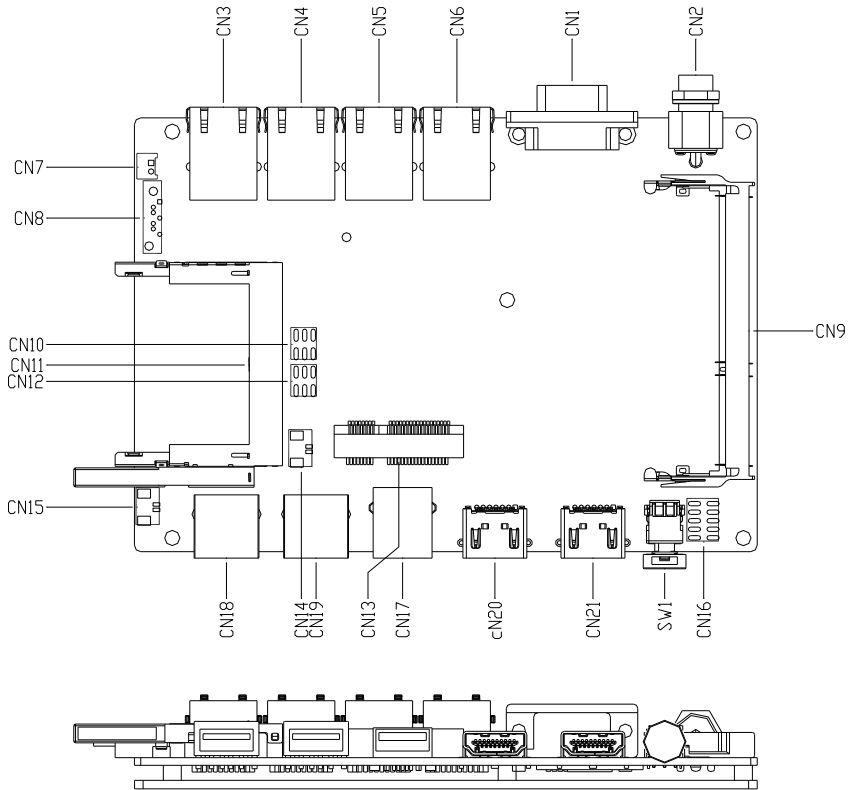

### Solder Side

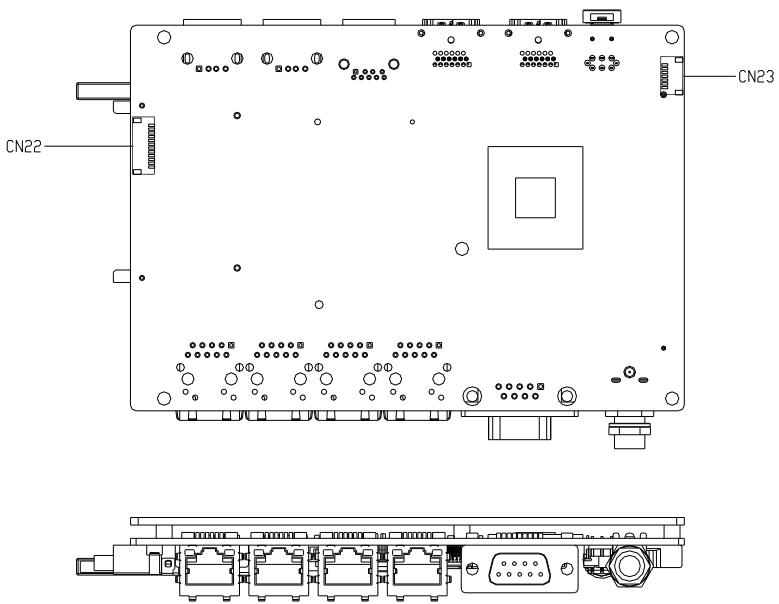

## 2.3 Block Diagram

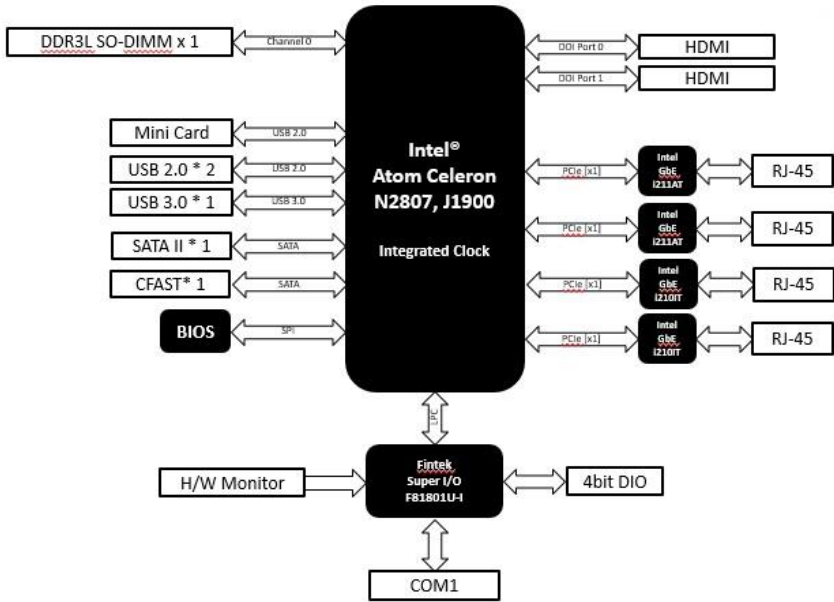

## 2.4 List of Jumpers

---

Please refer to the table below for all of the board's jumpers that you can configure for your application

Label	Function
CN12 (1,3,5)	Clear CMOS Jumper
CN12 (2,4,6)	Auto Power Button Enable/Disable Selection
SW1	Push Power Button With Orange LED

### 2.4.1 Clear CMOS Jumper (CN12, Pin 1,3,5)

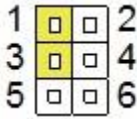

Normal (Default)

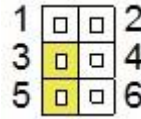

Clear CMOS

### 2.4.2 Auto Power Button Enable/Disable Selection (JP12, Pin 2,4,6)

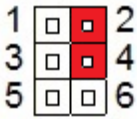

Enable (Default)

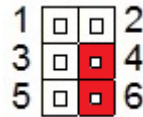

Disable

### 2.4.3 Push POWER Button with Orange LED (SW4)

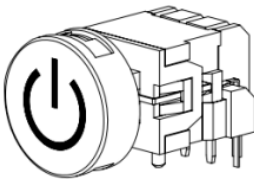

CIRCUIT

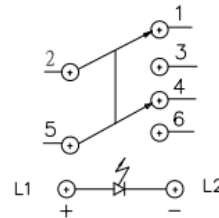

Pin	Pin Name	Signal Type	Signal level
L1	+V5S	IN	+5V



L2	GND	GND	GND
1	NC		
2	PWRBTN#	OUT	
3	GND	GND	GND
4	NC		
5	NC		
6	NC		

## 2.5 List of Connectors

Please refer to the table below for all of the board's connectors that you can configure for your application

Label	Function
CN1	COM port RS-232
CN2	+12V Input
CN3	LAN (RJ-45) Port
CN4	LAN (RJ-45) Port
CN5	LAN (RJ-45) Port
CN6	LAN (RJ-45) Port
CN7	+5V Output for SATA HDD
CN8	SATA Port
CN9	DDR3L SO-DIMM Slot
CN10	Digital IO Port
CN11	C-FAST CARD Connector
CN13	Mini-Card Slot (USB2.0 port 2 ONLY)
CN14	Battery
CN15	Buzzer connector
CN16	Front Panel Connector
CN17	USB3.0 port 0
CN18	USB2.0 port 3
CN19	USB2.0 port 1
CN20	HDMI1 Port
CN21	HDMI2 Port
CN22	LPC Expansion Connector
CN23	SPI Programming Header

### 2.5.1 COM Port RS-232 (CN1)

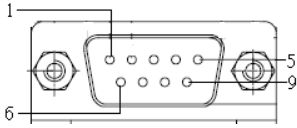

Pin	Pin Name	Signal Type	Signal level
1	DCD	IN	
2	RX	IN	
3	TX	OUT	±9V
4	DTR	OUT	±9V
5	GND	GND	
6	DSR	IN	
7	RTS	OUT	±9V
8	CTS	IN	
9	RI	IN	

### 2.5.2 +12 V Input (CN2)

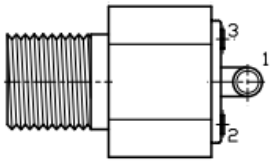

Pin	Pin Name	Signal Type	Signal Level
1	+12V	PWR	+12V
2-3	GND	GND	

### 2.5.3 LAN Port 1/2/3/4 (RJ-45) (CN3,4,5,6)

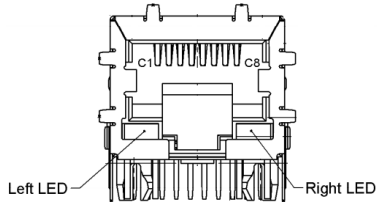

Pin	Pin Name	Signal Type	Signal Level
C1	MDI0+	DIFF	
C2	MDI0-	DIFF	
C3	MDI1+	DIFF	
C4	MDI2+	DIFF	
C5	MDI2-	DIFF	
C6	MDI1-	DIFF	
C7	MDI3+	DIFF	
C8	MDI3-	DIFF	

### 2.5.4 +5 V Output for SATA HDD (CN7)

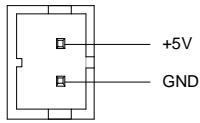

Pin	Pin Name	Signal Type	Signal Level
1	+V5S	PWR	+5V
2	GND	GND	

## 2.5.5 SATA Port (CN8)

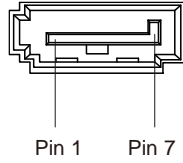

Pin	Pin Name	Signal Type	Signal Level
1	GND	GND	
2	SATA_TXP1	DIFF	
3	SATA_TXN1	DIFF	
4	GND	GND	
5	SATA_RXN1	DIFF	
6	SATA_RXP1	DIFF	
7	GND	GND	

## 2.5.6 DDR3L SODIMM Slot (CN9)

Standard specification

## 2.5.7 Digital I/O Port (CN10)

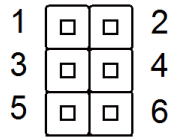

Pin	Pin Name	Signal Type	Signal Level
1	+V5S	PWR	+5V
2	DIO0	I/O	+5V
3	DIO1	I/O	+5V

4	DIO2	I/O	+5V
5	DIO3	I/O	+5V
6	GND	GND	

### 2.5.8 CFast Card Connector (CN11)

Pin	Pin Name	Signal Type	Signal level
S1	GND	GND	
S2	SATA_TXP0	DIFF	
S3	SATA_TXN0	DIFF	
S4	GND	GND	
S5	SATA_RXN0	DIFF	
S6	SATA_RXP0	DIFF	
S7	GND	GND	
P1	NC		
P2	GND	GND	
P3	NC		
P4	NC		
P5	NC		
P6	NC		
P7	GND	GND	
P8	CFD_LED#	OUT	+3.3V
P9	NC		
P10	NC		
P11	NC		

P12	NC		
P13	+V3.3S	PWR	+3.3V
P14	+V3.3S	PWR	+3.3V
P15	GND	GND	
P16	GND	GND	
P17	NC		

### 2.5.9 MiniCard Slot (USB Port2 only) (CN13)

Pin	Pin Name	Signal Type	Signal level
1	WAKE_PCIE0#_3P3	IN	
2	+V3.3A	PWR	+3.3V
3	NC		
4	GND	GND	
5	NC		
6	+V1.5S	PWR	+1.5V
7	NC	IN	
8	NC	PWR	
9	GND	GND	
10	NC	I/O	
11	NC	DIFF	
12	NC	IN	
13	NC	DIFF	
14	NC	IN	
15	GND	GND	
16	NC	PWR	

Pin	Pin Name	Signal Type	Signal level
17	NC		
18	GND	GND	
19	NC		
20	WL_DISABLE0#	OUT	+3.3V
21	GND	GND	
22	BUF_PLT_RST#	OUT	+3.3V
23	NC	DIFF	
24	+V3.3A	PWR	+3.3V
25	NC	DIFF	
26	GND	GND	
27	GND	GND	
28	+V1.5S	PWR	+1.5V
29	GND	GND	
30	SMB_CLK_3P3_FA	I/O	+3.3V
31	NC	DIFF	
32	SMB_DATA_3P3_FA	I/O	+3.3V
33	NC	DIFF	
34	GND	GND	
35	GND	GND	
36	USB_DN2	DIFF	
37	GND	GND	
38	USB_DP2	DIFF	
39	+V3.3A	PWR	+3.3V
40	GND	GND	
41	+V3.3A	PWR	+3.3V



Pin	Pin Name	Signal Type	Signal level
42	NC		
43	NC		
44	NC		
45	NC		
46	NC		
47	NC		
48	+V1.5S	PWR	+1.5V
49	NC		
50	GND	GND	
51	NC		
52	+V3.3A	PWR	+3.3V

### 2.5.10 Battery (CN14)

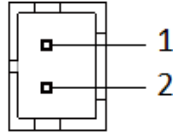

Pin	Pin Name	Signal Type	Signal Level
1	+3.3V	PWR	3.3V
2	GND	GND	

### 2.5.11 Buzzer Connector (CN15)

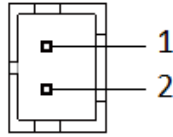

Pin	Pin Name	Signal Type	Signal Level
1	+V3.3S	PWR	3.3V
2	FP_BUZZER	OUT	3.3V

### 2.5.12 Front Panel Connector (CN16)

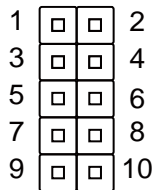

Pin	Pin Name	Signal Type	Signal Level
1	GND	GND	
2	PWR_BTN#	IN	
3	IDELED#	OUT	

4	+V3.3S	PWR	+3.3V
5	BUZZER	OUT	
6	+V5S	PWR	+5V
7	GND	GND	
8	+V3.3S	PWR	+3.3V
9	GND	GND	
10	HWRST#	IN	

### 2.5.13 USB 3.0 Port 0 (CN17)

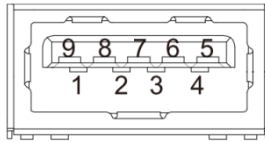

Pin	Pin Name	Signal Type	Signal Level
1	+5VSB	PWR	+5V
2	USB0_D-	DIFF	
3	USB0_D+	DIFF	
4	GND	GND	
5	USB0_SSRX-	DIFF	
6	USB0_SSRX+	DIFF	
7	GND	GND	
8	USB0_SSTX-	DIFF	
9	USB0_SSTX+	DIFF	

### 2.5.14 USB 2.0 Port 3 and 1 (CN18/ 19)

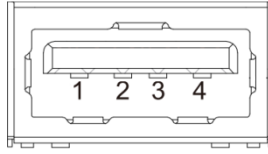

Pin	Pin Name	Signal Type	Signal Level
1	+5VSB	PWR	+5V
2	USB1_D-	DIFF	
3	USB1_D+	DIFF	
4	GND	GND	

### 2.5.15 HDMI Port 1 and 2 (CN20/ 21)

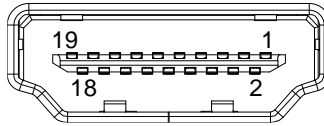

Pin	Pin Name	Signal Type	Signal Level
1	TMDS_DAT2+	DIFF	
2	GND	GND	
3	TMDS_DAT2-	DIFF	
4	TMDS_DAT1+	DIFF	
5	GND	GND	
6	TMDS_DAT1-	DIFF	
7	TMDS_DAT0+	DIFF	
8	GND	GND	
9	TMDS_DAT0-	DIFF	

10	TMDS_CLK+	DIFF	
11	GND	GND	
12	TMDS_CLK-	DIFF	
13	NC		
14	NC		
15	DDC_CLK	I/O	+5V
16	DDC_DATA	I/O	+5V
17	GND	GND	
18	+5V	I/O	+5V
19	HPLG_DETECT	IN	

## 2.5.16LPC Port (CN22)

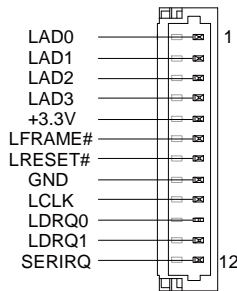

Pin	Pin Name	Signal Type	Signal Level
1	LAD0	I/O	+3.3V
2	LAD1	I/O	+3.3V
3	LAD2	I/O	+3.3V
4	LAD3	I/O	+3.3V
5	+V3.3S	PWR	+3.3V
6	LFRAME#	IN	
7	LRESET#	OUT	+3.3V
8	GND	GND	

9	LCLK	OUT	
10	LDRQ0	IN	
11	LDRQ1	IN	
12	SERIRQ	I/O	+3.3V

### 2.5.17 SPI Programming Header (CN23)

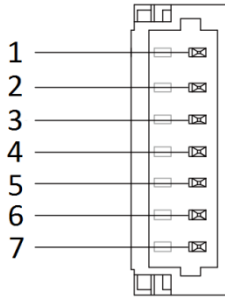

Pin	Pin Name	Signal Type	Signal Level
1	SPI_SO_F	OUT	
2	GND	GND	
3	SPI_CLK_F	IN	
4	+V3.3A_SPI	PWR	+3.3V
5	SPI_SI_F	IN	
6	SPI_CS0#_F	IN	
7	NC		

# Chapter 3

---

AMI BIOS Setup

## 3.1 System Test and Initialization

---

The board uses certain routines to perform testing and initialization. If an error, fatal or non-fatal, is encountered, a few short beeps or an error message will be outputted. The board can usually continue the boot up sequence with non-fatal errors.

The system configuration verification routines check the current system configuration against the values stored in the CMOS memory. If they do not match, an error message will be outputted, in which case you will need to run the BIOS setup program to set the configuration information in memory.

There are three situations in which you will need to change the CMOS settings:

- You are starting your system for the first time
- You have changed your system's hardware
- The CMOS memory has lost power and the configuration information is erased

The system's CMOS memory uses a backup battery for data retention, which is to be replaced once emptied.



## 3.2 AMI BIOS Setup

---

The AMI BIOS ROM has a pre-installed Setup program that allows users to modify basic system configurations, which is stored in the battery-backed CMOS RAM and BIOS NVRAM so that the information is retained when the power is turned off.

To enter BIOS Setup, press <Del> or <F2> immediately while your computer is powering up.

The function for each interface can be found below.

**Main** – Date and time can be set here. Press <Tab> to switch between date elements

**Advanced** – Enable/ Disable boot option for legacy network devices

**Chipset** – For hosting bridge parameters

**Boot** – Enable/ Disable quiet Boot Option

**Security** – The setup administrator password can be set here

**Save & Exit** – Save your changes and exit the program

### 3.3 Setup submenu: Main

Press 'Delete' Key to enter Setup

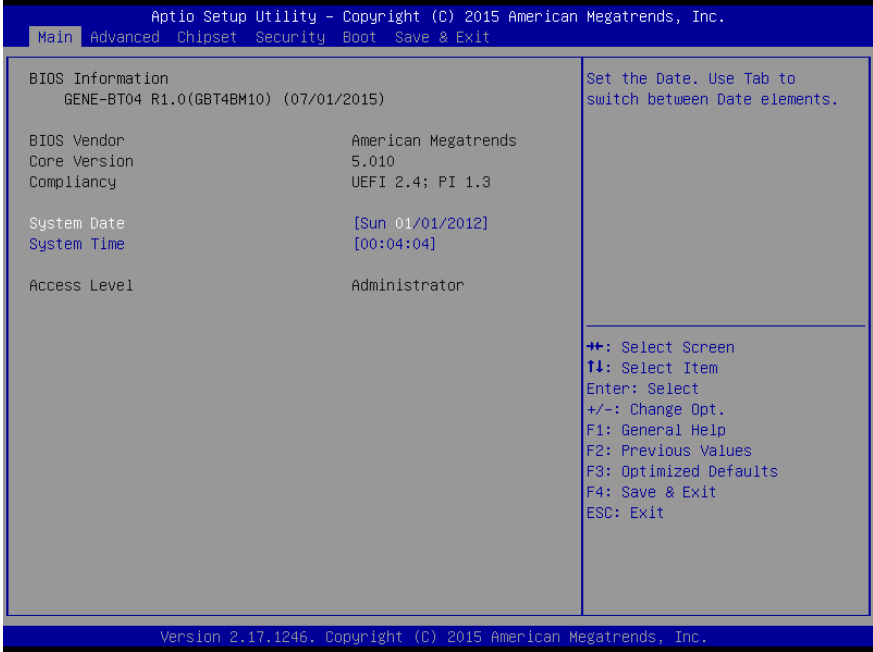

### 3.4 Setup submenu: Advanced

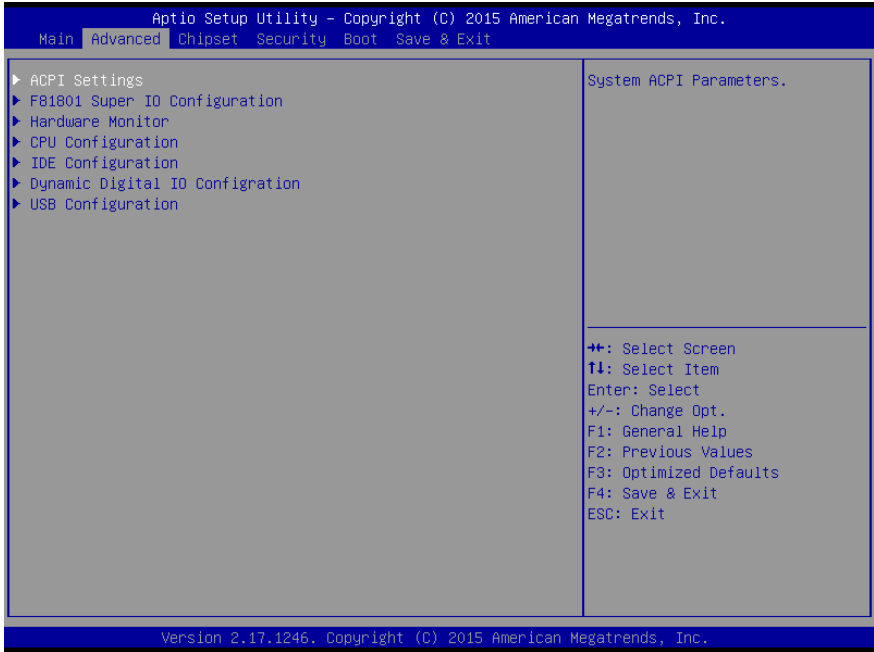

### 3.4.1 Advanced: ACPI Settings

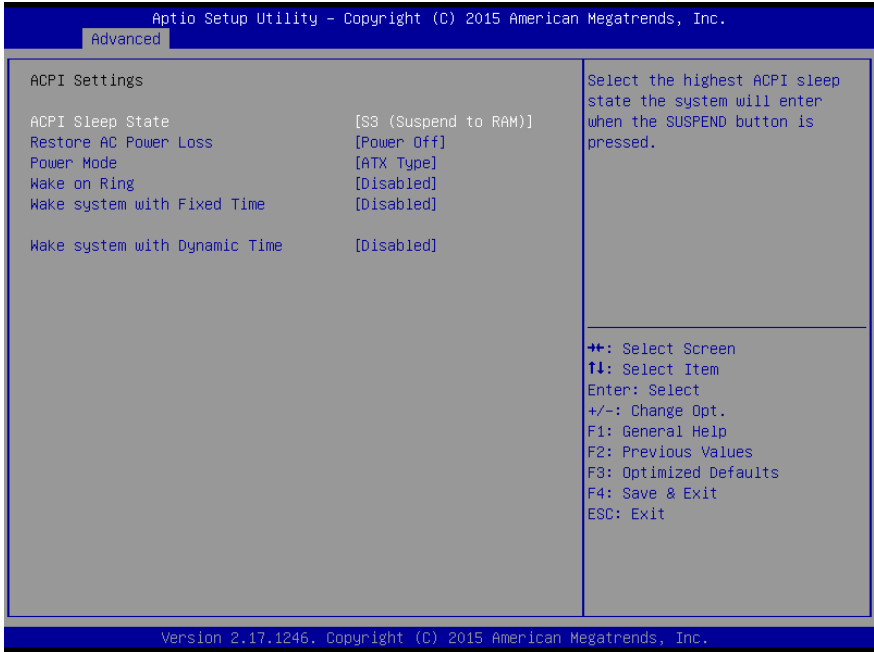

Options summary:

ACPI Sleep State	Suspend Disabled	Optimal Default, Failsafe Default
	S3 (Suspend to RAM)	
Select the highest ACPI sleep state the system will enter when the SUSPEND button is pressed.		
Restore AC Power	Power Off	Optimal Default, Failsafe Default
Loss	Power On	
	Last State	
Select AC power state when power is re-applied after a power failure		
Power Mode	ATX Type	Optimal Default, Failsafe Default

	AT Type	
Select power supply mode		
Wake on Ring	Disabled	Optimal Default, Failsafe Default
	Enabled	
En/Disabled wake from ring		
Wake system with Fixed Time	Disabled	Optimal Default, Failsafe Default
	Enabled	
Enable or disable System wake on alarm event. Wake up time is setting by following settings.		
Wake up day	0-31	
Select 0 for daily system wake up		
Wake up hour	0-23	
Wake up minute	0-59	
Wake up second	0-59	
Wake system with Dynamic Time	Disabled	Optimal Default, Failsafe Default
	Enabled	
Enable or disable System wake on alarm event. Wake up time is current time + Increase minutes.		
Wake up minute increase	1-5	

## 3.4.2 Advanced: F81801 Super IO Configuration

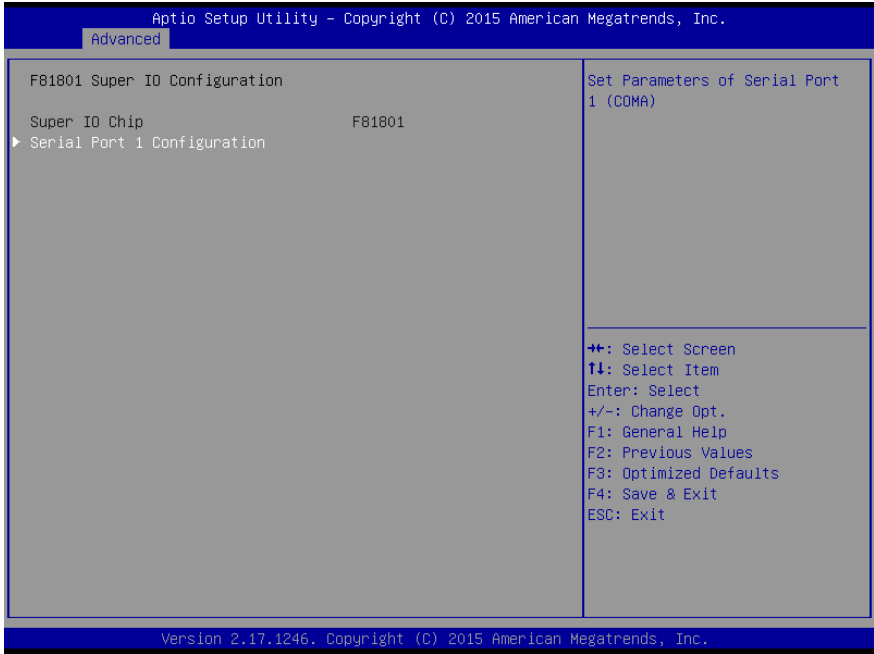

### 3.4.2.1 F81801 Super IO Configuration: Serial Port 1 Configuration

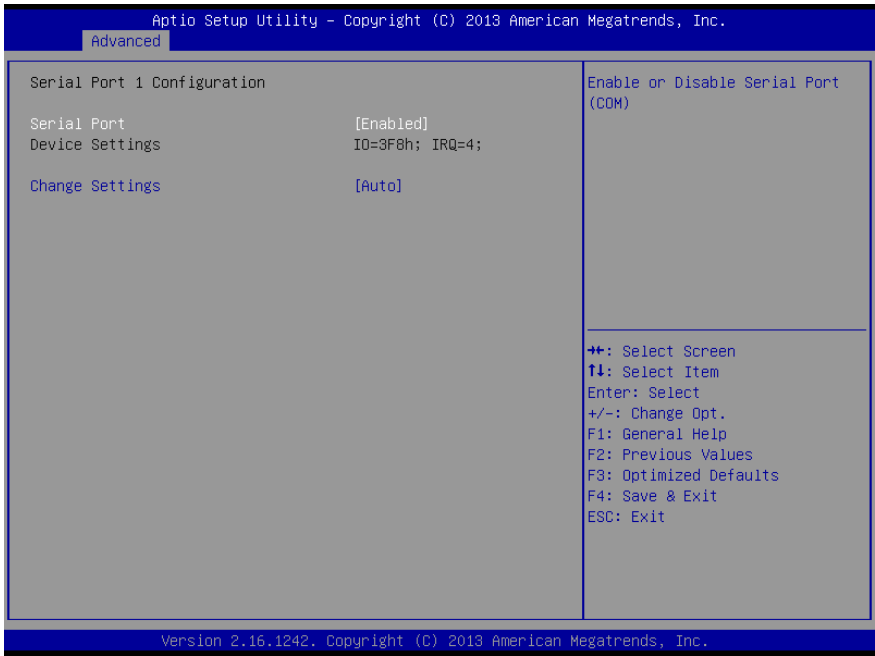

Options summary:

Serial Port	Disabled	Optimal Default, Failsafe Default
	Enabled	
Enable or Disable Serial Port (COM)		
Change Settings	Auto	Optimal Default, Failsafe Default
	IO = 3F8h; IRQ = 4	
	IO = 3F8h; IRQ = 3, 4, 5, 6, 7, 9, 10, 11, 12	
	IO = 2F8h; IRQ = 3, 4, 5, 6, 7, 9, 10, 11, 12	

	IO = 3E8h; IRQ = 3, 4, 5, 6, 7, 9, 10, 11, 12	
	IO = 2E8h; IRQ = 3, 4, 5, 6, 7, 9, 10, 11, 12	
Select an optimal settings for Super IO Device		



### 3.4.3 Advanced: H/W Monitor

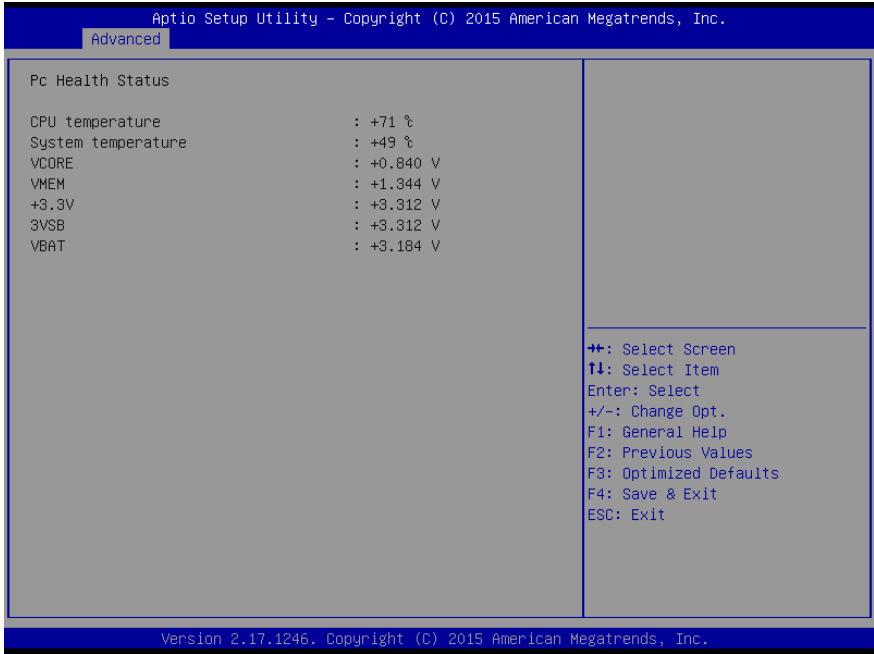

### 3.4.4 Advanced: CPU Configuration

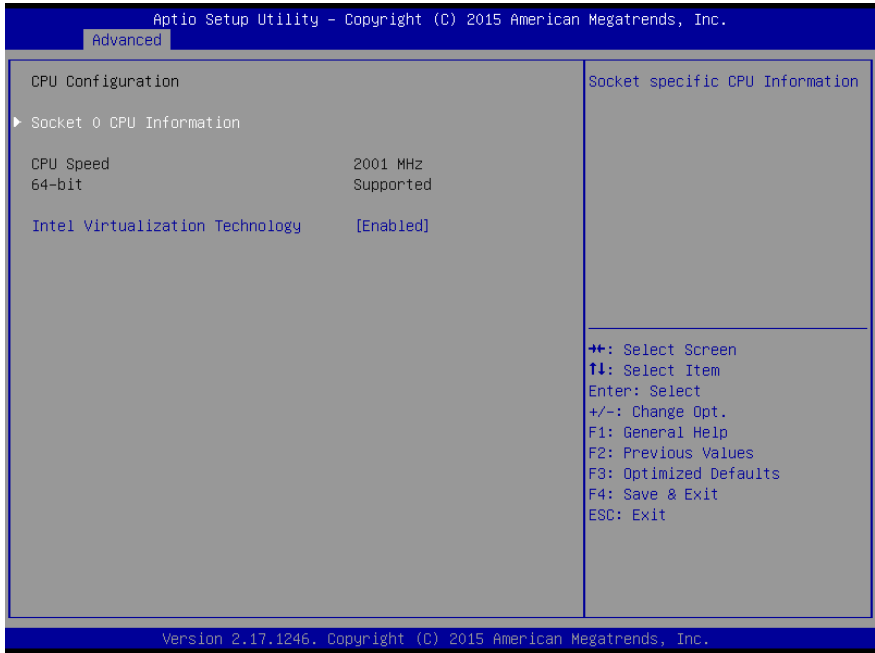

Options summary:

Intel Virtualization	Disabled	Optimal Default, Failsafe Default
Technology	Enabled	
When enabled, a VMM can utilize the additional hardware capabilities provided by Vander pool Technology		

### 3.4.4.1 CPU Configuration: Socket 0 CPU Configuration

The screenshot shows the Aptio Setup Utility interface. At the top, it reads "Aptio Setup Utility - Copyright (C) 2015 American Megatrends, Inc." Below this is a blue bar with the word "Advanced" in white. The main area is a grey window with a blue border. On the left, under the heading "Socket 0 CPU Information", the following details are listed:

Intel(R) Celeron(R) CPU J1900 @ 1.99GHz	
CPU Signature	30678
Microcode Patch	829
Max CPU Speed	1990 MHz
Min CPU Speed	1334 MHz
Processor Cores	4
Intel HT Technology	Not Supported
Intel VT-x Technology	Supported
L1 Data Cache	24 kB x 4
L1 Code Cache	32 kB x 4
L2 Cache	1024 kB x 2
L3 Cache	Not Present

On the right side of the grey window, a legend lists the following navigation options:

- +/: Select Screen
- ↑↓: Select Item
- Enter: Select
- +/-: Change Opt.
- F1: General Help
- F2: Previous Values
- F3: Optimized Defaults
- F4: Save & Exit
- ESC: Exit

At the bottom of the grey window, it reads "Version 2.17.1246. Copyright (C) 2015 American Megatrends, Inc."

### 3.4.5 Advanced: IDE Configuration



Options summary:

Serial-ATA (SATA)	Enabled	Default
	Disabled	
En/Disable SATA		
SATA Speed Support	Gen1	Default
	Gen2	
SATA Speed Support Gen1 or Gen2		
SATA Mode	IDE	Default
	AHCI	
IDE: Configure SATA controllers as legacy IDE		
AHCI: Configure SATA controllers to operate in AHCI mode		

Serial-ATA Port 0/1	Enabled	Default
	Disabled	
En/Disable SATA Port		
SATA Port 0/1 HotPlug	Enabled	Default
	Disabled	
En/Disable SATA Port Hotplug		

### 3.4.6 Advanced: Dynamic Digital IO Configuration

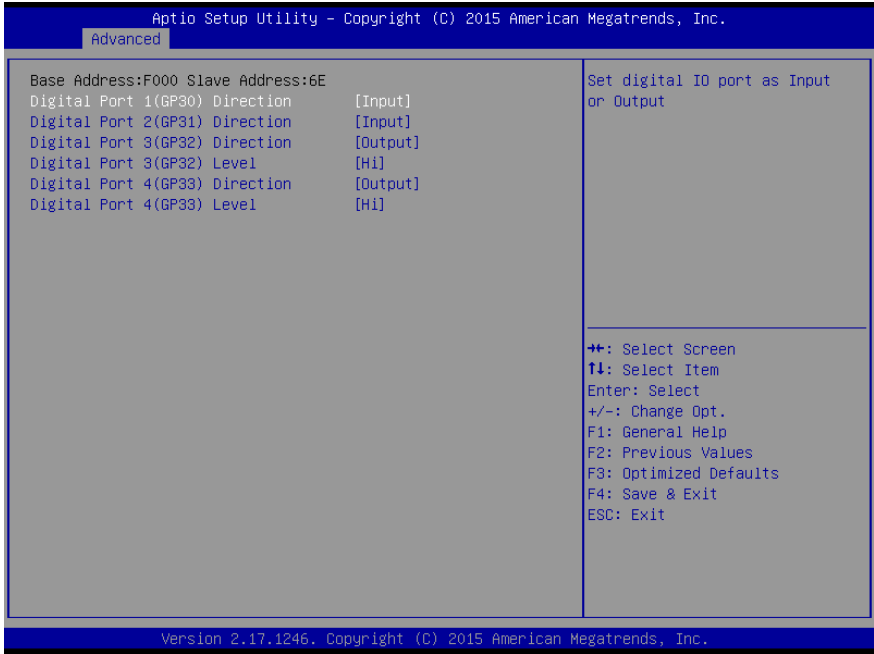

Options summary:

Digital Port 1 /2 (GP30/ GP31)	Input	Default
Direction	Output	
Set digital IO port as Input or Output		
Digital Port 3 /4 (GP32/ GP33) Direction	Input	Default
	Output	
Set digital IO port as Input or Output		
Digital Port 3 /4 (GP32/ GP33) Level	Hi	Default
	Low	
Set digital IO Output port as High or Low		

### 3.4.7 Advanced: USB Configuration

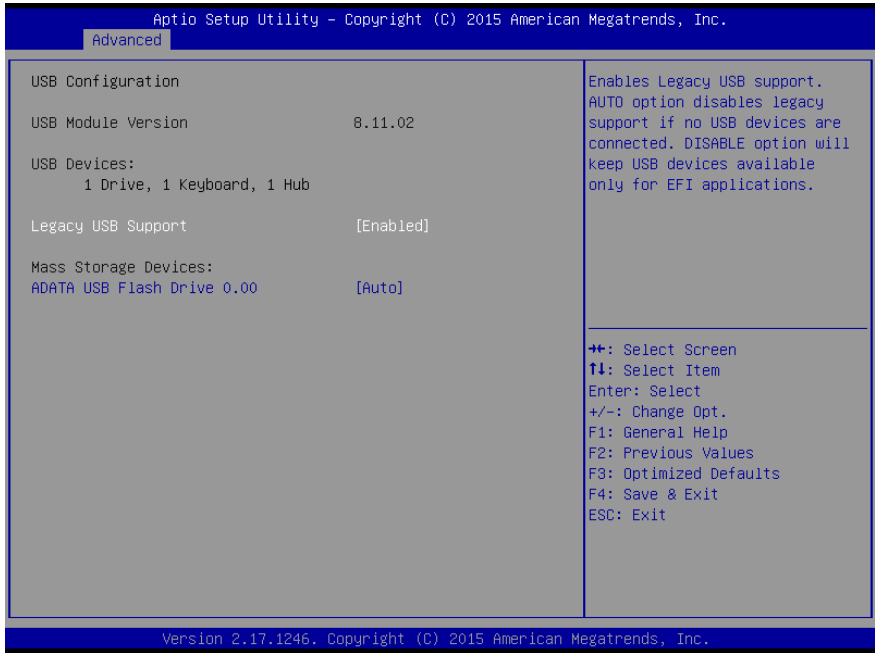

Options summary:

Legacy USB Support	Enabled	Optimal Default, Failsafe Default
	Disabled	
	Auto	
<p>Enables BIOS Support for Legacy USB Support. When enabled, USB can be functional in legacy environment like DOS.</p> <p>AUTO option disables legacy support if no USB devices are connected</p>		
Device Name (Emulation Type)	Auto	Optimal Default, Failsafe Default
	Floppy	
	Forced FDD	
	Hard Disk	

	CDROM	
If Auto. USB devices less than 530MB will be emulated as Floppy and remaining as Floppy and remaining as hard drive. Forced FDD option can be used to force a HDD formatted drive to boot as FDD(Ex. ZIP drive)		



### 3.5 Setup Submenu: Chipset

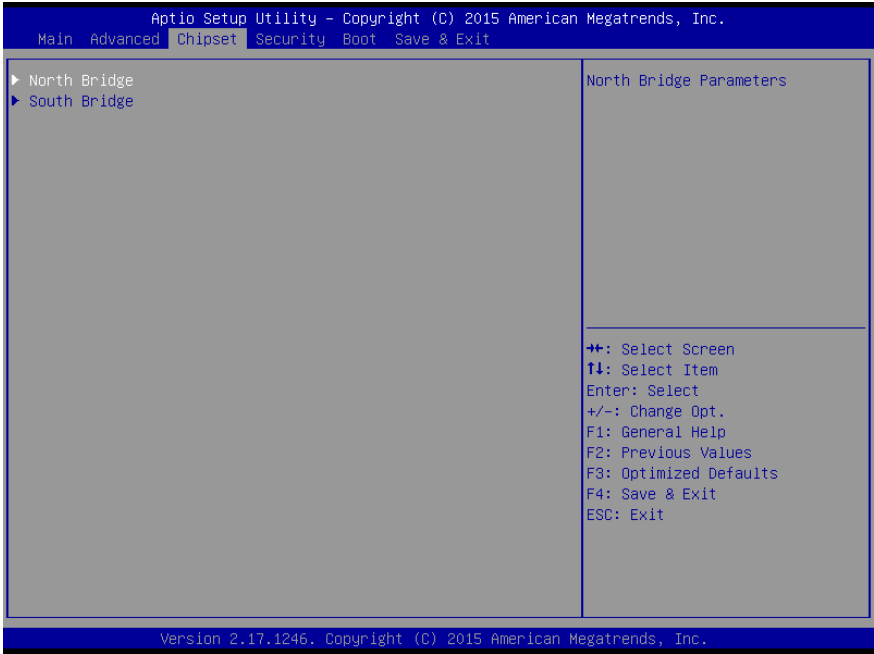

### 3.5.1 Chipset: Host Bridge

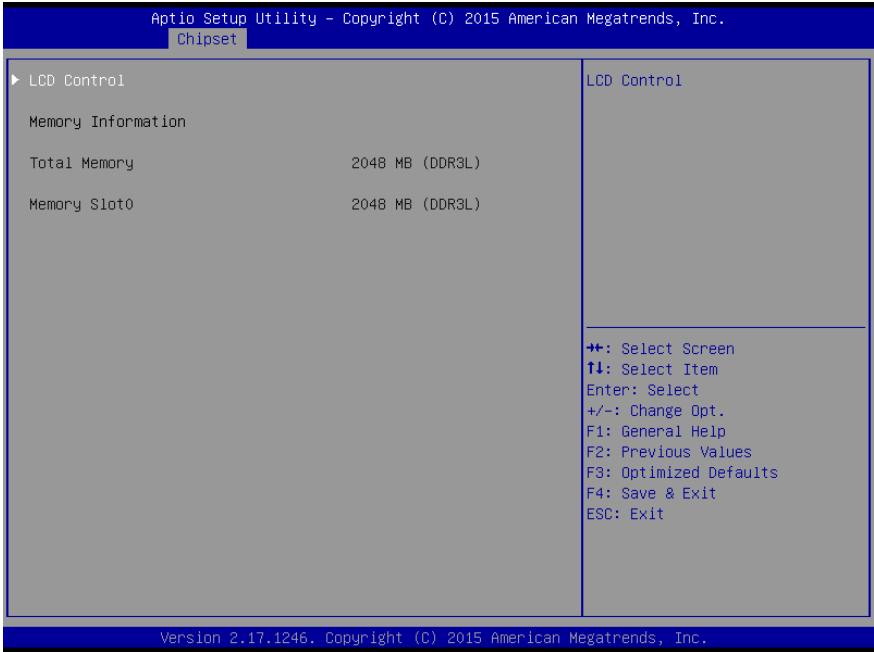

### 3.5.1.1 Host Bridge: LCD Control

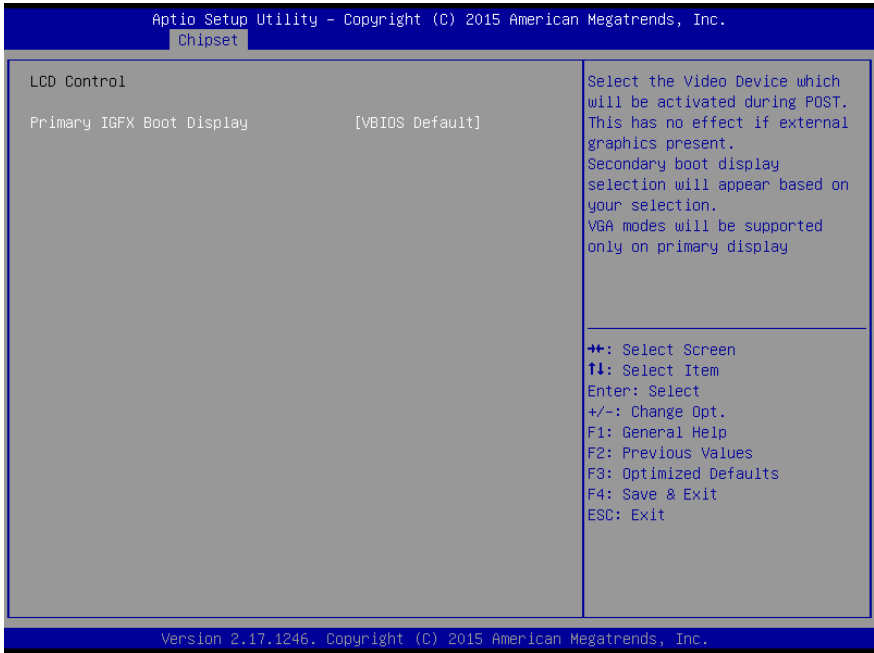

Options summary:

Primary IGFX Boot Display	VBIOS Default	Optimal Default, Failsafe Default
	HDMI1	
	HDMI2	

Select the Video device which will be activated during POST.  
 This has no effect if external graphics present.  
 Secondary boot display selection will appear based on your selection.  
 VGA modes will be supported only on primary display

### 3.5.2 Chipset: South Bridge

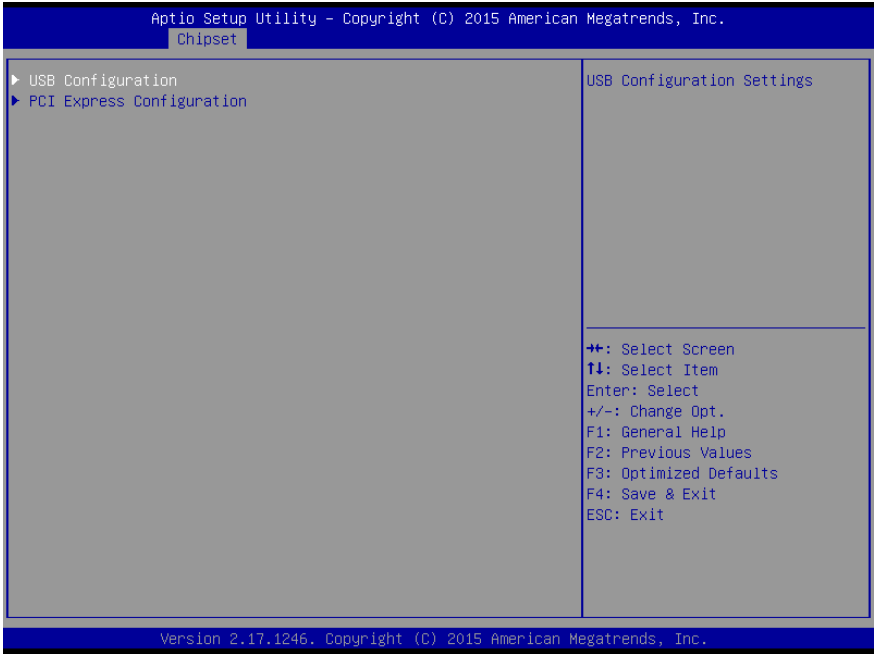

### 3.5.2.1 South Bridge: USB Configuration

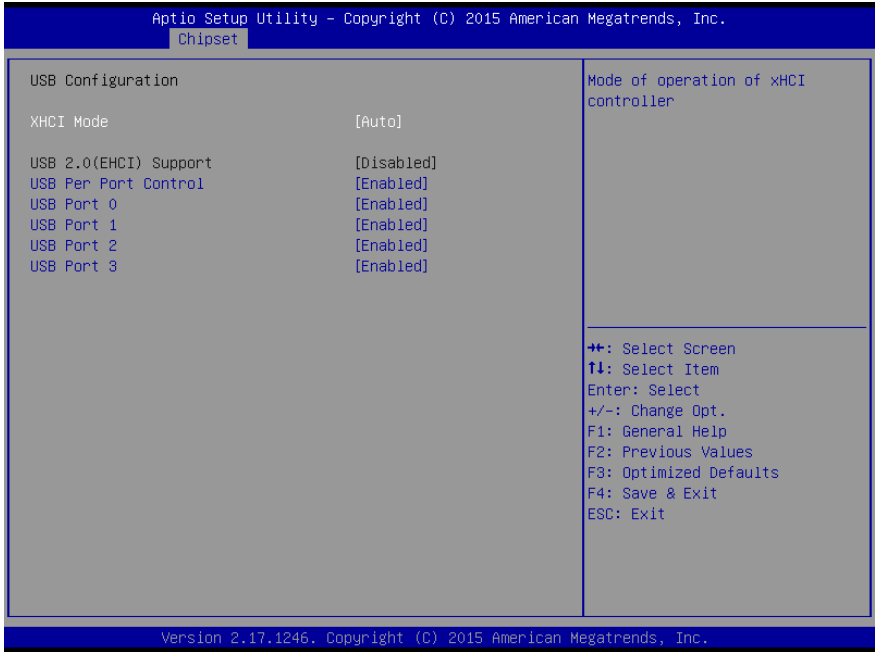

Options summary:

XHCI Mode	Enabled	Optimal Default, Failsafe Default
	Disabled	
	Auto	
	Smart Auto	
Mode of operation of XHCI controller		
USB Per Port Control	Enabled	Optimal Default, Failsafe Default
	Disabled	
Control each of the USB port(0~3)		
Enable: Enable USB per port		
Disable: Use USB port x settings		

USB Port 0/1/2/3	Enabled	Optimal Default, Failsafe Default
	Disabled	
Enable/Disable USB Port 0~3		

### 3.5.2.2 South Bridge: PCI Express Configuration

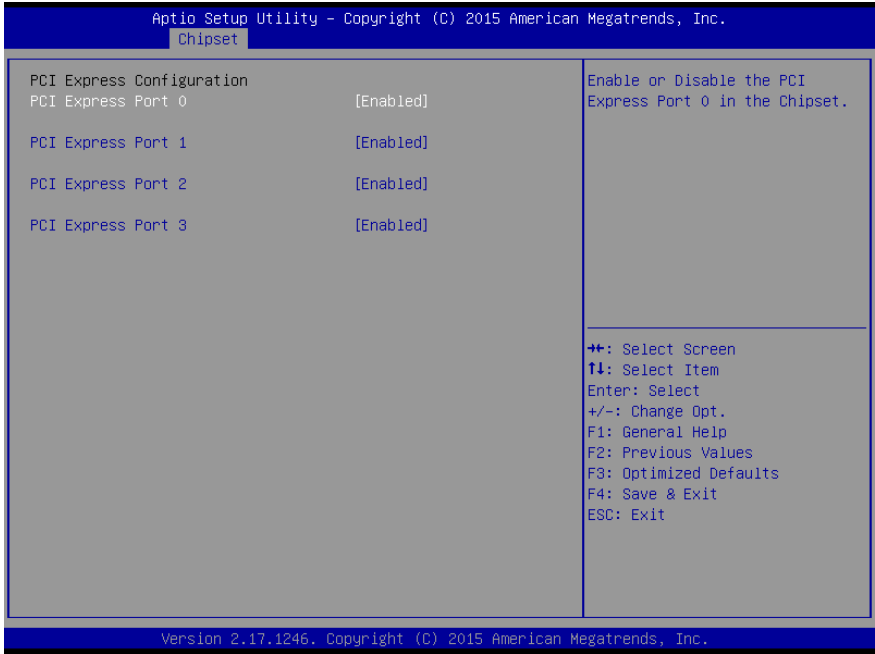

Options summary:

PCI Express Port 0/1/2/3	Enabled	Optimal Default, Failsafe Default
	Disabled	
Enable or Disable the PCI Express Port 0~3 in the Chipset.		

## 3.6 Setup submenu: Security

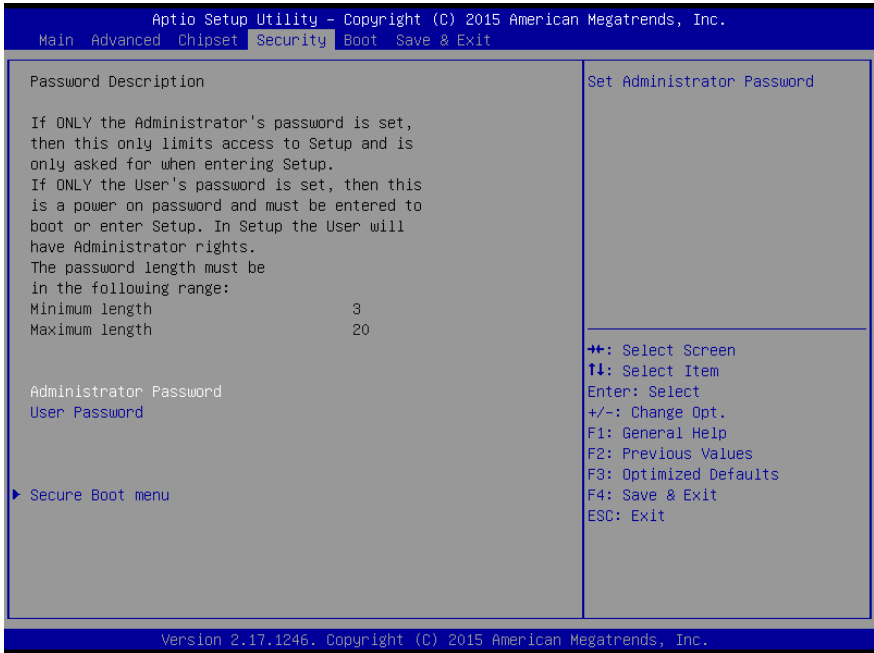

### Change User/Administrator Password

You can set a User Password once an Administrator Password is set. The password will be required during boot up, or when the user enters the Setup utility. Please Note that a User Password does not provide access to many of the features in the Setup utility.

Select the password you wish to set, press Enter to open a dialog box to enter your password (you can enter no more than six letters or numbers). Press Enter to confirm your entry, after which you will be prompted to retype your password for a final confirmation. Press Enter again after you have retyped it correctly.



## Removing the Password

Highlight this item and type in the current password. At the next dialog box press Enter to disable password protection.

### 3.6.1 Security: Secure Boot

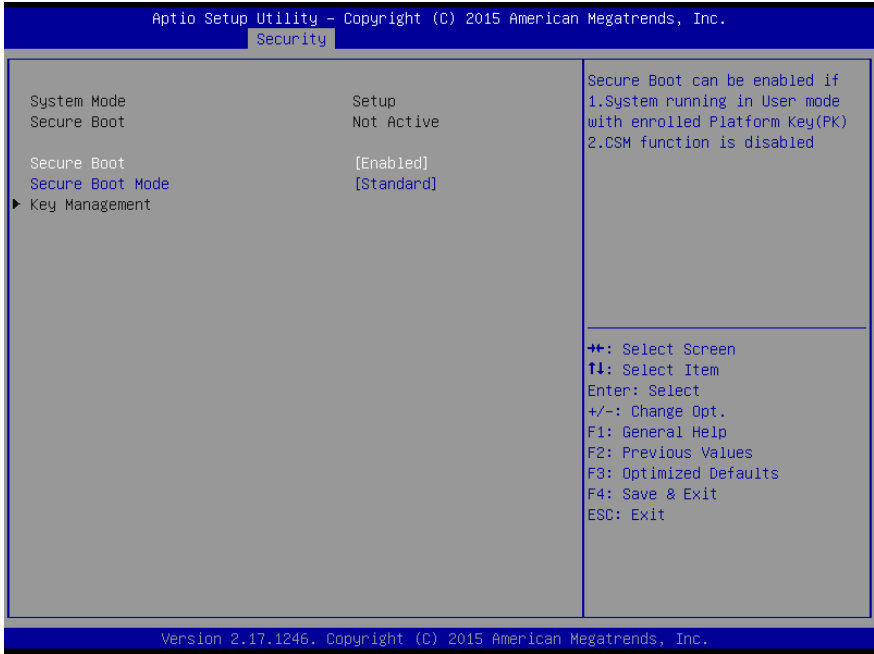

Options summary:

Secure Boot	Disabled	Optimal Default, Failsafe Default
	Enabled	
Secure Boot can be enabled if		
1. System running in user mode with enrolled platform key (PK)		
2. CSM function is disabled		
Secure Boot Mode	Standard	Optimal Default, Failsafe Default
	Custom	
Secure Boot mode selector:		
'Custom' Mode enables users to change Image Execution policy and manage Secure boot keys.		

### 3.7 Setup submenu: Boot

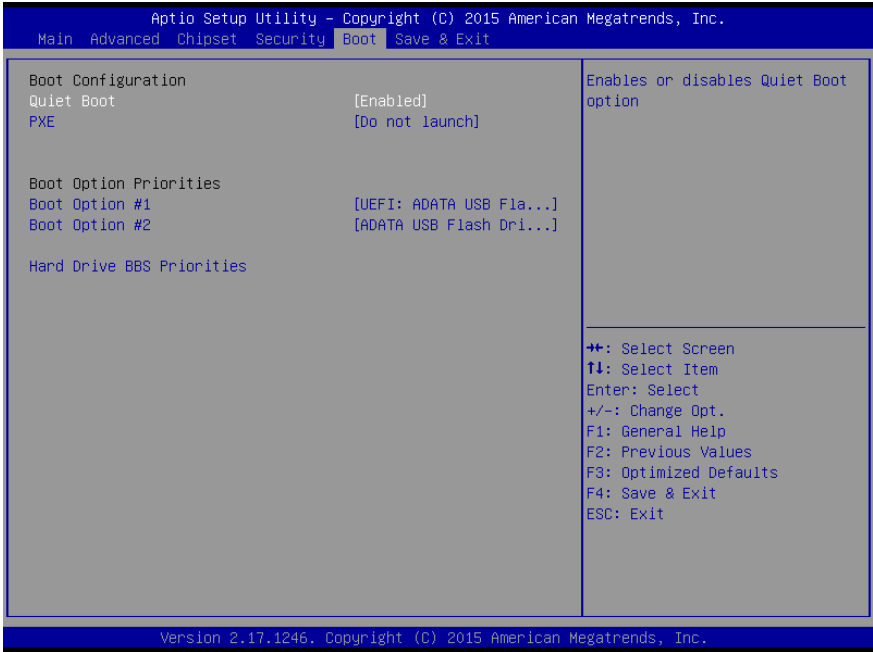

Options summary:

Quiet Boot	Disabled	Default
	Enabled	
En/Disable showing boot logo.		
PXE	Do not launch	Default
	Enabled	
En/Disable PXE boot		

### 3.8 Setup submenu: Save & Exit

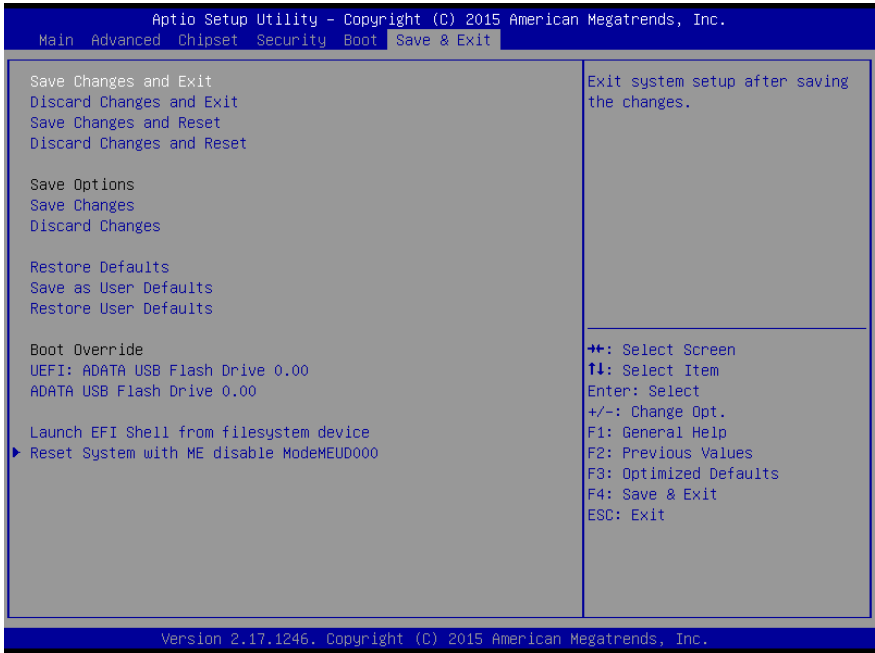

# Chapter 4

---

Drivers Installation

## 4.1 Product CD/DVD

---

The GENE-BT04 comes with a product DVD that contains all the drivers and utilities you need to setup your product. Insert the DVD and follow the steps in the autorun program to install the drivers.

In case the program does not start, follow the sequence below to install the drivers.

### Step 1 – Install Chipset Drivers

1. Open the **Step1 - Chipset** folder and select your OS
2. Open the **SetupChipset.exe** file in the folder
3. Follow the instructions
4. Drivers will be installed automatically

### Step 2 – Install Graphics Driver

1. Open the **Step2 - VGA** folder and select your OS
2. Open the **Setup.exe** file in the folder
3. Follow the instructions
4. Drivers will be installed automatically

### Step 3 – Install LAN Driver

1. Click on the **Step3 - LAN** folder and select your OS
2. Open the **.exe** file in the folder
3. Follow the instructions
4. Drivers will be installed automatically

### Step 4 – Install TXE Drivers (Windows 8.1/10 only)

1. Open the **Step4 - TXE** folder and select your OS

2. Open the **SetupTXE.exe** file in the folder
3. Follow the instructions
4. Drivers will be installed automatically

#### Step 5 – Install USB 3.0 Driver (Windows 7 only)

1. Open the **Step5 - USB3.0** folder followed by **Setup.exe**
2. Follow the instructions
3. Drivers will be installed automatically

#### Step 6 – Install MBI Driver

1. Open the **Step6 - MBI** folder and select your OS
2. Open the **Setup.exe** file in the folder
3. Follow the instructions
4. Drivers will be installed automatically

# Appendix A

---

## Watchdog Timer Programming



## A.1 Watchdog Timer Registers

Table 1 : Watch dog relative IO address		
	Default Value	Note
I/O Base Address	0xA00	I/O Base address for Watchdog operation. This address is assigned by SIO LDN7, register 0x60-0x61.

Table 2 : Watchdog relative register table				
Register	Offset	BitNum	Value	Note
Watchdog WDRST# Enable	0x00	7	1	Enable/Disable time out output via WDRST# 0: Disable 1: Enable
Pulse Width	0x05	0:1	01	Width of Pulse signal 00: 1ms (do not use) 01: 25ms 10: 125ms 11: 5s <b><i>Pulse width is must longer then 16ms.</i></b>
Signal Polarity	0x05	2	0	0: low active 1: high active <b><i>Must set this bit to 0</i></b>
Counting Unit	0x05	3	0	Select time unit. 0: second 1: minute
Output Signal Type	0x05	4	1	0: Level 1: Pulse <b><i>Must set this bit to 1</i></b>
Watchdog Timer Enable	0x05	5	1	0: Disable 1: Enable
Timeout Status	0x05	6	1	1: timeout occurred. Write a 1 to clear timeout status
Timer Counter	0x06			Time of watchdog timer (0~255)

## A.2 Watchdog Sample Program

```
*****
// WDT I/O operation relative definition (Please reference to Table 1)
#define WDTAddr    0xA00 // WDT I/O base address
Void  WDTWriteByte(byte Register, byte Value);
byte  WDTReadByte(byte Register);
Void  WDTSetReg(byte Register, byte Bit, byte Val);
// Watch Dog relative definition (Please reference to Table 2)
#define DevReg     0x00 // Device configuration register
    #define WDRstBit 0x80 // Watchdog WDTRST# (Bit7)
    #define WDRstVal 0x80 // Enabled WDTRST#
#define TimerReg   0x05 // Timer register
    #define PSWidthBit 0x00 // WDTRST# Pulse width (Bit0:1)
    #define PSWidthVal 0x01 // 25ms for WDTRST# pulse
    #define PolarityBit 0x02 // WDTRST# Signal polarity (Bit2)
    #define PolarityVal 0x00 // Low active for WDTRST#
    #define UnitBit    0x03 // Unit for timer (Bit3)
    #define ModeBit    0x04 // WDTRST# mode (Bit4)
    #define ModeVal    0x01 // 0:level 1: pulse
    #define EnableBit  0x05 // WDT timer enable (Bit5)
    #define EnableVal  0x01 // 1: enable
    #define StatusBit  0x06 // WDT timer status (Bit6)
#define CounterReg 0x06 // Timer counter register
*****

VOID  Main(){
    // Procedure : AaeonWDTConfig
    // (byte)Timer : Counter of WDT timer.(0x00~0xFF)
    // (boolean)Unit : Select time unit(0: second, 1: minute).
    AaeonWDTConfig(Counter, Unit);

    // Procedure : AaeonWDTEnable
    // This procedure will enable the WDT counting.
    AaeonWDTEnable();
}
*****

// Procedure : AaeonWDTEnable
```

```

VOID AaeonWDTEnable (){
    WDTEnableDisable(1);
}

// Procedure : AaeonWDTConfig
VOID AaeonWDTConfig (byte Counter, BOOLEAN Unit){
    // Disable WDT counting
    WDTEnableDisable(0);
    // Clear Watchdog Timeout Status
    WDTClearTimeoutStatus();
    // WDT relative parameter setting
    WDTParameterSetting(Timer, Unit);
}

VOID WDTEnableDisable(byte Value){
    If (Value == 1)
        WDTSetBit(TimerReg, EnableBit, 1);
    else
        WDTSetBit(TimerReg, EnableBit, 0);
}

VOID WDTParameterSetting(byte Counter, BOOLEAN Unit){
    // Watchdog Timer counter setting
    WDTWriteByte(CounterReg, Counter);
    // WDT counting unit setting
    WDTSetBit(TimerReg, UnitBit, Unit);
    // WDT output mode set to pulse
    WDTSetBit(TimerReg, ModeBit, ModeVal);
    // WDT output mode set to active low
    WDTSetBit(TimerReg, PolarityBit, PolarityVal);
    // WDT output pulse width is 25ms
    WDTSetBit(TimerReg, PSWidthBit, PSWidthVal);
    // Watchdog WDTRST# Enable
    WDTSetBit(DevReg, WDTRstBit, WDTRstVal);
}

VOID WDTClearTimeoutStatus(){
    WDTSetBit(TimerReg, StatusBit, 1);
}

*****
*****

```

```
VOID  WDTWriteByte(byte Register, byte Value){
    IOWriteByte(WDTAddr+Register, Value);
}

byte  WDTReadByte(byte Register){
    return IOReadByte(WDTAddr+Register);
}

VOID  WDTSetBit(byte Register, byte Bit, byte Val){
    byte TmpValue;

    TmpValue = WDTReadByte(Register);
    TmpValue &= ~(1 << Bit);
    TmpValue |= Val << Bit;
    WDTWriteByte(Register, TmpValue);
}
```

```
*****
```









































# Appendix B













---

I/O Information

## B.1 I/O Address Map

Note: There is no PS/2 interface on the GENE-BT04, hence the exclamation marks

- ▼  Input/output (IO)
  -  [00000000 - 0000006F] PCI Express Root Complex
  -  [00000020 - 00000021] Programmable interrupt controller
  -  [00000024 - 00000025] Programmable interrupt controller
  -  [00000028 - 00000029] Programmable interrupt controller
  -  [0000002C - 0000002D] Programmable interrupt controller
  -  [0000002E - 0000002F] Motherboard resources
  -  [00000030 - 00000031] Programmable interrupt controller
  -  [00000034 - 00000035] Programmable interrupt controller
  -  [00000038 - 00000039] Programmable interrupt controller
  -  [0000003C - 0000003D] Programmable interrupt controller
  -  [00000040 - 00000043] System timer
  -  [0000004E - 0000004F] Motherboard resources
  -  [00000050 - 00000053] System timer
  -  [00000060 - 00000060] Standard PS/2 Keyboard
  -  [00000061 - 00000061] Motherboard resources
  -  [00000063 - 00000063] Motherboard resources
  -  [00000064 - 00000064] Standard PS/2 Keyboard
  -  [00000065 - 00000065] Motherboard resources
  -  [00000067 - 00000067] Motherboard resources
  -  [00000070 - 00000070] Motherboard resources
  -  [00000070 - 00000077] System CMOS/real time clock
  -  [00000078 - 0000CF7] PCI Express Root Complex
  -  [00000080 - 0000008F] Motherboard resources
  -  [00000092 - 00000092] Motherboard resources
  -  [000000A0 - 000000A1] Programmable interrupt controller
  -  [000000A4 - 000000A5] Programmable interrupt controller
  -  [000000A8 - 000000A9] Programmable interrupt controller
  -  [000000AC - 000000AD] Programmable interrupt controller
  -  [000000B0 - 000000B1] Programmable interrupt controller
  -  [000000B2 - 000000B3] Motherboard resources
  -  [000000B4 - 000000B5] Programmable interrupt controller
  -  [000000B8 - 000000B9] Programmable interrupt controller
  -  [000000BC - 000000BD] Programmable interrupt controller
  -  [000002C8 - 000002CF] Communications Port (COM10)
  -  [000002D8 - 000002DF] Communications Port (COM9)
  -  [000003B0 - 000003BB] Intel(R) HD Graphics
  -  [000003C0 - 000003DF] Intel(R) HD Graphics
  -  [000003F8 - 000003FF] Communications Port (COM1)
  -  [00000400 - 0000047F] Motherboard resources

-  [000004D0 - 000004D1] Programmable interrupt controller
-  [00000500 - 000005FE] Motherboard resources
-  [00000600 - 0000061F] Motherboard resources
-  [00000680 - 0000069F] Motherboard resources
-  [00000A00 - 00000A0F] Motherboard resources
-  [00000A10 - 00000A1F] Motherboard resources
-  [00000D00 - 0000FFFF] PCI Express Root Complex
-  [0000B000 - 0000BFFF] Intel(R) Atom(TM)/Celeron(R)/Pentium(R) Processor PCI Express - Root Port 4 - 0F4E
-  [0000C000 - 0000CFFF] Intel(R) Atom(TM)/Celeron(R)/Pentium(R) Processor PCI Express - Root Port 3 - 0F4C
-  [0000D000 - 0000DFFF] Intel(R) Atom(TM)/Celeron(R)/Pentium(R) Processor PCI Express - Root Port 2 - 0F4A
-  [0000E000 - 0000EFFF] Intel(R) Atom(TM)/Celeron(R)/Pentium(R) Processor PCI Express - Root Port 1 - 0F48
-  [0000F000 - 0000F01F] Intel(R) Atom(TM)/Celeron(R)/Pentium(R) Processor Platform Control Unit - SMBus Port - 0F12
-  [0000F080 - 0000F087] Intel(R) HD Graphics









































## B.2 Memory Address Map







































Address Range	Device Name
[000A0000 - 000BFFFF]	Intel(R) HD Graphics
[000A0000 - 000BFFFF]	PCI Express Root Complex
[000C0000 - 000DFFFF]	PCI Express Root Complex
[000E0000 - 000FFFFFF]	PCI Express Root Complex
[C0000000 - CFFFFFFF]	Intel(R) HD Graphics
[C0000000 - D0A16FFF]	PCI Express Root Complex
[D0000000 - D03FFFFF]	Intel(R) HD Graphics
[D0400000 - D04FFFFF]	Intel(R) Trusted Execution Engine Interface
[D0500000 - D05FFFFF]	Intel(R) Trusted Execution Engine Interface
[D0600000 - D061FFFF]	Intel(R) I211 Gigabit Network Connection
[D0600000 - D06FFFFFF]	Intel(R) Atom(TM)/Celeron(R)/Pentium(R) Processor PCI Express - Root Port 4 - 0F4E
[D0620000 - D0623FFF]	Intel(R) I211 Gigabit Network Connection
[D0700000 - D071FFFF]	Intel(R) I211 Gigabit Network Connection #2
[D0700000 - D07FFFFFF]	Intel(R) Atom(TM)/Celeron(R)/Pentium(R) Processor PCI Express - Root Port 3 - 0F4C
[D0710000 - D0713FFF]	High Definition Audio Controller
[D0720000 - D0723FFF]	Intel(R) I211 Gigabit Network Connection #2
[D0800000 - D081FFFF]	Intel(R) I211 Gigabit Network Connection #3
[D0800000 - D08FFFFFF]	Intel(R) Atom(TM)/Celeron(R)/Pentium(R) Processor PCI Express - Root Port 2 - 0F4A
[D0820000 - D0823FFF]	Intel(R) I211 Gigabit Network Connection #3
[D0900000 - D091FFFF]	Intel(R) I211 Gigabit Network Connection #4
[D0900000 - D09FFFFFF]	Intel(R) Atom(TM)/Celeron(R)/Pentium(R) Processor PCI Express - Root Port 1 - 0F48
[D0920000 - D0923FFF]	Intel(R) I211 Gigabit Network Connection #4
[D0A00000 - D0A0FFFF]	Intel(R) USB 3.0 eXtensible Host Controller - 1.0 (Microsoft)
[D0A10000 - D0A13FFF]	High Definition Audio Controller
[D0A14000 - D0A1401F]	Intel(R) Atom(TM)/Celeron(R)/Pentium(R) Processor Platform Control Unit - SMBus Port - 0F12
[D0A16000 - D0A167FF]	Standard SATA AHCI Controller
[E0000000 - EFFFFFFF]	Motherboard resources
[E00000D0 - E00000DB]	Intel(R) Sideband Fabric Device
[FED00000 - FED003FF]	High precision event timer
[FED01000 - FED01FFF]	Motherboard resources
[FED03000 - FED03FFF]	Motherboard resources
[FED04000 - FED04FFF]	Motherboard resources
[FED08000 - FED08FFF]	Motherboard resources
[FED0C000 - FED0FFFF]	Motherboard resources
[FED1C000 - FED1CFFF]	Motherboard resources
[FEE00000 - FEEFFFFFFF]	Motherboard resources
[FEF00000 - FEFFFFFFFF]	Motherboard resources
[FF000000 - FFFFFFFF]	Device





















































































## B.3 IRQ Mapping Chart











































Note: There is no PS/2 interface on the GENE-BT04, hence the exclamation marks

▼		Interrupt request (IRQ)	
		(ISA) 0x00000000 (00)	System timer
		(ISA) 0x00000001 (01)	Standard PS/2 Keyboard
		(ISA) 0x00000003 (03)	High Definition Audio Controller
		(ISA) 0x00000004 (04)	Communications Port (COM1)
		(ISA) 0x00000008 (08)	High precision event timer
		(ISA) 0x0000000A (10)	Communications Port (COM10)
		(ISA) 0x0000000B (11)	Communications Port (COM9)
		(ISA) 0x0000000C (12)	PS/2 Compatible Mouse
		(ISA) 0x00000036 (54)	Microsoft ACPI-Compliant System
		(ISA) 0x00000037 (55)	Microsoft ACPI-Compliant System
		(ISA) 0x00000038 (56)	Microsoft ACPI-Compliant System
		(ISA) 0x00000039 (57)	Microsoft ACPI-Compliant System
		(ISA) 0x0000003A (58)	Microsoft ACPI-Compliant System
		(ISA) 0x0000003B (59)	Microsoft ACPI-Compliant System
		(ISA) 0x0000003C (60)	Microsoft ACPI-Compliant System
		(ISA) 0x0000003D (61)	Microsoft ACPI-Compliant System
		(ISA) 0x0000003E (62)	Microsoft ACPI-Compliant System
		(ISA) 0x0000003F (63)	Microsoft ACPI-Compliant System
		(ISA) 0x00000040 (64)	Microsoft ACPI-Compliant System
		(ISA) 0x00000041 (65)	Microsoft ACPI-Compliant System
		(ISA) 0x00000042 (66)	Microsoft ACPI-Compliant System
		(ISA) 0x00000043 (67)	Microsoft ACPI-Compliant System
		(ISA) 0x00000044 (68)	Microsoft ACPI-Compliant System
		(ISA) 0x00000045 (69)	Microsoft ACPI-Compliant System
		(ISA) 0x00000046 (70)	Microsoft ACPI-Compliant System
		(ISA) 0x00000047 (71)	Microsoft ACPI-Compliant System
		(ISA) 0x00000048 (72)	Microsoft ACPI-Compliant System
		(ISA) 0x00000049 (73)	Microsoft ACPI-Compliant System
		(ISA) 0x0000004A (74)	Microsoft ACPI-Compliant System
		(ISA) 0x0000004B (75)	Microsoft ACPI-Compliant System
		(ISA) 0x0000004C (76)	Microsoft ACPI-Compliant System
		(ISA) 0x0000004D (77)	Microsoft ACPI-Compliant System
		(ISA) 0x0000004E (78)	Microsoft ACPI-Compliant System
		(ISA) 0x0000004F (79)	Microsoft ACPI-Compliant System
		(ISA) 0x00000050 (80)	Microsoft ACPI-Compliant System
		(ISA) 0x00000051 (81)	Microsoft ACPI-Compliant System
		(ISA) 0x00000052 (82)	Microsoft ACPI-Compliant System
		(ISA) 0x00000053 (83)	Microsoft ACPI-Compliant System
		(ISA) 0x00000054 (84)	Microsoft ACPI-Compliant System
		(ISA) 0x00000055 (85)	Microsoft ACPI-Compliant System











































 (ISA) 0x00000056 (86)	Microsoft ACPI-Compliant System
 (ISA) 0x00000057 (87)	Microsoft ACPI-Compliant System
 (ISA) 0x00000058 (88)	Microsoft ACPI-Compliant System
 (ISA) 0x00000059 (89)	Microsoft ACPI-Compliant System
 (ISA) 0x0000005A (90)	Microsoft ACPI-Compliant System
 (ISA) 0x0000005B (91)	Microsoft ACPI-Compliant System
 (ISA) 0x0000005C (92)	Microsoft ACPI-Compliant System
 (ISA) 0x0000005D (93)	Microsoft ACPI-Compliant System
 (ISA) 0x0000005E (94)	Microsoft ACPI-Compliant System
 (ISA) 0x0000005F (95)	Microsoft ACPI-Compliant System
 (ISA) 0x00000060 (96)	Microsoft ACPI-Compliant System
 (ISA) 0x00000061 (97)	Microsoft ACPI-Compliant System
 (ISA) 0x00000062 (98)	Microsoft ACPI-Compliant System
 (ISA) 0x00000063 (99)	Microsoft ACPI-Compliant System
 (ISA) 0x00000064 (100)	Microsoft ACPI-Compliant System
 (ISA) 0x00000065 (101)	Microsoft ACPI-Compliant System
 (ISA) 0x00000066 (102)	Microsoft ACPI-Compliant System
 (ISA) 0x00000067 (103)	Microsoft ACPI-Compliant System
 (ISA) 0x00000068 (104)	Microsoft ACPI-Compliant System
 (ISA) 0x00000069 (105)	Microsoft ACPI-Compliant System
 (ISA) 0x0000006A (106)	Microsoft ACPI-Compliant System
 (ISA) 0x0000006B (107)	Microsoft ACPI-Compliant System
 (ISA) 0x0000006C (108)	Microsoft ACPI-Compliant System
 (ISA) 0x0000006D (109)	Microsoft ACPI-Compliant System
 (ISA) 0x0000006E (110)	Microsoft ACPI-Compliant System
 (ISA) 0x0000006F (111)	Microsoft ACPI-Compliant System
 (ISA) 0x00000070 (112)	Microsoft ACPI-Compliant System
 (ISA) 0x00000071 (113)	Microsoft ACPI-Compliant System
 (ISA) 0x00000072 (114)	Microsoft ACPI-Compliant System
 (ISA) 0x00000073 (115)	Microsoft ACPI-Compliant System
 (ISA) 0x00000074 (116)	Microsoft ACPI-Compliant System
 (ISA) 0x00000075 (117)	Microsoft ACPI-Compliant System
 (ISA) 0x00000076 (118)	Microsoft ACPI-Compliant System
 (ISA) 0x00000077 (119)	Microsoft ACPI-Compliant System
 (ISA) 0x00000078 (120)	Microsoft ACPI-Compliant System
 (ISA) 0x00000079 (121)	Microsoft ACPI-Compliant System
 (ISA) 0x0000007A (122)	Microsoft ACPI-Compliant System
 (ISA) 0x0000007B (123)	Microsoft ACPI-Compliant System
 (ISA) 0x0000007C (124)	Microsoft ACPI-Compliant System

 (ISA) 0x0000007D (125)	Microsoft ACPI-Compliant System
 (ISA) 0x0000007E (126)	Microsoft ACPI-Compliant System
 (ISA) 0x0000007F (127)	Microsoft ACPI-Compliant System
 (ISA) 0x00000080 (128)	Microsoft ACPI-Compliant System
 (ISA) 0x00000081 (129)	Microsoft ACPI-Compliant System
 (ISA) 0x00000082 (130)	Microsoft ACPI-Compliant System
 (ISA) 0x00000083 (131)	Microsoft ACPI-Compliant System
 (ISA) 0x00000084 (132)	Microsoft ACPI-Compliant System
 (ISA) 0x00000085 (133)	Microsoft ACPI-Compliant System
 (ISA) 0x00000086 (134)	Microsoft ACPI-Compliant System
 (ISA) 0x00000087 (135)	Microsoft ACPI-Compliant System
 (ISA) 0x00000088 (136)	Microsoft ACPI-Compliant System
 (ISA) 0x00000089 (137)	Microsoft ACPI-Compliant System
 (ISA) 0x0000008A (138)	Microsoft ACPI-Compliant System
 (ISA) 0x0000008B (139)	Microsoft ACPI-Compliant System
 (ISA) 0x0000008C (140)	Microsoft ACPI-Compliant System
 (ISA) 0x0000008D (141)	Microsoft ACPI-Compliant System
 (ISA) 0x0000008E (142)	Microsoft ACPI-Compliant System
 (ISA) 0x0000008F (143)	Microsoft ACPI-Compliant System
 (ISA) 0x00000090 (144)	Microsoft ACPI-Compliant System
 (ISA) 0x00000091 (145)	Microsoft ACPI-Compliant System
 (ISA) 0x00000092 (146)	Microsoft ACPI-Compliant System
 (ISA) 0x00000093 (147)	Microsoft ACPI-Compliant System
 (ISA) 0x00000094 (148)	Microsoft ACPI-Compliant System
 (ISA) 0x00000095 (149)	Microsoft ACPI-Compliant System
 (ISA) 0x00000096 (150)	Microsoft ACPI-Compliant System
 (ISA) 0x00000097 (151)	Microsoft ACPI-Compliant System
 (ISA) 0x00000098 (152)	Microsoft ACPI-Compliant System
 (ISA) 0x00000099 (153)	Microsoft ACPI-Compliant System
 (ISA) 0x0000009A (154)	Microsoft ACPI-Compliant System
 (ISA) 0x0000009B (155)	Microsoft ACPI-Compliant System
 (ISA) 0x0000009C (156)	Microsoft ACPI-Compliant System
 (ISA) 0x0000009D (157)	Microsoft ACPI-Compliant System
 (ISA) 0x0000009E (158)	Microsoft ACPI-Compliant System
 (ISA) 0x0000009F (159)	Microsoft ACPI-Compliant System
 (ISA) 0x000000A0 (160)	Microsoft ACPI-Compliant System
 (ISA) 0x000000A1 (161)	Microsoft ACPI-Compliant System
 (ISA) 0x000000A2 (162)	Microsoft ACPI-Compliant System
 (ISA) 0x000000A3 (163)	Microsoft ACPI-Compliant System
 (ISA) 0x000000A4 (164)	Microsoft ACPI-Compliant System











































 (ISA) 0x000000A5 (165)	Microsoft ACPI-Compliant System
 (ISA) 0x000000A6 (166)	Microsoft ACPI-Compliant System
 (ISA) 0x000000A7 (167)	Microsoft ACPI-Compliant System
 (ISA) 0x000000A8 (168)	Microsoft ACPI-Compliant System
 (ISA) 0x000000A9 (169)	Microsoft ACPI-Compliant System
 (ISA) 0x000000AA (170)	Microsoft ACPI-Compliant System
 (ISA) 0x000000AB (171)	Microsoft ACPI-Compliant System
 (ISA) 0x000000AC (172)	Microsoft ACPI-Compliant System
 (ISA) 0x000000AD (173)	Microsoft ACPI-Compliant System
 (ISA) 0x000000AE (174)	Microsoft ACPI-Compliant System
 (ISA) 0x000000AF (175)	Microsoft ACPI-Compliant System
 (ISA) 0x000000B0 (176)	Microsoft ACPI-Compliant System
 (ISA) 0x000000B1 (177)	Microsoft ACPI-Compliant System
 (ISA) 0x000000B2 (178)	Microsoft ACPI-Compliant System
 (ISA) 0x000000B3 (179)	Microsoft ACPI-Compliant System
 (ISA) 0x000000B4 (180)	Microsoft ACPI-Compliant System
 (ISA) 0x000000B5 (181)	Microsoft ACPI-Compliant System
 (ISA) 0x000000B6 (182)	Microsoft ACPI-Compliant System
 (ISA) 0x000000B7 (183)	Microsoft ACPI-Compliant System
 (ISA) 0x000000B8 (184)	Microsoft ACPI-Compliant System
 (ISA) 0x000000B9 (185)	Microsoft ACPI-Compliant System
 (ISA) 0x000000BA (186)	Microsoft ACPI-Compliant System
 (ISA) 0x000000BB (187)	Microsoft ACPI-Compliant System
 (ISA) 0x000000BC (188)	Microsoft ACPI-Compliant System
 (ISA) 0x000000BD (189)	Microsoft ACPI-Compliant System
 (ISA) 0x000000BE (190)	Microsoft ACPI-Compliant System
 (ISA) 0x000000BF (191)	Microsoft ACPI-Compliant System
 (ISA) 0x000000C0 (192)	Microsoft ACPI-Compliant System
 (ISA) 0x000000C1 (193)	Microsoft ACPI-Compliant System
 (ISA) 0x000000C2 (194)	Microsoft ACPI-Compliant System
 (ISA) 0x000000C3 (195)	Microsoft ACPI-Compliant System
 (ISA) 0x000000C4 (196)	Microsoft ACPI-Compliant System
 (ISA) 0x000000C5 (197)	Microsoft ACPI-Compliant System
 (ISA) 0x000000C6 (198)	Microsoft ACPI-Compliant System
 (ISA) 0x000000C7 (199)	Microsoft ACPI-Compliant System
 (ISA) 0x000000C8 (200)	Microsoft ACPI-Compliant System
 (ISA) 0x000000C9 (201)	Microsoft ACPI-Compliant System
 (ISA) 0x000000CA (202)	Microsoft ACPI-Compliant System
 (ISA) 0x000000CB (203)	Microsoft ACPI-Compliant System
 (ISA) 0x000000CC (204)	Microsoft ACPI-Compliant System
 (ISA) 0x00000100 (256)	Microsoft ACPI-Compliant System
 (ISA) 0x00000101 (257)	Microsoft ACPI-Compliant System











































 (ISA) 0x000000A5 (165)	Microsoft ACPI-Compliant System
 (ISA) 0x000000A6 (166)	Microsoft ACPI-Compliant System
 (ISA) 0x000000A7 (167)	Microsoft ACPI-Compliant System
 (ISA) 0x000000A8 (168)	Microsoft ACPI-Compliant System
 (ISA) 0x000000A9 (169)	Microsoft ACPI-Compliant System
 (ISA) 0x000000AA (170)	Microsoft ACPI-Compliant System
 (ISA) 0x000000AB (171)	Microsoft ACPI-Compliant System
 (ISA) 0x000000AC (172)	Microsoft ACPI-Compliant System
 (ISA) 0x000000AD (173)	Microsoft ACPI-Compliant System
 (ISA) 0x000000AE (174)	Microsoft ACPI-Compliant System
 (ISA) 0x000000AF (175)	Microsoft ACPI-Compliant System
 (ISA) 0x000000B0 (176)	Microsoft ACPI-Compliant System
 (ISA) 0x000000B1 (177)	Microsoft ACPI-Compliant System
 (ISA) 0x000000B2 (178)	Microsoft ACPI-Compliant System
 (ISA) 0x000000B3 (179)	Microsoft ACPI-Compliant System
 (ISA) 0x000000B4 (180)	Microsoft ACPI-Compliant System
 (ISA) 0x000000B5 (181)	Microsoft ACPI-Compliant System
 (ISA) 0x000000B6 (182)	Microsoft ACPI-Compliant System
 (ISA) 0x000000B7 (183)	Microsoft ACPI-Compliant System
 (ISA) 0x000000B8 (184)	Microsoft ACPI-Compliant System
 (ISA) 0x000000B9 (185)	Microsoft ACPI-Compliant System
 (ISA) 0x000000BA (186)	Microsoft ACPI-Compliant System
 (ISA) 0x000000BB (187)	Microsoft ACPI-Compliant System
 (ISA) 0x000000BC (188)	Microsoft ACPI-Compliant System
 (ISA) 0x000000BD (189)	Microsoft ACPI-Compliant System
 (ISA) 0x000000BE (190)	Microsoft ACPI-Compliant System
 (ISA) 0x000000BF (191)	Microsoft ACPI-Compliant System
 (ISA) 0x000000C0 (192)	Microsoft ACPI-Compliant System
 (ISA) 0x000000C1 (193)	Microsoft ACPI-Compliant System
 (ISA) 0x000000C2 (194)	Microsoft ACPI-Compliant System
 (ISA) 0x000000C3 (195)	Microsoft ACPI-Compliant System
 (ISA) 0x000000C4 (196)	Microsoft ACPI-Compliant System
 (ISA) 0x000000C5 (197)	Microsoft ACPI-Compliant System
 (ISA) 0x000000C6 (198)	Microsoft ACPI-Compliant System
 (ISA) 0x000000C7 (199)	Microsoft ACPI-Compliant System
 (ISA) 0x000000C8 (200)	Microsoft ACPI-Compliant System
 (ISA) 0x000000C9 (201)	Microsoft ACPI-Compliant System
 (ISA) 0x000000CA (202)	Microsoft ACPI-Compliant System
 (ISA) 0x000000CB (203)	Microsoft ACPI-Compliant System
 (ISA) 0x000000CC (204)	Microsoft ACPI-Compliant System
 (ISA) 0x00000100 (256)	Microsoft ACPI-Compliant System
 (ISA) 0x00000101 (257)	Microsoft ACPI-Compliant System

---

 (ISA) 0x00000102 (258)	Microsoft ACPI-Compliant System
 (ISA) 0x00000103 (259)	Microsoft ACPI-Compliant System
 (ISA) 0x00000104 (260)	Microsoft ACPI-Compliant System
 (ISA) 0x00000105 (261)	Microsoft ACPI-Compliant System
 (ISA) 0x00000106 (262)	Microsoft ACPI-Compliant System
 (ISA) 0x00000107 (263)	Microsoft ACPI-Compliant System
 (ISA) 0x00000108 (264)	Microsoft ACPI-Compliant System
 (ISA) 0x00000109 (265)	Microsoft ACPI-Compliant System
 (ISA) 0x0000010A (266)	Microsoft ACPI-Compliant System
 (ISA) 0x0000010B (267)	Microsoft ACPI-Compliant System
 (ISA) 0x0000010C (268)	Microsoft ACPI-Compliant System
 (ISA) 0x0000010D (269)	Microsoft ACPI-Compliant System
 (ISA) 0x0000010E (270)	Microsoft ACPI-Compliant System
 (ISA) 0x0000010F (271)	Microsoft ACPI-Compliant System
 (ISA) 0x00000110 (272)	Microsoft ACPI-Compliant System
 (ISA) 0x00000111 (273)	Microsoft ACPI-Compliant System
 (ISA) 0x00000112 (274)	Microsoft ACPI-Compliant System
 (ISA) 0x00000113 (275)	Microsoft ACPI-Compliant System
 (ISA) 0x00000114 (276)	Microsoft ACPI-Compliant System
 (ISA) 0x00000115 (277)	Microsoft ACPI-Compliant System
 (ISA) 0x00000116 (278)	Microsoft ACPI-Compliant System
 (ISA) 0x00000117 (279)	Microsoft ACPI-Compliant System
 (ISA) 0x00000118 (280)	Microsoft ACPI-Compliant System
 (ISA) 0x00000119 (281)	Microsoft ACPI-Compliant System
 (ISA) 0x0000011A (282)	Microsoft ACPI-Compliant System
 (ISA) 0x0000011B (283)	Microsoft ACPI-Compliant System
 (ISA) 0x0000011C (284)	Microsoft ACPI-Compliant System
 (ISA) 0x0000011D (285)	Microsoft ACPI-Compliant System
 (ISA) 0x0000011E (286)	Microsoft ACPI-Compliant System
 (ISA) 0x0000011F (287)	Microsoft ACPI-Compliant System
 (ISA) 0x00000120 (288)	Microsoft ACPI-Compliant System
 (ISA) 0x00000121 (289)	Microsoft ACPI-Compliant System
 (ISA) 0x00000122 (290)	Microsoft ACPI-Compliant System
 (ISA) 0x00000123 (291)	Microsoft ACPI-Compliant System
 (ISA) 0x00000124 (292)	Microsoft ACPI-Compliant System
 (ISA) 0x00000125 (293)	Microsoft ACPI-Compliant System
 (ISA) 0x00000126 (294)	Microsoft ACPI-Compliant System
 (ISA) 0x00000127 (295)	Microsoft ACPI-Compliant System
 (ISA) 0x00000128 (296)	Microsoft ACPI-Compliant System
 (ISA) 0x00000129 (297)	Microsoft ACPI-Compliant System
 (ISA) 0x0000012A (298)	Microsoft ACPI-Compliant System
 (ISA) 0x0000012B (299)	Microsoft ACPI-Compliant System













































 (ISA) 0x0000012C (300)	Microsoft ACPI-Compliant System
 (ISA) 0x0000012D (301)	Microsoft ACPI-Compliant System
 (ISA) 0x0000012E (302)	Microsoft ACPI-Compliant System
 (ISA) 0x0000012F (303)	Microsoft ACPI-Compliant System
 (ISA) 0x00000130 (304)	Microsoft ACPI-Compliant System
 (ISA) 0x00000131 (305)	Microsoft ACPI-Compliant System
 (ISA) 0x00000132 (306)	Microsoft ACPI-Compliant System
 (ISA) 0x00000133 (307)	Microsoft ACPI-Compliant System
 (ISA) 0x00000134 (308)	Microsoft ACPI-Compliant System
 (ISA) 0x00000135 (309)	Microsoft ACPI-Compliant System
 (ISA) 0x00000136 (310)	Microsoft ACPI-Compliant System
 (ISA) 0x00000137 (311)	Microsoft ACPI-Compliant System
 (ISA) 0x00000138 (312)	Microsoft ACPI-Compliant System
 (ISA) 0x00000139 (313)	Microsoft ACPI-Compliant System
 (ISA) 0x0000013A (314)	Microsoft ACPI-Compliant System
 (ISA) 0x0000013B (315)	Microsoft ACPI-Compliant System
 (ISA) 0x0000013C (316)	Microsoft ACPI-Compliant System
 (ISA) 0x0000013D (317)	Microsoft ACPI-Compliant System
 (ISA) 0x0000013E (318)	Microsoft ACPI-Compliant System
 (ISA) 0x0000013F (319)	Microsoft ACPI-Compliant System
 (ISA) 0x00000140 (320)	Microsoft ACPI-Compliant System
 (ISA) 0x00000141 (321)	Microsoft ACPI-Compliant System
 (ISA) 0x00000142 (322)	Microsoft ACPI-Compliant System
 (ISA) 0x00000143 (323)	Microsoft ACPI-Compliant System
 (ISA) 0x00000144 (324)	Microsoft ACPI-Compliant System
 (ISA) 0x00000145 (325)	Microsoft ACPI-Compliant System
 (ISA) 0x00000146 (326)	Microsoft ACPI-Compliant System
 (ISA) 0x00000147 (327)	Microsoft ACPI-Compliant System
 (ISA) 0x00000148 (328)	Microsoft ACPI-Compliant System
 (ISA) 0x00000149 (329)	Microsoft ACPI-Compliant System
 (ISA) 0x0000014A (330)	Microsoft ACPI-Compliant System
 (ISA) 0x0000014B (331)	Microsoft ACPI-Compliant System
 (ISA) 0x0000014C (332)	Microsoft ACPI-Compliant System
 (ISA) 0x0000014D (333)	Microsoft ACPI-Compliant System
 (ISA) 0x0000014E (334)	Microsoft ACPI-Compliant System
 (ISA) 0x0000014F (335)	Microsoft ACPI-Compliant System
 (ISA) 0x00000150 (336)	Microsoft ACPI-Compliant System
 (ISA) 0x00000151 (337)	Microsoft ACPI-Compliant System
 (ISA) 0x00000152 (338)	Microsoft ACPI-Compliant System
 (ISA) 0x00000153 (339)	Microsoft ACPI-Compliant System
 (ISA) 0x00000154 (340)	Microsoft ACPI-Compliant System
 (ISA) 0x00000155 (341)	Microsoft ACPI-Compliant System











































 (ISA) 0x00000156 (342)	Microsoft ACPI-Compliant System
 (ISA) 0x00000157 (343)	Microsoft ACPI-Compliant System
 (ISA) 0x00000158 (344)	Microsoft ACPI-Compliant System
 (ISA) 0x00000159 (345)	Microsoft ACPI-Compliant System
 (ISA) 0x0000015A (346)	Microsoft ACPI-Compliant System
 (ISA) 0x0000015B (347)	Microsoft ACPI-Compliant System
 (ISA) 0x0000015C (348)	Microsoft ACPI-Compliant System
 (ISA) 0x0000015D (349)	Microsoft ACPI-Compliant System
 (ISA) 0x0000015E (350)	Microsoft ACPI-Compliant System
 (ISA) 0x0000015F (351)	Microsoft ACPI-Compliant System
 (ISA) 0x00000160 (352)	Microsoft ACPI-Compliant System
 (ISA) 0x00000161 (353)	Microsoft ACPI-Compliant System
 (ISA) 0x00000162 (354)	Microsoft ACPI-Compliant System
 (ISA) 0x00000163 (355)	Microsoft ACPI-Compliant System
 (ISA) 0x00000164 (356)	Microsoft ACPI-Compliant System
 (ISA) 0x00000165 (357)	Microsoft ACPI-Compliant System
 (ISA) 0x00000166 (358)	Microsoft ACPI-Compliant System
 (ISA) 0x00000167 (359)	Microsoft ACPI-Compliant System
 (ISA) 0x00000168 (360)	Microsoft ACPI-Compliant System
 (ISA) 0x00000169 (361)	Microsoft ACPI-Compliant System
 (ISA) 0x0000016A (362)	Microsoft ACPI-Compliant System
 (ISA) 0x0000016B (363)	Microsoft ACPI-Compliant System
 (ISA) 0x0000016C (364)	Microsoft ACPI-Compliant System
 (ISA) 0x0000016D (365)	Microsoft ACPI-Compliant System
 (ISA) 0x0000016E (366)	Microsoft ACPI-Compliant System
 (ISA) 0x0000016F (367)	Microsoft ACPI-Compliant System
 (ISA) 0x00000170 (368)	Microsoft ACPI-Compliant System
 (ISA) 0x00000171 (369)	Microsoft ACPI-Compliant System
 (ISA) 0x00000172 (370)	Microsoft ACPI-Compliant System
 (ISA) 0x00000173 (371)	Microsoft ACPI-Compliant System
 (ISA) 0x00000174 (372)	Microsoft ACPI-Compliant System
 (ISA) 0x00000175 (373)	Microsoft ACPI-Compliant System
 (ISA) 0x00000176 (374)	Microsoft ACPI-Compliant System
 (ISA) 0x00000177 (375)	Microsoft ACPI-Compliant System
 (ISA) 0x00000178 (376)	Microsoft ACPI-Compliant System
 (ISA) 0x00000179 (377)	Microsoft ACPI-Compliant System
 (ISA) 0x0000017A (378)	Microsoft ACPI-Compliant System
 (ISA) 0x0000017B (379)	Microsoft ACPI-Compliant System
 (ISA) 0x0000017C (380)	Microsoft ACPI-Compliant System
 (ISA) 0x0000017D (381)	Microsoft ACPI-Compliant System
 (ISA) 0x0000017E (382)	Microsoft ACPI-Compliant System
 (ISA) 0x0000017F (383)	Microsoft ACPI-Compliant System













































---

























 (ISA) 0x00000180 (384)	Microsoft ACPI-Compliant System
 (ISA) 0x00000181 (385)	Microsoft ACPI-Compliant System
 (ISA) 0x00000182 (386)	Microsoft ACPI-Compliant System
 (ISA) 0x00000183 (387)	Microsoft ACPI-Compliant System
 (ISA) 0x00000184 (388)	Microsoft ACPI-Compliant System
 (ISA) 0x00000185 (389)	Microsoft ACPI-Compliant System
 (ISA) 0x00000186 (390)	Microsoft ACPI-Compliant System
 (ISA) 0x00000187 (391)	Microsoft ACPI-Compliant System
 (ISA) 0x00000188 (392)	Microsoft ACPI-Compliant System
 (ISA) 0x00000189 (393)	Microsoft ACPI-Compliant System
 (ISA) 0x0000018A (394)	Microsoft ACPI-Compliant System
 (ISA) 0x0000018B (395)	Microsoft ACPI-Compliant System
 (ISA) 0x0000018C (396)	Microsoft ACPI-Compliant System
 (ISA) 0x0000018D (397)	Microsoft ACPI-Compliant System
 (ISA) 0x0000018E (398)	Microsoft ACPI-Compliant System
 (ISA) 0x0000018F (399)	Microsoft ACPI-Compliant System
 (ISA) 0x00000190 (400)	Microsoft ACPI-Compliant System
 (ISA) 0x00000191 (401)	Microsoft ACPI-Compliant System
 (ISA) 0x00000192 (402)	Microsoft ACPI-Compliant System
 (ISA) 0x00000193 (403)	Microsoft ACPI-Compliant System
 (ISA) 0x00000194 (404)	Microsoft ACPI-Compliant System
 (ISA) 0x00000195 (405)	Microsoft ACPI-Compliant System
 (ISA) 0x00000196 (406)	Microsoft ACPI-Compliant System
 (ISA) 0x00000197 (407)	Microsoft ACPI-Compliant System
 (ISA) 0x00000198 (408)	Microsoft ACPI-Compliant System
 (ISA) 0x00000199 (409)	Microsoft ACPI-Compliant System
 (ISA) 0x0000019A (410)	Microsoft ACPI-Compliant System
 (ISA) 0x0000019B (411)	Microsoft ACPI-Compliant System
 (ISA) 0x0000019C (412)	Microsoft ACPI-Compliant System
 (ISA) 0x0000019D (413)	Microsoft ACPI-Compliant System
 (ISA) 0x0000019E (414)	Microsoft ACPI-Compliant System
 (ISA) 0x0000019F (415)	Microsoft ACPI-Compliant System
 (ISA) 0x000001A0 (416)	Microsoft ACPI-Compliant System
 (ISA) 0x000001A1 (417)	Microsoft ACPI-Compliant System
 (ISA) 0x000001A2 (418)	Microsoft ACPI-Compliant System
 (ISA) 0x000001A3 (419)	Microsoft ACPI-Compliant System
 (ISA) 0x000001A4 (420)	Microsoft ACPI-Compliant System
 (ISA) 0x000001A5 (421)	Microsoft ACPI-Compliant System
 (ISA) 0x000001A6 (422)	Microsoft ACPI-Compliant System
 (ISA) 0x000001A7 (423)	Microsoft ACPI-Compliant System
 (ISA) 0x000001A8 (424)	Microsoft ACPI-Compliant System
 (ISA) 0x000001A9 (425)	Microsoft ACPI-Compliant System

---

 (ISA) 0x000001AA (426)	Microsoft ACPI-Compliant System
 (ISA) 0x000001AB (427)	Microsoft ACPI-Compliant System
 (ISA) 0x000001AC (428)	Microsoft ACPI-Compliant System
 (ISA) 0x000001AD (429)	Microsoft ACPI-Compliant System
 (ISA) 0x000001AE (430)	Microsoft ACPI-Compliant System
 (ISA) 0x000001AF (431)	Microsoft ACPI-Compliant System
 (ISA) 0x000001B0 (432)	Microsoft ACPI-Compliant System
 (ISA) 0x000001B1 (433)	Microsoft ACPI-Compliant System
 (ISA) 0x000001B2 (434)	Microsoft ACPI-Compliant System
 (ISA) 0x000001B3 (435)	Microsoft ACPI-Compliant System
 (ISA) 0x000001B4 (436)	Microsoft ACPI-Compliant System
 (ISA) 0x000001B5 (437)	Microsoft ACPI-Compliant System
 (ISA) 0x000001B6 (438)	Microsoft ACPI-Compliant System
 (ISA) 0x000001B7 (439)	Microsoft ACPI-Compliant System
 (ISA) 0x000001B8 (440)	Microsoft ACPI-Compliant System
 (ISA) 0x000001B9 (441)	Microsoft ACPI-Compliant System
 (ISA) 0x000001BA (442)	Microsoft ACPI-Compliant System
 (ISA) 0x000001BB (443)	Microsoft ACPI-Compliant System
 (ISA) 0x000001BC (444)	Microsoft ACPI-Compliant System
 (ISA) 0x000001BD (445)	Microsoft ACPI-Compliant System
 (ISA) 0x000001BE (446)	Microsoft ACPI-Compliant System
 (ISA) 0x000001BF (447)	Microsoft ACPI-Compliant System
 (ISA) 0x000001C0 (448)	Microsoft ACPI-Compliant System
 (ISA) 0x000001C1 (449)	Microsoft ACPI-Compliant System
 (ISA) 0x000001C2 (450)	Microsoft ACPI-Compliant System
 (ISA) 0x000001C3 (451)	Microsoft ACPI-Compliant System
 (ISA) 0x000001C4 (452)	Microsoft ACPI-Compliant System
 (ISA) 0x000001C5 (453)	Microsoft ACPI-Compliant System
 (ISA) 0x000001C6 (454)	Microsoft ACPI-Compliant System
 (ISA) 0x000001C7 (455)	Microsoft ACPI-Compliant System
 (ISA) 0x000001C8 (456)	Microsoft ACPI-Compliant System
 (ISA) 0x000001C9 (457)	Microsoft ACPI-Compliant System
 (ISA) 0x000001CA (458)	Microsoft ACPI-Compliant System
 (ISA) 0x000001CB (459)	Microsoft ACPI-Compliant System
 (ISA) 0x000001CC (460)	Microsoft ACPI-Compliant System
 (ISA) 0x000001CD (461)	Microsoft ACPI-Compliant System
 (ISA) 0x000001CE (462)	Microsoft ACPI-Compliant System
 (ISA) 0x000001CF (463)	Microsoft ACPI-Compliant System
 (ISA) 0x000001D0 (464)	Microsoft ACPI-Compliant System
 (ISA) 0x000001D1 (465)	Microsoft ACPI-Compliant System
 (ISA) 0x000001D2 (466)	Microsoft ACPI-Compliant System
 (ISA) 0x000001D3 (467)	Microsoft ACPI-Compliant System

 (ISA) 0x00001D4 (468)	Microsoft ACPI-Compliant System
 (ISA) 0x00001D5 (469)	Microsoft ACPI-Compliant System
 (ISA) 0x00001D6 (470)	Microsoft ACPI-Compliant System
 (ISA) 0x00001D7 (471)	Microsoft ACPI-Compliant System
 (ISA) 0x00001D8 (472)	Microsoft ACPI-Compliant System
 (ISA) 0x00001D9 (473)	Microsoft ACPI-Compliant System
 (ISA) 0x00001DA (474)	Microsoft ACPI-Compliant System
 (ISA) 0x00001DB (475)	Microsoft ACPI-Compliant System
 (ISA) 0x00001DC (476)	Microsoft ACPI-Compliant System
 (ISA) 0x00001DD (477)	Microsoft ACPI-Compliant System
 (ISA) 0x00001DE (478)	Microsoft ACPI-Compliant System
 (ISA) 0x00001DF (479)	Microsoft ACPI-Compliant System
 (ISA) 0x00001E0 (480)	Microsoft ACPI-Compliant System
 (ISA) 0x00001E1 (481)	Microsoft ACPI-Compliant System
 (ISA) 0x00001E2 (482)	Microsoft ACPI-Compliant System
 (ISA) 0x00001E3 (483)	Microsoft ACPI-Compliant System
 (ISA) 0x00001E4 (484)	Microsoft ACPI-Compliant System
 (ISA) 0x00001E5 (485)	Microsoft ACPI-Compliant System
 (ISA) 0x00001E6 (486)	Microsoft ACPI-Compliant System
 (ISA) 0x00001E7 (487)	Microsoft ACPI-Compliant System
 (ISA) 0x00001E8 (488)	Microsoft ACPI-Compliant System
 (ISA) 0x00001E9 (489)	Microsoft ACPI-Compliant System
 (ISA) 0x00001EA (490)	Microsoft ACPI-Compliant System
 (ISA) 0x00001EB (491)	Microsoft ACPI-Compliant System
 (ISA) 0x00001EC (492)	Microsoft ACPI-Compliant System
 (ISA) 0x00001ED (493)	Microsoft ACPI-Compliant System
 (ISA) 0x00001EE (494)	Microsoft ACPI-Compliant System
 (ISA) 0x00001EF (495)	Microsoft ACPI-Compliant System
 (ISA) 0x00001F0 (496)	Microsoft ACPI-Compliant System
 (ISA) 0x00001F1 (497)	Microsoft ACPI-Compliant System
 (ISA) 0x00001F2 (498)	Microsoft ACPI-Compliant System
 (ISA) 0x00001F3 (499)	Microsoft ACPI-Compliant System
 (ISA) 0x00001F4 (500)	Microsoft ACPI-Compliant System
 (ISA) 0x00001F5 (501)	Microsoft ACPI-Compliant System
 (ISA) 0x00001F6 (502)	Microsoft ACPI-Compliant System
 (ISA) 0x00001F7 (503)	Microsoft ACPI-Compliant System
 (ISA) 0x00001F8 (504)	Microsoft ACPI-Compliant System
 (ISA) 0x00001F9 (505)	Microsoft ACPI-Compliant System
 (ISA) 0x00001FA (506)	Microsoft ACPI-Compliant System
 (ISA) 0x00001FB (507)	Microsoft ACPI-Compliant System
 (ISA) 0x00001FC (508)	Microsoft ACPI-Compliant System
 (ISA) 0x00001FD (509)	Microsoft ACPI-Compliant System

---

	(ISA) 0x000001FE (510)	Microsoft ACPI-Compliant System
	(ISA) 0x000001FF (511)	Microsoft ACPI-Compliant System
	(PCI) 0x0000000A (10)	Intel(R) Atom(TM)/Celeron(R)/Pentium(R) Processor Platform Control Unit - SMBus Port - 0F12
	(PCI) 0x00000016 (22)	High Definition Audio Controller
	(PCI) 0xFFFFFFFFB (-21)	Intel(R) Trusted Execution Engine Interface
	(PCI) 0xFFFFFFFFEC (-20)	Intel(R) I211 Gigabit Network Connection #4
	(PCI) 0xFFFFFFFFED (-19)	Intel(R) I211 Gigabit Network Connection #3
	(PCI) 0xFFFFFFFFEE (-18)	Intel(R) I211 Gigabit Network Connection #2
	(PCI) 0xFFFFFFFFEF (-17)	Intel(R) I211 Gigabit Network Connection #2
	(PCI) 0xFFFFFFFFF0 (-16)	Intel(R) I211 Gigabit Network Connection #2
	(PCI) 0xFFFFFFFFF1 (-15)	Intel(R) I211 Gigabit Network Connection #2
	(PCI) 0xFFFFFFFFF2 (-14)	Intel(R) I211 Gigabit Network Connection #3
	(PCI) 0xFFFFFFFFF3 (-13)	Intel(R) I211 Gigabit Network Connection #3
	(PCI) 0xFFFFFFFFF4 (-12)	Intel(R) I211 Gigabit Network Connection #3
	(PCI) 0xFFFFFFFFF5 (-11)	Intel(R) I211 Gigabit Network Connection #4
	(PCI) 0xFFFFFFFFF6 (-10)	Intel(R) I211 Gigabit Network Connection #4
	(PCI) 0xFFFFFFFFF7 (-9)	Intel(R) I211 Gigabit Network Connection #4
	(PCI) 0xFFFFFFFFF8 (-8)	Intel(R) USB 3.0 eXtensible Host Controller - 1.0 (Microsoft)
	(PCI) 0xFFFFFFFFF9 (-7)	Intel(R) HD Graphics
	(PCI) 0xFFFFFFFFFA (-6)	Intel(R) I211 Gigabit Network Connection
	(PCI) 0xFFFFFFFFFB (-5)	Intel(R) I211 Gigabit Network Connection
	(PCI) 0xFFFFFFFFFC (-4)	Intel(R) I211 Gigabit Network Connection
	(PCI) 0xFFFFFFFFFD (-3)	Intel(R) I211 Gigabit Network Connection
	(PCI) 0xFFFFFFFFFE (-2)	Standard SATA AHCI Controller

# Appendix C

---

Mating Connectors

## C.1 List of Mating Connectors and Cables

Connector Label	Function	Mating Connector		Available Cable	Cable P/N
		Vendor	Model no		
CN8	SATA	Molex	88750-5318	SATA CABLE.7P Pitch 1.27mm.50 cm	1709070500
CN7	+5Vout Connector	JST	PHR-2	2 Pins For HDD Power	1702150155
CN10	Digital IO Port Connector	Molex	51110-0650	n/a	n/a
CN16	Front Panel Connector	Molex	51110-1050	n/a	n/a
CN15	Buzzer connector	Molex	51021-0200	n/a	n/a
CN2	12V Power Connector	FLYINGWAY	FWAA801	2.5mm DC PLUG SCREW TYPE W/MOLDING to 5.08mm 1X4P HOUSING	1702041004

# Appendix D

---

Electrical Specifications for I/O Ports

## D.1 Electrical Specifications for I/O Ports

I/O	Reference	Signal name	Rate output
COM Port	CN1	+5V/+12V	+5V/1A or +12V/1A
+5V Output for SATA HDD	CN7	+5V	+5V/1A
Digital IO Port	CN10	+5V	+5V/1A
C-Fast Slot	CN11	+3.3V	+3.3V/0.5A
Mini-Card Slot USB 2.0 Port2 Only	CN13	+3.3VSB +1.5V	+3.3V/1.1A +1.5V/0.375A
USB 3.0 Port 0	CN17	+5VSB	+5V/1A
USB 2.0 Port 3	CN18	+5VSB	+5V/0.5A
USB 2.0 Port 1	CN19	+5VSB	+5V/0.5A
HDMI Port	CN20,CN21	+5V	+5V/1A



# Appendix E

---

Digital I/O Ports

## E.1 Electrical Specifications for Digital I/O Ports

---

Table 1 : Digital Input/Output Pin Electrical Specification

Pin	Type	Input Threshold Voltage		Output Voltage		Note
		Low	High	Low	High	
DIO1	I/O	0.8	2.0	0	3.3	
DIO2	I/O	0.8	2.0	0	3.3	
DIO3	I/O	0.8	2.0	0	3.3	
DIO4	I/O	0.8	2.0	0	3.3	

Note: All DI/O pins are 5V tolerant in input mode.

## E.2 DI/O Programming

---

GENE-BT04 utilizes FINTEK F81801U chipset as its Digital I/O controller. Below are the procedures to complete its configuration and the AAEON initial DI/O program is also attached, based on which you can develop customized program to fit your application.

There are three steps to complete the configuration setup:

- (1) Enter the MB PnP Mode
- (2) Modify the data of configuration registers
- (3) Exit the MB PnP Mode. Undesired result may occur if the MB PnP Mode is not exited normally.

### E.3 Digital I/O Register

Table 2 : SuperIO relative register table

	Default Value	Note
Index	0x2E	SIO MB PnP Mode Index Register 0x2E or 0x4E
Data	0x2F	SIO MB PnP Mode Data Register 0x2F or 0x4F

Table 3 : Digital Input/Output relative register table

	LDN	Register	Bit	Note
GPIO1 Direction	0x06	0xC0	0	0:input, 1: output
GPIO2 Direction	0x06	0xC0	1	
GPIO3 Direction	0x06	0xC0	2	
GPIO4 Direction	0x06	0xC0	3	
GPIO1 Output Level	0x06	0xC1	0	0:low, 1: high
GPIO2 Output Level	0x06	0xC1	1	
GPIO3 Output Level	0x06	0xC1	2	
GPIO4 Output Level	0x06	0xC1	3	
GPIO1 Status	0x06	0xC2	0	0:low, 1: high
GPIO2 Status	0x06	0xC2	1	
GPIO3 Status	0x06	0xC2	2	
GPIO4 Status	0x06	0xC2	3	

## E.4 Digital I/O Sample Program

```

*****
// SuperIO relative definition (Please reference to Table 2)
#define SIOIndex 0x2E
#define SIOData 0x2F
#define DIOLDN 0x06
IOWriteByte(byte IOPort, byte Value);
IOReadByte(byte IOPort);
// DIO relative definition (Please reference to Table 3)
#define DirReg 0xC0 // 0:input, 1: output
    #define InputPin 0x00
    #define OutputPin 0x01
#define OutputReg 0xC1 // 0:low, 1: high
#define StatusReg 0xC2 // 0:low, 1: high
    #define PinLow 0x00
    #define PinHigh 0x01
#define Pin1Bit 0x00
#define Pin2Bit 0x01
#define Pin3Bit 0x02
#define Pin4Bit 0x03
*****

*****
VOID Main(){
    Boolean PinStatus ;

    // Procedure : AaeonReadPinStatus
    // Input :
    // Example, Read Digital I/O Pin 3 status
    // Output :
    // InputStatus :
    // 0: Digital I/O Pin level is low
    // 1: Digital I/O Pin level is High
    PinStatus = AaeonReadPinStatus(Pin3Bit);

    // Procedure : AaeonSetOutputLevel
    // Input :
    // Example, Set Digital I/O Pin 2 to high level
    AaeonSetOutputLevel(Pin2Bit, PinHigh);
}

```

```

*****
*****
Boolean  AaeonReadPinStatus(byte PinBit){
    Boolean PinStatus ;

        PinStatus = SIOBitRead(DIOLDN, StatusReg, PinBit);
    Return PinStatus ;
}
VOID  AaeonSetOutputLevel(byte PinBit, byte Value){
    ConfigDioMode(PinBit, OutputPin);
    SIOBitSet(DIOLDN, OutputReg, PinBit, Value);
}
*****
*****VOID
SIOEnterMBPnPMode(){
    IOWriteByte(SIOIndex, 0x87);
    IOWriteByte(SIOIndex, 0x87);
}

VOID  SIOExitMBPnPMode(){
    IOWriteByte(SIOIndex, 0xAA);
}

VOID  SIOSelectLDN(byte LDN){
    IOWriteByte(SIOIndex, 0x07); // SIO LDN Register Offset = 0x07
    IOWriteByte(SIOData, LDN);
}

VOID  SIOBitSet(byte LDN, byte Register, byte BitNum, byte Value){
    Byte TmpValue;

    SIOEnterMBPnPMode();
    SIOSelectLDN(LDN);
    IOWriteByte(SIOIndex, Register);
    TmpValue = IOReadByte(SIOData);
    TmpValue &= ~(1 << BitNum);
    TmpValue |= (Value << BitNum);
    IOWriteByte(SIOData, TmpValue);
    SIOExitMBPnPMode();
}

```

```

VOID  SIOByteSet(byte LDN, byte Register, byte Value){
    SIOEnterMBPnPMode();
    SIOSelectLDN(LDN);
    IOWriteByte(SIOIndex, Register);
    IOWriteByte(SIOData, Value);
    SIOExitMBPnPMode();
}
*****

*****

Boolean  SIOBitRead(byte LDN, byte Register, byte BitNum){
    Byte TmpValue;

    SIOEnterMBPnPMode();
    SIOSelectLDN(LDN);
    IOWriteByte(SIOIndex, Register);
    TmpValue = IOReadByte(SIOData);
    TmpValue &= (1 << BitNum);
    SIOExitMBPnPMode();
    If(TmpValue == 0)
        Return 0;
    Return 1;
}

VOID  ConfigDioMode(byte PinBit, byte Mode){
    Byte TmpValue;

    SIOEnterMBPnPMode();
    SIOSelectLDN(DIOLDN);
    IOWriteByte(SIOIndex, DirReg);
    TmpValue = IOReadByte(SIOData);
    TmpValue |= (Mode << PinBit);
    IOWriteByte(SIOData, DirReg);
    SIOExitMBPnPMode();
}
*****

```