

# GENE-APL7

---

3.5" Subcompact Board

User's Manual 3<sup>rd</sup> Ed

## Copyright Notice

---

This document is copyrighted, 2018. All rights are reserved. The original manufacturer reserves the right to make improvements to the products described in this manual at any time without notice.

No part of this manual may be reproduced, copied, translated, or transmitted in any form or by any means without the prior written permission of the original manufacturer. Information provided in this manual is intended to be accurate and reliable. However, the original manufacturer assumes no responsibility for its use, or for any infringements upon the rights of third parties that may result from its use.

The material in this document is for product information only and is subject to change without notice. While reasonable efforts have been made in the preparation of this document to assure its accuracy, AAEMON assumes no liabilities resulting from errors or omissions in this document, or from the use of the information contained herein.

AAEMON reserves the right to make changes in the product design without notice to its users.

## Acknowledgement

---

All other products' name or trademarks are properties of their respective owners.

- Microsoft Windows is a registered trademark of Microsoft Corp.
- Intel, Pentium, Celeron, and Xeon are registered trademarks of Intel Corporation
- Core, Atom are trademarks of Intel Corporation
- ITE is a trademark of Integrated Technology Express, Inc.
- IBM, PC/AT, PS/2, and VGA are trademarks of International Business Machines Corporation.

All other product names or trademarks are properties of their respective owners.

## Packing List

---

Before setting up your product, please make sure the following items have been shipped:

Item	Quantity
● GENE-APL7	1

If any of these items are missing or damaged, please contact your distributor or sales representative immediately.

## About this Document

---

This User's Manual contains all the essential information, such as detailed descriptions and explanations on the product's hardware and software features (if any), its specifications, dimensions, jumper/connector settings/definitions, and driver installation instructions (if any), to facilitate users in setting up their product.

Users may refer to the [AAEON.com](http://AAEON.com) for the latest version of this document.

## Safety Precautions

---

Please read the following safety instructions carefully. It is advised that you keep this manual for future references

1. All cautions and warnings on the device should be noted.
2. Make sure the power source matches the power rating of the device.
3. Position the power cord so that people cannot step on it. Do not place anything over the power cord.
4. Always completely disconnect the power before working on the system's hardware.
5. No connections should be made when the system is powered as a sudden rush of power may damage sensitive electronic components.
6. If the device is not to be used for a long time, disconnect it from the power supply to avoid damage by transient over-voltage.
7. Always disconnect this device from any AC supply before cleaning.
8. While cleaning, use a damp cloth instead of liquid or spray detergents.
9. Make sure the device is installed near a power outlet and is easily accessible.
10. Keep this device away from humidity.
11. Place the device on a solid surface during installation to prevent falls
12. Do not cover the openings on the device to ensure optimal heat dissipation.
13. Watch out for high temperatures when the system is running.
14. Do not touch the heat sink or heat spreader when the system is running
15. Never pour any liquid into the openings. This could cause fire or electric shock.
16. As most electronic components are sensitive to static electrical charge, be sure to ground yourself to prevent static charge when installing the internal components. Use a grounding wrist strap and contain all electronic components in any static-shielded containers.

17. If any of the following situations arises, please the contact our service personnel:
  - i. Damaged power cord or plug
  - ii. Liquid intrusion to the device
  - iii. Exposure to moisture
  - iv. Device is not working as expected or in a manner as described in this manual
  - v. The device is dropped or damaged
  - vi. Any obvious signs of damage displayed on the device
18. **DO NOT LEAVE THIS DEVICE IN AN UNCONTROLLED ENVIRONMENT WITH TEMPERATURES BEYOND THE DEVICE'S PERMITTED STORAGE TEMPERATURES (SEE CHAPTER 1) TO PREVENT DAMAGE.**

### **Warning!**



This device complies with Part 15 FCC Rules. Operation is subject to the following two conditions: (1) this device may not cause harmful interference, and (2) this device must accept any interference received including interference that may cause undesired operation.

### **Caution:**

*There is a danger of explosion if the battery is incorrectly replaced. Replace only with the same or equivalent type recommended by the manufacturer. Dispose of used batteries according to the manufacturer's instructions and your local government's recycling or disposal directives.*

### **Attention:**

*Il y a un risque d'explosion si la batterie est remplacée de façon incorrecte. Ne la remplacer qu'avec le même modèle ou équivalent recommandé par le constructeur. Recycler les batteries usées en accord avec les instructions du fabricant et les directives gouvernementales de recyclage.*



## China RoHS Requirements (CN)

产品中有毒有害物质或元素名称及含量

AAEON Main Board/ Daughter Board/ Backplane

部件名称	有毒有害物质或元素					
	铅 (Pb)	汞 (Hg)	镉 (Cd)	六价铬 (Cr(VI))	多溴联苯 (PBB)	多溴二苯醚 (PBDE)
印刷电路板 及其电子组件	○	○	○	○	○	○
外部信号 连接器及线材	○	○	○	○	○	○
<p>O: 表示该有毒有害物质在该部件所有均质材料中的含量均在 SJ/T 11363-2006 标准规定的限量要求以下。</p> <p>X: 表示该有毒有害物质至少在该部件的某一均质材料中的含量超出 SJ/T 11363-2006 标准规定的限量要求。</p> <p>备注: 此产品所标示之环保使用期限, 系指在一般正常使用状况下。</p>						

## China RoHS Requirement (EN)

Poisonous or Hazardous Substances or Elements in Products

AAEON Main Board/ Daughter Board/ Backplane

Component	Poisonous or Hazardous Substances or Elements					
	Lead (Pb)	Mercury (Hg)	Cadmium (Cd)	Hexavalent Chromium (Cr(VI))	Polybrominated Biphenyls (PBB)	Polybrominated Diphenyl Ethers (PBDE)
PCB & Other Components	○	○	○	○	○	○
Wires & Connectors for External Connections	○	○	○	○	○	○
<p>O: The quantity of poisonous or hazardous substances or elements found in each of the component's parts is below the SJ/T 11363-2006-stipulated requirement.</p> <p>X: The quantity of poisonous or hazardous substances or elements found in at least one of the component's parts is beyond the SJ/T 11363-2006-stipulated requirement.</p> <p><b>Note:</b> The Environment Friendly Use Period as labeled on this product is applicable under normal usage only</p>						

# Table of Contents

---

<b>Chapter 1 - Product Specifications .....</b>	<b>1</b>
1.1 Specifications.....	2
<b>Chapter 2 – Hardware Information .....</b>	<b>5</b>
2.1 Dimensions .....	6
2.2 Jumpers and Connectors .....	8
2.3 Assembly Options.....	10
2.4 Block Diagram.....	11
2.5 List of Jumpers .....	12
2.5.1 Clear CMOS Jumper (JP1) .....	13
2.5.2 LVDS1 and eDP Port Operating VDD/BKLT Selection (JP2).....	13
2.5.3 LVDS and eDP Port BLKT Control Mode Selection (JP3).....	13
2.5.4 LVDS2 BLKT Control Mode Selection (JP4).....	13
2.5.5 LVDS2 Operating VDD/BKLT Selection (JP5).....	14
2.5.6 Front Panel Connector (JP6).....	14
2.5.7 COM1~4 Function Selection (JP7, JP9, JP10, JP11) .....	15
2.5.8 Auto Power Button Enable/Disable Selection (JP8) .....	15
2.6 List of Connectors .....	16
2.6.1 LVDS and eDP Port Inverter / Backlight Connector (CN2, CN8). 18	
2.6.2 LVDS Port (CN4, CN5).....	19
2.6.3 External +12V Input (CN6).....	21
2.6.4 Audio I/O Port (CN7).....	21
2.6.5 Speaker (Left) (CN9) .....	22
2.6.6 I2S I/O Port (CN10).....	22
2.6.7 Speaker (Right) (CN11).....	23
2.6.8 COM Port (CN12, CN13, CN14, CN15, CN16, CN19, CN20, CN21, CN25, CN26) .....	23

2.6.9	LPC and I2C Port (CN17) .....	24
2.6.10	Micro SIM Card Socket (CN18) .....	25
2.6.11	CPU FAN (Optional) (CN22) .....	25
2.6.12	8bit DIO Port (CN24) .....	26
2.6.13	+5V Output for SATA HDD (CN27) .....	27
2.6.14	RTC Battery (CN28) .....	27
2.6.15	USB 2.0 Port (CN29-36) .....	27
2.6.16	3.0 SATA Port (CN37) .....	28
2.6.17	USB Ports 0 and 1 (CN38) .....	28
2.6.18	LAN (RJ-45) (CN39, CN40) .....	30
2.6.19	COM Port 2 and COM Port 3 (CN41) .....	31
2.6.20	VGA Port (CN42) .....	33
2.6.21	eDP Port (CN43) .....	34
2.6.22	mSATA(Default) and MiniCard Slot (Full-MiniCard) (CN44) .....	35
2.6.23	MiniCard Slot (Full-MiniCard) (CN45) .....	38
2.6.24	VGA connector (CN46) .....	41
2.6.25	DDR3L SO-DIMM Slot (DIMM1) .....	42
<b>Chapter 3</b>	<b>- AMI BIOS Setup .....</b>	<b>43</b>
3.1	System Test and Initialization .....	44
3.2	AMI BIOS Setup .....	45
3.3	Setup submenu: Main .....	46
3.4	Setup submenu: Advanced .....	47
3.4.1	Advanced: CPU Configuration .....	48
3.4.2	Advanced: SATA Configuration .....	50
3.4.3	Advanced: PCI Express Configuration .....	52
3.4.4	Advanced: Hardware Monitor .....	53
3.4.4.1	Hardware Monitor: CPU Smart Fan Mode Configuration ..	54
3.4.5	Advanced: SIO Configuration .....	55

3.4.5.1	SIO Configuration: Serial Port 1 Configuration.....	56
3.4.5.2	SIO Configuration: Serial Port 2 Configuration.....	57
3.4.5.3	SIO Configuration: Serial Port 3 Configuration.....	58
3.4.5.4	SIO Configuration: Serial Port 4 Configuration.....	59
3.4.5.5	SIO Configuration: Serial Port 5 Configuration.....	60
3.4.5.6	SIO Configuration: Serial Port 6 Configuration.....	61
3.4.5.7	SIO Configuration: Serial Port 7 Configuration.....	62
3.4.5.8	SIO Configuration: Serial Port 8 Configuration.....	63
3.4.5.9	SIO Configuration: Serial Port 9 Configuration.....	64
3.4.5.10	SIO Configuration: Serial Port 10 Configuration.....	65
3.4.5.11	SIO Configuration: Serial Port 11 Configuration.....	66
3.4.5.12	SIO Configuration: Serial Port 12 Configuration.....	67
3.4.6	Advanced: Power Management.....	68
3.4.7	Advanced: Digital IO Port Configuration.....	69
3.5	Setup submenu: Chipset.....	70
3.5.1	Chipset: North Bridge.....	71
3.5.1.1	North Bridge: LVDS Panel Configuration.....	72
3.6	Setup submenu: Security.....	75
3.7	Setup submenu: Boot.....	76
3.8	Setup submenu: Save & Exit.....	77
<b>Chapter 4</b>	<b>Drivers Installation.....</b>	<b>78</b>
4.1	Driver Download/Installation.....	79
<b>Appendix A</b>	<b>- Watchdog Timer Programming.....</b>	<b>81</b>
A.1	Watchdog Timer Registers.....	82
A.2	Watchdog Sample Program.....	83
<b>Appendix B</b>	<b>- I/O Information.....</b>	<b>86</b>
B.1	I/O Address Map.....	87
B.2	Memory Address Map.....	89

B.3	IRQ Mapping Chart.....	90
<b>Appendix C – Mating Connectors.....</b>		<b>95</b>
C.1	List of Mating Connectors and Cables.....	96
<b>Appendix D – Digital I/O Ports .....</b>		<b>97</b>
D.1	Digital I/O Register.....	98
D.2	Digital I/O Sample Code (4 in 4 out, 2 low 2 high).....	100

# Chapter 1

---

Product Specifications

## 1.1 Specifications

---

### System

Form Factor	3.5" SubCompact Board
CPU	Intel® Pentium® N4200/ Celeron® N3350 Processor SoC
CPU Frequency	Up to 2.5 GHz
Chipset	Intel® Pentium® N4200/ Celeron® N3350 Processor SoC
Memory Type	DDR3L 1866MHz, SODIMM x 1
Max. Memory Capacity	Up to 8GB
BIOS	AMI
Wake on LAN	Yes
Watchdog Timer	255 Levels
Power Requirement	12V Only
Power Supply Type	AT/ ATX
Power Consumption (Typical)	Intel® N4200,DDR3L 1600MHz 8GB,1.61A@+12V
Dimension (L x W)	5.75" x 4" (146 mm x 101.7 mm)
Operating Temperature	32°F ~ 140°F (0°C ~ 60°C)
Storage Temperature	-40°F ~ 176°F (-40°C ~ 85°C)
Operating Humidity	0% ~ 90% relative humidity, non-condensing
MTBF (Hours)	126,000



## System

Certification	CE/FCC
---------------	--------

## I/O

Ethernet	Realtek RTL-8111E, RJ-45 x 2
Audio	High Definition Audio Interface (Option: 2W Amp)
USB Port	Rear I/O: USB 3.0 x 2 Internal: USB2.0 x 8
Serial Port	Rear I/O: COM x 2 (COM2 is RS-232/422/485) Internal: COM x 4 (Option to COM x 10) COM2-5 support 5V/12V/RI
Parallel Port	—
HDD Interface	SATA 3.0 x 1
FDD Interface	—
SSD	mSATA x 1 (Full, optional for mini-card)
Expansion Slot	Mini-card x 1 (Full size)
DIO	8-bit
SIM	Micro SIM x 1 (Option)
TPM	—
Touch	—

## Display

VGA/LCD Controller	Intel® Pentium® N4200/ Celeron® N3350 Processor SoC
Video Output	VGA/LVDS1 (Option: LVDS2/eDP)
Backlight inverter supply	Max 12V, 2A

# Chapter 2

---

Hardware Information

## 2.1 Dimensions

### Component Side

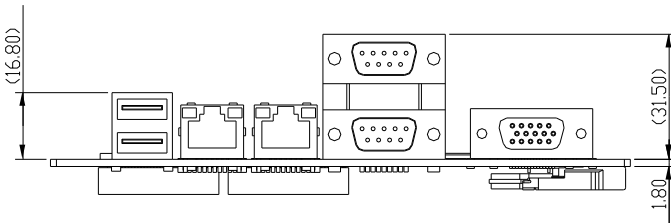
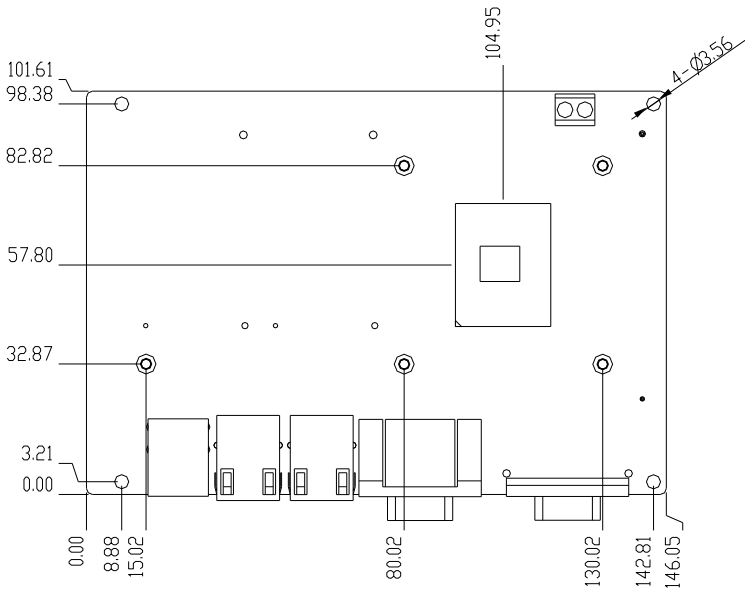

### Solder Side

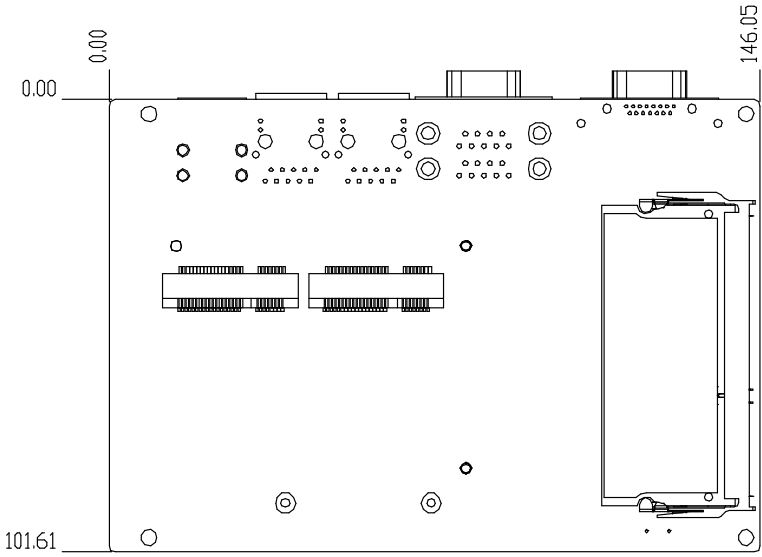

## 2.2 Jumpers and Connectors

### Component Side

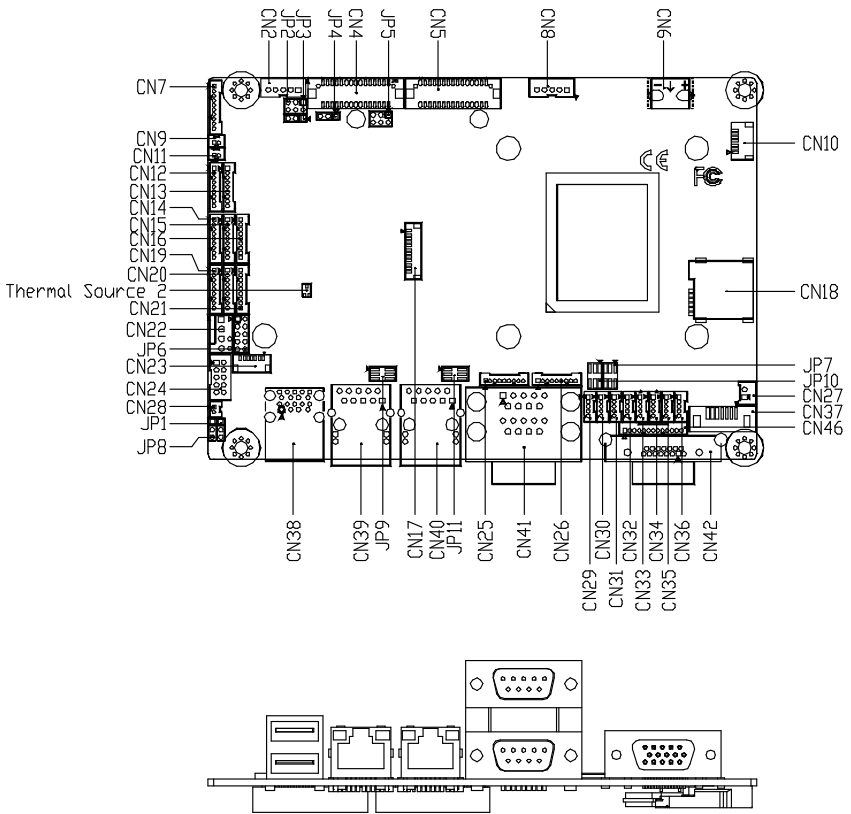

Solder Side

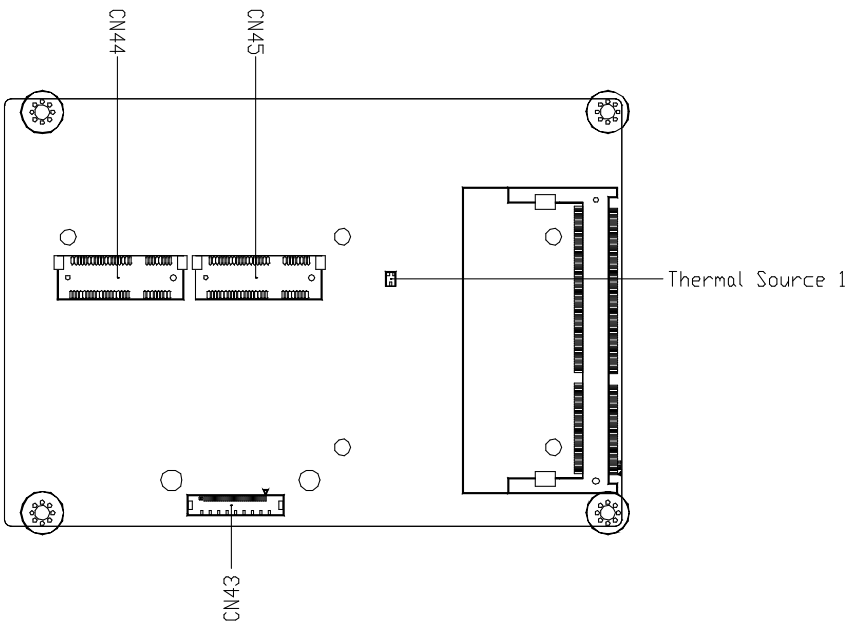

## 2.3 Assembly Options

Optional accessory for GENE-APL7-HSK01

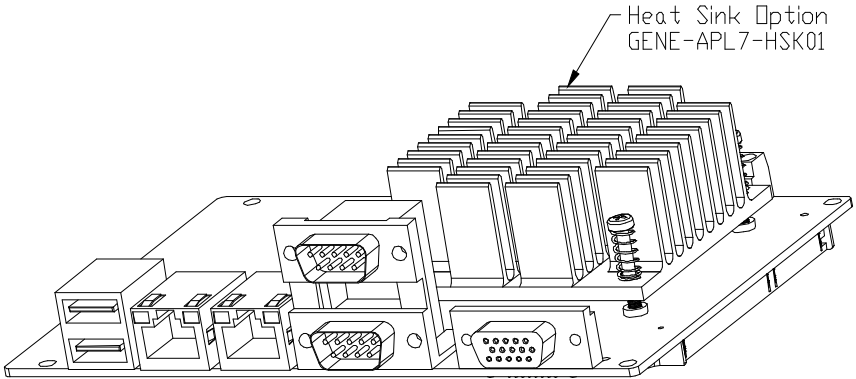



## 2.4 Block Diagram

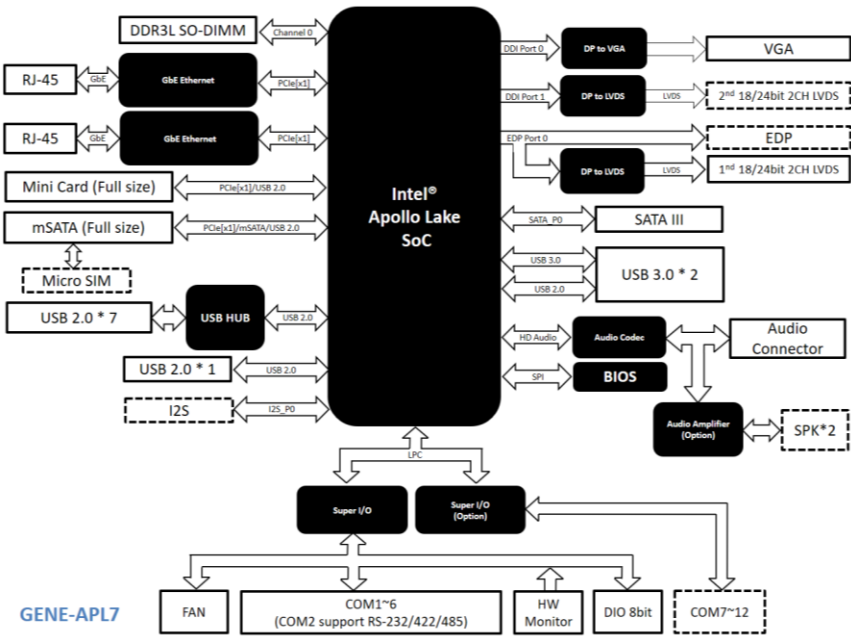

## 2.5 List of Jumpers

---

Please refer to the table below for all of the board's jumpers that you can configure for your application

Label	Function
JP1	Clear CMOS Jumper
JP2	LVDS1/eDP VDD and BLKT VCC Selection
JP3	LVDS1/eDP BLKT Control Mode Selection
JP4	LVDS2 Port BLKT Control Mode Selection
JP5	LVDS2 Port VDD and BLKT VCC Selection
JP6	Front Panel Connector
JP7	COM2 Pin8 Function Selection
JP8	Auto Power Button Enable/Disable Selection
JP9	COM1 Pin8 Function Selection
JP10	COM3 Pin8 Function Selection
JP11	COM4 Pin8 Function Selection

### 2.5.1 Clear CMOS Jumper (JP1)

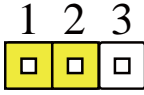

Normal (1-2) (Default)

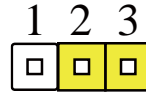

Clear CMOS (2-3)

### 2.5.2 LVDS1 and eDP Port Operating VDD/BKLT Selection (JP2)

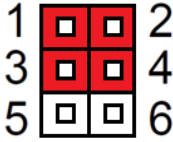

+12V LVDS / eDP BKLT (1-3)

+5V LVDS / eDP VDD (2-4)

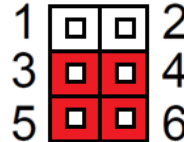

+5V LVDS / eDP BKLT (3-5) (Default)

+3.3V LVDS / eDP VDD (4-6) (Default)

### 2.5.3 LVDS and eDP Port BLKT Control Mode Selection (JP3)

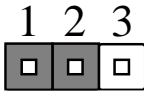

LVDS and eDP VR Mode (1-2) (Default)

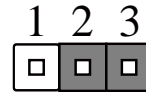

LVDS and eDP PWM Mode (2-3)

### 2.5.4 LVDS2 BLKT Control Mode Selection (JP4)

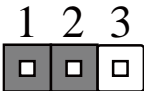

LVDS2VR Mode (1-2) (Default)



LVDS2PWM Mode (2-3)

## 2.5.5 LVDS2 Operating VDD/BKLT Selection (JP5)

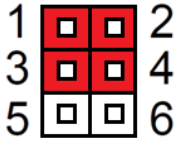

+12V LVDS2 BKLT (1-3)

+5V LVDS2 VDD (2-4)

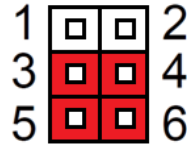

+5V LVDS2 BKLT (3-5) (Default)

+3.3V LVDS2VDD (4-6) (Default)

## 2.5.6 Front Panel Connector (JP6)

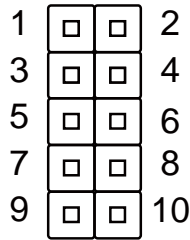

Pin	Pin Name	Pin	Pin Name
1	PWR_BTN-	2	PWR_BTN+
3	HDD_LED-	4	HDD_LED+
5	SPEAKER-	6	SPEAKER+
7	PWR_LED-	8	PWR_LED+
9	H/W RESET-	10	H/W RESET+

### 2.5.7 COM1~4 Function Selection (JP7, JP9, JP10, JP11)

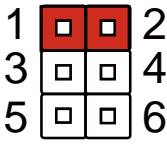

+12V (1-2)

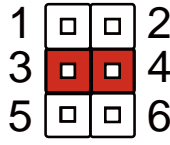

Ring (3-4) (Default)

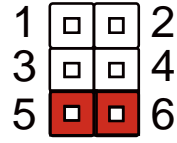

+5V (5-6)

### 2.5.8 Auto Power Button Enable/Disable Selection (JP8)

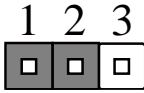

ATX Mode (1-2)

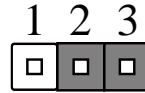

AT Mode (2-3) (Default)

## 2.6 List of Connectors

Please refer to the table below for all of the board's connectors that you can configure for your application

Label	Function
CN2	LVDS/eDP Port Inverter / Backlight Connector
CN4	LVDS1/eDP Port
CN5	LVDS2 Port
CN6	External +12V Input
CN7	Audio I/O Port
CN8	LVDS2 Port Inverter / Backlight Connector
CN9	Speaker (Left)
CN10	I2S I/O Port
CN11	Speaker (Right)
CN12	COM Port 9
CN13	COM Port 10
CN14	COM Port 12
CN15	COM Port 11
CN16	COM Port 5
CN17	LPC and I2C Port
CN18	Micro SIM Card Socket
CN19	COM Port 8
CN20	COM Port 7
CN21	COM Port 6
CN22	CPU FAN (Optional)
CN23	SPI Debug Port
CN24	8bit DIO Port
CN25	COM Port 1

Label	Function
CN26	COM Port 4
CN27	+5V Output for SATA HDD
CN28	RTC Battery
CN29	USB 2.0 Port 5
CN30	USB 2.0 Port 4
CN31	USB 2.0 Port 3
CN32	USB 2.0 Port 2
CN33	USB 2.0 Port 6
CN34	USB 2.0 Port 7
CN35	USB 2.0 Port 8
CN36	USB 2.0 Port 9
CN37	3.0 SATA Port
CN38	USB 3.0 Ports 0 and 1
CN39	LAN (RJ-45) Port2
CN40	LAN (RJ-45) Port1
CN41A	COM Port 2
CN41B	COM Port 3
CN42	VGA Port
CN43	eDP Port
CN44	mSATA(Default) and MiniCard Slot(Full-MiniCard)
CN45	MiniCard Slot (Full-MiniCard)
CN46	VGA Pin Header
DIMM1	DDR3L SO-DIMM Slot

## 2.6.1 LVDS and eDP Port Inverter / Backlight Connector (CN2, CN8)

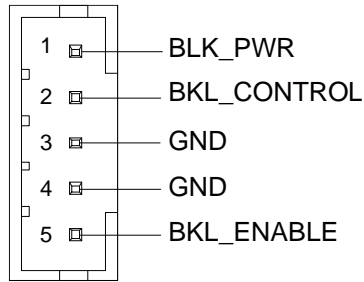

Pin	Pin Name	Signal Type	Signal level
1	BKL_PWR	PWR	+5V / +12V
2	BKL_CONTROL	OUT	
3	GND	GND	
4	GND	GND	
5	BKL_ENABLE	OUT	+3.3V



## 2.6.2 LVDS Port (CN4, CN5)

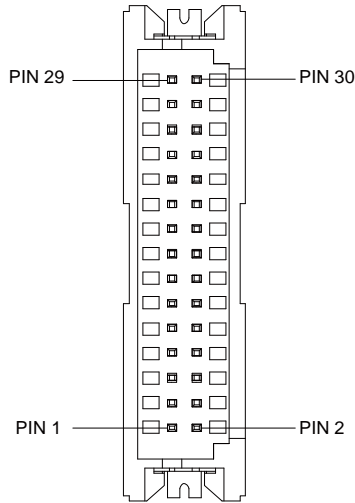

Pin	Pin Name	Signal Type	Signal level
1	BKL_ENABLE	OUT	
2	BKL_CONTROL	OUT	
3	LCD_PWR	PWR	+3.3V/+5V
4	GND	GND	
5	LVDS_A_CLK-	DIFF	
6	LVDS_A_CLK+	DIFF	
7	LCD_PWR	PWR	+3.3V/+5V
8	GND	GND	
9	LVDS_DA0-	DIFF	
10	LVDS_DA0+	DIFF	

11	LVDS_DA1-	DIFF	
12	LVDS_DA1+	DIFF	
13	LVDS_DA2-	DIFF	
14	LVDS_DA2+	DIFF	
15	LVDS_DA3-	DIFF	
16	LVDS_DA3+	DIFF	
17	DDC_DATA	I/O	+3.3V
18	DDC_CLK	I/O	+3.3V
19	LVDS_DB0-	DIFF	
20	LVDS_DB0+	DIFF	
21	LVDS_DB1-	DIFF	
22	LVDS_DB1+	DIFF	
23	LVDS_DB2-	DIFF	
24	LVDS_DB2+	DIFF	
25	LVDS_DB3-	DIFF	
26	LVDS_DB3+	DIFF	
27	LCD_PWR	PWR	+3.3V/+5V
28	GND	GND	
29	LVDS_B_CLK-	DIFF	
30	LVDS_B_CLK+	DIFF	

### 2.6.3 External +12V Input (CN6)

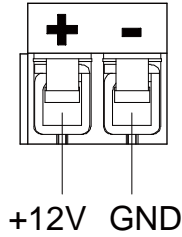

Pin	Pin Name	Signal Type	Signal Level
1	+12V	PWR	+12V
2	GND	GND	

### 2.6.4 Audio I/O Port (CN7)

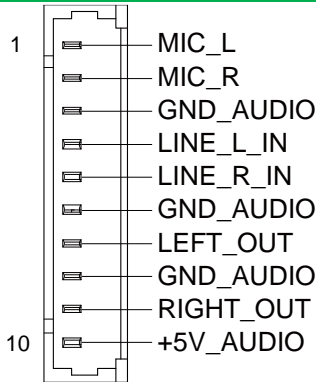

Pin	Pin Name	Signal Type	Signal Level
1	MIC_L	IN	
2	MIC_R	IN	
3	GND_AUDIO	GND	
4	LINE_L_IN	IN	
5	LINE_R_IN	IN	
6	GND_AUDIO	GND	

7	LEFT_OUT	OUT	
8	GND_AUDIO	GND	
9	RIGHT_OUT	OUT	
10	+5V_AUDIO	PWR	+5V

### 2.6.5 Speaker (Left) (CN9)

Pin	Pin Name	Signal Type	Signal Level
1	SPK_L+	OUT	
2	SPK_L-	OUT	

### 2.6.6 I2S I/O Port (CN10)

Pin	Pin Name	Signal Type	Signal Level
1	I2S_MCLK	OUT	
2	GND	GND	
3	I2S_BCLK	OUT	
4	+V1.8A	PWR	+1.8V
5	I2S_SDI	IN	
6	I2S_SDO	OUT	
7	I2S_WS_SYNC	IN	

## 2.6.7 Speaker (Right) (CN11)

Pin	Pin Name	Signal Type	Signal Level
1	SPK_R+	OUT	
2	SPK_R-	OUT	

## 2.6.8 COM Port (CN12, CN13, CN14, CN15, CN16, CN19, CN20, CN21, CN25, CN26)

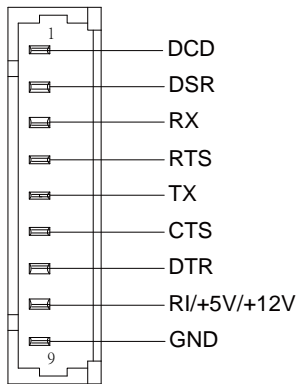

RS-232			
Pin	Pin Name	Signal Type	Signal Level
1	DCD	IN	
2	DSR	IN	
3	RX	IN	
4	RTS	OUT	±9V
5	TX	OUT	±9V
6	CTS	IN	

7	DTR	OUT	±9V
8	RI/+5V/+12V	IN/ PWR	+5V/+12V
9	GND	GND	

### 2.6.9 LPC and I2C Port (CN17)

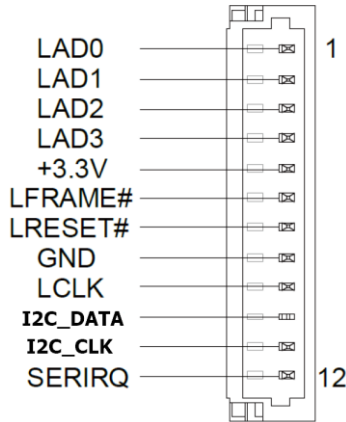

Pin	Pin Name	Signal Type	Signal Level
1	LAD0	I/O	+3.3V
2	LAD1	I/O	+3.3V
3	LAD2	I/O	+3.3V
4	LAD3	I/O	+3.3V
5	+3.3V	PWR	+3.3V
6	LFRAME#	IN	
7	LRESET#	OUT	+3.3V
8	GND	GND	

9	LCLK	OUT	
10	I2C DATA	I/O	
11	I2C CLK	I/O	
12	SERIRQ	I/O	+3.3V

### 2.6.10 Micro SIM Card Socket (CN18)

Pin	Pin Name	Signal Type	Signal Level
1	UIM_PWR	PWR	
2	UIM_RST	IN	
3	UIM_CLK	IN	
4	GND	GND	
5	UIM_VPP	PWR	
6	UIM_DATA	I/O	

### 2.6.11 CPU FAN (Optional) (CN22)

Pin	Pin Name	Signal Type	Signal Level
1	GND	GND	
2	FAN_POWER	PWR	+12V
3	FAN_TAC	IN	

## 2.6.12 8bit DIO Port (CN24)

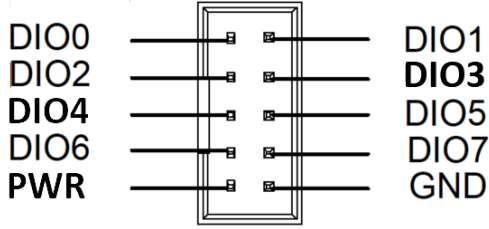

Pin	Pin Name	Signal Type	Signal Level
1	GPIO0	I/O	+5V
2	GPIO1	I/O	+5V
3	GPIO2	I/O	+5V
4	GPIO3	I/O	+5V
5	GPIO4	I/O	+5V
6	GPIO5	I/O	+5V
7	GPIO6	I/O	+5V
8	GPIO7	I/O	+5V
9	+5V	PWR	+5V
10	GND	GND	



### 2.6.13 +5V Output for SATA HDD (CN27)

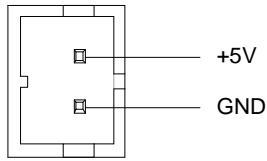

Pin	Pin Name	Signal Type	Signal Level
1	+5V	PWR	+5V
2	GND	GND	

### 2.6.14 RTC Battery (CN28)

Pin	Pin Name	Signal Type	Signal Level
1	+3.3V	PWR	3.3V
2	GND	GND	

### 2.6.15 USB 2.0 Port (CN29-36)

Pin	Pin Name	Signal Type	Signal Level
1	+5VSB	PWR	+5V
2	USB_D-	DIFF	
3	USB_D+	DIFF	
4	GND	GND	
5	GND	GND	

## 2.6.16 3.0 SATA Port (CN37)

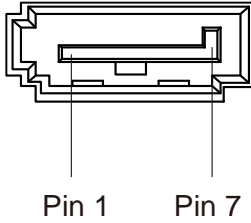

Pin	Pin Name	Signal Type	Signal Level
1	GND	GND	
2	SATA_TX+	DIFF	
3	SATA_TX-	DIFF	
4	GND	GND	
5	SATA_RX-	DIFF	
6	SATA_RX+	DIFF	
7	GND	GND	

## 2.6.17 USB Ports 0 and 1 (CN38)

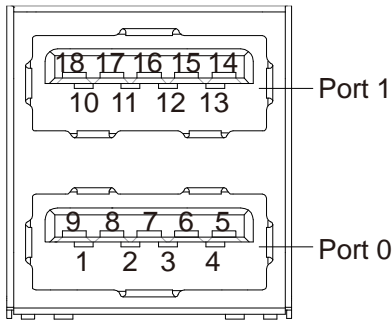

Pin	Pin Name	Signal Type	Signal Level
1	+5VSB	PWR	+5V
2	USB0_D-	DIFF	

3	USB0_D+	DIFF	
4	GND	GND	
5	USB0_SSRX-	DIFF	
6	USB0_SSRX+	DIFF	
7	GND	GND	
8	USB0_SSTX-	DIFF	
9	USB0_SSTX+	DIFF	
10	+5VSB	PWR	+5V
11	USB1_D-	DIFF	
12	USB1_D+	DIFF	
13	GND	GND	
14	USB1_SSRX-		
15	USB1_SSRX+		
16	GND	GND	
17	USB1_SSTX-		
18	USB1_SSTX+		

## 2.6.18 LAN (RJ-45) (CN39, CN40)

ACT/LINK LED      SPEED LED

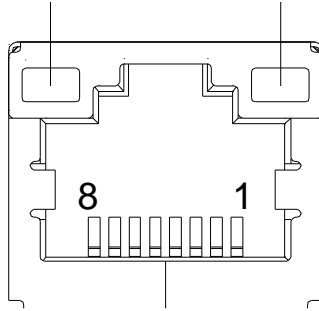

Pin	Pin Name	Signal Type	Signal Level
1	MDI0+	DIFF	
2	MDI0-	DIFF	
3	MDI1+	DIFF	
4	MDI2+	DIFF	
5	MDI2-	DIFF	
6	MDI1-	DIFF	
7	MDI3+	DIFF	
8	MDI3-	DIFF	

## 2.6.19 COM Port 2 and COM Port 3 (CN41)

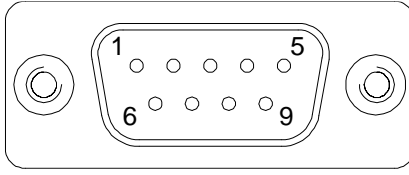

RS-232			
Pin	Pin Name	Signal Type	Signal Level
1	DCD	IN	
2	RX	IN	
3	TX	OUT	±9V
4	DTR	OUT	±9V
5	GND	GND	
6	DSR	IN	
7	RTS	OUT	±9V
8	CTS	IN	
9	RI/+5V/+12V	IN/ PWR	RI/+5V/+12V

## RS-422(only COM2)

Pin	Pin Name	Signal Type	Signal Level
1	RS422_TX-	OUT	±5V
2	RS422_TX+	OUT	±5V
3	RS422_RX+	IN	
4	RS422_RX-	IN	
5	GND	GND	
6			
7			
8			
9	NC/+5V/+12V	PWR	+5V/+12V

## RS-485(only COM2)

Pin	Pin Name	Signal Type	Signal Level
1	RS485_D-	I/O	±5V
2	RS485_D+	I/O	±5V
3			
4			
5	GND	GND	
6			
7			
8			
9	NC/+5V/+12V	PWR	+5V/+12V

## 2.6.20 VGA Port (CN42)

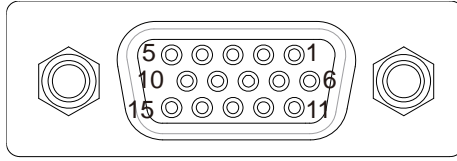

Pin	Pin Name	Signal Type	Signal Level
1	RED	OUT	Analog
2	GREEN	OUT	Analog
3	BLUE	OUT	Analog
4	NC		
5	GND	GND	
6	RED_GND_RTN	GND	
7	GREEN_GND_RTN	GND	
8	BLUE_GND_RTN	GND	
9	+5V	PWR	+5V
10	CRT_PLUG#		
11	NC		
12	DDC_DATA	I/O	+5V
13	HSYNC	OUT	
14	VSYNC	OUT	
15	DDC_CLK	I/O	+5V

## 2.6.21 eDP Port (CN43)

Pin	Pin Name	Signal Type	Signal Level
1	LCD_PWR	PWR	+3.3V/+5V
2	LCD_PWR	PWR	+3.3V/+5V
3	GND	GND	
4	GND	GND	
5	EDP_TX2_N	DIFF	
6	EDP_TX2_P	DIFF	
7	GND	GND	
8	EDP_TX1_N		
9	EDP_TX1_P		
10	GND	GND	
11	EDP_TX0_N		
12	EDP_TX0_P		
13	GND	GND	
14	EDP_TX3_N		
15	EDP_TX3_P		
16	GND	GND	
17	EDP_AUXN		
18	EDP_AUXP		
19	GND	GND	



Pin	Pin Name	Signal Type	Signal Level
20	BKLTNESS		
21	NC	NC	
22	BKLTEN		
23	eDP_HPDP		
24	GND	GND	
25	GND	GND	
26	GND	GND	
27	+VCC_BKLT_eDP	PWR	+12V/5V
28	+VCC_ BKLT_eDP	PWR	+12V/5V
29	+VCC_ BKLT_eDP	PWR	+12V/5V
30	+VCC_BKLT_eDP	PWR	+12V/5V

## 2.6.22 mSATA(Default) and MiniCard Slot (Full-MiniCard) (CN44)

Pin	Pin Name	Signal Type	Signal Level
1	PCIE_WAKE#	IN	
2	+3.3VSB	PWR	+3.3V
3	NC		
4	GND	GND	
5	NC		
6	+1.5V	PWR	+1.5V

7	PCIE_CLK_REQ#	IN	
8	NC	PWR	
9	GND	GND	
10	NC	I/O	
11	PCIE_REF_CLK-	DIFF	
12	NC	IN	
13	PCIE_REF_CLK+	DIFF	
14	NC		
15	GND	GND	
16	NC	PWR	
17	NC		
18	GND	GND	
19	NC		
20	W_DISABLE#	OUT	+3.3V
21	GND	GND	
22	PCIE_RST#	OUT	+3.3V
23	SATA_RX-	DIFF	
24	+3.3VSB	PWR	+3.3V
25	SATA_RX+	DIFF	
26	GND	GND	
27	GND	GND	

28	+1.5V	PWR	+1.5V
29	GND	GND	
30	SMB_CLK	I/O	+3.3V
31	SATA_TX-	DIFF	
32	SMB_DATA	I/O	+3.3V
33	SATA_TX+	DIFF	
34	GND	GND	
35	GND	GND	
36	USB_D-	DIFF	
37	GND	GND	
38	USB_D+	DIFF	
39	+3.3VSB	PWR	+3.3V
40	GND	GND	
41	+3.3VSB	PWR	+3.3V
42	NC		
43	GND	GND	
44	NC		
45	NC		
46	NC		
47	NC		
48	+1.5V	PWR	+1.5V

49	NC		
50	GND	GND	
51	NC		
52	+3.3VSB	PWR	+3.3V

### 2.6.23 MiniCard Slot (Full-MiniCard) (CN45)

Pin	Pin Name	Signal Type	Signal Level
1	PCIE_WAKE#	IN	
2	+3.3VSB	PWR	+3.3V
3	NC		
4	GND	GND	
5	NC		
6	+1.5V	PWR	+1.5V
7	PCIE_CLK_REQ#	IN	
8	NC	PWR	
9	GND	GND	
10	NC	I/O	
11	PCIE_REF_CLK-	DIFF	
12	NC	IN	
13	PCIE_REF_CLK+	DIFF	
14	NC		

15	GND	GND	
16	NC	PWR	
17	NC		
18	GND	GND	
19	NC		
20	W_DISABLE#	OUT	+3.3V
21	GND	GND	
22	PCIE_RST#	OUT	+3.3V
23	PCIE_RX-	DIFF	
24	+3.3VSB	PWR	+3.3V
25	PCIE_RX+	DIFF	
26	GND	GND	
27	GND	GND	
28	+1.5V	PWR	+1.5V
29	GND	GND	
30	SMB_CLK	I/O	+3.3V
31	PCIE_TX-	DIFF	
32	SMB_DATA	I/O	+3.3V
33	PCIE_TX+	DIFF	
34	GND	GND	
35	GND	GND	

36	USB_D-	DIFF	
37	GND	GND	
38	USB_D+	DIFF	
39	+3.3VSB	PWR	+3.3V
40	GND	GND	
41	+3.3VSB	PWR	+3.3V
42	NC		
43	GND	GND	
44	NC		
45	NC		
46	NC		
47	NC		
48	+1.5V	PWR	+1.5V
49	NC		
50	GND	GND	
51	NC		
52	+3.3VSB	PWR	+3.3V

## 2.6.24 VGA connector (CN46)

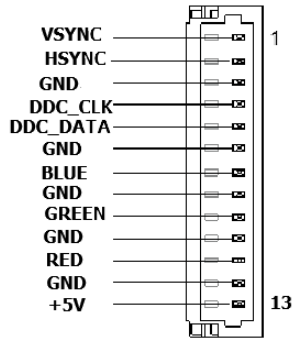

Pin	Pin Name	Signal Type	Signal level
1	VSYNC	OUT	
2	HSYNC	OUT	
3	GND	GND	
4	DDC_CLK	I/O	
5	DDC_DAT	I/O	
6	GND	GND	
7	BLUE	Out	Analog
8	GND	GND	
9	GREEN	Out	Analog
10	GND	GND	
11	RED	Out	Analog
12	GND	GND	
13	+5V	PWR	

## 2.6.25 DDR3L SO-DIMM Slot (DIMM1)

---

Standard Specification



# Chapter 3

---

AMI BIOS Setup

## 3.1 System Test and Initialization

---

The board uses certain routines to perform testing and initialization. If an error, fatal or non-fatal, is encountered, a few short beeps or an error message will be outputted. The board can usually continue the boot up sequence with non-fatal errors.

The system configuration verification routines check the current system configuration against the values stored in the CMOS memory. If they do not match, an error message will be outputted, in which case you will need to run the BIOS setup program to set the configuration information in memory.

There are three situations in which you will need to change the CMOS settings:

- You are starting your system for the first time
- You have changed your system's hardware
- The CMOS memory has lost power and the configuration information is erased

The system's CMOS memory uses a backup battery for data retention, which is to be replaced once emptied.

## 3.2 AMI BIOS Setup

---

The AMI BIOS ROM has a pre-installed Setup program that allows users to modify basic system configurations, which is stored in the battery-backed CMOS RAM and BIOS NVRAM so that the information is retained when the power is turned off.

To enter BIOS Setup, press <Del> or <F2> immediately while your computer is powering up.

The function for each interface can be found below.

**Main** – Date and time can be set here. Press <Tab> to switch between date elements

**Advanced** – Enable/ Disable boot option for legacy network devices

**Chipset** – For hosting bridge parameters

**Boot** – Enable/ Disable quiet Boot Option

**Security** – The setup administrator password can be set here

**Save & Exit** – Save your changes and exit the program

### 3.3 Setup submenu: Main



### 3.4 Setup submenu: Advanced

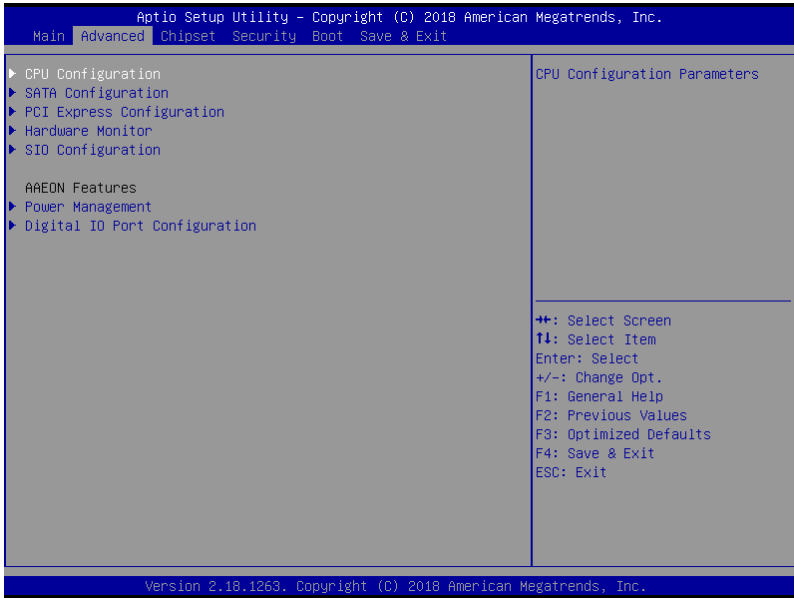

### 3.4.1 Advanced: CPU Configuration

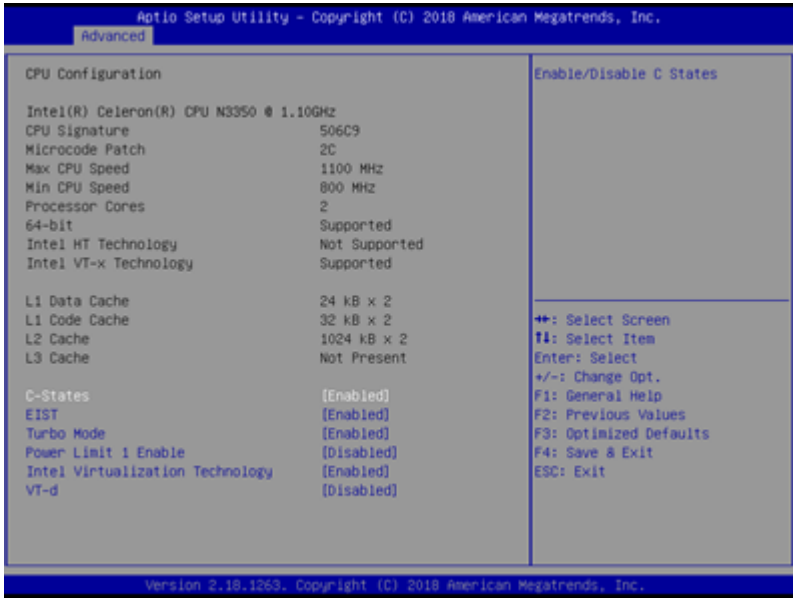

Options summary:

C-States	Disabled	
	Enabled	Optimal Default, Failsafe Default
Enable/Disable C States.		
EIST	Disabled	
	Enabled	Optimal Default, Failsafe Default
Enable/Disable Intel SpeedStep.		
Turbo Mode	Disabled	
	Enabled	Optimal Default, Failsafe Default
Turbo Mode		
Power Limit 1 Enable	Disabled	Optimal Default, Failsafe Default
	Enabled	

Enable/Disable Power Limit 1		
Intel Virtualization Technology	Disabled	
	Enabled	Optimal Default, Failsafe Default
When enabled, a VMM can utilize the additional hardware capabilities provided by Vanderpool Technology.		
VT-d	Disabled	Optimal Default, Failsafe Default
	Enabled	
Enable/Disable CP VT-d		

### 3.4.2 Advanced: SATA Configuration

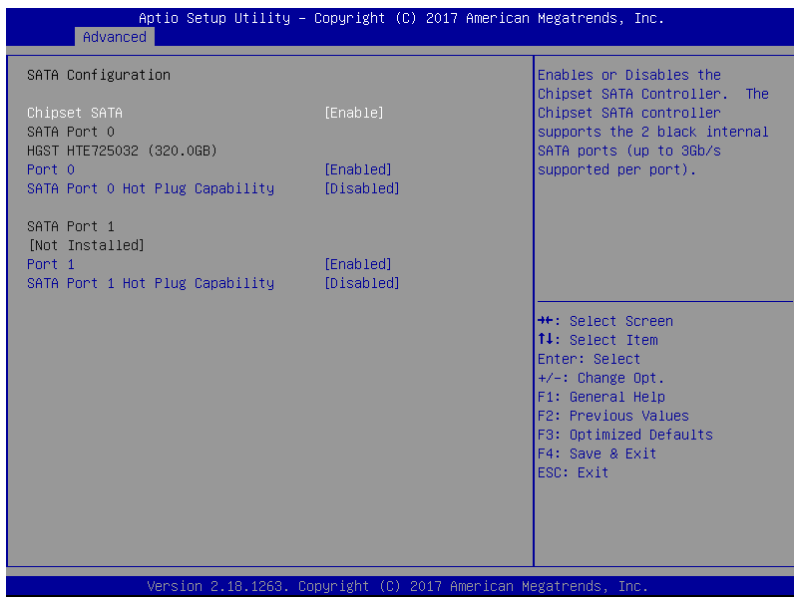

Options summary:

Chipset SATA	Disabled	
	Enabled	Optimal Default, Failsafe Default
Enables or Disables the Chipset SATA Controller. The Chipset SATA controller supports the 2 black internal SATA ports (up to 3Gb/s supported per port).		
Port 0	Disabled	
	Enabled	Optimal Default, Failsafe Default
Enable or Disable SATA Port		
SATA Port 0 Hot Plug Capability	Disabled	Optimal Default, Failsafe Default
	Enabled	
If enabled, SATA port will be reported as Hot Plug capable.		



Port 1	Disabled	
	Enabled	Optimal Default, Failsafe Default
Enable or Disable SATA Port		
SATA Port 1 Hot Plug Capability	Disabled	Optimal Default, Failsafe Default
	Enabled	
If enabled, SATA port will be reported as Hot Plug capable.		

### 3.4.3 Advanced: PCI Express Configuration



Options summary:

PCIE Slot(CN45)	Disabled	
	Enabled	Optimal Default, Failsafe Default
Control PCIE Slot (CN45)		
Hot Plug	Disabled	Optimal Default, Failsafe Default
	Enabled	
PCI Express Hot Plug Enable/Disable		
PCIE Speed	Auto	Optimal Default, Failsafe Default
	Gen1	
	Gen2	
Configure PCIe Speed(CN45)		

### 3.4.4 Advanced: Hardware Monitor

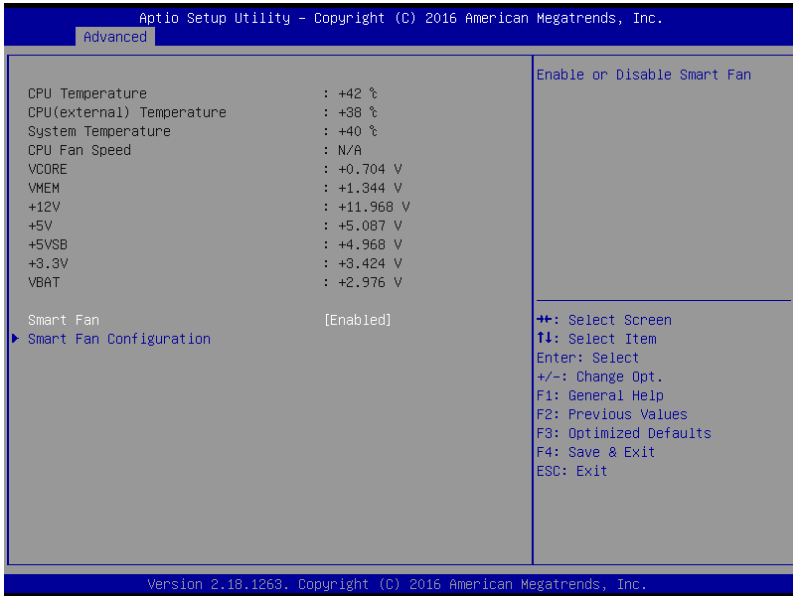

Options summary:

Smart Fan	Disable	
	Enable	Optimal Default, Failsafe Default
Enables or Disables Smart Fan.		

### 3.4.4.1 Hardware Monitor: CPU Smart Fan Mode Configuration

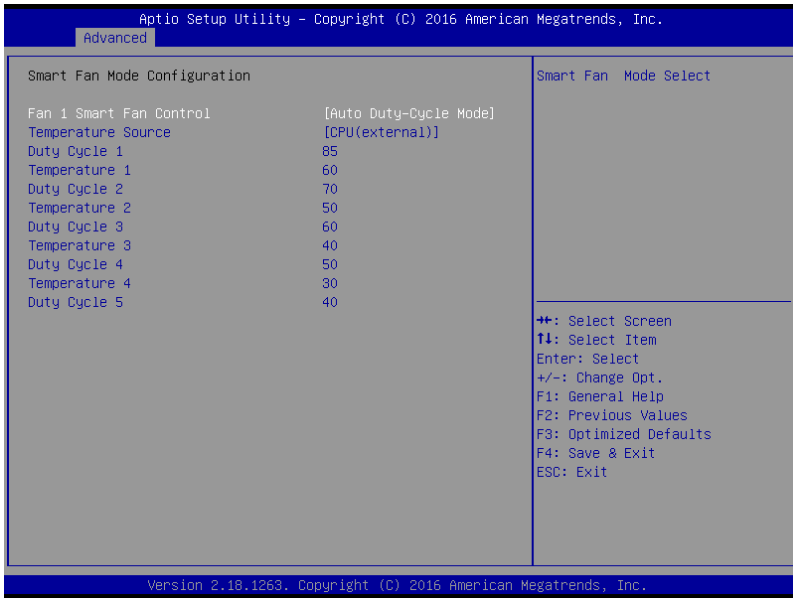

Options summary:

Fan 1 Smart Fan	Manual Duty Mode	
Control	Auto Duty-Cycle Mode	Optimal Default, Failsafe Default
Smart Fan Mode Select		
Temperature Source	CPU(external)	Optimal Default, Failsafe Default
	System	
Select the monitored temperature source for this fan.		
Duty Cycle 1	85	
Temperature 1	60	
Auto fan speed control. Fan speed will follow different temperature by different duty cycle 1-100		

### 3.4.5 Advanced: SIO Configuration

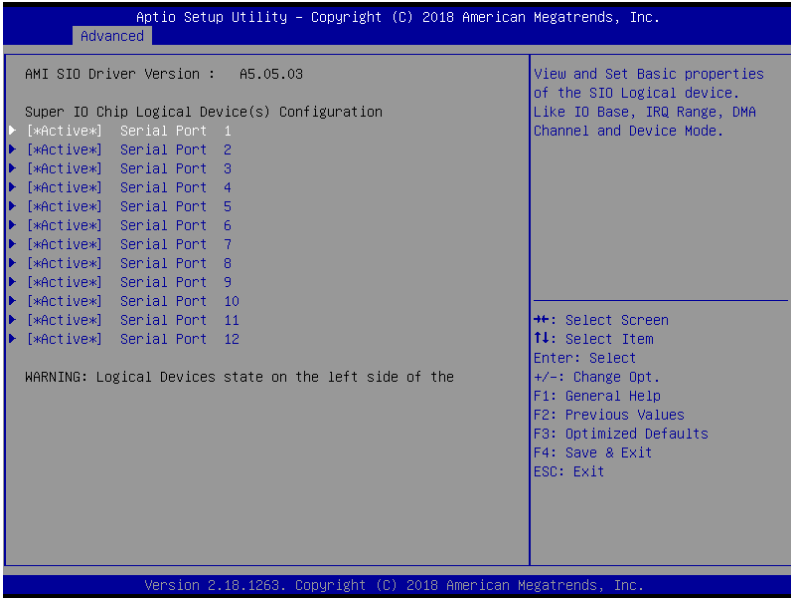

### 3.4.5.1 SIO Configuration: Serial Port 1 Configuration



Options summary:

Use This Device	Disable	
	Enable	Optimal Default, Failsafe Default
Enable or Disable this Logical Device.		
Possible:	Use Automatic Settings	Optimal Default, Failsafe Default
	IO=3F8h; IRQ=11	
	IO=2F8h; IRQ=11	
Allows user to change Device's Resource settings. New settings will be reflected on This Setup Page after System restarts.		

### 3.4.5.2 SIO Configuration: Serial Port 2 Configuration

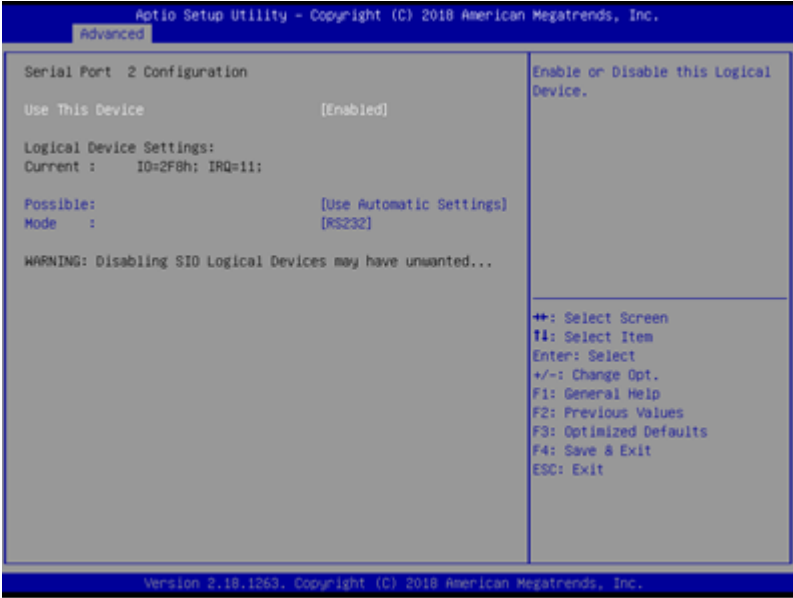

Options summary:

Use This Device	Disable	
	Enable	Optimal Default, Failsafe Default
Enable or Disable this Logical Device.		
Possible:	Use Automatic Settings	Optimal Default, Failsafe Default
	IO=2F8h; IRQ=11	
	IO=3F8h; IRQ=11	
Allows user to change Device's Resource settings. New settings will be reflected on This Setup Page after System restarts.		
Mode:	RS232	Optimal Default, Failsafe Default
	RS422	
	RS485	
UART RS232, 422, 485 selection.		

### 3.4.5.3 SIO Configuration: Serial Port 3 Configuration



Options summary:

Use This Device	Disable	
	Enable	Optimal Default, Failsafe Default
Enable or Disable this Logical Device.		
Possible:	Use Automatic Settings	Optimal Default, Failsafe Default
	IO=3E8h; IRQ=11	
	IO=2E8h; IRQ=11	
Allows user to change Device's Resource settings. New settings will be reflected on This Setup Page after System restarts.		
Mode:	RS232	Optimal Default, Failsafe Default
	RS422	
	RS485	
UART RS232, 422, 485 selection.		



### 3.4.5.4 SIO Configuration: Serial Port 4 Configuration

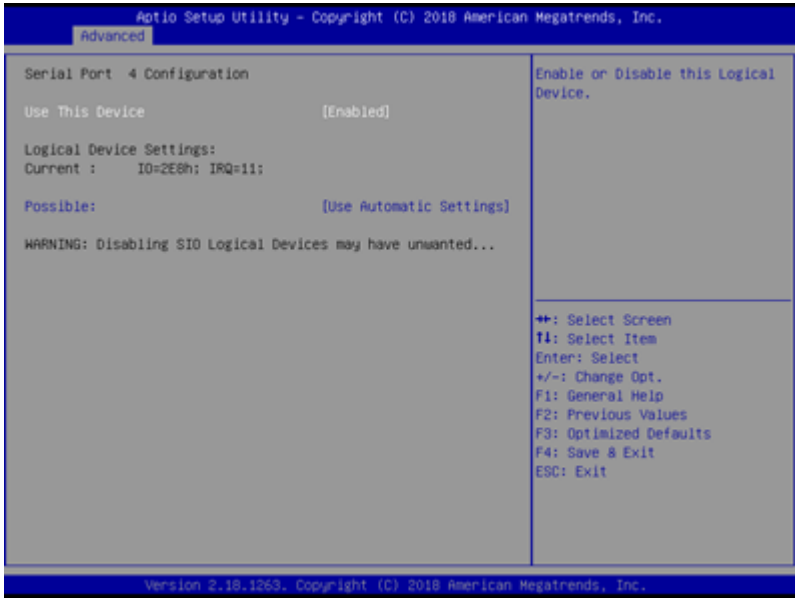

Options summary:

Use This Device	Disable	
	Enable	Optimal Default, Failsafe Default
Enable or Disable this Logical Device.		
Possible:	Use Automatic Settings	Optimal Default, Failsafe Default
	IO=2E8h; IRQ=11	
	IO=3E8h; IRQ=11	
Allows user to change Device's Resource settings. New settings will be reflected on This Setup Page after System restarts.		

### 3.4.5.5 SIO Configuration: Serial Port 5 Configuration

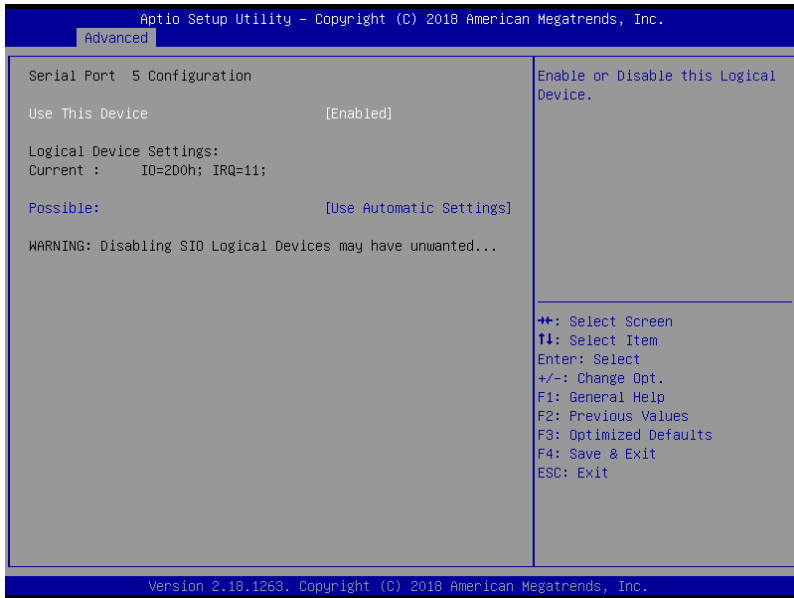

Options summary:

Use This Device	Disable	
	Enable	Optimal Default, Failsafe Default
Enable or Disable this Logical Device.		
Possible:	Use Automatic Settings	Optimal Default, Failsafe Default
	IO=2D0h; IRQ=11	
	IO=2C0h; IRQ=11	
Allows user to change Device's Resource settings. New settings will be reflected on This Setup Page after System restarts.		

### 3.4.5.6 SIO Configuration: Serial Port 6 Configuration

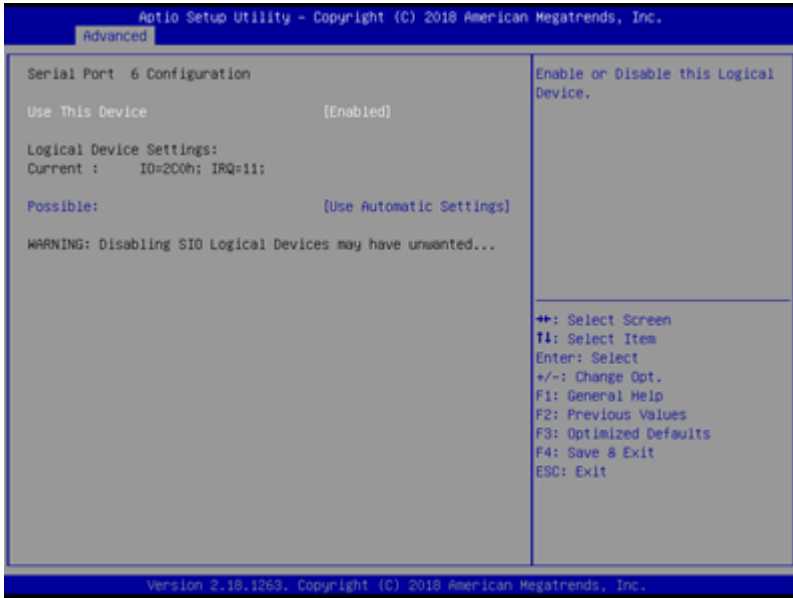

Options summary:

Use This Device	Disable	
	Enable	Optimal Default, Failsafe Default
Enable or Disable this Logical Device.		
Possible:	Use Automatic Settings	Optimal Default, Failsafe Default
	IO=2C0h; IRQ=11	
	IO=2D0h; IRQ=11	
Allows user to change Device's Resource settings. New settings will be reflected on This Setup Page after System restarts.		

### 3.4.5.7 SIO Configuration: Serial Port 7 Configuration



Options summary:

Use This Device	Disable	
	Enable	Optimal Default, Failsafe Default
Enable or Disable this Logical Device.		
Possible:	Use Automatic Settings	Optimal Default, Failsafe Default
	IO=2A0h; IRQ=10	
	IO=2A8h; IRQ=10	
Allows user to change Device's Resource settings. New settings will be reflected on This Setup Page after System restarts.		

### 3.4.5.8 SIO Configuration: Serial Port 8 Configuration

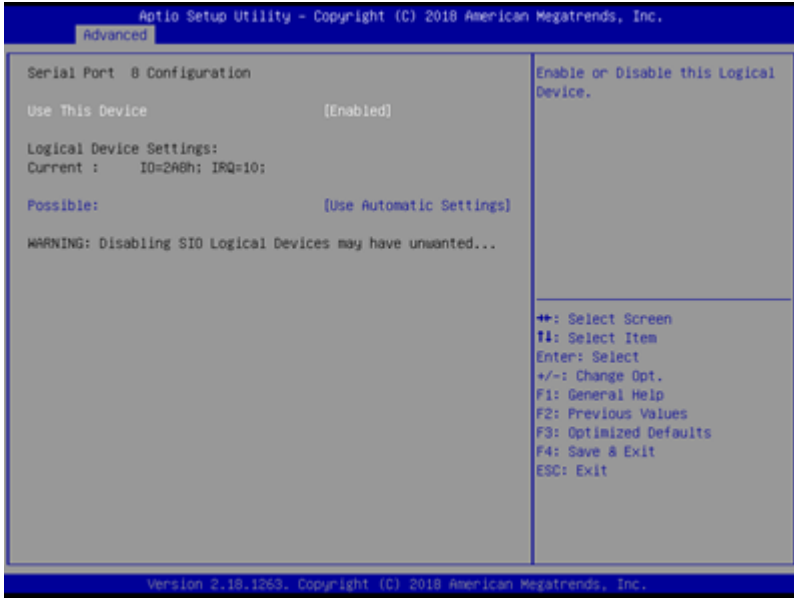

Options summary:

Use This Device	Disable	
	Enable	Optimal Default, Failsafe Default
Enable or Disable this Logical Device.		
Possible:	Use Automatic Settings	Optimal Default, Failsafe Default
	IO=2A8h; IRQ=10	
	IO=2A0h; IRQ=10	
Allows user to change Device's Resource settings. New settings will be reflected on This Setup Page after System restarts.		

### 3.4.5.9 SIO Configuration: Serial Port 9 Configuration



Options summary:

Use This Device	Disable	
	Enable	Optimal Default, Failsafe Default
Enable or Disable this Logical Device.		
Possible:	Use Automatic Settings	Optimal Default, Failsafe Default
	IO=2B0h; IRQ=10	
	IO=2B8h; IRQ=10	
Allows user to change Device's Resource settings. New settings will be reflected on This Setup Page after System restarts.		

### 3.4.5.10 SIO Configuration: Serial Port 10 Configuration

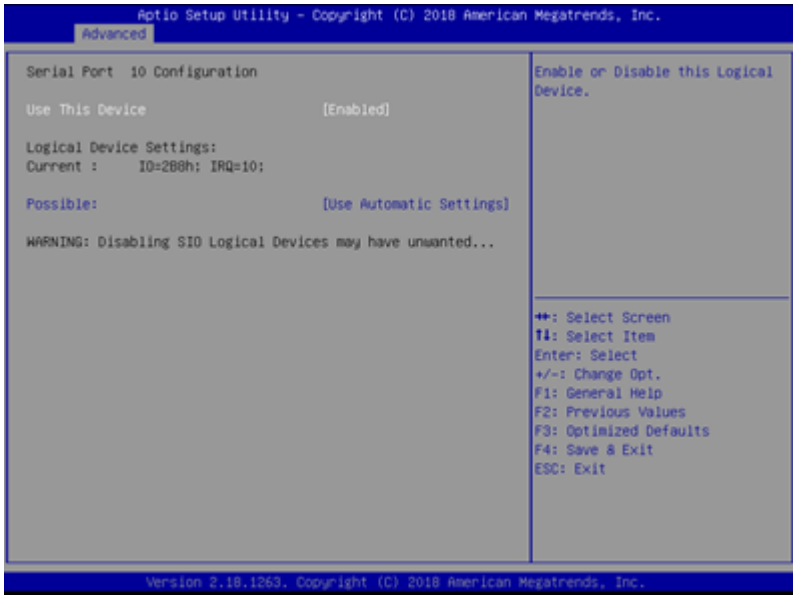

Options summary:

Use This Device	Disable	
	Enable	Optimal Default, Failsafe Default
Enable or Disable this Logical Device.		
Possible:	Use Automatic Settings	Optimal Default, Failsafe Default
	IO=2B8h; IRQ=10	
	IO=2B0h; IRQ=10	
Allows user to change Device's Resource settings. New settings will be reflected on This Setup Page after System restarts.		

### 3.4.5.11 SIO Configuration: Serial Port 11 Configuration

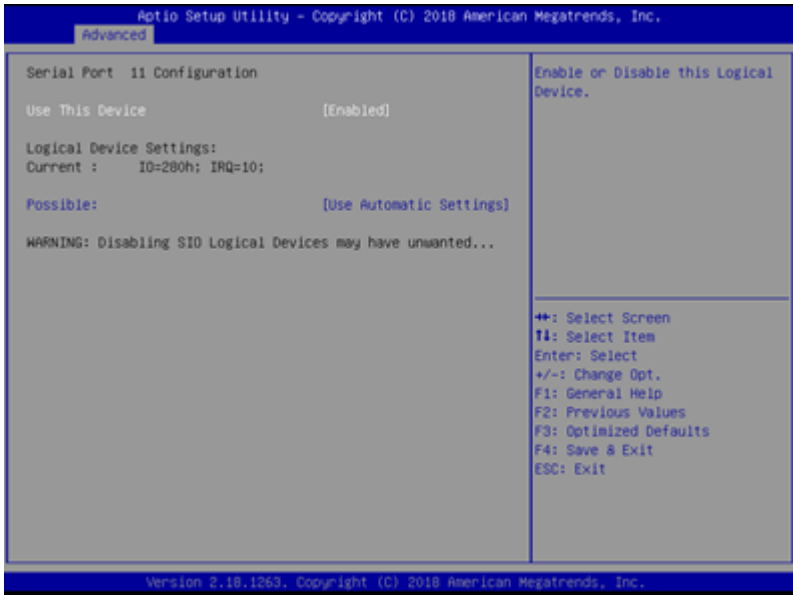

Options summary:

Use This Device	Disable	
	Enable	Optimal Default, Failsafe Default
Enable or Disable this Logical Device.		
Possible:	Use Automatic Settings	Optimal Default, Failsafe Default
	IO=280h; IRQ=10	
	IO=288h; IRQ=10	
Allows user to change Device's Resource settings. New settings will be reflected on This Setup Page after System restarts.		



### 3.4.5.12 SIO Configuration: Serial Port 12 Configuration

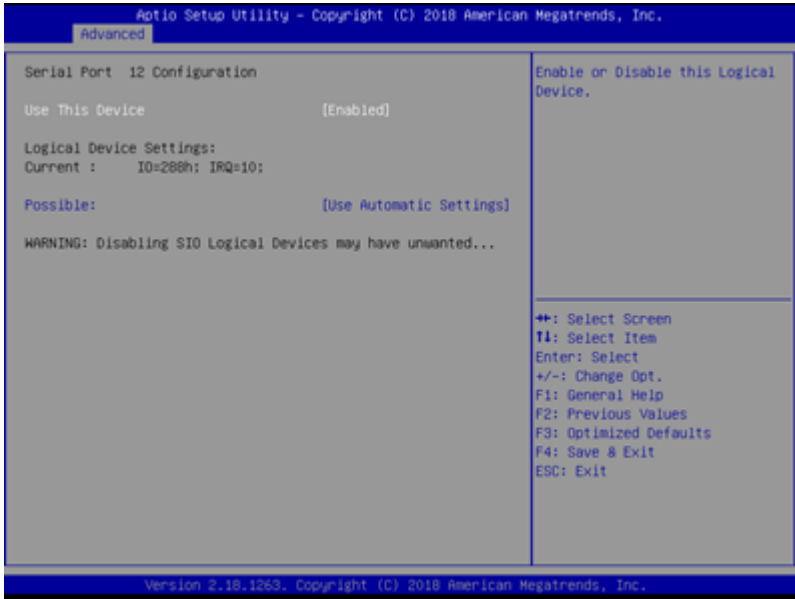

Options summary:

Use This Device	Disable	
	Enable	Optimal Default, Failsafe Default
Enable or Disable this Logical Device.		
Possible:	Use Automatic Settings	Optimal Default, Failsafe Default
	IO=288h; IRQ=10	
	IO=280h; IRQ=10	
Allows user to change Device's Resource settings. New settings will be reflected on This Setup Page after System restarts.		

### 3.4.6 Advanced: Power Management

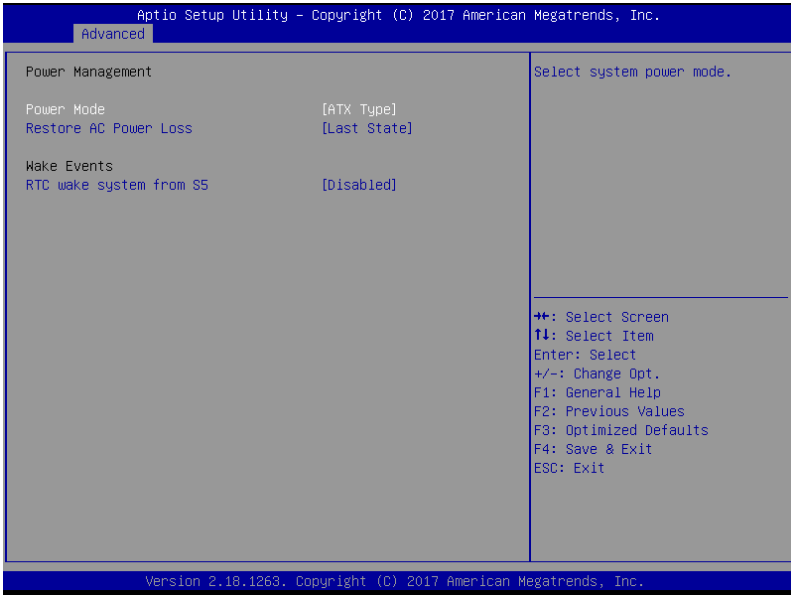

Options summary:

Power Mode	ATX Type	Optimal Default, Failsafe Default
	AT Type	
Select system power mode		
Restore AC Power Loss	Last State	Optimal Default, Failsafe Default
	Always On	
	Always Off	
RTC wake system from S5	Disable	Optimal Default, Failsafe Default
	Fixed Time	
Fixed Time: System will wake on the hr::min::sec specified.		

### 3.4.7 Advanced: Digital IO Port Configuration

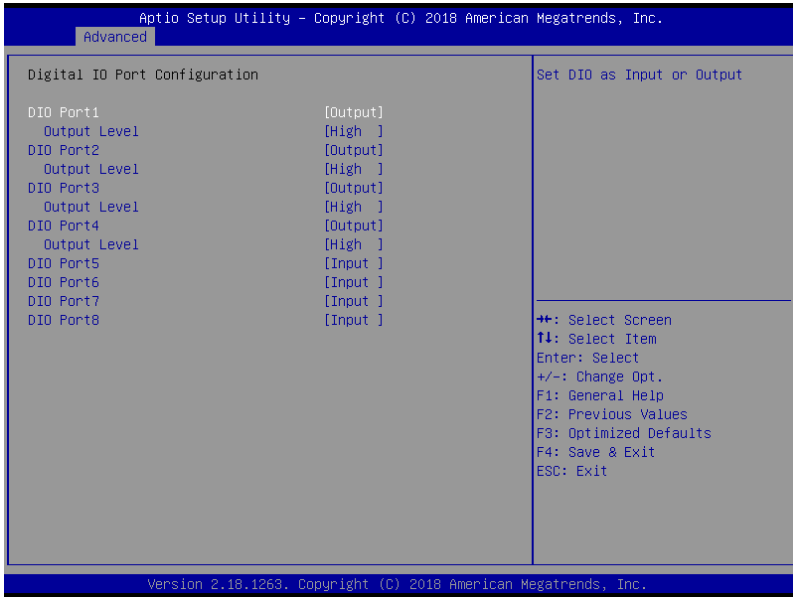

Options summary:

DIO Port*	Output	
	Input	
Set DIO as Input or Output		
Output Level	High	Optimal Default, Failsafe Default
	Low	
Set output level when DIO pin is output		

### 3.5 Setup submenu: Chipset



### 3.5.1 Chipset: North Bridge



### 3.5.11 North Bridge: LVDS Panel Configuration

\* LVDS2 only available for 2 LVDS SKU

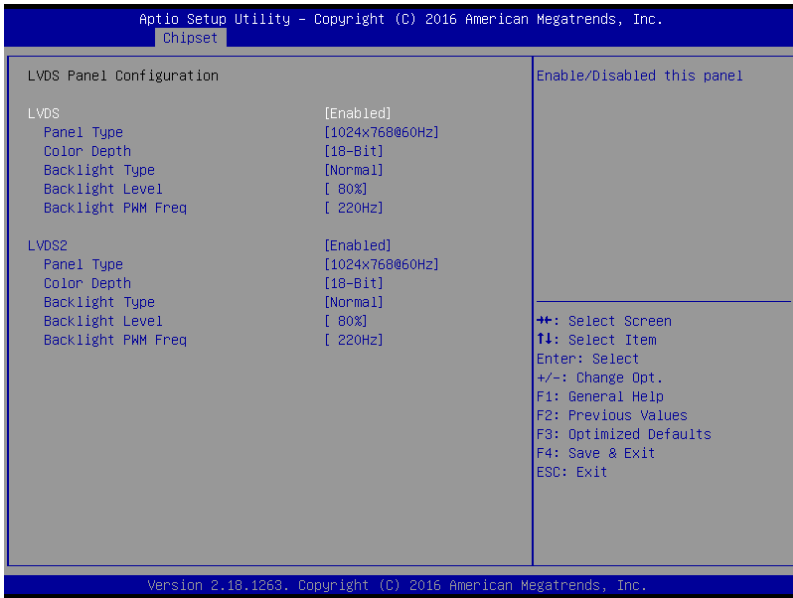

Options summary:

LVDS	Disabled	
	Enabled	Optimal Default, Failsafe Default
Enable/Disabled this panel.		
LVDS Panel Type	640x480@60Hz	Optimal Default, Failsafe Default
	800x480@60Hz	
	800x600@60Hz	
	1024x600@60Hz	
	1024x768@60Hz	
	1280x768@60Hz	
	1280x800@60Hz	
	1280x1024@60Hz	

	1366x768@60Hz	
	1440x900@60Hz	
	1600x1200@60Hz	
	1920x1080@60Hz	
	1920x1200@60Hz	
Select LCD panel used by Internal Graphics Device by selecting the appropriate setup item.		
Color Depth	18-bit	Optimal Default, Failsafe Default
	24-bit	
	36-bit	
	48-bit	
Select panel type		
Backlight Type	Normal	Optimal Default, Failsafe Default
	Inverted	
Select backlight control signal type		
Backlight Level	0%	Optimal Default, Failsafe Default
	10%	
	20%	
	30%	
	40%	
	50%	
	60%	
	70%	
	80%	
	90%	
	100%	
Select backlight control level		

Backlight PWM Freq	100Hz	Optimal Default, Failsafe Default
	200Hz	
	220Hz	
	500Hz	
	1KHz	
	2.2KHz	
	6.5KHz	
Select PWM frequency of backlight control signal		



## 3.6 Setup submenu: Security



### Change User/Administrator Password

If an Administrator Password is set, it will be required during boot up, or when the user enters the Setup utility. Please Note that a User Password does not provide access to many of the features in the Setup utility.

Select the password you wish to set, press Enter to open a dialog box to enter your password (you can enter no more than six letters or numbers). Press Enter to confirm your entry, after which you will be prompted to retype your password for a final confirmation. Press Enter again after you have retyped it correctly.

### Removing the Password

Highlight this item and type in the current password. At the next dialog box press Enter to disable password protection.

### 3.7 Setup submenu: Boot



Options summary:

Quiet Boot	Disabled	Optimal Default, Failsafe Default
	Enabled	
Enable/Disable showing boot logo.		
Monitor Mwait	Disable	Optimal Default, Failsafe Default
	Enabled	
	Auto	
Enable/Disable Monitor Mwait. To install Linux OS, please set this item to disable.		
Ipv4 PXE Support	Disabled	Optimal Default, Failsafe Default
	Enabled	
Enable Ipv4 PXE Boot Support. If disabled IPV4 PXE boot option will not be created.		

### 3.8 Setup submenu: Save & Exit

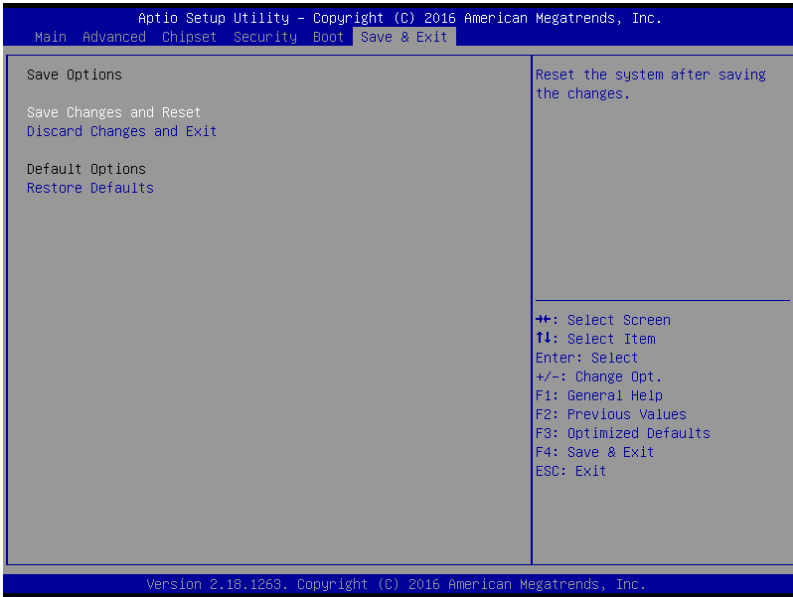

# Chapter 4

---

Drivers Installation

## 4.1 Driver Download/Installation

---

Drivers for the GENE-APL7 can be downloaded from the product page on the AAEON website by following this link:

<https://www.aaeon.com/en/p/embedded-single-board-computers-gene-apl7>

Download the driver(s) you need and follow the steps below to install them.

### Step 1 – Install Chipset Drivers

1. Open the **Step1 - Chipset** folder followed by **SetupChipset.exe**
2. Follow the instructions
3. Drivers will be installed automatically

### Step 2 – Install Graphics Drivers

1. Open the **Step2 - VGA** folder followed by **Setup.exe**
2. Follow the instructions
3. Drivers will be installed automatically

### Step 3 – Install LAN Drivers

1. Click on the **Step3 - LAN** folder and select your OS
2. Open the **.exe** file in the folder
3. Follow the instructions
4. Drivers will be installed automatically

### Step 4 – Install Audio Drivers

1. Open the **Step4 - Audio** folder followed by **0006-64bit\_Win7\_Win8\_Win81\_Win10\_R279.exe**
2. Follow the instructions
3. Drivers will be installed automatically

### Step 5 – Install TXE Driver

1. Open the **Step5 - TXE** folder followed by **SetupTXE.exe**
2. Follow the instructions
3. Drivers will be installed automatically

### Step 6 – Install SerialPort\_Patch Driver

1. Open the **Step6 - SerialPort\_Patch** folder followed by **Setup.exe**
2. Follow the instructions
3. Drivers will be installed automatically

### Step 7 – Install GPIO Driver

1. Open the **Step6 - GPIO** folder followed by **SetupSerialIO.exe**
2. Follow the instructions
3. Drivers will be installed automatically

# Appendix A

---

## Watchdog Timer Programming

## A.1 Watchdog Timer Registers

Table 1 : Watch dog relative IO address		
	Default Value	Note
I/O Base Address	0xA10	I/O Base address for Watchdog operation. This address is assigned by SIO LDN7, register 0x60-0x61.

Table 2 : Watchdog relative register table				
Register	Offset	BitNum	Value	Note
Watchdog WDRST# Enable	0x00	7	1	Enable/Disable time out output via WDRST# 0: Disable 1: Enable
Pulse Width	0x05	0:1	01	Width of Pulse signal 00: 1ms (do not use) 01: 25ms 10: 125ms 11: 5s <b>Pulse width is must longer then 16ms.</b>
Signal Polarity	0x05	2	0	0: low active 1: high active <b>Must set this bit to 0</b>
Counting Unit	0x05	3	0	Select time unit. 0: second 1: minute
Output Signal Type	0x05	4	1	0: Level 1: Pulse <b>Must set this bit to 1</b>
Watchdog Timer Enable	0x05	5	1	0: Disable 1: Enable
Timeout Status	0x05	6	1	1: timeout occurred. Write a 1 to clear timeout status
Timer Counter	0x06			Time of watchdog timer (0~255)



## A.2 Watchdog Sample Program

```
*****
// WDT I/O operation relative definition (Please reference to Table 1)
#define WDTAddr    0x510 // WDT I/O base address
Void  WDTWriteByte(byte Register, byte Value);
byte  WDTReadByte(byte Register);
Void  WDTSetReg(byte Register, byte Bit, byte Val);
// Watch Dog relative definition (Please reference to Table 2)
#define DevReg     0x00 // Device configuration register
    #define WDTRstBit 0x80 // Watchdog WDTRST# (Bit7)
    #define WDTRstVal 0x80 // Enabled WDTRST#
#define TimerReg   0x05 // Timer register
    #define PSWidthBit 0x00 // WDTRST# Pulse width (Bit0:1)
    #define PSWidthVal 0x01 // 25ms for WDTRST# pulse
    #define PolarityBit 0x02 // WDTRST# Signal polarity (Bit2)
    #define PolarityVal 0x00 // Low active for WDTRST#
    #define UnitBit    0x03 // Unit for timer (Bit3)
    #define ModeBit    0x04 // WDTRST# mode (Bit4)
    #define ModeVal    0x01 // 0:level 1; pulse
    #define EnableBit  0x05 // WDT timer enable (Bit5)
    #define EnableVal  0x01 // 1: enable
    #define StatusBit  0x06 // WDT timer status (Bit6)
#define CounterReg 0x06 // Timer counter register
*****

*****
VOID  Main(){
    // Procedure : AaeonWDTConfig
    // (byte)Timer : Counter of WDT timer.(0x00~0xFF)
    // (boolean)Unit : Select time unit(0: second, 1: minute).
    AaeonWDTConfig(Counter, Unit);

    // Procedure : AaeonWDTEnable
    // This procedure will enable the WDT counting.
    AaeonWDTEnable();
}
*****

*****
// Procedure : AaeonWDTEnable
```

```

VOID AaeonWDTEnable (){
    WDTEnableDisable(1);
}

// Procedure : AaeonWDTConfig
VOID AaeonWDTConfig (byte Counter, BOOLEAN Unit){
    // Disable WDT counting
    WDTEnableDisable(0);
    // Clear Watchdog Timeout Status
    WDTClearTimeoutStatus();
    // WDT relative parameter setting
    WDTParameterSetting(Timer, Unit);
}

VOID WDTEnableDisable(byte Value){
    If (Value == 1)
        WDTSetBit(TimerReg, EnableBit, 1);
    else
        WDTSetBit(TimerReg, EnableBit, 0);
}

VOID WDTParameterSetting(byte Counter, BOOLEAN Unit){
    // Watchdog Timer counter setting
    WDTWriteByte(CounterReg, Counter);
    // WDT counting unit setting
    WDTSetBit(TimerReg, UnitBit, Unit);
    // WDT output mode set to pulse
    WDTSetBit(TimerReg, ModeBit, ModeVal);
    // WDT output mode set to active low
    WDTSetBit(TimerReg, PolarityBit, PolarityVal);
    // WDT output pulse width is 25ms
    WDTSetBit(TimerReg, PSWidthBit, PSWidthVal);
    // Watchdog WDTRST# Enable
    WDTSetBit(DevReg, WDTRstBit, WDTRstVal);
}

VOID WDTClearTimeoutStatus() {
    WDTSetBit(TimerReg, StatusBit, 1);
}

*****
*****

```

```
VOID  WDTWriteByte(byte Register, byte Value){
    IOWriteByte(WDTAddr+Register, Value);
}

byte  WDTReadByte(byte Register){
    return IOReadByte(WDTAddr+Register);
}

VOID  WDTSetBit(byte Register, byte Bit, byte Val){
    byte TmpValue;

    TmpValue = WDTReadByte(Register);
    TmpValue &= ~(1 << Bit);
    TmpValue |= Val << Bit;
    WDTWriteByte(Register, TmpValue);
}
```

























```
*****
```









































# Appendix B

---

I/O Information

## B.1 I/O Address Map































- ▼  DESKTOP-VUHO34E
  - ▼  Input/output (IO)
    -  [0000000000000000 - 000000000000006F] PCI Express Root Complex
    -  [0000000000000020 - 0000000000000021] Programmable interrupt controller
    -  [0000000000000024 - 0000000000000025] Programmable interrupt controller
    -  [0000000000000028 - 0000000000000029] Programmable interrupt controller
    -  [000000000000002C - 000000000000002D] Programmable interrupt controller
    -  [000000000000002E - 000000000000002F] Motherboard resources
    -  [0000000000000030 - 0000000000000031] Programmable interrupt controller
    -  [0000000000000034 - 0000000000000035] Programmable interrupt controller
    -  [0000000000000038 - 0000000000000039] Programmable interrupt controller
    -  [000000000000003C - 000000000000003D] Programmable interrupt controller
    -  [0000000000000040 - 0000000000000043] System timer
    -  [000000000000004E - 000000000000004F] Motherboard resources
    -  [0000000000000050 - 0000000000000053] System timer
    -  [0000000000000060 - 0000000000000060] Standard PS/2 Keyboard
    -  [0000000000000061 - 0000000000000061] Motherboard resources
    -  [0000000000000063 - 0000000000000063] Motherboard resources
    -  [0000000000000064 - 0000000000000064] Standard PS/2 Keyboard
    -  [0000000000000065 - 0000000000000065] Motherboard resources
    -  [0000000000000067 - 0000000000000067] Motherboard resources
    -  [0000000000000070 - 0000000000000070] Motherboard resources
    -  [0000000000000070 - 0000000000000077] System CMOS/real time clock
    -  [0000000000000078 - 0000000000000CF7] PCI Express Root Complex
    -  [0000000000000080 - 000000000000008F] Motherboard resources

	[000000000000080 - 00000000000008F] Motherboard resources
	[000000000000092 - 000000000000092] Motherboard resources
	[0000000000000A0 - 0000000000000A1] Programmable interrupt controller
	[0000000000000A4 - 0000000000000A5] Programmable interrupt controller
	[0000000000000A8 - 0000000000000A9] Programmable interrupt controller
	[0000000000000AC - 0000000000000AD] Programmable interrupt controller
	[0000000000000B0 - 0000000000000B1] Programmable interrupt controller
	[0000000000000B2 - 0000000000000B3] Motherboard resources
	[0000000000000B4 - 0000000000000B5] Programmable interrupt controller
	[0000000000000B8 - 0000000000000B9] Programmable interrupt controller
	[0000000000000BC - 0000000000000BD] Programmable interrupt controller
	[000000000000280 - 000000000000287] Communications Port (COM11)
	[000000000000288 - 00000000000028F] Communications Port (COM12)
	[0000000000002A0 - 0000000000002A7] Communications Port (COM7)
	[0000000000002A8 - 0000000000002AF] Communications Port (COM8)
	[0000000000002B0 - 0000000000002B7] Communications Port (COM9)
	[0000000000002B8 - 0000000000002BF] Communications Port (COM10)
	[0000000000002C0 - 0000000000002C7] Communications Port (COM6)
	[0000000000002D0 - 0000000000002D7] Communications Port (COM5)
	[0000000000002E8 - 0000000000002EF] Communications Port (COM4)
	[0000000000002F8 - 0000000000002FF] Communications Port (COM2)
	[0000000000003E8 - 0000000000003EF] Communications Port (COM3)
	[0000000000003F8 - 0000000000003FF] Communications Port (COM1)
	[000000000000400 - 00000000000047F] Motherboard resources
	[0000000000004D0 - 0000000000004D1] Programmable interrupt controller
	[0000000000004D0 - 0000000000004D1] Programmable interrupt controller
	[000000000000500 - 0000000000005FF] Motherboard resources
	[000000000000680 - 00000000000069F] Motherboard resources
	[000000000000A00 - 000000000000A0F] Motherboard resources
	[000000000000A10 - 000000000000A1F] Motherboard resources
	[000000000000A20 - 000000000000A2F] Motherboard resources
	[000000000000D00 - 000000000000FFFF] PCI Express Root Complex
	[000000000000D00 - 000000000000DFFF] Intel(R) Celeron(R)/Pentium(R) Processor PCI Express Root Port - 5AD9
	[000000000000DF00 - 000000000000DFFF] Realtek PCIe GBE Family Controller #2
	[000000000000E000 - 000000000000EFFF] Intel(R) Celeron(R)/Pentium(R) Processor PCI Express Root Port - 5AD8
	[000000000000EF00 - 000000000000EFFF] Realtek PCIe GBE Family Controller
	[000000000000F000 - 000000000000F03F] Intel(R) HD Graphics
	[000000000000F040 - 000000000000F05F] Intel(R) Celeron(R)/Pentium(R) Processor SMBUS - 5AD4
	[000000000000F060 - 000000000000F07F] Standard SATA AHCI Controller
	[000000000000F080 - 000000000000F083] Standard SATA AHCI Controller
	[000000000000F090 - 000000000000F097] Standard SATA AHCI Controller































## B.2 Memory Address Map































Address Range	Device Name
[000000007B800001 - 000000007BFFFFFF]	PCI Express Root Complex
[000000007C000001 - 000000007FFFFFFF]	PCI Express Root Complex
[0000000080000000 - 000000008FFFFFFF]	Intel(R) HD Graphics
[0000000080000000 - 00000000CFFFFFFF]	PCI Express Root Complex
[0000000090000000 - 0000000090FFFFFF]	Intel(R) HD Graphics
[0000000091000000 - 00000000910FFFFF]	High Definition Audio Controller
[0000000091100000 - 00000000911FFFFF]	Intel(R) Celeron(R)/Pentium(R) Processor PCI Express Root Port - 5AD9
[0000000091200000 - 00000000912FFFFFFF]	Intel(R) Celeron(R)/Pentium(R) Processor PCI Express Root Port - 5AD8
[0000000091300000 - 000000009130FFFFFF]	Intel(R) USB 3.0 eXtensible Host Controller - 1.0 (Microsoft)
[0000000091310000 - 0000000091313FFF]	High Definition Audio Controller
[0000000091314000 - 0000000091315FFF]	Standard SATA AHCI Controller
[0000000091318000 - 00000000913180FF]	Intel(R) Celeron(R)/Pentium(R) Processor SMBUS - 5AD4
[0000000091319000 - 00000000913197FF]	Standard SATA AHCI Controller
[000000009131A000 - 000000009131A0FF]	Standard SATA AHCI Controller
[000000009131E000 - 000000009131EFFF]	Intel(R) Trusted Execution Engine Interface
[00000000CFE00000 - 00000000CFEFFFFF]	Intel(R) Celeron(R)/Pentium(R) Processor PCI Express Root Port - 5AD9
[00000000CFEFB000 - 00000000CFEFBFFF]	Realtek PCIe GBE Family Controller #2
[00000000CFEFC000 - 00000000CFEFFFFF]	Realtek PCIe GBE Family Controller #2
[00000000CFF00000 - 00000000CFFFFFFFFF]	Intel(R) Celeron(R)/Pentium(R) Processor PCI Express Root Port - 5AD8
[00000000CFFFB000 - 00000000CFFFBFFF]	Realtek PCIe GBE Family Controller
[00000000CFFFC000 - 00000000CFFFCFFF]	Realtek PCIe GBE Family Controller
[00000000D0C00000 - 00000000D0C00653]	Intel(R) Serial IO GPIO Host Controller - INT3452
[00000000D0C40000 - 00000000D0C40763]	Intel(R) Serial IO GPIO Host Controller - INT3452
[00000000D0C50000 - 00000000D0C5076B]	Intel(R) Serial IO GPIO Host Controller - INT3452
[00000000D0C70000 - 00000000D0C70673]	Intel(R) Serial IO GPIO Host Controller - INT3452
[00000000E0000000 - 00000000EFFFFFFF]	Motherboard resources
[00000000E0000000 - 00000000EFFFFFFF]	PCI Express Root Complex
[00000000FEA00000 - 00000000FEAFFFFF]	Motherboard resources
[00000000FED00000 - 00000000FED003FF]	High precision event timer
[00000000FED01000 - 00000000FED01FFF]	Motherboard resources
[00000000FED03000 - 00000000FED03FFF]	Motherboard resources
[00000000FED06000 - 00000000FED06FFF]	Motherboard resources
[00000000FED08000 - 00000000FED09FFF]	Motherboard resources
[00000000FED1C000 - 00000000FED1CFFF]	Motherboard resources
[00000000FED80000 - 00000000FED8BFFF]	Motherboard resources
[00000000FEE00000 - 00000000FEEFFFFFFF]	Motherboard resources































## B.3 IRQ Mapping Chart

▼		Interrupt request (IRQ)
		(ISA) 0x00000000 (00) System timer
		(ISA) 0x00000001 (01) Standard PS/2 Keyboard
		(ISA) 0x00000008 (08) High precision event timer
		(ISA) 0x0000000A (10) Communications Port (COM10)
		(ISA) 0x0000000A (10) Communications Port (COM11)
		(ISA) 0x0000000A (10) Communications Port (COM12)
		(ISA) 0x0000000A (10) Communications Port (COM7)
		(ISA) 0x0000000A (10) Communications Port (COM8)
		(ISA) 0x0000000A (10) Communications Port (COM9)
		(ISA) 0x0000000B (11) Communications Port (COM1)
		(ISA) 0x0000000B (11) Communications Port (COM2)
		(ISA) 0x0000000B (11) Communications Port (COM3)
		(ISA) 0x0000000B (11) Communications Port (COM4)
		(ISA) 0x0000000B (11) Communications Port (COM5)
		(ISA) 0x0000000B (11) Communications Port (COM6)
		(ISA) 0x0000000C (12) PS/2 Compatible Mouse
		(ISA) 0x0000000E (14) Intel(R) Serial IO GPIO Host Controller - INT3452
		(ISA) 0x0000000E (14) Intel(R) Serial IO GPIO Host Controller - INT3452
		(ISA) 0x0000000E (14) Intel(R) Serial IO GPIO Host Controller - INT3452
		(ISA) 0x0000000E (14) Intel(R) Serial IO GPIO Host Controller - INT3452
		(ISA) 0x00000036 (54) Microsoft ACPI-Compliant System
		(ISA) 0x00000037 (55) Microsoft ACPI-Compliant System
		(ISA) 0x00000038 (56) Microsoft ACPI-Compliant System
		(ISA) 0x00000039 (57) Microsoft ACPI-Compliant System
		(ISA) 0x0000003A (58) Microsoft ACPI-Compliant System
		(ISA) 0x0000003B (59) Microsoft ACPI-Compliant System
		(ISA) 0x0000003C (60) Microsoft ACPI-Compliant System
		(ISA) 0x0000003D (61) Microsoft ACPI-Compliant System
		(ISA) 0x0000003E (62) Microsoft ACPI-Compliant System































 (ISA) 0x0000003E (62)	Microsoft ACPI-Compliant System
 (ISA) 0x0000003F (63)	Microsoft ACPI-Compliant System
 (ISA) 0x00000040 (64)	Microsoft ACPI-Compliant System
 (ISA) 0x00000041 (65)	Microsoft ACPI-Compliant System
 (ISA) 0x00000042 (66)	Microsoft ACPI-Compliant System
 (ISA) 0x00000043 (67)	Microsoft ACPI-Compliant System
 (ISA) 0x00000044 (68)	Microsoft ACPI-Compliant System
 (ISA) 0x00000045 (69)	Microsoft ACPI-Compliant System
 (ISA) 0x00000046 (70)	Microsoft ACPI-Compliant System
 (ISA) 0x00000047 (71)	Microsoft ACPI-Compliant System
 (ISA) 0x00000048 (72)	Microsoft ACPI-Compliant System
 (ISA) 0x00000049 (73)	Microsoft ACPI-Compliant System
 (ISA) 0x0000004A (74)	Microsoft ACPI-Compliant System
 (ISA) 0x0000004B (75)	Microsoft ACPI-Compliant System
 (ISA) 0x0000004C (76)	Microsoft ACPI-Compliant System
 (ISA) 0x0000004D (77)	Microsoft ACPI-Compliant System
 (ISA) 0x0000004E (78)	Microsoft ACPI-Compliant System
 (ISA) 0x0000004F (79)	Microsoft ACPI-Compliant System
 (ISA) 0x00000050 (80)	Microsoft ACPI-Compliant System
 (ISA) 0x00000051 (81)	Microsoft ACPI-Compliant System
 (ISA) 0x00000052 (82)	Microsoft ACPI-Compliant System
 (ISA) 0x00000053 (83)	Microsoft ACPI-Compliant System
 (ISA) 0x00000054 (84)	Microsoft ACPI-Compliant System
 (ISA) 0x00000055 (85)	Microsoft ACPI-Compliant System
 (ISA) 0x00000056 (86)	Microsoft ACPI-Compliant System
 (ISA) 0x00000057 (87)	Microsoft ACPI-Compliant System
 (ISA) 0x00000058 (88)	Microsoft ACPI-Compliant System
 (ISA) 0x00000059 (89)	Microsoft ACPI-Compliant System
 (ISA) 0x0000005A (90)	Microsoft ACPI-Compliant System
 (ISA) 0x0000005B (91)	Microsoft ACPI-Compliant System
 (ISA) 0x0000005C (92)	Microsoft ACPI-Compliant System

 (ISA) 0x0000005D (93)	Microsoft ACPI-Compliant System
 (ISA) 0x0000005E (94)	Microsoft ACPI-Compliant System
 (ISA) 0x0000005F (95)	Microsoft ACPI-Compliant System
 (ISA) 0x00000060 (96)	Microsoft ACPI-Compliant System
 (ISA) 0x00000061 (97)	Microsoft ACPI-Compliant System
 (ISA) 0x00000062 (98)	Microsoft ACPI-Compliant System
 (ISA) 0x00000063 (99)	Microsoft ACPI-Compliant System
 (ISA) 0x00000064 (100)	Microsoft ACPI-Compliant System
 (ISA) 0x00000065 (101)	Microsoft ACPI-Compliant System
 (ISA) 0x00000066 (102)	Microsoft ACPI-Compliant System
 (ISA) 0x00000067 (103)	Microsoft ACPI-Compliant System
 (ISA) 0x00000068 (104)	Microsoft ACPI-Compliant System
 (ISA) 0x00000069 (105)	Microsoft ACPI-Compliant System
 (ISA) 0x0000006A (106)	Microsoft ACPI-Compliant System
 (ISA) 0x0000006B (107)	Microsoft ACPI-Compliant System
 (ISA) 0x0000006C (108)	Microsoft ACPI-Compliant System
 (ISA) 0x0000006D (109)	Microsoft ACPI-Compliant System
 (ISA) 0x0000006E (110)	Microsoft ACPI-Compliant System
 (ISA) 0x0000006F (111)	Microsoft ACPI-Compliant System
 (ISA) 0x00000070 (112)	Microsoft ACPI-Compliant System
 (ISA) 0x00000071 (113)	Microsoft ACPI-Compliant System
 (ISA) 0x00000072 (114)	Microsoft ACPI-Compliant System
 (ISA) 0x00000073 (115)	Microsoft ACPI-Compliant System
 (ISA) 0x00000074 (116)	Microsoft ACPI-Compliant System
 (ISA) 0x00000075 (117)	Microsoft ACPI-Compliant System
 (ISA) 0x00000076 (118)	Microsoft ACPI-Compliant System
 (ISA) 0x00000077 (119)	Microsoft ACPI-Compliant System
 (ISA) 0x00000078 (120)	Microsoft ACPI-Compliant System
 (ISA) 0x00000079 (121)	Microsoft ACPI-Compliant System
 (ISA) 0x0000007A (122)	Microsoft ACPI-Compliant System

 (ISA) 0x0000007A (122)	Microsoft ACPI-Compliant System
 (ISA) 0x0000007B (123)	Microsoft ACPI-Compliant System
 (ISA) 0x0000007C (124)	Microsoft ACPI-Compliant System
 (ISA) 0x0000007D (125)	Microsoft ACPI-Compliant System
 (ISA) 0x0000007E (126)	Microsoft ACPI-Compliant System
 (ISA) 0x0000007F (127)	Microsoft ACPI-Compliant System
 (ISA) 0x00000080 (128)	Microsoft ACPI-Compliant System
 (ISA) 0x00000081 (129)	Microsoft ACPI-Compliant System
 (ISA) 0x00000082 (130)	Microsoft ACPI-Compliant System
 (ISA) 0x00000083 (131)	Microsoft ACPI-Compliant System
 (ISA) 0x00000084 (132)	Microsoft ACPI-Compliant System
 (ISA) 0x00000085 (133)	Microsoft ACPI-Compliant System
 (ISA) 0x00000086 (134)	Microsoft ACPI-Compliant System
 (ISA) 0x00000087 (135)	Microsoft ACPI-Compliant System
 (ISA) 0x00000088 (136)	Microsoft ACPI-Compliant System
 (ISA) 0x00000089 (137)	Microsoft ACPI-Compliant System
 (ISA) 0x0000008A (138)	Microsoft ACPI-Compliant System
 (ISA) 0x0000008B (139)	Microsoft ACPI-Compliant System
 (ISA) 0x0000008C (140)	Microsoft ACPI-Compliant System
 (ISA) 0x0000008D (141)	Microsoft ACPI-Compliant System
 (ISA) 0x0000008E (142)	Microsoft ACPI-Compliant System
 (ISA) 0x0000008F (143)	Microsoft ACPI-Compliant System
 (ISA) 0x00000090 (144)	Microsoft ACPI-Compliant System
 (ISA) 0x00000091 (145)	Microsoft ACPI-Compliant System
 (ISA) 0x00000092 (146)	Microsoft ACPI-Compliant System
 (ISA) 0x00000093 (147)	Microsoft ACPI-Compliant System
 (ISA) 0x00000094 (148)	Microsoft ACPI-Compliant System
 (ISA) 0x00000095 (149)	Microsoft ACPI-Compliant System
 (ISA) 0x00000096 (150)	Microsoft ACPI-Compliant System
 (ISA) 0x00000097 (151)	Microsoft ACPI-Compliant System
 (ISA) 0x00000098 (152)	Microsoft ACPI-Compliant System

---

	(ISA) 0x000001F0 (496)	Microsoft ACPI-Compliant System
	(ISA) 0x000001F1 (497)	Microsoft ACPI-Compliant System
	(ISA) 0x000001F2 (498)	Microsoft ACPI-Compliant System
	(ISA) 0x000001F3 (499)	Microsoft ACPI-Compliant System
	(ISA) 0x000001F4 (500)	Microsoft ACPI-Compliant System
	(ISA) 0x000001F5 (501)	Microsoft ACPI-Compliant System
	(ISA) 0x000001F6 (502)	Microsoft ACPI-Compliant System
	(ISA) 0x000001F7 (503)	Microsoft ACPI-Compliant System
	(ISA) 0x000001F8 (504)	Microsoft ACPI-Compliant System
	(ISA) 0x000001F9 (505)	Microsoft ACPI-Compliant System
	(ISA) 0x000001FA (506)	Microsoft ACPI-Compliant System
	(ISA) 0x000001FB (507)	Microsoft ACPI-Compliant System
	(ISA) 0x000001FC (508)	Microsoft ACPI-Compliant System
	(ISA) 0x000001FD (509)	Microsoft ACPI-Compliant System
	(ISA) 0x000001FE (510)	Microsoft ACPI-Compliant System
	(ISA) 0x000001FF (511)	Microsoft ACPI-Compliant System
	(PCI) 0x00000019 (25)	High Definition Audio Controller
	(PCI) 0xFFFFFFF3 (-13)	Realtek PCIe GBE Family Controller
	(PCI) 0xFFFFFFF4 (-12)	Realtek PCIe GBE Family Controller #2
	(PCI) 0xFFFFFFF5 (-11)	Intel(R) USB 3.0 eXtensible Host Controller - 1.0 (Microsoft)
	(PCI) 0xFFFFFFF6 (-10)	Intel(R) Trusted Execution Engine Interface
	(PCI) 0xFFFFFFF7 (-9)	Intel(R) HD Graphics
	(PCI) 0xFFFFFFF8 (-8)	Standard SATA AHCI Controller
	(PCI) 0xFFFFFFF9 (-7)	Intel(R) Celeron(R)/Pentium(R) Processor PCI Express Root Port - 5AD7
	(PCI) 0xFFFFFFFA (-6)	Intel(R) Celeron(R)/Pentium(R) Processor PCI Express Root Port - 5AD6
	(PCI) 0xFFFFFFFB (-5)	Intel(R) Celeron(R)/Pentium(R) Processor PCI Express Root Port - 5ADB
	(PCI) 0xFFFFFFFC (-4)	Intel(R) Celeron(R)/Pentium(R) Processor PCI Express Root Port - 5ADA
	(PCI) 0xFFFFFFFD (-3)	Intel(R) Celeron(R)/Pentium(R) Processor PCI Express Root Port - 5AD9
	(PCI) 0xFFFFFFF0 (-2)	Intel(R) Celeron(R)/Pentium(R) Processor PCI Express Root Port - 5AD8

# Appendix C

---

Mating Connectors

## C.1 List of Mating Connectors and Cables

The table notes mating connectors and available cables.

Connector Label	Function	Mating Connector		Available Cable	Cable P/N
		Vendor	Model no		
CN8, CN2	LVDS Port Inverter	JST	PHR-5	N/A	N/A
CN4, CN5	LVDS	HIROSE	DF13-30DS-1.25C	N/A	N/A
CN7	Audio	Molex	51021-1000	Audio Cable	1709100254
CN9, CN11	Speaker	Molex	51021-0200	N/A	N/A
CN12, CN13, CN14, CN15, CN16, CN19, CN20, CN21, CN25, CN26	COM	Molex	51021-0900	UART Wafer Cable	1701090150
JP6	Front Panel	Molex	51110-1050	N/A	N/A
CN24	DIO	Molex	51110-1050	N/A	N/A
CN28	RTC Battery	Molex	51021-0200	Battery Cable	175011901C
CN29~CN36	USB	Molex	51021-0500	USB Wafer Cable	1700050207
CN27	SATA PWR	JST	PHR-2	2 Pins For SATA Power	1702150155
CN43	eDP (optional)	KEL	SSL20-30S	N/A	170430030W
CN17	LPC Port	JST	SHR-12V-S-B	AAEON LPC Cable	1703120130
CN1	External +12V Input	Molex	19211-0003	Power Cable	170204010R

# Appendix D

---

Digital I/O Ports

## D.1 Digital I/O Register

### 7.1.2 Logic Device Number Register (LDN) — Index 07h

Bit	Name	R/W	Reset	Default	Description
7-0	LDN	R/W	LRESET#	00h	00h: Select FDC device configuration registers. 03h: Select Parallel Port device configuration registers. 04h: Select Hardware Monitor device configuration registers. 05h: Select KBC device configuration registers. 06h: Select GPIO device configuration registers. 07h: Select WDT device configuration registers. 0Ah: Select PME, ACPI and ERP device configuration registers. 10h: Select UART1 device configuration registers. 11h: Select UART2 device configuration registers. 12h: Select UART3 device configuration registers. 13h: Select UART4 device configuration registers. 14h: Select UART5 device configuration registers. 15h: Select UART6 device configuration registers. Otherwise: Reserved.

### GPIO8 Output Enable Register — Index 88h

Bit	Name	R/W	Reset	Default	Description
7	GPIO87_OE	R/W	LRESET#	0	0: GPIO87 is in input mode. 1: GPIO87 is in output mode.
6	GPIO86_OE	R/W	LRESET#	0	0: GPIO86 is in input mode. 1: GPIO85 is in output mode.
5	GPIO85_OE	R/W	LRESET#	0	0: GPIO85 is in input mode. 1: GPIO85 is in output mode.
4	GPIO84_OE	R/W	LRESET#	0	0: GPIO84 is in input mode. 1: GPIO84 is in output mode.
3	GPIO83_OE	R/W	LRESET#	0	0: GPIO83 is in input mode. 1: GPIO83 is in output mode.
2	GPIO82_OE	R/W	LRESET#	0	0: GPIO82 is in input mode. 1: GPIO82 is in output mode.
1	GPIO81_OE	R/W	LRESET#	0	0: GPIO81 is in input mode. 1: GPIO81 is in output mode.
0	GPIO80_OE	R/W	LRESET#	0	0: GPIO80 is in input mode. 1: GPIO80 is in output mode.



**GPIO8 Output Data Register — Index 89h (This byte could be also written by base address + 2)**

Bit	Name	R/W	Reset	Default	Description
7	GPIO87_VAL	R/W	LRESET#	1	0: GPIO87 outputs 0 when in output mode. 1: GPIO87 outputs 1 when in output mode.
6	GPIO86_VAL	R/W	LRESET#	1	0: GPIO86 outputs 0 when in output mode. 1: GPIO86 outputs 1 when in output mode.
5	GPIO85_VAL	R/W	LRESET#	1	0: GPIO85 outputs 0 when in output mode. 1: GPIO85 outputs 1 when in output mode.
4	GPIO84_VAL	R/W	LRESET#	1	0: GPIO84 outputs 0 when in output mode. 1: GPIO84 outputs 1 when in output mode.
3	GPIO83_VAL	R/W	LRESET#	1	0: GPIO83 outputs 0 when in output mode. 1: GPIO83 outputs 1 when in output mode.
2	GPIO82_VAL	R/W	LRESET#	1	0: GPIO82 outputs 0 when in output mode. 1: GPIO82 outputs 1 when in output mode.
1	GPIO81_VAL	R/W	LRESET#	1	0: GPIO81 outputs 0 when in output mode. 1: GPIO81 outputs 1 when in output mode.
0	GPIO80_VAL	R/W	LRESET#	1	0: GPIO80 outputs 0 when in output mode. 1: GPIO80 outputs 1 when in output mode.

**GPIO8 Pin Status Register — Index 8Ah (This byte could be also read by base address + 2)**

Bit	Name	R/W	Reset	Default	Description
7	GPIO87_IN	R	-	-	The pin status of GPIO87/PD7.
6	GPIO86_IN	R	-	-	The pin status of GPIO86/PD6.
5	GPIO85_IN	R	-	-	The pin status of GPIO85/PD5.
4	GPIO84_IN	R	-	-	The pin status of GPIO84/PD4.
3	GPIO83_IN	R	-	-	The pin status of GPIO83/PD3.
2	GPIO82_IN	R	-	-	The pin status of GPIO82/PD2.
1	GPIO81_IN	R	-	-	The pin status of GPIO81/PD1.
0	GPIO80_IN	R	-	-	The pin status of GPIO80/PD0.

## D.2 Digital I/O Sample Code (4 in 4 out, 2 low 2 high)

---

```
Outputb(0x2E,0x87); //enter configuration
Outputb(0x2E,0x87);

Outputb(0x2E,0x07); //set LDN
Outputb(0x2F,0x06);

Outputb(0x2E,0xA0); //GPIO set 5 register
Outputb(0x2F,0xF0);

Outputb(0x2E,0xA1); //GPIO output data register
Outputb(0x2F,0x30);

Outputb(0x2E,0xAA); //exit configuration
```