

GENE-6310 Rev. B

VIA Eden™ CPU

SubCompact Board

With LCD, LVDS, Ethernet,

4 COMs, TV-out & Audio

GENE-6310 Rev. B Manual

Aug. 2003

Copyright Notice

This document is copyrighted, 2003. All rights are reserved. The original manufacturer reserves the right to make improvements to the products described in this manual at any time without notice.

No part of this manual may be reproduced, copied, translated, or transmitted in any form or by any means without the prior written permission of the original manufacturer. Information provided in this manual is intended to be accurate and reliable. However, the original manufacturer assumes no responsibility for its use, or for any infringements upon the rights of third parties that may result from its use.

The material in this document is for product information only and is subject to change without notice. While reasonable efforts have been made in the preparation of this document to assure its accuracy, AAEON assumes no liabilities resulting from errors or omissions in this document, or from the use of the information contained herein.

AAEON reserves the right to make changes in the product design without notice to its users.

Acknowledgments

All other product s' name or trademarks are properties of their respective owners.

- Award is a trademark of Award Software International, Inc.
- CompactFlash™ is a trademark of the Compact Flash Association.
- VIA Eden™ is a trademark of VIA Technology Inc.
- Microsoft Windows® is a registered trademark of Microsoft Corp.
- PC/AT, PS/2, and VGA are trademarks of International Business Machines Corporation.

Packing List

Before you begin installing your card, please make sure that the following materials have been shipped:

- 1 GENE-6310 Rev. B All-In-One Single Board Computer
- 1 Hard disk drive (IDE) interface cable
- 1 Floppy disk drive interface cable
- 1 6-pin mini-DIN dual outlet adapter for keyboard and PS/2
- 2 USB Cable
- 1 Audio Cable
- 3 COM Port Cable
- 1 TV-Out Cable
- 1 LPT 1 Cable
- 1 Accessory for all series jumper
- 1 Quick Installation Guide
- 1 Utility CD-ROM

If any of these items should be missing or damaged, please contact your distributor or sales representative immediately.

Contents

Chapter 1 General Information

1.1 Introduction	1-2
1.2 Features	1-3
1.3 Specifications.....	1-4

Chapter 2 Quick Installation Guide

2.1 Safety Precautions.....	2-2
2.2 Location of Connectors and Jumpers	2-3
2.3 Mechanical Drawing.....	2-5
2.4 List of Jumpers.....	2-7
2.5 List of Connectors	2-7
2.6 Setting Jumpers	2-9
2.7 LCD Voltage (JP1)	2-9
2.8 RS-232, RS-422 and RS-485 Select (JP2 & JP3).....	2-10
2.9 PC/104 + Power I/O (JP4)	2-10
2.10 Clear CMOS (JP5)	2-10
2.11 LCD Shift Clock Select (JP6)	2-10
2.12 ATX Power Simulate AT Power (JP7).....	2-11
2.13 Hard Drive Connector (CN1)	2-11
2.14 TV-out Connector (CN2)	2-13
2.15 Fan Connector (CN3)	2-13
2.16 TTL LCD Connector (CN4, CN5)	2-14
2.17 Floppy Drive Connector (CN6).....	2-15

2.18 Front Panel Connector (CN7)	2-16
2.19 LVDS Channel 1 Connector (CN11)	2-16
2.20 LVDS Channel 2 Connector (CN8)	2-17
2.21 Serial Port/ COM 2 (CN9)	2-17
2.22 Parallel Port Connector (CN10)	2-18
2.23 Audio Connector (CN13)	2-18
2.24 100 Base-T Ethernet Connector (CN14)	2-19
2.25 Power Connector (CN15)	2-19
2.26 USB Connector (CN16, CN17)	2-20
2.27 Serial Port/ COM 1 (CN18)	2-20
2.28 IrDA Connector (CN19)	2-21
2.29 PS/2 Keyboard and Mouse Connector (CN20)	2-21
2.30 VGA Connector (CN21)	2-22
2.31 CompactFlash Connector (CN22)	2-23
2.32 PME# Connector for PCM-3794 (CN23)	2-24
2.33 RS-232 Serial Port Connector (CN24)	2-24
2.34 RS-232 Serial Port Connector (CN25)	2-25
2.35 Option ATX Power Connector (CN26)	2-25

Chapter 3 Award BIOS Setup

3.1 System Test and Initialization	3-2
3.2 Award BIOS Setup	3-3
3.3 Standard CMOS Features	3-6
3.4 Advanced BIOS Features	3-7
3.5 Advanced Chipset Features	3-8
3.6 Integrated Peripherals	3-9

3.7 Power management Setup	3-10
3.8 PnP/PCI Configuration	3-11
3.9 PC Health Status	3-12
3.10 Frequency/ Voltage control	3-13
3.11 Load Fail-Safe Defaults	3-14
3.12 Load Optimized Defaults	3-14
3.13 Set Supervisor/ User Password	3-14
3.14 Save & Exit Setup	3-15
3.15 Exit without saving	3-15

Chapter 4 Driver Installation

4.1 Installation 1	4-3
4.2 Installation 2	4-4

Appendix A Programming the WatchDog Timer

Programming the Watchdog timer	A-2
--------------------------------------	-----

Chapter

1

**General
Information**

1.1 Introduction

The GENE-6310 Rev.B is an all-in-one VIA Eden™ series CPU based single board computer (SBC) with an Integrated AGP 4X 2D/3D Graphics Accelerator, an audio controller, a 10/100 Base-T Ethernet Controller, Dual channel LVDS interface, and PC/104 plus expansion capability. This compact (only 5.75" x 4") unit offers all the functions of a single board computer, but still fits in the space of a FDD drive.

Onboard features include four serial ports (three RS-232, one RS-232/422/485), one multi-mode parallel (ECP/EPP/SPP) port, pin header for 4 USB (Universal Serial Bus) ports, a floppy drive controller, and a keyboard/PS/2 mouse interface. The built-in high speed PCI-EIDE controller supports Ultra DMA-33 master mode. Up to two IDE devices can be connected, including large hard disks, CD-ROM drives, and tape backup drives, etc.

The GENE-6310 Rev.B also features power management to minimize power consumption. It complies with the APM/ACPI standard and supports three types of power saving features: Doze mode, Standby mode, and Suspend mode. In addition, the board's watchdog timer can be programmed to reset the system or generate an interrupt in case the system stops due to a program bug or SMI.

Highly Integrated Multi-media SBC

The GENE-6310 Rev. B is a highly integrated multi-media SBC that combines audio, video, and network functions on a FDD drive size single board computer. It provides an AC-97 audio interface 2.0 version. Major onboard devices adopt PCI technology to achieve outstanding computing performance when used with VIA Eden™ (Pentium® III level) series CPU, making the GENE-6310 one of the world's smallest and most powerful all-in-one multimedia boards

1.2 Features

- 3.5" FDD SubCompact Form Factor
- Supports VIA Eden™ Series CPU
- Integrated AGP 4X 2D/3D Graphics Accelerator
- Supports CRT and 18/36-bit TFT/DSTN panels
- Supports NTSC/PAL TV output
- Integrated AC-97 2.0 SoundBlaster compatible audio codec
- Supports CompactFlash™ Storage
- Supports one 10/100 Base-T Fast Ethernet
- 4 COMs/ 1 Parallel/ 4 USBs/ 1 IrDA Port
- 5 volt only operation

1.3 Specifications

System

- CPU: VIA Eden™ EPGA mobile processor
- Memory: Onboard one 144-pin SODIMM socket supports up to 512MB SDRAM
- Chipset: VIA VT8606 (66/100/133FSB)/VT82C686B
- BIOS: Award 256KB FLASH BIOS
- Ethernet: Realtek RTL8100, 10/100 Base-T RJ-45 connector x 1
- SSD: Type II CompactFlash™ socket
- Expansion Interface: PC/104 plus connector x 1
- Battery: Lithium battery for data retention
- Watchdog Timer: Can generate a system reset, IRQ, or NMI. Software selectable time-out interval.
- DMA: 7 DMA channels
- Interrupt: 15 interrupt levels
- H/W Status Monitoring: Embedded in VIA VT82C686B supports power supply voltages, fan speed, and temperature monitoring.
- Power Supply Voltage: +5V (4.75V to 5.25V), AT / ATX
- Size/ Weight 5.75" (L) x 4" (W)

(146 mm x 101.6 mm)

0.88 lb (0.4 kg)

Display

- **Chipset** VIA VT8606 Integrated
- **Memory Size:** Shared memory up to 32MB
- **Display Type:** Supports CRT, LVDS (18/36-bit only), or TTL (18/36-bit only) LCD displays. Can display both CRT and flat panel simultaneously, such as CRT with TTL or CRT with LVDS LCD at the same time.
- **TV-out:** VIA 1621 supports NTSC/PAL S-Video composite outputs
- **Resolution:** Up to 1280 x 1024 @ 32-bit colors for CRT
Up to 1024 x 768 @ 18-bit colors for LCD

I/O

- **MIO:** IDE (UDMA33) x 1, FDD x 1, KB + Mouse x 1, RS-232 x 3, RS-232/422/485 x 1, Parallel x 1
- **IrDA:** One IrDA Tx/Rx header
- **Audio:** VIA VT82C686B with AC-97 2.0 compliant audio codec VT1612

- USB: Two 5x2 pin headers support 4 USB 1.1 ports

Chapter

2

**Quick
Installation
Guide**

Notice:

The Quick Installation Guide is derived from Chapter 2 of user manual. For other chapters and further installation instructions, please refer to the user manual CD-ROM that came with the product.



2.1 Safety Precautions

Warning!

Always completely disconnect the power cord from your board whenever you are working on it. Do not make connections while the power is on, because a sudden rush of power can damage sensitive electronic components.

Caution!

Always ground yourself to remove any static charge before touching the board. Modern electronic devices are very sensitive to static electric charges. Use a grounding wrist strap at all times. Place all electronic components on a static-dissipative surface or in a static-shielded bag when they are not in the chassis

2.2 Location of Connectors and Jumpers

Locating connectors and jumpers (component side)

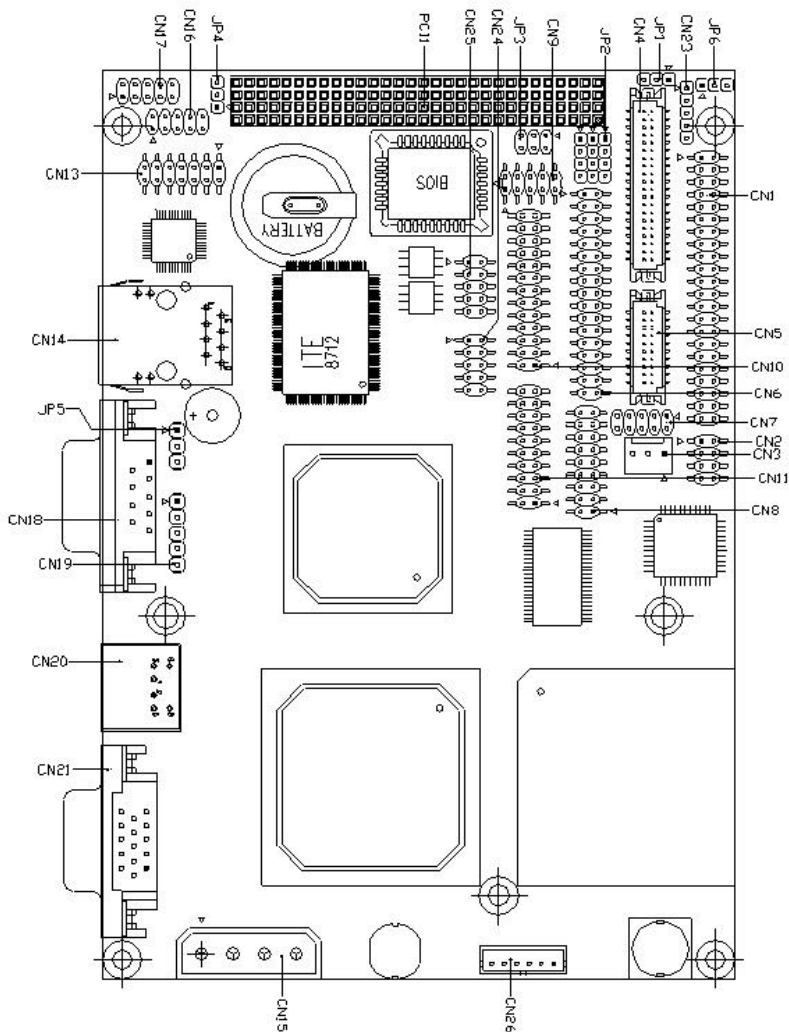

Locating connectors (solder side)

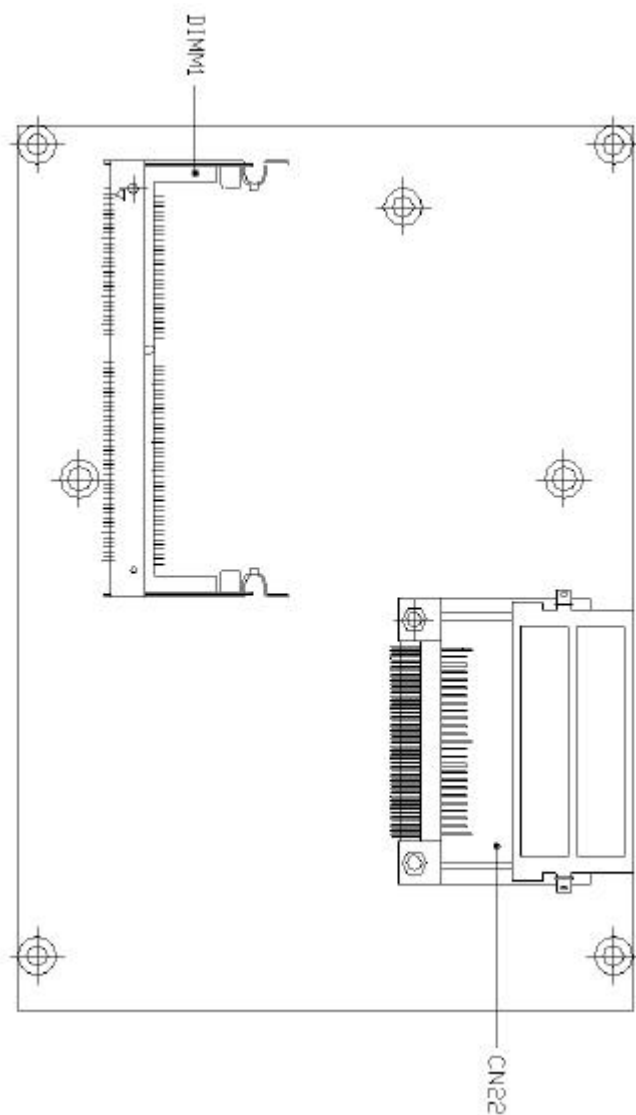

2.3 Mechanical Drawing

Mechanical drawing (component side)

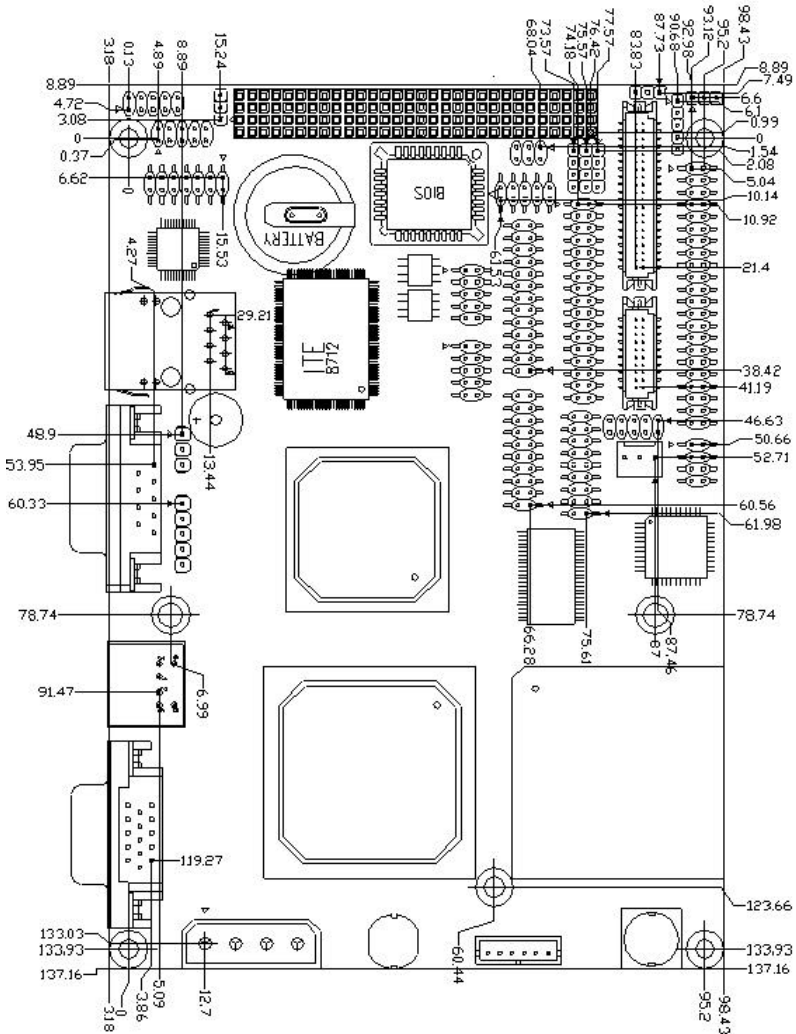

Mechanical Drawing (solder side)

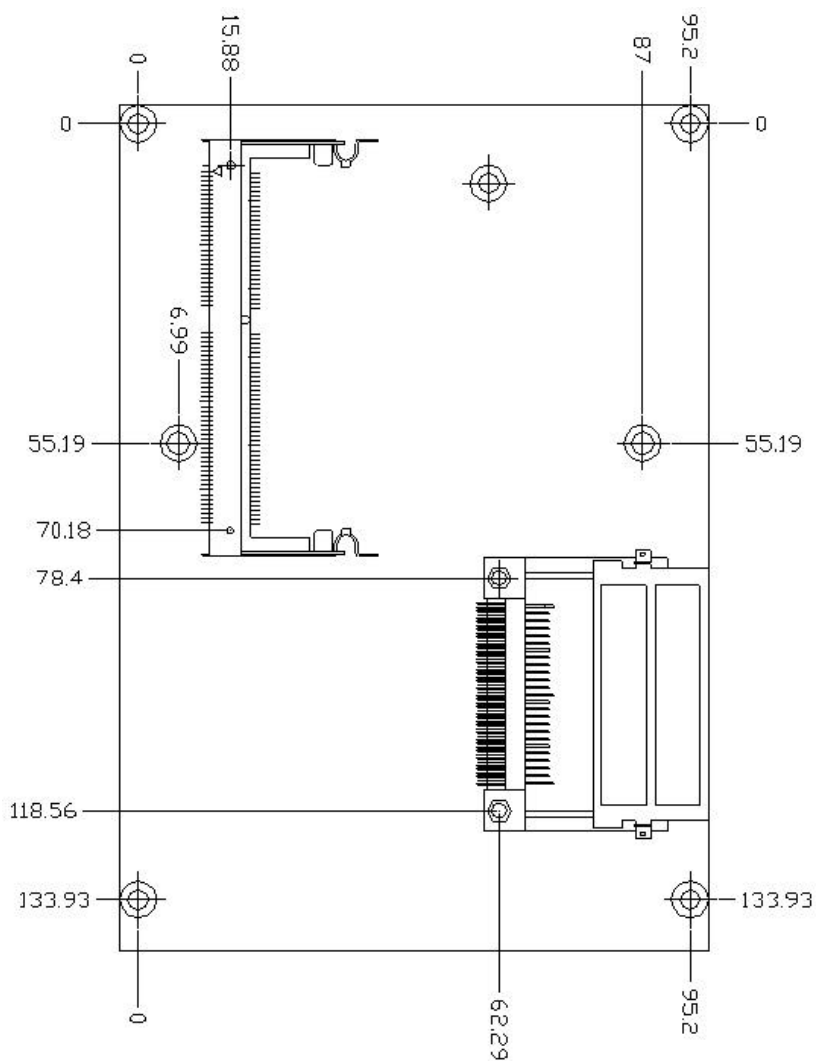

2.4 List of Jumpers

The board has a number of jumpers that allow you to configure your system to suit your application.

The table below shows the function of each of the board's jumpers:

Jumpers

Label	Function
JP1	LCD Voltage Select
JP2	RS-232/422/485 select
JP3	RS-232/422/485 select
JP4	PC/104 + Power I/O
JP5	Clear CMOS
JP6	Shift Clock Setting
JP7	ATX Power simulate AT Power

2.5 List of Connectors

The board has a number of connectors that allow you to configure your system to suit your application.

The table below shows the function of each of the board's connectors:

Connectors

Label	Function
CN1	IDE Connector
CN2	TV-out Connector
CN3	Fan Connector
CN4	TTL LCD Connector
CN5	TTL LCD Connector
CN6	FDD Connector
CN7	Front Panel Connector
CN8	LVDS Channel 2 Connector
CN9	Serial Port Connector (COM2)
CN10	Parallel Port Connector
CN11	LVDS Channel 1 Connector
CN13	Audio Connector
CN14	RJ-45 Ethernet Connector
CN15	Power Connector
CN16	USB Connector
CN17	USB Connector
CN18	Serial Port Connector (COM1)
CN19	IrDA Connector
CN20	PS/2 Keyboard and Mouse Connector
CN21	VGA Connector
CN22	CompactFlash Socket
CN23	PME# Connector for PCM-3794
CN24	Serial Port Connector (COM3)
CN25	Serial Port Connector (COM4)
CN26	Option ATX Power Connector
DIMM 1	SODIMM slot
PCI 1	PCI-104 Connector

2.6 Setting Jumpers

You configure your card to match the needs of your application by setting jumpers. A jumper is the simplest kind of electric switch. It consists of two metal pins and a small metal clip (often protected by a plastic cover) that slides over the pins to connect them. To “close” a jumper you connect the pins with the clip.

To “open” a jumper you remove the clip. Sometimes a jumper will have three pins, labeled 1, 2 and 3. In this case you would connect either pins 1 and 2 or 2 and 3.

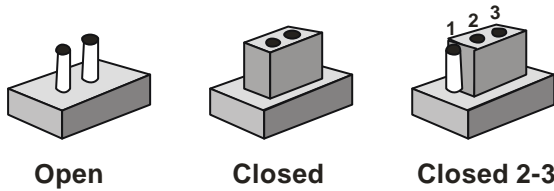

A pair of needle-nose pliers may be helpful when working with jumpers.

If you have any doubts about the best hardware configuration for your application, contact your local distributor or sales representative before you make any change.

Generally, you simply need a standard cable to make most connections.

2.7 LCD Voltage (JP1)

JP1	Function
1-2	+5V
2-3	+3.3V (Default)

2.8 RS-232, RS-422 and RS-485 Select (JP2 & JP3)

JP2	Function
1-2, 4-5, 7-8, 10-11	RS-232 (Default)
2-3, 5-6, 8-9, 11-12	RS-422
2-3, 5-6, 8-9, 11-12	RS-485

JP3	Function
1-2	RS-232 (Default)
3-4	RS-422
5-6	RS-485

2.9 PCI-104 Power I/O (JP4)

JP4	Function
1-2	5V
2-3	3.3V (Default)

2.10 Clear CMOS (JP5)

You can use JP5 pin 1-3 to clear the CMOS data if necessary. To reset the CMOS data, set JP5 to 2-3 for just a few seconds, and then move the jumper cap back to 1-2

JP5	Function
1-2	Protect (Default)
2-3	Clear CMOS

2.11 LCD Shift Clock Select (JP6)

JP6	Function
2-3	Shift Clock -
1-2	Shift Clock (Default)

2.12 ATX Power Simulate AT Power (JP7)

JP7	Function
NC	ATX or AT standard (Default)
1-2	ATX Power Simulate AT Power

2.13 Hard Drive Connector (CN1)

You can attach one or two Enhanced Integrated Device Electronics hard disk drives to the GENE-6310 internal controller. The GENE-6310 IDE controller uses a PCI local-bus interface. This advanced interface supports faster data transfer.

Connecting the hard drive

Connecting drives is done in a daisy-chain fashion and requires one of two cables, depending on the drive size.

Wire number 1 on the cable is normally red or blue, and the other wires are usually gray.

1. Connect one end of the cable to CN1, and make sure the red (or blue) wire corresponds to pin 1 on the connector, which is labeled on the board (on the right side).
2. Plug the other end of the cable to the Enhanced IDE hard drive, with pin 1 on the hard drives. (see your hard drive's documentation for the documentation for the location of the connector.)

Connect a second drive as described above.

Unlike floppy drives, IDE hard drives can connect to either end of the cable. If you install two drives, you will need to set one as the master and the other as the slave by using jumpers on the drives. If you install just one drive, set it as the master.

Pin	Signal	Pin	Signal
1	IDE RESET	2	GND
3	DATA 7	4	DATA 8
5	DATA 6	6	DATA 9
7	DATA 5	8	DATA 10
9	DATA 4	10	DATA 11
11	DATA 3	12	DATA 12
13	DATA 2	14	DATA 13
15	DATA 1	16	DATA 14
17	DATA 0	18	DATA 15
19	Signal GND	20	NC
21	DREQ	22	GND
23	IO WRITE	24	GND
25	IO READ	26	GND
27	IO CHANNEL READY	28	ALE
29	DACK#	30	GND
31	IRQ14	32	NC
33	ADDR 1	34	PDIAG
35	ADDR 0	36	ADDR 2
37	HARD DISK SELECT 0	38	HARD DISK SELECT 1
39	IDE ACTIVE	40	GND
41	VCC	42	VCC
43	NC	44	GND

2.14 TV-out Connector (CN2)

The GENE-6310 has an 8-pin connector for supporting TV output function. The pin definition is listed below.

Pin	Signal	Pin	Signal
1	LUMF	2	Composite
3	GND	4	GND
5	CHROMF	6	NC
7	GND	8	NC

2.15 Fan Connector (CN3)

Pin	Signal
1	GND
2	+5V
3	FAN Sensor

2.16 TTL LCD Connector (CN4, CN5)

TTL LCD Connector (CN4)

Pin	Signal	Pin	Signal
1	+5V	2	+5V
3	GND	4	GND
5	+3.3V	6	+3.3V
7	ENABKL	8	GND
9	NC	10	NC
11	BLUE0-0	12	BLUE0-1
13	BLUE0-2	14	BLUE0-3
15	BLUE0-4	16	BLUE0-5
17	NC	18	NC
19	GREEN0-0	20	GREEN0-1
21	GREEN0-2	22	GREEN0-3
23	GREEN0-4	24	GREEN0-5
25	NC	26	NC
27	RED0-0	28	RED0-1
29	RED0-2	30	RED0-3
31	RED0-4	32	RED0-5
33	GND	34	GND
35	SHIFT CLK	36	FLM
37	DE	38	LP
39	NC	40	ENVEE

TTL LCD Connector (CN5)

Pin	Signal	Pin	Signal
1	GND	2	GND
3	BLUE1-0	4	BLUE1-1
5	BLUE1-2	6	BLUE1-3
7	BLUE1-4	8	BLUE1-5

9	GREEN1-0	10	GREEN1-1
11	GREEN1-2	12	GREEN1-3
13	GREEN1-4	14	GREEN1-5
15	RED1-0	16	RED1-1
17	RED1-2	18	RED1-3
19	RED1-4	20	RED1-5

2.17 Floppy Drive Connector (CN6)

Pin	Signal	Pin	Signal
1	GND	2	DENSITY SELECT0
3	GND	4	N.C.
5	GND	6	DENSITY SELECT1
7	GND	8	INDEX
9	GND	10	MOTOR A
11	GND	12	DRIVE SELECT B
13	GND	14	DRIVE SELELCT A
15	GND	16	MOTOR B
17	GND	18	DIRECTION
19	GND	20	STEP
21	GND	22	WRITE DATA
23	GND	24	WRITE GATE
25	GND	26	TRACK 0
27	GND	28	WRITE PROTECT
29	GND	30	READ DATA
31	GND	32	HEAD
33	GND	34	DIKS CHANGE

2.18 Front Panel Connector (CN7)

Pin	Signal	Pin	Signal
1	HDD LED#	2	VCC
3	GND	4	PWR LED
5	ESMI#	6	GND
7	RESETIN	8	GND
9	PWBT#	10	GND

2.19 LVDS Channel 1 Connector (CN11)

Pin	Signal	Pin	Signal
1	+TXOUT1	2	-TXOTU1
3	GND	4	GND
5	+TXCLK	6	-TXCLK
7	GND	8	PPVCC
9	PPVCC	10	PPVCC
11	+TXOUT2	12	-TXOUT2
13	GND	14	GND
15	+TXOUT0	16	-TXOUT0
17	NC	18	NC
19	ENVDD	20	NC

2.20 LVDS Channel 2 Connector (CN8)

Pin	Signal	Pin	Signal
1	+TXOUT1	2	-TXOUT1
3	GND	4	GND
5	+TXCLK	6	-TXCLK
7	GND	8	PPVCC
9	PPVCC	10	PPVCC
11	+TXOUT2	12	-TXOUT2
13	GND	14	GND
15	+TXOUT0	16	-TXOUT0
17	NC	18	NC

2.21 Serial Port/ COM 2 (CN9)

The GENE-6310 offers two serial ports, one RS-232 and one RS-232/422/485. These ports allow you to connect them to serial devices (mouse, printers, etc.)

Pin	Signal	Pin	Signal
1	CM2-1 (NDCD2/ 485TX-)	2	CM2-2 (NRXD 2/ 485RX+)
3	CM2-3 (NTXD2/ 485TX+)	4	CM2-4 (NDTR 2/485 RX-)
5	GND	6	SDSRB2X
7	SRTSB2X	8	SCTSB2X
9	SRIB2X	10	N.C.

2.22 Parallel Port Connector (CN10)

Pin	Signal	Pin	Signal
1	STROBE	14	AFD
2	PTD0	15	ERROR
3	PTD1	16	INIT
4	PTD2	17	SLIN
5	PTD3	18	GND
6	PTD4	19	GND
7	PTD5	20	GND
8	PTD6	21	GND
9	PTD7	22	GND
10	ACK	23	GND
11	BUSY	24	GND
12	PE	25	GND
13	SELECT	26	N.C.

2.23 Audio Connector (CN13)

The GENE-6310 provides all major audio signals on a 14-pin flat-cable connector, CN13.

It offers the Mic-in, Line-in, and Audio-out signal pins as shown in the following table.

Pin	Signal	Pin	Signal
1	MIC In	2	MIC Vcc
3	GND	4	CD GND
5	Line in Left	6	CD Left
7	Line in Right	8	CD GND
9	GND	10	CD Right
11	Audio Out Left	12	Audio Out Right
13	GND	14	GND

2.24 100 Base-T Ethernet Connector (CN14)

This 100 Base-T Ethernet connector is a standard RJ-45 connector. The onboard TFL8139C fast Ethernet controller supports 10Mb/s and 100 Mb/s N-way auto-negotiation operation.

Pin	Signal	Pin	Signal
1	TX+	9	SPEED LED
2	TX-	10	VCC
3	TCT	11	VCC
4	N.C.	12	ACTIVE LED
5	N.C.	13	GND
6	RCT	14	GND
7	RD+	15	GND
8	RD-	16	GND

2.25 Power Connector (CN15)

In single board computer (non-passive backplane) applications, you will need to connect the power to the GENE-6310 board using CN15. This connector is fully compatible with the standard PC power supply connector. Please check the following table for its pin assignment.

Pin	Signal
1	+5V
2	GND
3	GND
4	+12V

2.26 USB Connector (CN16, CN17)

The GENE-6310 has 4 USB (Universal Serial Bus) ports that provide complete functions to plug play, hot attach, or detach for up to 127 external devices. The USB interfaces comply with USB specification Rev. 1.1 and can be disabled in the system BIOS setup.

Pin	Signal	Pin	Signal
1	+5V	2	GND
3	D0-	4	GND
5	D0+	6	D1+
7	GND	8	D1-
9	GND	10	+5V

2.27 Serial Port/ COM 1 (CN18)

The GENE-6310 offers two serial ports, one RS-232 and one RS-232/422/485. These ports allow you to connect them to serial devices (mouse, printers, etc.).

Pin	Signal	Pin	Signal
1	NDCD1	2	NRXD1
3	NTXD1	4	NDTR1
5	GND	6	NDSR1
7	NRTS1	8	NCTS1
9	NR11	10	N.C.

2.28 IrDA Connector (CN19)

The IrDA connector (CN19) can be configured to support wireless infrared module. With this module and applications such as laplink or Win 95/98 Direct Cable connection, user can transfer files to or from laptops, notebooks, PDA and printers that also equip IrDA function. This connector supports HPSIR (115.2Kbps, 2 meters), and ASK-IR (56Kbps).

Install infrared module onto IrDA connector and enable infrared function from BIOS setup; moreover, make sure to have correct orientation when you plug onto IrDA connector (CN19).

Pin	Signal
1	+5V
2	N.C.
3	IrRx
4	GND
5	IrTx

2.29 PS/2 Keyboard and Mouse Connector (CN20)

The GENE-6310 provides a keyboard connector which supports both a keyboard and a PS/2 style mouse. In most cases, especially in embedded applications, a keyboard is not used. The standard PC/AT BIOS will report an error or fail during power-on-self-test (POST) after a reset if the keyboard is not present. The mainboard BIOS Advanced Setup Menu can let you select "Present" or "Absent" under the "System Keyboard" section, allowing no-keyboard operation in the applications of embedded system and won't cause the system halting under POST.

Pin	Signal
1	KB DATA
2	MS DATA
3	GND
4	Vcc
5	KB CLOCK
6	MS CLOCK
7	N.C.
8	N.C.

2.30 VGA Connector (CN21)

The GENE-6310 can drive conventional CRT displays and is capable of driving a wide range of flat panel displays, including electroluminescent (EL), gas plasma, passive LCD, and active LCD displays. In other words, the board has two connectors to support these displays, one for standard CRT VGA monitor and the other for any one of the flat panel displays.

Pin	Signal		
1	Red	9	+5V
2	Green	10	GND
3	Blue	11	N.C.
4	N.C.	12	SDA
5	GND	13	HSYNC
6	GND	14	VSYN
7	GND	15	SCL
8	GND		

2.31 CompactFlash Connector (CN22)

Pin	Signal	Pin	Signal
1	GND	26	GND
2	DATA3	27	DATA11
3	DATA4	28	DATA12
4	DATA5	29	DATA13
5	DATA6	30	DATA14
6	DATA7	31	DATA15
7	CS#1	32	CS#3
8	GND	33	GND
9	GND	34	IO READ
10	GND	35	IO WRITE
11	GND	36	+5V
12	GND	37	IRQ15
13	+5V	38	+5V
14	GND	39	CSEL
15	GND	40	N.C.
16	GND	41	IDE RESET
17	GND	42	IO READY
18	ADDR2	43	N.C.
19	ADDR1	44	+5V
20	ADDR0	45	DASP
21	DATA0	46	DIAG
22	DATA1	47	DATA8
23	DATA2	48	DATA9
24	N.C.	49	DATA10
25	GND	50	GND

2.32 PME# Connector for PCM-3794 (CN23)

This connector can show the power management events of PCM-3794 (PC/104 + expansion interface, made by AAEON) which is connected to GENE-6310 to provide the function of “Hot Swap.”

Pin	Signal
1	N.C.
2	GND
3	PME#
4	SMBDATA
5	SMBCLK

2.33 RS-232 Serial Port Connector(CN24)

Pin	Signal	Pin	Signal
1	DCD	2	RXD
3	TXD	4	DTR
5	GND	6	DSR
7	RTS	8	CTS
9	RI	10	N.C

2.34 RS-232 Serial Port Connector(CN25)

Pin	Signal	Pin	Signal
1	DCD	2	RXD
3	TXD	4	DTR
5	GND	6	DSR
7	RTS	8	CTS
9	RI	10	N.C

2.35 Option ATX Power Connector(CN26)

Pin	Signal
1	N.C
2	GND
3	PWR-OK
4	GND
5	PS-ON
6	+5VSB

Chapter

3

**Award
BIOS Setup**

3.1 System test and initialization

These routines test and initialize board hardware. If the routines encounter an error during the tests, you will either hear a few short beeps or see an error message on the screen. There are two kinds of errors: fatal and non-fatal. The system can usually continue the boot up sequence with non-fatal errors. Non-fatal error messages usually appear on the screen along with the following instructions:

Press <F1> to RESUME

Write down the message and press the F1 key to continue the boot up sequence.

System configuration verification

These routines check the current system configuration against the values stored in the CMOS memory. If they do not match, the program outputs an error message. You will then need to run the BIOS setup program to set the configuration information in memory.

There are three situations in which you will need to change the CMOS settings:

1. You are starting your system for the first time
2. You have changed the hardware attached to your system
3. The CMOS memory has lost power and the configuration information has been erased.

The GENE-6310 Rev. B CMOS memory has an integral lithium battery backup for data retention. However, you will need to replace the complete unit when it finally runs down.

3.2 Award BIOS setup

Awards BIOS ROM has a built-in Setup program that allows users to modify the basic system configuration. This type of information is stored in battery-backed CMOS RAM so that it retains the Setup information when the power is turned off.

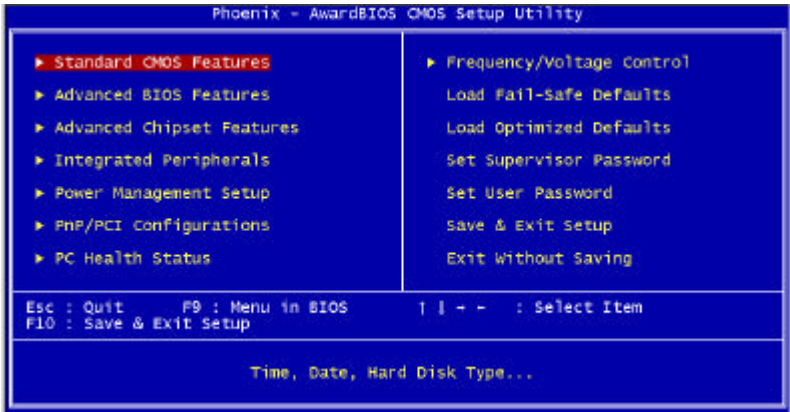

Entering setup

Power on the computer and press immediately. This will allow you to enter Setup.

Standard CMOS Features

Use this menu for basic system configuration. (Date, time, IDE, etc.)

Advanced BIOS Features

Use this menu to set the advanced features available on your system.

Advanced Chipset Features

Use this menu to change the values in the chipset registers and optimize your system performance.

Integrated Peripherals

Use this menu to specify your settings for integrated peripherals. (Primary slave, secondary slave, keyboard, mouse etc.)

Power Management Setup

Use this menu to specify your settings for power management. (HDD power down, power on by ring, KB wake up, etc.)

PnP/PCI Configurations

This entry appears if your system supports PnP/PCI.

PC Health Status

This menu allows you to set the shutdown temperature for your system.

Frequency/Voltage Control

Use this menu to specify your settings for frequency/ voltage control.

Load Fail-Safe Defaults

Use this menu to load the BIOS default values for the minimal/stable performance for your system to operate.

Load Optimized Defaults

Use this menu to load the BIOS default values that are factory settings for optimal performance system operations. While AWARD has designated the custom BIOS to maximize performance, the factory has the right to change these defaults to meet their needs.

Set Supervisor/User Password

Use this menu to set Supervisor/User Passwords.

Save and Exit Setup

Save CMOS value changes to CMOS and exit setup.

Exit Without Saving

Abandon all CMOS value changes and exit setup.

3.3 Standard CMOS Features

When you choose the Standard CMOS Features option from the INITIAL SETUP SCREEN menu, the screen shown below is displayed. This standard Setup Menu allows users to configure system components such as date, time, hard disk drive, floppy drive and display. Once a field is highlighted, on-line help information is displayed in the right box of the Menu screen.

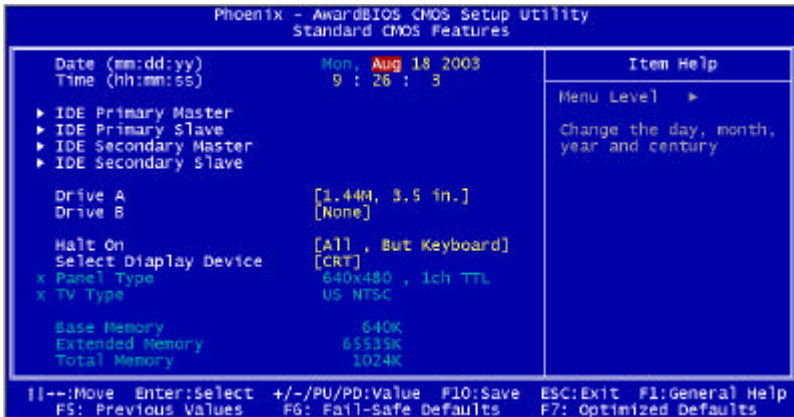

3.4 Advanced BIOS Features

By choosing the Advanced BIOS Features option from the INITIAL SETUP SCREEN menu, the screen below is displayed. This sample screen contains the manufacturer's default values for the GENE-6310 Rev. B.

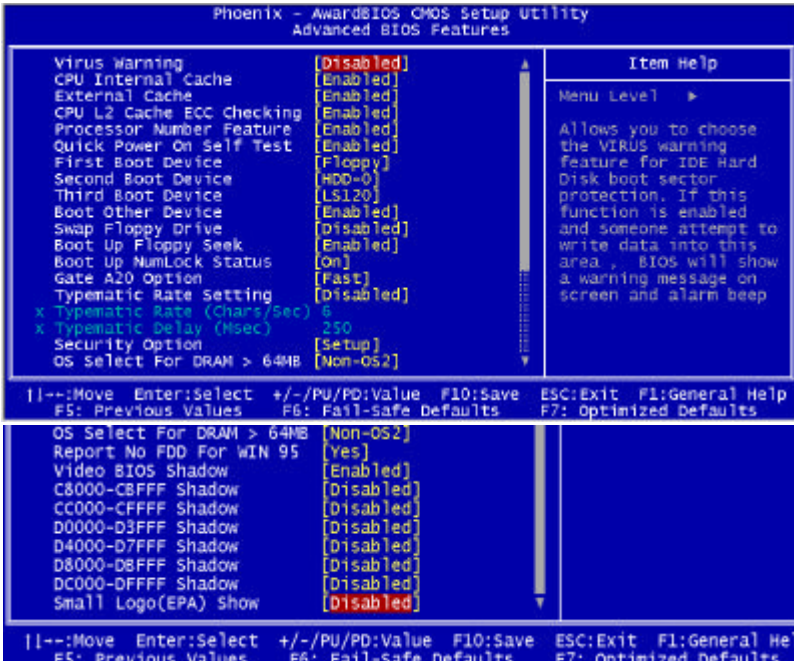

3.5 Advanced Chipset Features

By choosing the Advanced Chipset Features option from the INITIAL SETUP SCREEN menu, the screen below is displayed. This sample screen contains the manufacturer's default values for the GENE-6310 Rev. B.

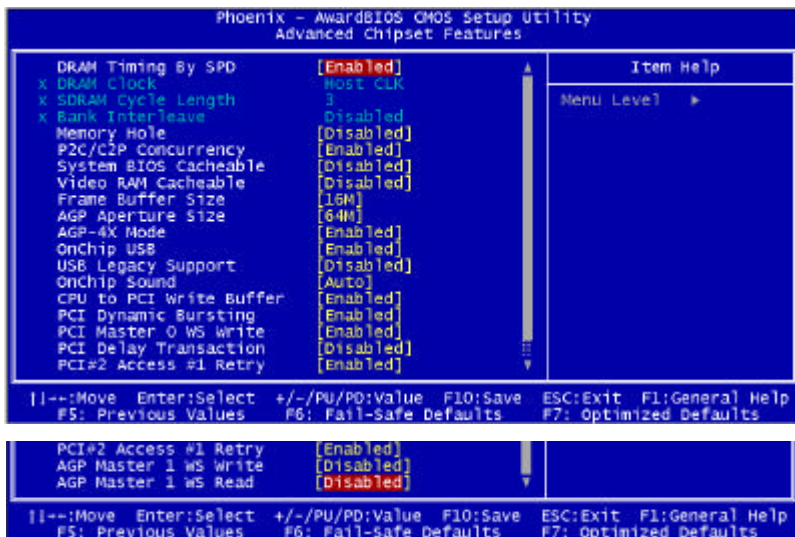

3.6 Integrated Peripherals

By choosing the Integrated Peripherals from the INITIAL SETUP SCREEN menu, the screen below is displayed. This sample screen contains the manufacturer's default values for the GENE-6310 Rev. B.

```

Phoenix - AwardBIOS CMOS Setup Utility
Integrated Peripherals

OnChip IDE Channel0 [Enabled]
OnChip IDE Channel1 [Enabled]
IDE Prefetch Mode [Enabled]
Primary Master PIO [Auto]
Primary Slave PIO [Auto]
Secondary Master PIO [Auto]
Secondary Slave PIO [Auto]
Primary Master UDMA [Auto]
Primary Slave UDMA [Auto]
Secondary Master UDMA [Auto]
Secondary Slave UDMA [Auto]
Init Display First [PCI Slot]
IDE HDD Block Mode [Enabled]
Onboard FDD Controller [Enabled]
Onboard Serial Port 1 [3F8/IRQ4]
Onboard Serial Port 2 [2F8/IRQ3]
UART 2 Mode [Standard]
x IR Function Duplex Half
x TX,RX inverting enable No, Yes

Item Help
Menu Level >

[ ]--:Move Enter:Select +/-/PU/PD:Value F10:Save ESC:Exit F1:General Help
F5: Previous Values F6: Fail-safe Defaults F7: Optimized Defaults
  
```

```

x TX,RX inverting enable No, Yes
Onboard Parallel Port [378/IRQ7]
Onboard Parallel Mode [Normal]
ECP Mode Use DMA [3]
Parallel Port EPP Type [EPP1.9]
Onboard Serial Port 3 [Disabled]
x Serial Port 3 Use IRQ IRQ10
Onboard Serial Port 4 [Disabled]
x Serial Port 4 Use IRQ IRQ11
Onboard Legacy Audio [Enabled]
Sound Blaster [Disabled]
SB I/O Base Address [220H]
SB IRQ Select [IRQ 5]
SB DMA Select [DMA 1]
MPU-401 [Disabled]
MPU-401 I/O Address [330-333H]

Item Help
Menu Level >

[ ]--:Move Enter:Select +/-/PU/PD:Value F10:Save ESC:Exit F1:General Help
F5: Previous Values F6: Fail-safe Defaults F7: Optimized Defaults
  
```

3.7 Power management setup

By choosing the Power Management Setup from the INITIAL SETUP SCREEN menu, the screen below is displayed. This sample screen contains the manufacturer's default values for the GENE-6310 Rev. B.

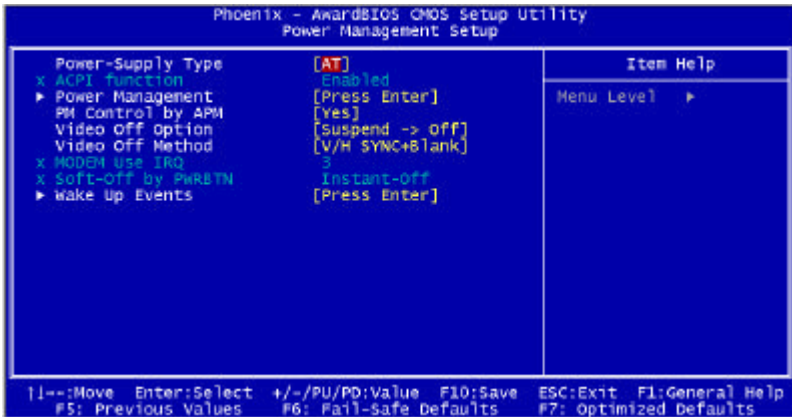

3.8 PnP/PCI Configuration

By choosing the PnP/PCI configurations from the Initial Setup Screen menu, the screen below is displayed. This sample screen contains the manufacturer's default values for the GENE-6310 Rev. B.

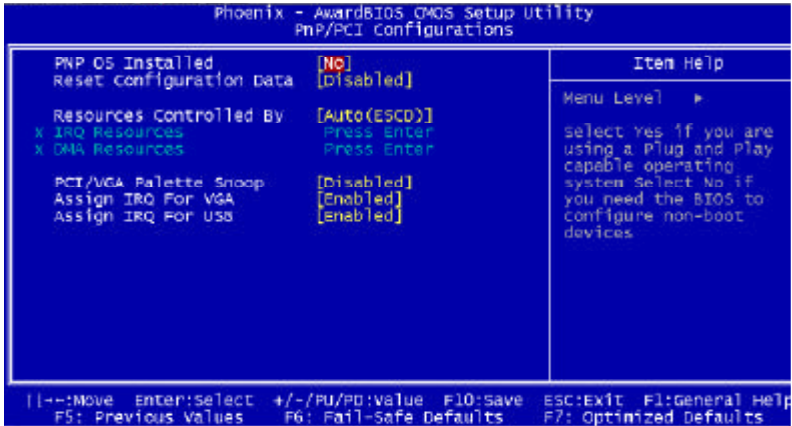

3.9 PC Health Status

By choosing the PC Health Status from the Initial Setup Screen menu, the screen below is displayed. This sample screen contains the manufacturer's default values for the GENE-6310 Rev. B.

```
Phoenix - AwardBIOS CMOS Setup Utility
PC Health Status

Current CPU Temp.
Current CPU/FAN Speed
Vcore
  3.5V
  3.3V
  5V
  12V

Item Help
Menu Level ▶

[Left Arrow]=Move Enter=Select +/-/PU/PD=Value F10=Save ESC=Exit F1=General Help
F5: Previous Values F6: Fail-Safe Defaults F7: Optimized Defaults
```

3.10 Frequency/Voltage control

By choosing the Frequency/Voltage Control from the Initial Setup Screen menu, the screen below is displayed. This sample screen contains the manufacturer's default values for the GENE-6310 Rev. B.

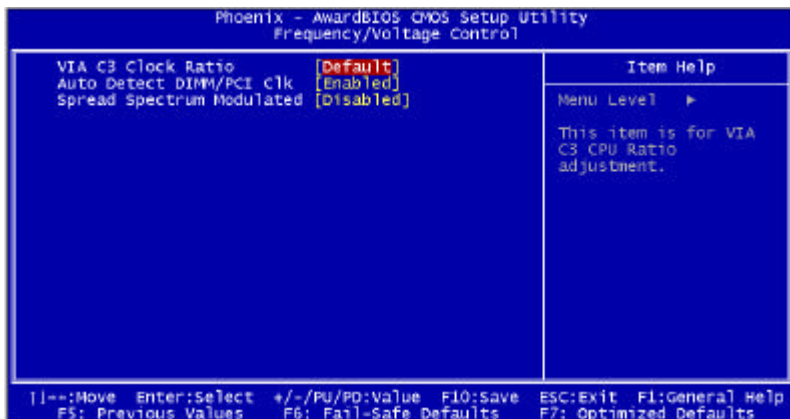

3.11 Load Fail-Safe Defaults

When you press <Enter> on this item you get a confirmation dialog box with a message similar to:

Load Fail-Safe Default (Y/N)?

Pressing "Y" loads the BIOS default values for the most stable, minimal performance system operations.

3.12 Load Optimized Defaults

When you press <Enter> on this item you get a confirmation dialog box with a message similar to:

Load Optimized Defaults (Y/N)?

Pressing "Y" loads the default values that are manufacturer's settings for optimal performance system operations.

3.13 Set Supervisor/User Password

You can set either SUPERVISOR or USER PASSWORD, or both of them. The difference between the two is that the supervisor password allows unrestricted access to enter and change the options of the setup menus, while the user password only allows entry to the program, but not modify options.

To abort the process at any time, press Esc.

In the Security Option item in the BIOS Features Setup screen, select System or Setup:

System Enter a password each time the system boots and whenever you enter Setup.

Setup Enter a password whenever you enter Setup.

NOTE: To clear the password, simply press Enter when asked to enter a password. Then the password function is disabled.

3.14 Save & Exit setup

If you select this option and press <Enter>, the values entered in the setup utilities will be recorded in the chipset's CMOS memory. The microprocessor will check this every time you turn on your system and compare this to what it finds as it checks the system. This record is required for the system to operate.

3.15 Exit without saving

Selecting this option and pressing <Enter> allows you to exit the Setup program without recording any new value or changing old one.

Chapter

4

**Driver
Installation**

The GENE-6310 Rev. B comes with a CD-ROM which contains most of drivers and utilities of your needs.

There are several installation ways depending on the driver package under different Operating System application.

If you utilize Windows NT series OS, you are strongly recommended to download the latest version Windows NT Service Pack from Microsoft website and install it before installing any driver.

Please follow the sequence below to install the drivers:

Step 1 – Install System Driver

Step 2 – Install VGA Driver

Step 3 – Install Audio Driver

Step 4 – Install LAN Driver

For installation procedures of each driver, you may refer to section 4.1-4.2.

4.1 Installation 1:

Applicable for Windows 2000/98/ME

1. Insert the GENE-6310 Rev. B CD-ROM into the CD-ROM Drive.
2. From the CD-ROM, select the desired component Driver folder, and then select the desired Operation System folder to double click on the Setup.exe icon. A driver installation screen will appear.
(Notice: take VGA driver installation under Windows 98 for example, choose the corresponding folder depending on your OS)
3. A driver installation screen will appear, please follow the onscreen instructions to install the driver in sequence and click on the Next button.
(Notice: In some cases the system will ask you to insert Windows 98 CD ROM and key in its path. Then click on the OK button to key in path.)
4. Click on the **Finish** button to finish installation process. And allow the system to reboot.

4.2 Installation 2:

Applicable for Windows 2000/ 98/ME

1. Insert the **GENE-6310 Rev. B CD-ROM** into the CD-ROM Drive.
2. Click on **Start** button, select the **Settings**, and then click on the **Control Panel** icon.
3. Double click on the **Add/Remove Hardware** icon and **Add New Hardware Wizard** will appear. Click on the **Next** button.
4. Select **Search for the best driver for your device (Recommended)** and click on the **Next** button.
5. Select **Specify a location**, click on **Have Disk** button then key in the CD-ROM path and specify component drivers and OS folders. Then click on the **Next** button.
6. The Wizard shows that Windows driver file search for the device. Click on the **Next** button.
7. The system will ask you to insert Windows 98 CD ROM. Click on the **OK** button to insert CD-ROM and key in path.
8. Click on the **OK** button.
9. Click on the **Finish** button to finish installation process. And allow the system to reboot.

Appendix

A

Programming the Watchdog Timer

Programming the Watchdog timer

An on-board watchdog timer reduces the chance of disruptions which CPLD (compact programmable logical device) interference can cause. This is an invaluable protective device for standalone or unmanned applications. When the watchdog timer activates (CPU processing has come to a halt), it can reset the system, or generate an interrupt on IRQ10, IRQ11, IRQ15, and NMI. This can be set via I/O Port 444, the functions as following:

0:	RESET
1:	NMI
2:	IRQ10
3:	IRQ11
4:	IRQ15

If you decide to program the watchdog timer, you must write data to I/O port 443 (hex). The output data is a value timer. You can write from 01 (hex) to FF (hex) for input second data, and the related timer is 1 to 255 seconds.

After data entry, your program must refresh the watchdog timer by rewriting the I/O port 443 (hex) while simultaneously setting it. When you want to disable the watchdog timer, your program should read a Hex value from I/O port 80 (hex).

The following procedure is a sample program for the watchdog timer:

- Type C:\DOS\Debug <Enter>
- To start watchdog timer and set function "Reset" type:
 - 444 0<Enter>; out 444h data 0.

- To input watchdog timers timer-out interval of 5 seconds type: o
o 443 05<Enter>; out 443h data 05.
- To disable the watchdog timer type:
i 80<Enter>

The time interval data of the watchdog timer is shown in binary code (8 bits).

Sample 2 : 5 seconds

0	0	0	0	0	1	0	1
---	---	---	---	---	---	---	---