

FWS-816B

1U Rackmount

Network Appliance Platform

1 3.5" Disk Drive bay

8 LAN Ports

2 Type A USB Ports

Copyright Notice

This document is copyrighted, 2007. All rights are reserved. The original manufacturer reserves the right to make improvements to the products described in this manual at any time without notice.

No part of this manual may be reproduced, copied, translated, or transmitted in any form or by any means without the prior written permission of the original manufacturer. Information provided in this manual is intended to be accurate and reliable. However, the original manufacturer assumes no responsibility for its use, or for any infringements upon the rights of third parties that may result from its use.

The material in this document is for product information only and is subject to change without notice. While reasonable efforts have been made in the preparation of this document to assure its accuracy, AAEON assumes no liabilities resulting from errors or omissions in this document, or from the use of the information contained herein.

AAEON reserves the right to make changes in the product design without notice to its users.

Acknowledgments

All other products' name or trademarks are properties of their respective owners.

- Award is a trademark of Award Software International, Inc.
- CompactFlash™ is a trademark of the Compact Flash Association.
- Intel®, Pentium® M, and Core 2 Duo are trademarks of Intel® Corporation.
- Microsoft Windows® is a registered trademark of Microsoft Corp.
- ISoundBlaster is a trademark of Creative Labs, Inc.

All other product names or trademarks are properties of their respective owners.

Packing List

Before you begin installing your card, please make sure that the following materials have been shipped:

- 1 FWS-816B
- 1 Quick Installation Guide
- 1 CD-ROM for manual (in PDF format) and drivers
- 1 Heatpipe Module
- 1 Serial ATA Cable
- 1 Hard Disk Drive Power Cable
- 2 Ear Brackets
- Screw Accessories

If any of these items should be missing or damaged, please contact your distributor or sales representative immediately.

Note:

PS2 keyboard/mouse cable and VGA Cable are optional accessories, please purchase those cables according to the following item numbers.

1701160302 VGA Cable

1700060150 PS2 KB/MS Cable

Contents

Chapter 1 General Information

| | |
|--------------------------------------|-----|
| 1.1 Introduction..... | 1-2 |
| 1.2 Features | 1-3 |
| 1.3 Specifications | 1-4 |
| 1.4 General System Information | 1-7 |

Chapter 2 Quick Installation Guide

| | |
|---|------|
| 2.1 Safety Precautions | 2-2 |
| 2.2 Location of Connectors | 2-3 |
| 2.3 Mechanical Drawing..... | 2-4 |
| 2.4 List of Jumpers..... | 2-5 |
| 2.5 List of Connectors | 2-6 |
| 2.6 Setting Jumpers | 2-7 |
| 2.7 Clear CMOS (JP1) | 2-8 |
| 2.8 Front Panel Connector (FP1)..... | 2-8 |
| 2.9 Front Panel Connector (FP2)..... | 2-8 |
| 2.10 USB Connector (USB1) | 2-9 |
| 2.11 USB Pin Header (CN4, CN5)..... | 2-9 |
| 2.12 RS-232 Serial Port Connector (COM1/2)..... | 2-9 |
| 2.13 Power Connector (ATX2)..... | 2-10 |
| 2.14 VGA Connector (CN1)..... | 2-10 |
| 2.15 FAN Connector (CPUFAN1) | 2-11 |
| 2.16 FAN Connector (FAN1, FAN2, FAN3) | 2-11 |

| | |
|--|------|
| 2.17 RJ-45 Phone Jack Connector (LAN1-8)..... | 2-11 |
| 2.18 PS2 Keyboard/ Mouse Connector (CN7) | 2-12 |
| 2.19 SATA Power Connector (PWR1) | 2-12 |
| 2.20 LCM & Key Pad Control Connector (LCMA1) | 2-12 |
| 2.21 Power Connector for PCI-X Riser (CN8)..... | 2-13 |
| 2.22 Removing the Cover..... | 2-14 |
| 2.23 Installing the CPU and the Heatpipe | 2-15 |
| 2.24 Installing the Hard Disk Drive | 2-23 |
| 2.25 Installing the Add-on Card..... | 2-26 |

Chapter 3 Award BIOS Setup

| | |
|--|-----|
| 3.1 System Test and Initialization | 3-2 |
| 3.2 Award BIOS Setup | 3-3 |

Chapter 4 Driver Installation

| | |
|------------------------|-----|
| 4.1 Installation | 4-3 |
|------------------------|-----|

Appendix A Programming the Watchdog Timer

| | |
|--|-----|
| A.1 Programming | A-2 |
| A.2 W83627EHG Watchdog Timer Initial Program | A-6 |

Appendix B I/O Information

| | |
|----------------------------------|-----|
| B.1 I/O Address Map | B-2 |
| B.2 Memory Address Map..... | B-3 |
| B.3 IRQ Mapping Chart..... | B-4 |
| B.4 DMA Channel Assignments..... | B-4 |

Appendix C Standard Firewall Platform Setting

| | |
|--|------|
| C.1 Standard Firewall Platform Setting | C-2 |
| C.2 Status LED Sample Code..... | C-3 |
| C.3 LAN Bypass Mode Sample Code | C-6 |
| C.4 LCM Sample Code | C-8 |
| C.5 Console Redirection | C-14 |

Chapter

1

**General
Information**

1.1 Introduction

FWS-816 Rev.B adopts the Core 2 Duo LGA 775 Processor, up to 2.66GHz with 533/800/1066 Front Side Bus. Moreover, the chipset is equipped with Intel® 945G and Intel® 82801FB (ICH7R). The system memory features 2x240-pin DDRII 667 SDRAM DIMM socket total up to 4GB and supports dual channel. It deploys eight LAN ports that consist of six PCIe Gigabit Ethernet LAN ports with two ports bypass function and two 10/100Base-TX LAN ports. FWS-816's condensed appearance features 1U form factor that fits nicely into a space limited environment.

This compact FWS-816B is equipped with one Ultra ATA, two SATA II and CompactFlash™ Type II connector with ATA mode. In addition, it offers flexible expansion with network products and features one PCI expansion slot, one Mini PCI slot, two USB2.0 ports and one RS-232 console port. The console port deploys console re-direction that increases the network security via remote control. Moreover, there is a front panel support LCM with keypad control that allows for easy access and operation. All of these designs provide for a more user-friendly solution.

1.2 Features

- 1U eight LAN ports network appliance platform
- Intel® Core 2 Duo CPU up to 2.66GHz (Dual Core up to 3.6GHz) (Tc =70.8° @ 115W)
- 2x240-pin dual channel DDRII 667 SDRAM DIMM support up to 4GB (DIMM Height under 31mm)
- Six 10/100/1000Base-TX ports (2 ports bypass function) & two 10/100 Ethernet ports
- One Ultra ATA-100 port & two SATA II ports
- CompactFlash Type-II connector & DOM up to 2GB (DOM Height under 29mm)
- 250W power with auto range input
- Six USB2.0 ports (4 Pin Headers)
- Parallel LCM with keypad & two USB2.0 ports & one RS-232 console (front panel) port
- One internal 3.5" disk drive bay
- PCI-E [x1] / PCI-X/ PCI Expansion Slot (Optional)

1.3 Specifications

System

| | |
|----------------------------|--|
| Construction: | 1U 8-port firewall heavy-duty steel system |
| CPU | Intel® Core 2 Duo LGA775 up to 2.66GHz (FSB 400/533/800/1066, Dual Core up to 3.6GHz) (Tc =70.8° @ 115W) |
| Memory | 2 x 240-pin DDRII 667 DIMM Socket, total up to 4GB, Support Dual Channel |
| LAN | 6 x PCI-E 【x1】 dual 10/100/1000Mb LAN (with 2-port bypass LAN3 & LAN4), 2x PCI 10/100Mb, RJ-45 X8 |
| BIOS | Award Plug & Play FWH BIOS – 4Mb ROM |
| IDE | ATA-100 x 1 channel (Supports CD-ROM ATAPI devices) |
| SATA Interface | SATA II x 2 |
| Solid Storage Disk | Supports CFD Type II connector(ATA mode) |
| Expansion Interface | Mini PCI Type III Socket |
| Watchdog Timer | 1~255 steps, can be set with software on Super I/O |
| RTC | Internal RTC |
| Storage | Internal : One 3.5" Hard Disk Drive Bay |

| | |
|---------------------|---|
| System Fan | Three 4cm Ball Bearing Fans |
| Color | Blue and Red |
| LCM | 2 x16 characters with 4 keypad control |
| Power Supply | ATX 250W, auto range |
| Dimensions | 16.93" (W) x 14.96" (D) x 1.73"(H) (430mm x 380mm x 44mm) —Chassis 9.84" (W) x 11.02" (D) (250mm x 280mm) —Board |
| Net Weight | 17.6 lb (8 kg) |

Display

| | |
|-----------------------|--|
| VGA Controller | Integrated VGA on Intel 945G, pin header connector |
|-----------------------|--|

I/O

| | |
|-----------------------------|---|
| Serial Port | Two COM ports: (Internal Pin Header x 1) COM 1: RS-232 COM 2: RS-232 (Pin Header) |
| Keyboard & Mouse | Reserve pin header |
| Universal Serial Bus | Two TYPE-A Connectors on front panel |
| Front I/O Panel | One Power LED One Bypass LED One Status LED One HDD Active LED Eight LAN LEDs |

| | |
|-----------------------|---|
| | Two USB Ports |
| | Eight LAN Ports |
| | One DB-9 connector |
| | One LCM Display |
| | One Reset Button |
| Rear I/O panel | One PCI-E [x1] / PCI-X/ PCI expansion slot (Optional) |

Environmental

| | |
|----------------------------|---|
| Operating Temp. | 32°F ~ 104°F (0°C ~ 40°C) |
| Storage Temp. | -4°F ~ 140°F (-20°C ~ 60°C) |
| Operating humidity: | 10 ~ 80% |
| Storage humidity: | 10 ~ 80% @ 40°C, non-condensing |
| Vibration | 0.5G / 5 ~ 500Hz / operation (3.5" Hard Disk Drive) |
| | 1.5G / 5 ~ 500Hz / non operation |
| Shock | 10G peak acceleration (11 m sec. duration), operation |
| | 20G peak acceleration (11 m sec. duration), non operation |

1.4 General System Information

Front Panel

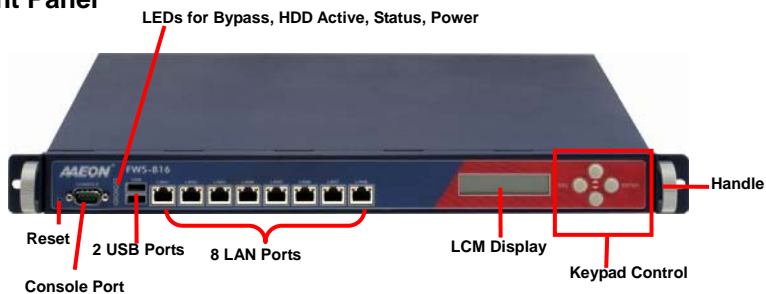

Inside

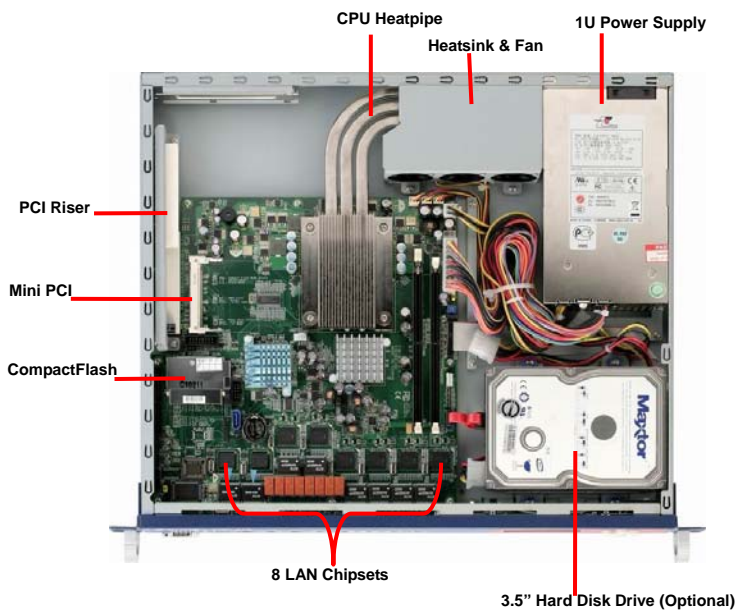

Chapter

2

**FWS-816B
Quick
Installation
Guide**

Notice:

The Quick Installation Guide is derived from Chapter 2 of the user manual. For other chapters and further installation instructions, please refer to the user manual CD-ROM that came with the product.



2.1 Safety Precautions

The installation is intended for technically qualified personnel who have experience installing and configuring system boards.

The equipment can be installed in a restricted access location (RAL) only.

A restricted access location is a site location for equipment where the following criteria apply:

01. Access can only be gained by service persons or by users who have been trained on the restrictions and the precautions for this specific site.

02. Access is by means of at least one of the following, special tool, lock and key, or other means of security, and is controlled by the authority responsible for the location.

Safety Precautions:

Warning!



Always completely disconnect the power cord from your board whenever you are working on it. Do not make connections while the power is on, because a sudden rush of power can damage sensitive electronic components.

Caution!



Always ground yourself to remove any static charge before touching the board. Modern electronic devices are very sensitive to static electric charges. Use a grounding wrist strap at all times. Place all electronic components on a static-dissipative surface or in a static-shielded bag when they are not in the chassis

2.2 Location of Connectors

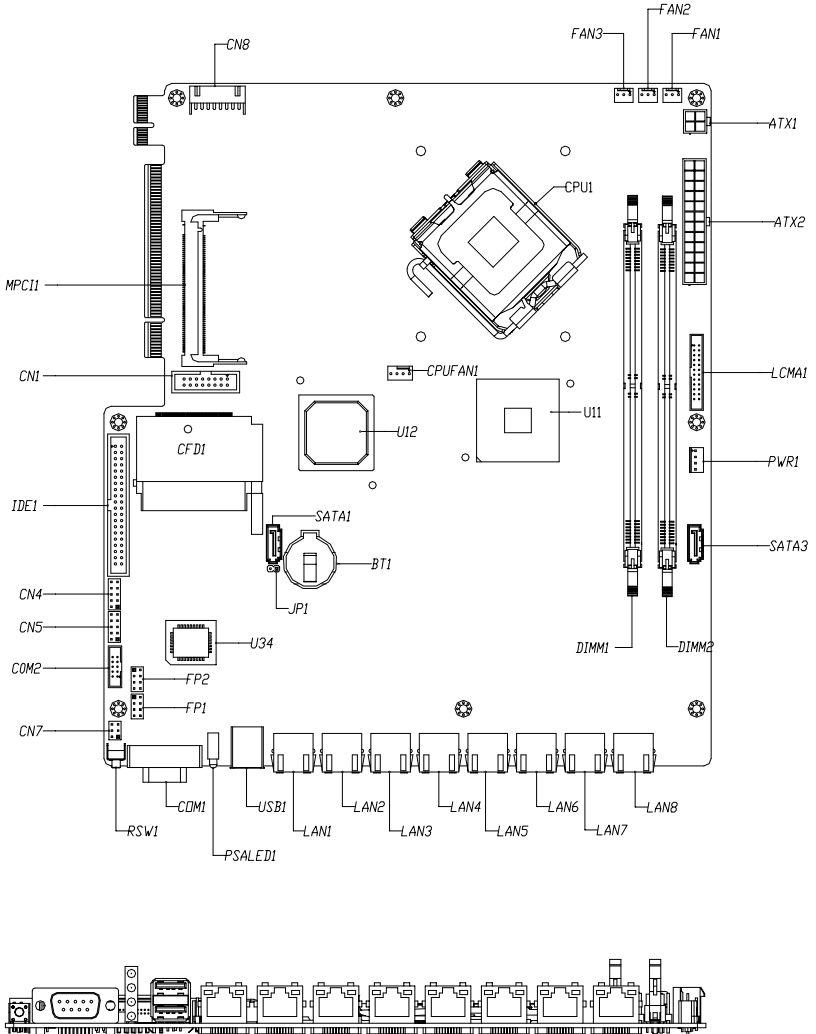

2.3 Mechanical Drawing

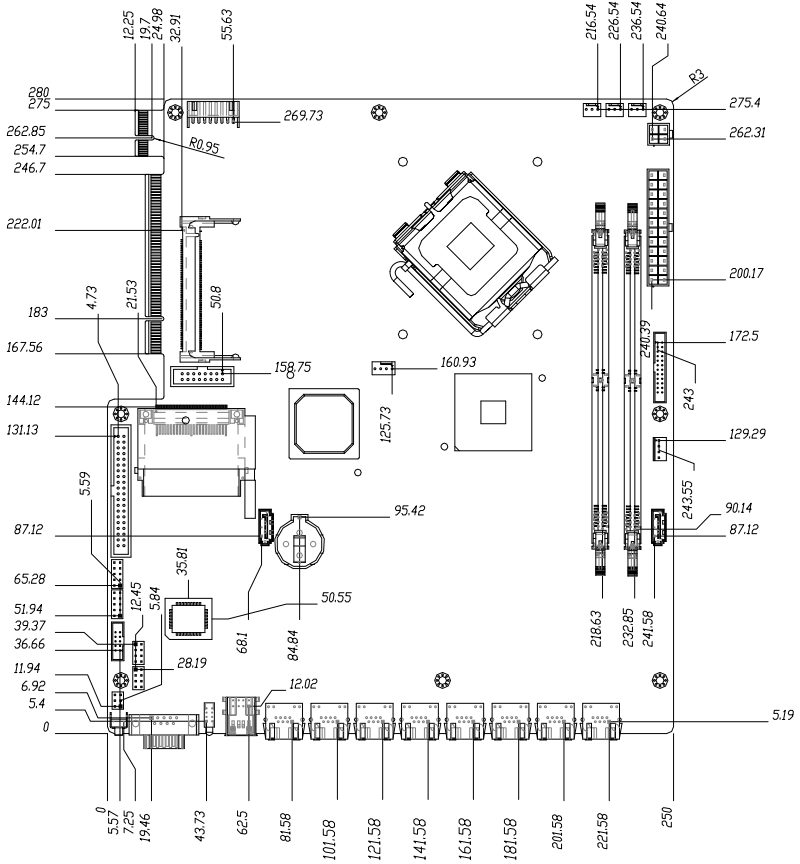

Unit: mm

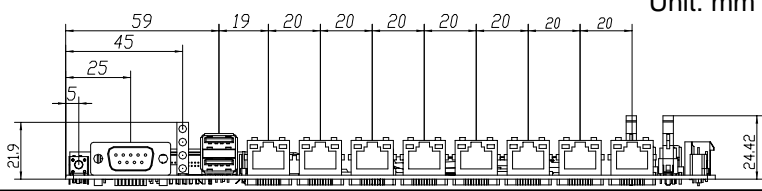

2.4 List of Jumpers

The board has a number of jumpers that allow you to configure your system to suit your application.

The table below shows the function of each of the board's jumpers:

| Label | Function |
|--------------|-------------------------|
| JP1 | Clear CMOS |
| FP1 | Front Panel Connector 1 |
| FP2 | Front Panel Connector 2 |

2.5 List of Connectors

The board has a number of connectors that allow you to configure your system to suit your application. The table below shows the function of each board's connectors:

| Label | Function |
|-----------|----------------------------------|
| ATX2 | ATX Power Connector |
| ATX1 | ATX Power_12V Connector |
| SATA1 & 3 | Serial ATA Connector |
| CN1 | VGA Display PIN HEADER |
| IDE1 | IDE Connector |
| USB1 | USB Connector |
| CN4 \ 5 | USB PIN HEADER |
| COM2 | RS-232 Serial Port PIN HEADER |
| COM1 | RS-232 Serial Port Connector |
| DIMM1~2 | DIMM Slot |
| FAN1~3 | Fan Connector |
| CPUFAN1 | Fan Connector |
| LAN1~8 | RJ-45 PHONEJACK Connector |
| CN7 | PS2 Keyboard/Mouse Connector |
| PWR1 | SATA POWER Connector |
| CFD1 | Compact Flash Slot |
| MPC11 | Mini PCI Slot |
| LCMA1 | LCM & Key Pad Control PIN HEADER |
| CN8 | Power Connector for PCI-X Riser |

Note: DIMM height limitation is 31mm; DOM height limitation is 29mm.

2.6 Setting Jumpers

You configure your card to match the needs of your application by setting jumpers. A jumper is the simplest kind of electric switch. It consists of two metal pins and a small metal clip (often protected by a plastic cover) that slides over the pins to connect them. To “close” a jumper you connect the pins with the clip.

To “open” a jumper you remove the clip. Sometimes a jumper will have three pins, labeled 1, 2 and 3. In this case you would connect either pins 1 and 2 or 2 and 3.

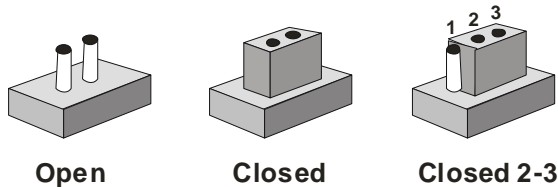

A pair of needle-nose pliers may be helpful when working with jumpers.

If you have any doubts about the best hardware configuration for your application, contact your local distributor or sales representative before you make any change.

Generally, you simply need a standard cable to make most connections.

2.7 Clear CMOS (JP1)

| JP1 | Function |
|------|---------------------|
| 1-2 | Clear |
| Open | Protected (Default) |

2.8 Front Panel Connector (FP1)

| Pin | Signal | Pin | Signal |
|-----|---------------------|-----|------------------|
| 1 | Power On Button (+) | 2 | Reset Switch (+) |
| 3 | Power On Button (-) | 4 | Reset Switch (-) |
| 5 | IDE LED (+) | 6 | Power LED (+) |
| 7 | IDE LED (-) | 8 | Power LED (-) |

2.9 Front Panel Connector (FP2)

| Pin | Signal | Pin | Signal |
|-----|----------------------|-----|-------------------|
| 1 | External Speaker (+) | 2 | NC |
| 3 | NC | 4 | NC |
| 5 | Internal Buzzer (-) | 6 | I2C Bus SMB Clock |
| 7 | External Speaker (-) | 8 | I2C Bus SMB Data |

Note: Internal Buzzer enable: Close Pin 5,7

2.10 USB Connector (USB1)

| Pin | Signal | Pin | Signal |
|-----|--------|-----|--------|
| 1 | GND | 2 | XUSB4+ |
| 3 | XUSB4- | 4 | +5V |
| 5 | GND | 6 | XUSB5+ |
| 7 | XUSB5- | 8 | +5V |

Note: When activating the COM port LL5 test, please “Disable” the USB keyboard and mouse in BIOS setting.

2.11 USB Pin Header (CN4, CN5)

| Pin | Signal | Pin | Signal |
|-----|--------|-----|--------|
| 1 | +5V | 2 | GND |
| 3 | USB- | 4 | GND |
| 5 | USB+ | 6 | USB+ |
| 7 | GND | 8 | USB- |
| 9 | GND | 10 | +5V |

2.12 RS-232 Serial Port Connector (COM1/2)

| Pin | Signal | Pin | Signal |
|-----|--------|-----|--------|
| 1 | DCD | 2 | RXD |
| 3 | TXD | 4 | DTR |
| 5 | GND | 6 | DSR |

| | | | |
|---|-----|---|-----|
| 7 | RTS | 8 | CTS |
| 9 | RI | | |

2.13 Power Connector (ATX2)

| Pin | Signal | Pin | Signal |
|-----|--------|-----|--------|
| 1 | +3.3V | 2 | +3.3V |
| 3 | GND | 4 | +5V |
| 5 | GND | 6 | +5V |
| 7 | GND | 8 | PWROK |
| 9 | +5VSB | 10 | +12V |
| 11 | +12V | 12 | +3.3V |
| 13 | +3.3V | 14 | -12V |
| 15 | GND | 16 | PS_ON |
| 17 | GND | 18 | GND |
| 19 | GND | 20 | NC |
| 21 | +5V | 22 | +5V |
| 23 | +5V | 24 | GND |

2.14 VGA Connector (CN1)

| Pin | Signal | Pin | Signal |
|-----|--------|-----|---------|
| 1 | VGA R | 2 | VGA VCC |
| 3 | VGA G | 4 | GND |

| | | | |
|----|-------|----|----------|
| 5 | VGA B | 6 | NC |
| 7 | NC | 8 | VGA DATA |
| 9 | GND | 10 | VGA HS |
| 11 | GND | 12 | VGA VS |
| 13 | GND | 14 | VGA CLK |
| 15 | GND | 16 | NC |

2.15 FAN Connector (CPUFAN1)

| Pin | Signal | Pin | Signal |
|-----|--------|-----|--------|
| 1 | GND | 2 | +12V |
| 3 | SENCE | 4 | CTRL |

2.16 FAN Connector (FAN1, FAN2, FAN3)

| Pin | Signal | Pin | Signal |
|-----|--------|-----|--------|
| 1 | GND | 2 | +12V |
| 3 | SENCE | | |

2.17 RJ-45 Phone Jack Connector (LAN1~8)

| Pin | Signal | Pin | Signal |
|-----|--------|-----|--------|
| 1 | TX+ | 2 | TX- |
| 3 | RX+ | 4 | RX- |
| 5 | T45 | 6 | T45 |

| | | | |
|----|-----------|----|----------|
| 7 | T78 | 8 | T78 |
| 9 | BLINK100- | 10 | BLINK1G- |
| 11 | BACT | 12 | +3.3V |
| 13 | GND | 14 | GND |

2.18 PS2 Keyboard/ Mouse Connector (CN7)

| Pin | Signal |
|-----|---------|
| 1 | KB_DATA |
| 2 | KB_CLK |
| 3 | GND |
| 4 | +5V |
| 5 | MS_DATA |
| 6 | MS_CLK- |

2.19 SATA Power Connector (PWR1)

| Pin | Signal | Pin | Signal |
|-----|--------|-----|--------|
| 1 | +12V | 2 | GND |
| 3 | GND | 4 | +5V |

2.20 LCM & Key Pad Control Connector (LCMA1)

| Pin | Signal | Pin | Signal |
|-----|--------|-----|--------|
| 1 | POWER | 2 | GND |
| 3 | LSLIN- | 4 | VEE |

| | | | |
|----|-------|----|--------|
| 5 | LAFD- | 6 | LINIT- |
| 7 | LPD1 | 8 | LPD0 |
| 9 | LPD3 | 10 | LPD2 |
| 11 | LPD5 | 12 | LPD4 |
| 13 | LPD7 | 14 | LPD6 |
| 15 | LCD- | 16 | VCC |
| 17 | UP | 18 | RIGHT |
| 19 | LEFT | 20 | DOWN |
| 21 | RESET | 22 | NC |
| 23 | NC | 24 | NC |

2.21 Power Connector for PCI-X Riser (CN8)

| Pin | Signal | Pin | Signal |
|-----|--------|-----|--------|
| 1 | GND | 2 | +3.3V |
| 3 | +3.3V | 4 | +3.3V |
| 5 | -12V | 6 | +5V |
| 7 | +5V | 8 | GND |

2.22 Removing the Cover

Before you install drives or plug-in cards into the FWS-816B, please switch the unit off and remove the power cord first.

Step 1: Unscrew the upper lid

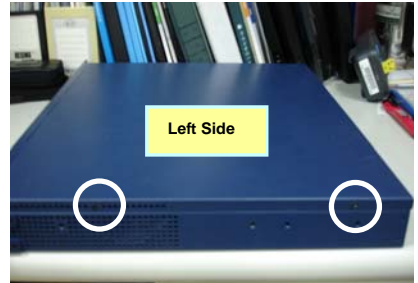
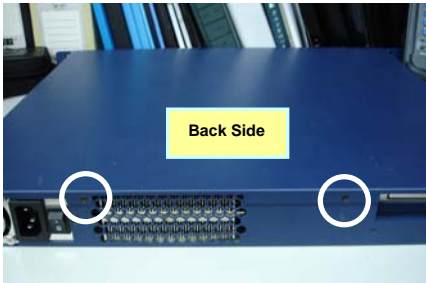

Step 2: Isolate the upper lid from the chassis



2.23 Installing the CPU and the Heatpipe

Step 1: Get the white tape from the interstice

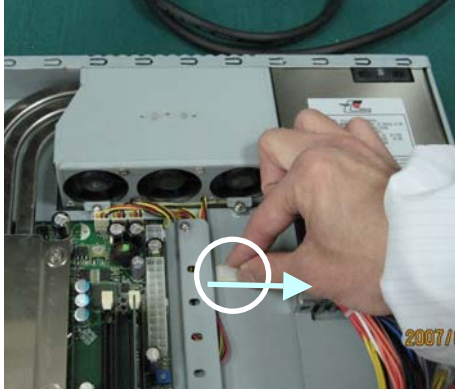

Step 2: Pull up the power cable

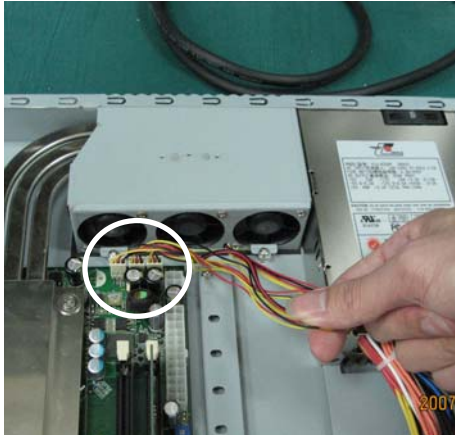

Step 3: Loosen these two screws and pull off the power cable of the three fans



Step 4: Lift up the fan module aside

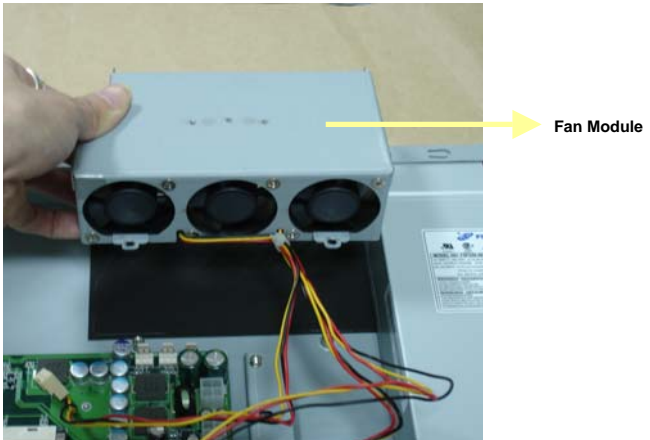

Step 5: Lift up the socket



Step 6: Put the CPU on socket

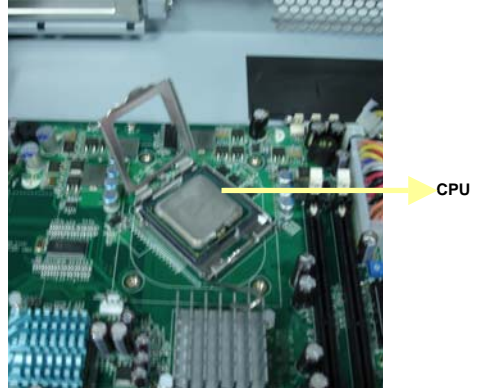

Step 7: Lock the CPU Socket

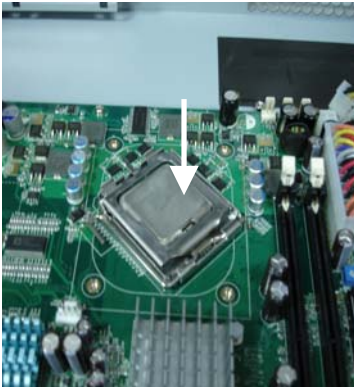

Step 8: The Heatpipe module is already with thermal paste

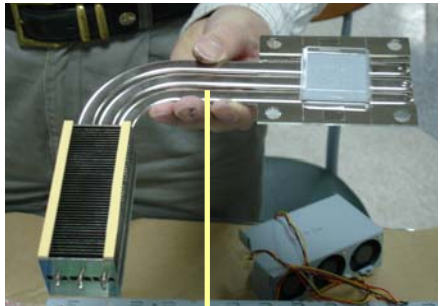

Step 9: Remove the transparent cap

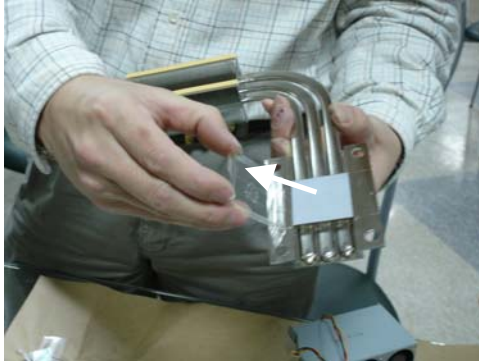

Step 10: Put the heatpipe on the Motherboard where the socket has already been put on CPU in the Chassis

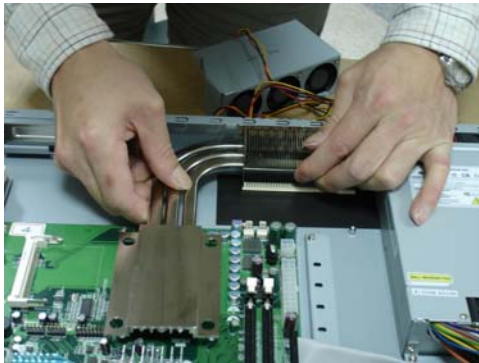

Step 11: Be sure the heatpipe has been put in the right position against the vent properly

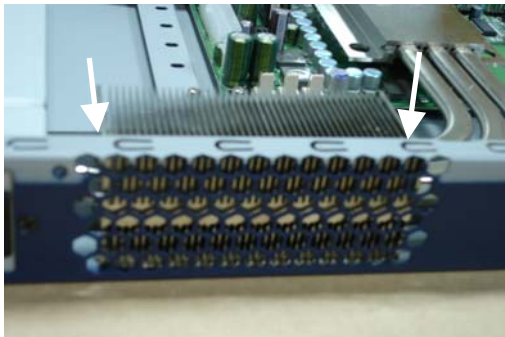

Step 12: Fasten the four screws of the heatpipe

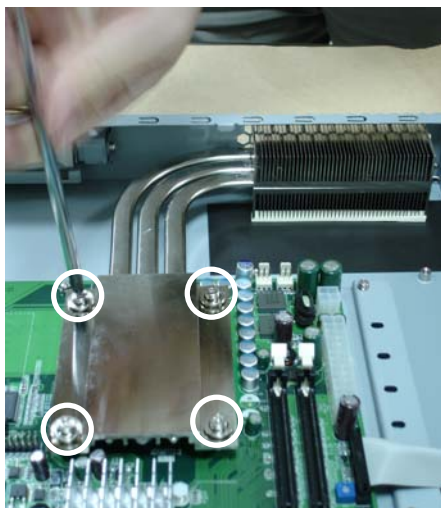

Step 13: Put the fan module back to the original place

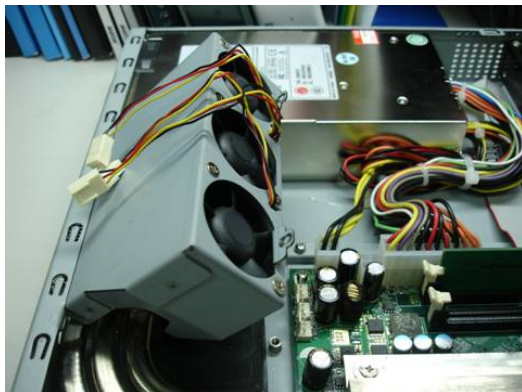

Step 14: Fasten the two screws of the fan module and plug in the power cable



Step 15: Insert the Power cable of Fan Module



Step 16: Insert 12V Power Cable

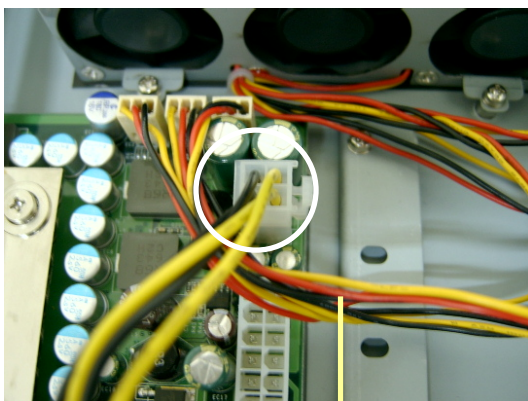

Power cables of FAN Module are under the 12V Power Cable

Step 17: Collect the power cable of Fan Module under the bracket for storage

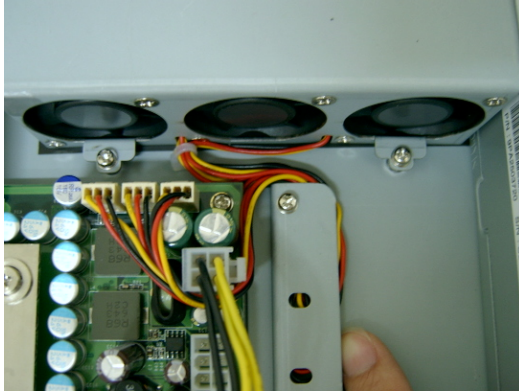

Note: Please pull the power cable tightly and keep it off the FAN

Step 18: Insert the white tape into the bracket to fix the power cable of Fan Module

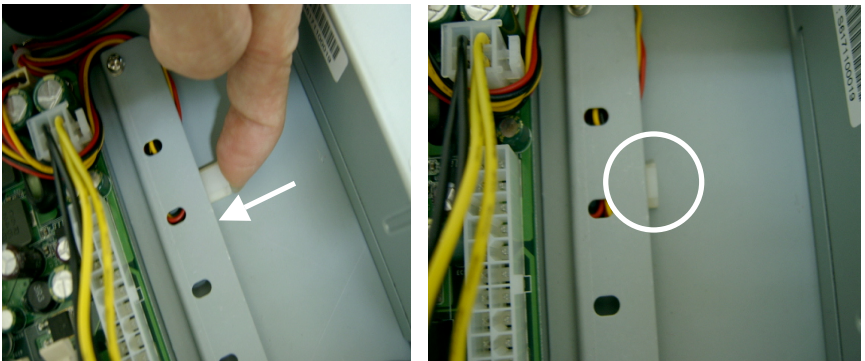

2.24 Installing the Hard Disk Drive

Step 1: Loosen the four screws

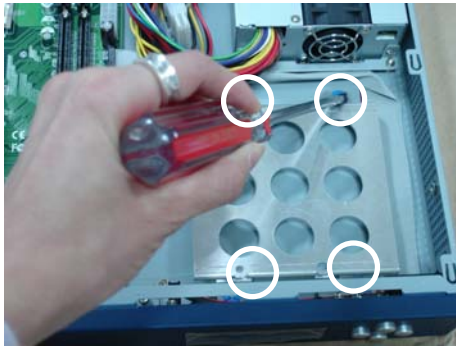

Step 2: Lift up the Hard Disk Drive Bracket aside

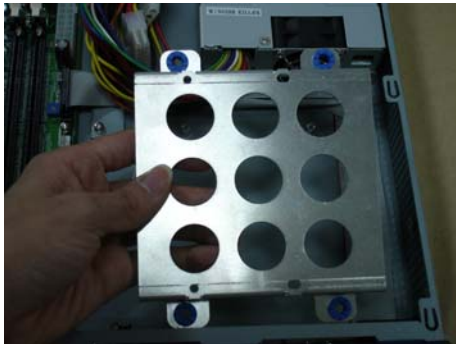

Step 3: Fasten the Hard Disk Drive Bracket with the back side of Hard Disk Drive by using the four screws

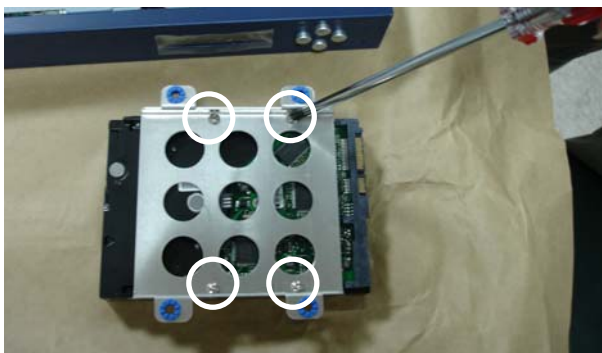

Step 4: Overturn the Hard Disk Drive and put it into the chassis



Step 5: Fasten the four screws of the Hard Disk Drive Bracket



2.25 Installing the Add-on Card

FWS-816B supports three types of add-on cards: PCI, PCI-X and PCI-Express, and not intended to use for any TELECOMMUNICATION NETWORK device. (Such as modem card.)

Step 1: Slide the cover of the PCI/ PCI-X/ PCI-E [x1] Expansion Slot horizontally and remove the cover backward



PCI/ PCI-X/
PCI-E [x1]
expansion slot
with cover

Step 2: Insert PCI card bracket to the cover bottom of the PCI/ PCI-X/ PCI-E [x1] Expansion Slot

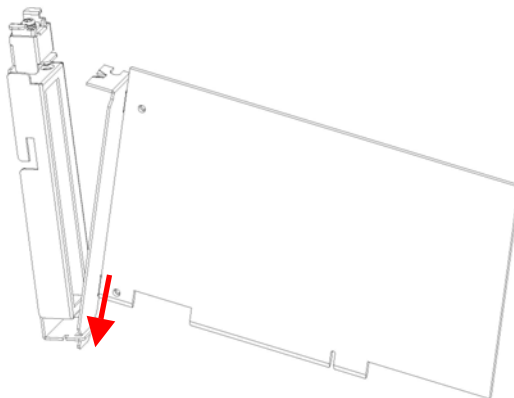

Step 3: Pull up the drawstring of the cover and hold

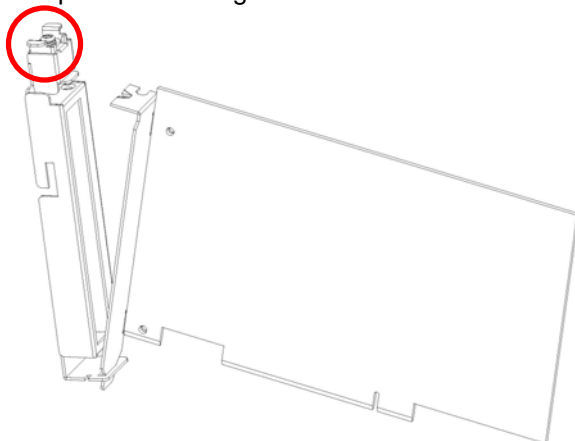

Step 4: Connect the top of the Bracket to the cover and release the drawstring

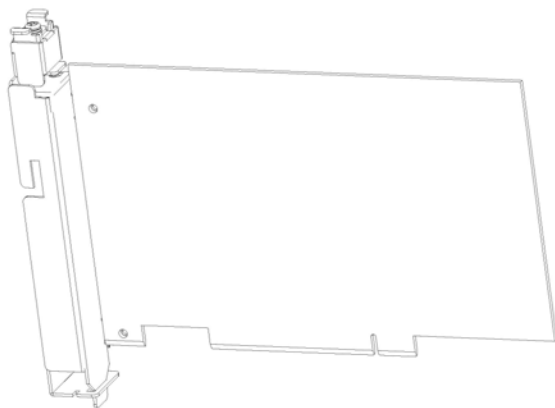

Note: There is an indentation on the bracket and you will see a hole on the cover when you pull up the drawstring. Please make sure the indentation has been placed to the hole on the cover and then release the drawstring to lock the card firmly.

Step 5: Insert the Add-on card to the FWS-816B

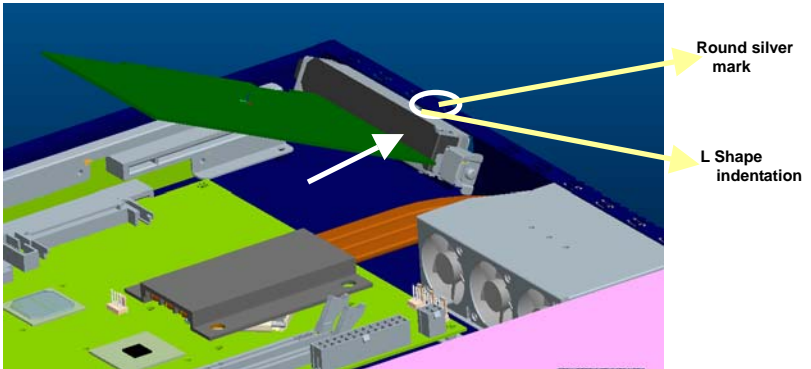

Note: There is a *round silver mark* on the top of the front panel. Please make sure the *L shape indentation* on the cover has been aimed at the mark when you insert the card to the FWS-816B.

Step 6: When the Add-on Card has been inserted to the expansion slot properly, slide it horizontally to the opposite direction mentioned in [Step 1](#) and you have finished the Add-on Card Installation

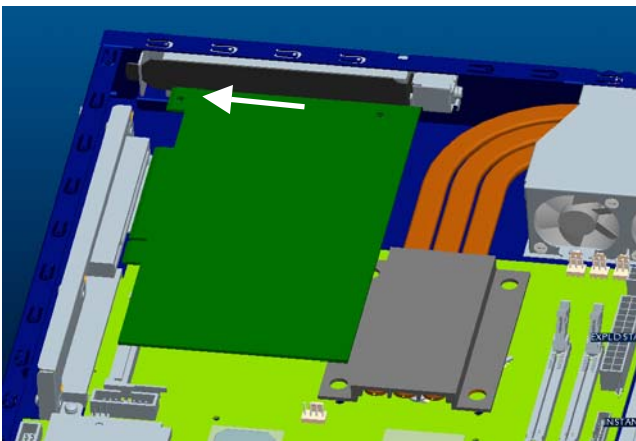

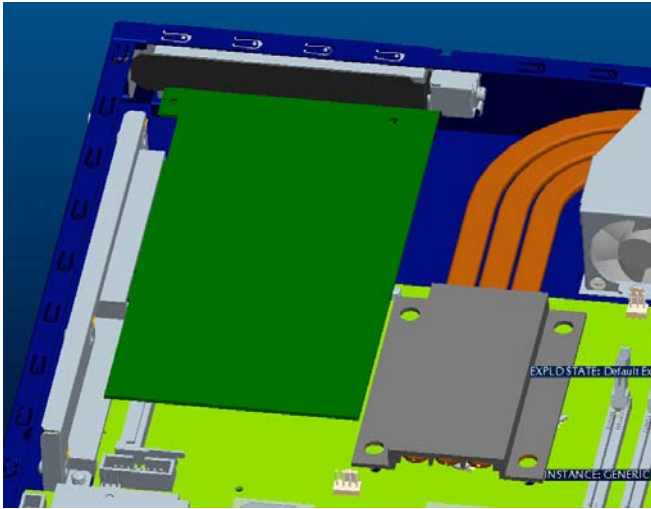

Below Table for China RoHS Requirements

产品中有毒有害物质或元素名称及含量

AAEON Boxer/ Industrial System

| 部件名称 | 有毒有害物质或元素 | | | | | |
|---|-----------|-----------|-----------|-----------------|---------------|-----------------|
| | 铅 (Pb) | 汞 (Hg) | 镉 (Cd) | 六价铬 (Cr(VI)) | 多溴联苯 (PBB) | 多溴二苯醚 (PBDE) |
| 印刷电路板 及其电子组件 | × | ○ | ○ | ○ | ○ | ○ |
| 外部信号 连接器及线材 | × | ○ | ○ | ○ | ○ | ○ |
| 外壳 | × | ○ | ○ | ○ | ○ | ○ |
| 中央处理器 与内存 | × | ○ | ○ | ○ | ○ | ○ |
| 硬盘 | × | ○ | ○ | ○ | ○ | ○ |
| 电源 | × | ○ | ○ | ○ | ○ | ○ |
| | | | | | | |
| | | | | | | |
| | | | | | | |
| | | | | | | |
| <p>O: 表示该有毒有害物质在该部件所有均质材料中的含量均在 SJ/T 11363-2006 标准规定的限量要求以下。</p> <p>X: 表示该有毒有害物质至少在该部件的某一均质材料中的含量超出 SJ/T 11363-2006 标准规定的限量要求。</p> <p>备注: 一、此产品所标示之环保使用期限, 系指在一般正常使用状况下。 二、上述部件物质中央处理器、内存、硬盘、电源为选购品。</p> | | | | | | |

Chapter

3

**Award
BIOS Setup**

3.1 System Test and Initialization

These routines test and initialize board hardware. If the routines encounter an error during the tests, you will either hear a few short beeps or see an error message on the screen. There are two kinds of errors: fatal and non-fatal. The system can usually continue the boot up sequence with non-fatal errors. Non-fatal error messages usually appear on the screen along with the following instructions:

Press <F1> to RESUME

Write down the message and press the F1 key to continue the boot up sequence.

System configuration verification

These routines check the current system configuration against the values stored in the CMOS memory. If they do not match, the program outputs an error message. You will then need to run the BIOS setup program to set the configuration information in memory.

There are three situations in which you will need to change the CMOS settings:

1. You are starting your system for the first time
2. You have changed the hardware attached to your system
3. The CMOS memory has lost power and the configuration information has been erased.

The FWS-816 Rev.B CMOS memory has an integral lithium battery backup for data retention. However, you will need to replace the complete unit when it finally runs down.

3.2 Award BIOS Setup

Awards BIOS ROM has a built-in Setup program that allows users to modify the basic system configuration. This type of information is stored in battery-backed CMOS RAM so that it retains the Setup information when the power is turned off.

Entering Setup

Power on the computer and press immediately. This will allow you to enter Setup.



Standard CMOS Features

Use this menu for basic system configuration. (Date, time, IDE, etc.)

Advanced BIOS Features

Use this menu to set the advanced features available on your system.

Advanced Chipset Features

Use this menu to change the values in the chipset registers and optimize your system performance.

Integrated Peripherals

Use this menu to specify your settings for integrated peripherals. (Primary slave, secondary slave, keyboard, mouse etc.)

Power Management Setup

Use this menu to specify your settings for power management. (HDD power down, power on by ring, KB wake up, etc.)

PnP/PCI Configurations

This entry appears if your system supports PnP/PCI.

PC Health Status

This menu allows you to set the shutdown temperature for your system.

Frequency/Voltage Control

Use this menu to specify your settings for auto detect DIMM/PCI clock and spread spectrum.

Load Fail-Safe Defaults

Use this menu to load the BIOS default values for the minimal/stable performance for your system to operate.

Load Optimized Defaults

Use this menu to load the BIOS default values that are factory settings for optimal performance system operations. While AWARD has designated the custom BIOS to maximize performance, the factory has the right to change these defaults to meet their needs.

Set Supervisor/User Password

Use this menu to set Supervisor/User Passwords.

Save and Exit Setup

Save CMOS value changes to CMOS and exit setup.

Exit Without Saving

Abandon all CMOS value changes and exit setup.

You can refer to the "AAEON BIOS Item Description.pdf" file in the CD for the meaning of each setting in this chapter.

Chapter

4

**Driver
Installation**

The FWS-816 Rev.B comes with an AutoRun CD-ROM that contains all drivers and utilities that can help you to install the driver automatically.

Insert the driver CD, the driver CD-title will auto start and show the installation guide. If not, please follow the sequence below to install the drivers.

Follow the sequence below to install the drivers:

Step 1 – Install INF Driver

Step 2 – Install VGA Driver

Step 3 – Install LAN Driver

USB 2.0 Drivers are available for download using Windows[®] Update for both Windows[®] XP and Windows[®] 2000. For additional information regarding USB 2.0 support in Windows[®] XP and Windows[®] 2000, please visit www.microsoft.com/hwdev/usb/.

Please read instructions below for further detailed installations.

4.1 Installation:

Insert the FWS-816 Rev.B CD-ROM into the CD-ROM drive and install the drivers from Step 1 to Step 3 in order.

Step 1 – Install INF Driver

1. Click on the **Step 1-INF** folder and select the OS you system is
2. Double click on the *.**exe** file located in each OS folder
3. Follow the instructions that the window shows
4. The system will help you install the driver automatically

Step 2 – Install VGA Driver

1. Click on the **Step 2 –VGA** folder
2. If the VGA supports 64-bit, please click on **Winxp64** folder; If the VGA is general one, please click on **Win2k_xp** folder
3. Double click on **Setup**
4. Follow the instructions that the window shows
5. The system will help you install the driver automatically

Step 3 – Install LAN Driver

There are two LAN Drivers that have to be installed. You need to install the **Intel 82573 LAN Driver** by autorun program first and then install the **Intel 82551ER Driver** manually.

Install the Intel 82573 LAN Driver

1. Click on the **Step 3 –LAN** folder and click on the folder of **Intel 82573 Driver**
2. Double click on **Autorun**
3. Follow the instructions that the window shows
4. The system will help you install the driver automatically

Install the Intel 82551ER Driver

1. Click on **Start** button
2. Click on **Settings** button
3. Click on **Control Panel** button
4. Click on **System** button
5. Select **Hardware** and click on **Device Manager...**
6. Double click on **Ethernet Controller**
7. Click on **Update Driver...**
8. Click on **Next**
9. Select **Search for a suitable driver...**, then click on **Next**.
10. Select **Specify a location**, then click on **Next**
11. Click on **Browse**
12. Select "Net559ER.INF" file from CD-ROM (**Step3 – LAN/Intel 82551ER Driver**) then click on **Open**
13. Click on **OK**
14. Click on **Next**
15. Click on **Yes**
16. Click on **Finish**

Appendix

A

Programming the Watchdog Timer

A.1 Programming

FWS-816 Rev.B utilizes W83627EHG chipset as its watchdog timer controller.

Below are the procedures to complete its configuration and the AAEON initial watchdog timer program is also attached based on which you can develop customized program to fit your application.

Configuring Sequence Description

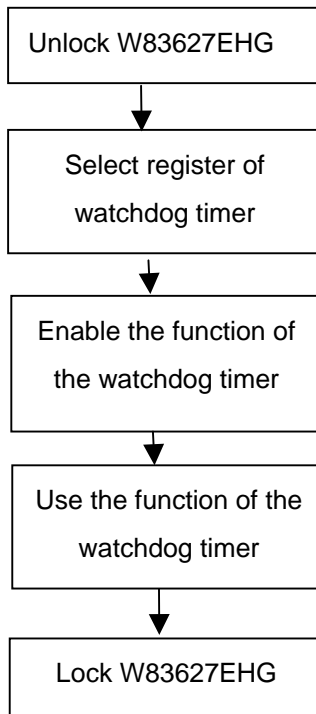

There are three steps to complete the configuration setup:

- (1) Enter the W83627EHG config Mode

- (2) Modify the data of configuration registers
- (3) Exit the W83627EHG config Mode. Undesired result may occur if the config Mode is not exited normally.

(1) Enter the W83627EHG config Mode

To enter the W83627EHG config Mode, two special I/O write operations are to be performed during Wait for Key state. To ensure the initial state of the key-check logic, it is necessary to perform two write operations to the Special Address port (2EH). The different enter keys are provided to select configuration ports (2Eh/2Fh) of the next step.

| | Address Port | Data Port |
|----------|--------------|-----------|
| 87h,87h: | 2Eh | 2Fh |

(2) Modify the Data of the Registers

All configuration registers can be accessed after entering the config Mode. Before accessing a selected register, the content of Index 07h must be changed to the LDN to which the register belongs, except some Global registers.

(3) Exit the W83627EHG config Mode

The exit key is provided to select configuration ports (2Eh/2Fh) of the next step.

| | Address Port | Data Port |
|-------|--------------|-----------|
| 0aah: | 2Eh | 2Fh |

WatchDog Timer Register I (Index=F5h, Default=00h)

CRF5 (PLED mode register. Default 0 x 00)

Bit 7-6 : select PLED mode

= 00 Power LED pin is tri-stated.

- = 01 Power LED pin is driven low.
- = 10 Power LED pin is a 1Hz toggle pulse with 50 duty cycle.
- = 11 Power LED pin is a 1/4Hz toggle pulse with 50 duty cycle.

Bit 5-4 : Reserved

Bit 3 : select WDTO count mode.

= 0 second

= 1 minute

Bit 2 : Enable the rising edge of keyboard Reset (P20) to force Time-out event.

= 0 Disable

= 1 Enable

Bit 1-0 : Reserved

WatchDog Timer Register II (Index=F6h, Default=00h)

- Bit 7-0** = 0 x 00 Time-out Disable
- = 0 x 01 Time-out occurs after 1 second/minute
- = 0 x 02 Time-out occurs after 2 second/minutes
- = 0 x 03 Time-out occurs after 3 second/minutes
-
- = 0 x FF Time-out occurs after 255

second/minutes

WatchDog Timer Register III (Index=F7h, Default=00h)

- Bit 7** : Mouse interrupt reset Enable or Disable
= 1 Watchdog Timer is reset upon a Mouse interrupt
= 0 Watchdog Timer is not affected by Mouse interrupt
- Bit 6** : Keyboard interrupt reset Enable or Disable
= 1 Watchdog Timer is reset upon a Keyboard interrupt
= 0 Watchdog Timer is not affected by Keyboard interrupt
- Bit 5** : Force Watchdog Timer Time-out. Write Only
= 1 Force Watchdog Timer time-out event: this bit is self-clearing
- Bit 4** : Watchdog Timer Status. R/W
= 1 Watchdog Timer time-out occurred
= 0 Watchdog Timer counting
- Bit 3-0** : These bits select IRQ resource for Watchdog. Setting of 2 selects SMI.

A.2 W83627EHG Watchdog Timer Initial Program

Example: Setting 10 sec. as Watchdog timeout interval

;;

Mov dx,2eh ;Enter W83627EHG config mode

Mov al,87h (out 87h to 2eh twice)

Out dx,al

Out dx,al

;;

Mov al,07h

Out dx,al

Inc dx

Mov al,08h ;Select Logical Device 8 (GPIO Port
2)

Out dx,al

;;

Dec dx

Mov al,30h ;CR30 (GP20~GP27)

Out dx,al

Inc dx

Mov al,01h ;Activate GPIO2

Out dx,al

```
;/;;;;;;;;;;;;;;;;;;;;;;;;;;;;;;;;;;;;;;;;;;;;;;;;;;;;;;;;;;;;;;;;;;;;;;;;;;;;;;;;;;;;;;;;;;;;;;;;;;;;;;;;;;;;;;;;;;;;;;;;;;;;;;;;
```

```
Dec dx
```

```
Mov al,0f5h ;CRF5 (PLED mode register)
```

```
Out dx,al
```

```
Inc dx
```

```
In al,dx
```

```
And al,not 08h ;Set second as counting unit
```

```
Out dx,al
```

```
;/;;;;;;;;;;;;;;;;;;;;;;;;;;;;;;;;;;;;;;;;;;;;;;;;;;;;;;;;;;;;;;;;;;;;;;;;;;;;;;;;;;;;;;;;;;;;;;;;;;;;;;;;;;;;;;;;;;;;;;;;;;;;;;;;
```

```
Dec dx
```

```
Mov al,0f6h ; CRF6
```

```
Out dx,al
```

```
Inc dx
```

```
Mov al,10 ;Set timeout interval as 10 sec.
```

```
Out dx,al
```

```
;/;;;;;;;;;;;;;;;;;;;;;;;;;;;;;;;;;;;;;;;;;;;;;;;;;;;;;;;;;;;;;;;;;;;;;;;;;;;;;;;;;;;;;;;;;;;;;;;;;;;;;;;;;;;;;;;;;;;;;;;;;;;;;;;;
```

```
Dec dx ;Exit W83627EHG config mode
```

```
Mov al,0aah (out 0aah to 2eh once)
```

```
Out dx,al
```

```
;/;;;;;;;;;;;;;;;;;;;;;;;;;;;;;;;;;;;;;;;;;;;;;;;;;;;;;;;;;;;;;;;;;;;;;;;;;;;;;;;;;;;;;;;;;;;;;;;;;;;;;;;;;;;;;;;;;;;;;;;;;;;;;;;;
```

Appendix







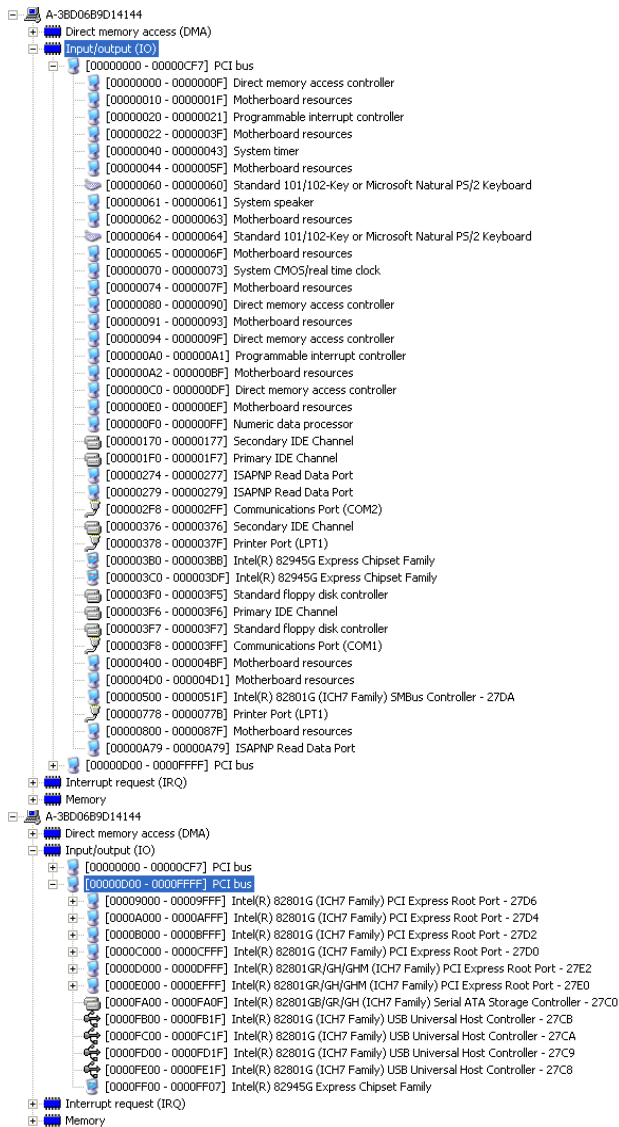















B

I/O Information

B.1 I/O Address Map



B.2 Memory Address Map

- [-]  A-3BD06B9D14144
 - [+]  Direct memory access (DMA)
 - [+]  **Input/output (IO)**
 - [+]  Interrupt request (IRQ)
 - [-]  Memory
 - [+]  [00000000 - 0009FFFF] System board
 - [+]  [000A0000 - 000BFFFF] PCI bus
 - [+]  [000C0000 - 000DFFFF] PCI bus
 - [+]  [000E0000 - 000EFFFF] System board
 - [+]  [000F0000 - 000F3FFF] System board
 - [+]  [000F4000 - 000F7FFF] System board
 - [+]  [000F8000 - 000FBFFF] System board
 - [+]  [000FC000 - 000FFFFF] System board
 - [+]  [00100000 - 1F6DFFFF] System board
 - [+]  [1F6E0000 - 1F6FFFFFF] System board
 - [+]  [1F700000 - FEBFFFFFF] PCI bus
 - [+]  [FEC00000 - FEC00FFF] System board
 - [+]  [FED13000 - FED1DFFF] System board
 - [+]  [FED20000 - FED8FFFF] System board
 - [+]  [FEE00000 - FEE00FFF] System board
 - [+]  [FFB00000 - FFB7FFFF] System board
 - [+]  [FFB80000 - FFBFFFFFF] Intel(R) 82802 Firmware Hub Device
 - [+]  [FFF00000 - FFFFFFFF] System board

B.3 IRQ Mapping Chart

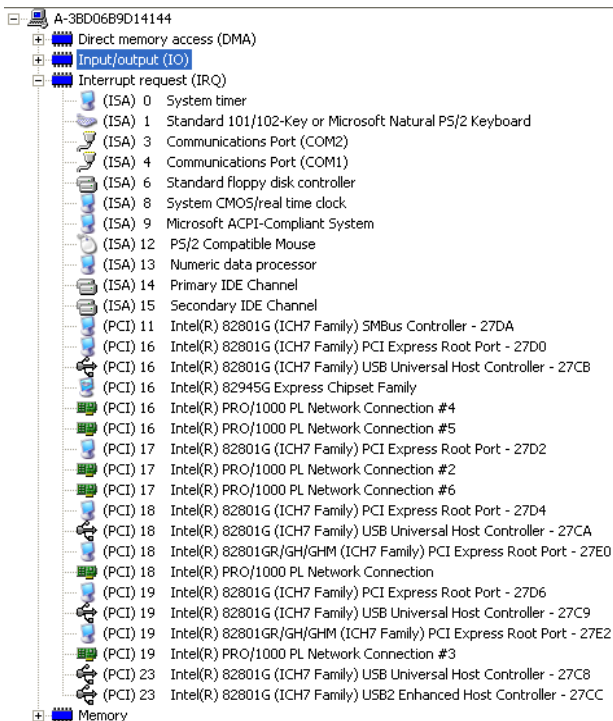

B.4 DMA Channel Assignments



Appendix

C

Standard Firewall Platform Setting

C.1 Standard Firewall Platform Setting

| | | |
|----------------|-----------------|---|
| Status LED | Disable | I/O PORT 48Fh set bit 4 to 1, I/O PORT 4B8h set bit 3 to 1 |
| | Red LED ON | I/O PORT 48Fh set bit 4 to 1, I/O PORT 4B8h set bit 3 to 0 |
| | Red LED Blink | I/O PORT 48Fh set bit 4 to 1, I/O PORT 4B8h set bit 3 to 0 I/O PORT 49Bh set bit 4 to 1 |
| | Green LED ON | I/O PORT 48Fh set bit 4 to 0, I/O PORT 4B8h set bit 3 to 1 |
| | Green LED Blink | I/O PORT 48Fh set bit 4 to 0, I/O PORT 4B8h set bit 3 to 1 I/O PORT 49Bh set bit 4 to 1 |
| LAN Bypass | Disable | I/O PORT 48Dh set bit 7 to 1, I/O PORT 48Fh set bit 2 to 0 |
| | Force Mode | I/O PORT 48Dh set bit 7 to 0, I/O PORT 48Fh set bit 2 to 0 |
| | Watch Dog Mode | I/O PORT 48Dh set bit 7 to 1, I/O PORT 48Fh set bit 2 to 1 |
| LCM Function | Disable | |
| | 378/IRQ7 | |
| Software Reset | | Press Software Reset button I/O PORT: 4B8h bit 6 will be set 1 |

C.2 Status LED Sample Code

Status LED Sample code

[Disabled LED Function]

```
mov dx,48Fh          ;( IO_PORT = 48Fh)
in  al,dx
or  al,00010000b ;set bit 4 -->high
out dx,al
```

```
mov dx,4B8h          ;( IO_PORT = 4B8h)
in  al,dx
or  al,00001000b ;set bit 3 -->high
out dx,al
```

[RED LED ON]

```
mov dx,48Fh          ;( IO_PORT = 48Fh)
in  al,dx
or  al,00010000b ;set bit 4 -->high
out dx,al
```

```
mov dx,4B8h          ;( IO_PORT = 4B8h)
in  al,dx
and al,11110111b ;set bit 3 -->LOW
```

```
out dx,al
```

[RED LED BLINK]

```
mov dx,48Fh          ;( IO_PORT = 48Fh)
```

```
in al,dx
```

```
or al,00010000b ;set bit 4 -->high
```

```
out dx,al
```

```
mov dx,4B8h          ;( IO_PORT = 4B8h)
```

```
in al,dx
```

```
and al,11110111b ;set bit 3 -->low
```

```
out dx,al
```

```
mov dx,49Bh          ;( IO_PORT = 49Bh)
```

```
in al,dx
```

```
or al,00010000b ;set bit 4 -->high(control blink)
```

```
out dx,al
```

[GREEN LED ON]

```
mov dx,48Fh          ;( IO_PORT = 48Fh)
```

```
in al,dx
```

```
and al,11101111b ;set bit 4 -->low
```

```
out dx,al
```

```
mov dx,4B8h          ;( IO_PORT = 4B8h)
```

```
in  al,dx
or  al,00001000b ;set bit 3 -->high
out dx,al
```

[GRN LED BLINK]

```
mov dx,48Fh          ;( IO_PORT = 48Fh)
in  al,dx
and al,11101111b ;set bit 4 -->low
out dx,al
```

```
mov dx,4B8h          ;( IO_PORT = 4B8h)
in  al,dx
or  al,00001000b ;set bit 3 -->high
out dx,al
```

```
mov dx,49Bh          ;( IO_PORT = 49Bh)
in  al,dx
or  al,00010000b ;set bit 4 -->high(control blink)
out dx,al
```

C.3 LAN Bypass Mode Sample Code

LAN BYPASS MODE Sample code

[Disable Function]

```
mov dx,48dh          ;( IO_PORT = 48dh)
in  al,dx
or  al,01000000b ;set bit 7-->high
out dx,al
```

```
mov dx,48Fh         ;( IO_PORT = 48Fh)
in  al,dx
and al,11111011b ;set bit 2-->low
out dx,al
```

[Force Mode]

```
mov dx,48dh          ;( IO_PORT = 48dh)
in  al,dx
and al,10111111b ;set bit 7-->low
out dx,al
```

```
mov dx,48Fh         ;( IO_PORT = 48Fh)
in  al,dx
and al,11111011b ;set bit 2-->low
out dx,al
```

[Watch Dog Mode]

```
mov dx,48dh                ;( IO_PORT = 48dh)
```

```
in  al,dx
```

```
or  al,01000000b ;set bit 7-->high
```

```
out dx,al
```

```
mov dx,48Fh                ;( IO_PORT = 48Fh)
```

```
in  al,dx
```

```
or  al,00000100b ;set bit 2-->high
```

```
out dx,al
```

C.4 LCM Sample Code

```
void Display_Clear()
{
    outportb(0x378, 0x01);
    wait();
    outportb(0x37A, 0xC8);
    wait();
    outportb(0x37A, 0xCA);
    wait();
}

void Return_Home()
{
    outportb(0x378, 0x02);
    wait();
    outportb(0x37A, 0xC8);
    wait();
    outportb(0x37A, 0xCA);
    wait();
}
```



```
}
```

```
void Entry_mode_set()
```

```
{
```

```
    outportb(0x378, 0x06);
```

```
    wait();
```

```
    outportb(0x37A, 0xC8);
```

```
    wait();
```

```
    outportb(0x37A, 0xCA);
```

```
    wait();
```

```
}
```

```
void Display_Off()
```

```
{
```

```
    outportb(0x378, 0x08);
```

```
    wait();
```

```
    outportb(0x37A, 0xC8);
```

```
    wait();
```

```
    outportb(0x37A, 0xCA);
```

```
        wait();
    }

void Display_On_Cursor_Off()
{
    outportb(0x378, 0x0C);
    wait();
    outportb(0x37A, 0xC8);
    wait();
    outportb(0x37A, 0xCA);
    wait();
}

void Display_On_Cursor_On()
{
    outportb(0x378, 0x0E);
    wait();
    outportb(0x37A, 0xC8);
    wait();
}
```

```
        outputb(0x37A, 0xCA);

        wait();

    }

/*****
***/

// Set the interface data length.

// Number of display line and character font.

// For 5x7 dots and 2 lines display now.

/*****
***/

void Function_Set()

{

    outputb(0x378, 0x38);

    wait();

    outputb(0x37A, 0xC8);

    wait();

    outputb(0x37A, 0xCA);
```

```
    wait();  
}
```

```
void Write_Char( char x )  
{  
    outportb(0x378, x);  
    outportb(0x37A, 0xC0);  
    wait();  
    outportb(0x37A, 0xC2);  
    wait();  
}
```

```
void Change_Line()  
{  
    outportb(0x378, 0xC0);  
    wait();  
    outportb(0x37A, 0xC8);  
    wait();  
    outportb(0x37A, 0xCA);
```

```
        wait();
    }

void wait()
{
    for (int i = 0 ; i < 0x10 ; i++)
    {
        for (int j = 0 ; j < 0x80 ; j++)
        {
            outportb(0x0EB, 0Xff);
        }
    }
}
```

C.5 Console Redirection

Console redirection allows you to maintain a system from a remote location by re-directing keyboard input and text output through the serial port. This section will tell you how to use the console redirection.

1. Please insert console cable between on FWS-816 Rev.B and remote client system.

2. Setup BIOS in FWS-816 Rev.B.

BIOS >> advanced BIOS features >> Baud Rate:
19200(Default)

BIOS >> advanced BIOS features >> Console Redirection:
Enable (Default)

| | |
|----------|--|
| Enabled | Attempt to redirect console via COM port |
| Disabled | Console redirection function disabled |

3. Configure Console redirection on client system. This example is for Windows platform.

Step1 - Click the Start button, point to programs >> Accessories >> Communication, and click Hyper Terminal

Step2 - Enter any name for the new connection and select any icon

Step3 - Click OK

Step4 - From the connect to pull-down menu, select a COM port available on your client system and click OK

Step5 - Select Baud Rate >> 19200, Flow control >> None, Data bit >>8, Parity cheek >> None, Stop bit>>1

4. Power on FWS-816 Rev.B and it will display the BIOS information on the client system.