

FWS-7541

1U Rackmount Network Appliance

User's Manual 2nd Ed

Copyright Notice

This document is copyrighted, 2022. All rights are reserved. The original manufacturer reserves the right to make improvements to the products described in this manual at any time without notice.

No part of this manual may be reproduced, copied, translated, or transmitted in any form or by any means without the prior written permission of the original manufacturer. Information provided in this manual is intended to be accurate and reliable. However, the original manufacturer assumes no responsibility for its use, or for any infringements upon the rights of third parties that may result from its use.

The material in this document is for product information only and is subject to change without notice. While reasonable efforts have been made in the preparation of this document to assure its accuracy, AAEMON assumes no liabilities resulting from errors or omissions in this document, or from the use of the information contained herein.

AAEMON reserves the right to make changes in the product design without notice to its users.

Acknowledgement

All other products' name or trademarks are properties of their respective owners.

- Microsoft Windows is a registered trademark of Microsoft Corp.
- Intel, Pentium, Celeron, and Xeon are registered trademarks of Intel Corporation
- Core, Atom are trademarks of Intel Corporation
- ITE is a trademark of Integrated Technology Express, Inc.
- IBM, PC/AT, PS/2, and VGA are trademarks of International Business Machines Corporation.
- CentOS is a trademark of Red Hat, Inc.

All other product names or trademarks are properties of their respective owners.

Packing List

Before setting up your product, please make sure the following items have been shipped:

Item	Quantity
● FWS-7541	1
● Console cable	1
● Ear bracket (pair)	1
● SATA cable	2
● SATA power cable	2
● HDD kit	2

If any of these items are missing or damaged, please contact your distributor or sales representative immediately.

About this Document

This User's Manual contains all the essential information, such as detailed descriptions and explanations on the product's hardware and software features (if any), its specifications, dimensions, jumper/connector settings/definitions, and driver installation instructions (if any), to facilitate users in setting up their product.

Users may refer to the AAEON.com for the latest version of this document.

Safety Precautions

Please read the following safety instructions carefully. It is advised that you keep this manual for future references

1. All cautions and warnings on the device should be noted.
2. All cables and adapters supplied by AAEON are certified and in accordance with the material safety laws and regulations of the country of sale. Do not use any cables or adapters not supplied by AAEON to prevent system malfunction or fires.
3. Make sure the power source matches the power rating of the device.
4. Position the power cord so that people cannot step on it. Do not place anything over the power cord.
5. Always completely disconnect the power before working on the system's hardware.
6. No connections should be made when the system is powered as a sudden rush of power may damage sensitive electronic components.
7. If the device is not to be used for a long time, disconnect it from the power supply to avoid damage by transient over-voltage.
8. Always disconnect this device from any AC supply before cleaning.
9. While cleaning, use a damp cloth instead of liquid or spray detergents.
10. Make sure the device is installed near a power outlet and is easily accessible.
11. Keep this device away from humidity.
12. Place the device on a solid surface during installation to prevent falls
13. Do not cover the openings on the device to ensure optimal heat dissipation.
14. Watch out for high temperatures when the system is running.
15. Do not touch the heat sink or heat spreader when the system is running
16. Never pour any liquid into the openings. This could cause fire or electric shock.

17. As most electronic components are sensitive to static electrical charge, be sure to ground yourself to prevent static charge when installing the internal components. Use a grounding wrist strap and contain all electronic components in any static-shielded containers.
18. If any of the following situations arises, please the contact our service personnel:
 - i. Damaged power cord or plug
 - ii. Liquid intrusion to the device
 - iii. Exposure to moisture
 - iv. Device is not working as expected or in a manner as described in this manual
 - v. The device is dropped or damaged
 - vi. Any obvious signs of damage displayed on the device
19. **DO NOT LEAVE THIS DEVICE IN AN UNCONTROLLED ENVIRONMENT WITH TEMPERATURES BEYOND THE DEVICE'S PERMITTED STORAGE TEMPERATURES (SEE CHAPTER 1) TO PREVENT DAMAGE.**

Warning!



This device complies with Part 15 FCC Rules. Operation is subject to the following two conditions: (1) this device may not cause harmful interference, and (2) this device must accept any interference received including interference that may cause undesired operation.

Caution:

There is a danger of explosion if the battery is incorrectly replaced. Replace only with the same or equivalent type recommended by the manufacturer. Dispose of used batteries according to the manufacturer's instructions and your local government's recycling or disposal directives.

Attention:

Il y a un risque d'explosion si la batterie est remplacée de façon incorrecte. Ne la remplacer qu'avec le même modèle ou équivalent recommandé par le constructeur. Recycler les batteries usées en accord avec les instructions du fabricant et les directives gouvernementales de recyclage.

China RoHS Requirements (CN)

产品中有毒有害物质或元素名称及含量

AAEON Embedded Box PC/ Industrial System

部件名称	有毒有害物质或元素					
	铅 (Pb)	汞 (Hg)	镉 (Cd)	六价铬 (Cr(VI))	多溴联苯 (PBB)	多溴二苯醚 (PBDE)
印刷电路板 及其电子组件	○	○	○	○	○	○
外部信号 连接器及线材	○	○	○	○	○	○
外壳	○	○	○	○	○	○
中央处理器 与内存	○	○	○	○	○	○
硬盘	○	○	○	○	○	○
电源	○	○	○	○	○	○
<p>O: 表示该有毒有害物质在该部件所有均质材料中的含量均在 SJ/T 11363-2006 标准规定的限量要求以下。</p> <p>X: 表示该有毒有害物质至少在该部件的某一均质材料中的含量超出 SJ/T 11363-2006 标准规定的限量要求。</p> <p>备注:</p> <p>一、此产品所标示之环保使用期限，系指在一般正常使用状况下。</p> <p>二、上述部件物质中央处理器、内存、硬盘、光驱、触控模块为选购品。</p>						

China RoHS Requirement (EN)

Poisonous or Hazardous Substances or Elements in Products
 AAEON Embedded Box PC/ Industrial System

Component	Poisonous or Hazardous Substances or Elements					
	Lead (Pb)	Mercury (Hg)	Cadmium (Cd)	Hexavalent Chromium (Cr(VI))	Polybrominated Biphenyls (PBB)	Polybrominated Diphenyl Ethers (PBDE)
PCB & Other Components	○	○	○	○	○	○
Wires & Connectors for External Connections	○	○	○	○	○	○
Chassis	○	○	○	○	○	○
CPU & RAM	○	○	○	○	○	○
Hard Disk	○	○	○	○	○	○
PSU	○	○	○	○	○	○

O: The quantity of poisonous or hazardous substances or elements found in each of the component's parts is below the SJ/T 11363-2006-stipulated requirement.

X: The quantity of poisonous or hazardous substances or elements found in at least one of the component's parts is beyond the SJ/T 11363-2006-stipulated requirement.

Note: The Environment Friendly Use Period as labeled on this product is applicable under normal usage only

Table of Contents

Chapter 1 – Product Specifications	1
1.1 Specifications	2
Chapter 2 – Hardware Information	5
2.1 Dimensions	6
2.2 Jumpers and Connectors.....	10
2.3 List of Jumpers	11
2.3.1 Clear CMOS (CN5)	11
2.4 List of Connectors.....	11
2.4.1 Battery Holder (CN4).....	12
2.4.2 Digital IO Pin Header (CN10).....	13
2.4.3 Front Panel Header (FP1).....	13
2.4.4 Case Open Holder (CN11)	13
2.4.5 M.2 B-Key Slot (CN20)	14
2.4.6 M.2 E-Key Slot (CN22)	15
2.4.7 Serial Port (CN24)	17
2.5 Hardware Installation	18
2.5.1 Hard Disk Drive (HDD) Installation.....	18
2.5.2 Heat Sink Installation	22
2.5.3 NIM Installation.....	25
Chapter 3 - AMI BIOS Setup	27
3.1 System Test and Initialization	28
3.2 AMI BIOS Setup	29
3.3 Setup Submenu: Main.....	30
3.4 Setup Submenu: Advanced.....	31
3.4.1 Trusted Computing.....	32
3.4.2 Hardware Monitor.....	34

3.4.3	System FAN Setting	35
3.4.4	SIO Configuration	37
3.4.5	Serial Port 0 Configuration.....	38
3.4.6	Serial Port 1 Configuration	39
3.4.7	Parallel Port Configuration.....	40
3.4.8	Serial Port Console Redirection.....	41
3.4.9	Console Redirection Settings.....	42
3.4.10	Legacy Console Redirection Settings	44
3.4.11	Power Management	45
3.4.12	Digital IO Port Configuration.....	46
3.4.13	LAN Bypass Configuration.....	47
3.4.14	Case Open Configuration	48
3.5	Setup Submenu: Platform Configuration	49
3.5.1	PCH-IO Configuration	50
3.5.2	SATA Configuration.....	51
3.5.3	Controller 3 SATA Configuration	52
3.5.4	General ME Configuration	53
3.5.5	Socket Configuration.....	54
3.5.6	Processor Configuration	55
3.5.7	Memory Configuration	56
3.5.8	Memory Topology	57
3.5.9	IIO Configuration	58
3.5.10	Socket0 Configuration	59
3.5.11	Advanced Power Management Configuration	60
3.5.12	Hardware PM State Control.....	61
3.6	Setup Submenu: Security.....	62
3.6.1	Secure Boot	63
3.6.1.1	Key Management	64

3.7	Setup Submenu: Boot	66
3.8	Setup Submenu: Save & Exit.....	67

Chapter 1

Product Specifications

1.1 Specifications

System

Form Factor	1U Rackmount ICE-Lake-D LCC Platform Network Appliance
Processor	Intel® Xeon® ICE-Lake-D LCC Processors
Chipset	SoC
System Memory	Up to DDR4 SO-DIMM ECC DIMM Slots x 2

Network

Ethernet	1Gb RJ45 (I350 AM4 x 3) x 12 + up to 4 x 10Gb SFP + (SKU optional)
Bypass	2 Pairs LAN Bypass 3.1
NIM Slot	NIM Slot x 1 (Optional)

Display

Graphic Controller	-
Connector	VGA from IPMI x 1 (Optional by BOM SKU)

Storage

HDDs	2.5" HDD x 2 (default) or 3.5" HDD x 1 (If no NIM module present)
CF/CFast/mSATA	-

Internal/Expansion Interface

PCIe Slot	-
Mini-Card slot	M.2 (B-Key 3052) for 4G/5G (USB 3.0 + PCIe) x 1 with SIM M.2 (E-Key 2230) (PCIe) x 1
IPMI	Optional by BOM SKU
Keyboard and Mouse	-
USB	USB 3.2 Gen 1 x 2

Miscellaneous

RTC	-
Watchdog Timer	1 ~ 255
Software Button	1
TPM	TPM 2.0 SPI
GPIO	N/A, DIO pin header x 1 (4-in/4-out), optional by BOM SKU
FAN	System Fan x 1
MTBF (Hours)	TBD
Color	Black

Environmental Parameters and Dimensions

Power Requirement	220W Power
Operating Temperature	32°F ~ 104°F (0°C ~ 40°C)
Storage Temperature	-4°F ~ 140°F (-20°C ~ 60°C)
Operating Humidity	10% ~ 80% relative humidity, non-condensing
Storage Humidity	0% ~ 80% @40°C; non-condensing

Environmental Parameters and Dimensions

Vibration	0.5 grms/5 ~ 500Hz / operation (2.5" Hard Disk Drive) 1.5 grms/5 ~ 500Hz / non operation
Shock	10 G peak acceleration (11 m sec. duration), operation 20 G peak acceleration (11 m sec. duration), non operation
Dimension	16.93" x 7.87" x 1.73" (430mm x 200mm x 44mm)

I/O Interfaces

Front Panel	1Gb RJ45 x 12 + up to 4 x 10Gb SFP+ (Optional by BOM SKU) Power LED x 1 Status LED x 1 HDD Active LED x 1 USB 3.2 GEN1 Ports x 2 RJ-45 Console x 1 LCM display with keypad x 1 Software Programmable Button x 1
Rear Panel	AC Power Input x 1 Power Switch x 1

Chapter 2

Hardware Information

2.1 Dimensions

System

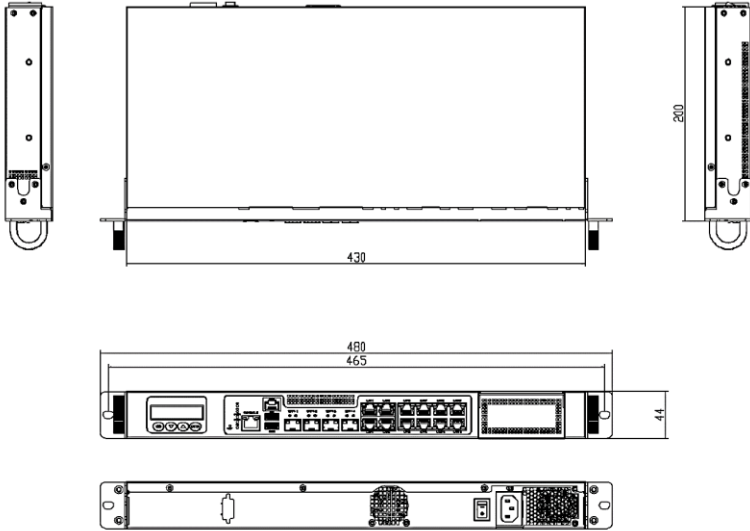

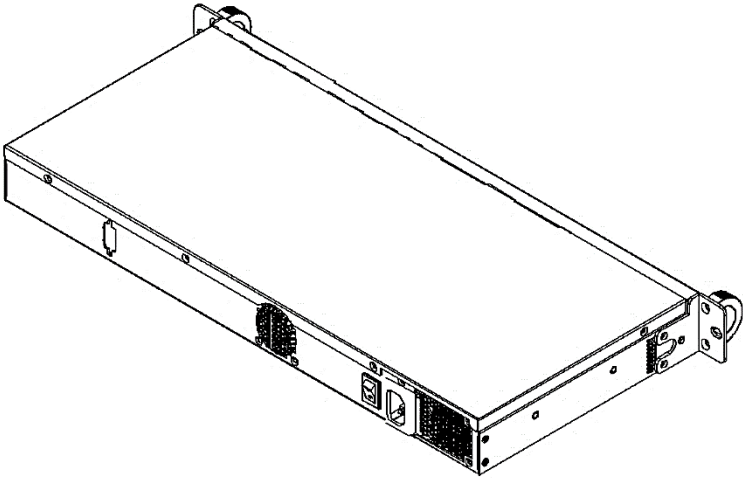
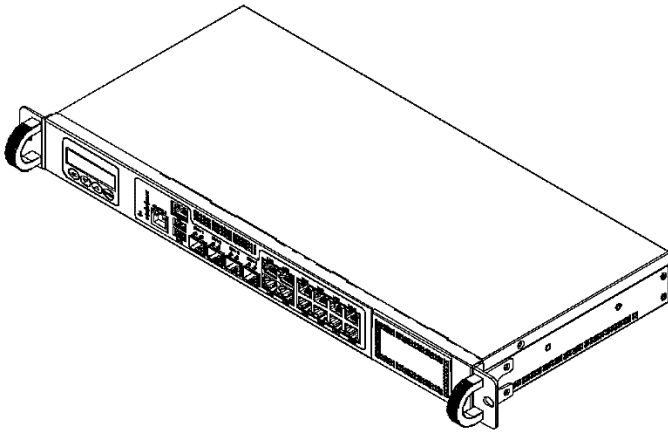

Board Component Side

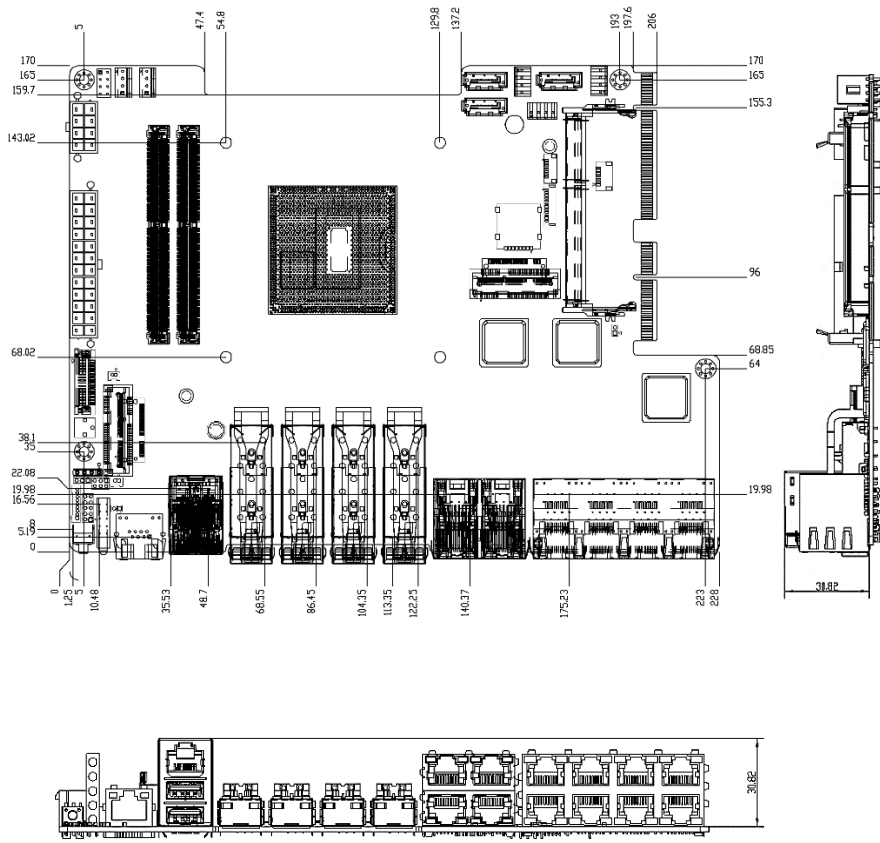

Solder Side

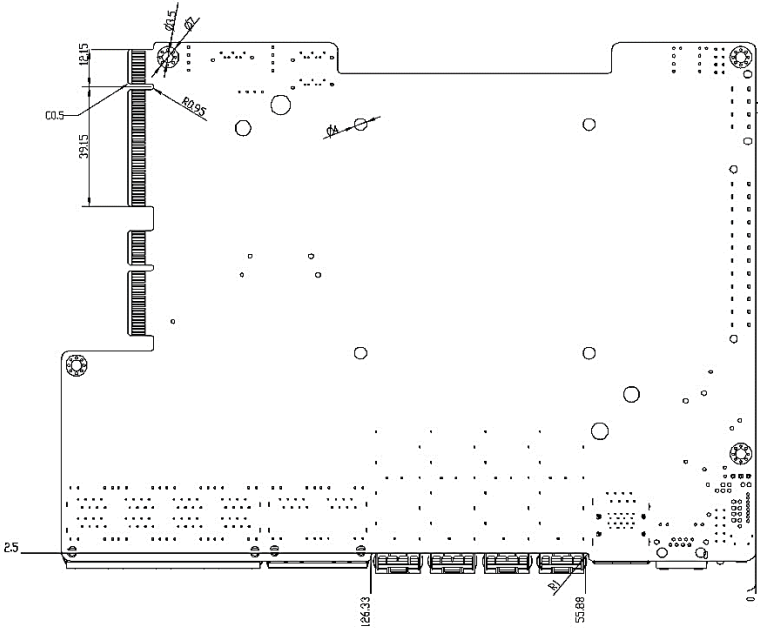

2.2 Jumpers and Connectors

Component Side

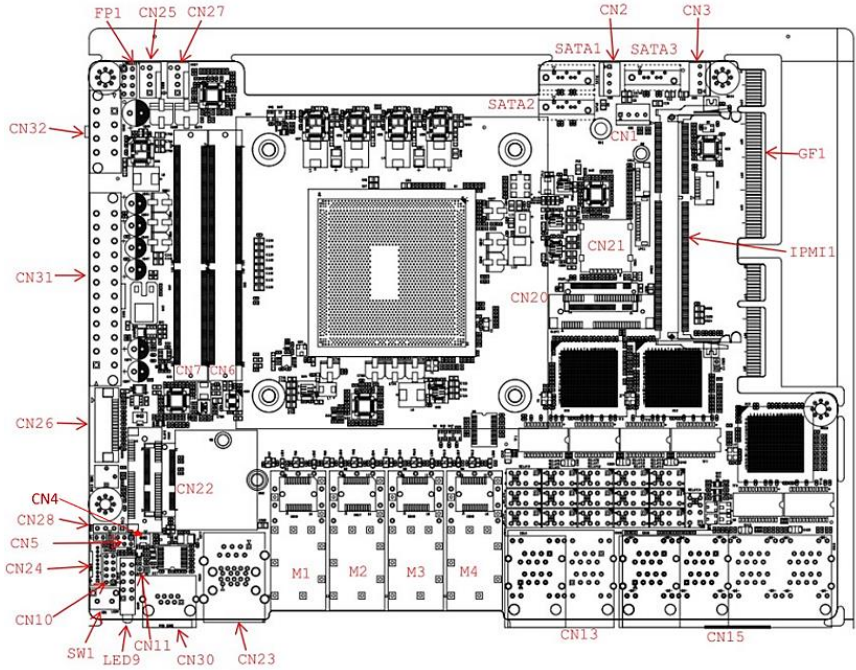

2.3 List of Jumpers

Please refer to the table below for all of the board's jumpers that you can configure for your application

Label	Function
CN5	Clear CMOS

2.3.1 Clear CMOS (CN5)

Setting	Configuration
Normal	1-3,2-4
Clear CMOS	3-5,4-6

Note: Normal is set as default.

2.4 List of Connectors

Please refer to the table below for all of the board's connectors that you can configure for your application

Label	Function
LED9	Status LED
CN1, CN2, CN3	SATA Power
CN4	Battery Header
CN6, CN7	DDR4 SO-DIMM*2
CN10	DIO Header
CN11	Case Open
CN13	1Gb RJ45 Port
CN15	1Gb RJ45 Port

CN20	M.2 B-Key slot
CN21	Micro SIM
CN22	M.2 E-Key slot
CN23	USB3.1 + RJ45 Connector (IPMI Ethernet)
CN24	Serial Port
CN25, CN27	FAN1/FAN2
CN26, CN28	LCM
CN30	Console
CN31, CN32	ATX Power Connector
M1, M2, M3, M4	10Gb SFP+
GF1	PCIe*8 Gold Finger (NIM riser card PER-R40X only)
SATA1, SATA2, SATA3	SATA Connector
FP1	Front Panel Header
IPMI1	IPMI Slot
SW1	Software Programmable Button

Note: Bypass Function on CN13.

Note: PCIe*8 on GF1 is for NIM riser card PER-R40X only, not for standard PCIe signal.

2.4.1 Battery Holder (CN4)

Pin	Signal	Pin	Signal
1	+3.3V	2	Ground

2.4.2 Digital IO Pin Header (CN10)

Pin	Signal	Pin	Signal
1	Digital I/O bit1	2	Digital I/O bit2
3	Digital I/O bit3	4	Digital I/O bit4
5	Digital I/O bit5	6	Digital I/O bit6
7	Digital I/O bit7	8	Digital I/O bit8
9	+5V	10	GND

2.4.3 Front Panel Header (FP1)

Pin	Signal	Pin	Signal
1	Power Button SW+	2	Ground
3	Hardware Reset SW+	4	Ground
5	PWRLED	6	Ground
7	HDDACT	8	HDD LED-

2.4.4 Case Open Holder (CN11)

Pin	Signal	Pin	Signal
1	Ground	2	Case Open

2.4.5 M.2 B-Key Slot (CN20)

Pin	Signal	Pin	Signal
1	CFG3	2	+3.3V
3	GND	4	+3.3V
5	GND	6	PWR_OFF
7	USB2DN	8	W_DISABLE
9	USB2DP	10	NC
11	GND	-	-
-	-	20	NC
21	CFG0	22	NC
23	NC	24	NC
25	NC	26	NC
27	GND	28	NC
29	PCIE1RXP	30	UIMRST
31	PCIE1RXN	32	UIMCLK
33	GND	34	UIMDAT
35	PCIE1TXN	36	UIMPWR
37	PCIE1TXP	38	DEVSLP
39	GND	40	NC
41	PCIE0RXP	42	NC
43	PCIE0RXN	44	NC
45	GND	46	NC
47	PCIE0TXN	48	NC
49	PCIE0TXP	50	PLTRST#
51	GND	52	NC
53	PCIECLKDN	54	WAKE#
55	PCIECLKDP	56	NC

57	GND	58	NC
59	NC	60	NC
61	NC	62	NC
63	NC	64	NC
65	NC	66	SIMDET
67	NC	68	32K_SUSCLK
69	CFG1	70	+3.3V
71	GND	72	+3.3V
73	GND	74	+3.3V
75	CFG2	-	-

2.4.6 M.2 E-Key Slot (CN22)

Pin	Signal	Pin	Signal
1	GND	2	+3.3V
3	NC	4	+3.3V
5	NC	6	NC
7	GND	8	NC
9	NC	10	NC
11	NC	12	NC
13	NC	14	NC
15	NC	16	NC
17	NC	18	GND
19	NC	20	NC
21	NC	22	NC
23	NC	32	NC
33	GND	34	NC
35	PCIE0TXP	36	NC

37	PCIE0TXN	38	NC
39	GND	40	NC
41	PCIE0RXP	42	NC
43	PCIE0RXN	44	NC
45	GND	46	NC
47	PCIECLK0DP	48	NC
49	PCIECLK0DN	50	32K_SUSCLK
51	GND	52	PLTRST#
53	CLKREQ#	54	DIS2#
55	WAKE#	56	DIS1#
57	GND	58	NC
59	PCIE1TXP	60	NC
61	PCIE1TXN	62	NC
63	GND	64	NC
65	PCIE0RXP	66	NC
67	PCIE0RXN	68	NC
69	GND	70	NC
71	PCIECLK1DP	72	+3.3V
73	PCIECLK1DN	74	+3.3V
75	GND	-	-

2.4.7 Serial Port (CN24)

Pin	Signal	Pin	Signal
1	DCD2	2	DSR2
3	RXD2	4	RTS2
5	TXD2	6	CTS2
7	DTR2	8	RI2
9	GND	-	-

2.5 Hardware Installation

This section details the hardware assembly steps for the FWS-7541. Please read this section thoroughly before beginning installation and ensure you have all necessary components ready. A Phillips head screwdriver is required.

2.5.1 Hard Disk Drive (HDD) Installation

Step 1: Unscrew the upper lid.



Step 2: Place assembled cushions on the hard disk driver bracket.

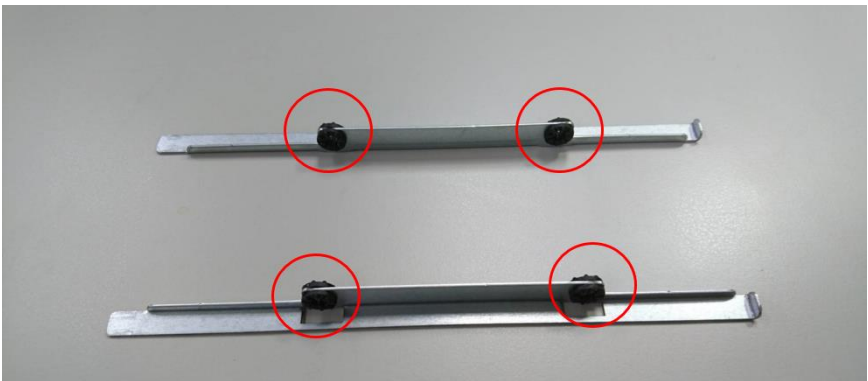

Step 3: Lock HDD on the bottom cushions with four screws.



Step 4: Connect the SATA cable and power cable to the main board.



Step 5: Connect the SATA cable and power cable into the Hard Disk and put hard drive bracket on the chassis.

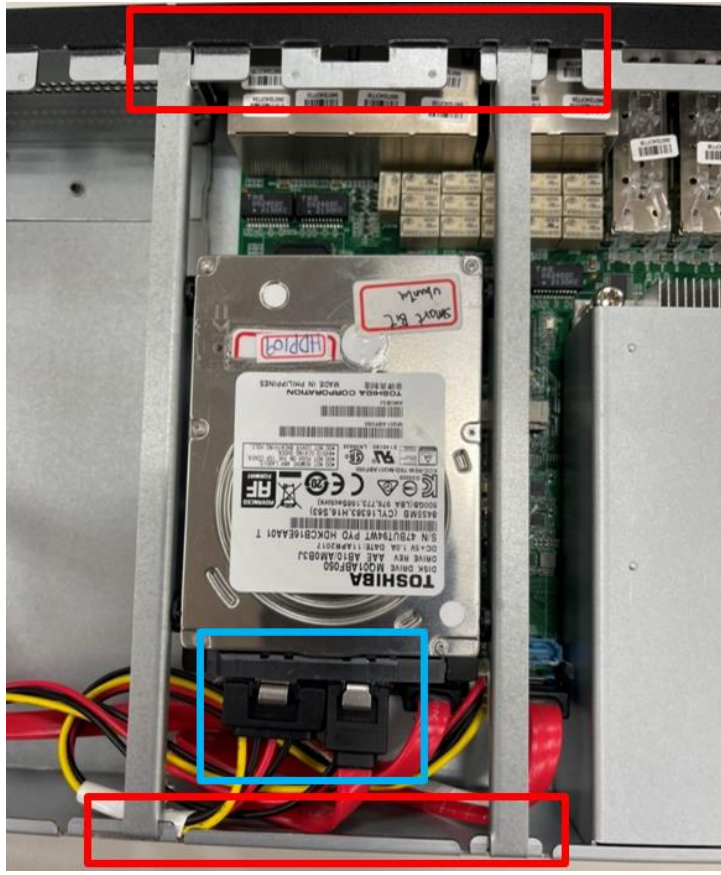

Step 6: Connect the SATA cable and power cable into the Hard Disk and put hard drive bracket on the chassis.



2.5.2 Heat Sink Installation

Step 1: Loosen the screw and remove the fan duct.



Step 2: Cover the Heatsink on the CPU and ensure the direction of the Heatsink does not obstruct the airflow.

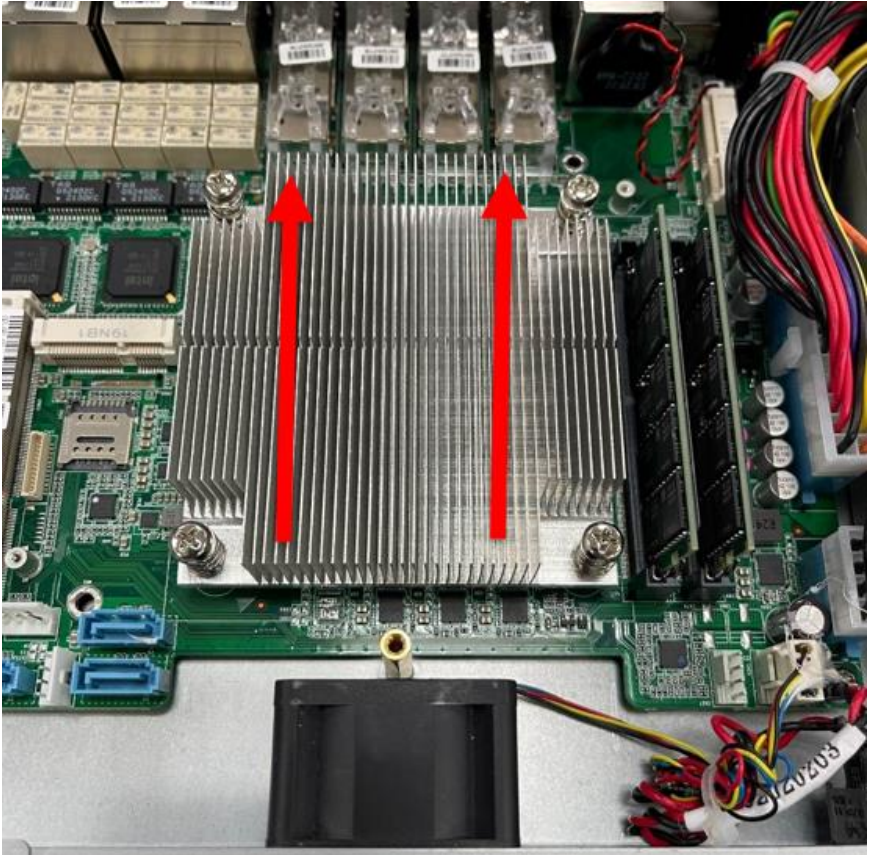

Step 3: Fasten the screw to lock the air duct.



2.5.3 NIM Installation

Step 1: Loosen the screws on the bottom of chassis.

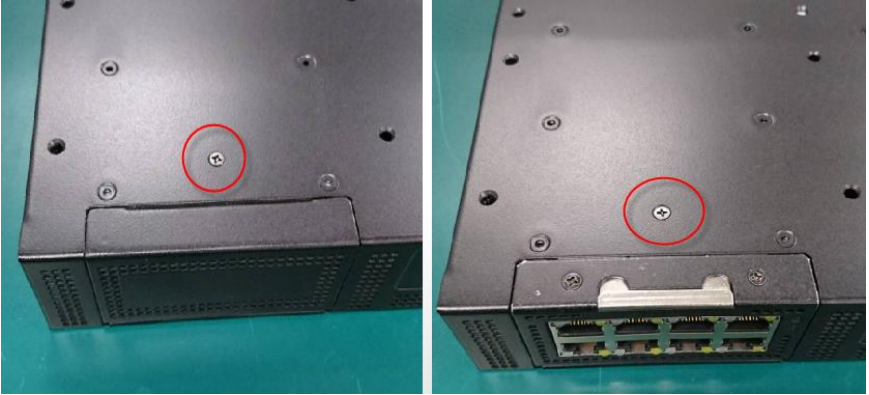

Step 2: Remove the null Module cover or existing LAN module.



Step 3: Insert the LAN Module and fasten the screws.

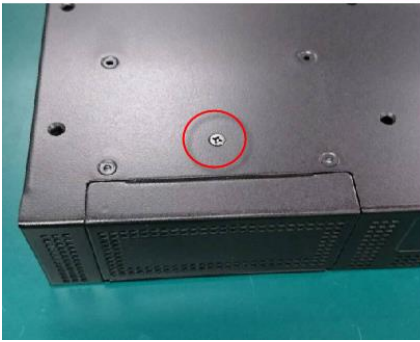
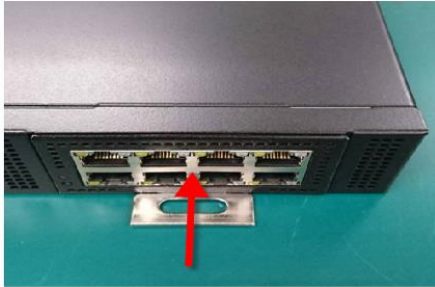

Chapter 3

AMI BIOS Setup

3.1 System Test and Initialization

These routines test and initialize board hardware. If the routines encounter an error during the tests, you will either hear a few short beeps or see an error message on the screen. There are two kinds of errors: fatal and non-fatal. The system can usually continue the boot up sequence with non-fatal errors.

System configuration verification:

These routines check the current system configuration stored in the CMOS memory and BIOS NVRAM. If system configuration is not found or system configuration data error is detected, system will load optimized default and re-boot with this default system configuration automatically.

There are four situations in which you will need to setup system configuration:

1. You are starting your system for the first time.
2. You have changed the hardware attached to your system.
3. The system configuration is reset by Clear-CMOS jumper.
4. The CMOS memory has lost power and the configuration information has been erased.

The FWS-7541 CMOS memory has an integral lithium battery backup for data retention. However, you will need to replace the complete unit when it finally runs down.

3.2 AMI BIOS Setup

AMI BIOS ROM has a built-in Setup program that allows users to modify the basic system configuration. This type of information is stored in battery-backed CMOS RAM and BIOS NVRAM so that it retains the Setup information when the power is turned off.

Entering Setup

Power on the computer and press or <ESC> immediately. This will allow you to enter Setup.

Main

Set the date, use tab to switch between date elements.

Advanced

In here, can set power mode, USB configuration and check CPU type and speed.

Chipset

Host bridge parameters.

Boot

Enables/disable quiet boot option.

Security

Set setup administrator/user password.

Save & Exit

Exit system setup after saving the changes.

3.3 Setup Submenu: Main



3.4 Setup Submenu: Advanced

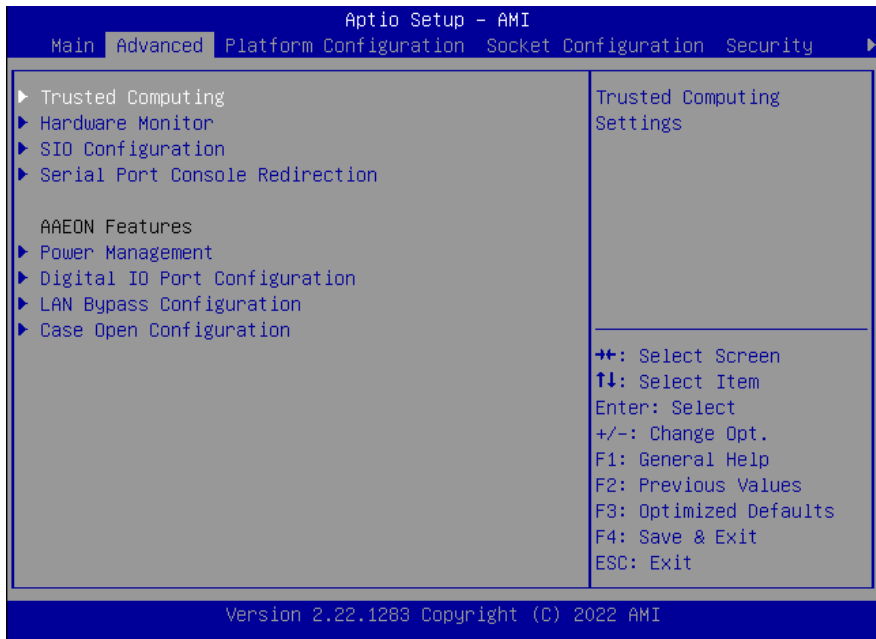

3.4.1 Trusted Computing

Aptio Setup - AMI

Advanced

<p>TPM 2.0 Device Found Firmware Version: 7.2 Vendor: NTC</p> <p>Security Device Support [Enable]</p> <p>Active PCR banks SHA-1,SHA256 Available PCR banks SHA-1,SHA256,SHA384</p> <p>SHA-1 PCR Bank [Enabled] SHA256 PCR Bank [Enabled] SHA384 PCR Bank [Disabled]</p> <p>Pending operation [None] Platform Hierarchy [Enabled] Storage Hierarchy [Enabled] Endorsement Hierarchy [Enabled]</p>	<p>▲ Enables or Disables BIOS support for security device. O.S. will not show Security Device. TCG EFI protocol and INT1A interface will not be available.</p> <hr/> <p>++: Select Screen ↑↓: Select Item Enter: Select +/-: Change Opt. F1: General Help F2: Previous Values F3: Optimized Defaults F4: Save & Exit ▼ ESC: Exit</p>
--	--

Version 2.22.1283 Copyright (C) 2022 AMI

Options Summary		
Security Device Support	Enable Disable	Optimal Default, Failsafe Default
Enables or Disables BIOS support for security device. O.S. will not show Security Device. TCG EFI protocol and INT1A interface will not be available.		
SHA-1 PCR Bank	Enabled Disabled	Optimal Default, Failsafe Default
Enable or Disable SHA-1 PCR Bank		
SHA256 PCR Bank	Enabled Disabled	Optimal Default, Failsafe Default
Enable or Disable SHA256 PCR Bank.		
SHA384 PCR Bank	Enabled Disabled	Optimal Default, Failsafe Default
Enable or Disable SHA384 PCR Bank.		
Pending operation	None TPM Clear	Optimal Default, Failsafe Default
Schedule an Operation for the Security Device. NOTE: Your Computer will reboot during restart in order to change State of Security Device.		
Platform Hierarchy	Enabled	Optimal Default, Failsafe Default

	Disabled	
Enable or Disable Platform Hierarchy		
Storage Hierarchy	Enabled	Optimal Default, Failsafe Default
	Disabled	
Enable or Disable Storage Hierarchy		
Endorsement Hierarchy	Enabled	Optimal Default, Failsafe Default
	Disabled	
Enable or Disable Endorsement Hierarchy		
TPM 2.0 UEFI Spec Version	TCG_2	Optimal Default, Failsafe Default
	TCG_1_2	
Select the TCH2 Spec Version Support. TCG_1_2: The Compatible mode for Win8/Win10 TCG_2: Support new TCG2 protocol and event format for Win10 or later		
Physical Presence Spec Version	1.3	Optimal Default, Failsafe Default
	1.2	
Select to Tell O.S. to support PPI Spec Version 1.2 or 1.3. Note some HCK tests might not support 1.3		
Device Select	Auto	Optimal Default, Failsafe Default
	TPM 1.2	
	TPM 2.0	
TPM 1.2 will restrict support to TPM 1.2 devices, TPM 2.0 will restrict support to TPM 2.0 devices, Auto will support both with the default set to TPM 2.0 devices if not found, TPM 1.2 devices will be enumerated.		

3.4.2 Hardware Monitor

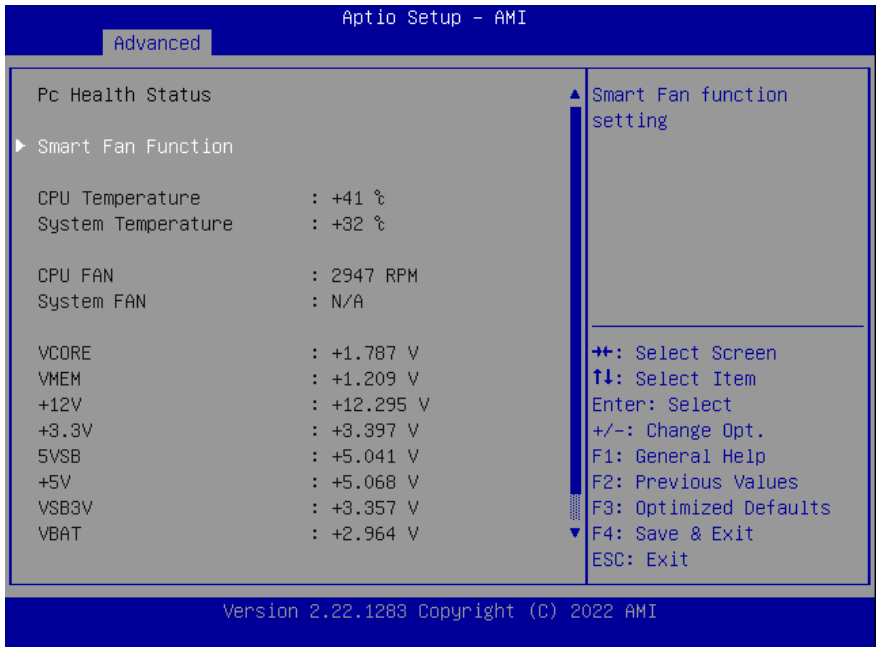

3.4.3 System FAN Setting

Aptio Setup - AMI

Advanced

Smart Fan Function CPU Fan Setting CPU Fan Mode [Software Mode] Manual PWM Setting 127 System Fan Setting System Fan Mode [Software Mode] Manual PWM Setting 127	Smart Fan Mode Select ⇧⇧: Select Screen ⇩⇩: Select Item Enter: Select +/-: Change Opt. F1: General Help F2: Previous Values F3: Optimized Defaults F4: Save & Exit ESC: Exit
--	---

Version 2.22.1283 Copyright (C) 2022 AMI

Options Summary		
Manual PWM Setting	127	Optimal Default, Failsafe Default
Fan will work with this Manual PWM Value		

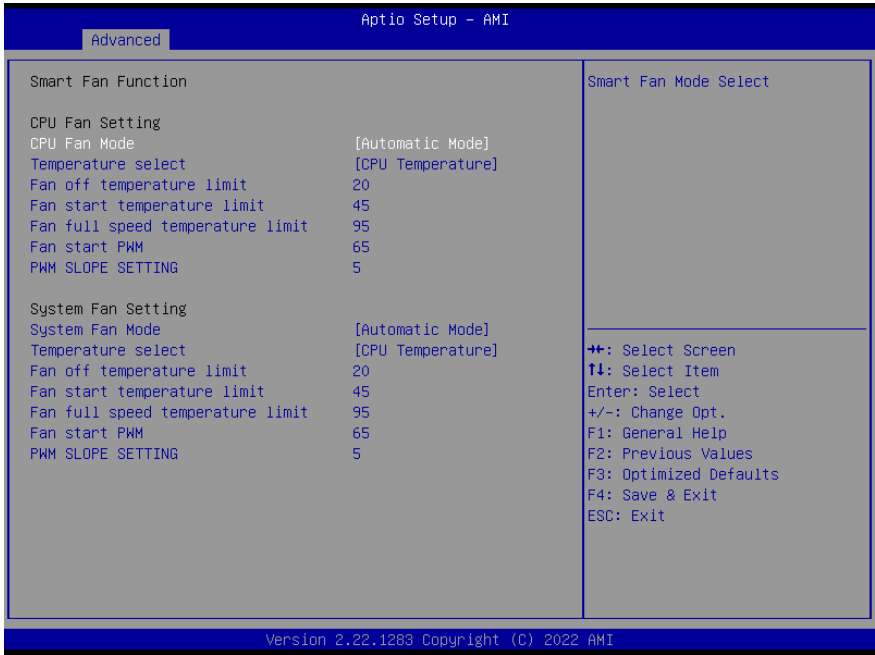

Options Summary		
Smart Fan 1 Mode	Automatic Mode	Optimal Default, Failsafe Default
	Software Mode	
Smart Fan Mode Select		
Fan off temperature limit	20	Optimal Default, Failsafe Default
Fan will off when temperature lower then this limit		
Fan start temperature limit	45	Optimal Default, Failsafe Default
Fan will work when temperature higher than this limit		
Fan full speed temperature limit	95	Optimal Default, Failsafe Default
Fan will full speed when temperature higher than this limit		
Fan start PWM	65	Optimal Default, Failsafe Default
Fan will full start with this PWM value		
PWM SLOPE SETTING	5	Optimal Default, Failsafe Default
PWM SLOPE Selection		
Slope = PWM value / °C		

3.4.4 SIO Configuration

The screenshot shows the 'Advanced' tab of the 'Aptio Setup - AMI' BIOS. The main area is divided into two columns. The left column contains the following text: 'AMI SIO Driver Version : A5.17.00', 'Super IO Chip Logical Device(s) Configuration', and three items: '▶ [*Active*] Serial Port 0', '▶ [*Active*] Serial Port 1', and '▶ [*Active*] Parallel Port'. Below these is a 'WARNING' message: 'WARNING: Logical Devices state on the left side of the control, reflects the current Logical Device state. Changes made during Setup Session will be shown after you restart the system.' The right column contains a description: 'View and Set Basic properties of the SIO Logical device. Like IO Base, IRQ Range, DMA Channel and Device Mode.' Below this is a legend for navigation: '++: Select Screen', '↑↓: Select Item', 'Enter: Select', '+/-: Change Opt.', 'F1: General Help', 'F2: Previous Values', 'F3: Optimized Defaults', 'F4: Save & Exit', and 'ESC: Exit'. At the bottom of the screen, it says 'Version 2.22.1283 Copyright (C) 2022 AMI'.

3.4.5 Serial Port 0 Configuration



Options Summary		
Use This Device	Enabled	Optimal Default, Failsafe Default
	Disabled	
Enable or Disable this Logical Device		
Possible	Use Automatic setting	Optimal Default, Failsafe Default
	IO=3F8h; IRQ=4	
	IO=2F8h; IRQ=3	
Allows the user to change the device resource settings. New settings will be reflected on this setup page after system restarts		

3.4.6 Serial Port 1 Configuration



Options Summary		
Use This Device	Enabled	Optimal Default, Failsafe Default
	Disabled	
Enable or Disable this Logical Device		
Possible	Use Automatic setting	Optimal Default, Failsafe Default
	IO=3F8h; IRQ=4	
	IO=2F8h; IRQ=3	
Allows the user to change the device resource settings. New settings will be reflected on this setup page after system restarts		

3.4.7 Parallel Port Configuration

Aptio Setup - AMI

Advanced

<p>Parallel Port Configuration</p> <p>Use This Device [Enabled]</p> <p>Logical Device Settings:</p> <p>Current : IO=378h; IRQ=5;</p> <p>Possible: [Use Automatic Settings]</p> <p>Mode : [Standard Parallel Port mode(SPP)]</p> <p>WARNING: Disabling SIO Logical Devices may have unwanted side effects. PROCEED WITH CAUTION.</p>	<p>Enable or Disable this Logical Device.</p> <hr/> <p> ++: Select Screen ↑↓: Select Item Enter: Select +/-: Change Opt. F1: General Help F2: Previous Values F3: Optimized Defaults F4: Save & Exit ESC: Exit </p>
---	---

Version 2.22.1283 Copyright (C) 2022 AMI

Options Summary		
Use This Device	Enabled	Optimal Default, Failsafe Default
	Disabled	
Enable or Disable this Logical Device		
Possible	Use Automatic setting	Optimal Default, Failsafe Default
	IO=378h; IRQ=5	
	IO=378h; IRQ=5, 6, 7, 10, 11, 12	
	IO=278h; IRQ=5, 6, 7, 10, 11, 12	
	IO=3BCh; IRQ=5, 6, 7, 10, 11, 12	
Allows the user to change the device resource settings. New settings will be reflected on this setup page after system restarts		

Options Summary

Mode	Standard Parallel Port mode (SPP)	Optimal Default, Failsafe Default
	EPP Mode	
	ECP Mode	
	EPP mode & ECP mode	
Change Parallel Port mode. Some of the Modes require a DMA resource. After Mode changing, Reset the System to reflect actual device settings		

3.4.8 Serial Port Console Redirection

Aptio Setup - AMI

Advanced

<p>CDROM</p> <p>Console Redirection [Enabled]</p> <p>▶ Console Redirection Settings</p> <p>Legacy Console Redirection</p> <p>▶ Legacy Console Redirection Settings</p> <p>Serial Port for Out-of-Band Management/ Windows Emergency Management Services (EMS)</p> <p>Console Redirection [Disabled]</p> <p>EMS</p> <p>▶ Console Redirection Settings</p>	<p>Console Redirection Enable or Disable.</p> <hr/> <p>++: Select Screen ↑↓: Select Item Enter: Select +/-: Change Opt. F1: General Help F2: Previous Values F3: Optimized Defaults F4: Save & Exit ESC: Exit</p>
--	---

Version 2.22.1283 Copyright (C) 2022 AMI

Options Summary

Console Redirection	Enabled	Optimal Default, Failsafe Default
	Disabled	
Console Redirection Enable or Disable		
Console Redirection EMS	Enabled	
	Disabled	Optimal Default, Failsafe Default
Console Redirection Enable or Disable		

3.4.9 Console Redirection Settings

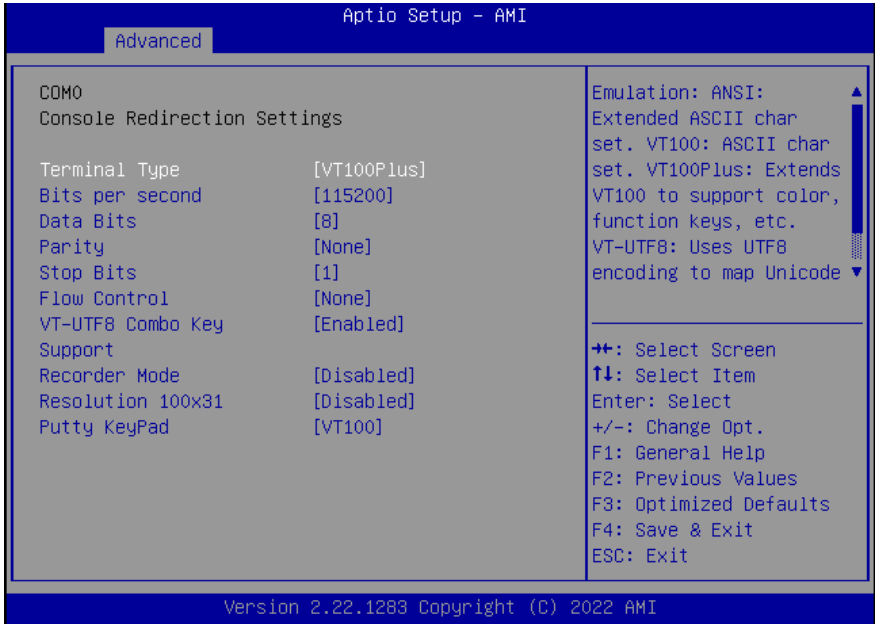

Options Summary		
Terminal Type	VT100	
	VT100Plus	Optimal Default, Failsafe Default
	VT-UTF8	
	ANSI	
Emulation: ANSI: Extended ASCII char set. VT100: ASCII char set. VT100+: Extends VT100 to support color, function keys, etc. VT-UTF8: Uses UTF8 encoding to map Unicode chars onto 1 or more bytes.		
Bits per second	9600	
	19200	
	38400	
	57600	
	115200	Optimal Default, Failsafe Default
Selects serial port transmission speed. The speed must be matched on the other side. Long or noisy lines may require lower speeds		
Data Bits	7	
	8	Optimal Default, Failsafe Default
Data Bits		

Options Summary

Parity	None	Optimal Default, Failsafe Default
	Even	
	Odd	
	Mark	
	Space	
<p>A parity bit can be sent with the data bits to detect some transmission errors. Even: parity bit is 0 if the num of 1's in the data bits is even. Odd: parity bit is 0 if num of 1's in the data bits is odd. Mark: parity bit is always 1. Space: Parity bit is always 0. Mark and Space Parity do not allow for error detection. They can be used as an additional data bit.</p>		
Stop Bits	1	Optimal Default, Failsafe Default
	2	
<p>Stop bits indicate the end of a serial data packet. (A start bit indicates the beginning). The standard setting is 1 stop bit. Communication with slow devices may require more than 1 stop bit.</p>		
Flow Control	None	Optimal Default, Failsafe Default
	Hardware RTS/CTS	
<p>Flow control can prevent data loss from buffer overflow. When sending data, if the receiving buffers are full, a 'stop' signal can be sent to stop the data flow. Once the buffers are empty, a 'start' signal can be sent to re-start the flow. Hardware flow control uses two wires to send start/stop signals.</p>		
VT-UTF8 Combo Key Support	Enabled	Optimal Default, Failsafe Default
	Disabled	
<p>Enable VT-UTF8 Combination Key Support for ANSI/VT100 terminals</p>		
Recorder Mode	Enabled	
	Disabled	Optimal Default, Failsafe Default
<p>With this mode enabled only text will be sent. This is to capture Terminal data.</p>		
Resolution 100x31	Enabled	
	Disabled	Optimal Default, Failsafe Default
<p>Enables or disables extended terminal resolution</p>		
Putty KeyPad	VT100	Optimal Default, Failsafe Default
	LINUX	
	XTERMR6	
	SCO	
	ESCN	
	VT400	
<p>Select FunctionKey and KeyPad on Putty.</p>		

3.4.10 Legacy Console Redirection Settings

Aptio Setup - AMI

Advanced

Legacy Console Redirection Settings		Select a COM port to display redirection of Legacy OS and Legacy OPRM Messages
Redirection COM Port	[COM0]	
Resolution	[80x24]	++: Select Screen ↑↓: Select Item Enter: Select +/-: Change Opt. F1: General Help F2: Previous Values F3: Optimized Defaults F4: Save & Exit ESC: Exit
Redirect After POST	[Always Enable]	

Version 2.22.1283 Copyright (C) 2022 AMI

Options Summary		
Redirection COM Port	COM0	Optimal Default, Failsafe Default
Select a COM port to display redirection of Legacy OS and Legacy OPRM Message		
Resolution	80x24	Optimal Default, Failsafe Default
	80x25	
On Legacy OS, the Number of Rows and Columns supported redirection		

3.4.11 Power Management

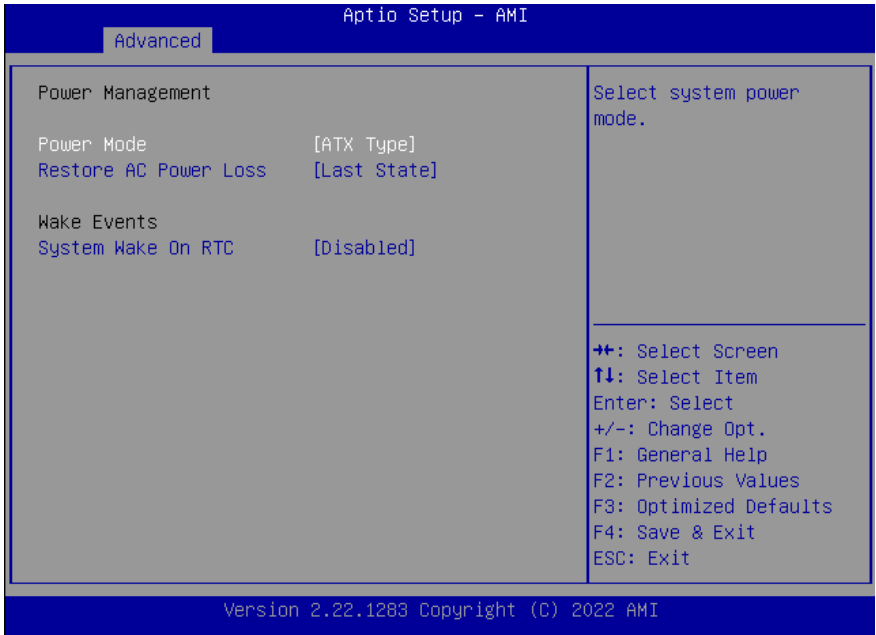

Options Summary		
Power Mode	ATX Type	Optimal Default, Failsafe Default
	AT Type	
Select system power mode.		
Restore AC Power Loss	Last State	Optimal Default, Failsafe Default
	Always On	
	Always Off	
System Wake On RTC	Disabled	Optimal Default, Failsafe Default
	By Date	
	By Weekday	
	Bypass	
By Date: System will wake on the day with hr::min::sec specified./n		
By Weekday: System will wake on the enabled weekday with hr::min::sec specified./n		
Bypass: BIOS will not control RTC wake function		

3.4.12 Digital IO Port Configuration

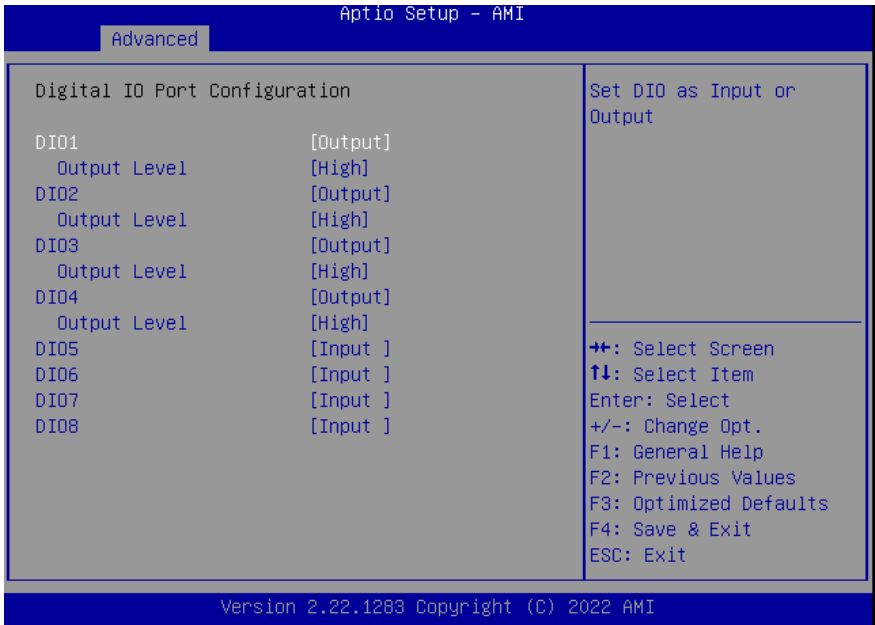

Options Summary		
DIO	Input	
	Output	
Set DIO as Input or Output		
Output Level	High	Optimal Default, Failsafe Default
	Low	
Set output level when DIO pin is output		

3.4.13 LAN Bypass Configuration

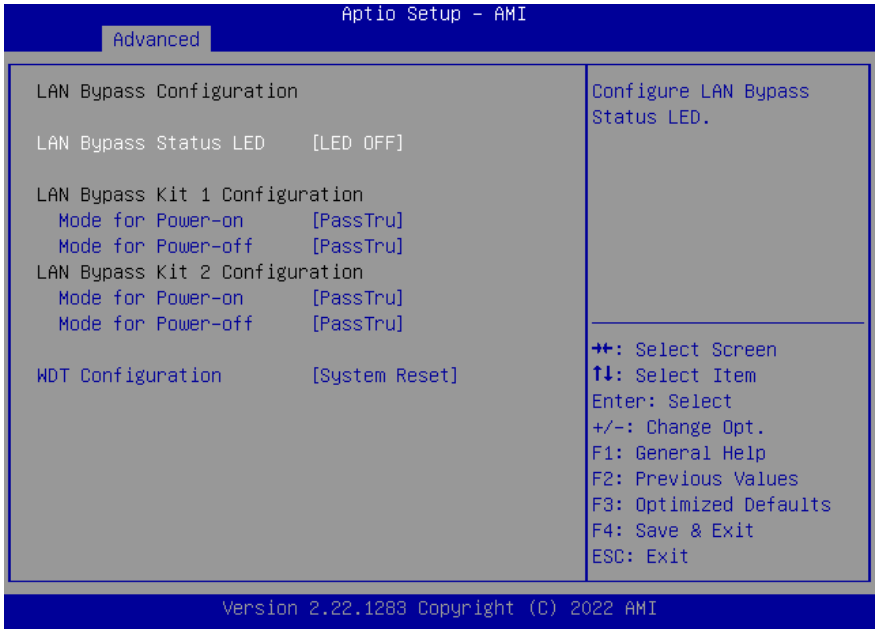

Options Summary		
Lan Bypass Status LED	LED OFF	Optimal Default, Failsafe Default
	RED LED ON	
	RED LED BLINK	
	RED LED FAST BLINK	
	GREEN LED ON	
	GREEN LED BLINK	
	GREEN LED FAST BLINK	
Configure LAN Bypass status LED		
Mode for Power-on	PassTru	Optimal Default, Failsafe Default
	Bypass	
Configure LAN kit behavior when system is in power-on state. (Bypass/Pass Through)		
Mode for Power-off	PassTru	Optimal Default, Failsafe Default
	Bypass	
Configure LAN kit behavior when system is in power-off state. (Bypass/Pass Through)		
WDT Configuration	System Reset	Optimal Default, Failsafe Default
	Force Bypass	
Configure WDT behavior, System Reset, Force Bypass		

3.4.14 Case Open Configuration

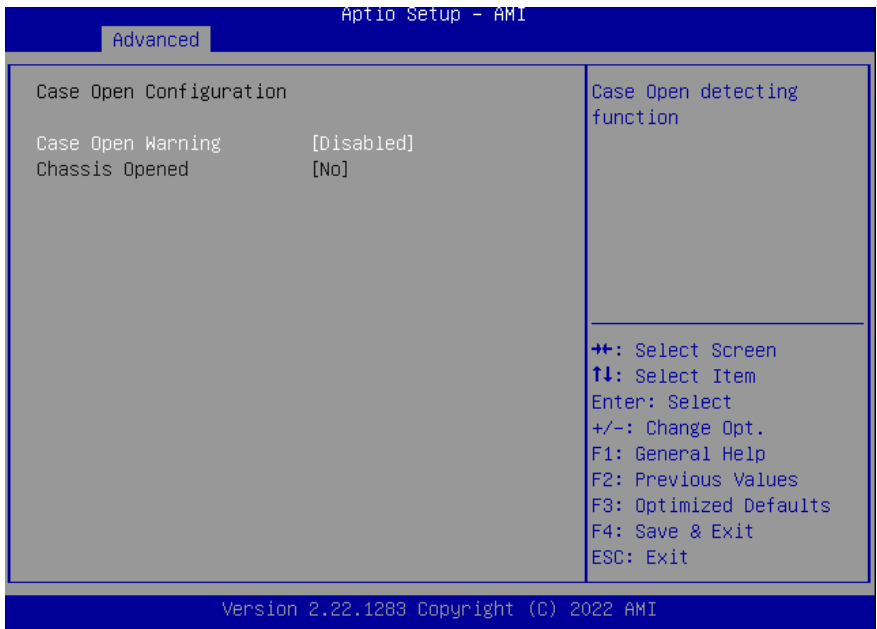

Options Summary		
Case Open Warning	Disabled	Optimal Default, Failsafe Default
	Enabled	
	Clear	
Case Open detecting function		

3.5 Setup Submenu: Platform Configuration

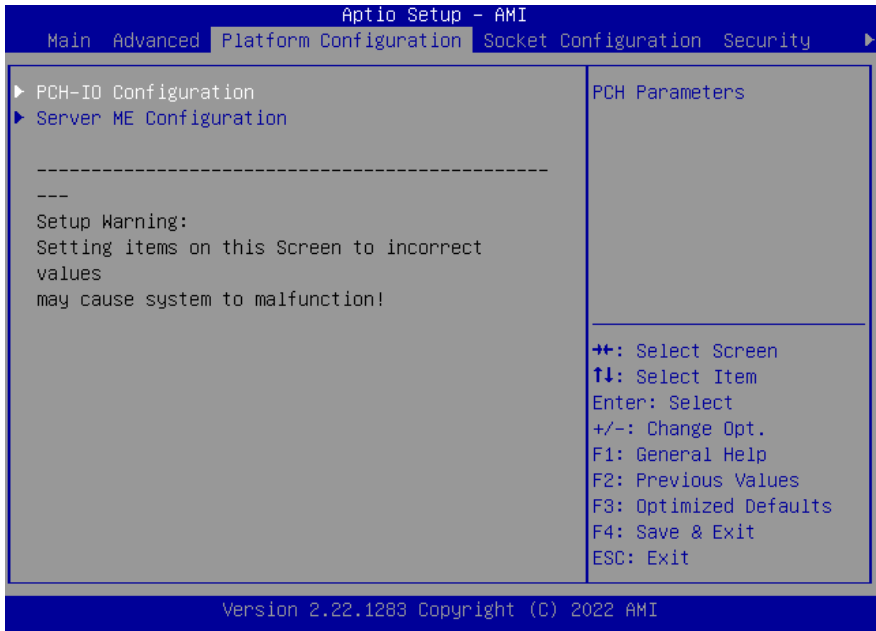

3.5.1 PCH-IO Configuration

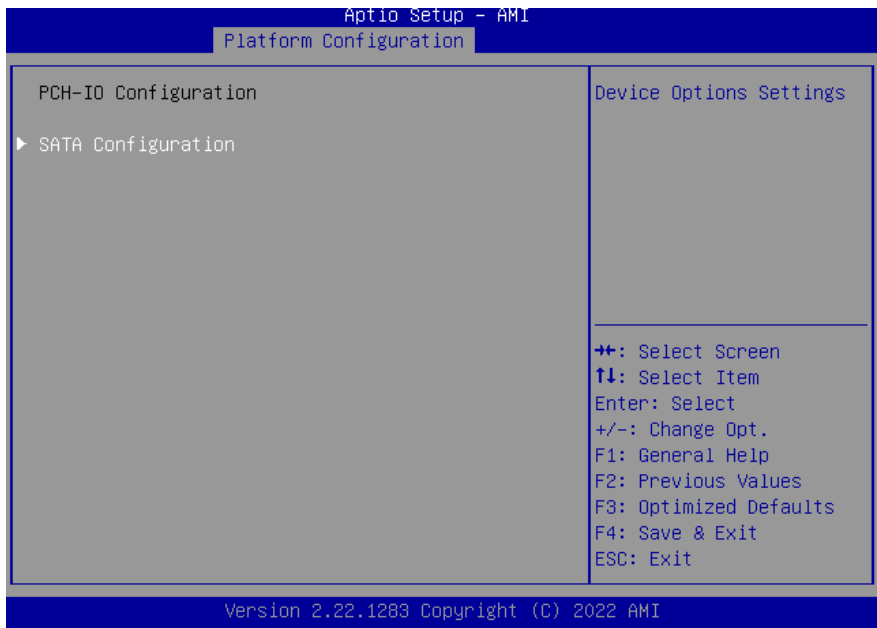

3.5.2 SATA Configuration

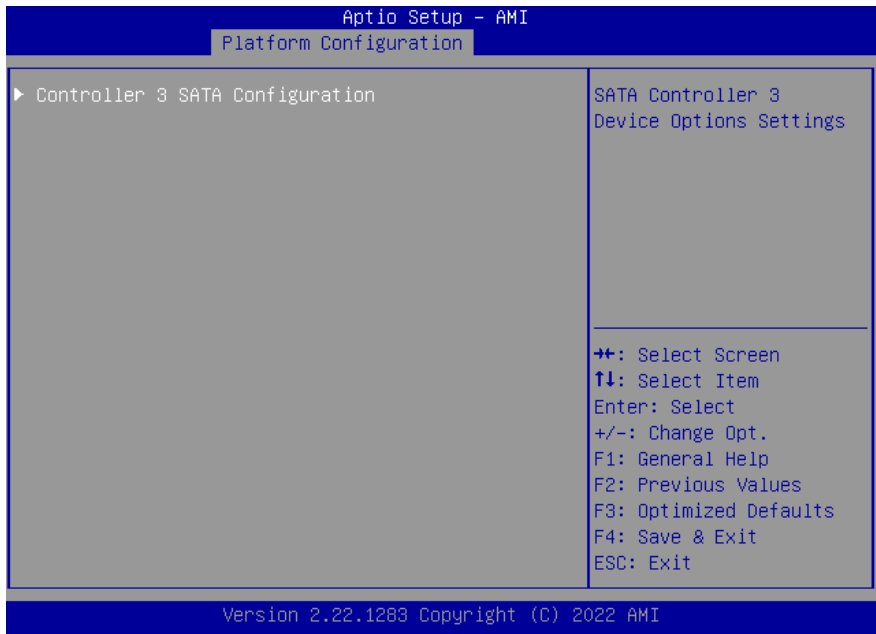

3.5.3 Controller 3 SATA Configuration

```

Aptio Setup - AMI
Platform Configuration

Controller 3 SATA Configuration
SATA Configuration      [Enabled]
SATA Port 0             [Not Installed]
SATA Port 1             [Not Installed]
SATA Port 2             [Not Installed]
SATA Port 3             [Not Installed]
SATA Port 4             [Not Installed]

SATA test settings

+/: Select Screen
↑↓: Select Item
Enter: Select
+/-: Change Opt.
F1: General Help
F2: Previous Values
F3: Optimized Defaults
F4: Save & Exit
ESC: Exit

Version 2.22.1283 Copyright (C) 2022 AMI
    
```

Options Summary		
SATA Configuration	Enabled	Optimal Default, Failsafe Default
	Disabled	
SATA test setting		

3.5.4 General ME Configuration

Aptio Setup - AMI

Platform Configuration

General ME Configuration	
Oper. Firmware Version	11:5.0.3.67
Backup Firmware Version	N/A
Recovery Firmware Version	11:5.0.3.67
ME Firmware Status #1	0x00000245
ME Firmware Status #2	0x8011C006
Current State	Operational
Error Code	No Error
Recovery Cause	N/A

++: Select Screen
↑↓: Select Item
Enter: Select
+/-: Change Opt.
F1: General Help
F2: Previous Values
F3: Optimized Defaults
F4: Save & Exit
ESC: Exit

Version 2.22.1283 Copyright (C) 2022 AMI

3.5.5 Socket Configuration

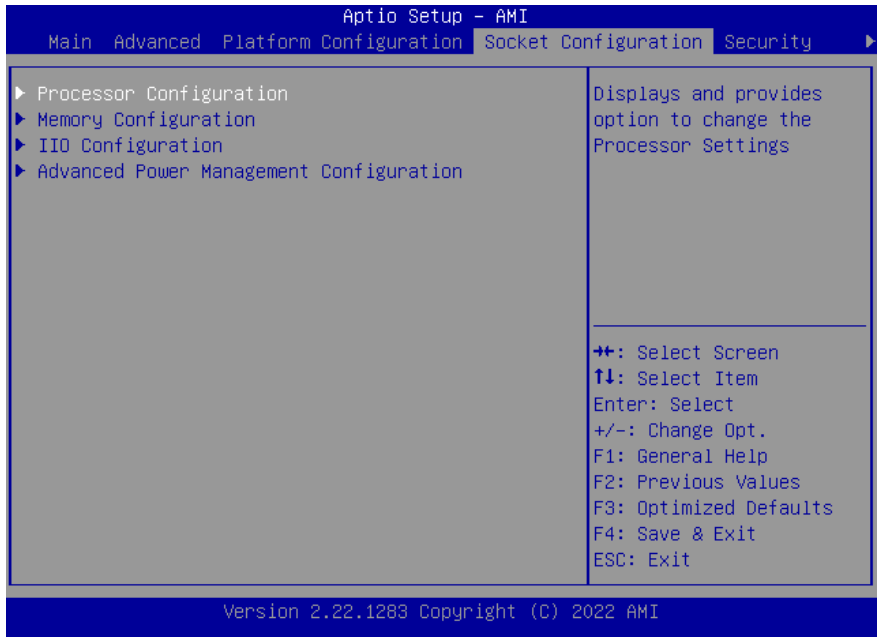

3.5.6 Processor Configuration

Aptio Setup - AMI

Socket Configuration

<p>Processor Configuration</p> <p>-----</p> <p>---</p> <p>Processor BSP Revision 606C1 - ICX-D LCC B</p> <p>Processor Socket Socket 0 Socket 1</p> <p>Processor ID 000606C1*</p> <p>Processor Frequency 2.200GHz</p> <p>Processor Max Ratio 16H</p> <p>Processor Min Ratio 08H</p> <p>Microcode Revision 01000150</p> <p>L1 Cache RAM(Per Core) 80KB</p> <p>L2 Cache RAM(Per Core) 1280KB</p> <p>L3 Cache RAM(Per Package) 10240KB</p> <p>Processor 0 Version Intel(R) Xeon(R) D-1713 NT CPU @ 2.20GHz</p> <p>Hyper-Threading [ALL] [Enable]</p>	<p>Enables Hyper Threading (Software Method to Enable/Disable Logical Processor threads.</p> <hr/> <p>++: Select Screen ↑↓: Select Item Enter: Select +/-: Change Opt. F1: General Help F2: Previous Values F3: Optimized Defaults F4: Save & Exit ESC: Exit</p>
---	--

Version 2.22.1283 Copyright (C) 2022 AMI

Options Summary		
Hyper-Threading	Enabled	Optimal Default, Failsafe Default
[ALL]	Disabled	
Enables Hyper Threading (Software Method to Enable/Disable Logical Processor threads.		

3.5.7 Memory Configuration

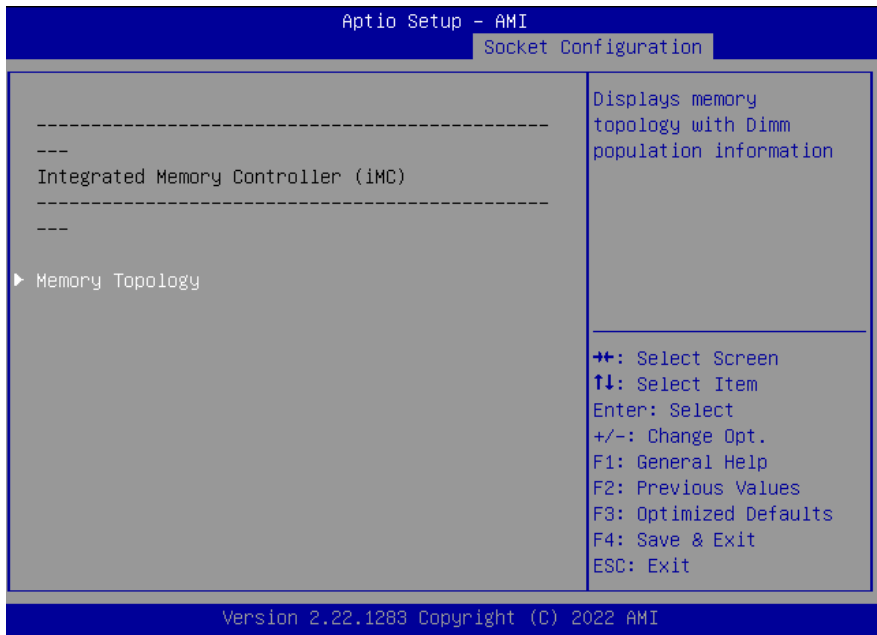

3.5.8 Memory Topology

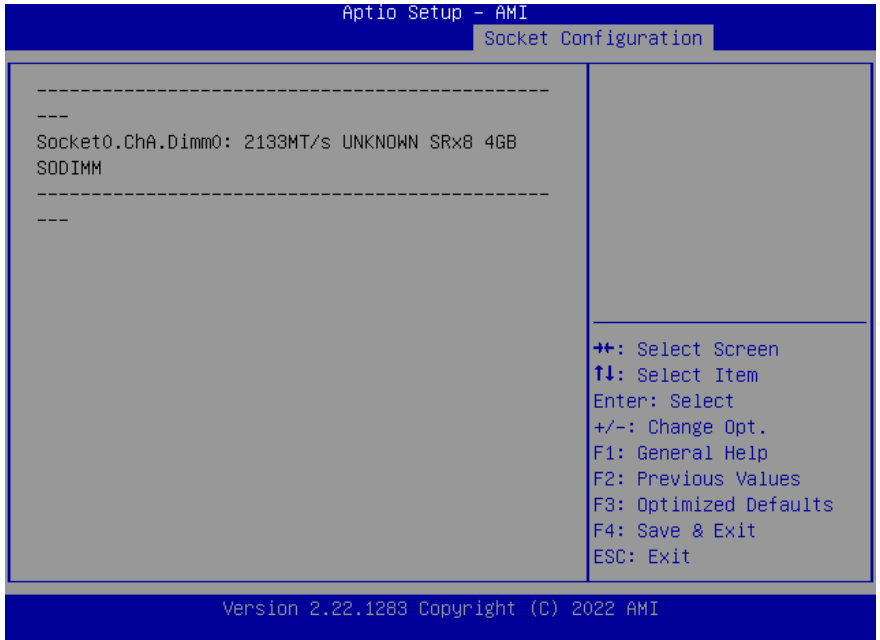

3.5.9 IIO Configuration

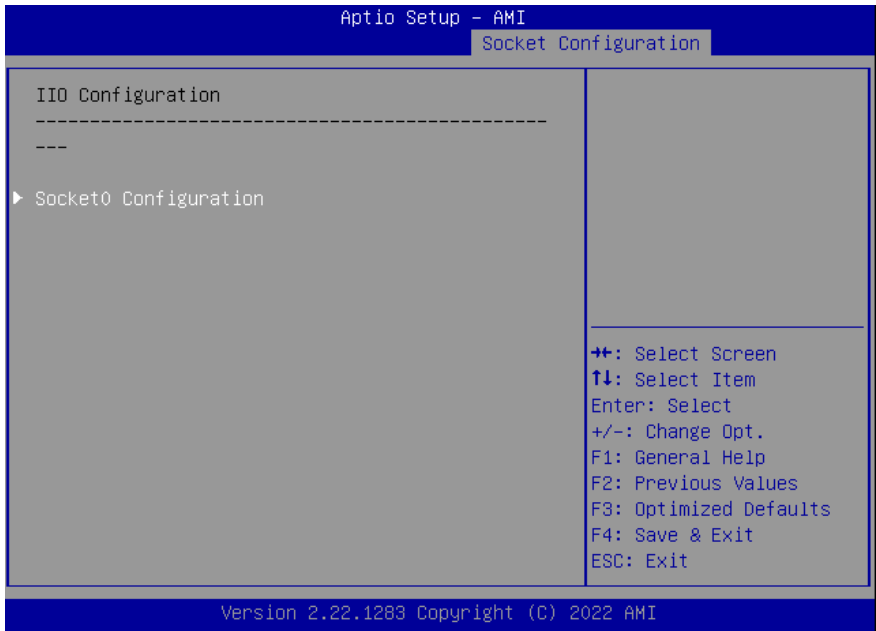

3.5.10 Socket0 Configuration



Options Summary		
IOU0 (IIO PCIe Port 1)	Auto	Optimal Default, Failsafe Default
	X4x4x8	
	X8x8	
	X16	
Selects PCIe port Bifurcation for selected slot(s)		

3.5.11 Advanced Power Management Configuration



3.5.12 Hardware PM State Control

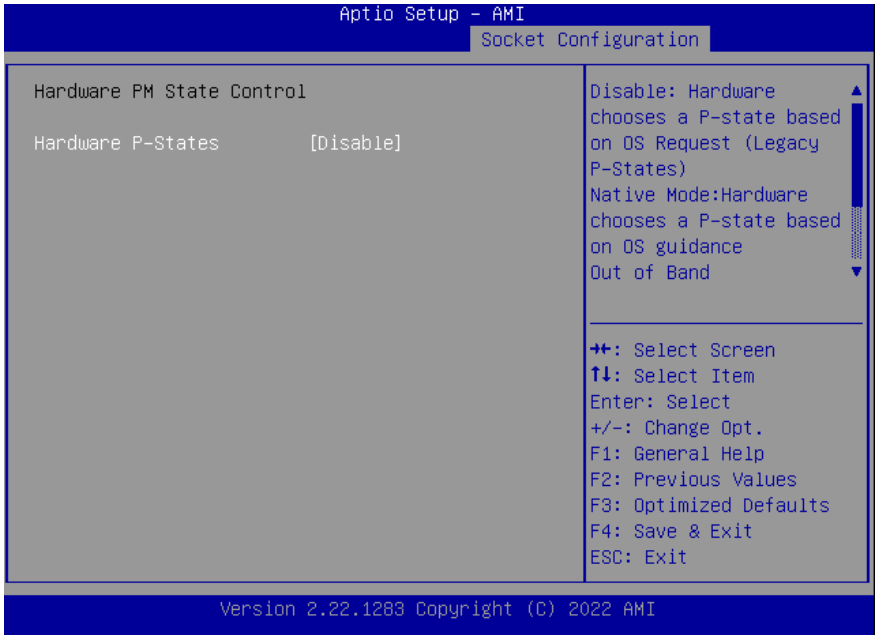

Options Summary		
Hardware P-States	Disable	Optimal Default, Failsafe Default
	Native Mode	
Disable: Hardware chooses a P-state based on OS Request (Legacy P-States) Native Mode: Hardware chooses a P-state based on OS guidance Out of Band Mode: Hardware autonomously chooses a P-state (no OS guidance)"		

3.6 Setup Submenu: Security



Change User/Administrator Password

You can install an Administrator password, and if you install an administrator password, you can then install a user password. A user password does not provide access to many of the features in the Setup utility.

If you highlight these items and press Enter, a dialog box appears which lets you enter a password. You can enter no more than six letters or numbers. Press Enter after you have typed in the password. A second dialog box asks you to retype the password for confirmation. Press Enter after you have retyped it correctly. The password is required at boot time, or when the user enters the Setup utility.

Removing the Password

Highlight this item and type in the current password. At the next dialog box press Enter to disable password protection.

3.6.1 Secure Boot

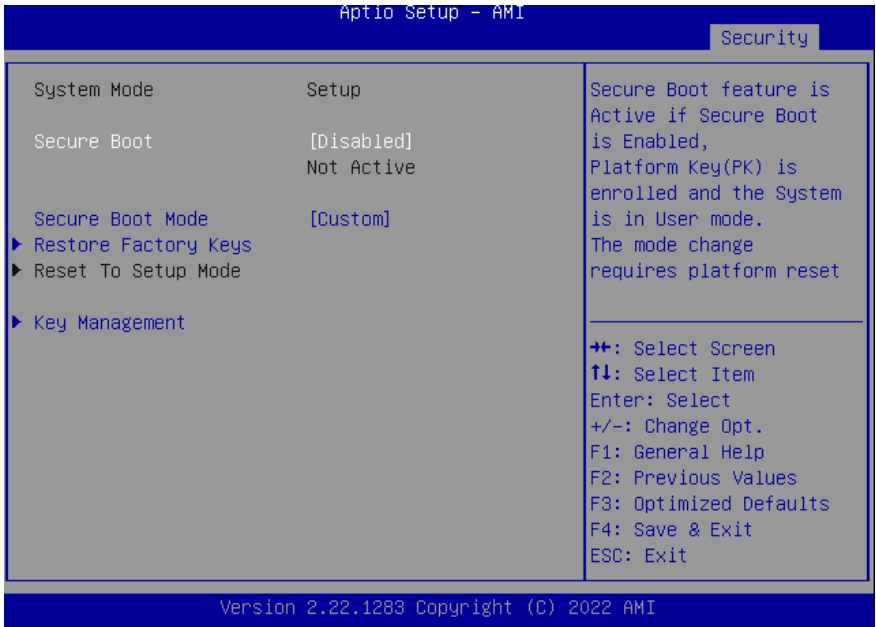

Options Summary		
Secure Boot	Disabled	Optimal Default, Failsafe Default
	Enabled	
Secure Boot feature is Active if Secure Boot is Enabled, Platform Key (PK) is enrolled and the System is in User mode. The mode change requires platform reset		
Secure Boot Mode	Standard	
	Custom	Optimal Default, Failsafe Default
Secure Boot mode options: Standard or Custom. In Custom mode, Secure Boot Policy variables can be configured by a physically present user without full authentication		
Restore Factory Keys	Force System to User Mode. Install factory default Secure Boot key databases	

3.6.1.1 Key Management

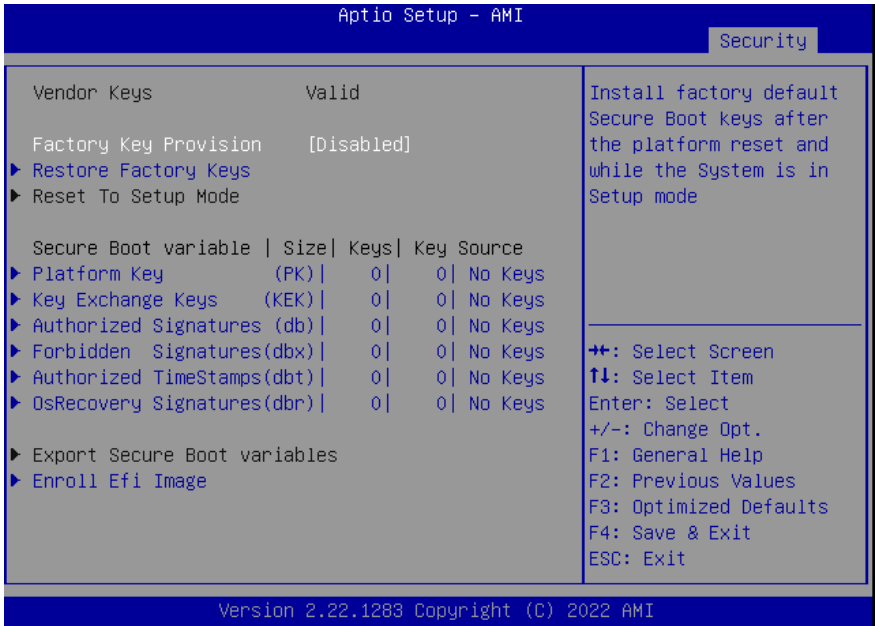

Options Summary		
Factory Key Provision	Disabled	Optimal Default, Failsafe Default
	Enabled	
Install factory default Secure Boot keys after the platform reset and while the System is in Setup mode		
Restore Factory Keys	Force System to User Mode. Install factory default Secure Boot key databases	
Enroll Efi Image	Allow Efi image to run in Secure Boot mode. Enroll SHA256 Hash certificate of a PE image into Authorized Signature Database (db)	

Secure Boot Variables

Enroll Factory Defaults or load certificates from a file:

1. Public Key Certificate in:
 - a) EFI_SIGNATURE_LIST
 - b) EFI_CERT_X509 (DER encoded)
 - c) EFI_CERT_RSA2048 (bin)
 - d) EFI_CERT_SHAXXX
2. Authenticated UEFI Variable
3. EFI PE/COFF Image (SHA256)

Key Source: Default, External, Mixed

3.7 Setup Submenu: Boot

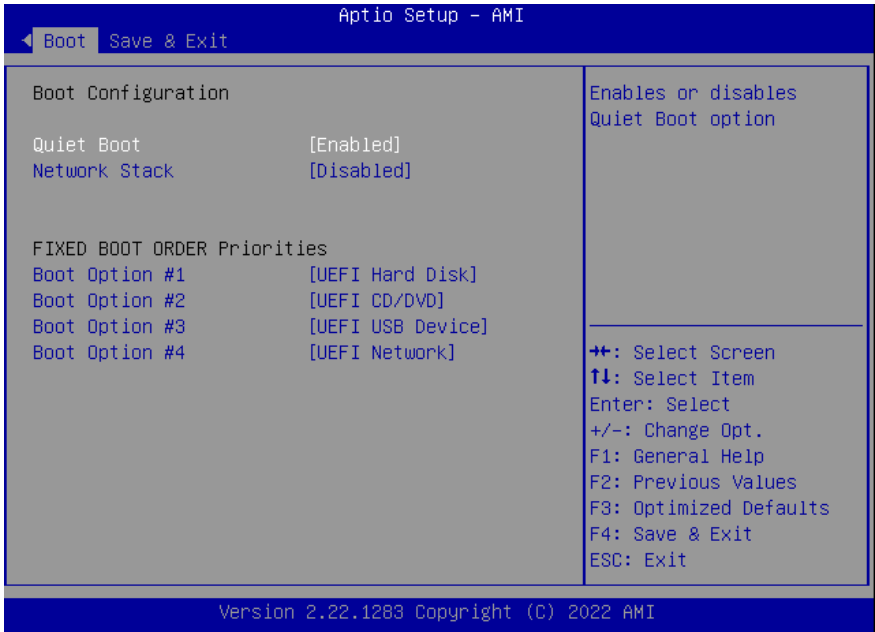

Options Summary		
Quiet Boot	Enabled	Optimal Default, Failsafe Default
	Disabled	
Enable or Disable Quiet Boot option.		
Network Stack	Enabled	
	Disabled	Optimal Default, Failsafe Default
Enable/Disable UEFI Network Stack.		

3.8 Setup Submenu: Save & Exit

