

# FWS-2272

---

Network Appliance

User's Manual 2<sup>nd</sup> Ed

## Copyright Notice

---

This document is copyrighted, 2018. All rights are reserved. The original manufacturer reserves the right to make improvements to the products described in this manual at any time without notice.

No part of this manual may be reproduced, copied, translated, or transmitted in any form or by any means without the prior written permission of the original manufacturer. Information provided in this manual is intended to be accurate and reliable. However, the original manufacturer assumes no responsibility for its use, or for any infringements upon the rights of third parties that may result from its use.

The material in this document is for product information only and is subject to change without notice. While reasonable efforts have been made in the preparation of this document to assure its accuracy, AAEMON assumes no liabilities resulting from errors or omissions in this document, or from the use of the information contained herein.

AAEMON reserves the right to make changes in the product design without notice to its users.

## Acknowledgement

---

All other products' name or trademarks are properties of their respective owners.

- Microsoft Windows is a registered trademark of Microsoft Corp.
- Intel, Pentium, Celeron, and Xeon are registered trademarks of Intel Corporation
- Core, Atom are trademarks of Intel Corporation
- ITE is a trademark of Integrated Technology Express, Inc.
- IBM, PC/AT, PS/2, and VGA are trademarks of International Business Machines Corporation.

All other product names or trademarks are properties of their respective owners.

## Packing List

---

Before setting up your product, please make sure the following items have been shipped:

| Item            | Quantity |
|-----------------|----------|
| ● FWS-2272      | 1        |
| ● Power adapter | 1        |

If any of these items are missing or damaged, please contact your distributor or sales representative immediately.

## About this Document

---

This User's Manual contains all the essential information, such as detailed descriptions and explanations on the product's hardware and software features (if any), its specifications, dimensions, jumper/connector settings/definitions, and driver installation instructions (if any), to facilitate users in setting up their product.

Users may refer to the [AAEON.com](http://AAEON.com) for the latest version of this document.

## Safety Precautions

---

Please read the following safety instructions carefully. It is advised that you keep this manual for future references

1. All cautions and warnings on the device should be noted.
2. All cables and adapters supplied by AAEON are certified and in accordance with the material safety laws and regulations of the country of sale. Do not use any cables or adapters not supplied by AAEON to prevent system malfunction or fires.
3. Make sure the power source matches the power rating of the device.
4. Position the power cord so that people cannot step on it. Do not place anything over the power cord.
5. Always completely disconnect the power before working on the system's hardware.
6. No connections should be made when the system is powered as a sudden rush of power may damage sensitive electronic components.
7. If the device is not to be used for a long time, disconnect it from the power supply to avoid damage by transient over-voltage.
8. Always disconnect this device from any AC supply before cleaning.
9. While cleaning, use a damp cloth instead of liquid or spray detergents.
10. Make sure the device is installed near a power outlet and is easily accessible.
11. Keep this device away from humidity.
12. Place the device on a solid surface during installation to prevent falls
13. Do not cover the openings on the device to ensure optimal heat dissipation.
14. Watch out for high temperatures when the system is running.
15. Do not touch the heat sink or heat spreader when the system is running
16. Never pour any liquid into the openings. This could cause fire or electric shock.

17. As most electronic components are sensitive to static electrical charge, be sure to ground yourself to prevent static charge when installing the internal components. Use a grounding wrist strap and contain all electronic components in any static-shielded containers.
18. If any of the following situations arises, please the contact our service personnel:
  - i. Damaged power cord or plug
  - ii. Liquid intrusion to the device
  - iii. Exposure to moisture
  - iv. Device is not working as expected or in a manner as described in this manual
  - v. The device is dropped or damaged
  - vi. Any obvious signs of damage displayed on the device
19. **DO NOT LEAVE THIS DEVICE IN AN UNCONTROLLED ENVIRONMENT WITH TEMPERATURES BEYOND THE DEVICE'S PERMITTED STORAGE TEMPERATURES (SEE CHAPTER 1) TO PREVENT DAMAGE.**

### **Warning!**



This device complies with Part 15 FCC Rules. Operation is subject to the following two conditions: (1) this device may not cause harmful interference, and (2) this device must accept any interference received including interference that may cause undesired operation.

### **Caution:**

*There is a danger of explosion if the battery is incorrectly replaced. Replace only with the same or equivalent type recommended by the manufacturer. Dispose of used batteries according to the manufacturer's instructions and your local government's recycling or disposal directives.*

### **Attention:**

*Il y a un risque d'explosion si la batterie est remplacée de façon incorrecte. Ne la remplacer qu'avec le même modèle ou équivalent recommandé par le constructeur. Recycler les batteries usées en accord avec les instructions du fabricant et les directives gouvernementales de recyclage.*



## China RoHS Requirements (CN)

产品中有毒有害物质或元素名称及含量

AAEON Embedded Box PC/ Industrial System

| 部件名称  | 有毒有害物质或元素 |           |           |                 |               |                 |
|---|-----------|-----------|-----------|-----------------|---------------|-----------------|
|   | 铅<br>(Pb) | 汞<br>(Hg) | 镉<br>(Cd) | 六价铬<br>(Cr(VI)) | 多溴联苯<br>(PBB) | 多溴二苯醚<br>(PBDE) |
| 印刷电路板<br>及其电子组件   | ○         | ○         | ○         | ○               | ○             | ○               |
| 外部信号<br>连接器及线材  | ○         | ○         | ○         | ○               | ○             | ○               |
| 外壳  | ○         | ○         | ○         | ○               | ○             | ○               |
| 中央处理器<br>与内存  | ○         | ○         | ○         | ○               | ○             | ○               |
| 硬盘  | ○         | ○         | ○         | ○               | ○             | ○               |
| 电源  | ○         | ○         | ○         | ○               | ○             | ○               |
| <p><b>O:</b> 表示该有毒有害物质在该部件所有均质材料中的含量均在 <b>SJ/T 11363-2006</b> 标准规定的限量要求以下。</p> <p><b>X:</b> 表示该有毒有害物质至少在该部件的某一均质材料中的含量超出 <b>SJ/T 11363-2006</b> 标准规定的限量要求。</p> <p><b>备注:</b></p> <p>一、此产品所标示之环保使用期限，系指在一般正常使用状况下。</p> <p>二、上述部件物质中央处理器、内存、硬盘、光驱、触控模块为选购品。</p> |           |           |           |                 |               |                 |

## China RoHS Requirement (EN)

Poisonous or Hazardous Substances or Elements in Products

AAEON Embedded Box PC/ Industrial System

| Component                                   | Poisonous or Hazardous Substances or Elements |              |              |                              |                                |                                       |
|---|---|--------------|--------------|------------------------------|--------------------------------|---------------------------------------|
|   | Lead (Pb)                                     | Mercury (Hg) | Cadmium (Cd) | Hexavalent Chromium (Cr(VI)) | Polybrominated Biphenyls (PBB) | Polybrominated Diphenyl Ethers (PBDE) |
| PCB & Other Components                      | ○   | ○            | ○            | ○                            | ○                              | ○                                     |
| Wires & Connectors for External Connections | ○   | ○            | ○            | ○                            | ○                              | ○                                     |
| Chassis                                     | ○   | ○            | ○            | ○                            | ○                              | ○                                     |
| CPU & RAM                                   | ○   | ○            | ○            | ○                            | ○                              | ○                                     |
| Hard Disk                                   | ○   | ○            | ○            | ○                            | ○                              | ○                                     |
| PSU   | ○   | ○            | ○            | ○                            | ○                              | ○                                     |

O: The quantity of poisonous or hazardous substances or elements found in each of the component's parts is below the SJ/T 11363-2006-stipulated requirement.

X: The quantity of poisonous or hazardous substances or elements found in at least one of the component's parts is beyond the SJ/T 11363-2006-stipulated requirement.

**Note: The Environment Friendly Use Period as labeled on this product is applicable under normal usage only**

## Table of Contents

---

|   |           |
|---|-----------|
| <b>Chapter 1 - Product Specifications .....</b>           | <b>1</b>  |
| 1.1 Specifications.....                                   | 2         |
| <b>Chapter 2 – Hardware Information .....</b>             | <b>5</b>  |
| 2.1 Dimensions .....                                      | 6         |
| 2.2 Jumpers and Connectors .....                          | 9         |
| 2.3 List of Jumpers .....                                 | 11        |
| 2.3.1 CMOS Setting Selection (CN2).....                   | 12        |
| 2.4 List of Connectors.....                               | 13        |
| 2.4.1 Digital I/O (CN9).....                              | 14        |
| 2.5 Installing the SATA DOM.....                          | 15        |
| <b>Chapter 3 - AMI BIOS Setup .....</b>                   | <b>18</b> |
| 3.1 System Test and Initialization.....                   | 19        |
| 3.2 AMI BIOS Setup.....                                   | 20        |
| 3.3 Setup Submenu: Main.....                              | 21        |
| 3.4 Setup Submenu: Advanced.....                          | 22        |
| 3.4.1 Advanced: Trusted Computing .....                   | 23        |
| 3.4.2 Advanced: CPU Configuration .....                   | 25        |
| 3.4.3 Advanced: SATA Drives .....                         | 27        |
| 3.4.4 Advanced: USB Configuration .....                   | 28        |
| 3.4.5 Advanced: Hardware Monitor .....                    | 29        |
| 3.4.6 Advanced: SIO Configuration.....                    | 30        |
| 3.4.6.1 SIO Configuration: Serial Port Configuration..... | 31        |
| 3.4.6.1.1 Serial Port Console Redirection.....            | 32        |
| 3.4.6.1.2 Console Redirection Settings.....               | 33        |
| 3.4.6.1.3 Legacy Console Redirection Settings.....        | 36        |

|                   |   |           |
|-------------------|---|-----------|
| 3.4.6.1.4         | Serial Port for Out-of-Band Management/Windows<br>Emergency Management Services (EMS) ..... | 37        |
| 3.4.7             | Advanced: Power Management.....   | 39        |
| 3.4.8             | Advanced: Digital I/O Port Configuration.....   | 41        |
| 3.4.9             | Status LED Configuration .....  | 42        |
| 3.5               | Setup submenu: Chipset .....  | 43        |
| 3.5.1             | Chipset: North Bridge.....  | 44        |
| 3.5.1.1           | North Bridge: AMI Graphic Output Protocol Policy .....                                      | 45        |
| 3.5.2             | SCC Configuration.....  | 46        |
| 3.6               | Setup submenu: Security.....  | 47        |
| 3.7               | Setup submenu: Boot.....  | 49        |
| 3.8               | Setup submenu: Exit .....   | 51        |
| <b>Chapter 4</b>  | <b>– Driver Installation .....</b>  | <b>52</b> |
| 4.1               | Driver Installation .....   | 53        |
| <b>Appendix A</b> | <b>- Watchdog Timer Programming.....</b>  | <b>54</b> |
| A.1               | Watchdog Timer Initial Program.....   | 55        |
| <b>Appendix B</b> | <b>- I/O Information .....</b>  | <b>61</b> |
| B.1               | I/O Address Map.....  | 62        |
| B.2               | Memory Address Map .....  | 64        |
| B.3               | IRQ Mapping Chart.....  | 65        |
| <b>Appendix C</b> | <b>- Standard LAN Bypass Platform Setting .....</b>   | <b>74</b> |
| C.1               | Status LED .....  | 75        |
| C.2               | LAN Bypass.....   | 78        |
| C.3               | Software Reset Button Configuration.....  | 81        |

# Chapter 1

---

Product Specifications

## 1.1 Specifications

---

### System

|                |  |
|----------------|--|
| Form Factor    | Desktop Network Appliance  |
| Processor      | Intel® Celeron® N3350 Processor SoC  |
| Chipset        | Intel® Celeron® N3350 Processor SoC  |
| System Memory  | Onboard LPDDR4 1GB memory. Optional BOM SKU supports 204-pin DDR3L SODIMM x 1, up to 8GB |
| Ethernet       | Intel® i211, Gigabit Ethernet x 4  |
| Bypass         | —  |
| HDD            | —  |
| CF/CFAST/MSATA | Onboard 8GB eMMC<br>SATA 6.0 Gb/s port x 1, for SATA DOM                                 |
| PCIe Slot      | —  |
| Mini-PCIe Slot | Mini-Card socket (full-size) with SIM socket x 1   |
| KB Mouse       | —  |
| USB            | USB 3.0 x 2  |
| RTC            | Internal RTC   |
| Watchdog Timer | 1~255 steps by software programmable   |
| TPM            | (TPM v1.2 9660/TPM2.0 9665 Optional)   |
| GPIO           | Reserve internal pin header 8-bit Digital I/O  |

|              |                         |
|--------------|-------------------------|
|              | interface (4-in /4-out) |
| Fan          | Fanless                 |
| MTBF (Hours) | 162,469                 |
| Color        | Silver                  |

## Display

|                    |                                    |
|--------------------|------------------------------------|
| Graphic Controller | Intel® HD Graphics 505 Intergrated |
| Connector          | —                                  |

## I/O

|             |   |
|-------------|---|
| Front Panel | Power LED x 1, Status LED x 1,<br>Storage Active LED x 1,<br>LAN LED x 8<br>USB 3.0 Port x 2, RJ-45 Port x 4,     |
| Rear Panel  | RJ-45 Console x 1,<br>12V DC Power Input x 1, Software Reset Button<br>x 1, Power Button x 1,<br>Antenna Hole x 2 |

## Environmental Parameters and Dimension

|                              |  |
|------------------------------|--|
| <b>Power Requirement</b>     | 12V DC Power in connector  |
| <b>Operating Temperature</b> | 32°F ~ 104°F (0°C ~ 40°C )   |
| <b>Storage Temperature</b>   | -4°F ~ 140°F (-20°C ~ 60°C)  |
| <b>Operating Humidity</b>    | 10%~80% relative humidity, non-condensing  |
| <b>Storage Humidity</b>      | 10%~80% @40°C; non-condensing  |
| <b>Vibration</b>             | 0.5 Grms/ 5 ~ 500Hz / operation (SATA DOM)<br>1.5 Grms/ 5 ~ 500Hz / non operation  |
| <b>Shock</b>                 | 10 G peak acceleration (11 m sec. duration),<br>operation<br>20 G peak acceleration (11 m sec. duration), non<br>operation |
| <b>Dimension (W x D x H)</b> | 6.1" x 3.62" x 1.26" (155mm x 92mm x 32mm)   |



# Chapter 2

---

Hardware Information

## 2.1 Dimensions

### System

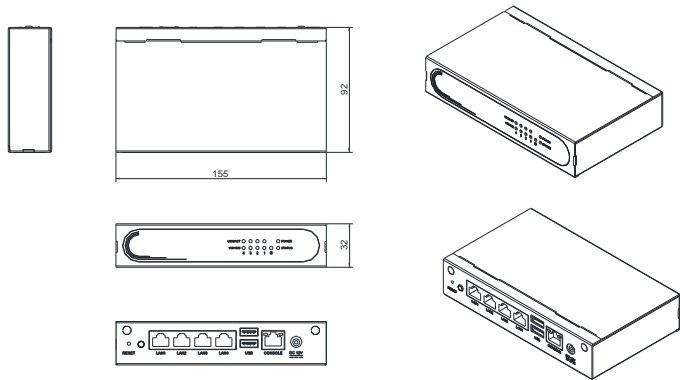

Board

Component Side

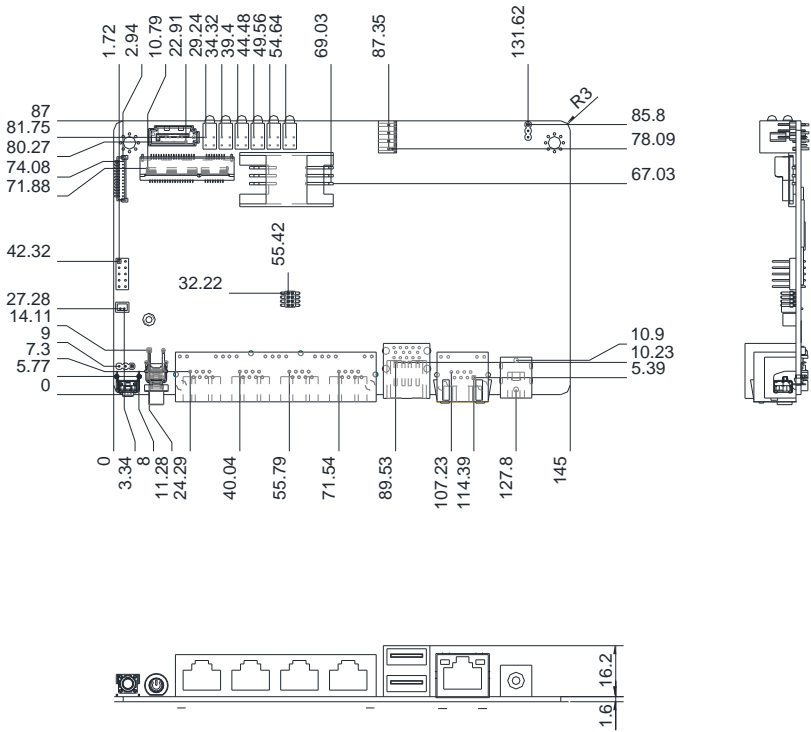

### Solder Side

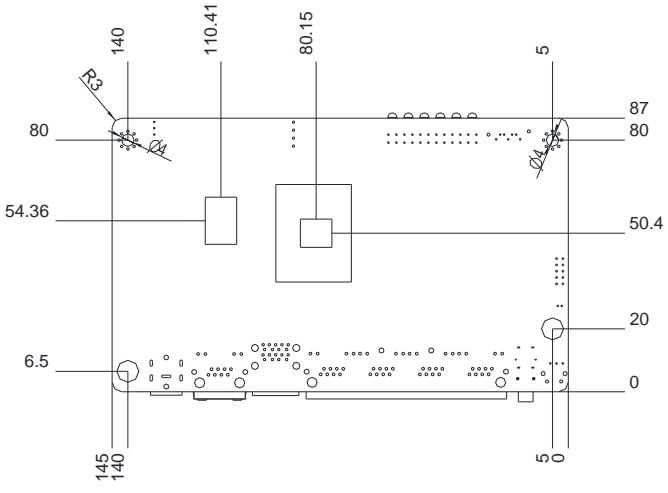

## 2.2 Jumpers and Connectors

### Component Side

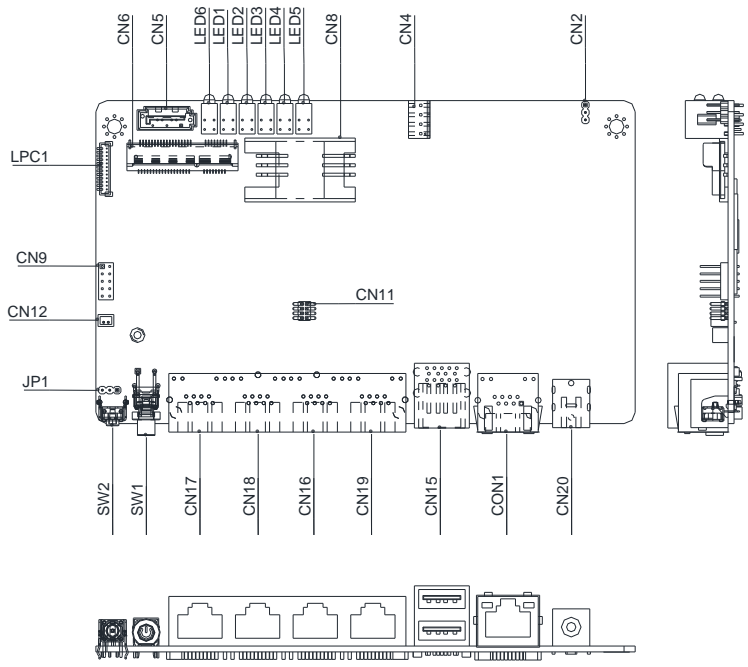

## Solder Side

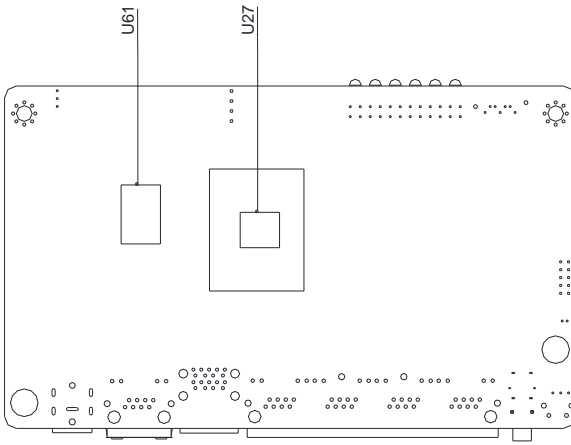

## 2.3 List of Jumpers

---

Please refer to the table below for all of the board's jumpers that you can configure for your application

| Label | Function               |
|-------|------------------------|
| CN2   | CMOS Setting Selection |

---

### 2.3.1 CMOS Setting Selection (CN2)

---



Normal (Default)



Clear CMOS



## 2.4 List of Connectors

---

Please refer to the table below for all of the board's connectors that you can configure for your application

| Label     | Function                       |
|-----------|--------------------------------|
| DIMM1     | DDR3L SODIMM SOCKET (Option)   |
| CON1      | RS-232                         |
| CN5       | SATA6G INTERFACE               |
| CN4       | SATA POWER                     |
| CN6       | Mini PCIe socket               |
| CN7/CN8   | SIM CARD SOCKET                |
| CN14      | RESET Pin Head (Option)        |
| CN13      | POWER BUTTON Pin Head (Option) |
| CN15      | USB3.0 DUAL Port               |
| CN9       | Digital I/O                    |
| CN16      | LAN1-4                         |
| SW2       | Software Reset                 |
| CN12      | Battery Socket                 |
| LED6      | POWER/Stats LED                |
| LED1      | HDD LED                        |
| LED2-LED5 | LAN1-LAN4 Link Stats LED       |
| CN3       | MICRO HDMI (Option)            |
| SW1       | POWER BUTTON                   |

## 2.4.1 Digital I/O (CN9)

---

This connector offers 4-pair of digital I/O functions and address is 801H. The pin definitions are illustrated below:

| Pin | Signal                        | Pin | Signal                        |
|-----|-------------------------------|-----|-------------------------------|
| 1   | Digital- IN/OUT(Port1 Bit 1)  | 2   | Digital- IN/OUT (Port1 Bit 2) |
| 3   | Digital- IN/OUT (Port1 Bit 4) | 4   | Digital- IN/OUT (Port1 Bit 5) |
| 5   | Digital- IN/OUT (Port3 Bit 4) | 6   | Digital- IN/OUT (Port3 Bit 5) |
| 7   | Digital- IN/OUT (Port6 Bit 3) | 8   | Digital- IN/OUT (Port4 Bit 7) |
| 9   | +5V                           | 10  | GND                           |

## 2.5 Installing the SATA DOM

---

1. Loosen and remove the screws from the top panel.



2. Remove the top panel.

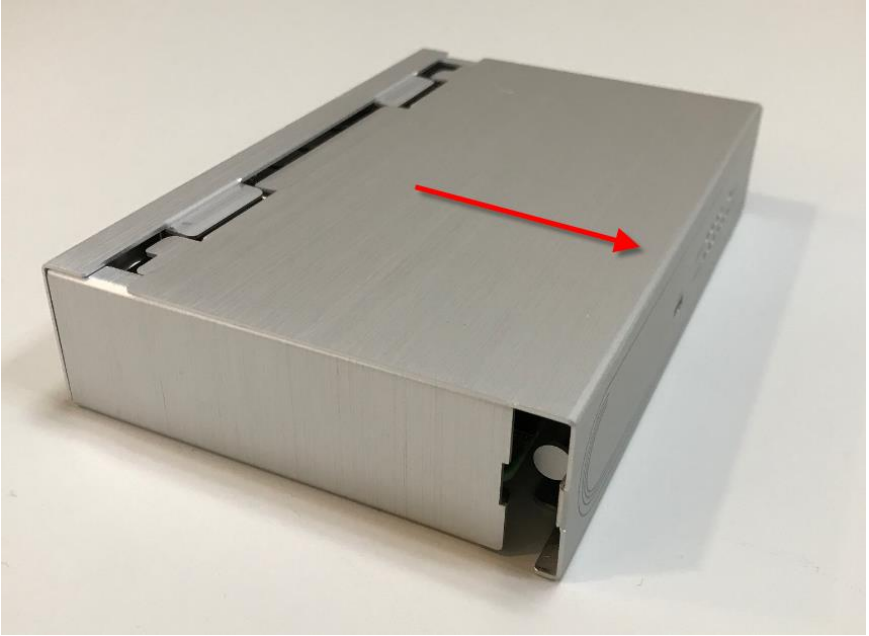

Step 3: Connect the SATA and power cables to the PCBA.

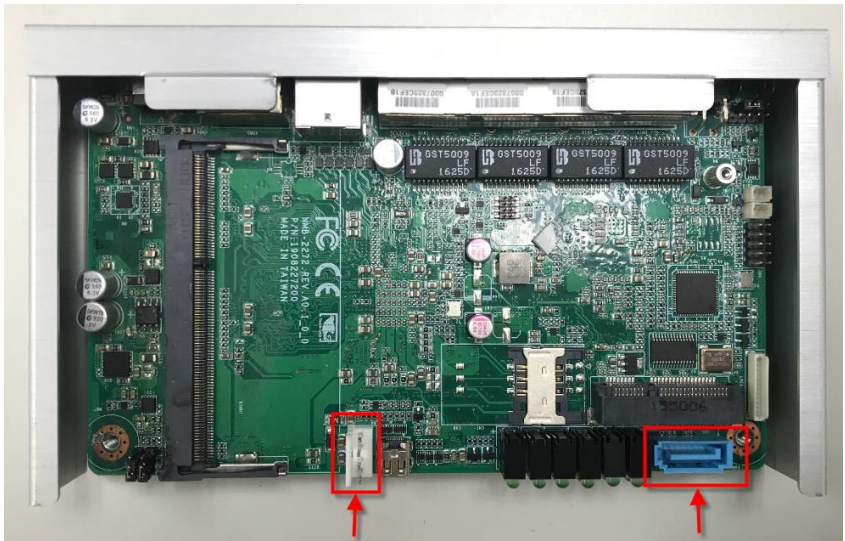

# Chapter 3

---

AMI BIOS Setup

## 3.1 System Test and Initialization

---

The system uses certain routines to perform testing and initialization. If an error, fatal or non-fatal, is encountered, a few short beeps or an error message will be outputted. The board can usually continue the boot up sequence with non-fatal errors.

The system configuration verification routines check the current system configuration against the values stored in the CMOS memory. If they do not match, an error message will be outputted, in which case you will need to run the BIOS setup program to set the configuration information in memory.

There are three situations in which you will need to change the CMOS settings:

- You are starting your system for the first time
- You have changed your system's hardware
- The CMOS memory has lost power and the configuration information is erased

The system's CMOS memory uses a backup battery for data retention, which is to be replaced once emptied.

Note: For Apollo Lake, Intel officially only supports its UEFI boot mode. Functionality for Legacy boot mode is not guaranteed since Intel will not provide any technical support.

For more detailed information about UEFI or Legacy boot mode, you can contact AAeon for a technical consult.

## 3.2 AMI BIOS Setup

---

The AMI BIOS ROM has a pre-installed Setup program that allows users to modify basic system configurations, which is stored in the battery-backed CMOS RAM and BIOS NVRAM so that the information is retained when the power is turned off.

To enter BIOS Setup, press <Del> or <F2> immediately while your computer is powering up.

The function for each interface can be found below.

**Main** – Date and time can be set here. Press <Tab> to switch between date elements

**Advanced** – Enable/ Disable boot option for legacy network devices

**Chipset** – For hosting bridge parameters

**Security** – The setup administrator password can be set here

**Boot** – Enable/ Disable quiet Boot Option

**Save & Exit** – Save your changes and exit the program



### 3.3 Setup Submenu: Main

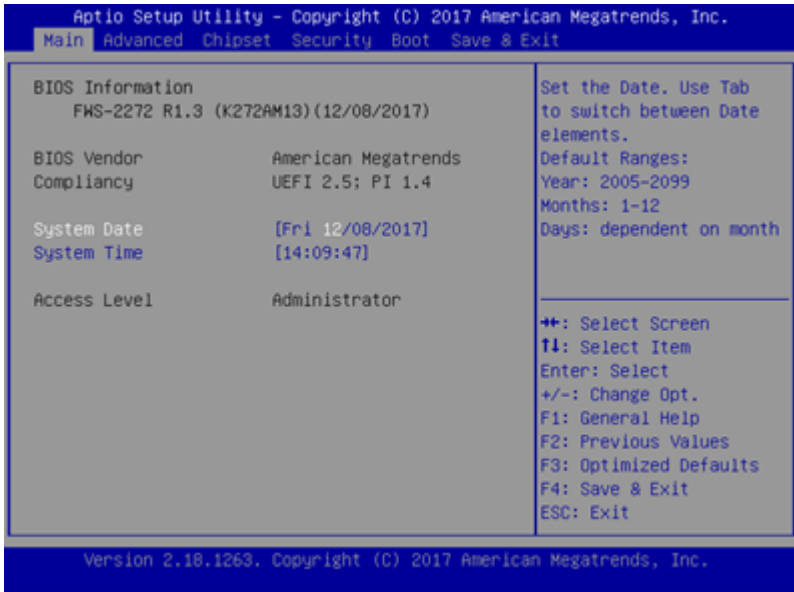

### 3.4 Setup Submenu: Advanced

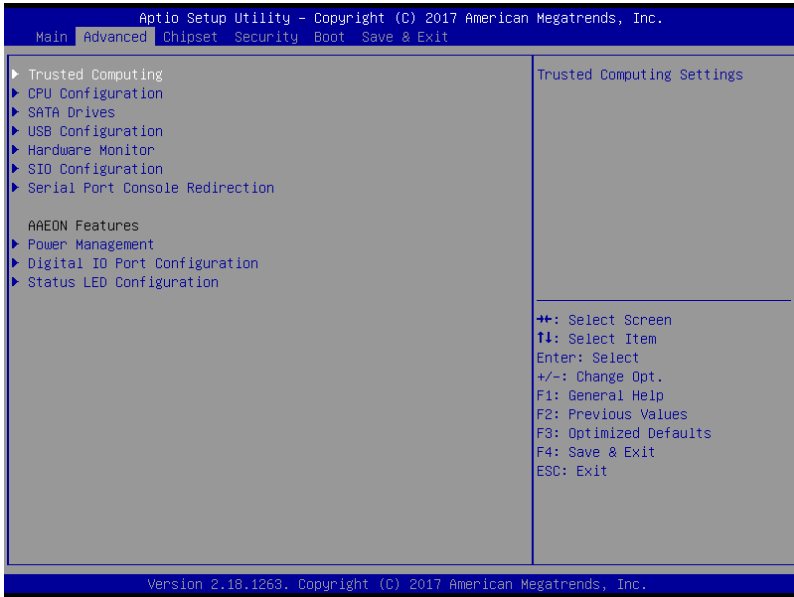

### 3.4.1 Advanced: Trusted Computing

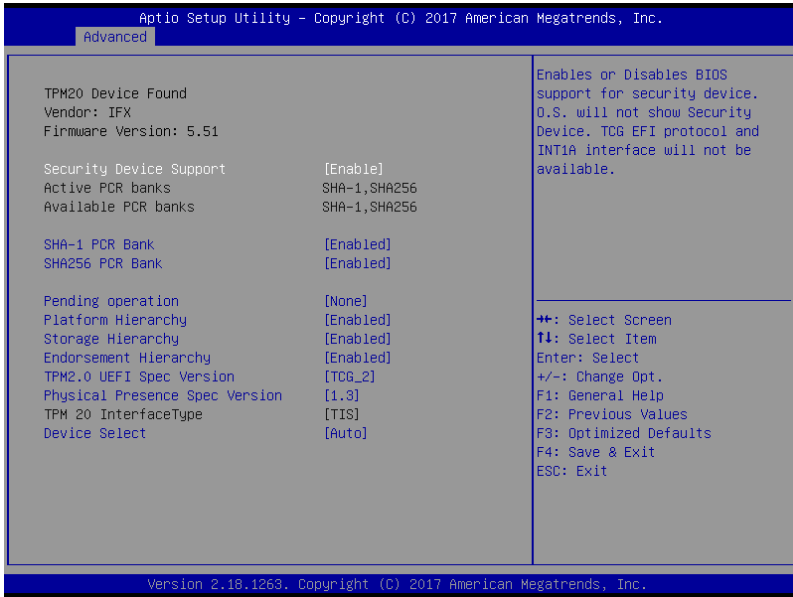

Options summary:

|   |                |
|---|----------------|
| Security Device Support   | Disabled       |
|   | <b>Enabled</b> |
| Enables or Disables BIOS support for security device. O.S. will not show Security Device. TCG EFI protocol and INT1A interface will not be available. |                |
| SHA-1 PCR Bank  | Disabled       |
|   | <b>Enabled</b> |
| Enable or Disable SHA-1 PCR Bank  |                |
| SHA256 PCR Bank   | Disabled       |
|   | <b>Enabled</b> |
| Enable or Disable SHA256 PCR Bank   |                |
| Pending operation   | <b>None</b>    |

|   |                |
|---|----------------|
|   | TPM Clear      |
| Schedule an Operation for the Security Device. NOTE: Your Computer will reboot during restart in order to change State of Security Device.  |                |
| Platform Hierarchy  | Disabled       |
|   | <b>Enabled</b> |
| Enable or Disable Platform Hierarchy  |                |
| Storage Hierarchy   | Disabled       |
|   | <b>Enabled</b> |
| Enable or Disable Storage Hierarchy   |                |
| Endorsement Hierarchy   | Disabled       |
|   | <b>Enabled</b> |
| Enable or Disable Endorsement Hierarchy   |                |
| TPM2.0 UEFI Spec Version  | TCG_1_2        |
|   | <b>TCG_2</b>   |
| Select the TCG2 Spec Version Support,<br>TCG_1_2: the Compatible mode for Win8/Win10,<br>TCG_2: Support new TCG2 protocol and event format for Win10 or later   |                |
| Physical Presence Spec Version  | 1.2            |
|   | <b>1.3</b>     |
| Select to Tell O.S. to support PPI Spec Version 1.2 or 1.3. Note some HCK tests might not support 1.3.  |                |
| Device Select   | TPM 1.2        |
|   | TPM 2.0        |
|   | <b>Auto</b>    |
| TPM 1.2 will restrict support to TPM 1.2 devices, TPM 2.0 will restrict support to TPM 2.0 devices, Auto will support both with the default set to TPM 2.0 devices if not found, TPM 1.2 devices will be enumerated |                |

### 3.4.2 Advanced: CPU Configuration

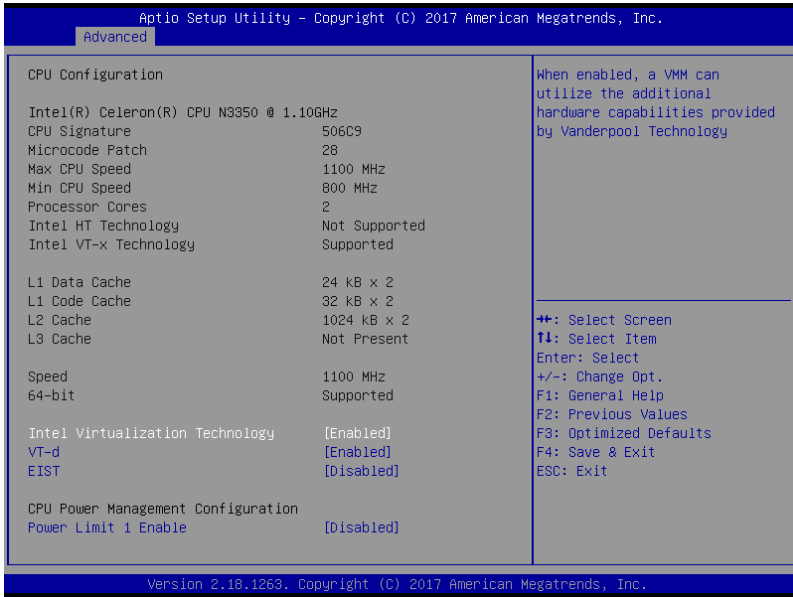

Options summary:

|  |          |
|--|----------|
| Intel Virtualization Technology  | Disabled |
|  | Enabled  |
| When enabled, a VMM can utilize the additional hardware capabilities provided by Vanderpool Technology |          |
| VT-d   | Disabled |
|  | Enabled  |
| Enable/Disable CPU VT-d  |          |
| EIST   | Disabled |
|  | Enabled  |
| Enable/Disable Intel SpeedStep   |          |
| Power Limit 1 Enable   | Disabled |

|                              |         |
|------------------------------|---------|
|                              | Enabled |
| Enable/Disable Power Limit 1 |         |

### 3.4.3 Advanced: SATA Drives

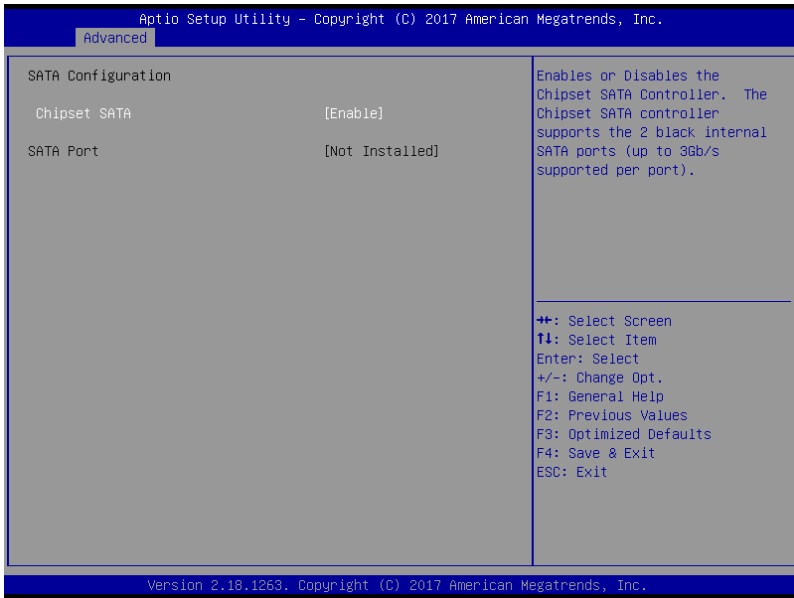

Options summary:

|   |                |
|---|----------------|
| Chipset SATA  | Disabled       |
|   | <b>Enabled</b> |
| Enables or Disables the Chipset SATA Controller. The Chipset SATA controller supports the 2 black internal SATA ports (up to 3Gb/s supported per port). |                |

### 3.4.4 Advanced: USB Configuration

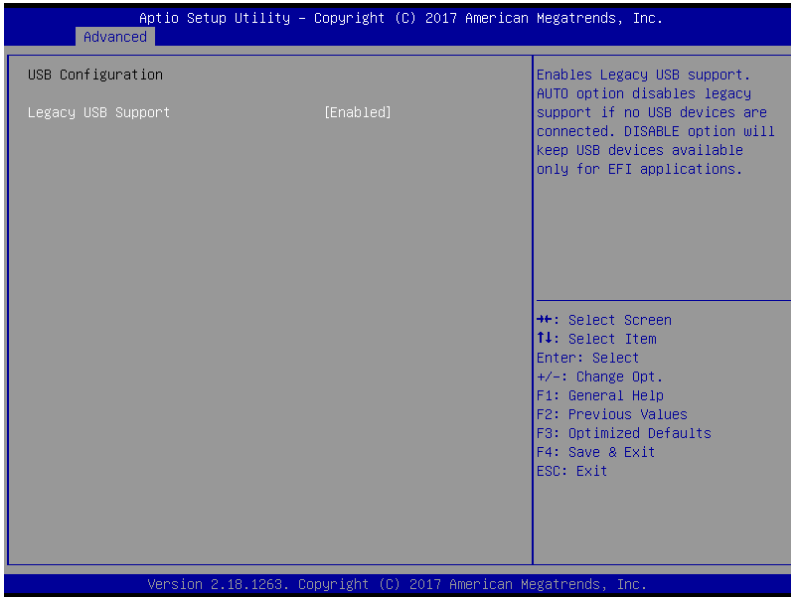

Options summary:

|  |          |
|--|----------|
| Legacy USB Support   | Disabled |
|  | Enabled  |
| Enables Legacy USB support. AUTO option disables legacy support if no USB devices are connected. DISABLE option will keep USB devices available only for EFI applications. |          |



### 3.4.5 Advanced: Hardware Monitor

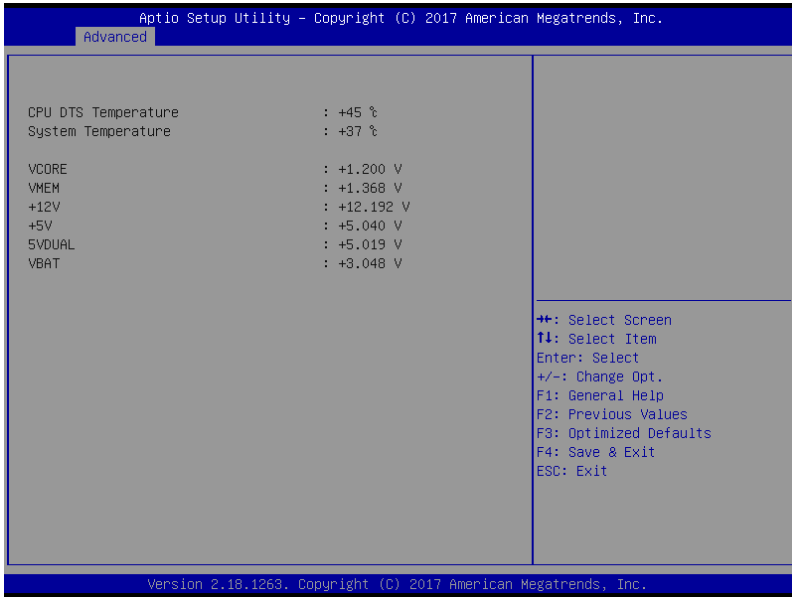

### 3.4.6 Advanced: SIO Configuration

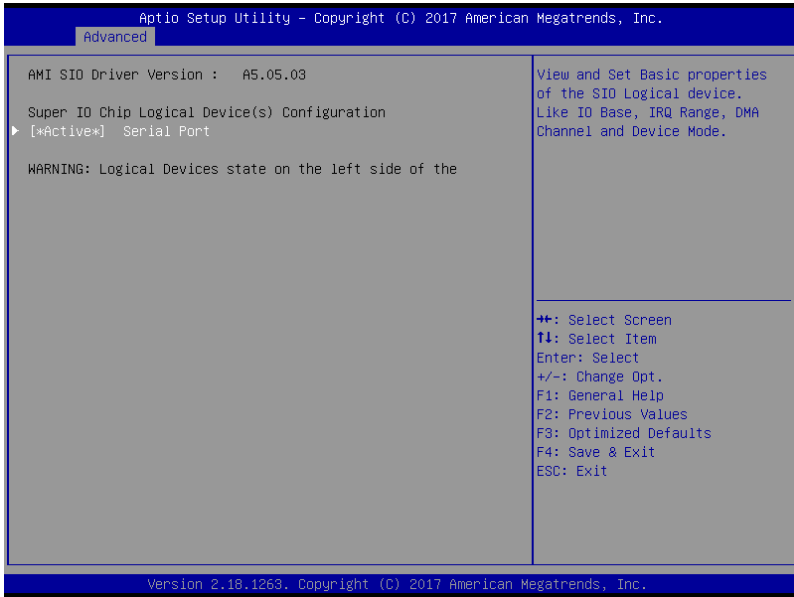

### 3.4.6.1 SIO Configuration: Serial Port Configuration

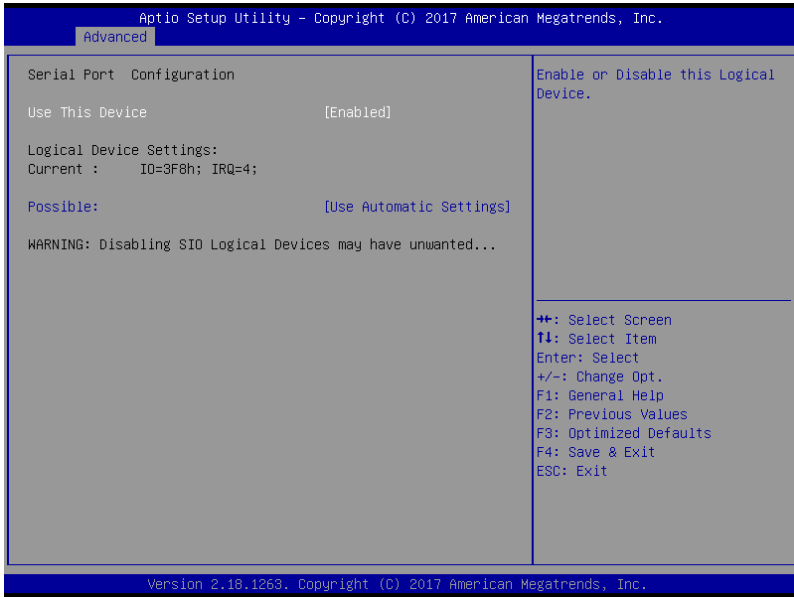

Options summary:

|  |                        |
|--|------------------------|
| Use This Device  | Disabled               |
|  | Enabled                |
| Enable or Disable this Logical Device.   |                        |
| Possible:  | Use Automatic Settings |
|  | IO=2F8h; IRQ=3;        |
|  | IO=3F8h; IRQ=4;        |
| Allows user to change Device's Resource settings. New settings will be reflected on This Setup Page after System restarts. |                        |

### 3.4.6.1.1 Serial Port Console Redirection

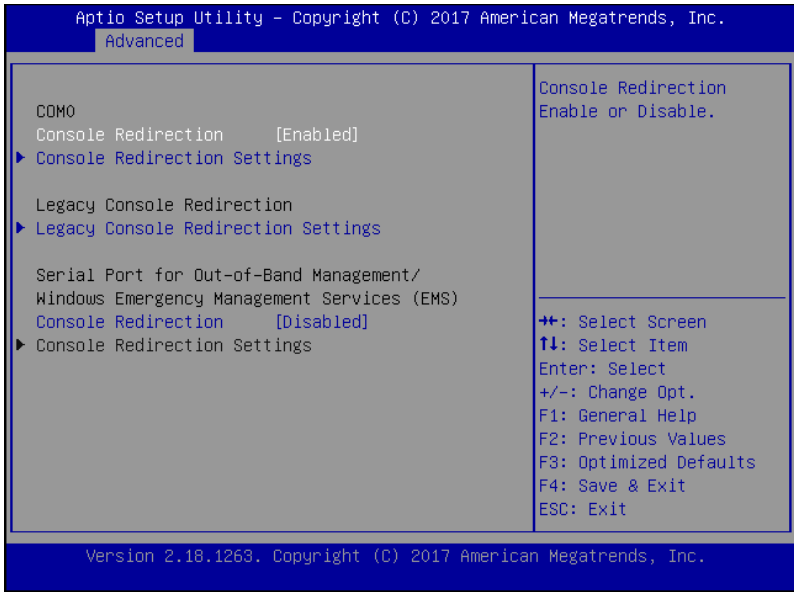

Options summary:

|  |          |
|--|----------|
| Console Redirection                      | Disabled |
|  | Enabled  |
| Console Redirection Enabled or Disabled. |          |

### 3.4.6.1.2 Console Redirection Settings

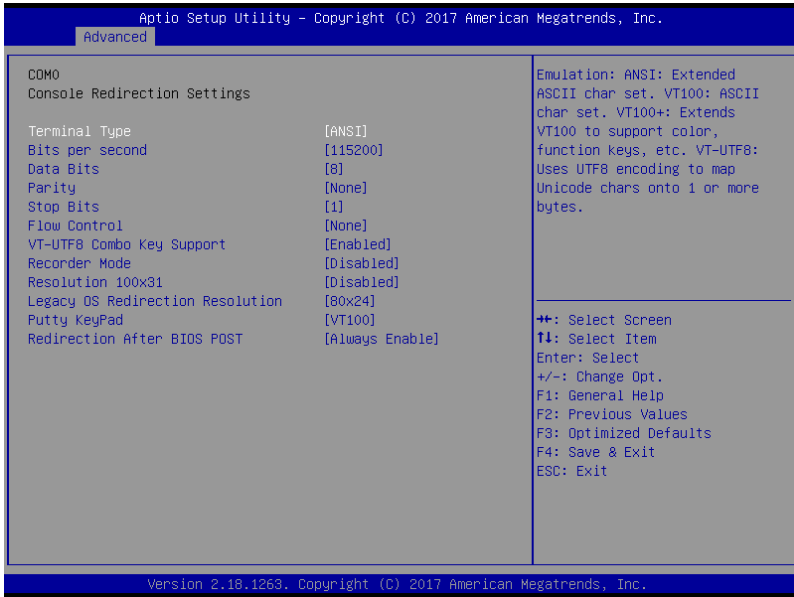

Options summary:

|   |         |
|---|---------|
| Terminal Type   | VT100   |
|   | VT100+  |
|   | VT-UTF8 |
|   | ANSI    |
| Emulation: ANSI: Extended ASCII char set. VT100: ASCII char set. VT100+: Extends VT100 to support color, function keys, etc. VT-UTF8: Uses UTF8 encoding to map Unicode chars onto 1 or more bytes. |         |
| Bits per second   | 9600    |
|   | 19200   |
|   | 38400   |
|   | 57600   |

|  |                  |
|--|------------------|
|  | <b>115200</b>    |
| Selects serial port transmission speed. The speed must be matched on the other side. Long or noisy lines may require lower speeds.   |                  |
| Data Bits  | 7                |
|  | <b>8</b>         |
| Data Bits  |                  |
| Parity   | <b>None</b>      |
|  | Even             |
|  | Odd              |
|  | Mark             |
|  | Space            |
| A parity bit can be sent with the data bits to detect some transmission errors. Even: parity bit is 0 if the num of 1's in the data bits is even. Odd: parity bit is 0 if num of 1's in the data bits is odd. Mark: parity bit is always 1. Space: Parity bit is always 0. Mark and Space Parity do not allow for error detection. |                  |
| Stop Bits  | <b>1</b>         |
|  | 2                |
| Stop bits indicate the end of a serial data packet. ( A start bit indicates the beginning). The standard setting is 1 stop bit. Communication with slow devices may require more than 1 stop bit.  |                  |
| Flow Control   | <b>None</b>      |
|  | Hardware RTS/CTS |
| Flow control can prevent data loss from buffer overflow. When sending data, if the receiving buffers are full, a 'stop' signal can be sent to stop the data flow. Once the buffers are empty, a 'start' signal can be sent to re-start the flow. Hardware flow control uses two wires to send start/stop signals.                  |                  |
| VT-UTF8 Combo Key Support  | Disabled         |

|  |                      |
|--|----------------------|
|  | <b>Enabled</b>       |
| Enable VT-UTF8 Combination Key Support for ANSI/VT100 terminals  |                      |
| Recorder Mode  | <b>Disabled</b>      |
|  | Enabled              |
| On this mode enabled only text will be send. This is to capture Terminal data.   |                      |
| Resolution 100x31  | <b>Disabled</b>      |
|  | Enabled              |
| Enables or disables extended terminal resolution   |                      |
| Legacy OS Redirection Resolution   | <b>80x24</b>         |
|  | 80x25                |
| On Legacy OS, the Number of Rows and Columns supported redirection   |                      |
| Putty KeyPad   | <b>VT100</b>         |
|  | LINUX                |
|  | XTERMR6              |
|  | SCO                  |
|  | ESCN                 |
|  | VT400                |
| Select FunctionKey and KeyPad on Putty.  |                      |
| Redirection After BIOS POST  | <b>Always Enable</b> |
|  | BootLoader           |
| The Setting Specify if BootLoader is selected than Legacy console redirection is disabled before booting to Legacy OS. Default value is Always Enable which means Legacy console Redirection is enabled for Legacy OS. |                      |

### 3.4.6.1.3 Legacy Console Redirection Settings

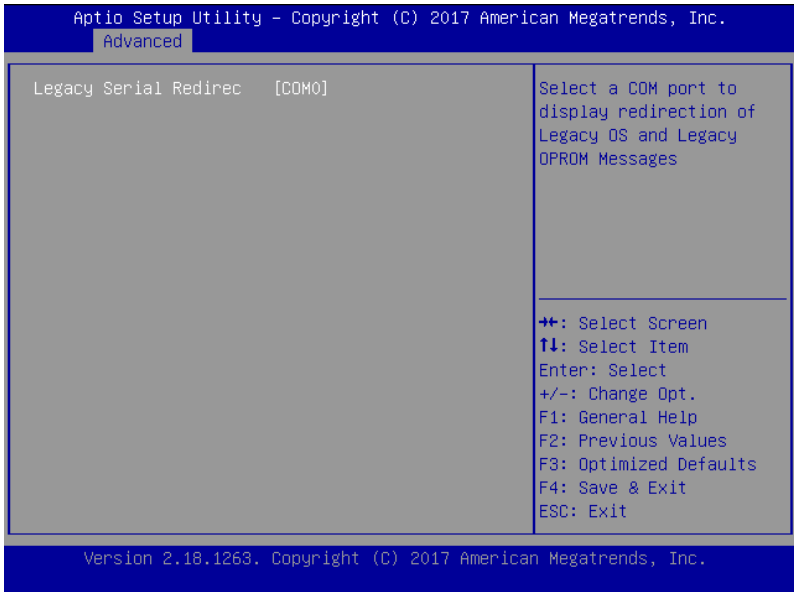

|   |      |
|---|------|
| Legacy Serial Redirection Port  | COM0 |
| Select a COM port to display redirection of Legacy OS and Legacy OPRM Messages. (Default only support first COM Port) |      |



### 3.4.6.1.4 Serial Port for Out-of-Band Management/Windows Emergency Management Services (EMS)

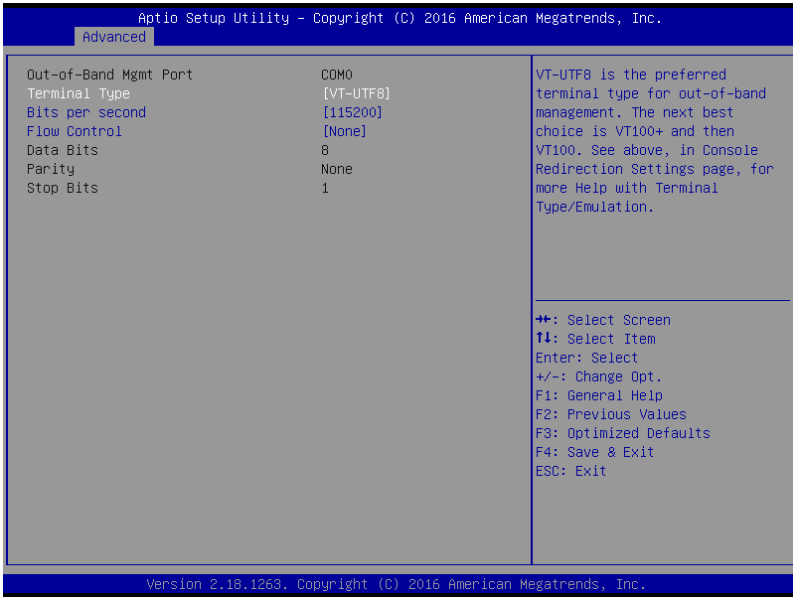

Options summary:

|  |                |
|--|----------------|
| Terminal Type  | VT100          |
|  | VT100+         |
|  | <b>VT-UTF8</b> |
|  | ANSI           |
| VT-UTF8 is the preferred terminal type for out-of-band management. The next best choice is VT100+ and then VT100. See above, in Console Redirection Settings page, for more Help with Terminal Type/Emulation. |                |
| Bits per second  | 9600           |
|  | 19200          |
|  | 57600          |

|  |                   |
|--|-------------------|
|  | <b>115200</b>     |
| Selects serial port transmission speed. The speed must be matched on the other side. Long or noisy lines may require lower speeds.   |                   |
| Flow Control   | <b>None</b>       |
|  | Hardware RTS/CTS  |
|  | Software Xon/Xoff |
| Flow control can prevent data loss from buffer overflow. When sending data, if the receiving buffers are full, a 'stop' signal can be sent to stop the data flow. Once the buffers are empty, a 'start' signal can be sent to re-start the flow. Hardware flow control uses two wires to send start/stop signals.                  |                   |
| Data Bits  | 7                 |
|  | <b>8</b>          |
| Data Bits  |                   |
| Parity   | <b>None</b>       |
|  | Even              |
|  | Odd               |
|  | Mark              |
|  | Space             |
| A parity bit can be sent with the data bits to detect some transmission errors. Even: parity bit is 0 if the num of 1's in the data bits is even. Odd: parity bit is 0 if num of 1's in the data bits is odd. Mark: parity bit is always 1. Space: Parity bit is always 0. Mark and Space Parity do not allow for error detection. |                   |
| Stop Bits  | 1                 |
|  | 2                 |
| Stop bits indicate the end of a serial data packet. ( A start bit indicates the beginning). The standard setting is 1 stop bit. Communication with slow devices may require more than 1 stop bit.  |                   |

### 3.4.7 Advanced: Power Management

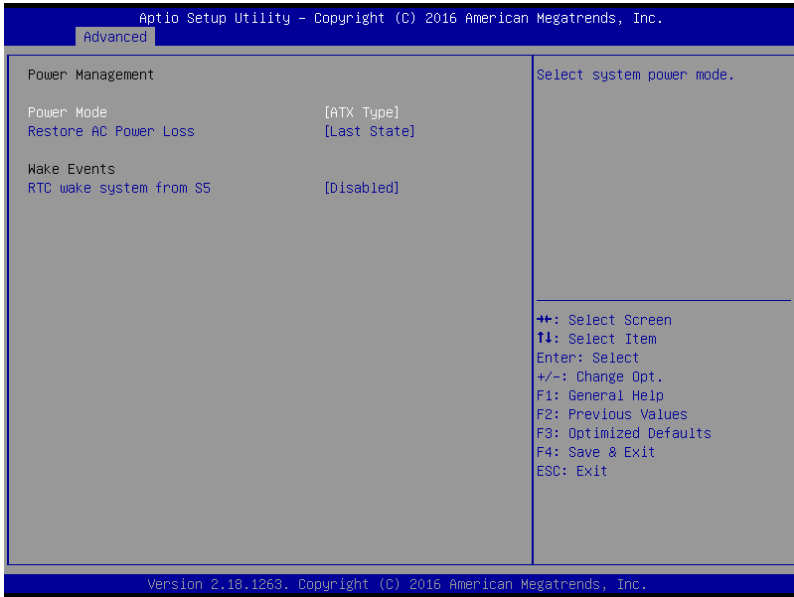

Options summary:

|   |              |
|---|--------------|
| Power Mode  | ATX Type     |
|   | AT Type      |
| Select Power Supply Mode.   |              |
| Restore AC Power Loss   | Power Off    |
|   | Power On     |
|   | Last State   |
| Select AC power state when power is re-applied after a power failure. |              |
| RTC Wake system from S5   | Disabled     |
|   | Fixed time   |
|   | Dynamic time |

|   |   |
|---|---|
| Fixed Time: System will wake on the hr::min::sec specified.   |   |
| Dynamic Time: System will wake on the current time + Increase minute(s)                                   |   |
| Wake up day (Fixed time option)   | 0 |
| Select 0 for daily system wake up, 1-31 for which day of month that you would like the system to wake up. |   |
| Wake up hour (Fixed time option)  | 0 |
| Select 0-23 For example enter 3 for 3am and 15 for 3pm.   |   |
| Wake up minute (Fixed time option)  | 0 |
| 0-59  |   |
| Wake up second (Fixed time option)  | 0 |
| 0-59  |   |
| Wake up minute increase (Dynamic time option)   | 1 |
| 1-5   |   |

### 3.4.8 Advanced: Digital I/O Port Configuration

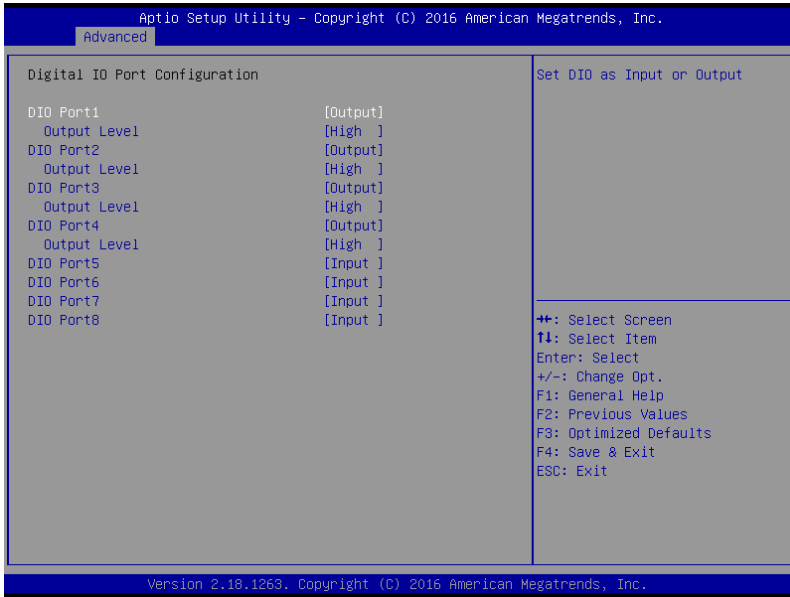

|   |        |
|---|--------|
| DIO_P#1~4                               | Input  |
|   | Output |
| Set DIO as Input or Output              |        |
| DIO_P#5~8                               | Input  |
|   | Output |
| Set DIO as Input or Output              |        |
| DIO_P#1~4 Direction                     | Low    |
|   | High   |
| Set output level when DIO pin is output |        |

### 3.4.9 Status LED Configuration

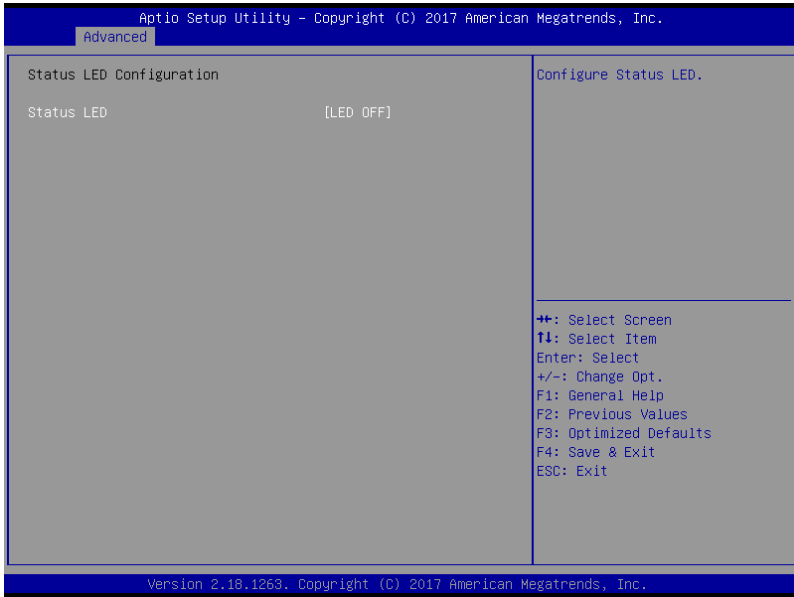

|                      |                      |
|----------------------|----------------------|
| Status LED           | <b>LED OFF</b>       |
|                      | RED LED ON           |
|                      | RED LED BLINK        |
|                      | RED LED FAST BLINK   |
|                      | GREEN LED ON         |
|                      | GREEN LED BLINK      |
|                      | GREEN LED FAST BLINK |
| Configure Status LED |                      |

### 3.5 Setup submenu: Chipset

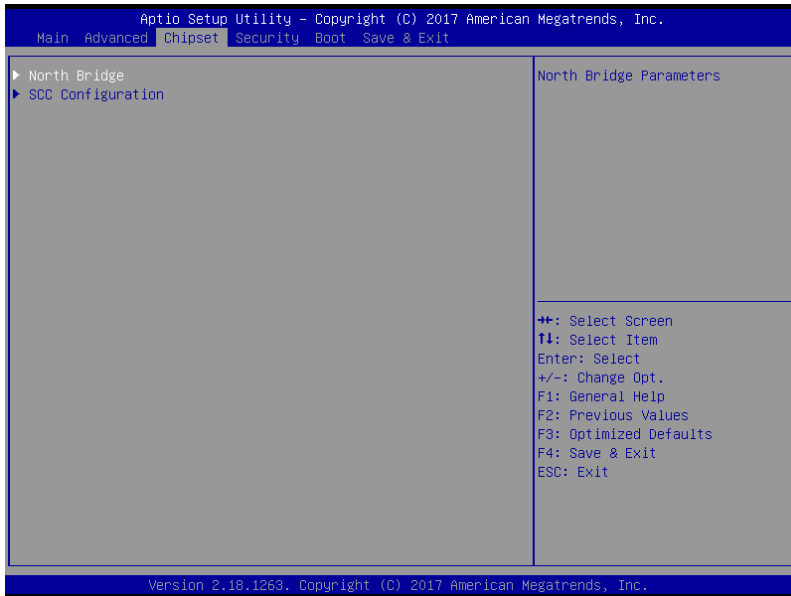

### 3.5.1 Chipset: North Bridge

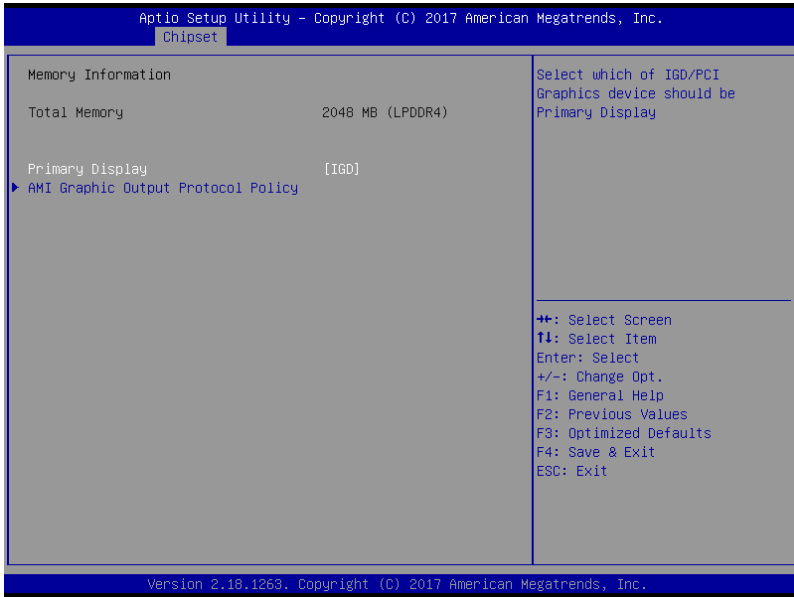

Options summary:

|   |      |
|---|------|
| Primary Display   | IGD  |
|   | PCIe |
| Select which of IGD/PCI Graphics device should be Primary Display |      |



### 3.5.1.1 North Bridge: AMI Graphic Output Protocol Policy

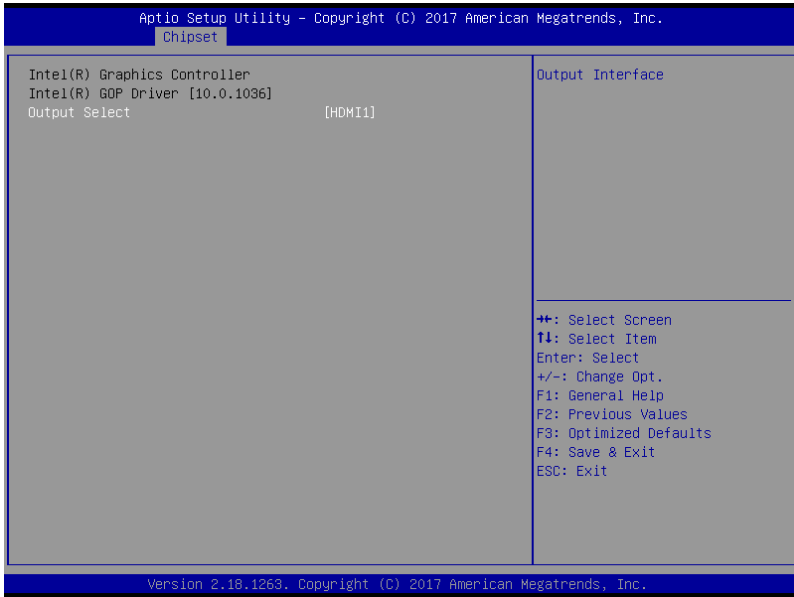

Options summary:

|                  |       |
|------------------|-------|
| Output Select    | HDMI1 |
| Output Interface |       |

### 3.5.2 SCC Configuration



Options summary:

|                                    |               |
|------------------------------------|---------------|
| SCC eMMC Support (D28:F0)          | <b>Enable</b> |
|                                    | Disable       |
| Enable/Disable SCC eMMC Support    |               |
| eMMC Max Speed                     | <b>HS400</b>  |
|                                    | HS200         |
|                                    | DDR50         |
| Select the eMMC max Speed allowed. |               |

## 3.6 Setup submenu: Security

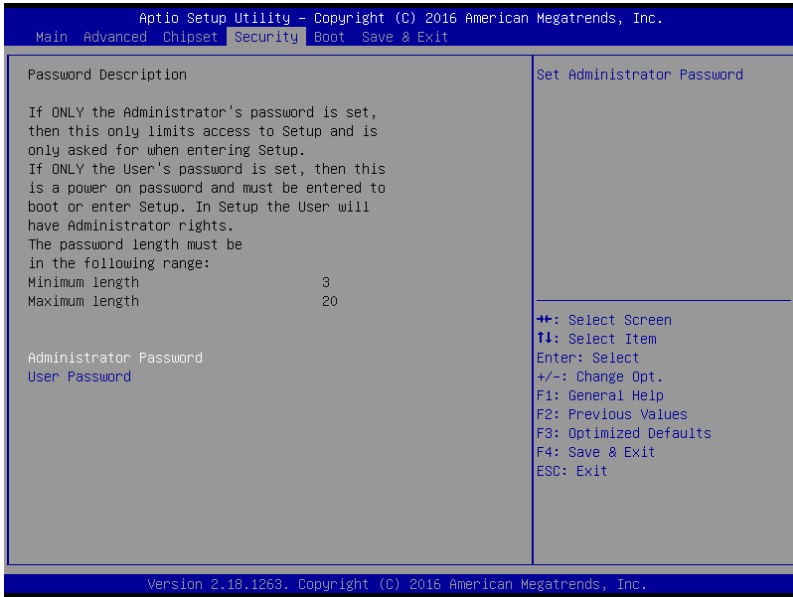

### Change User/Administrator Password

You can set passwords to limit BIOS access -

After installing an Administrator password, you will then be able to install a User password. A user password does not provide access to many of the features in the Setup utility.

If you highlight these items and press Enter, a dialog box will appear in which you can enter a password. Press Enter after you have typed in the password. A second dialog box will ask you to retype the password for confirmation. Press Enter after you have retyped it. The password is required at boot time, or when the user enters the Setup utility.

## Removing the Password

Highlight this item and type in the current password. When the next dialog box appears, press Enter to disable password protection.

### 3.7 Setup submenu: Boot

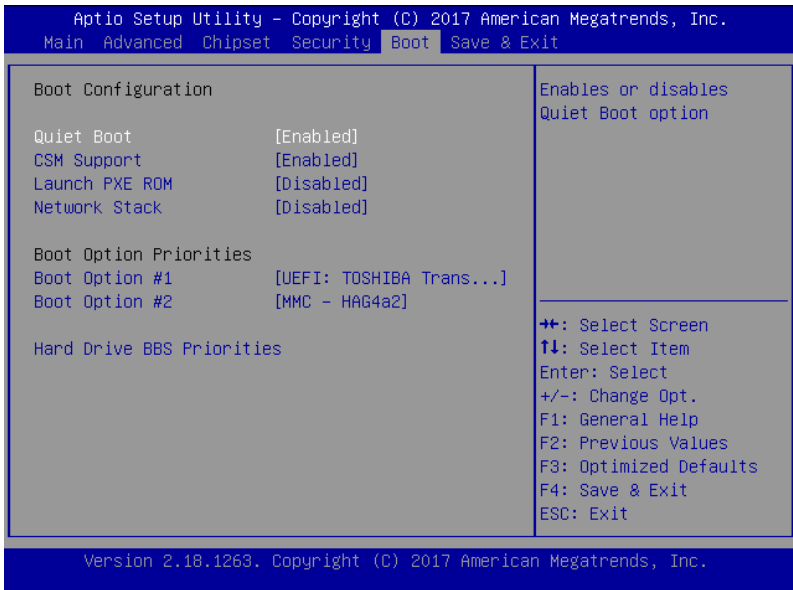

Options summary:

|  |          |
|--|----------|
| Quiet Boot                                 | Disabled |
|  | Enabled  |
| Enables or disables Quiet Boot option.     |          |
| CSM Support                                | Disabled |
|  | Enabled  |
| Enable/Disable Support                     |          |
| Launch PXE ROM                             | Disabled |
|  | Enabled  |
| Controls the execution of Legacy PXE OpROM |          |
| Network Stack                              | Disabled |
|  | Enabled  |

Enable/Disable UEFI Network Stack

### 3.8 Setup submenu: Exit

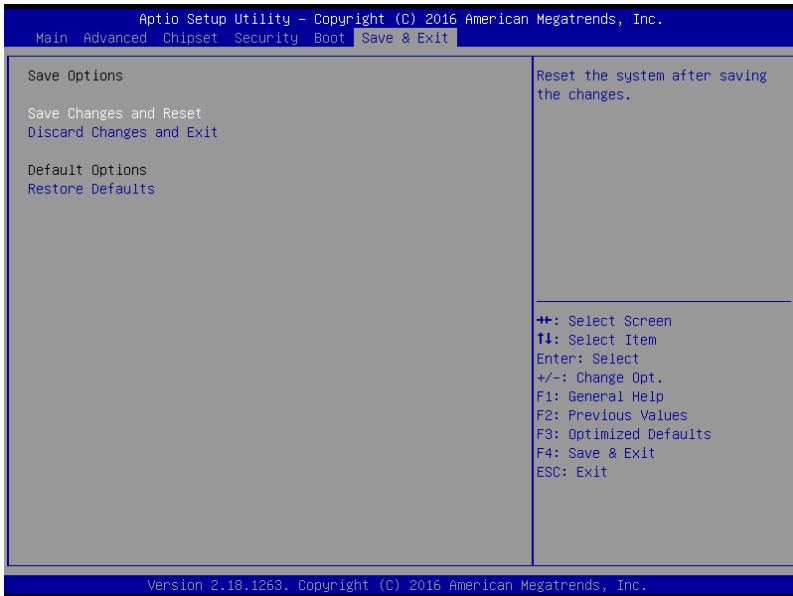

# Chapter 4

---

Driver Installation



## 4.1 Driver Installation

---

Please download the driver from AAeon website. It contains all the drivers and utilities you need to set up your product. Follow the steps below to install the driver.

<http://www.aaeon.com/en/p/desktop-network-appliance-fws-2272>

### Step 1 – Install LAN Driver

1. Open the **Step 1 – LAN** file
2. Unzip the `igb-5.3.5.12.tar.gz` file
3. Follow the “readme” to install

# Appendix A

---

## Watchdog Timer Programming

## A.1 Watchdog Timer Initial Program

|       | Default Value | Note   |
|-------|---------------|--|
| Index | 0x2E(Note1)   | SIO MB PnP Mode Index Register<br>0x2E or 0x4E |
| Data  | 0x2F(Note2)   | SIO MB PnP Mode Data Register<br>0x2F or 0x4F  |

|                        | LDN          | Register     | BitNum    | Value     | Note   |
|------------------------|--------------|--------------|-----------|-----------|--|
| Timer Counter          | 0x07(Note3)  | 0x73(Note4)  |           | (Note24)  | Time of watchdog timer (0~255)<br>This register is byte access |
| Counting Unit          | 0x07(Note5)  | 0x72(Note6)  | 7(Note7)  | 1(Note8)  | Select time unit.<br>1: second<br>0: minute                    |
| Watchdog Enable (KRST) | 0x07(Note9)  | 0x72(Note10) | 6(Note11) | 1(Note12) | 0: Disable<br>1: Enable  |
| Timeout Status         | 0x07(Note13) | 0x71(Note14) | 0(Note15) | 1         | 1: Clear timeout status  |

```
*****
// SuperIO relative definition (Please reference to Table 1)
#define byte   SIOIndex //This parameter is represented from Note1
#define byte   SIOData //This parameter is represented from Note2
#define void   IOWriteByte(byte IOPort, byte Value);
#define byte   IOReadByte(byte IOPort);
// Watch Dog relative definition (Please reference to Table 2)
#define byte   TimerLDN //This parameter is represented from Note3
#define byte   TimerReg //This parameter is represented from Note4
#define byte   TimerVal // This parameter is represented from Note24
#define byte   UnitLDN //This parameter is represented from Note5
#define byte   UnitReg //This parameter is represented from Note6
#define byte   UnitBit //This parameter is represented from Note7
#define byte   UnitVal //This parameter is represented from Note8
#define byte   EnableLDN //This parameter is represented from Note9
#define byte   EnableReg //This parameter is represented from Note10
#define byte   EnableBit //This parameter is represented from Note11
#define byte   EnableVal //This parameter is represented from Note12
#define byte   StatusLDN // This parameter is represented from Note13
#define byte   StatusReg // This parameter is represented from Note14
#define byte   StatusBit // This parameter is represented from Note15
*****
```

```
*****
VOID Main(){
    // Procedure : AaeonWDTConfig
    // (byte)Timer : Time of WDT timer.(0x00~0xFF)
    // (boolean)Unit : Select time unit(0: second, 1: minute).
    AaeonWDTConfig();

    // Procedure : AaeonWDTEnable
    // This procedure will enable the WDT counting.
    AaeonWDTEnable();
}
*****
```

```
*****
// Procedure : AaeonWDTEnable
VOID  AaeonWDTEnable (){
    WDTEnableDisable(EnableLDN, EnableReg, EnableBit, 1);
}

// Procedure : AaeonWDTConfig
VOID  AaeonWDTConfig (){
    // Disable WDT counting
    WDTEnableDisable(EnableLDN, EnableReg, EnableBit, 0);
    // Clear Watchdog Timeout Status
    WDTClearTimeoutStatus();
    // WDT relative parameter setting
    WDTParameterSetting();
}

VOID  WDTEnableDisable(byte LDN, byte Register, byte BitNum, byte Value){
    SIOBitSet(LDN, Register, BitNum, Value);
}

VOID  WDTParameterSetting(){
    // Watchdog Timer counter setting
    SIOByteSet(TimerLDN, TimerReg, TimerVal);
    // WDT counting unit setting
    SIOBitSet(UnitLDN, UnitReg, UnitBit, UnitVal);
}

VOID  WDTClearTimeoutStatus(){
    SIOBitSet(StatusLDN, StatusReg, StatusBit, 1);
}
*****
```

```
*****
VOID SIOEnterMBPnPMode0{
    Switch(SIOIndex){
        Case 0x2E:
            IOWriteByte(SIOIndex, 0x87);
            IOWriteByte(SIOIndex, 0x01);
            IOWriteByte(SIOIndex, 0x55);
            IOWriteByte(SIOIndex, 0x55);
            Break;
        Case 0x4E:
            IOWriteByte(SIOIndex, 0x87);
            IOWriteByte(SIOIndex, 0x01);
            IOWriteByte(SIOIndex, 0x55);
            IOWriteByte(SIOIndex, 0xAA);
            Break;
    }
}

VOID SIOExitMBPnPMode0{
    IOWriteByte(SIOIndex, 0x02);
    IOWriteByte(SIOData, 0x02);
}

VOID SIOSelectLDN(byte LDN){
    IOWriteByte(SIOIndex, 0x07); // SIO LDN Register Offset = 0x07
    IOWriteByte(SIOData, LDN);
}
*****
```

```
*****
VOID  SIOBitSet(byte LDN, byte Register, byte BitNum, byte Value){
    Byte TmpValue;

    SIOEnterMBPnPMode();
    SIOSelectLDN(byte LDN);
    IOWriteByte(SIOIndex, Register);
    TmpValue = IOReadByte(SIOData);
    TmpValue &= ~(1 << BitNum);
    TmpValue |= (Value << BitNum);
    IOWriteByte(SIOData, TmpValue);
    SIOExitMBPnPMode();
}

VOID  SIOByteSet(byte LDN, byte Register, byte Value){
    SIOEnterMBPnPMode();
    SIOSelectLDN(LDN);
    IOWriteByte(SIOIndex, Register);
    IOWriteByte(SIOData, Value);
    SIOExitMBPnPMode();
}
*****
```



# Appendix B

---

I/O Information

## B.1 I/O Address Map



















































| Input/output (I/O)  |   |
|---------------------|---|
| [0000000000000000]  | PCI Express Root Complex  |
| [0000000000000020]  | Programmable interrupt controller                                     |
| [0000000000000024]  | Programmable interrupt controller                                     |
| [0000000000000028]  | Programmable interrupt controller                                     |
| [000000000000002C]  | Programmable interrupt controller                                     |
| [000000000000002E]  | Motherboard resources   |
| [0000000000000030]  | Programmable interrupt controller                                     |
| [0000000000000034]  | Programmable interrupt controller                                     |
| [0000000000000038]  | Programmable interrupt controller                                     |
| [000000000000003C]  | Programmable interrupt controller                                     |
| [0000000000000040]  | System timer  |
| [000000000000004E]  | Motherboard resources   |
| [0000000000000050]  | System timer  |
| [0000000000000060]  | Standard PS/2 Keyboard  |
| [0000000000000061]  | Motherboard resources   |
| [0000000000000063]  | Motherboard resources   |
| [0000000000000064]  | Standard PS/2 Keyboard  |
| [0000000000000065]  | Motherboard resources   |
| [0000000000000067]  | Motherboard resources   |
| [0000000000000070]  | Motherboard resources   |
| [0000000000000070]  | System CMOS/real time clock   |
| [0000000000000078]  | PCI Express Root Complex  |
| [0000000000000080]  | Motherboard resources   |
| [0000000000000092]  | Motherboard resources   |
| [00000000000000A0]  | Programmable interrupt controller                                     |
| [00000000000000A4]  | Programmable interrupt controller                                     |
| [00000000000000A8]  | Programmable interrupt controller                                     |
| [00000000000000AC]  | Programmable interrupt controller                                     |
| [00000000000000B0]  | Programmable interrupt controller                                     |
| [00000000000000B2]  | Motherboard resources   |
| [00000000000000B4]  | Programmable interrupt controller                                     |
| [00000000000000B8]  | Programmable interrupt controller                                     |
| [00000000000000BC]  | Programmable interrupt controller                                     |
| [00000000000003F8]  | Communications Port (COM1)  |
| [0000000000000400]  | Motherboard resources   |
| [00000000000004D0]  | Programmable interrupt controller                                     |
| [0000000000000500]  | Motherboard resources   |
| [0000000000000680]  | Motherboard resources   |
| [0000000000000A00]  | Motherboard resources   |
| [0000000000000A30]  | Motherboard resources   |
| [0000000000000A40]  | Motherboard resources   |
| [0000000000000D00]  | PCI Express Root Complex  |
| [00000000000009000] | PCI-to-PCI Bridge   |
| [00000000000009000] | Intel(R) Celeron(R)/Pentium(R) Processor PCI Express Root Port - 5ADB |
| [00000000000009000] | PCI-to-PCI Bridge   |
| [0000000000000A000] | PCI-to-PCI Bridge   |
| [0000000000000B000] | PCI-to-PCI Bridge   |
| [0000000000000C000] | Intel(R) Celeron(R)/Pentium(R) Processor PCI Express Root Port - 5ADA |
| [0000000000000D000] | Intel(R) Celeron(R)/Pentium(R) Processor PCI Express Root Port - 5AD9 |
| [0000000000000E000] | Intel(R) Celeron(R)/Pentium(R) Processor PCI Express Root Port - 5AD8 |
| [0000000000000F000] | Intel(R) HD Graphics  |

 [000000000000F000 - 000000000000F03F] Intel(R) HD Graphics  
 [000000000000F040 - 000000000000F05F] Intel(R) Celeron(R)/Pentium(R) Processor SMBUS - 5AD4  
 [000000000000F060 - 000000000000F07F] Standard SATA AHCI Controller  
 [000000000000F080 - 000000000000F083] Standard SATA AHCI Controller  
 [000000000000F090 - 000000000000F097] Standard SATA AHCI Controller  
--





















































## B.2 Memory Address Map

|   |   |   |
|---|---|---|
| ▼ | Memory                                  |   |
|   | [000000007B800001 - 000000007BFFFFFF]   | PCI Express Root Complex  |
|   | [000000007C000001 - 000000007CFFFFFF]   | PCI Express Root Complex  |
|   | [0000000080000000 - 0000000080FFFFFF]   | Intel(R) HD Graphics  |
|   | [0000000080000000 - 0000000080FFFFFF]   | Intel(R) HD Graphics  |
|   | [0000000080000000 - 00000000CFFFFFFF]   | PCI Express Root Complex  |
|   | [0000000081000000 - 00000000810FFFFF]   | High Definition Audio Controller                                      |
|   | [0000000081100000 - 000000008110FFFFF]  | PCI-to-PCI Bridge   |
|   | [0000000081100000 - 00000000813FFFFFFF] | Intel(R) Celeron(R)/Pentium(R) Processor PCI Express Root Port - 5ADB |
|   | [0000000081100000 - 00000000813FFFFFFF] | PCI-to-PCI Bridge   |
|   | [00000000811DC000 - 00000000811DFFFFF]  | Intel(R) I211 Gigabit Network Connection #6                           |
|   | [00000000811E0000 - 00000000811FffffF]  | Intel(R) I211 Gigabit Network Connection #6                           |
|   | [0000000081200000 - 00000000812FFFFFFF] | PCI-to-PCI Bridge   |
|   | [00000000812DC000 - 00000000812DFFFFF]  | Intel(R) I211 Gigabit Network Connection #2                           |
|   | [00000000812E0000 - 00000000812FffffF]  | Intel(R) I211 Gigabit Network Connection #2                           |
|   | [0000000081300000 - 00000000813FFFFFFF] | PCI-to-PCI Bridge   |
|   | [00000000813DC000 - 00000000813DFFFFF]  | Intel(R) I211 Gigabit Network Connection #5                           |
|   | [00000000813E0000 - 00000000813FffffF]  | Intel(R) I211 Gigabit Network Connection #5                           |
|   | [0000000081400000 - 00000000814FFFFFFF] | Intel(R) Celeron(R)/Pentium(R) Processor PCI Express Root Port - 5ADA |
|   | [00000000814DC000 - 00000000814DFFFFF]  | Intel(R) I211 Gigabit Network Connection                              |
|   | [00000000814E0000 - 00000000814FffffF]  | Intel(R) I211 Gigabit Network Connection                              |
|   | [0000000081500000 - 00000000815FFFFFFF] | Intel(R) Celeron(R)/Pentium(R) Processor PCI Express Root Port - 5AD9 |
|   | [00000000815DC000 - 00000000815DFFFFF]  | Intel(R) I211 Gigabit Network Connection #4                           |
|   | [00000000815E0000 - 00000000815FffffF]  | Intel(R) I211 Gigabit Network Connection #4                           |
|   | [0000000081600000 - 00000000816FFFFFFF] | Intel(R) Celeron(R)/Pentium(R) Processor PCI Express Root Port - 5AD8 |
|   | [00000000816DC000 - 00000000816DFFFFF]  | Intel(R) I211 Gigabit Network Connection #3                           |
|   | [00000000816E0000 - 00000000816FffffF]  | Intel(R) I211 Gigabit Network Connection #3                           |
|   | [0000000081700000 - 000000008170FFFFF]  | Intel(R) USB 3.0 eXtensible Host Controller - 1.0 (Microsoft)         |
|   | [0000000081710000 - 0000000081713FFF]   | High Definition Audio Controller                                      |
|   | [0000000081714000 - 0000000081715FFF]   | Standard SATA AHCI Controller   |
|   | [0000000081716000 - 00000000817160FF]   | Intel(R) Celeron(R)/Pentium(R) Processor SMBUS - 5AD4                 |
|   | [0000000081717000 - 00000000817177FF]   | Standard SATA AHCI Controller   |
|   | [0000000081718000 - 00000000817180FF]   | Standard SATA AHCI Controller   |
|   | [000000008171B000 - 000000008171BFFF]   | Intel(R) Trusted Execution Engine Interface                           |
|   | [0000000090000000 - 000000009FFFFFFF]   | Intel(R) HD Graphics  |
|   | [0000000090000000 - 000000009FFFFFFF]   | Intel(R) HD Graphics  |
|   | [00000000D0C00000 - 00000000D0C00653]   | Intel(R) Serial IO GPIO Host Controller - INT3452                     |
|   | [00000000D0C40000 - 00000000D0C40763]   | Intel(R) Serial IO GPIO Host Controller - INT3452                     |
|   | [00000000D0C50000 - 00000000D0C5076B]   | Intel(R) Serial IO GPIO Host Controller - INT3452                     |
|   | [00000000D0C70000 - 00000000D0C70673]   | Intel(R) Serial IO GPIO Host Controller - INT3452                     |
|   | [00000000E0000000 - 00000000EFFFFFFF]   | Motherboard resources   |
|   | [00000000E0000000 - 00000000EFFFFFFF]   | PCI Express Root Complex  |
|   | [00000000FEA00000 - 00000000FEAFFFFF]   | Motherboard resources   |
|   | [00000000FED00000 - 00000000FED003FF]   | High precision event timer  |
|   | [00000000FED01000 - 00000000FED01FFF]   | Motherboard resources   |
|   | [00000000FED03000 - 00000000FED03FFF]   | Motherboard resources   |
|   | [00000000FED06000 - 00000000FED06FFF]   | Motherboard resources   |
|   | [00000000FED08000 - 00000000FED09FFF]   | Motherboard resources   |
|   | [00000000FED1C000 - 00000000FED1CFFF]   | Motherboard resources   |
|   | [00000000FED40000 - 00000000FED44FFF]   | Trusted Platform Module 2.0   |
|   | [00000000FED80000 - 00000000FEDBFFFF]   | Motherboard resources   |
|   | [00000000FEE00000 - 00000000FEEFFFFFFF] | Motherboard resources   |





















































## B.3 IRQ Mapping Chart

| Interrupt request (IRQ)   |   |
|---|---|
|  (ISA) 0x00000000 (00)   | System timer                                      |
|  (ISA) 0x00000001 (01)   | Standard PS/2 Keyboard                            |
|  (ISA) 0x00000004 (04)   | Communications Port (COM1)                        |
|  (ISA) 0x00000008 (08)   | High precision event timer                        |
|  (ISA) 0x0000000C (12)   | PS/2 Port Compatible Pointing Device              |
|  (ISA) 0x0000000E (14)   | Intel(R) Serial IO GPIO Host Controller - INT3452 |
|  (ISA) 0x0000000E (14)   | Intel(R) Serial IO GPIO Host Controller - INT3452 |
|  (ISA) 0x0000000E (14)   | Intel(R) Serial IO GPIO Host Controller - INT3452 |
|  (ISA) 0x0000000E (14)   | Intel(R) Serial IO GPIO Host Controller - INT3452 |
|  (ISA) 0x00000036 (54)   | Microsoft ACPI-Compliant System                   |
|  (ISA) 0x00000037 (55)   | Microsoft ACPI-Compliant System                   |
|  (ISA) 0x00000038 (56)   | Microsoft ACPI-Compliant System                   |
|  (ISA) 0x00000039 (57)   | Microsoft ACPI-Compliant System                   |
|  (ISA) 0x0000003A (58)   | Microsoft ACPI-Compliant System                   |
|  (ISA) 0x0000003B (59)   | Microsoft ACPI-Compliant System                   |
|  (ISA) 0x0000003C (60)   | Microsoft ACPI-Compliant System                   |
|  (ISA) 0x0000003D (61)   | Microsoft ACPI-Compliant System                   |
|  (ISA) 0x0000003E (62)   | Microsoft ACPI-Compliant System                   |
|  (ISA) 0x0000003F (63)   | Microsoft ACPI-Compliant System                   |
|  (ISA) 0x00000040 (64)   | Microsoft ACPI-Compliant System                   |
|  (ISA) 0x00000041 (65)   | Microsoft ACPI-Compliant System                   |
|  (ISA) 0x00000042 (66)   | Microsoft ACPI-Compliant System                   |
|  (ISA) 0x00000043 (67)   | Microsoft ACPI-Compliant System                   |
|  (ISA) 0x00000044 (68)   | Microsoft ACPI-Compliant System                   |
|  (ISA) 0x00000045 (69)   | Microsoft ACPI-Compliant System                   |
|  (ISA) 0x00000046 (70)   | Microsoft ACPI-Compliant System                   |
|  (ISA) 0x00000047 (71)   | Microsoft ACPI-Compliant System                   |
|  (ISA) 0x00000048 (72)   | Microsoft ACPI-Compliant System                   |
|  (ISA) 0x00000049 (73)   | Microsoft ACPI-Compliant System                   |
|  (ISA) 0x0000004A (74)  | Microsoft ACPI-Compliant System                   |
|  (ISA) 0x0000004B (75) | Microsoft ACPI-Compliant System                   |
|  (ISA) 0x0000004C (76) | Microsoft ACPI-Compliant System                   |
|  (ISA) 0x0000004D (77) | Microsoft ACPI-Compliant System                   |
|  (ISA) 0x0000004E (78) | Microsoft ACPI-Compliant System                   |
|  (ISA) 0x0000004F (79) | Microsoft ACPI-Compliant System                   |
|  (ISA) 0x00000050 (80) | Microsoft ACPI-Compliant System                   |
|  (ISA) 0x00000051 (81) | Microsoft ACPI-Compliant System                   |
|  (ISA) 0x00000052 (82) | Microsoft ACPI-Compliant System                   |
|  (ISA) 0x00000053 (83) | Microsoft ACPI-Compliant System                   |
|  (ISA) 0x00000054 (84) | Microsoft ACPI-Compliant System                   |
|  (ISA) 0x00000055 (85) | Microsoft ACPI-Compliant System                   |
|  (ISA) 0x00000056 (86) | Microsoft ACPI-Compliant System                   |
|  (ISA) 0x00000057 (87) | Microsoft ACPI-Compliant System                   |
|  (ISA) 0x00000058 (88) | Microsoft ACPI-Compliant System                   |
|  (ISA) 0x00000059 (89) | Microsoft ACPI-Compliant System                   |
|  (ISA) 0x0000005A (90) | Microsoft ACPI-Compliant System                   |
|  (ISA) 0x0000005B (91) | Microsoft ACPI-Compliant System                   |
|  (ISA) 0x0000005C (92) | Microsoft ACPI-Compliant System                   |
|  (ISA) 0x0000005D (93) | Microsoft ACPI-Compliant System                   |
|  (ISA) 0x0000005E (94) | Microsoft ACPI-Compliant System                   |
|  (ISA) 0x0000005F (95) | Microsoft ACPI-Compliant System                   |















































---

|   |                        |                                 |
|---|------------------------|---------------------------------|
|    | (ISA) 0x00000060 (96)  | Microsoft ACPI-Compliant System |
|    | (ISA) 0x00000061 (97)  | Microsoft ACPI-Compliant System |
|    | (ISA) 0x00000062 (98)  | Microsoft ACPI-Compliant System |
|    | (ISA) 0x00000063 (99)  | Microsoft ACPI-Compliant System |
|    | (ISA) 0x00000064 (100) | Microsoft ACPI-Compliant System |
|    | (ISA) 0x00000065 (101) | Microsoft ACPI-Compliant System |
|    | (ISA) 0x00000066 (102) | Microsoft ACPI-Compliant System |
|    | (ISA) 0x00000067 (103) | Microsoft ACPI-Compliant System |
|    | (ISA) 0x00000068 (104) | Microsoft ACPI-Compliant System |
|    | (ISA) 0x00000069 (105) | Microsoft ACPI-Compliant System |
|    | (ISA) 0x0000006A (106) | Microsoft ACPI-Compliant System |
|    | (ISA) 0x0000006B (107) | Microsoft ACPI-Compliant System |
|    | (ISA) 0x0000006C (108) | Microsoft ACPI-Compliant System |
|    | (ISA) 0x0000006D (109) | Microsoft ACPI-Compliant System |
|    | (ISA) 0x0000006E (110) | Microsoft ACPI-Compliant System |
|    | (ISA) 0x0000006F (111) | Microsoft ACPI-Compliant System |
|    | (ISA) 0x00000070 (112) | Microsoft ACPI-Compliant System |
|    | (ISA) 0x00000071 (113) | Microsoft ACPI-Compliant System |
|    | (ISA) 0x00000072 (114) | Microsoft ACPI-Compliant System |
|    | (ISA) 0x00000073 (115) | Microsoft ACPI-Compliant System |
|    | (ISA) 0x00000074 (116) | Microsoft ACPI-Compliant System |
|    | (ISA) 0x00000075 (117) | Microsoft ACPI-Compliant System |
|    | (ISA) 0x00000076 (118) | Microsoft ACPI-Compliant System |
|    | (ISA) 0x00000077 (119) | Microsoft ACPI-Compliant System |
|    | (ISA) 0x00000078 (120) | Microsoft ACPI-Compliant System |
|    | (ISA) 0x00000079 (121) | Microsoft ACPI-Compliant System |
|    | (ISA) 0x0000007A (122) | Microsoft ACPI-Compliant System |
|    | (ISA) 0x0000007B (123) | Microsoft ACPI-Compliant System |
|    | (ISA) 0x0000007C (124) | Microsoft ACPI-Compliant System |
|    | (ISA) 0x0000007D (125) | Microsoft ACPI-Compliant System |
|    | (ISA) 0x0000007E (126) | Microsoft ACPI-Compliant System |
|    | (ISA) 0x0000007F (127) | Microsoft ACPI-Compliant System |
|  | (ISA) 0x00000080 (128) | Microsoft ACPI-Compliant System |
|  | (ISA) 0x00000081 (129) | Microsoft ACPI-Compliant System |
|  | (ISA) 0x00000082 (130) | Microsoft ACPI-Compliant System |
|  | (ISA) 0x00000083 (131) | Microsoft ACPI-Compliant System |
|  | (ISA) 0x00000084 (132) | Microsoft ACPI-Compliant System |
|  | (ISA) 0x00000085 (133) | Microsoft ACPI-Compliant System |
|  | (ISA) 0x00000086 (134) | Microsoft ACPI-Compliant System |
|  | (ISA) 0x00000087 (135) | Microsoft ACPI-Compliant System |
|  | (ISA) 0x00000088 (136) | Microsoft ACPI-Compliant System |
|  | (ISA) 0x00000089 (137) | Microsoft ACPI-Compliant System |
|  | (ISA) 0x0000008A (138) | Microsoft ACPI-Compliant System |
|  | (ISA) 0x0000008B (139) | Microsoft ACPI-Compliant System |
|  | (ISA) 0x0000008C (140) | Microsoft ACPI-Compliant System |
|  | (ISA) 0x0000008D (141) | Microsoft ACPI-Compliant System |
|  | (ISA) 0x0000008E (142) | Microsoft ACPI-Compliant System |
|  | (ISA) 0x0000008F (143) | Microsoft ACPI-Compliant System |
|  | (ISA) 0x00000090 (144) | Microsoft ACPI-Compliant System |
|  | (ISA) 0x00000091 (145) | Microsoft ACPI-Compliant System |
|  | (ISA) 0x00000092 (146) | Microsoft ACPI-Compliant System |
|  | (ISA) 0x00000093 (147) | Microsoft ACPI-Compliant System |

---





















































|   |                        |                                 |
|---|------------------------|---------------------------------|
|    | (ISA) 0x00000094 (148) | Microsoft ACPI-Compliant System |
|    | (ISA) 0x00000095 (149) | Microsoft ACPI-Compliant System |
|    | (ISA) 0x00000096 (150) | Microsoft ACPI-Compliant System |
|    | (ISA) 0x00000097 (151) | Microsoft ACPI-Compliant System |
|    | (ISA) 0x00000098 (152) | Microsoft ACPI-Compliant System |
|    | (ISA) 0x00000099 (153) | Microsoft ACPI-Compliant System |
|    | (ISA) 0x0000009A (154) | Microsoft ACPI-Compliant System |
|    | (ISA) 0x0000009B (155) | Microsoft ACPI-Compliant System |
|    | (ISA) 0x0000009C (156) | Microsoft ACPI-Compliant System |
|    | (ISA) 0x0000009D (157) | Microsoft ACPI-Compliant System |
|    | (ISA) 0x0000009E (158) | Microsoft ACPI-Compliant System |
|    | (ISA) 0x0000009F (159) | Microsoft ACPI-Compliant System |
|    | (ISA) 0x000000A0 (160) | Microsoft ACPI-Compliant System |
|    | (ISA) 0x000000A1 (161) | Microsoft ACPI-Compliant System |
|    | (ISA) 0x000000A2 (162) | Microsoft ACPI-Compliant System |
|    | (ISA) 0x000000A3 (163) | Microsoft ACPI-Compliant System |
|    | (ISA) 0x000000A4 (164) | Microsoft ACPI-Compliant System |
|    | (ISA) 0x000000A5 (165) | Microsoft ACPI-Compliant System |
|    | (ISA) 0x000000A6 (166) | Microsoft ACPI-Compliant System |
|    | (ISA) 0x000000A7 (167) | Microsoft ACPI-Compliant System |
|    | (ISA) 0x000000A8 (168) | Microsoft ACPI-Compliant System |
|    | (ISA) 0x000000A9 (169) | Microsoft ACPI-Compliant System |
|    | (ISA) 0x000000AA (170) | Microsoft ACPI-Compliant System |
|    | (ISA) 0x000000AB (171) | Microsoft ACPI-Compliant System |
|    | (ISA) 0x000000AC (172) | Microsoft ACPI-Compliant System |
|    | (ISA) 0x000000AD (173) | Microsoft ACPI-Compliant System |
|    | (ISA) 0x000000AE (174) | Microsoft ACPI-Compliant System |
|    | (ISA) 0x000000AF (175) | Microsoft ACPI-Compliant System |
|    | (ISA) 0x000000B0 (176) | Microsoft ACPI-Compliant System |
|    | (ISA) 0x000000B1 (177) | Microsoft ACPI-Compliant System |
|    | (ISA) 0x000000B2 (178) | Microsoft ACPI-Compliant System |
|    | (ISA) 0x000000B3 (179) | Microsoft ACPI-Compliant System |
|  | (ISA) 0x000000B4 (180) | Microsoft ACPI-Compliant System |
|  | (ISA) 0x000000B5 (181) | Microsoft ACPI-Compliant System |
|  | (ISA) 0x000000B6 (182) | Microsoft ACPI-Compliant System |
|  | (ISA) 0x000000B7 (183) | Microsoft ACPI-Compliant System |
|  | (ISA) 0x000000B8 (184) | Microsoft ACPI-Compliant System |
|  | (ISA) 0x000000B9 (185) | Microsoft ACPI-Compliant System |
|  | (ISA) 0x000000BA (186) | Microsoft ACPI-Compliant System |
|  | (ISA) 0x000000BB (187) | Microsoft ACPI-Compliant System |
|  | (ISA) 0x000000BC (188) | Microsoft ACPI-Compliant System |
|  | (ISA) 0x000000BD (189) | Microsoft ACPI-Compliant System |
|  | (ISA) 0x000000BE (190) | Microsoft ACPI-Compliant System |
|  | (ISA) 0x000000BF (191) | Microsoft ACPI-Compliant System |
|  | (ISA) 0x000000C0 (192) | Microsoft ACPI-Compliant System |
|  | (ISA) 0x000000C1 (193) | Microsoft ACPI-Compliant System |
|  | (ISA) 0x000000C2 (194) | Microsoft ACPI-Compliant System |
|  | (ISA) 0x000000C3 (195) | Microsoft ACPI-Compliant System |
|  | (ISA) 0x000000C4 (196) | Microsoft ACPI-Compliant System |
|  | (ISA) 0x000000C5 (197) | Microsoft ACPI-Compliant System |
|  | (ISA) 0x000000C6 (198) | Microsoft ACPI-Compliant System |
|  | (ISA) 0x000000C7 (199) | Microsoft ACPI-Compliant System |

---

|  |                                 |
|--|---------------------------------|
|  (ISA) 0x000000C8 (200)   | Microsoft ACPI-Compliant System |
|  (ISA) 0x000000C9 (201)   | Microsoft ACPI-Compliant System |
|  (ISA) 0x000000CA (202)   | Microsoft ACPI-Compliant System |
|  (ISA) 0x000000CB (203)   | Microsoft ACPI-Compliant System |
|  (ISA) 0x000000CC (204)   | Microsoft ACPI-Compliant System |
|  (ISA) 0x00000100 (256)   | Microsoft ACPI-Compliant System |
|  (ISA) 0x00000101 (257)   | Microsoft ACPI-Compliant System |
|  (ISA) 0x00000102 (258)   | Microsoft ACPI-Compliant System |
|  (ISA) 0x00000103 (259)   | Microsoft ACPI-Compliant System |
|  (ISA) 0x00000104 (260)   | Microsoft ACPI-Compliant System |
|  (ISA) 0x00000105 (261)   | Microsoft ACPI-Compliant System |
|  (ISA) 0x00000106 (262)   | Microsoft ACPI-Compliant System |
|  (ISA) 0x00000107 (263)   | Microsoft ACPI-Compliant System |
|  (ISA) 0x00000108 (264)   | Microsoft ACPI-Compliant System |
|  (ISA) 0x00000109 (265)   | Microsoft ACPI-Compliant System |
|  (ISA) 0x0000010A (266)   | Microsoft ACPI-Compliant System |
|  (ISA) 0x0000010B (267)   | Microsoft ACPI-Compliant System |
|  (ISA) 0x0000010C (268)   | Microsoft ACPI-Compliant System |
|  (ISA) 0x0000010D (269)   | Microsoft ACPI-Compliant System |
|  (ISA) 0x0000010E (270)   | Microsoft ACPI-Compliant System |
|  (ISA) 0x0000010F (271)   | Microsoft ACPI-Compliant System |
|  (ISA) 0x00000110 (272)   | Microsoft ACPI-Compliant System |
|  (ISA) 0x00000111 (273)   | Microsoft ACPI-Compliant System |
|  (ISA) 0x00000112 (274)   | Microsoft ACPI-Compliant System |
|  (ISA) 0x00000113 (275)   | Microsoft ACPI-Compliant System |
|  (ISA) 0x00000114 (276)   | Microsoft ACPI-Compliant System |
|  (ISA) 0x00000115 (277)   | Microsoft ACPI-Compliant System |
|  (ISA) 0x00000116 (278)  | Microsoft ACPI-Compliant System |
|  (ISA) 0x00000117 (279) | Microsoft ACPI-Compliant System |
|  (ISA) 0x00000118 (280) | Microsoft ACPI-Compliant System |
|  (ISA) 0x00000119 (281) | Microsoft ACPI-Compliant System |
|  (ISA) 0x0000011A (282) | Microsoft ACPI-Compliant System |
|  (ISA) 0x0000011B (283) | Microsoft ACPI-Compliant System |
|  (ISA) 0x0000011C (284) | Microsoft ACPI-Compliant System |
|  (ISA) 0x0000011D (285) | Microsoft ACPI-Compliant System |
|  (ISA) 0x0000011E (286) | Microsoft ACPI-Compliant System |
|  (ISA) 0x0000011F (287) | Microsoft ACPI-Compliant System |
|  (ISA) 0x00000120 (288) | Microsoft ACPI-Compliant System |
|  (ISA) 0x00000121 (289) | Microsoft ACPI-Compliant System |
|  (ISA) 0x00000122 (290) | Microsoft ACPI-Compliant System |
|  (ISA) 0x00000123 (291) | Microsoft ACPI-Compliant System |
|  (ISA) 0x00000124 (292) | Microsoft ACPI-Compliant System |
|  (ISA) 0x00000125 (293) | Microsoft ACPI-Compliant System |
|  (ISA) 0x00000126 (294) | Microsoft ACPI-Compliant System |
|  (ISA) 0x00000127 (295) | Microsoft ACPI-Compliant System |
|  (ISA) 0x00000128 (296) | Microsoft ACPI-Compliant System |
|  (ISA) 0x00000129 (297) | Microsoft ACPI-Compliant System |
|  (ISA) 0x0000012A (298) | Microsoft ACPI-Compliant System |
|  (ISA) 0x0000012B (299) | Microsoft ACPI-Compliant System |
|  (ISA) 0x0000012C (300) | Microsoft ACPI-Compliant System |
|  (ISA) 0x0000012D (301) | Microsoft ACPI-Compliant System |
|  (ISA) 0x0000012E (302) | Microsoft ACPI-Compliant System |























































---

|   |                        |                                 |
|---|------------------------|---------------------------------|
|    | (ISA) 0x0000012F (303) | Microsoft ACPI-Compliant System |
|    | (ISA) 0x00000130 (304) | Microsoft ACPI-Compliant System |
|    | (ISA) 0x00000131 (305) | Microsoft ACPI-Compliant System |
|    | (ISA) 0x00000132 (306) | Microsoft ACPI-Compliant System |
|    | (ISA) 0x00000133 (307) | Microsoft ACPI-Compliant System |
|    | (ISA) 0x00000134 (308) | Microsoft ACPI-Compliant System |
|    | (ISA) 0x00000135 (309) | Microsoft ACPI-Compliant System |
|    | (ISA) 0x00000136 (310) | Microsoft ACPI-Compliant System |
|    | (ISA) 0x00000137 (311) | Microsoft ACPI-Compliant System |
|    | (ISA) 0x00000138 (312) | Microsoft ACPI-Compliant System |
|    | (ISA) 0x00000139 (313) | Microsoft ACPI-Compliant System |
|    | (ISA) 0x0000013A (314) | Microsoft ACPI-Compliant System |
|    | (ISA) 0x0000013B (315) | Microsoft ACPI-Compliant System |
|    | (ISA) 0x0000013C (316) | Microsoft ACPI-Compliant System |
|    | (ISA) 0x0000013D (317) | Microsoft ACPI-Compliant System |
|    | (ISA) 0x0000013E (318) | Microsoft ACPI-Compliant System |
|    | (ISA) 0x0000013F (319) | Microsoft ACPI-Compliant System |
|    | (ISA) 0x00000140 (320) | Microsoft ACPI-Compliant System |
|    | (ISA) 0x00000141 (321) | Microsoft ACPI-Compliant System |
|    | (ISA) 0x00000142 (322) | Microsoft ACPI-Compliant System |
|    | (ISA) 0x00000143 (323) | Microsoft ACPI-Compliant System |
|    | (ISA) 0x00000144 (324) | Microsoft ACPI-Compliant System |
|    | (ISA) 0x00000145 (325) | Microsoft ACPI-Compliant System |
|    | (ISA) 0x00000146 (326) | Microsoft ACPI-Compliant System |
|    | (ISA) 0x00000147 (327) | Microsoft ACPI-Compliant System |
|    | (ISA) 0x00000148 (328) | Microsoft ACPI-Compliant System |
|    | (ISA) 0x00000149 (329) | Microsoft ACPI-Compliant System |
|    | (ISA) 0x0000014A (330) | Microsoft ACPI-Compliant System |
|    | (ISA) 0x0000014B (331) | Microsoft ACPI-Compliant System |
|    | (ISA) 0x0000014C (332) | Microsoft ACPI-Compliant System |
|   | (ISA) 0x0000014D (333) | Microsoft ACPI-Compliant System |
|  | (ISA) 0x0000014E (334) | Microsoft ACPI-Compliant System |
|  | (ISA) 0x0000014F (335) | Microsoft ACPI-Compliant System |
|  | (ISA) 0x00000150 (336) | Microsoft ACPI-Compliant System |
|  | (ISA) 0x00000151 (337) | Microsoft ACPI-Compliant System |
|  | (ISA) 0x00000152 (338) | Microsoft ACPI-Compliant System |
|  | (ISA) 0x00000153 (339) | Microsoft ACPI-Compliant System |
|  | (ISA) 0x00000154 (340) | Microsoft ACPI-Compliant System |
|  | (ISA) 0x00000155 (341) | Microsoft ACPI-Compliant System |
|  | (ISA) 0x00000156 (342) | Microsoft ACPI-Compliant System |
|  | (ISA) 0x00000157 (343) | Microsoft ACPI-Compliant System |
|  | (ISA) 0x00000158 (344) | Microsoft ACPI-Compliant System |
|  | (ISA) 0x00000159 (345) | Microsoft ACPI-Compliant System |
|  | (ISA) 0x0000015A (346) | Microsoft ACPI-Compliant System |
|  | (ISA) 0x0000015B (347) | Microsoft ACPI-Compliant System |
|  | (ISA) 0x0000015C (348) | Microsoft ACPI-Compliant System |
|  | (ISA) 0x0000015D (349) | Microsoft ACPI-Compliant System |
|  | (ISA) 0x0000015E (350) | Microsoft ACPI-Compliant System |
|  | (ISA) 0x0000015F (351) | Microsoft ACPI-Compliant System |
|  | (ISA) 0x00000160 (352) | Microsoft ACPI-Compliant System |
|  | (ISA) 0x00000161 (353) | Microsoft ACPI-Compliant System |
|  | (ISA) 0x00000162 (354) | Microsoft ACPI-Compliant System |





















































---

---

















































|   |                       |                                 |
|---|-----------------------|---------------------------------|
|    | (ISA) 0x0000163 (355) | Microsoft ACPI-Compliant System |
|    | (ISA) 0x0000164 (356) | Microsoft ACPI-Compliant System |
|    | (ISA) 0x0000165 (357) | Microsoft ACPI-Compliant System |
|    | (ISA) 0x0000166 (358) | Microsoft ACPI-Compliant System |
|    | (ISA) 0x0000167 (359) | Microsoft ACPI-Compliant System |
|    | (ISA) 0x0000168 (360) | Microsoft ACPI-Compliant System |
|    | (ISA) 0x0000169 (361) | Microsoft ACPI-Compliant System |
|    | (ISA) 0x000016A (362) | Microsoft ACPI-Compliant System |
|    | (ISA) 0x000016B (363) | Microsoft ACPI-Compliant System |
|    | (ISA) 0x000016C (364) | Microsoft ACPI-Compliant System |
|    | (ISA) 0x000016D (365) | Microsoft ACPI-Compliant System |
|    | (ISA) 0x000016E (366) | Microsoft ACPI-Compliant System |
|    | (ISA) 0x000016F (367) | Microsoft ACPI-Compliant System |
|    | (ISA) 0x0000170 (368) | Microsoft ACPI-Compliant System |
|    | (ISA) 0x0000171 (369) | Microsoft ACPI-Compliant System |
|    | (ISA) 0x0000172 (370) | Microsoft ACPI-Compliant System |
|    | (ISA) 0x0000173 (371) | Microsoft ACPI-Compliant System |
|    | (ISA) 0x0000174 (372) | Microsoft ACPI-Compliant System |
|    | (ISA) 0x0000175 (373) | Microsoft ACPI-Compliant System |
|    | (ISA) 0x0000176 (374) | Microsoft ACPI-Compliant System |
|    | (ISA) 0x0000177 (375) | Microsoft ACPI-Compliant System |
|    | (ISA) 0x0000178 (376) | Microsoft ACPI-Compliant System |
|    | (ISA) 0x0000179 (377) | Microsoft ACPI-Compliant System |
|    | (ISA) 0x000017A (378) | Microsoft ACPI-Compliant System |
|    | (ISA) 0x000017B (379) | Microsoft ACPI-Compliant System |
|    | (ISA) 0x000017C (380) | Microsoft ACPI-Compliant System |
|    | (ISA) 0x000017D (381) | Microsoft ACPI-Compliant System |
|    | (ISA) 0x000017E (382) | Microsoft ACPI-Compliant System |
|    | (ISA) 0x000017F (383) | Microsoft ACPI-Compliant System |
|    | (ISA) 0x0000180 (384) | Microsoft ACPI-Compliant System |
|    | (ISA) 0x0000181 (385) | Microsoft ACPI-Compliant System |
|    | (ISA) 0x0000182 (386) | Microsoft ACPI-Compliant System |
|  | (ISA) 0x0000183 (387) | Microsoft ACPI-Compliant System |
|  | (ISA) 0x0000184 (388) | Microsoft ACPI-Compliant System |
|  | (ISA) 0x0000185 (389) | Microsoft ACPI-Compliant System |
|  | (ISA) 0x0000186 (390) | Microsoft ACPI-Compliant System |
|  | (ISA) 0x0000187 (391) | Microsoft ACPI-Compliant System |
|  | (ISA) 0x0000188 (392) | Microsoft ACPI-Compliant System |
|  | (ISA) 0x0000189 (393) | Microsoft ACPI-Compliant System |
|  | (ISA) 0x000018A (394) | Microsoft ACPI-Compliant System |
|  | (ISA) 0x000018B (395) | Microsoft ACPI-Compliant System |
|  | (ISA) 0x000018C (396) | Microsoft ACPI-Compliant System |
|  | (ISA) 0x000018D (397) | Microsoft ACPI-Compliant System |
|  | (ISA) 0x000018E (398) | Microsoft ACPI-Compliant System |
|  | (ISA) 0x000018F (399) | Microsoft ACPI-Compliant System |
|  | (ISA) 0x0000190 (400) | Microsoft ACPI-Compliant System |
|  | (ISA) 0x0000191 (401) | Microsoft ACPI-Compliant System |
|  | (ISA) 0x0000192 (402) | Microsoft ACPI-Compliant System |
|  | (ISA) 0x0000193 (403) | Microsoft ACPI-Compliant System |
|  | (ISA) 0x0000194 (404) | Microsoft ACPI-Compliant System |
|  | (ISA) 0x0000195 (405) | Microsoft ACPI-Compliant System |
|  | (ISA) 0x0000196 (406) | Microsoft ACPI-Compliant System |











































---

---

|   |                        |                                 |
|---|------------------------|---------------------------------|
|    | (ISA) 0x00000197 (407) | Microsoft ACPI-Compliant System |
|    | (ISA) 0x00000198 (408) | Microsoft ACPI-Compliant System |
|    | (ISA) 0x00000199 (409) | Microsoft ACPI-Compliant System |
|    | (ISA) 0x0000019A (410) | Microsoft ACPI-Compliant System |
|    | (ISA) 0x0000019B (411) | Microsoft ACPI-Compliant System |
|    | (ISA) 0x0000019C (412) | Microsoft ACPI-Compliant System |
|    | (ISA) 0x0000019D (413) | Microsoft ACPI-Compliant System |
|    | (ISA) 0x0000019E (414) | Microsoft ACPI-Compliant System |
|    | (ISA) 0x0000019F (415) | Microsoft ACPI-Compliant System |
|    | (ISA) 0x000001A0 (416) | Microsoft ACPI-Compliant System |
|    | (ISA) 0x000001A1 (417) | Microsoft ACPI-Compliant System |
|    | (ISA) 0x000001A2 (418) | Microsoft ACPI-Compliant System |
|    | (ISA) 0x000001A3 (419) | Microsoft ACPI-Compliant System |
|    | (ISA) 0x000001A4 (420) | Microsoft ACPI-Compliant System |
|    | (ISA) 0x000001A5 (421) | Microsoft ACPI-Compliant System |
|    | (ISA) 0x000001A6 (422) | Microsoft ACPI-Compliant System |
|    | (ISA) 0x000001A7 (423) | Microsoft ACPI-Compliant System |
|    | (ISA) 0x000001A8 (424) | Microsoft ACPI-Compliant System |
|    | (ISA) 0x000001A9 (425) | Microsoft ACPI-Compliant System |
|    | (ISA) 0x000001AA (426) | Microsoft ACPI-Compliant System |
|    | (ISA) 0x000001AB (427) | Microsoft ACPI-Compliant System |
|    | (ISA) 0x000001AC (428) | Microsoft ACPI-Compliant System |
|    | (ISA) 0x000001AD (429) | Microsoft ACPI-Compliant System |
|    | (ISA) 0x000001AE (430) | Microsoft ACPI-Compliant System |
|    | (ISA) 0x000001AF (431) | Microsoft ACPI-Compliant System |
|    | (ISA) 0x000001B0 (432) | Microsoft ACPI-Compliant System |
|    | (ISA) 0x000001B1 (433) | Microsoft ACPI-Compliant System |
|    | (ISA) 0x000001B2 (434) | Microsoft ACPI-Compliant System |
|    | (ISA) 0x000001B3 (435) | Microsoft ACPI-Compliant System |
|    | (ISA) 0x000001B4 (436) | Microsoft ACPI-Compliant System |
|    | (ISA) 0x000001B5 (437) | Microsoft ACPI-Compliant System |
|   | (ISA) 0x000001B6 (438) | Microsoft ACPI-Compliant System |
|  | (ISA) 0x000001B7 (439) | Microsoft ACPI-Compliant System |
|  | (ISA) 0x000001B8 (440) | Microsoft ACPI-Compliant System |
|  | (ISA) 0x000001B9 (441) | Microsoft ACPI-Compliant System |
|  | (ISA) 0x000001BA (442) | Microsoft ACPI-Compliant System |
|  | (ISA) 0x000001BB (443) | Microsoft ACPI-Compliant System |
|  | (ISA) 0x000001BC (444) | Microsoft ACPI-Compliant System |
|  | (ISA) 0x000001BD (445) | Microsoft ACPI-Compliant System |
|  | (ISA) 0x000001BE (446) | Microsoft ACPI-Compliant System |
|  | (ISA) 0x000001BF (447) | Microsoft ACPI-Compliant System |
|  | (ISA) 0x000001C0 (448) | Microsoft ACPI-Compliant System |
|  | (ISA) 0x000001C1 (449) | Microsoft ACPI-Compliant System |
|  | (ISA) 0x000001C2 (450) | Microsoft ACPI-Compliant System |
|  | (ISA) 0x000001C3 (451) | Microsoft ACPI-Compliant System |
|  | (ISA) 0x000001C4 (452) | Microsoft ACPI-Compliant System |
|  | (ISA) 0x000001C5 (453) | Microsoft ACPI-Compliant System |
|  | (ISA) 0x000001C6 (454) | Microsoft ACPI-Compliant System |
|  | (ISA) 0x000001C7 (455) | Microsoft ACPI-Compliant System |
|  | (ISA) 0x000001C8 (456) | Microsoft ACPI-Compliant System |
|  | (ISA) 0x000001C9 (457) | Microsoft ACPI-Compliant System |
|  | (ISA) 0x000001CA (458) | Microsoft ACPI-Compliant System |

---

|   |                        |                                 |
|---|------------------------|---------------------------------|
|    | (ISA) 0x000001CB (459) | Microsoft ACPI-Compliant System |
|    | (ISA) 0x000001CC (460) | Microsoft ACPI-Compliant System |
|    | (ISA) 0x000001CD (461) | Microsoft ACPI-Compliant System |
|    | (ISA) 0x000001CE (462) | Microsoft ACPI-Compliant System |
|    | (ISA) 0x000001CF (463) | Microsoft ACPI-Compliant System |
|    | (ISA) 0x000001D0 (464) | Microsoft ACPI-Compliant System |
|    | (ISA) 0x000001D1 (465) | Microsoft ACPI-Compliant System |
|    | (ISA) 0x000001D2 (466) | Microsoft ACPI-Compliant System |
|    | (ISA) 0x000001D3 (467) | Microsoft ACPI-Compliant System |
|    | (ISA) 0x000001D4 (468) | Microsoft ACPI-Compliant System |
|    | (ISA) 0x000001D5 (469) | Microsoft ACPI-Compliant System |
|    | (ISA) 0x000001D6 (470) | Microsoft ACPI-Compliant System |
|    | (ISA) 0x000001D7 (471) | Microsoft ACPI-Compliant System |
|    | (ISA) 0x000001D8 (472) | Microsoft ACPI-Compliant System |
|    | (ISA) 0x000001D9 (473) | Microsoft ACPI-Compliant System |
|    | (ISA) 0x000001DA (474) | Microsoft ACPI-Compliant System |
|    | (ISA) 0x000001DB (475) | Microsoft ACPI-Compliant System |
|    | (ISA) 0x000001DC (476) | Microsoft ACPI-Compliant System |
|    | (ISA) 0x000001DD (477) | Microsoft ACPI-Compliant System |
|    | (ISA) 0x000001DE (478) | Microsoft ACPI-Compliant System |
|    | (ISA) 0x000001DF (479) | Microsoft ACPI-Compliant System |
|    | (ISA) 0x000001E0 (480) | Microsoft ACPI-Compliant System |
|    | (ISA) 0x000001E1 (481) | Microsoft ACPI-Compliant System |
|    | (ISA) 0x000001E2 (482) | Microsoft ACPI-Compliant System |
|    | (ISA) 0x000001E3 (483) | Microsoft ACPI-Compliant System |
|    | (ISA) 0x000001E4 (484) | Microsoft ACPI-Compliant System |
|    | (ISA) 0x000001E5 (485) | Microsoft ACPI-Compliant System |
|    | (ISA) 0x000001E6 (486) | Microsoft ACPI-Compliant System |
|    | (ISA) 0x000001E7 (487) | Microsoft ACPI-Compliant System |
|  | (ISA) 0x000001E8 (488) | Microsoft ACPI-Compliant System |
|  | (ISA) 0x000001E9 (489) | Microsoft ACPI-Compliant System |
|  | (ISA) 0x000001EA (490) | Microsoft ACPI-Compliant System |
|  | (ISA) 0x000001EB (491) | Microsoft ACPI-Compliant System |
|  | (ISA) 0x000001EC (492) | Microsoft ACPI-Compliant System |
|  | (ISA) 0x000001ED (493) | Microsoft ACPI-Compliant System |
|  | (ISA) 0x000001EE (494) | Microsoft ACPI-Compliant System |
|  | (ISA) 0x000001EF (495) | Microsoft ACPI-Compliant System |
|  | (ISA) 0x000001F0 (496) | Microsoft ACPI-Compliant System |
|  | (ISA) 0x000001F1 (497) | Microsoft ACPI-Compliant System |
|  | (ISA) 0x000001F2 (498) | Microsoft ACPI-Compliant System |
|  | (ISA) 0x000001F3 (499) | Microsoft ACPI-Compliant System |
|  | (ISA) 0x000001F4 (500) | Microsoft ACPI-Compliant System |
|  | (ISA) 0x000001F5 (501) | Microsoft ACPI-Compliant System |
|  | (ISA) 0x000001F6 (502) | Microsoft ACPI-Compliant System |
|  | (ISA) 0x000001F7 (503) | Microsoft ACPI-Compliant System |
|  | (ISA) 0x000001F8 (504) | Microsoft ACPI-Compliant System |
|  | (ISA) 0x000001F9 (505) | Microsoft ACPI-Compliant System |
|  | (ISA) 0x000001FA (506) | Microsoft ACPI-Compliant System |
|  | (ISA) 0x000001FB (507) | Microsoft ACPI-Compliant System |
|  | (ISA) 0x000001FC (508) | Microsoft ACPI-Compliant System |
|  | (ISA) 0x000001FD (509) | Microsoft ACPI-Compliant System |
|  | (ISA) 0x000001FE (510) | Microsoft ACPI-Compliant System |

|   |                        |   |
|---|------------------------|---|
|    | (ISA) 0x000001FF (511) | Microsoft ACPI-Compliant System                               |
|    | (PCI) 0x00000019 (25)  | High Definition Audio Controller                              |
|    | (PCI) 0xFFFFFD7 (-41)  | Intel(R) I211 Gigabit Network Connection #2                   |
|    | (PCI) 0xFFFFFD8 (-40)  | Intel(R) I211 Gigabit Network Connection #2                   |
|    | (PCI) 0xFFFFFD9 (-39)  | Intel(R) I211 Gigabit Network Connection #2                   |
|    | (PCI) 0xFFFFFDA (-38)  | Intel(R) I211 Gigabit Network Connection #2                   |
|    | (PCI) 0xFFFFFDB (-37)  | Intel(R) I211 Gigabit Network Connection #2                   |
|    | (PCI) 0xFFFFFDC (-36)  | Intel(R) I211 Gigabit Network Connection #2                   |
|    | (PCI) 0xFFFFFDD (-35)  | Intel(R) I211 Gigabit Network Connection #5                   |
|    | (PCI) 0xFFFFFDE (-34)  | Intel(R) I211 Gigabit Network Connection #5                   |
|    | (PCI) 0xFFFFFDF (-33)  | Intel(R) I211 Gigabit Network Connection #5                   |
|    | (PCI) 0xFFFFFE0 (-32)  | Intel(R) I211 Gigabit Network Connection #5                   |
|    | (PCI) 0xFFFFFE1 (-31)  | Intel(R) I211 Gigabit Network Connection #5                   |
|    | (PCI) 0xFFFFFE2 (-30)  | Intel(R) I211 Gigabit Network Connection #5                   |
|    | (PCI) 0xFFFFFE3 (-29)  | Intel(R) I211 Gigabit Network Connection                      |
|    | (PCI) 0xFFFFFE4 (-28)  | Intel(R) I211 Gigabit Network Connection                      |
|    | (PCI) 0xFFFFFE5 (-27)  | Intel(R) I211 Gigabit Network Connection                      |
|    | (PCI) 0xFFFFFE6 (-26)  | Intel(R) I211 Gigabit Network Connection                      |
|    | (PCI) 0xFFFFFE7 (-25)  | Intel(R) I211 Gigabit Network Connection                      |
|    | (PCI) 0xFFFFFE8 (-24)  | Intel(R) I211 Gigabit Network Connection                      |
|    | (PCI) 0xFFFFFE9 (-23)  | Intel(R) I211 Gigabit Network Connection #4                   |
|    | (PCI) 0xFFFFFEA (-22)  | Intel(R) I211 Gigabit Network Connection #4                   |
|    | (PCI) 0xFFFFFEB (-21)  | Intel(R) I211 Gigabit Network Connection #4                   |
|    | (PCI) 0xFFFFFEC (-20)  | Intel(R) I211 Gigabit Network Connection #4                   |
|    | (PCI) 0xFFFFFED (-19)  | Intel(R) I211 Gigabit Network Connection #4                   |
|    | (PCI) 0xFFFFFEE (-18)  | Intel(R) I211 Gigabit Network Connection #4                   |
|    | (PCI) 0xFFFFFEF (-17)  | Intel(R) I211 Gigabit Network Connection #3                   |
|   | (PCI) 0xFFFFFF0 (-16)  | Intel(R) I211 Gigabit Network Connection #3                   |
|  | (PCI) 0xFFFFFF1 (-15)  | Intel(R) I211 Gigabit Network Connection #3                   |
|  | (PCI) 0xFFFFFF2 (-14)  | Intel(R) I211 Gigabit Network Connection #3                   |
|  | (PCI) 0xFFFFFF3 (-13)  | Intel(R) I211 Gigabit Network Connection #3                   |
|  | (PCI) 0xFFFFFF4 (-12)  | Intel(R) I211 Gigabit Network Connection #3                   |
|  | (PCI) 0xFFFFFF5 (-11)  | Intel(R) I211 Gigabit Network Connection #6                   |
|  | (PCI) 0xFFFFFF6 (-10)  | Intel(R) I211 Gigabit Network Connection #6                   |
|  | (PCI) 0xFFFFFF7 (-9)   | Intel(R) I211 Gigabit Network Connection #6                   |
|  | (PCI) 0xFFFFFF8 (-8)   | Intel(R) I211 Gigabit Network Connection #6                   |
|  | (PCI) 0xFFFFFF9 (-7)   | Intel(R) I211 Gigabit Network Connection #6                   |
|  | (PCI) 0xFFFFFFA (-6)   | Intel(R) I211 Gigabit Network Connection #6                   |
|  | (PCI) 0xFFFFFFB (-5)   | Intel(R) USB 3.0 eXtensible Host Controller - 1.0 (Microsoft) |
|  | (PCI) 0xFFFFFFC (-4)   | Intel(R) Trusted Execution Engine Interface                   |
|  | (PCI) 0xFFFFFFD (-3)   | Intel(R) HD Graphics  |
|  | (PCI) 0xFFFFFFE (-2)   | Standard SATA AHCI Controller                                 |

# Appendix C

---

Standard LAN Bypass Platform Setting

## C.1 Status LED

The LED status indicator of FWS-2272 is programmable with AAEON SDK for your application.

**Table1: LED Status**

|                      | STA_LED2 | STA_LED1 | STA_LED0 |
|----------------------|----------|----------|----------|
| LED Off              | 0        | 0        | 0        |
| Red LED On           | 0        | 0        | 1        |
| Red LED Blink        | 0        | 1        | 0        |
| Red LED Fast Blink   | 0        | 1        | 1        |
| Reserved             | 1        | 0        | 0        |
| Green LED Blink      | 1        | 0        | 1        |
| Green LED Fast Blink | 1        | 1        | 0        |
| Green LED On         | 1        | 1        | 1        |

**Table2: Status LED and register mapping table**

| CPLD Slave Address 0x90 (Note1) |           |               |        |           |
|---------------------------------|-----------|---------------|--------|-----------|
|                                 | Attribute | Offset(SMBUS) | BitNum | Value     |
| STA_LED2                        | R/W       | 0x00 (Note2)  | 2      | (Table 1) |
| STA_LED1                        | R/W       | 0x00 (Note2)  | 1      | (Table 1) |
| STA_LED0                        | R/W       | 0x00 (Note2)  | 0      | (Table 1) |

**Sample Code:**

```
*****
#define ByteCPLD_SLAVE_ADDRESS //This parameter is represented from Note1
#define ByteOFFSET //This parameter is represented from Note2
*****
bData = aaeonSmbusReadByte(CPLD_SLAVE_ADDRESS, OFFSET);

switch( LED_FLAG)
{
case 0:
{
//LED Off
//BIT2=0, BIT1=0, BIT0=0
bData = bData & 0xF8;
break;
}
case 1:
{
//Red LED On
//BIT2=0, BIT1=0, BIT0=1
bData = (bData & 0xF8) | 0x01;
break;
}
case 2:
{
//Red LED Blink
//BIT2=0, BIT1=1, BIT0=0
bData = (bData & 0xF8) | 0x02;
break;
}
case 3:
{
//Red LED Fast Blink
//BIT2=0, BIT1=1, BIT0=1
bData = (bData & 0xF8) | 0x03;
break;
}
case 4:
{
//Green LED On
//BIT2=1, BIT1=1, BIT0=1
```



```
        bData = (bData & 0xF8) | 0x07;
        break;
    }
    case 5:
    {
        //Green LED Blink
        //BIT2=1, BIT1=0, BIT0=1
        bData = (bData & 0xF8) | 0x05;
        break;
    }
    case 6:
    {
        //Green LED Fast Blink
        //BIT2=1, BIT1=1, BIT0=0
        bData = (bData & 0xF8) | 0x06;
        break;
    }
    default:
        break;
}
SmbusWriteByte(CPLD_SLAVE_ADDRESS, 0x00, bData);
*****
```

## C.2 LAN Bypass

Table1: LAN Kit ID Select

| LAN_ID2 | LAN_ID1 | LAN_ID0 | LAN kit selected   |
|---------|---------|---------|--------------------|
| 0       | 0       | 0       | LAN Kit 1 Selected |
| 0       | 0       | 1       | LAN Kit 2 Selected |

Table2: LAN Bypass register table

| Function | Description  |
|----------|--|
| LAN_ID3  |  |
| LAN_ID2  | Use for selecting which LAN kit will be configured, refer to Table 1 of ID Select table of LAN kit.                                      |
| LAN_ID1  | They should be set before ACT_EN.  |
| LAN_ID0  |  |
| PWR_ON   | Use for configuring LAN Bypass function behavior to LAN kit, when system power on.<br>1: Bypass<br>0: Pass Through                       |
| PWR_OFF  | Use for configuring LAN Bypass function behavior to LAN kit, when system power off.<br>1: Bypass<br>0: Pass Through                      |
| WDT_EN   | Use for configuring WDT function behavior to LAN kit, when WDT triggered.<br>0: Normal WDT reset (Default)<br>1: Force Bypass            |
| ACT_EN   | Use for activating programming of LAN kit. It is edge triggering (falling edge 1 to 0) and should be set to high(1) as its normal state. |

Table3: LAN Bypass register mapping table

| CPLD Slave Address 0x90 (Note1) |           |               |        |           |
|---------------------------------|-----------|---------------|--------|-----------|
|                                 | Attribute | Offset(SMBUS) | BitNum | Value     |
| LAN_ID3                         | R/W       | 0x01(Note2)   | 3      | (Table 1) |
| LAN_ID2                         | R/W       | 0x01(Note2)   | 2      | (Table 1) |
| LAN_ID1                         | R/W       | 0x01(Note2)   | 1      | (Table 1) |
| LAN_ID0                         | R/W       | 0x01(Note2)   | 0      | (Table 1) |
| PWR_ON                          | R/W       | 0x01(Note2)   | 6      | (Table 2) |
| PWR_OFF                         | R/W       | 0x01(Note2)   | 5      | (Table 2) |
| WDT_EN                          | R/W       | 0x01(Note2)   | 4      | (Table 2) |
| ACT_EN                          | R/W       | 0x01(Note2)   | 7      | (Table 2) |

### Sample Code

```

*****
#define ByteCPLD_SLAVE_ADDRESS //This parameter is represented from Note1
#define ByteOFFSET //This parameter is represented from Note2
*****

// Select Lan Pair
BYTE bLanSel = LAN_PAIR;

BYTE bData = SmbusReadByte(CPLD_SLAVE_ADDRESS, OFFSET);
// Set Reg01h bit3
if(bLanSel & 0x08)
    bData = bData | 0x08;
else
    bData = bData & 0xF7;
// Set Reg01h bit2
if(bLanSel & 0x04)
    bData = bData | 0x04;
else
    bData = bData & 0xFB;
// Set Reg01h bit1
if(bLanSel & 0x02)
    bData = bData | 0x02;
else
    bData = bData & 0xFD;

```

```
// Set Reg01h bit0
if(bLanSel & 0x01)
    bData = bData | 0x01;
else
    bData = bData & 0xFE;

// Power On Action (Reg01h bit6)
if(SET_PASS_THROUGH) // Pass Through
    bData = bData & 0xBF;
else // Bypass
    bData = bData | 0x40;

// Power Off Action (Reg01h bit5)
if(SET_PASS_THROUGH) // Pass Through
    bData = bData & 0xDF;
else // Bypass
    bData = bData | 0x20;

// WDT Action (Reg01h bit4)
if(SET_WDT_RESET)// Reset
    bData = bData & 0xEF;
else // Bypass
    bData = bData | 0x10;

SmbusWriteByte(CPLD_SLAVE_ADDRESS, OFFSET, bData);

// Apply Settings (Reg01h bit7)
bData = SmbusReadByte(CPLD_SLAVE_ADDRESS, OFFSET);
SmbusWriteByte(CPLD_SLAVE_ADDRESS, OFFSET, bData & 0x7F);
Sleep(500);
bData = SmbusReadByte(CPLD_SLAVE_ADDRESS, OFFSET);
SmbusWriteByte(CPLD_SLAVE_ADDRESS, OFFSET, bData | 0x80);
*****
```

### C.3 Software Reset Button Configuration

Table 1: Soft Reset Button register mapping table

|         | Attribute | Register(I/O) | BitNum   | Value   |
|---------|-----------|---------------|----------|---------|
| BTN_STS | R         | 0xA05(Note1)  | 4(Note2) | (Note3) |

Table 2: LAN Bypass register table

| Function | Description  |
|----------|--|
| BTN_STS  | Reading this register returns the pin level status which is normal high active low.<br>0: Pin Level States Low.<br>1: Pin Level States High. |

#### Sample Code:

```
*****
#define Word    BTN_STS    //This parameter is represented from Note1
#define ByteBTN_STS_R    //This parameter is represented from Note2
*****
Byte GET_Value (Word IoAddr, Byte BitNum,Byte Value){
    BYTE TmpValue;

    TmpValue = inportb (IoAddr);
    return (TmpValue & (1 << BitNum))
}
*****
VOID Main(){
    Byte RstBtn;

    RstBtn = GET_Value (BTN_STS, BTN_STS_R); // Active Low
}
*****
```