

**FOX-120**

Intel® LV Celeron® M Processor  
Multipurpose & Waterproof  
Panel PC  
with 12" TFT LCD

## **Copyright Notice**

This document is copyrighted, 2010. All rights are reserved. The original manufacturer reserves the right to make improvements to the products described in this manual at any time without notice.

No part of this manual may be reproduced, copied, translated, or transmitted in any form or by any means without the prior written permission of the original manufacturer. Information provided in this manual is intended to be accurate and reliable. However, the original manufacturer assumes no responsibility for its use, or for any infringements upon the rights of third parties that may result from its use.

The material in this document is for product information only and is subject to change without notice. While reasonable efforts have been made in the preparation of this document to assure its accuracy, AAEON assumes no liabilities resulting from errors or omissions in this document, or from the use of the information contained herein.

AAEON reserves the right to make changes in the product design without notice to its users.

## **Acknowledgments**

All other products' name or trademarks are properties of their respective owners.

- Award is a trademark of Award Software International, Inc.
- Intel<sup>®</sup>, Celeron<sup>®</sup> and Pentium<sup>®</sup> are trademarks of Intel<sup>®</sup> Corporation.
- Microsoft Windows<sup>®</sup> is a registered trademark of Microsoft Corp.
- IBM, PC/AT, PS/2, and VGA are trademarks of International Business Machines Corporation.

**All other product names or trademarks are properties of their respective owners.**

## **Packing List**

Before you begin operating your PC, please make sure that the following materials are enclosed:

- 1 USB Cable with water proof Connector
- 2 COM Cables with water proof Connectors
- 1 waterproof Connector for DC-in (Female)
- 1 waterproof Connector for LAN (optional)
- 1 waterproof Connector for audio –Line-out (optional)
- 1 Easy stand
- 1 CD-ROM for manual (in PDF format)
- 1 FOX-120 Multi purpose & Waterproof Panel PC

If any of these items should be missing or damaged, please contact your distributor or sales representative immediately.

## **Safety & Warranty**

1. Read these safety instructions carefully.
2. Keep this user's manual for later reference.
3. Disconnect this equipment from any AC outlet before cleaning. Do not use liquid or spray detergents for cleaning. Use a damp cloth.
4. For pluggable equipment, the power outlet must be installed near the equipment and must be easily accessible.
5. Keep this equipment away from humidity.
6. Put this equipment on a firm surface during installation. Dropping it or letting it fall could cause damage.
7. The openings on the enclosure are for air convection. Protect the equipment from overheating. **DO NOT COVER THE OPENINGS.**
8. Make sure the voltage of the power source is correct before connecting the equipment to the power outlet.
9. Position the power cord so that people cannot step on it. Do not place anything over the power cord.
10. All cautions and warnings on the equipment should be noted.
11. If the equipment is not used for a long time, disconnect it from the power source to avoid damage by transient over-voltage.
12. Never pour any liquid into an opening. This could cause fire or electrical shock.
13. Never open the equipment. For safety reasons, only qualified service personnel should open the equipment.
14. If any of the following situations arises, get the equipment checked by service personnel:
  - a. The power cord or plug is damaged.
  - b. Liquid has penetrated into the equipment.
  - c. The equipment has been exposed to moisture.

- d. The equipment does not work well, or you cannot get it to work according to the user's manual.
  - e. The equipment has been dropped and damaged.
  - f. The equipment has obvious signs of breakage.
15. DO NOT LEAVE THIS EQUIPMENT IN AN ENVIRONMENT WHERE THE STORAGE TEMPERATURE IS BELOW -20°C (-4°F) OR ABOVE 70°C (140°F). IT MAY DAMAGE THE EQUIPMENT.
16. DO NOT OPEN the sealed Enclosure /case of equipment. Once enclosure is disassembled without approval, it will lead in abnormal operating of water proof gel. For Guarantee of water proof function, please make sure configuration/ peripheral (HDD,RAM, peripherals) has been confirmed to install before shipping.

## **FCC**

### ***Warning!***



This device complies with Part 15 FCC Rules. Operation is subject to the following two conditions: (1) this device may not cause harmful interference, and (2) this device must accept any interference received including interference that may cause undesired operation.

### ***Caution:***

*There is a danger of explosion if the battery is incorrectly replaced. Replace only with the same or equivalent type recommended by the manufacturer. Dispose of used batteries according to the manufacturer's instructions and your local government's recycling or disposal directives.*

Below Table for China RoHS Requirements

产品中有毒有害物质或元素名称及含量

AAEON Panel PC/ Workstation

部件名称	有毒有害物质或元素					
	铅 (Pb)	汞 (Hg)	镉 (Cd)	六价铬 (Cr(VI))	多溴联苯 (PBB)	多溴二苯醚 (PBDE)
印刷电路板 及其电子组件	×	○	○	○	○	○
外部信号 连接器及线材	×	○	○	○	○	○
外壳	×	○	○	○	○	○
中央处理器 与内存	×	○	○	○	○	○
硬盘	×	○	○	○	○	○
液晶模块	×	○	○	○	○	○
光驱	×	○	○	○	○	○
触控模块	×	○	○	○	○	○
电源	×	○	○	○	○	○

O: 表示该有毒有害物质在该部件所有均质材料中的含量均在  
SJ/T 11363-2006 标准规定的限量要求以下。

X: 表示该有毒有害物质至少在该部件的某一均质材料中的含量超出  
SJ/T 11363-2006 标准规定的限量要求。

备注:

- 一、此产品所标示之环保使用期限，系指在一般正常使用状况下。
- 二、上述部件物质中央处理器、内存、硬盘、光驱、触控模块为选购品。

# Contents

## Chapter 1 General Information

1.1 Introduction.....	1-2
1.2 Features .....	1-3
1.3 Specification .....	1-4
1.4 Dimension .....	1-6

## Chapter 2 Hardware Installation

2.1 USB 1/2 Connector .....	2-2
2.2 COM 1 Connector for RS232 .....	2-2
2.3 COM 2 Connector for RS232/RS422/RS485.....	2-3
2.4 Audio (Line out) .....	2-4
2.5 DC-in 9~30V Connector .....	2-4

## Chapter 3 Award BIOS set up

3.1 System Test and Initialization .....	3-2
3.2 Award BIOS Setup .....	3-3

## Chapter 4 Driver Installation

4.1 Installation .....	4-3
------------------------	-----

## Appendix FAQ

A.1 FAQ.....	A-2
--------------	-----



Chapter

**1**

**General  
Information**

## **1.1 Introduction**

---

FOX-120 Multipurpose & Waterproof panel PC is a high-performance computing and completely fan-less solution for applications in outdoor, semi-outdoor, and harsh indoor environment ,that comes with Intel Celeron M Low Power processor, 12" wide View-angle display (with sunlight readability), Sealing enclosure( 6 sides of IP65 certified) and Water proof I/O connectors for Ethernet , multi-COM port, audio and USB interfaces. In addition, with water resistant bottoms on front panel, FOX has user-friendly interface for brightness control and a variety of optional wireless for real time communication or navigation.

Besides, for system integrators, a simple, complete, compact and highly integrated system helps you smoothly build an industrial grade solution into your applications. By this concept, FOX is design with valuable features (listed in next section) to serve various field of markets such as Vehicle, food factory, slaughter house, Pharmacy Production, Production Plant Hospital Operation Room, and Outdoor KIOSK Public Information Terminal.

With FOX, we believe the end user can optimize the workflow of operations and management in daily business.

## **1.2 Features**

---

- 12" High Brightness & Wide View-Angle LCD Panel
- Polarized Touch Panel Control for Outdoor Readability (Optional)
- Slim, Rugged, Sealing Enclosure with All sides of IP65 Certified
- Supports Windows 2000, XP, XP Embedded
- Wide Operating Temperature Range:  
-20°C~60 °C (With W/T CFD ); -20 °C ~55 °C (With W/T HDD )
- Day and Night Mode Display:  
Day Mode for Sunlight Readability; Night Mode for Power Saving
- Multi-Wireless Options:  
WIFI LAN with Internal Antenna (optional)  
GPS Module with Internal Antenna (optional)
- Waterproof Lockable I/O: Standard M12 Waterproof Connector
- User Friendly Bottom Control on Front Panel

## 1.3 Specification

---

### **System**

- CPU Onboard Intel Celeron M 1.5GHz/ ULV  
Celeron M 600MHz Processor
- Memory Onboard 256/512MB, up to 1G DDR  
SDRAM
- LCD / CRT Controller Intel 852GM
- Ethernet Intel 82562 10/100Base-TX, RJ-45  
connector x 1
- M12 water proof I/O Port 2 RS-232  
2 USB 2.0 ports,  
Audio Line-out (optional)  
10/100Base-TX RJ-45 (optional)
- Storage Disk Drive Type II Compact Flash™ internal slot  
Anti-vibration 2.5" Hard disk drive bay
- OS Support Windows 2000, XP, XP Embedded

### **Mechanical**

- Construction Metal
- Front Panel Color Silver Gray- RAL9007
- Mounting VESA 75-100mm holes,  
Vehicle Mounting
- Dimension 13.6" (W) x 11.1" (H) x 2.4" (D)  
(345mm x 282mm x 60mm)

- Net Weight 9.9 lb (4.5Kg)
- Gross Weight 12.1 lb (5.5Kg)

***Environmental***

- Operating Temperature -4°F~131°F (-20°C~55°C);  
With W/T Hard Disk drive  
-4°F~140°F (-20°C~60°C)  
with W/T CompactFlash™Disk
- Storage Temperature -22°F~158°F(-30°C~70°C)
- Operating Humidity 10% to 90%@35°C, non-condensing
- Vibration Random Operation 3G, 5-500Hz
- Shock 15G peak acceleration (11 msec. duration)
- EMC CE/FCC Class A
- Power Supply Input: DC 9~30V

***LCD***

- Display Type 12" Color TFT LCD
- Max. Resolution 800 x 600
- Max. Colors 262K colors
- Dot Size 0.3075mm x 0.3075mm
- Luminance 450 nits
- Viewing Angle 140° (H) x 110° (V)
- Backlight MTBF 50,000 hours

### ***Touch Screen***

- Type 8-wire analog resistive
- Light Transmission >74%
- Lifetime 1 million activations

**Note:** All AAEON's LCD products are manufactured with High precision technology. However, in all LCD panels there maybe a small number of defective pixels that do not change color. This is a normal occurrence for all LCD displays from all manufacturers and should not be noticeable or objectionable under normal operation. AAEON qualify the LCD panel following industry standard: total 7 dead pixels on a screen or if there are 3 within 1 inch square area of each other on the display.

## 1.4 Dimension

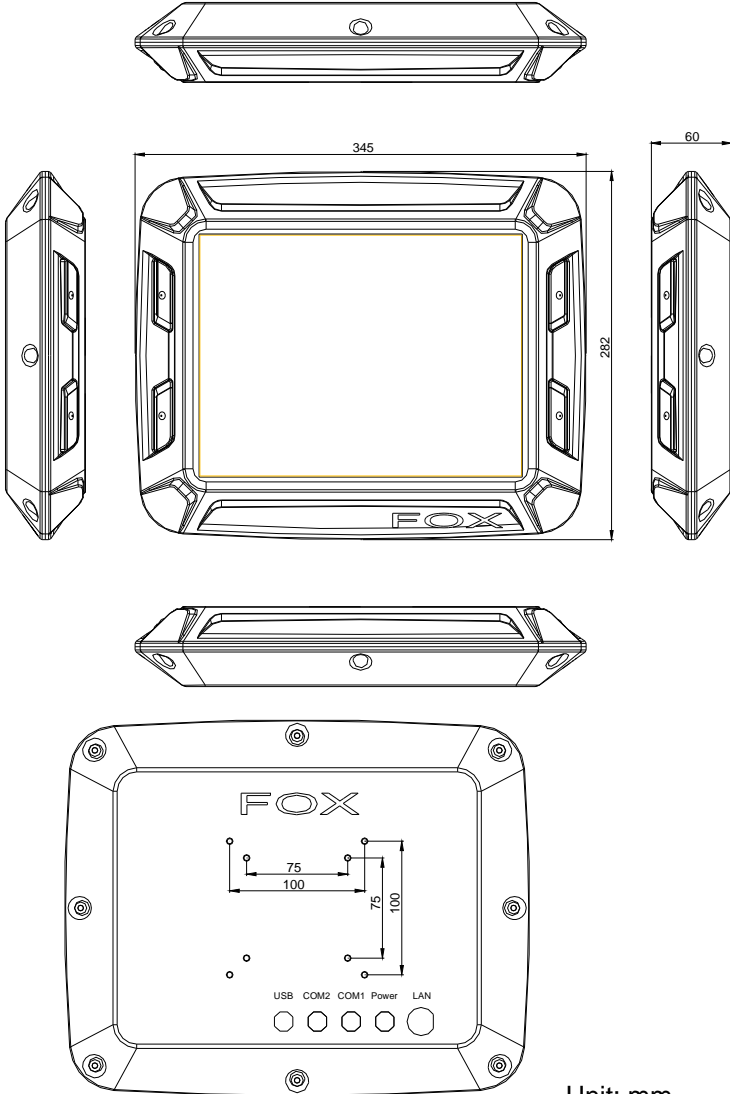

Unit: mm

Front Side



Rear Side

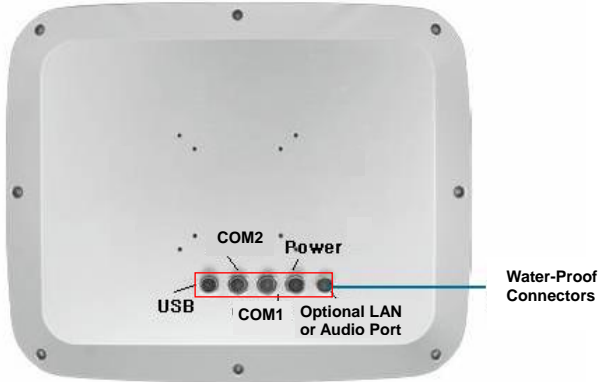



Chapter

**2**

**Hardware  
Installation**

## 2.1 USB 1/2 Connector

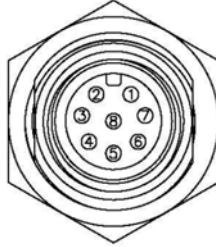

Pin Assignments  
Front View

Pin	Signal	Pin	Signal
1	USB1 V+	2	USB0 V+
3	USB D0+	4	USB D0-
5	USB0 GND	6	USB D1+
7	USB D1-	8	USB1 GND

## 2.2 COM1 Connector for RS-232

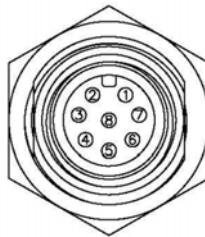

Pin Assignments  
Front View

Pin	Signal	Pin	Signal
1	DCD	2	RXD
3	TXD	4	DTR
5	GND	6	DSR
7	RTS	8	CTS

### 2.3 COM2 Connector for RS232/RS422/RS485

---

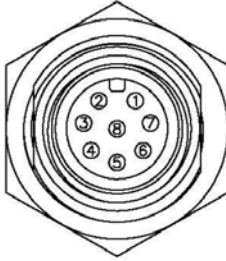

Pin Assignments  
Front View

#### RS-232

Pin	Signal	Pin	Signal
1	DCD	2	RXD
3	TXD	4	DTR
5	GND	6	DSR
7	RTS	8	CTS

#### RS-422

Pin	Signal	Pin	Signal
1	TXD-	2	RXD+
3	TXD+	4	RXD-

#### RS-485

Pin	Signal	Pin	Signal
1	TXD-	2	NC
3	TXD+	4	NC

## 2.4 Audio (Line out)

---

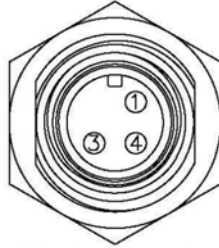

Pin Assignments  
Front View

Pin	Signal	Pin	Signal
1	R-out	2	N/A
3	L-out	4	GND

## 2.5 DC-IN 9~30V Connector

---

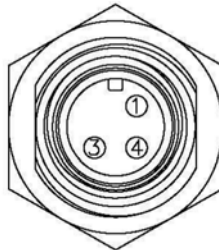

Pin Assignments  
Front View

Pin	Signal	Pin	Signal
1	DC V+	2	N/A
3	GND	4	NC

Chapter

**3**

**Award  
BIOS Setup**

### **3.1 System Test and Initialization**

---

These routines test and initialize board hardware. If the routines encounter an error during the tests, you will either hear a few short beeps or see an error message on the screen. There are two kinds of errors: fatal and non-fatal. The system can usually continue the boot up sequence with non-fatal errors. Non-fatal error messages usually appear on the screen along with the following instructions:

Press <F1> to RESUME

Write down the message and press the F1 key to continue the boot up sequence.

#### **System configuration verification**

These routines check the current system configuration against the values stored in the CMOS memory. If they do not match, the program outputs an error message. You will then need to run the BIOS setup program to set the configuration information in memory.

There are three situations in which you will need to change the CMOS settings:

1. You are starting your system for the first time
2. You have changed the hardware attached to your system
3. The CMOS memory has lost power and the configuration information has been erased.

TheFOX-120 CMOS memory has an integral lithium battery backup for data retention. However, you will need to replace the complete unit when it finally runs down.

## **3.2 Award BIOS Setup**

---

Awards BIOS ROM has a built-in Setup program that allows users to modify the basic system configuration. This type of information is stored in battery-backed CMOS RAM so that it retains the Setup information when the power is turned off.

### **Entering Setup**

Power on the computer and press <Del> immediately. This will allow you to enter Setup.

### **Standard CMOS Features**

Use this menu for basic system configuration. (Date, time, IDE, etc.)

### **Advanced BIOS Features**

Use this menu to set the advanced features available on your system.

### **Advanced Chipset Features**

Use this menu to change the values in the chipset registers and optimize your system performance.

### **Integrated Peripherals**

Use this menu to specify your settings for integrated peripherals. (Primary slave, secondary slave, keyboard, mouse etc.)

### **Power Management Setup**

Use this menu to specify your settings for power management. (HDD power down, power on by ring, KB wake up, etc.)

### **PnP/PCI Configurations**

This entry appears if your system supports PnP/PCI.

## **PC Health Status**

This menu allows you to set the shutdown temperature for your system.

## **Frequency/Voltage Control**

Use this menu to specify your settings for auto detect DIMM/PCI clock and spread spectrum.

## **Load Fail-Safe Defaults**

Use this menu to load the BIOS default values for the minimal/stable performance for your system to operate.

## **Load Optimized Defaults**

Use this menu to load the BIOS default values that are factory settings for optimal performance system operations. While AWARD has designated the custom BIOS to maximize performance, the factory has the right to change these defaults to meet their needs.

## **Set Supervisor/User Password**

Use this menu to set Supervisor/User Passwords.

## **Save and Exit Setup**

Save CMOS value changes to CMOS and exit setup.

## **Exit Without Saving**

Abandon all CMOS value changes and exit setup.

**You can refer to the "AAEON BIOS Item Description.pdf" file in the CD for the meaning of each setting in this chapter.**



Chapter

4

**Driver  
Installation**

There are several installation ways depending on the driver package under different Operating System application. The Auto-run program will run automatically. However, if the Auto-run program cannot be run smoothly, please follow the steps below to install the drivers:

Step 1-Install Intel INF Update for Windows 9x-2003 Driver

Step 2-Install Intel Extreme Graphics 2 Driver

Step 3-Install Intel LAN Driver

Step 4-Install Realtek AC97 codec Driver

Step 5-Install Touch Screen Driver

USB 2.0 Drivers are available for download using Windows Update for both Windows XP and Windows 2000. For additional information regarding USB 2.0 support in Windows XP and Windows 2000, please visit [www.microsoft.com/hwdev/usb/](http://www.microsoft.com/hwdev/usb/).

For installation procedures of each driver, you may see the details in the following.

## 4.1 Installation

---

Insert the FOX-120 CD-ROM into the CD-ROM drive and install the drivers from Step 1 to Step 5 in order.

Step 1 – Install Intel INF Update for Windows 9x-2003 Driver

1. Click on the **Step 1- Intel INF Update for Windows 9x-2003** folder
2. Double click on **Setup.exe**
3. Follow the instructions that the window shows
4. The system will help you install the driver automatically

Step 2 – Install Intel Extreme Graphics 2 Driver

1. Click on the **Step 2 –Intel Extreme Graphics 2 Driver** folder and select the OS your system is
2. Double click on **Setup.exe** located in the OS folder
3. Follow the instructions that the window shows
4. The system will help you install the driver automatically

Step 3 – Install Intel LAN Driver

1. Click on the **Step 3 –Intel LAN Driver** folder and select the OS your system is
2. Double click on **.exe** file located in the OS folder
3. Follow the instructions that the window shows
4. The system will help you install the driver automatically

Step 4 – Install Realtek AC97 codec Driver

1. Click on the **Step 4 –Realtek AC97 codec Driver** folder and then double click on **wdm\_a361.exe**
2. Follow the instructions that the window shows
3. The system will help you install the driver automatically

Step 5 – Install Touch Screen Driver

1. Click on the **Step 5 –Touch Screen Driver** folder and double click on **Setup.exe**
2. Follow the instructions that the window shows
3. The system will help you install the driver automatically

Appendix

**A**

**FAQ**

## **A.1 FAQ**

---

### **Installing Windows 2000 from a USB CD-ROM Drive May Cause a "Stop 0x7B" Error**

#### **Answer:**

Only if you install Windows 2000 SP3 version, the error will be automatically corrected.

Categorized List of Fixes in Windows 2000 Service Pack 3 (SP3)

<http://support.microsoft.com/default.aspx?scid=%2fsupport%2fservicepacks%2fwindows%2f2000%2fsp3fixlist.asp>

Q294820 - Installing Windows 2000 from a USB CD-ROM Drive May Cause a "Stop 0x7B" Error

<http://support.microsoft.com/default.aspx?scid=kb:en-us:294820>

PSS ID Number: 294820

Article Last Modified on 5/28/2003

The information in this article applies to:

Microsoft Windows 2000 Server SP1

Microsoft Windows 2000 Server SP2

Microsoft Windows 2000 Advanced Server SP1

Microsoft Windows 2000 Advanced Server SP2

Microsoft Windows 2000 Professional SP1

Microsoft Windows 2000 Professional SP2

This article was previously published under Q294820

## **SYMPTOMS**

If you are using a Universal Serial Bus (USB) CD-ROM drive to install Windows 2000 on certain legacy-free computers, you may receive a "Stop 0x0000007B" Inaccessible\_boot\_device error message while booting from the installation CD. Because many legacy-free computers do not have a standard CD-ROM drive or floppy disk drive, the USB CD-ROM drive may be the only method for installing or recovering Windows.

## **CAUSE**

Windows 2000 Setup does not support certain USB CD-ROM drives as bootable devices. This causes error message during the Text-mode portion of Setup.

## **RESOLUTION**

Please contact your computer manufacturer for information about obtaining updated Windows 2000 Setup disks that you can use to boot your computer with a USB CD-ROM device.

## **STATUS**

Microsoft has confirmed that this is a problem in the Microsoft products that are listed at the beginning of this article.

## A.2 FAQ

---

What does the Day/Night Mode button actually do?

**Answer:**

Day mode is the highest brightness for out door use, Night mode is lowest one for power saving and navigation safty.

## A.3 FAQ

---

What type of anti-glare treatment are you putting onto your touch screen and what is the LCD brightness reduction with this treatment?

**Answer:**

We use Low Reflection touch screen with Anti-Refelctive surface which incorporates "circular polarizer" films inside.It is new technology of Touch panel , which has several layers of films, applied to reduce the amount of reflection back into the users eye (Reflectivity: $1.5 \pm 1\%$ )and increase "contrast ratio" of display in outdoor environment.