

EPIC-KBS9

EPIC Board

User's Manual 2nd Ed

Copyright Notice

This document is copyrighted, 2018. All rights are reserved. The original manufacturer reserves the right to make improvements to the products described in this manual at any time without notice.

No part of this manual may be reproduced, copied, translated, or transmitted in any form or by any means without the prior written permission of the original manufacturer. Information provided in this manual is intended to be accurate and reliable. However, the original manufacturer assumes no responsibility for its use, or for any infringements upon the rights of third parties that may result from its use.

The material in this document is for product information only and is subject to change without notice. While reasonable efforts have been made in the preparation of this document to assure its accuracy, AAEMON assumes no liabilities resulting from errors or omissions in this document, or from the use of the information contained herein.

AAEMON reserves the right to make changes in the product design without notice to its users.

Acknowledgement

All other products' name or trademarks are properties of their respective owners.

- Microsoft Windows is a registered trademark of Microsoft Corp.
- Intel, Pentium, Celeron, and Xeon are registered trademarks of Intel Corporation
- Core, Atom are trademarks of Intel Corporation
- ITE is a trademark of Integrated Technology Express, Inc.
- IBM, PC/AT, PS/2, and VGA are trademarks of International Business Machines Corporation.

All other product names or trademarks are properties of their respective owners.

Packing List

Before setting up your product, please make sure the following items have been shipped:

Item	Quantity
● EPIC-KBS9	1
● 1702150155 SATA power cable	1
● 1709070500 SATA cable	1
● 9657666600 jumper cap	1
● Product DVD with drivers	1

If any of these items are missing or damaged, please contact your distributor or sales representative immediately.

About this Document

This User's Manual contains all the essential information, such as detailed descriptions and explanations on the product's hardware and software features (if any), its specifications, dimensions, jumper/connector settings/definitions, and driver installation instructions (if any), to facilitate users in setting up their product.

Users may refer to the AAEON.com for the latest version of this document.

Safety Precautions

Please read the following safety instructions carefully. It is advised that you keep this manual for future references

1. All cautions and warnings on the device should be noted.
2. Make sure the power source matches the power rating of the device.
3. Position the power cord so that people cannot step on it. Do not place anything over the power cord.
4. Always completely disconnect the power before working on the system's hardware.
5. No connections should be made when the system is powered as a sudden rush of power may damage sensitive electronic components.
6. If the device is not to be used for a long time, disconnect it from the power supply to avoid damage by transient over-voltage.
7. Always disconnect this device from any AC supply before cleaning.
8. While cleaning, use a damp cloth instead of liquid or spray detergents.
9. Make sure the device is installed near a power outlet and is easily accessible.
10. Keep this device away from humidity.
11. Place the device on a solid surface during installation to prevent falls
12. Do not cover the openings on the device to ensure optimal heat dissipation.
13. Watch out for high temperatures when the system is running.
14. Do not touch the heat sink or heat spreader when the system is running
15. Never pour any liquid into the openings. This could cause fire or electric shock.
16. As most electronic components are sensitive to static electrical charge, be sure to ground yourself to prevent static charge when installing the internal components. Use a grounding wrist strap and contain all electronic components in any static-shielded containers.

17. If any of the following situations arises, please the contact our service personnel:
 - i. Damaged power cord or plug
 - ii. Liquid intrusion to the device
 - iii. Exposure to moisture
 - iv. Device is not working as expected or in a manner as described in this manual
 - v. The device is dropped or damaged
 - vi. Any obvious signs of damage displayed on the device
18. **DO NOT LEAVE THIS DEVICE IN AN UNCONTROLLED ENVIRONMENT WITH TEMPERATURES BEYOND THE DEVICE'S PERMITTED STORAGE TEMPERATURES (SEE CHAPTER 1) TO PREVENT DAMAGE.**

Warning!



This device complies with Part 15 FCC Rules. Operation is subject to the following two conditions: (1) this device may not cause harmful interference, and (2) this device must accept any interference received including interference that may cause undesired operation.

Caution:

There is a danger of explosion if the battery is incorrectly replaced. Replace only with the same or equivalent type recommended by the manufacturer. Dispose of used batteries according to the manufacturer's instructions and your local government's recycling or disposal directives.

Attention:

Il y a un risque d'explosion si la batterie est remplacée de façon incorrecte. Ne la remplacer qu'avec le même modèle ou équivalent recommandé par le constructeur. Recycler les batteries usées en accord avec les instructions du fabricant et les directives gouvernementales de recyclage.

China RoHS Requirements (CN)

产品中有毒有害物质或元素名称及含量

AAEON Main Board/ Daughter Board/ Backplane

部件名称	有毒有害物质或元素					
	铅 (Pb)	汞 (Hg)	镉 (Cd)	六价铬 (Cr(VI))	多溴联苯 (PBB)	多溴二苯醚 (PBDE)
印刷电路板 及其电子组件	○	○	○	○	○	○
外部信号 连接器及线材	○	○	○	○	○	○
<p>O: 表示该有毒有害物质在该部件所有均质材料中的含量均在 SJ/T 11363-2006 标准规定的限量要求以下。</p> <p>X: 表示该有毒有害物质至少在该部件的某一均质材料中的含量超出 SJ/T 11363-2006 标准规定的限量要求。</p> <p>备注: 此产品所标示之环保使用期限, 系指在一般正常使用状况下。</p>						

China RoHS Requirement (EN)

Poisonous or Hazardous Substances or Elements in Products

AAEON Main Board/ Daughter Board/ Backplane

Component	Poisonous or Hazardous Substances or Elements					
	Lead (Pb)	Mercury (Hg)	Cadmium (Cd)	Hexavalent Chromium (Cr(VI))	Polybrominated Biphenyls (PBB)	Polybrominated Diphenyl Ethers (PBDE)
PCB & Other Components	○	○	○	○	○	○
Wires & Connectors for External Connections	○	○	○	○	○	○
<p>O: The quantity of poisonous or hazardous substances or elements found in each of the component's parts is below the SJ/T 11363-2006-stipulated requirement.</p> <p>X: The quantity of poisonous or hazardous substances or elements found in at least one of the component's parts is beyond the SJ/T 11363-2006-stipulated requirement.</p> <p>Note: The Environment Friendly Use Period as labeled on this product is applicable under normal usage only</p>						

Table of Contents

Chapter 1 - Product Specifications	1
1.1 Specifications	2
Chapter 2 – Hardware Information	1
2.1 Dimensions	2
2.2 Jumpers and Connectors.....	4
2.3 List of Jumpers	6
2.3.1 Clear CMOS Jumper (JP6).....	7
2.3.2 AT / ATX mode Selection (JP7).....	7
2.3.3 Front Panel PIN Header (JP9).....	8
2.4 List of Connectors.....	9
2.4.1 External +12V Input (CN2)	10
2.4.2 Audio Port (CN5)	10
2.4.3 RTC Battery Connector (CN6)	11
2.4.4 +5V Output for SATA HDD (CN7)	11
2.4.5 USB 2.0 Port (CN8)	11
2.4.6 USB 2.0 Port (CN9)	12
2.4.7 SATA Port (CN10).....	12
2.4.8 mini-Card / mSATA Connector (CN11).....	13
2.4.9 SATA Port (CN13).....	15
2.4.10 CPU FAN Connector (CN14).....	16
2.4.11 LPC Port (CN15).....	16
2.4.12 COM Port (CN16).....	17
2.4.13 COM Port (CN17).....	17
2.4.14 USB 2.0/3.0 Port 1~Port 2 (CN22).....	18
2.4.15 HDMI (CN23)	19
2.4.16 DIO (CN24)	20

2.4.17	External +12V Input [Reserved] (CN27)	20
2.4.18	CRT (CN31)	21
2.4.19	PCIe [x4] Slot (CN53)	21
2.4.20	LAN (RJ-45) Port1~4 (CN54)	22
2.4.21	System FAN Connector (CN56)	22
2.4.22	LAN (RJ-45) Port1~2 [Reserved] (CN57)	23
2.4.23	DDR4 SO-DIMM Slot (DIMM1 & DIMM2)	23
2.5	Block Diagram	24
Chapter 3 - BIOS Setup		25
3.1	System Test and Initialization	26
3.2	AMI BIOS Setup	27
3.3	Setup submenu: Main	28
3.4	Setup submenu: Advanced	29
3.4.1	CPU Configuration	30
3.4.2	SATA Configuration	31
3.4.3	SIO Configuration	32
3.4.3.1	Serial Port Configuration	33
3.4.4	Hardware Monitor	34
3.4.4.1	Smart Fan Mode Configuration	35
3.4.5	USB Configuration	37
3.4.6	Digital IO Port Configuration	39
3.4.7	Power Management	40
3.5	Setup submenu: Chipset	41
3.5.1	System Agent (SA) Configuration	42
3.5.1.1	Graphics Configuration	44
3.5.2	PCH-IO Configuration	45
3.6	Security	47
3.7	Submenu: Boot	48

3.7.1	BBS Priorities.....	49
3.8	Submenu: Exit.....	50
Chapter 4 – Drivers Installation.....		1
4.1	Product CD/DVD.....	2
Appendix A – Mating Connectors.....		4
A.1	List of Mating Connectors and Cables.....	5
Appendix B - I/O Information.....		6
B.1	I/O Address Map.....	7
B.2	Memory Address Map.....	9
B.3	IRQ Mapping Chart.....	11
Appendix C – Digital I/O Ports.....		13
C.1	Digital I/O Register.....	14
C.2	Digital I/O Sample Code.....	17

Chapter 1

Product Specifications

1.1 Specifications

System

● Form Factor	4" EPIC Board
● CPU	CPU Socket Type
● CPU Frequency	6th/7th Generation Intel® Core™ i3/i5/i7/Celeron® (Support up to 65W SKU)
● Chipset	H110/Q170 (6W)
● Memory Type	DDR4 (Non-ECC) SODIMM x 2, 2133MHz, up to 32G
● Max. Memory Capacity	Up to 32G
● BIOS	AMI
● Wake On LAN	Yes
● Watchdog Timer	255 Levels
● Power Requirement	+12V, AT/ATX
● Power Supply Type	AT/ ATX
● Power Consumption (Typical)	--
● Dimension (L x W)	4.53" x 6.50" (115mm x 165mm)
● Operating Temperature	32°F ~ 140°F (0°C ~ 60°C)
● Storage Temperature	-40°F ~ 176°F (-40°C ~ 85°C)
● Operation Humidity	0 ~ 90%, relative humidity, non-condensing
● MTBF (Hours)	--

- Certification CE/FCC

Display

- VGA/LCD Controller 6th/7th Generation Intel® Core™ i3/i5/i7/Celeron®
- Video Output HDMI (Rear), VGA (Internal Only)
- Backlight Inverter Supply --

I/O

- Ethernet Intel® i211 Gigabit Ethernet x 4
- Audio Realtek ALC269 (With 2W Amplifier)
- USB Port USB3.0 x 2 (Real IO)
USB2.0 x 2 (Internal)
- Serial Port COM x 2 (All Internal), RS-232/422/485
- Parallel Port --
- HDD Interface SATA 3.0 x 2
- FDD Interface --
- SSD mSATA x 1 (Full size -
H110 SKU: By BOM change for mPCIe
Q170 SKU: By BIOS change for mPCIe)
- Expansion Slot Mini-PCIe slot (Share with mSATA as above)
PCIe[x4] Slot x 1 (Q170 SKU)
- DIO 8-bit
- TPM --

- Touch --

Chapter 2

Hardware Information

2.1 Dimensions

Component Side

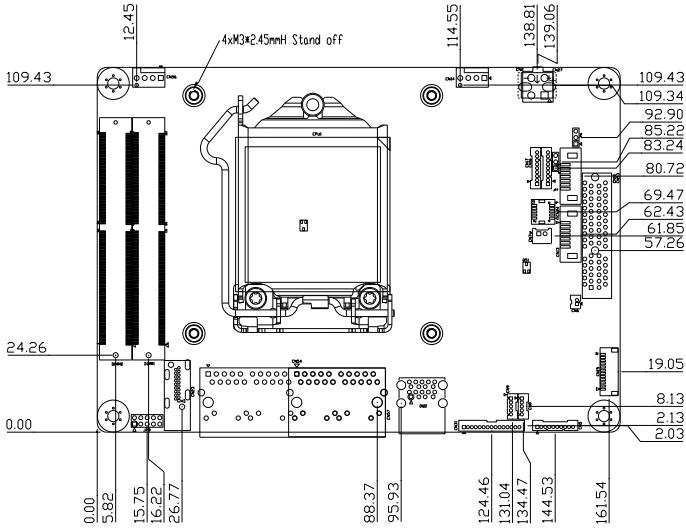

Component Side

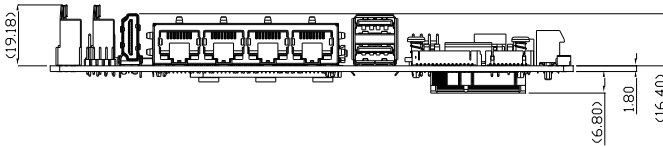

Solder Side

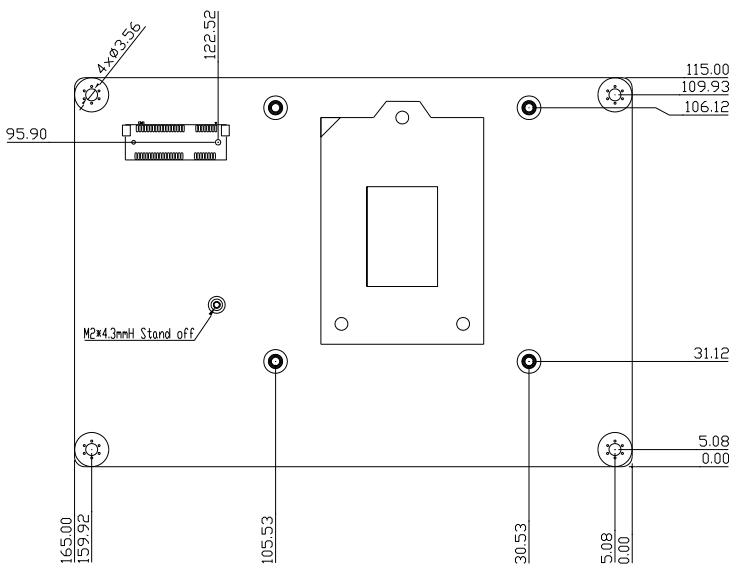

Solder Side

2.2 Jumpers and Connectors

Component Side

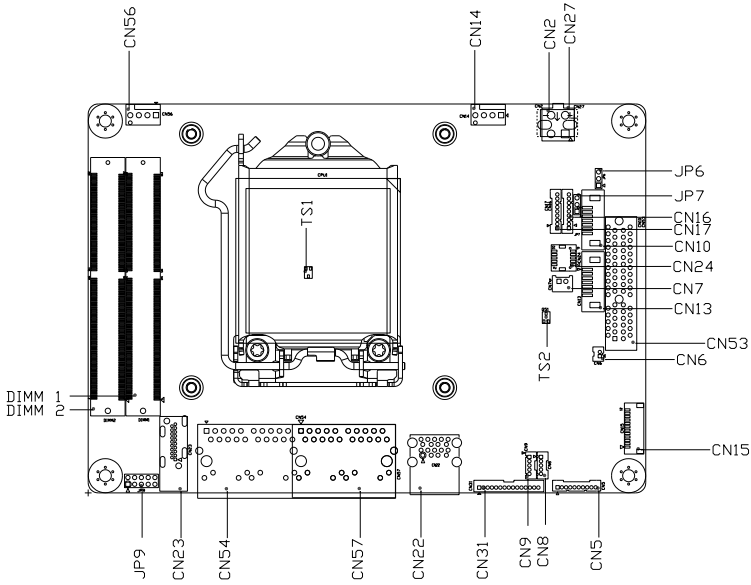

Component Side

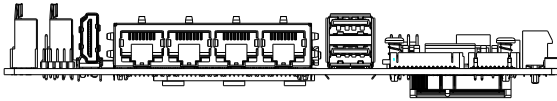

Solder Side

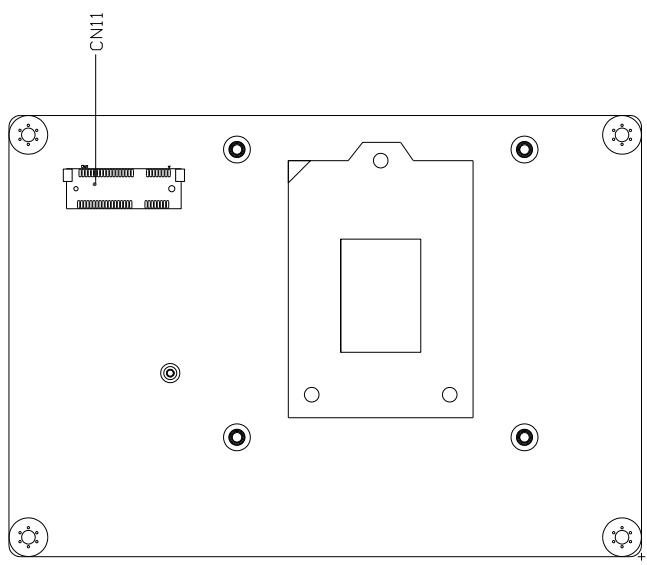

Solder Side

2.3 List of Jumpers

Please refer to the table below for all of the board's jumpers that you can configure for your application

Label	Function
JP6	Clear CMOS Jumper
JP7	AT / ATX Mode Selection
JP9	Front Panel PIN Header

2.3.1 Clear CMOS Jumper (JP6)

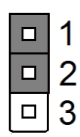

Normal (Default)

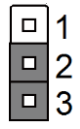

Clear CMOS

2.3.2 AT / ATX mode Selection (JP7)

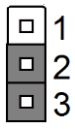

AT mode (Default)

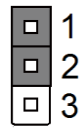

ATX mode

2.3.3 Front Panel PIN Header (JP9)

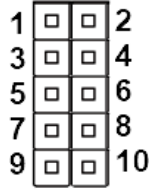

Pin	Pin Name	Signal Type	Signal Level
1	GND	GND	
2	EXT_PWRBTN#	IN	
3	HDD_LED-	OUT	GND
4	HDD_LED+	OUT	+3.3V
5	SPKR-	OUT	GND
6	SPKR+	OUT	+5V
7	GND	GND	
8	PWR_LED+	OUT	+3.3V
9	GND	GND	
10	HWRST#	IN	

2.4 List of Connectors

Please refer to the table below for all of the board's connectors that you can configure for your application

Label	Function
CN2	External +12V Input [Default]
CN5	Audio Port
CN6	RTC Battery Connector
CN7	+5V Output for SATA HDD
CN8	USB 2.0 Port
CN9	USB 2.0 Port
CN10	SATA Port
CN11	Mini-Card / mSATA Connector
CN13	SATA Port
CN14	CPU FAN Connector
CN15	LPC Port
CN16	COM Port
CN17	COM Port
CN22	USB 2.0/3.0 Port 1~Port 2
CN23	HDMI
CN24	DIO
CN27	External +12V Input [Reserved]
CN31	CRT
CN53	PCIE x 4 Slot
CN54	LAN (RJ-45) Port 1~Port 4
CN56	System FAN Connector
CN57	LAN (RJ-45) Port 1~Port 2 [Reserved]
DIMM1	DDR4 SO-DIMM

DIMM2

DDR4 SO-DIMM

2.4.1 External +12V Input (CN2)

Pin	Pin Name	Signal Type	Signal Level
1	+12V	PWR	+12V
2	GND	GND	

2.4.2 Audio Port (CN5)

Pin	Pin Name	Signal Type	Signal Level
1	MIC_L		
2	MIC_R		
3	GND		
4	LIN_L		
5	LIN_R		
6	GND	GND	
7	LOUT_L		
8	GND	GND	
9	LOUT_R		
10	+V5A_AUD	PWR	+5V

2.4.3 RTC Battery Connector (CN6)

Pin	Pin Name	Signal Type	Signal Level
1	+3.3V	PWR	+3.3V
2	GND	GND	

2.4.4 +5V Output for SATA HDD (CN7)

Pin	Pin Name	Signal Type	Signal Level
1	+V5S	PWR	+5V
2	GND	GND	

2.4.5 USB 2.0 Port (CN8)

Pin	Pin Name	Signal Type	Signal Level
1	+V5A_USB	PWR	+5V
2	USB2_D-	DIFF	
3	USB2_D+	DIFF	
4	GND	GND	
5	GND	GND	

2.4.6 USB 2.0 Port (CN9)

Pin	Pin Name	Signal Type	Signal Level
1	+V5A_USB	PWR	+5V
2	USB2_D-	DIFF	
3	USB2_D+	DIFF	
4	GND	GND	
5	GND	GND	

2.4.7 SATA Port (CN10)

Pin	Pin Name	Signal Type	Signal Level
1	GND	GND	
2	SATA_TX+	DIFF	
3	SATA_TX-	DIFF	
4	GND	GND	
5	SATA_RX-	DIFF	
6	SATA_RX+	DIFF	
7	GND	GND	

2.4.8 mini-Card / mSATA Connector (CN11)

Pin	Pin Name	Signal Type	Signal Level
1	PCIE_WAKE#	IN	
2	+3.3VSB/+3.3V	PWR	+3.3V
3	NC		
4	GND	GND	
5	NC		
6	+1.5V	PWR	+1.5V
7	PCIE_CLK_REQ#	IN	
8	UIM_PRW	PWR	
9	GND	GND	
10	UIM_DATA	I/O	
11	PCIE_REF_CLK-	DIFF	
12	UIM_CLK	IN	
13	PCIE_REF_CLK+	DIFF	
14	UIM_RST	IN	
15	GND	GND	
16	UIM_VPP	PWR	
17	NC		
18	GND	GND	
19	NC		
20	W_DISABLE#	OUT	+3.3V

21	GND	GND	
22	PCIE_RST#	OUT	+3.3V
23	PCIE_RX-/mSATARX+	DIFF	
24	+3.3VSB/+3.3V	PWR	+3.3V
25	PCIE_RX+/mSATARX-	DIFF	
26	GND	GND	
27	GND	GND	
28	+1.5V	PWR	+1.5V
29	GND	GND	
30	SMB_CLK	I/O	+3.3V
31	PCIE_TX-/mSATATX-	DIFF	
32	SMB_DATA	I/O	+3.3V
33	PCIE_TX+/mSATATX+	DIFF	
34	GND	GND	
35	GND	GND	
36	USB_D-	DIFF	
37	GND	GND	
38	USB_D+	DIFF	
39	+3.3VSB/+3.3V	PWR	+3.3V
40	GND	GND	
41	+3.3VSB/+3.3V	PWR	+3.3V
42	NC		

43	GND	GND	
44	NC		
45	NC		
46	NC		
47	NC		
48	+1.5V	PWR	+1.5V
49	NC		
50	GND	GND	
51	NC		
52	+3.3VSB/+3.3V	PWR	+3.3V

2.4.9 SATA Port (CN13)

Pin	Pin Name	Signal Type	Signal Level
1	GND	GND	
2	SATA_TX+	DIFF	
3	SATA_TX-	DIFF	
4	GND	GND	
5	SATA_RX-	DIFF	
6	SATA_RX+	DIFF	
7	GND	GND	

2.4.10 CPU FAN Connector (CN14)

Pin	Pin Name	Signal Type	Signal Level
1	GND	GND	
2	+V12S/+V5S	PWR	+12V/+5V
3	TACH	IN	
4	PWM	OUT	

※ +12V/+5V can be set by BOM(R768-+12V/R766-+5V) [Default: +12V]

2.4.11 LPC Port (CN15)

Pin	Pin Name	Signal Type	Signal Level
1	LAD0	IN/OUT	+3.3V
2	LAD1	IN/OUT	+3.3V
3	LAD2	IN/OUT	+3.3V
4	LAD3	IN/OUT	+3.3V
5	+V3.3S	PWR	+3.3V
6	LFRAME#	IN	
7	LRESET#	OUT	+3.3V
8	GND	GND	
9	LCLK	OUT	
10	SMB_DATA/ I2C_SDA	IN/OUT	
11	SMB_CLK/ I2C_CLK	OUT	
12	SMB_ALERT/	IN	+3.3V

INT_SERIRQ

2.4.12 COM Port (CN16)

Pin	Pin Name	Signal Type	Signal Level
1	DCD	IN	
2	DSR	IN	
3	RX	IN	
4	RTS	OUT	±9V
5	TX	OUT	±9V
6	CTS	IN	
7	DTR	OUT	±9V
8	RI/+5V/+12V	IN/ PWR	+5V/+12V
9	GND	GND	

※ COM RS-232/422/485 can be set by BIOS setting. Default is RS-232.

※ COM RI/+5V/+12V function can be set by BOM(R1971-RI/R1972-+12V/R1973-+5V)

2.4.13 COM Port (CN17)

Pin	Pin Name	Signal Type	Signal Level
1	DCD	IN	
2	DSR	IN	
3	RX	IN	
4	RTS	OUT	±9V
5	TX	OUT	±9V
6	CTS	IN	

7	DTR	OUT	±9V
8	RI/+5V/+12V	IN/ PWR	+5V/+12V
9	GND	GND	

※ COM RS-232/422/485 can be set by BIOS setting. Default is RS-232.

※ COM RI/+5V/+12V function can be set by BOM(R1968-RI/R1970-+12V/R1969-+5V)

2.4.14 USB 2.0/3.0 Port 1~Port 2 (CN22)

Pin	Pin Name	Signal Type	Signal Level
1	+V5SB	PWR	+5V
2	USB3_D-	DIFF	
3	USB3_D+	DIFF	
4	GND	GND	
5	USB3_SSRX-	DIFF	
6	USB3_SSRX+	DIFF	
7	GND	GND	
8	USB3_SSTX-	DIFF	
9	USB3_SSTX+	DIFF	
10	+V5SB	PWR	+5V
11	USB4_D-	DIFF	
12	USB4_D+	DIFF	
13	GND	GND	
14	USB4_SSRX-	DIFF	
15	USB4_SSRX+	DIFF	
16	GND	GND	
17	USB4_SSTX-	DIFF	

18	USB4_SSTX+	DIFF
----	------------	------

2.4.15 HDMI (CN23)

Pin	Pin Name	Signal Type	Signal Level
1	HDMI_TX2+	DIFF	
2	GND	GND	
3	HDMI_TX2-	DIFF	
4	HDMI_TX1+	DIFF	
5	GND	GND	
6	HDMI_TX1-	DIFF	
7	HDMI_TX0+	DIFF	
8	GND	GND	
9	HDMI_TX0-	DIFF	
10	HDMI_CLK+	DIFF	
11	GND	GND	
12	HDMI_CLK-	DIFF	
13	NC		
14	NC		
15	DDC_CLK	I/O	+5V
16	DDC_DATA	I/O	+5V
17	GND	GND	
18	+5V	PWR	+5V

19	HDMI_HPD
----	----------

2.4.16 DIO (CN24)

Pin	Pin Name	Signal Type	Signal Level
1	DIO0		
2	DIO1		
3	DIO2		
4	DIO3		
5	DIO4		
6	DIO5		
7	DIO6		
8	DIO7		
9	+V5S	PWR	+5V
10	GND	GND	

2.4.17 External +12V Input [Reserved] (CN27)

Pin	Pin Name	Signal Type	Signal Level
1	GND	GND	
2	GND	GND	
3	+12V	PWR	+12V
4	+12V	PWR	+12V

2.4.18 CRT (CN31)

Pin	Pin Name	Signal Type	Signal Level
1	RED		
2	GREEN		
3	BLUE		
4	NC		
5	GND	GND	
6	GND	GND	
7	GND	GND	
8	GND	GND	
9	+V5S_DISP_CON	PWR	+5V
10	GND	GND	
11	NC		
12	DATA		
13	HSY		
14	VSX		
15	CLK		

2.4.19 PCIE [x4] Slot (CN53)

Standard specification

2.4.20 LAN (RJ-45) Port1~4 (CN54)

Pin	Pin Name	Signal Type	Signal Level
1	MDI0+	DIFF	
2	MDI0-	DIFF	
3	MDI1+	DIFF	
4	MDI2+	DIFF	
5	MDI2-	DIFF	
6	MDI1-	DIFF	
7	MDI3+	DIFF	
8	MDI3-	DIFF	

2.4.21 System FAN Connector (CN56)

Pin	Pin Name	Signal Type	Signal Level
1	GND	GND	
2	+V12S/+V5S	PWR	+12V/+5V
3	TACH	IN	
4	PWM	OUT	

※ +12V/+5V can be set by BOM(R2146-+12V/R2145-+5V) [Default:+12V]

2.4.22 LAN (RJ-45) Port1~2 [Reserved] (CN57)

Pin	Pin Name	Signal Type	Signal Level
1	MDI0+	DIFF	
2	MDI0-	DIFF	
3	MDI1+	DIFF	
4	MDI2+	DIFF	
5	MDI2-	DIFF	
6	MDI1-	DIFF	
7	MDI3+	DIFF	
8	MDI3-	DIFF	

2.4.23 DDR4 SO-DIMM Slot (DIMM1 & DIMM2)

Standard specification

2.5 Block Diagram

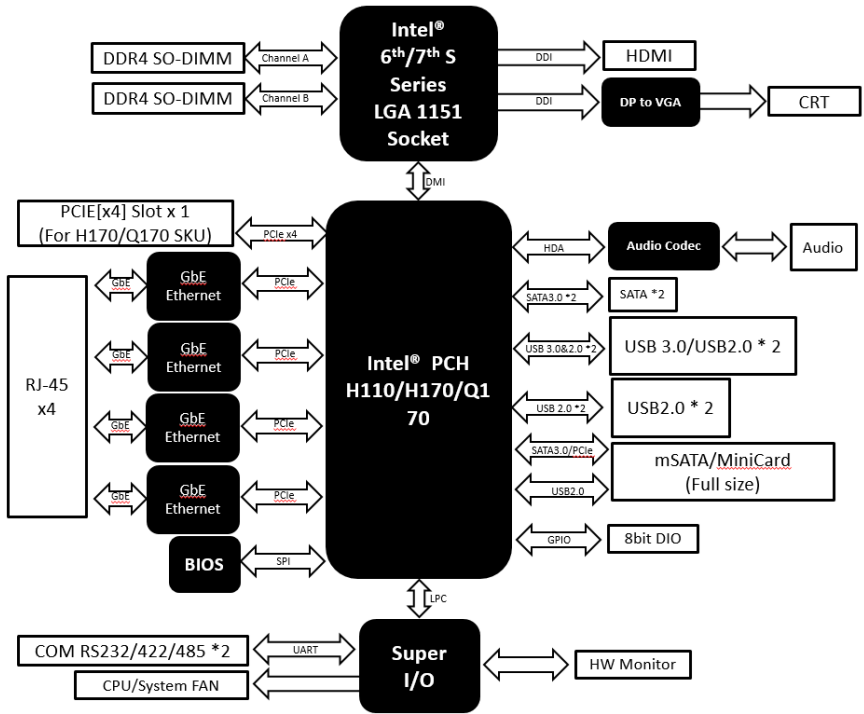

Chapter 3

BIOS Setup

3.1 System Test and Initialization

These routines test and initialize board hardware. If the routines encounter an error during the tests, you will either hear a few short beeps or see an error message on the screen. There are two kinds of errors: fatal and non-fatal. The system can usually continue the boot up sequence with non-fatal errors.

System configuration verification

These routines check the current system configuration stored in the CMOS memory and BIOS NVRAM. If system configuration is not found or system configuration data error is detected, system will load optimized default and re-boot with this default system configuration automatically.

There are four situations in which you will need to setup system configuration:

1. You are starting your system for the first time
2. You have changed the hardware attached to your system
3. The system configuration is reset by Clear-CMOS jumper
4. The CMOS memory has lost power and the configuration information has been erased.

The EPIC-KBS9 CMOS memory has an integral lithium battery backup for data retention. However, you will need to replace the complete unit when it finally runs down.

3.2 AMI BIOS Setup

AMI BIOS ROM has a built-in Setup program that allows users to modify the basic system configuration. This type of information is stored in battery-backed CMOS RAM and BIOS NVRAM so that it retains the Setup information when the power is turned off.

Entering Setup

Power on the computer and press or <ESC> immediately. This will allow you to enter Setup.

Main – Date and time can be set here. Press <Tab> to switch between date elements

Advanced – Enable/ Disable boot option for legacy network devices

Chipset – For hosting bridge parameters

Boot – Enable/ Disable quiet Boot Option

Security – The setup administrator password can be set here

Save & Exit – Save your changes and exit the program

3.3 Setup submenu: Main

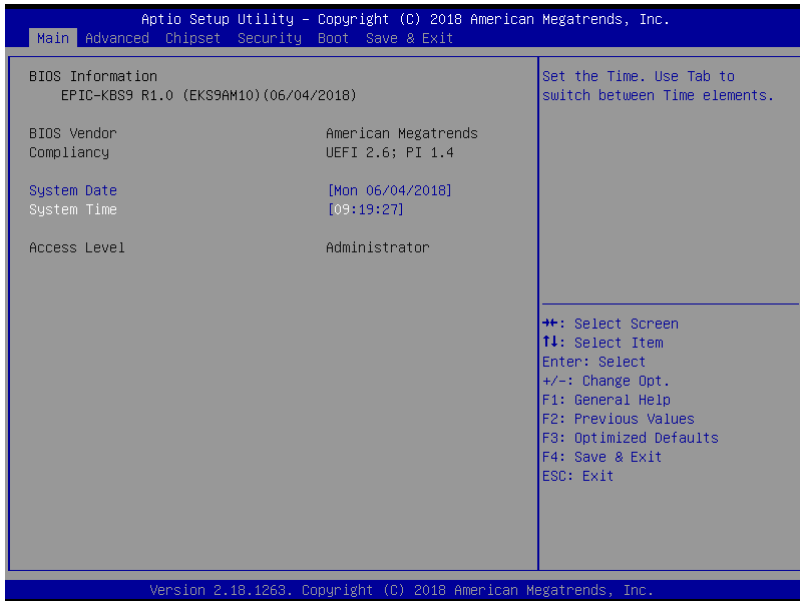

3.4 Setup submenu: Advanced

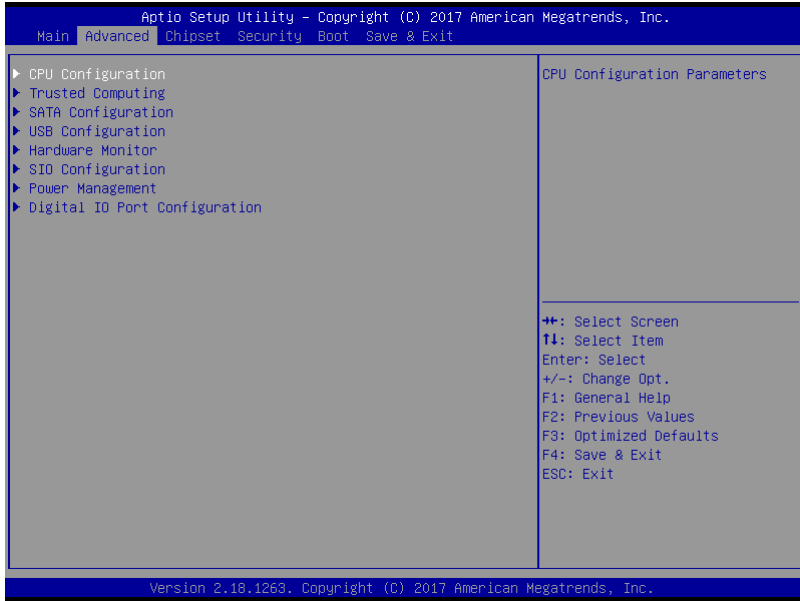

3.4.1 CPU Configuration

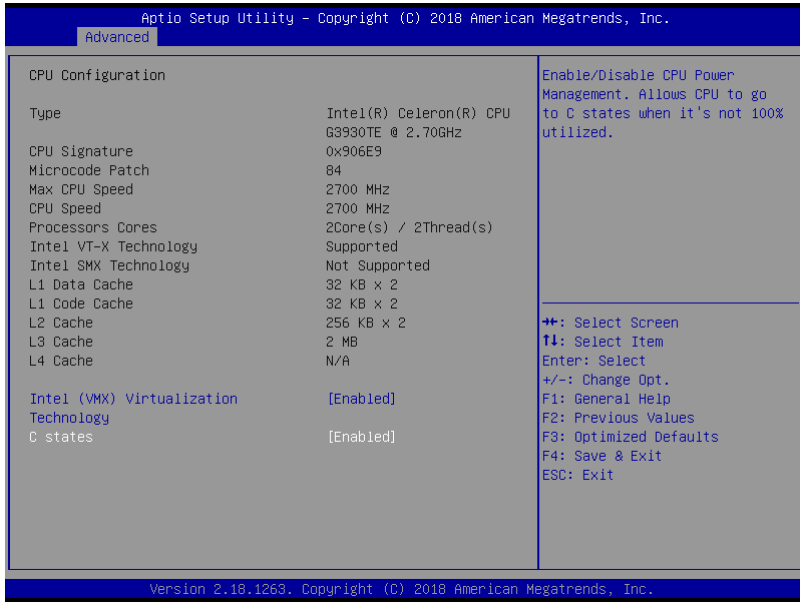

Options summary:

Intel (VMX)	Disabled	
Virtualization Technology	Enabled	Optimal Default, Failsafe Default
When enabled, a VMM can utilize the additional hardware capabilities provided by Vanderpool Technology.		
C states	Disabled	
	Enabled	Optimal Default, Failsafe Default
Enabled for Windows XP and Linux (OS optimized for Hyper-Threading Technology) and Disable for other OS (OS not optimized for Hyper-Threading Technology). When Disabled only one thread per enabled core is enabled.		

3.4.2 SATA Configuration

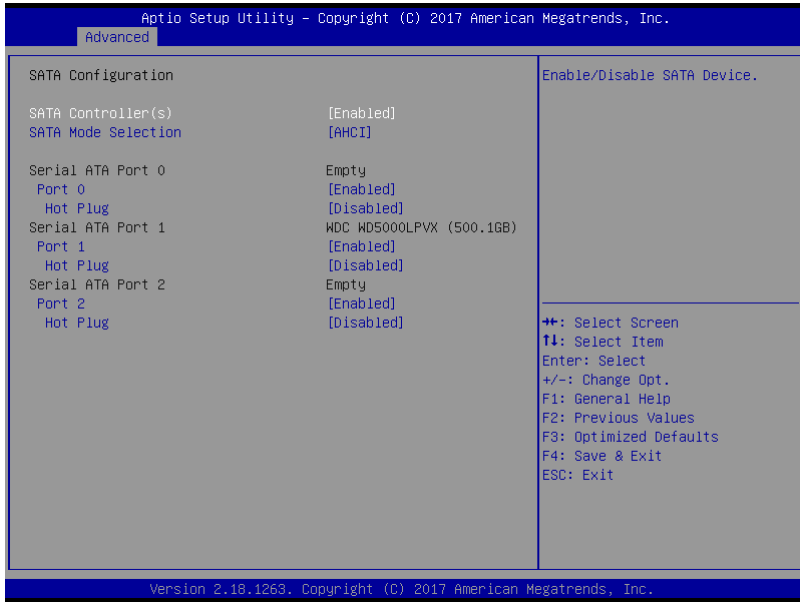

Options summary:

SATA Controller(s)	Enabled	Optimal Default, Failsafe Default
	Disabled	
Enable or disable SATA Device.		
SATA Mode	AHCI Mode	Optimal Default, Failsafe Default
	RAID Mode	
Determines how SATA controller(s) operate.		
Port 0	Disabled	
	Enabled	Optimal Default, Failsafe Default
Enable or Disable SATA Port.		
Hot Plug	Disabled	Optimal Default, Failsafe Default
	Enabled	
Designates this port as Hot Pluggable.		

3.4.3 SIO Configuration

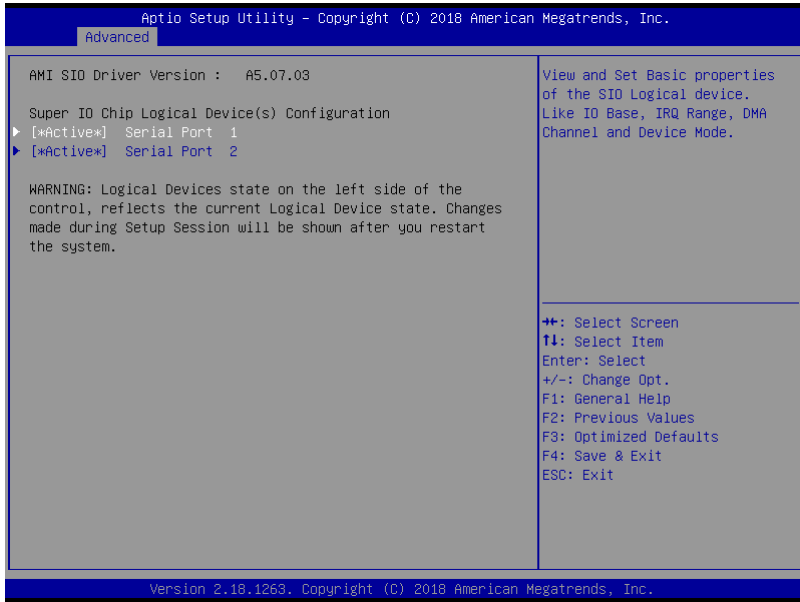

3.4.3.1 Serial Port Configuration

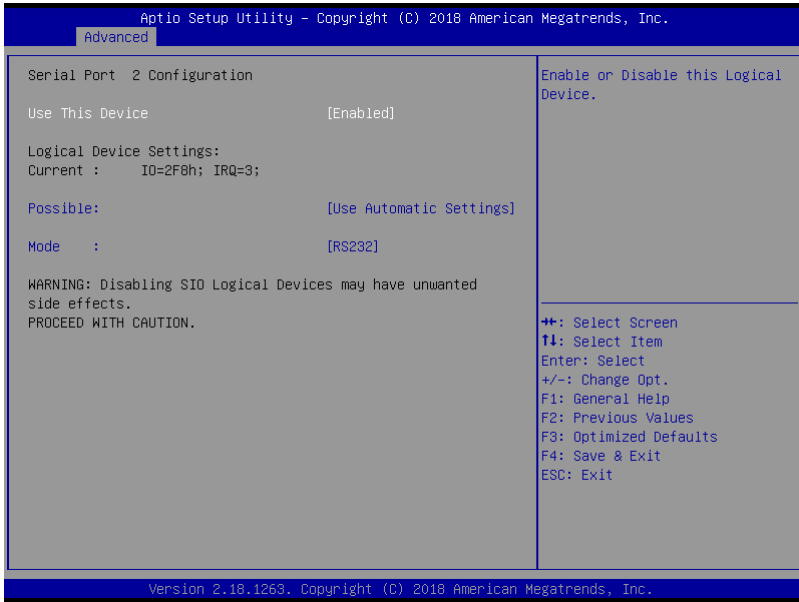

Options summary:

Use This Device	Disabled	Optimal Default, Failsafe Default
	Enabled	
En/Disable Serial Port (COM)		
Possible:	Use Automatic Settings	Optimal Default, Failsafe Default
	IO=2F8; IRQ=3;	
	IO=3F8; IRQ=4;	
Select an optimal setting for IO device		
mode	RS232	Optimal Default, Failsafe Default
	RS422	
	RS485	
Uart RS232/422/485 selection		

3.4.4 Hardware Monitor

Aptio Setup Utility - Copyright (C) 2018 American Megatrends, Inc.

Advanced

<p>Pc Health Status</p> <p>CPU Temperature(DTS) : +55 ℃ System Temperature1 : +37 ℃ System Temperature2 : +46 ℃ Fan1 Speed : 1270 RPM Fan2 Speed : N/A VCCORE : +0.920 V +12V : +11.968 V +5V : +5.171 V VMEM : +1.232 V</p> <p>Smart Fan [Enabled]</p> <p>▶ Smart Fan Mode Configuration</p>	<p>Enable or Disable Smart Fan</p> <hr/> <p>++: Select Screen ↑↓: Select Item Enter: Select +/-: Change Opt. F1: General Help F2: Previous Values F3: Optimized Defaults F4: Save & Exit ESC: Exit</p>
---	--

Version 2.18.1263. Copyright (C) 2018 American Megatrends, Inc.

3.4.4.1 Smart Fan Mode Configuration

Options summary:

Fan1 Smart Fan control	Manual Duty Mode	Optimal Default, Failsafe Default
	Auto Duty-Cycle Mode	
Fan2 Smart Fan control	Manual Duty Mode	Optimal Default, Failsafe Default
	Auto Duty-Cycle Mode	

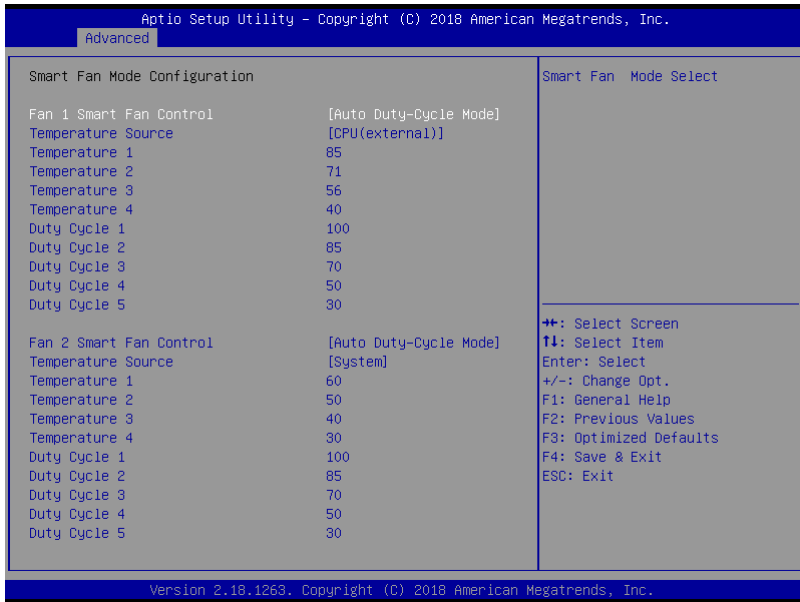

Options summary:

Manual Setting	60	Optimal Default, Failsafe Default
Set Fan at fixed Duty-Cycle Min=0 Max=100 Please input Dec number:		

Aptio Setup Utility - Copyright (C) 2018 American Megatrends, Inc.

Advanced

Smart Fan Mode Configuration	Smart Fan Mode Select
Fan 1 Smart Fan Control [Manual Duty Mode] Manual Duty Mode 60	
Fan 2 Smart Fan Control [Manual Duty Mode] Manual Duty Mode 60	
	++: Select Screen ↑: Select Item Enter: Select +/-: Change Opt. F1: General Help F2: Previous Values F3: Optimized Defaults F4: Save & Exit ESC: Exit

Version 2.18.1263. Copyright (C) 2018 American Megatrends, Inc.

3.4.5 USB Configuration

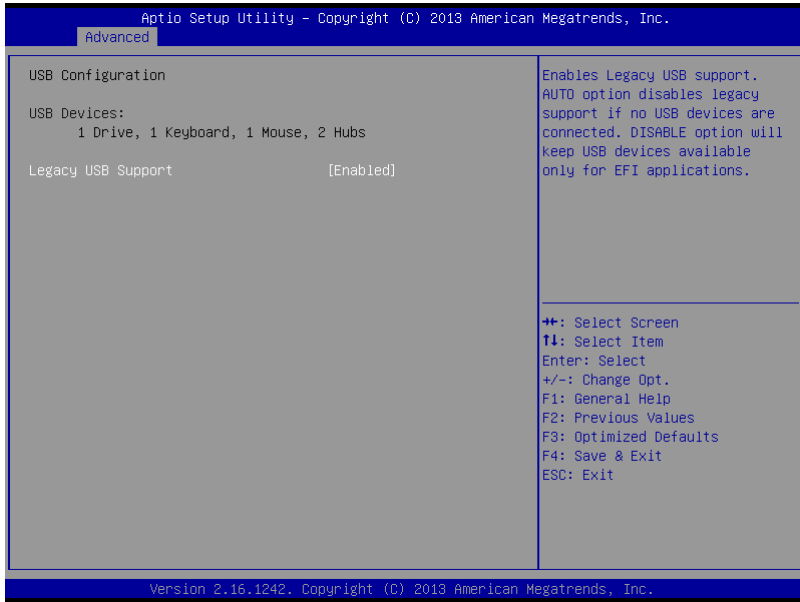

Options summary:

Legacy USB Support	Enabled	Optimal Default, Failsafe Default
	Disabled	
	Auto	
<p>Enables BIOS Support for Legacy USB Support. When enabled, USB can be functional in legacy environment like DOS.</p> <p>AUTO option disables legacy support if no USB devices are connected</p>		
Device Name (Emulation Type)	Auto	Optimal Default, Failsafe Default
	Floppy	
	Forced FDD	
	Hard Disk	
	CDROM	

If Auto. USB devices less than 530MB will be emulated as Floppy and remaining as Floppy and remaining as hard drive. Forced FDD option can be used to force a HDD formatted drive to boot as FDD(Ex. ZIP drive)

USB Port 0/1 function	FCH USB port 8/9	Optimal Default, Failsafe Default
routing	FCH USB port 0/1	

3.4.6 Digital IO Port Configuration

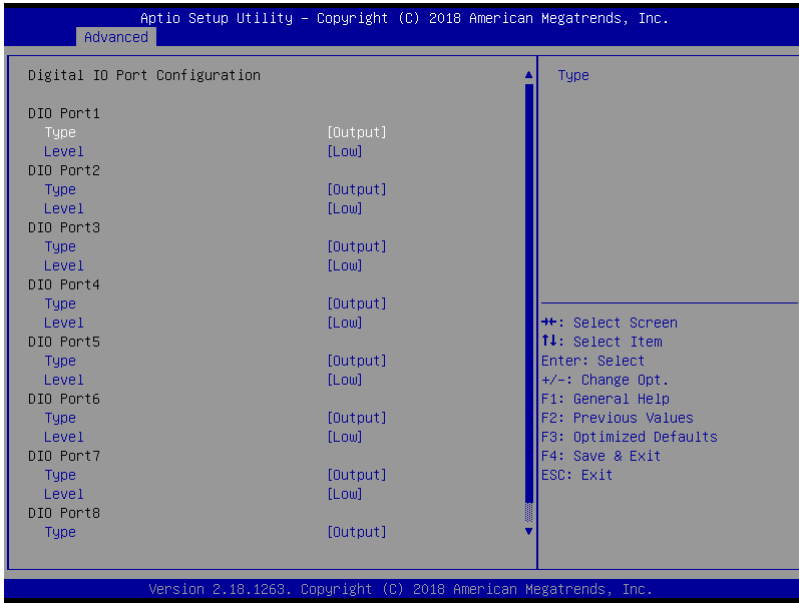

Options summary:

DIO Port*	Output	
	Input	
Set DIO as Input or Output		
Output Level	High	
	Low	
Set output level when DIO pin is output		

3.4.7 Power Management

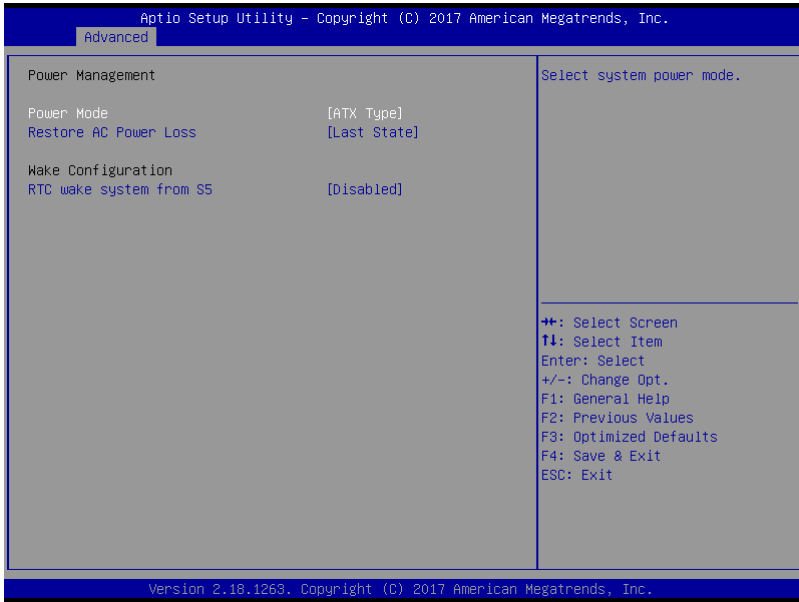

Options summary:

Power Mode	ATX Type	Optimal Default, Failsafe Default
	AT Type	
Select power supply mode.		
Restore AC Power LOSS	Last State	Optimal Default, Failsafe Default
	Power On	
	Power Off	
Select power state when power is re-applied after a power failure.		
RTC wake system from S5	Disabled	Optimal Default, Failsafe Default
	Fixed Time	
	Dynamic Time	
Enable or disable System wake on alarm event. When enabled, System will wake on the hr::min::sec specified		

3.5 Setup submenu: Chipset



3.5.1 System Agent (SA) Configuration

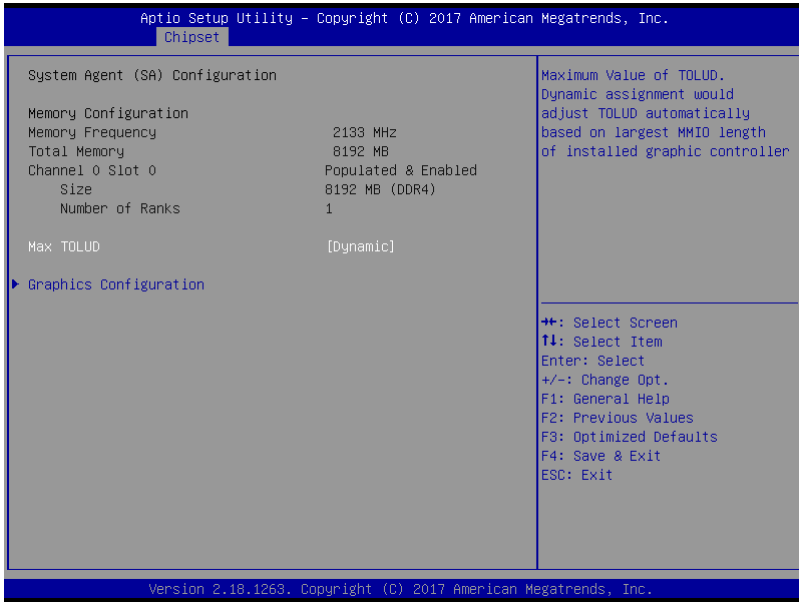

Options summary:

Max TOLUD	Dynamic	Optimal Default, Failsafe Default
	1 GB	
	1.25 GB	
	1.5 GB	
	1.75 GB	
	2 GB	
	2.25 GB	
	2.5 GB	
	2.75 GB	
	3 GB	
	3.25 GB	

Maximum Value of TOLUD Dynamic assignment would adjust TOLUD automatically based on largest MMIO length of installed graphic controller.

3.5.1.1 Graphics Configuration

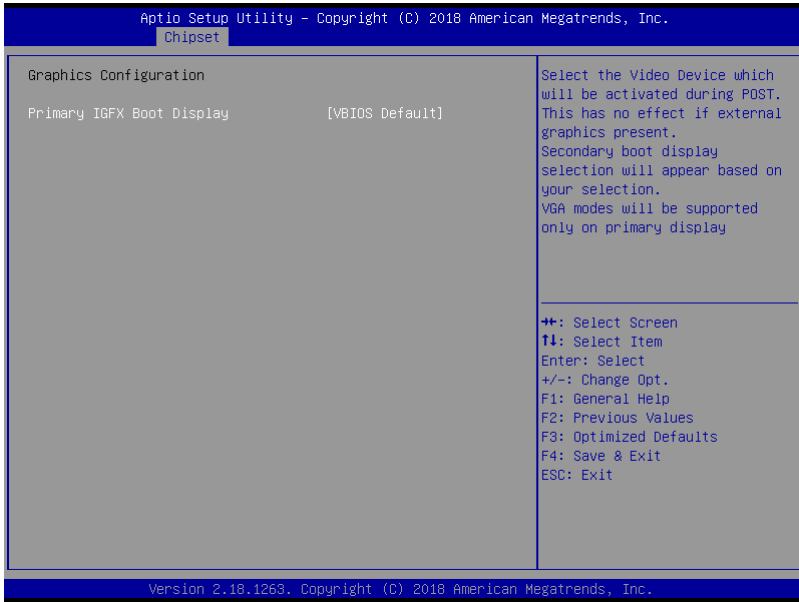

Options summary:

Primary IGFX Boot Display	VBIOS Default	Optimal Default, Failsafe Default
	CRT	
	HDMI	
<p>Select the Video Device which will be activated during POST. This has no effect if external graphic present.</p> <p>Secondary boot display selection will appear based on your selection.</p>		

3.5.2 PCH-IO Configuration

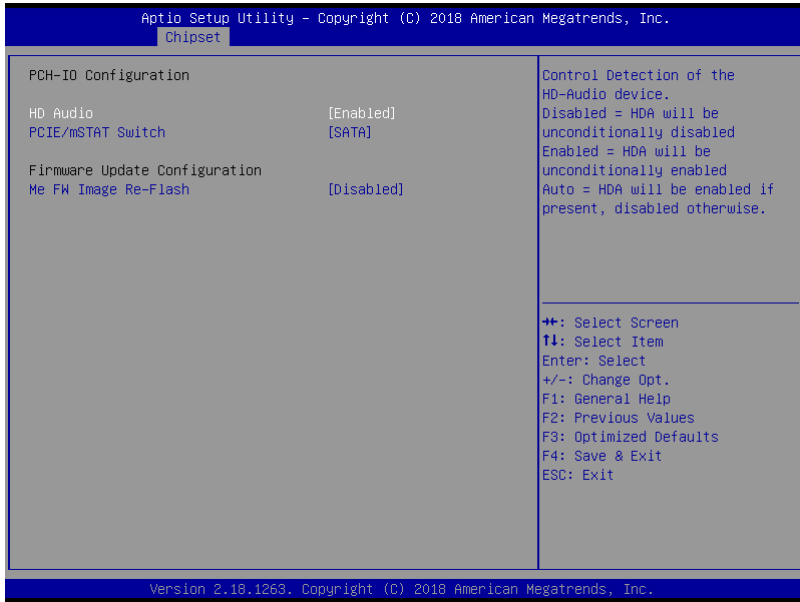

Options summary:

HD Audio	Disabled	Optimal Default, Failsafe Default
	Enabled	
	Auto	
Control Detection of the HD-Audio device. Disabled = HDA will be unconditionally disabled Enabled = HDA will be unconditionally enabled Auto = HDA will be enabled if present, disabled otherwise.		
PCIe/mSATA Switch	PCIE	Optimal Default, Failsafe Default
	SATA	
Select function enabled for Half-MiniCard(CN13) slot		
Me FW Image Re-Flash	Disabled	Optimal Default, Failsafe Default
	Enabled	

Enabled/Disable Me FW Image Re-Flash function.

3.6 Security

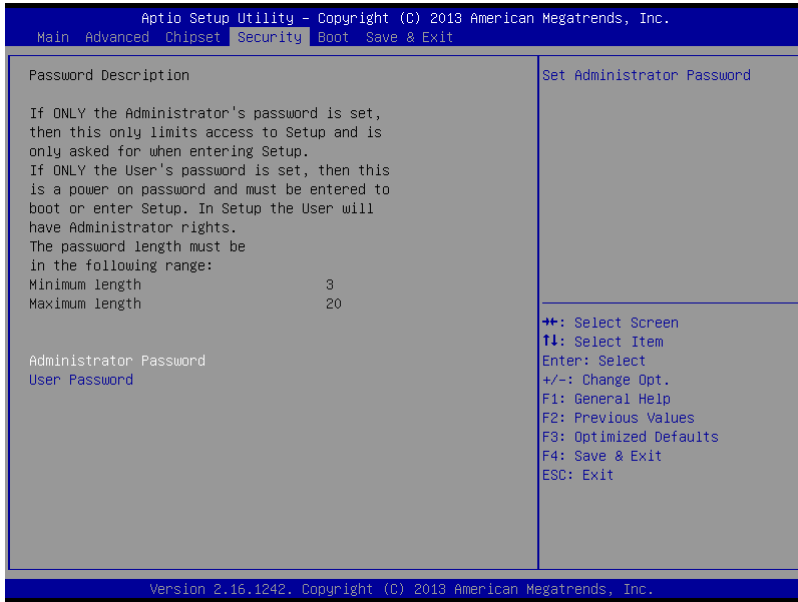

Change User/Supervisor Password

You can install a Supervisor password, and if you install a supervisor password, you can then install a user password. A user password does not provide access to many of the features in the Setup utility.

If you highlight these items and press Enter, a dialog box appears which lets you enter a password. You can enter no more than six letters or numbers. Press Enter after you have typed in the password. A second dialog box asks you to retype the password for confirmation. Press Enter after you have retyped it correctly. The password is required at boot time, or when the user enters the Setup utility.

Removing the Password

Highlight this item and type in the current password. At the next dialog box press Enter to disable password protection.

3.7 Submenu: Boot

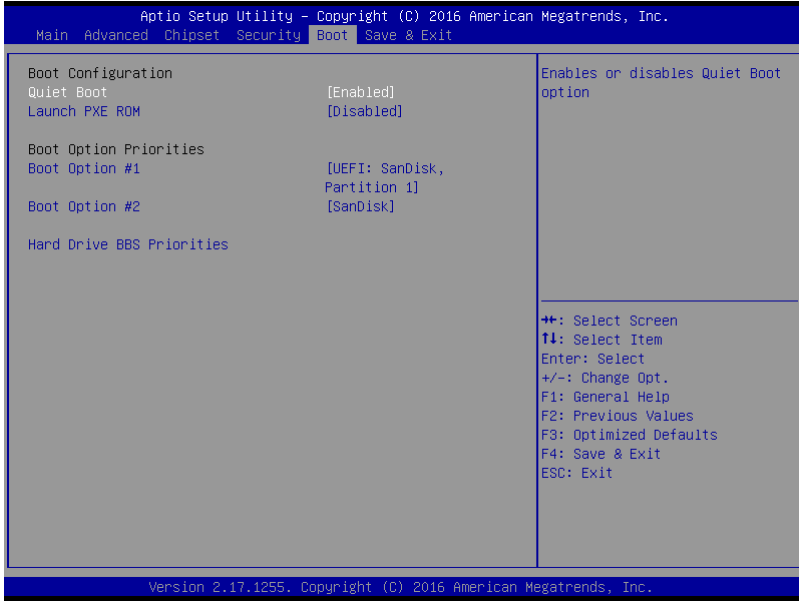

Options summary:

Quiet Boot	Disabled	Optimal Default, Failsafe Default
	Enabled	
En/Disable showing boot logo.		
Launch PXE OpROM	Disabled	Optimal Default, Failsafe Default
	Enabled	
Controls the execution of UEFI and Legacy PXE OpROM		

3.7.1 BBS Priorities

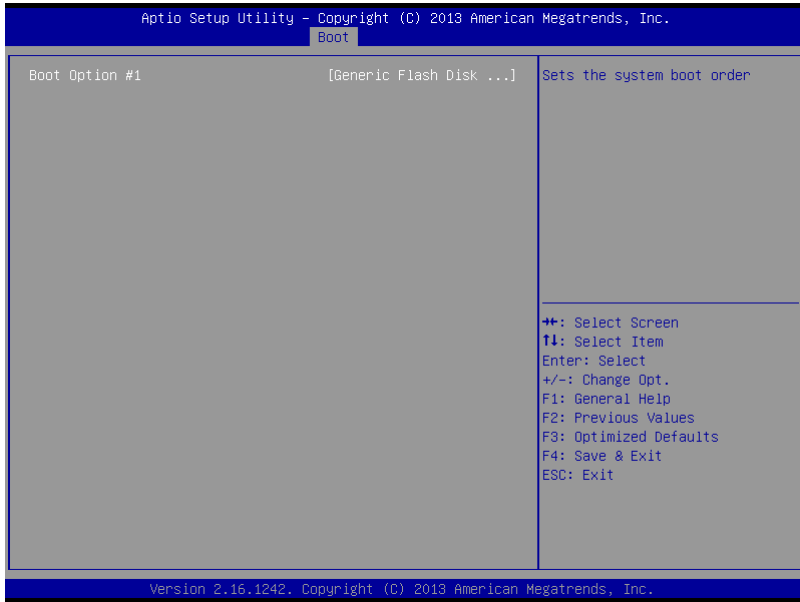

3.8 Submenu: Exit

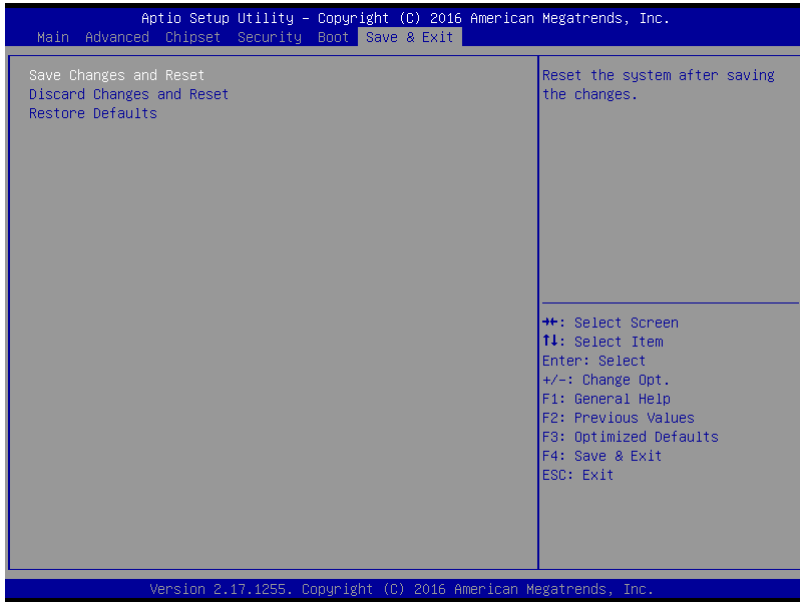

Chapter 4

Drivers Installation

4.1 Product CD/DVD

The EPIC-KBS9 comes with a product DVD that contains all the drivers and utilities you need to setup your product. Insert the DVD and follow the steps in the autorun program to install the drivers.

In case the program does not start, follow the sequence below to install the drivers.

Step 1 – Install Chipset Drivers

1. Open the **Step 1 – Chipset** folder and select your SKU and OS
2. Open the **SetupChipset.exe** file in the folder
3. Follow the instructions
4. Drivers will be installed automatically

Step 2 – Install Graphics Drivers

1. Open the **Step 2 - Graphic** folder and select your SKU and OS
2. Open the **Setup.exe** file in the folder
3. Follow the instructions
4. Drivers will be installed automatically

Step 3 – Install LAN Drivers

1. Open the **Step 3 – LAN** folder and select your SKU and OS
2. Open the **.exe** file in the folder
3. Follow the instructions
4. Drivers will be installed automatically

Step 4 – Install Audio Drivers

1. Open the **Step 4 – Audio** folder and select your SKU and OS

2. Open the **.exe** file in the folder
3. Follow the instructions
4. Drivers will be installed automatically

Step 5 – Install Serial Port Drivers

1. Open the **Step 5 – Serial Port Driver (Optional)** folder and select your SKU and OS
2. Open the **FintekSerial.exe** file in the folder
3. Follow the instructions
4. Drivers will be installed automatically

Appendix A

Mating Connectors

A.1 List of Mating Connectors and Cables

The table notes mating connectors and available cables.

Connector Label	Function	Mating Connector		Available Cable	Cable P/N
		Vendor	Model no		
CN2	External +12V Input	Molex	19211-0003	Power cable	170204010R
CN5	Audio Port	Molex	51021-1000	Audio cable	1709100254
CN6	RTC Battery Connector	Molex	51021-0200	Battery cable	175011301K
CN7	+5V Output for SATA HDD	JST	PHR-2	SATA power cable	1702150155
CN8	USB2.0 Port	Molex	51021-0500	USB Cable	1700050207
CN9	USB2.0 Port	Molex	51021-0500	USB Cable	1700050207
CN10	SATA Port	Molex	887505318	SATA Cable	1709070500
CN13	SATA Port	Molex	887505318	SATA Cable	1709070500
CN14	CPU FAN Connector	Molex	47054-1000	FAN	17592KBS90
CN15	LPC Connector	JST	SHR-12V-S-B	AAEON LPC Cable	1703120130
CN16	COM Port	Molex	51021-0900	COM Cable	1701090150
CN17	COM Port	Molex	51021-0900	COM Cable	1701090150
CN24	DIO	JCTC	11002H00-2x5P	N/A	N/A
CN27	External +12V Input [Reserved]	Molex	3901-2040	N/A	N/A
CN31	CRT Port	JWT	A1251H02-15	VGA Cable	1704150153
CN56	SYSTEM FAN Connector	Molex	47054-1000	FAN	17592KBS90

Appendix B

I/O Information

B.1 I/O Address Map

Device Manager

File Action View Help

DESKTOP-3OLI1TU

- Input/output (IO)
 - [0000000000000000 - 0000000000000CF7] PCI Express Root Complex
 - [0000000000000020 - 0000000000000021] Programmable interrupt controller
 - [0000000000000024 - 0000000000000025] Programmable interrupt controller
 - [0000000000000028 - 0000000000000029] Programmable interrupt controller
 - [000000000000002C - 000000000000002D] Programmable interrupt controller
 - [000000000000002E - 000000000000002F] Motherboard resources
 - [0000000000000030 - 0000000000000031] Programmable interrupt controller
 - [0000000000000034 - 0000000000000035] Programmable interrupt controller
 - [0000000000000038 - 0000000000000039] Programmable interrupt controller
 - [000000000000003C - 000000000000003D] Programmable interrupt controller
 - [0000000000000040 - 0000000000000043] System timer
 - [000000000000004E - 000000000000004F] Motherboard resources
 - [0000000000000050 - 0000000000000053] System timer
 - [0000000000000060 - 0000000000000060] Standard PS/2 Keyboard
 - [0000000000000061 - 0000000000000061] Motherboard resources
 - [0000000000000063 - 0000000000000063] Motherboard resources
 - [0000000000000064 - 0000000000000064] Standard PS/2 Keyboard
 - [0000000000000065 - 0000000000000065] Motherboard resources
 - [0000000000000067 - 0000000000000067] Motherboard resources
 - [0000000000000070 - 0000000000000070] Motherboard resources
 - [0000000000000070 - 0000000000000077] System CMOS/real time clock
 - [0000000000000080 - 0000000000000080] Motherboard resources
 - [0000000000000092 - 0000000000000092] Motherboard resources
 - [00000000000000A0 - 00000000000000A1] Programmable interrupt controller
 - [00000000000000A4 - 00000000000000A5] Programmable interrupt controller
 - [00000000000000A8 - 00000000000000A9] Programmable interrupt controller
 - [00000000000000AC - 00000000000000AD] Programmable interrupt controller
 - [00000000000000B0 - 00000000000000B1] Programmable interrupt controller
 - [00000000000000B2 - 00000000000000B3] Motherboard resources
 - [00000000000000B4 - 00000000000000B5] Programmable interrupt controller
 - [00000000000000B8 - 00000000000000B9] Programmable interrupt controller
 - [00000000000000BC - 00000000000000BD] Programmable interrupt controller
 - [00000000000000F0 - 00000000000000F0] Numeric data processor
 - [00000000000002F8 - 00000000000002FF] Communications Port (COM2)
 - [00000000000003B0 - 00000000000003BB] Intel(R) HD Graphics 610
 - [00000000000003C0 - 00000000000003DF] Intel(R) HD Graphics 610
 - [00000000000003F8 - 00000000000003FF] Communications Port (COM1)
 - [00000000000004D0 - 00000000000004D1] Programmable interrupt controller
 - [0000000000000680 - 000000000000069F] Motherboard resources
 - [0000000000000800 - 000000000000087F] Motherboard resources

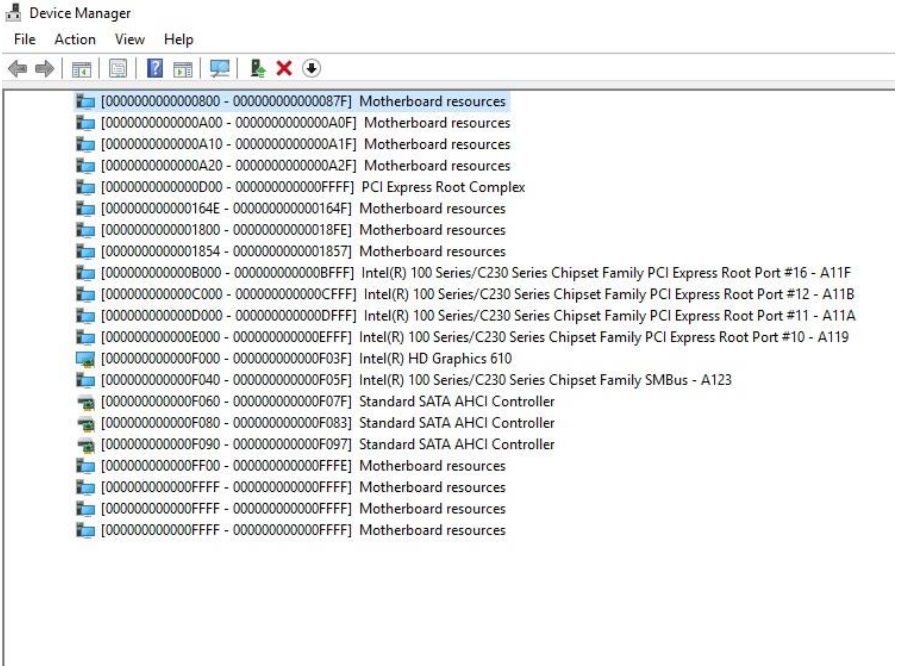

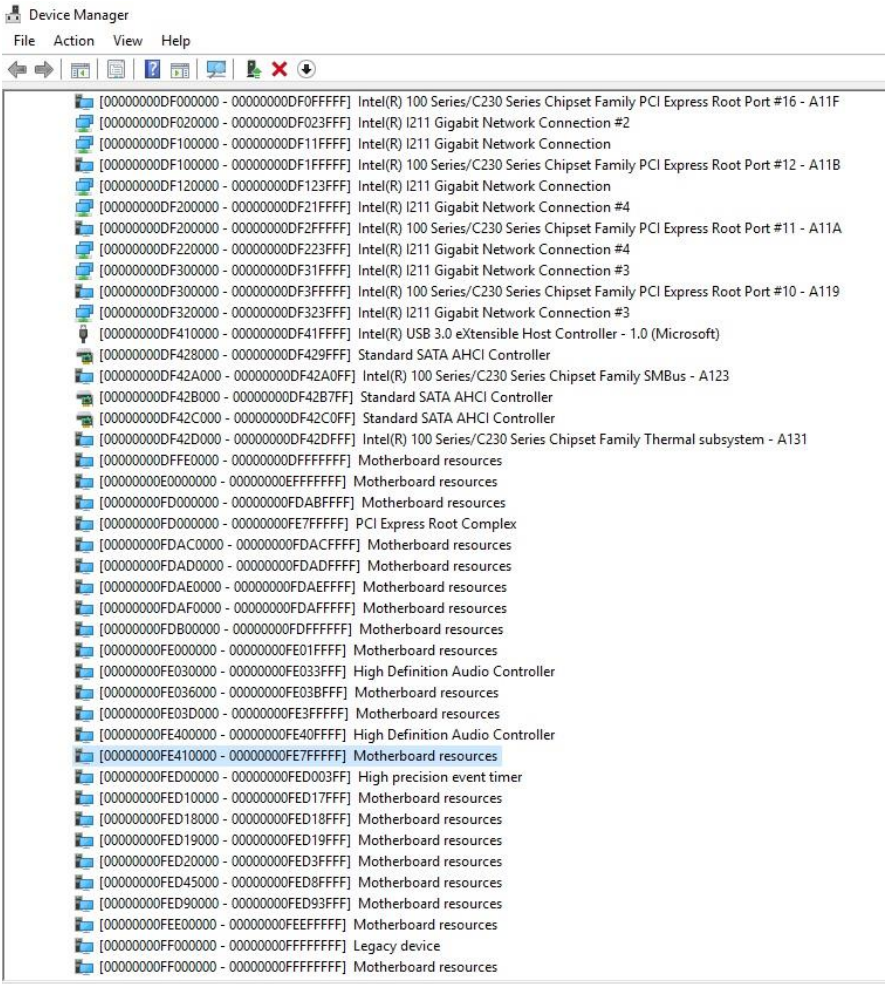

B.3 IRQ Mapping Chart

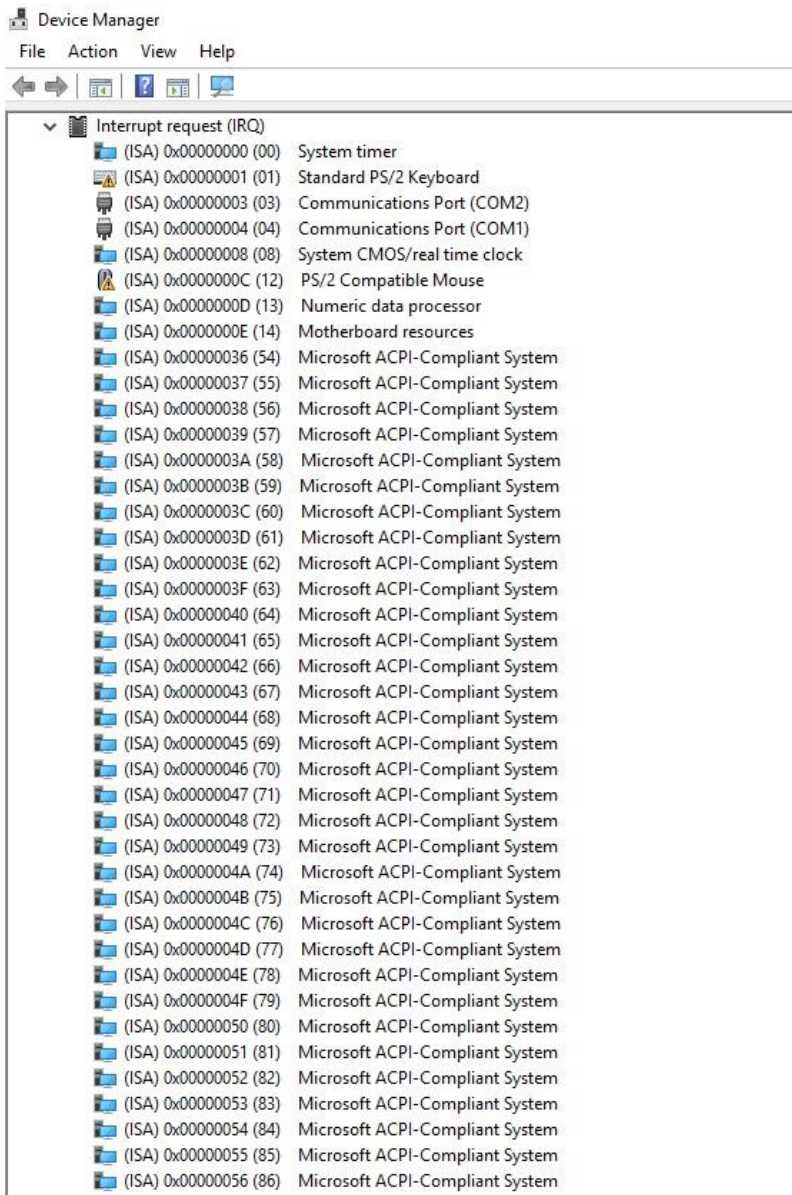

The screenshot displays the Windows Device Manager window, specifically the 'Interrupt request (IRQ)' section. The window title is 'Device Manager' and it has a menu bar with 'File', 'Action', 'View', and 'Help'. Below the menu bar are navigation icons. The main content area shows a tree view with 'Interrupt request (IRQ)' expanded, listing various hardware components and their assigned IRQs. The list includes:

- (ISA) 0x00000000 (00) System timer
- (ISA) 0x00000001 (01) Standard PS/2 Keyboard
- (ISA) 0x00000003 (03) Communications Port (COM2)
- (ISA) 0x00000004 (04) Communications Port (COM1)
- (ISA) 0x00000008 (08) System CMOS/real time clock
- (ISA) 0x0000000C (12) PS/2 Compatible Mouse
- (ISA) 0x0000000D (13) Numeric data processor
- (ISA) 0x0000000E (14) Motherboard resources
- (ISA) 0x00000036 (54) Microsoft ACPI-Compliant System
- (ISA) 0x00000037 (55) Microsoft ACPI-Compliant System
- (ISA) 0x00000038 (56) Microsoft ACPI-Compliant System
- (ISA) 0x00000039 (57) Microsoft ACPI-Compliant System
- (ISA) 0x0000003A (58) Microsoft ACPI-Compliant System
- (ISA) 0x0000003B (59) Microsoft ACPI-Compliant System
- (ISA) 0x0000003C (60) Microsoft ACPI-Compliant System
- (ISA) 0x0000003D (61) Microsoft ACPI-Compliant System
- (ISA) 0x0000003E (62) Microsoft ACPI-Compliant System
- (ISA) 0x0000003F (63) Microsoft ACPI-Compliant System
- (ISA) 0x00000040 (64) Microsoft ACPI-Compliant System
- (ISA) 0x00000041 (65) Microsoft ACPI-Compliant System
- (ISA) 0x00000042 (66) Microsoft ACPI-Compliant System
- (ISA) 0x00000043 (67) Microsoft ACPI-Compliant System
- (ISA) 0x00000044 (68) Microsoft ACPI-Compliant System
- (ISA) 0x00000045 (69) Microsoft ACPI-Compliant System
- (ISA) 0x00000046 (70) Microsoft ACPI-Compliant System
- (ISA) 0x00000047 (71) Microsoft ACPI-Compliant System
- (ISA) 0x00000048 (72) Microsoft ACPI-Compliant System
- (ISA) 0x00000049 (73) Microsoft ACPI-Compliant System
- (ISA) 0x0000004A (74) Microsoft ACPI-Compliant System
- (ISA) 0x0000004B (75) Microsoft ACPI-Compliant System
- (ISA) 0x0000004C (76) Microsoft ACPI-Compliant System
- (ISA) 0x0000004D (77) Microsoft ACPI-Compliant System
- (ISA) 0x0000004E (78) Microsoft ACPI-Compliant System
- (ISA) 0x0000004F (79) Microsoft ACPI-Compliant System
- (ISA) 0x00000050 (80) Microsoft ACPI-Compliant System
- (ISA) 0x00000051 (81) Microsoft ACPI-Compliant System
- (ISA) 0x00000052 (82) Microsoft ACPI-Compliant System
- (ISA) 0x00000053 (83) Microsoft ACPI-Compliant System
- (ISA) 0x00000054 (84) Microsoft ACPI-Compliant System
- (ISA) 0x00000055 (85) Microsoft ACPI-Compliant System
- (ISA) 0x00000056 (86) Microsoft ACPI-Compliant System

Device Manager

File Action View Help

← → [Refresh] [Update] [Help] [Monitor] [Error] [Close]

[Folder]	(ISA) 0x000001F1 (497)	Microsoft ACPI-Compliant System
[Folder]	(ISA) 0x000001F2 (498)	Microsoft ACPI-Compliant System
[Folder]	(ISA) 0x000001F3 (499)	Microsoft ACPI-Compliant System
[Folder]	(ISA) 0x000001F4 (500)	Microsoft ACPI-Compliant System
[Folder]	(ISA) 0x000001F5 (501)	Microsoft ACPI-Compliant System
[Folder]	(ISA) 0x000001F6 (502)	Microsoft ACPI-Compliant System
[Folder]	(ISA) 0x000001F7 (503)	Microsoft ACPI-Compliant System
[Folder]	(ISA) 0x000001F8 (504)	Microsoft ACPI-Compliant System
[Folder]	(ISA) 0x000001F9 (505)	Microsoft ACPI-Compliant System
[Folder]	(ISA) 0x000001FA (506)	Microsoft ACPI-Compliant System
[Folder]	(ISA) 0x000001FB (507)	Microsoft ACPI-Compliant System
[Folder]	(ISA) 0x000001FC (508)	Microsoft ACPI-Compliant System
[Folder]	(ISA) 0x000001FD (509)	Microsoft ACPI-Compliant System
[Folder]	(ISA) 0x000001FE (510)	Microsoft ACPI-Compliant System
[Folder]	(ISA) 0x000001FF (511)	Microsoft ACPI-Compliant System
[Folder]	(PCI) 0x00000005 (05)	Intel(R) 100 Series/C230 Series Chipset Family SMBus - A123
[Folder]	(PCI) 0x00000006 (06)	Intel(R) 100 Series/C230 Series Chipset Family Thermal subsystem - A131
[Folder]	(PCI) 0x00000010 (16)	High Definition Audio Controller
[Folder]	(PCI) 0xFFFFFEE8 (-24)	Intel(R) I211 Gigabit Network Connection #2
[Folder]	(PCI) 0xFFFFFEE9 (-23)	Intel(R) I211 Gigabit Network Connection #2
[Folder]	(PCI) 0xFFFFFEEA (-22)	Intel(R) I211 Gigabit Network Connection #2
[Folder]	(PCI) 0xFFFFFEEB (-21)	Intel(R) I211 Gigabit Network Connection #2
[Folder]	(PCI) 0xFFFFFEEC (-20)	Intel(R) I211 Gigabit Network Connection
[Folder]	(PCI) 0xFFFFFEED (-19)	Intel(R) I211 Gigabit Network Connection
[Folder]	(PCI) 0xFFFFFEEE (-18)	Intel(R) I211 Gigabit Network Connection
[Folder]	(PCI) 0xFFFFFEED (-17)	Intel(R) I211 Gigabit Network Connection
[Folder]	(PCI) 0xFFFFFEED (-16)	Intel(R) I211 Gigabit Network Connection #4
[Folder]	(PCI) 0xFFFFFEED (-15)	Intel(R) I211 Gigabit Network Connection #4
[Folder]	(PCI) 0xFFFFFEED (-14)	Intel(R) I211 Gigabit Network Connection #4
[Folder]	(PCI) 0xFFFFFEED (-13)	Intel(R) I211 Gigabit Network Connection #4
[Folder]	(PCI) 0xFFFFFEED (-12)	Intel(R) I211 Gigabit Network Connection #3
[Folder]	(PCI) 0xFFFFFEED (-11)	Intel(R) I211 Gigabit Network Connection #3
[Folder]	(PCI) 0xFFFFFEED (-10)	Intel(R) I211 Gigabit Network Connection #3
[Folder]	(PCI) 0xFFFFFEED (-9)	Intel(R) I211 Gigabit Network Connection #3
[Folder]	(PCI) 0xFFFFFEED (-8)	Intel(R) USB 3.0 eXtensible Host Controller - 1.0 (Microsoft)
[Folder]	(PCI) 0xFFFFFEED (-7)	Intel(R) HD Graphics 610
[Folder]	(PCI) 0xFFFFFEED (-6)	Standard SATA AHCI Controller
[Folder]	(PCI) 0xFFFFFEED (-5)	Intel(R) 100 Series/C230 Series Chipset Family PCI Express Root Port #16 - A11F
[Folder]	(PCI) 0xFFFFFEED (-4)	Intel(R) 100 Series/C230 Series Chipset Family PCI Express Root Port #12 - A11B
[Folder]	(PCI) 0xFFFFFEED (-3)	Intel(R) 100 Series/C230 Series Chipset Family PCI Express Root Port #11 - A11A
[Folder]	(PCI) 0xFFFFFEED (-2)	Intel(R) 100 Series/C230 Series Chipset Family PCI Express Root Port #10 - A119
>	Memory	

Appendix C

Digital I/O Ports

Bit Range	Default & Access	Field Name (ID): Description
27	0h RO	Reserved.
26:25	2h RW	RX Level/Edge Configuration (RXEVCFG): Determines if the internal RX pad state (synchronized, filtered vs non-filtered version as determined by PreGfRXSel, and is further subject to RXInv) should be passed on to the next logic stage as is, as a pulse, or level signal. This field does not affect the received pad state (to GPIORXState or native functions) but how the interrupt or wake triggering events should be delivered to the GPIO Community Controller . 0h = Level 1h = Edge 2h = Drive '0' 3h = Reserved (implement as setting 0h)
24	0h RO	Reserved.
23	0h RW	RX Invert (RXINV): This bit determines if the selected pad state should go through the polarity inversion stage. This field is only applicable when the RX buffer is configured as an input in either GPIO Mode or native function mode. The polarity inversion takes place at the mux node of raw vs filtered or non-filtered RX pad state, as determined by PreGfRXsel and RXPadStSel This bit does not affect GPIORXState. During host ownership GPIO Mode, when this bit is set to '1', then the RX pad state is inverted as it is sent to the GPIO-to-IOxAPIC, GPE/SCI, SMI, NMI logic or GPI_IS[n] that is using it. This is used to allow active-low and active-high inputs to cause IRQ, SMI#, SCI or NMI. 0 = No inversion 1 = Inversion
22:21	0h RO	Reserved.
20	0h RW	GPIO Input Route IOxAPIC (GPIROUTIOXAPIC): Determines if the pad can be routed to cause peripheral IRQ when configured in GPIO input mode. If the pad is not configured in GPIO input mode, this field has no effect. 0 = Routing does not cause peripheral IRQ 1 = Routing can cause peripheral IRQ Note: This bit does not affect any interrupt status bit within GPIO, but is used as the last qualifier for the peripheral IRQ indication to the intended recipient(s).
19	0h RW	GPIO Input Route SCI (GPIROUTSCI): Determines if the pad can be routed to cause SCI when configured in GPIO input mode. If the pad is not configured in GPIO input mode, this field has no effect. 0 = Routing does not cause SCI. 1 = Routing can cause SCI Note: This bit does not affect any interrupt status bit within GPIO, but is used as the last qualifier for the GPE indication to the intended recipient(s).
18	0h RW	GPIO Input Route SMI (GPIROUTSMI): Determines if the pad can be routed to cause SMI when configured in GPIO input mode. If the pad is not configured in GPIO input mode, this field has no effect. 0 = Routing does not cause SMI. 1 = Routing can cause SMI. Note: This bit does not affect any interrupt status bit within GPIO, but is used as the last qualifier for the SMI indication to the intended recipient(s). This bit only applies to a GPIO that has SMI capability. Otherwise, the bit is RO.
17	0h RW	GPIO Input Route NMI (GPIROUTNMI): Determines if the pad can be routed to cause NMI when configured in GPIO input mode. If the pad is not configured in GPIO input mode, this field has no effect. 0 = Routing does not cause NMI. 1 = Routing can cause NMI. Note: This bit also affects GPI_NMI_STS. If '0', GPI_NMI_STS is always clear. If '1', GPI_NMI_STS could be set (depending on GPIOOwn setting) when there is an event. Whether a NMI indication is generated and sent to the intended recipient(s) is also depending on the corresponding GPI_NMI_EN bit. This bit only applies to a GPIO that has NMI capability. Otherwise, the bit is RO.
16:13	0h RO	Reserved.
12	-- RW	Pad Mode bit 2 (PMODE2): See Pad Mode Bit 0 description.
11	-- RW	Pad Mode bit 1 (PMODE1): See Pad Mode Bit 0 description.

Bit Range	Default & Access	Field Name (ID): Description
10	-- RW	<p>Pad Mode bit 0 (PMODE0): This bit is used in conjunction with Pad Mode bit 1 and 2 . This three-bit field determines whether the Pad is controlled by GPIO controller logic or one of the native functions muxed onto the Pad.</p> <p>0h = GPIO control the Pad.</p> <p>1h = native function 1, if applicable, controls the Pad</p> <p>2h = native function 2, if applicable, controls the Pad</p> <p>3h = native function 3, if applicable, controls the Pad</p> <p>4h = enable GPIO blink/PWM capability if applicable (note that not all GPIOs have blink/PWM capability)</p> <p>Dedicated (unmuxed) GPIO shall report RO of all 0's in this register field</p> <p>If GPIO vs. native mode is configured via soft strap, this bit has no effect.</p> <p>Default value is determined by the default functionality of the pad.</p>
9	1h RW	<p>GPIO RX Disable (GPIORXDIS): 0 = Enable the input buffer (active low enable) of the pad.</p> <p>1 = Disable the input buffer of the pad.</p> <p>Notes: When the input buffer is disabled, the internal pad state is always driven to '0'.</p>
8	1h RW	<p>GPIO TX Disable (GPIOTXDIS): 0 = Enable the output buffer (active low enable) of the pad.</p> <p>1 = Disable the output buffer of the pad; i.e. Hi-Z</p>
7:2	0h RO	Reserved.
1	0h RO	<p>GPIO RX State (GPIORXSTATE): This is the current internal RX pad state after Glitch Filter logic stage and is not affected by PMode and RXINV settings.</p>
0	0h RW	<p>GPIO TX State (GPIOTXSTATE): 0 = Drive a level '0' to the TX output pad.</p> <p>1 = Drive a level '1' to the TX output pad</p>

C.2 Digital I/O Sample Code

```
UINT32 SOC_GPIO_BASE_ADDRESS=0xFDAE06A8,SOC_GPIO_VAL=0;
for (i = 0; i < 8; i++)
{
    SOC_GPIO_VAL=MmioRead32(SOC_GPIO_BASE_ADDRESS+8*i);
    if (SetupData.SOCGPPGx_Oe[i]==0)//GPIO set to input
    {
        SOC_GPIO_VAL |= BIT8;//Set bit 8
        SOC_GPIO_VAL &= (~BIT9);//Clear bit 9
    }
    else if (SetupData.SOCGPPGx_Oe[i]==1)//GPIO set to output
    {
        SOC_GPIO_VAL |= BIT9;//Set bit 9
        SOC_GPIO_VAL &= (~BIT8);//Clear bit 8
        if(SetupData.SOCGPPGx_Val[i]==0)
            SOC_GPIO_VAL &= (~BIT0);//Clear bit 0 ==>Output LOW
        else
            SOC_GPIO_VAL |= BIT0;//Set bit 0 ==>Output HIGH
    }
}
```