

EPIC-KBS7

EPIC Board

User's Manual 3rd Ed

Copyright Notice

This document is copyrighted, 2018. All rights are reserved. The original manufacturer reserves the right to make improvements to the products described in this manual at any time without notice.

No part of this manual may be reproduced, copied, translated, or transmitted in any form or by any means without the prior written permission of the original manufacturer. Information provided in this manual is intended to be accurate and reliable. However, the original manufacturer assumes no responsibility for its use, or for any infringements upon the rights of third parties that may result from its use.

The material in this document is for product information only and is subject to change without notice. While reasonable efforts have been made in the preparation of this document to assure its accuracy, AAEMON assumes no liabilities resulting from errors or omissions in this document, or from the use of the information contained herein.

AAEMON reserves the right to make changes in the product design without notice to its users.

Acknowledgement

All other products' name or trademarks are properties of their respective owners.

- Microsoft Windows is a registered trademark of Microsoft Corp.
- Intel, Pentium, Celeron, and Xeon are registered trademarks of Intel Corporation
- Core, Atom are trademarks of Intel Corporation
- ITE is a trademark of Integrated Technology Express, Inc.
- IBM, PC/AT, PS/2, and VGA are trademarks of International Business Machines Corporation.

All other product names or trademarks are properties of their respective owners.

Packing List

Before setting up your product, please make sure the following items have been shipped:

Item	Quantity
● EPIC-KBS7	1
● 1702150155 SATA power cable	1
● 1709070500 SATA cable	2
● 9657666600 jumper cap	1
● Product DVD with drivers	1

If any of these items are missing or damaged, please contact your distributor or sales representative immediately.

About this Document

This User's Manual contains all the essential information, such as detailed descriptions and explanations on the product's hardware and software features (if any), its specifications, dimensions, jumper/connector settings/definitions, and driver installation instructions (if any), to facilitate users in setting up their product.

Users may refer to the AAEON.com for the latest version of this document.

Safety Precautions

Please read the following safety instructions carefully. It is advised that you keep this manual for future references

1. All cautions and warnings on the device should be noted.
2. Make sure the power source matches the power rating of the device.
3. Position the power cord so that people cannot step on it. Do not place anything over the power cord.
4. Always completely disconnect the power before working on the system's hardware.
5. No connections should be made when the system is powered as a sudden rush of power may damage sensitive electronic components.
6. If the device is not to be used for a long time, disconnect it from the power supply to avoid damage by transient over-voltage.
7. Always disconnect this device from any AC supply before cleaning.
8. While cleaning, use a damp cloth instead of liquid or spray detergents.
9. Make sure the device is installed near a power outlet and is easily accessible.
10. Keep this device away from humidity.
11. Place the device on a solid surface during installation to prevent falls
12. Do not cover the openings on the device to ensure optimal heat dissipation.
13. Watch out for high temperatures when the system is running.
14. Do not touch the heat sink or heat spreader when the system is running
15. Never pour any liquid into the openings. This could cause fire or electric shock.
16. As most electronic components are sensitive to static electrical charge, be sure to ground yourself to prevent static charge when installing the internal components. Use a grounding wrist strap and contain all electronic components in any static-shielded containers.

17. If any of the following situations arises, please the contact our service personnel:
 - i. Damaged power cord or plug
 - ii. Liquid intrusion to the device
 - iii. Exposure to moisture
 - iv. Device is not working as expected or in a manner as described in this manual
 - v. The device is dropped or damaged
 - vi. Any obvious signs of damage displayed on the device
18. **DO NOT LEAVE THIS DEVICE IN AN UNCONTROLLED ENVIRONMENT WITH TEMPERATURES BEYOND THE DEVICE'S PERMITTED STORAGE TEMPERATURES (SEE CHAPTER 1) TO PREVENT DAMAGE.**

Warning!



This device complies with Part 15 FCC Rules. Operation is subject to the following two conditions: (1) this device may not cause harmful interference, and (2) this device must accept any interference received including interference that may cause undesired operation.

Caution:

There is a danger of explosion if the battery is incorrectly replaced. Replace only with the same or equivalent type recommended by the manufacturer. Dispose of used batteries according to the manufacturer's instructions and your local government's recycling or disposal directives.

Attention:

Il y a un risque d'explosion si la batterie est remplacée de façon incorrecte. Ne la remplacer qu'avec le même modèle ou équivalent recommandé par le constructeur. Recycler les batteries usées en accord avec les instructions du fabricant et les directives gouvernementales de recyclage.

China RoHS Requirements (CN)

产品中有毒有害物质或元素名称及含量

AAEON Main Board/ Daughter Board/ Backplane

部件名称	有毒有害物质或元素					
	铅 (Pb)	汞 (Hg)	镉 (Cd)	六价铬 (Cr(VI))	多溴联苯 (PBB)	多溴二苯醚 (PBDE)
印刷电路板 及其电子组件	○	○	○	○	○	○
外部信号 连接器及线材	○	○	○	○	○	○
<p>○: 表示该有毒有害物质在该部件所有均质材料中的含量均在 SJ/T 11363-2006 标准规定的限量要求以下。</p> <p>X: 表示该有毒有害物质至少在该部件的某一均质材料中的含量超出 SJ/T 11363-2006 标准规定的限量要求。</p> <p>备注: 此产品所标示之环保使用期限, 系指在一般正常使用状况下。</p>						

China RoHS Requirement (EN)

Poisonous or Hazardous Substances or Elements in Products

AAEON Main Board/ Daughter Board/ Backplane

Component	Poisonous or Hazardous Substances or Elements					
	Lead (Pb)	Mercury (Hg)	Cadmium (Cd)	Hexavalent Chromium (Cr(VI))	Polybrominated Biphenyls (PBB)	Polybrominated Diphenyl Ethers (PBDE)
PCB & Other Components	○	○	○	○	○	○
Wires & Connectors for External Connections	○	○	○	○	○	○
<p>O: The quantity of poisonous or hazardous substances or elements found in each of the component's parts is below the SJ/T 11363-2006-stipulated requirement.</p> <p>X: The quantity of poisonous or hazardous substances or elements found in at least one of the component's parts is beyond the SJ/T 11363-2006-stipulated requirement.</p> <p>Note: The Environment Friendly Use Period as labeled on this product is applicable under normal usage only</p>						

Table of Contents

Chapter 1 - Product Specifications	1
1.1 Specifications	2
Chapter 2 – Hardware Information	1
2.1 Dimensions	2
2.2 Jumpers and Connectors.....	5
2.3 List of Jumpers	7
2.3.1 LVDS Power select / LVDS BKLT Power select (JP4)	8
2.3.2 LVDS BKLT control (JP5)	8
2.3.3 RTC RESET header (JP6).....	9
2.3.4 ATX/AT select (JP7).....	9
2.3.5 Front Panel Header (JP9)	9
2.4 List of Connectors.....	10
2.4.1 Backlight CONN (CN1).....	12
2.4.2 2 PIN DC IN connector (CN2)	12
2.4.3 LVDS CONN (CN3)	13
2.4.4 3 PIN SB Power IN connector (CN4).....	14
2.4.5 AUDIO PIN Header (CN5).....	15
2.4.6 RTC Battery CONN (CN6)	16
2.4.7 SATA Power connector (CN7)	16
2.4.8 USB PIN Header (CN8 / CN9)	16
2.4.9 SATA Port 1/SATA Port 2 (CN10/CN13).....	17
2.4.10 External FAN PIN Header (CN14).....	18
2.4.11 LPC connector for debug (CN15)	18
2.4.12 RS232/422/485 PIN Header (CN16).....	19
2.4.13 RS232 PIN Header (CN17).....	20
2.4.14 RS232 PIN Header (CN18).....	21

2.4.15	RS232 PIN Header (CN26)	22
2.4.16	DIO PIN HEADER (CN24)	23
2.5	CPU Installation	24
Chapter 3 - BIOS Setup		1
3.1	System Test and Initialization	2
3.2	AMI BIOS Setup	3
3.3	Setup submenu: Main	4
3.4	Setup submenu: Advanced	5
3.4.1	CPU Configuration	6
3.4.2	SATA Configuration	7
3.4.3	SIO Configuration	9
3.4.3.1	Serial Port Configuration	10
3.4.4	Hardware Monitor	11
3.4.4.1	CPU Smart Fan Mode Configuration	12
3.4.5	USB Configuration	15
3.4.6	Digital IO Port Configuration	16
3.4.7	Power Management	18
3.5	Submenu Chipset	20
3.5.1	System Agent (SA) Configuration	21
3.5.1.1	Graphics Configuration	23
3.5.1.2	LVDS Panel Configuration	25
3.5.2	PCH-IO Configuration	28
3.6	Security	30
3.7	Submenu: Boot	32
3.7.1	BBS Priorities	33
3.8	Submenu: Exit	34
Chapter 4 – Drivers Installation		1
4.1	Product CD/DVD	2

Appendix A - Watchdog Timer Programming	5
A.1 Watchdog Timer Initial Program	6
Appendix B - I/O Information	11
B.1 I/O Address Map	12
B.2 Memory Address Map	14
B.3 IRQ Mapping Chart.....	16
Appendix B – Mating Connector Information	18
B.1 Mating Connector	19

Chapter 1

Product Specifications

1.1 Specifications

System

● Form Factor	EPIC Board
● Processor	6th/7th Gen. Intel® Core™ i7/i5/i3/Celeron®
● System Memory	Up to 16 GB DDR4 (Non-ECC) 2133 MHz
● Chipset	Intel® H110 (6W)
● I/O Chipset	Fintek F81866D
● Ethernet	Intel 10/100/1000 Base LANs, RJ-45 x 2 (Real IO) (i211 x 2)
● BIOS	UEFI (Supports Legacy BIOS)
● Wake On LAN	Yes
● Watchdog Timer	255 Levels
● H/W Status Monitoring	VCORE, V12V, V5V,VDIMM & Temperature from CPU / System side & FAN Speed (please see appendix 1)
● Expansion Interface	Mini-card x 1 (Shared with mSATA by BOM)
● Battery	CR-2032
● Power Consumption (Typical)	49.8 W
● Board Size	165 x 115 mm (6.5 x 4.53")
● Gross Weight	0.4 kg (0.88 lbs)
● Operating Temperature	0 ~ 60°C (32 ~ 140°F)

- **Storage Temperature** -40 ~ 80°C (-40 ~ 176°F)
- **Operation Humidity** 0 ~ 90%, relative humidity, non-condensing

Display

- **Chipset** Processor-integrated
- **Display Combination** CRT/HDMI (Option: LVDS)
- **LCD Interface** LVDS 18/24bit, 2CH

I/O

- **SATA** 2 x SATA
- **USB** USB3.0 x 4 (Real IO)
USB2.0 x 2 (Internal)
- **Serial Port** COM x 4 (Internal)
(COM2: RS232/422/485, RING feature only)
- **DI/O** 8-bit
- **Audio** ALC892, no Amp

Remark

The EPIC-KBS7 only supports 35/51W CPU due to limited power. Please contact AAeon to get more detailed information.

Chapter 2

Hardware Information

2.1 Dimensions

Component Side

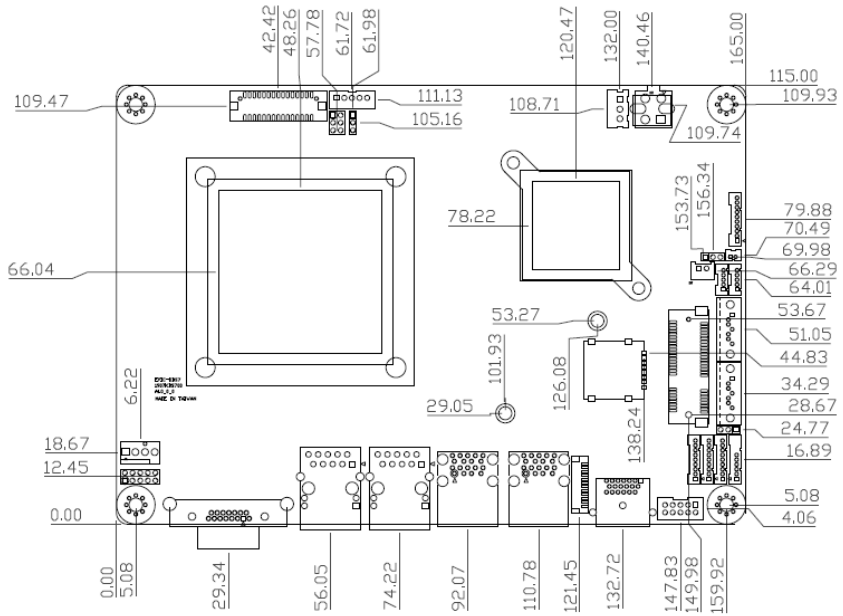

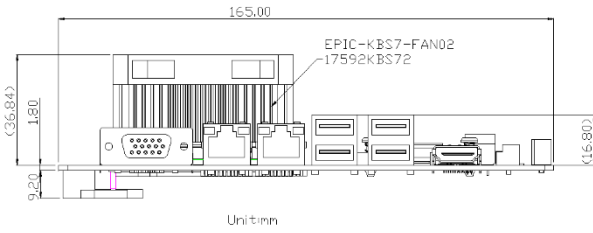
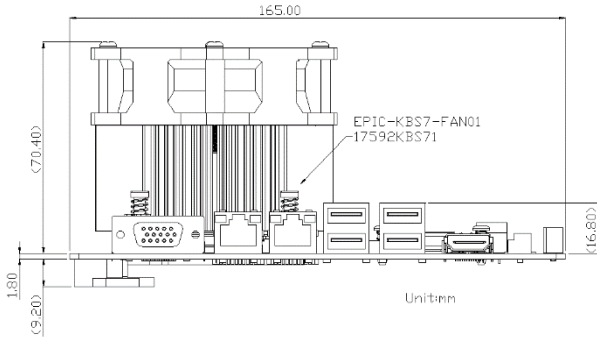

Solder Side

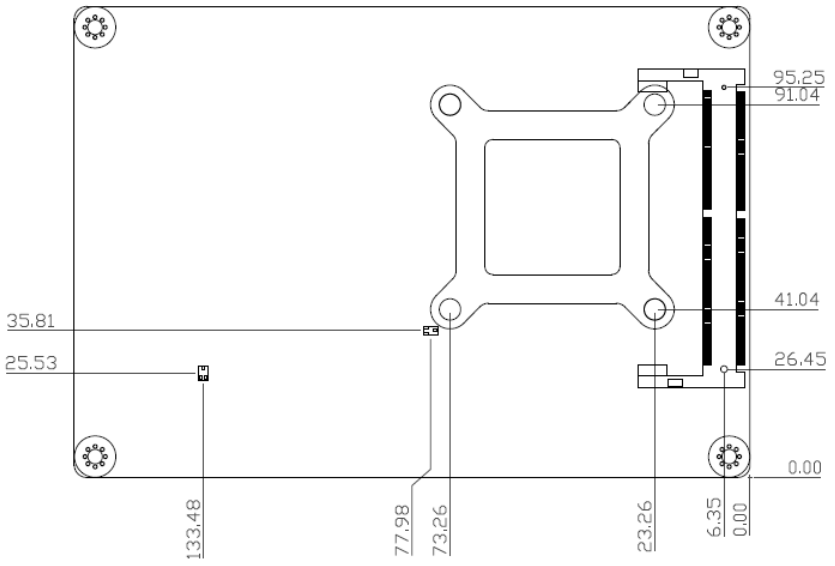

2.2 Jumpers and Connectors

Component Side

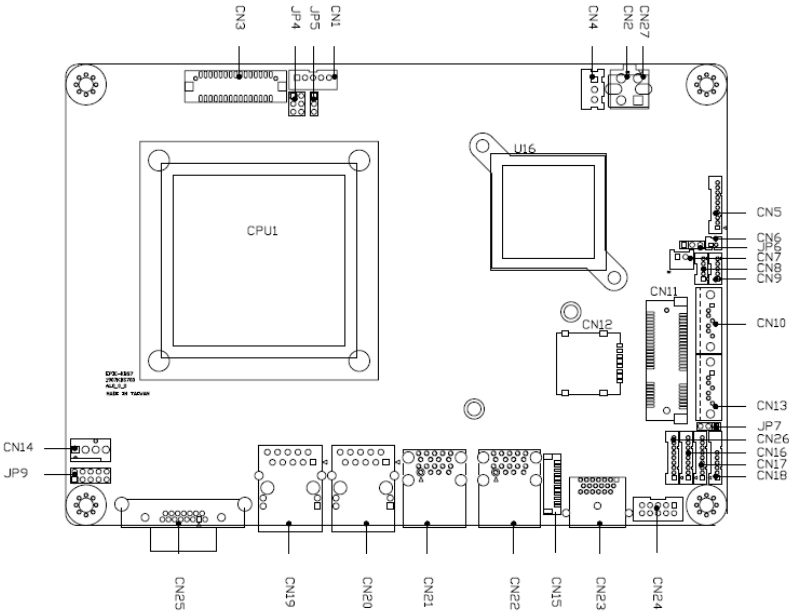

Component Side

Solder Side

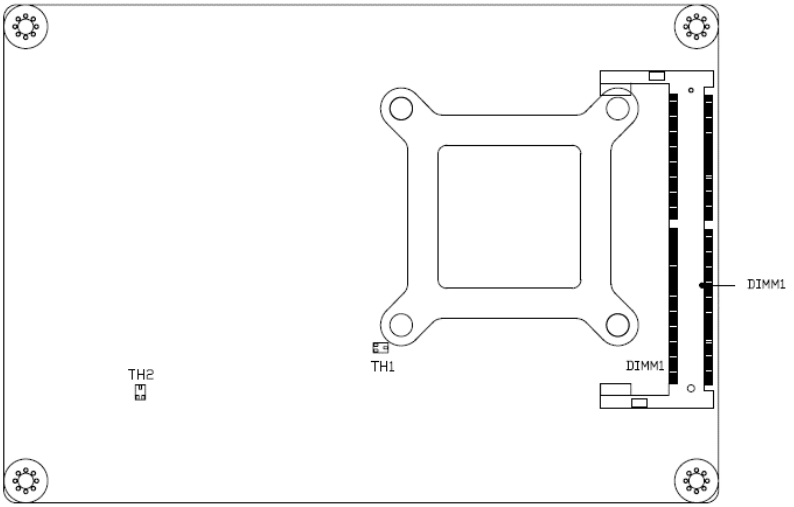

Solder Side

2.3 List of Jumpers

Please refer to the table below for all of the board's jumpers that you can configure for your application

Label	Function
JP4	LVDS power Select CONN
JP5	Backlight power select CONN
JP6	Clean C-MOS PIN Header
JP7	AT/ATX CONN
JP9	Front Panel PIN Header

2.3.1 LVDS Power select / LVDS BKLT Power select (JP4)

LVDS Power select

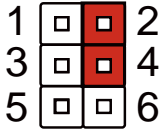

+5V

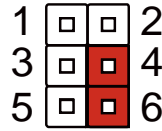

+3.3V (Default)

LVDS BKLT Power select

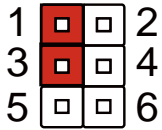

+12V

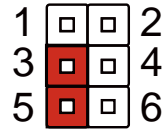

+5V (Default)

2.3.2 LVDS BKLT control (JP5)

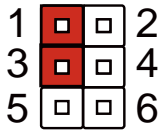

+12V

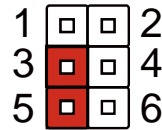

+5V (Default)

2.3.3 RTC RESET header (JP6)

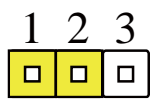

Normal (Default)

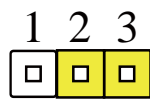

Clear CMOS

2.3.4 ATX/AT select (JP7)

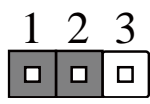

Disable (Default)

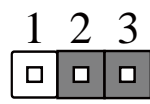

Enable (Default)

2.3.5 Front Panel Header (JP9)

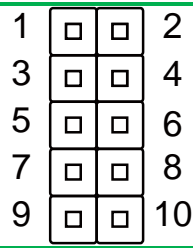

Pin	Pin Name	Pin	Pin Name
1	GND	2	EXT_PWRBTN#
3	FP_HDLED-	4	FP_HDLED+
5	FP_SPKR-	6	+V5S
7	GND	8	PWRLED+
9	GND	10	HWRST#

2.4 List of Connectors

Please refer to the table below for all of the board's connectors that you can configure for your application

Label	Function
CN1	Backlight CONN
CN2	2 PIN DC IN connector
CN3	LVDS CONN
CN4	3 PIN SB Power IN connector
CN5	AUDIO connector
CN6	RTC Battery CONN
CN7	SATA Power connector
CN8	USB2.0 CONN
CN9	USB2.0 CONN
CN10	SATA CONN
CN13	SATA CONN
CN11	Mini-card CONN
CN12	SIM card CONN
CN14	External FAN PIN Heater
CN15	LPC connector for debug
CN16	RS232/422/485 CONN COM2
CN17	RS232 CONN COM1
CN18	RS232 CONN COM3
CN26	RS232 CONN COM4
CN24	DIO CONN
CN19	Giga LAN RJ45 Connector
CN20	Giga LAN RJ45 Connector
CN21	USB 3.0 Connector

CN22	USB 3.0 Connector
BZ1	PC Buzzer
CN23	HDMI CONN
CN25	VGA CONN
U18	BOIS Socket
CPU1	CPU Socket
DIMM1	RAM Socket1
LED1	Stand By power LED indicate
LED2	+V5S LED indicate
LED3	HDD LED indicate

2.4.1 Backlight CONN (CN1)

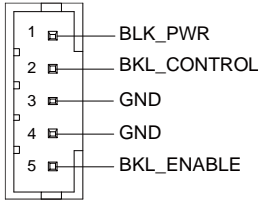

Pin	Pin Name
1	BLK_PWR
2	BLK_CONTROL
3	GND
4	GND
5	BKL_ENABLE

2.4.2 2 PIN DC IN connector (CN2)

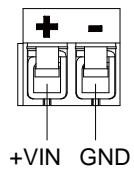

Pin	Pin Name
1	+VIN 9~24V or 12V
2	GND

2.4.3 LVDS CONN (CN3)

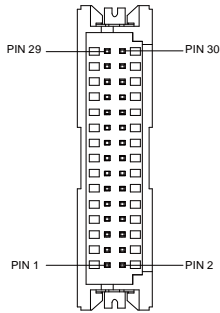

Pin	Pin Name
1	BKL_ENABLE
2	BKL_CONTROL
3	LCD_PWR
4	GND
5	LVDS_A_CLK-
6	LVDS_A_CLK+
7	LCD_PWR
8	GND
9	LVDS_DA0-
10	LVDS_DA0+
11	LVDS_DA1-
12	LVDS_DA1+
13	LVDS_DA2-
14	LVDS_DA2+
15	LVDS_DA3-
16	LVDS_DA3+
17	DDC_DATA
18	DDC_CLK

19	LVDS_DB0-
20	LVDS_DB0+
21	LVDS_DB1-
22	LVDS_DB1+
23	LVDS_DB2-
24	LVDS_DB2+
25	LVDS_DB3-
26	LVDS_DB3+
27	LCD_PWR
28	GND
29	LVDS_B_CLK-
30	LVDS_B_CLK+

2.4.4 3 PIN SB Power IN connector (CN4)

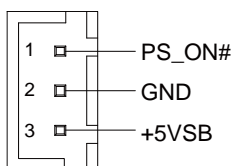

Pin	Pin Name
1	PS_ON#
2	GND
3	+V5A_SB_IN

2.4.5 AUDIO PIN Header (CN5)

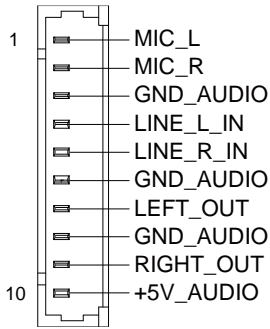

Pin	Pin Name
1	MIC_L
2	MIC_R
3	GND
4	LIN_L
5	LIN_R
6	GND
7	LOUT_L
8	GND
9	LOUT_R
10	+VDD_AUD

2.4.6 RTC Battery CONN (CN6)

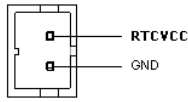

Pin	Pin Name
1	RTCVCC
2	GND

2.4.7 SATA Power connector (CN7)

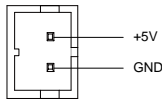

Pin	Pin Name
1	+5V
2	GND

2.4.8 USB PIN Header (CN8 / CN9)

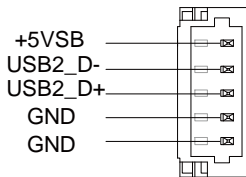

Pin	Pin Name
1	VCC
2	USBD-

3	USB+
4	GND
5	GND

2.4.9 SATA Port 1/SATA Port 2 (CN10/CN13)

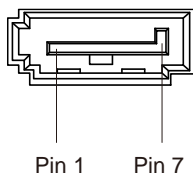

Pin	Pin Name	Pin	Pin Name
1	GND	1	GND
2	SATA_TXP0	2	SATA_TXP1
3	SATA_TXN0	3	SATA_TXN1
4	GND	4	GND
5	SATA_RXN0	5	SATA_RXN1
6	SATA_RXP0	6	SATA_RXP1
7	GND	7	GND

2.4.10 External FAN PIN Header (CN14)

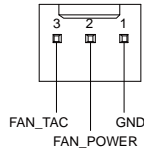

Pin	Pin Name
1	GND
2	+VCC_FAN_CPU_CON
3	FAN_TAC_CPU_CON
4	FAN_CTL_CPU_CON

2.4.11 LPC connector for debug (CN15)

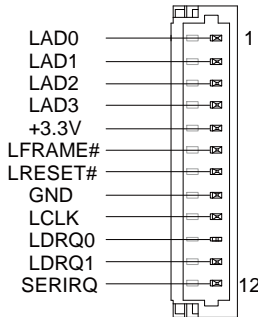

Pin	Pin Name
1	LPC_AD0
2	LPC_AD1
3	LPC_AD2
4	LPC_AD3
5	P3V3

6	FRAME#
7	RST#
8	GND
9	CLK
10	LDRQ0
11	LDRQ1
12	INT_SERIRQ

2.4.12RS232/422/485 PIN Header (CN16)

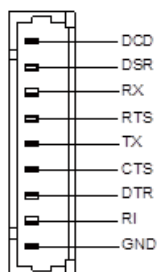

Pin	Pin Name
1	DCD2
2	DSR2
3	RX2
4	RTS2
5	TX2
6	CTS2
7	DTR2
8	RI1
9	GND

2.4.13RS232 PIN Header (CN17)

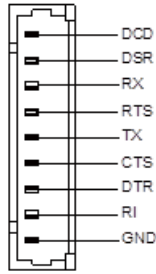

Pin	Pin Name
1	DCD1
2	DSR1
3	RX1
4	RTS1
5	TX1
6	CTS1
7	DTR1
8	RI1
9	GND

2.4.14RS232 PIN Header (CN18)

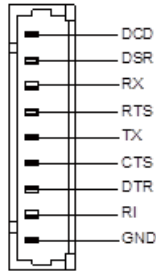

Pin	Pin Name
1	DCD3
2	DSR3
3	RX3
4	RTS3
5	TX3
6	CTS3
7	DTR3
8	RI3
9	GND

2.4.15RS232 PIN Header (CN26)

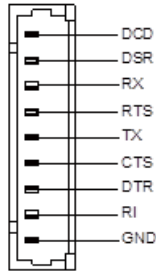

Pin	Pin Name
1	DCD4
2	DSR4
3	RX4
4	RTS4
5	TX4
6	CTS4
7	DTR4
8	RI4
9	GND

2.4.16 DIO PIN HEADER (CN24)

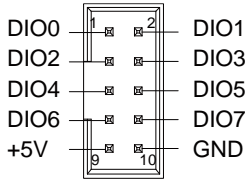

Pin	Pin Name	Pin	Pin Name
1	PD0	2	PD1
3	PD2	4	PD3
5	PD4	6	PD5
7	PD6	8	PD7
9	+V5S	10	GND

2.5 CPU Installation

- Turn off the system, unplug the power cord and make sure the system is off.
- Have the Intel KabyLake or Intel SkyLake-S FCLGA1151 Processor (Max. TDP 35W) ready.



Step 1: Remove the plastic cover as instructed below.



Step 2: Assemble the CPU.



Step3: Assemble the cover, and make sure that the corners align.



Step 4: Push the cover down so that it fits.

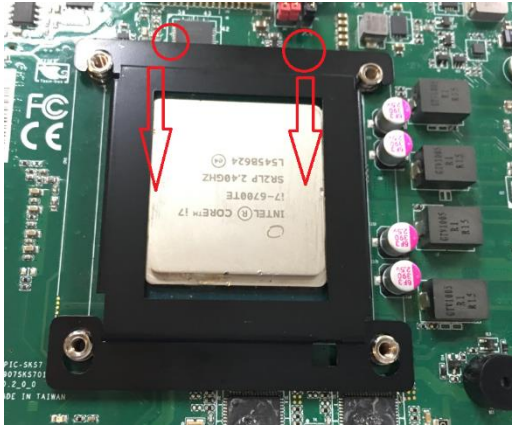

Step 7: Stick the sponge on the PCB in order to fix the metal cover.



- Special surface treatment

The CPU bracket and cover are within electrophoretic deposition and also with insulation feature, better for EMC regulation.

- Better fix CPU in place

The cover benefit is better to fix the CPU when disassembling cooler.

- Better Compatibility

It is also good for heat spreading. If the CPU is fixed better, the board will perform better and be more reliable.

Chapter 3

BIOS Setup

3.1 System Test and Initialization

These routines test and initialize board hardware. If the routines encounter an error during the tests, you will either hear a few short beeps or see an error message on the screen. There are two kinds of errors: fatal and non-fatal. The system can usually continue the boot up sequence with non-fatal errors.

System configuration verification

These routines check the current system configuration stored in the CMOS memory and BIOS NVRAM. If system configuration is not found or system configuration data error is detected, system will load optimized default and re-boot with this default system configuration automatically.

There are four situations in which you will need to setup system configuration:

1. You are starting your system for the first time
2. You have changed the hardware attached to your system
3. The system configuration is reset by Clear-CMOS jumper
4. The CMOS memory has lost power and the configuration information has been erased.

The COM-BT CMOS memory has an integral lithium battery backup for data retention. However, you will need to replace the complete unit when it finally runs down.

3.2 AMI BIOS Setup

AMI BIOS ROM has a built-in Setup program that allows users to modify the basic system configuration. This type of information is stored in battery-backed CMOS RAM and BIOS NVRAM so that it retains the Setup information when the power is turned off.

Entering Setup

Power on the computer and press or <ESC> immediately. This will allow you to enter Setup.

Main – Date and time can be set here. Press <Tab> to switch between date elements

Advanced – Enable/ Disable boot option for legacy network devices

Chipset – For hosting bridge parameters

Boot – Enable/ Disable quiet Boot Option

Security – The setup administrator password can be set here

Save & Exit – Save your changes and exit the program

3.3 Setup submenu: Main

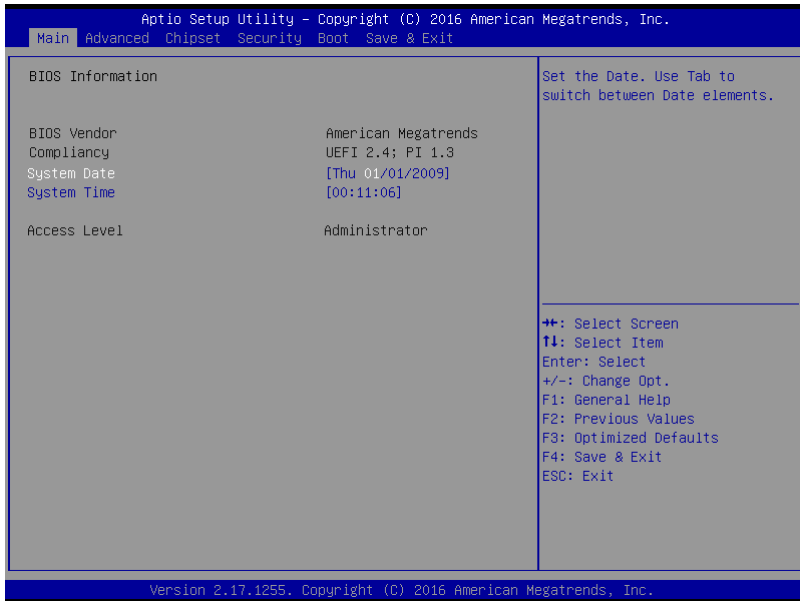

3.4 Setup submenu: Advanced

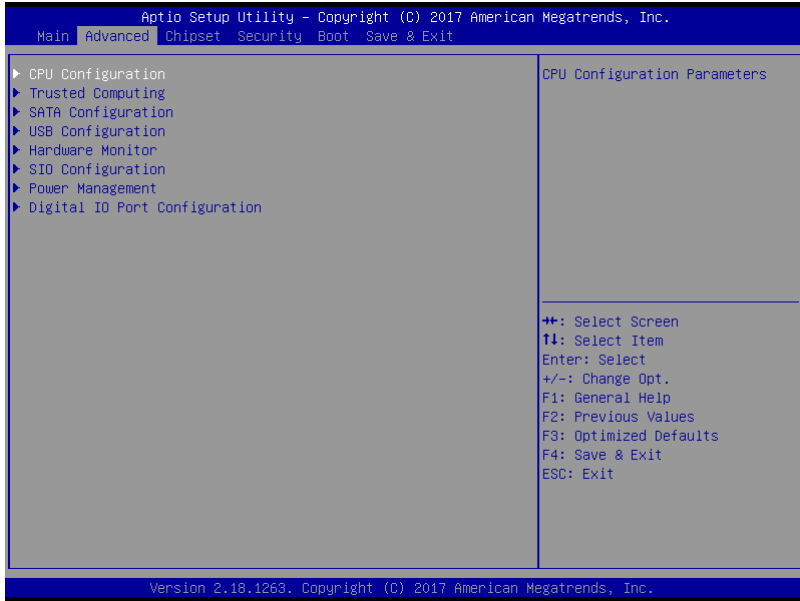

3.4.1 CPU Configuration

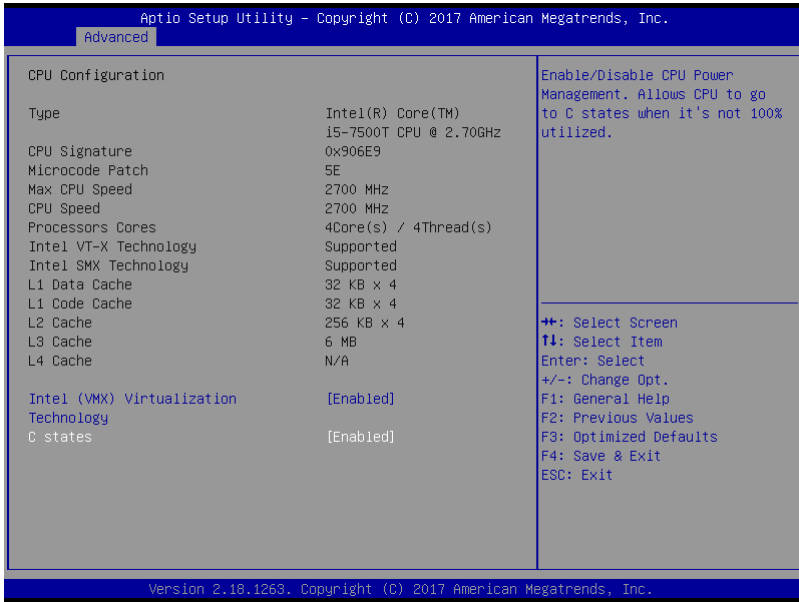

Options summary:

Intel (VMX) Virtualization Technology	Disabled	
	Enabled	Optimal Default, Failsafe Default
When enabled, a VMM can utilize the additional hardware capabilities provided by Vanderpool Technology.		
C states	Disabled	
	Enabled	Optimal Default, Failsafe Default
Enabled for Windows XP and Linux (OS optimized for Hyper-Threading Technology) and Disable for other OS (OS not optimized for Hyper-Threading Technology). When Disabled only one thread per enabled core is enabled.		

3.4.2 SATA Configuration

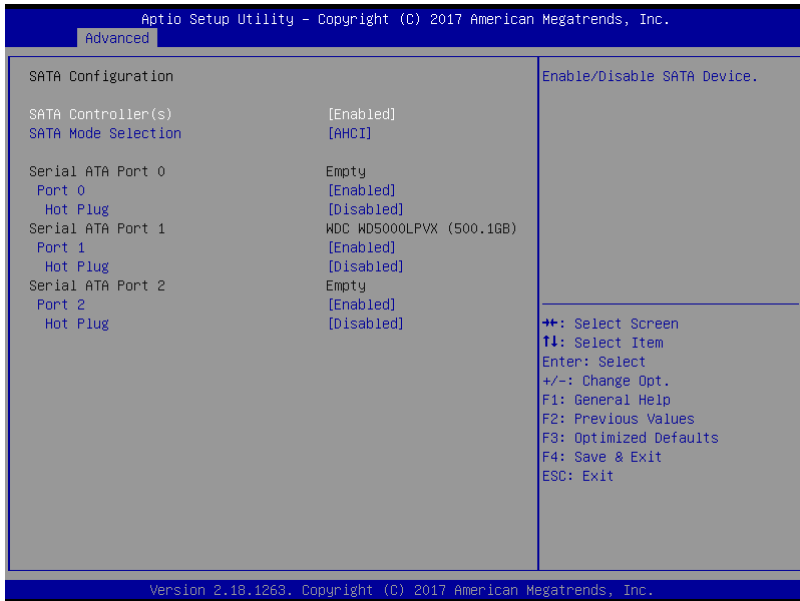

Options summary:

SATA Controller(s)	Enabled	Optimal Default, Failsafe Default
	Disabled	
Enable or disable SATA Device.		
SATA Mode	AHCI Mode	Optimal Default, Failsafe Default
	RAID Mode	
Determines how SATA controller(s) operate.		
Port 0	Disabled	Optimal Default, Failsafe Default
	Enabled	
Enable or Disable SATA Port.		
Hot Plug	Disabled	Optimal Default, Failsafe Default

	Enabled	
Designates this port as Hot Pluggable.		

3.4.3 SIO Configuration

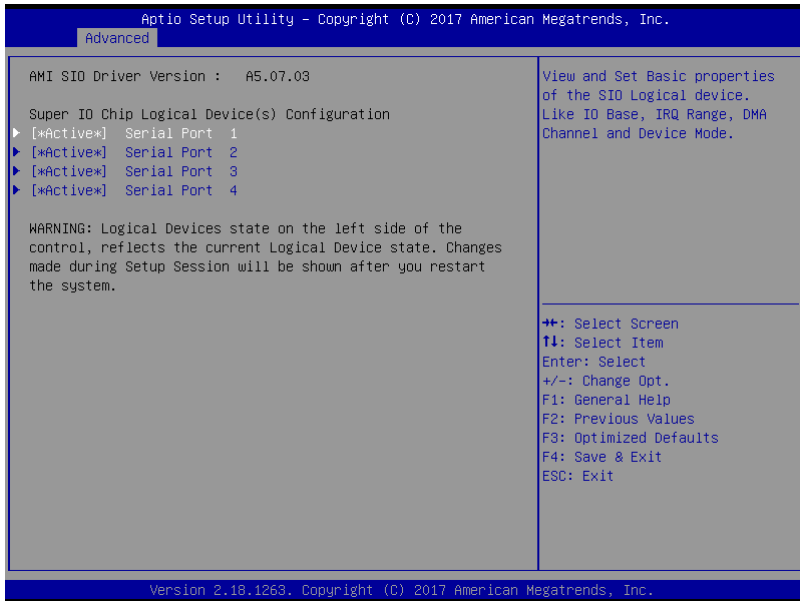

3.4.3.1 Serial Port Configuration

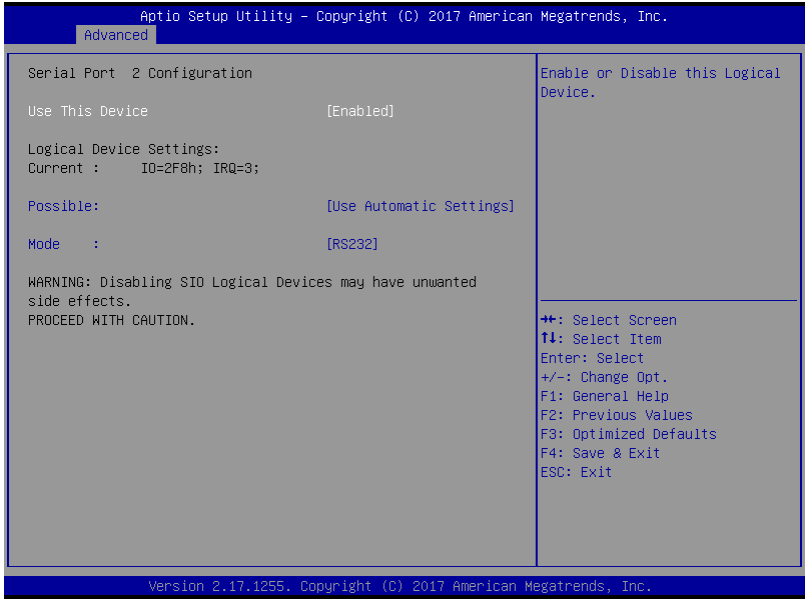

Options summary:

Use This Device	Disabled	Optimal Default, Failsafe Default
	Enabled	
En/Disable Serial Port (COM)		
Possible:	Use Automatic Settings	Optimal Default, Failsafe Default
	IO=2F8; IRQ=3;	
	IO=3F8; IRQ=4;	
Select an optimal setting for IO device		
mode	RS232	Optimal Default, Failsafe Default
	RS422	
	RS485	
Uart RS232/422/485 selection		

3.4.4 Hardware Monitor

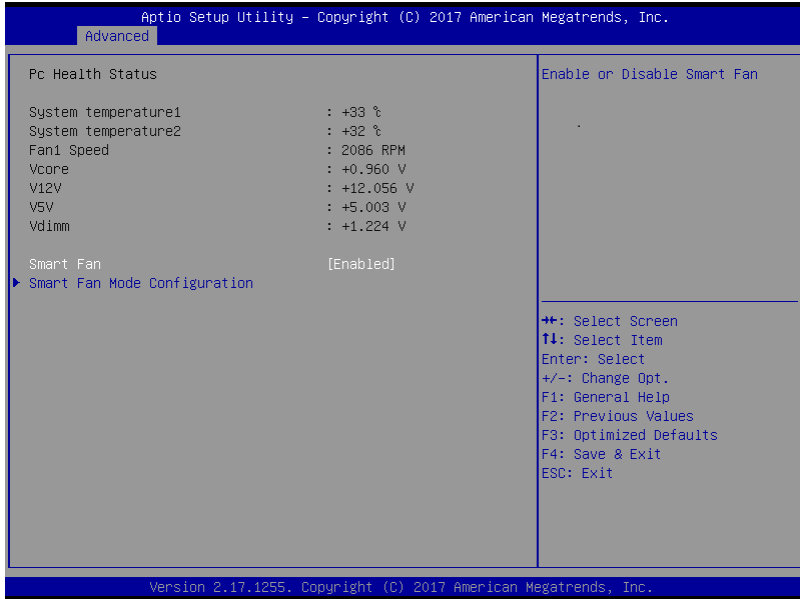

Options summary:

Fan1 Smart Fan control	Manual RPM Mode	Optimal Default, Failsafe Default
	Manual Duty Mode	
	Auto RPM Mode	
	Auto Duty-Cycle Mode	

3.4.4.1 CPU Smart Fan Mode Configuration

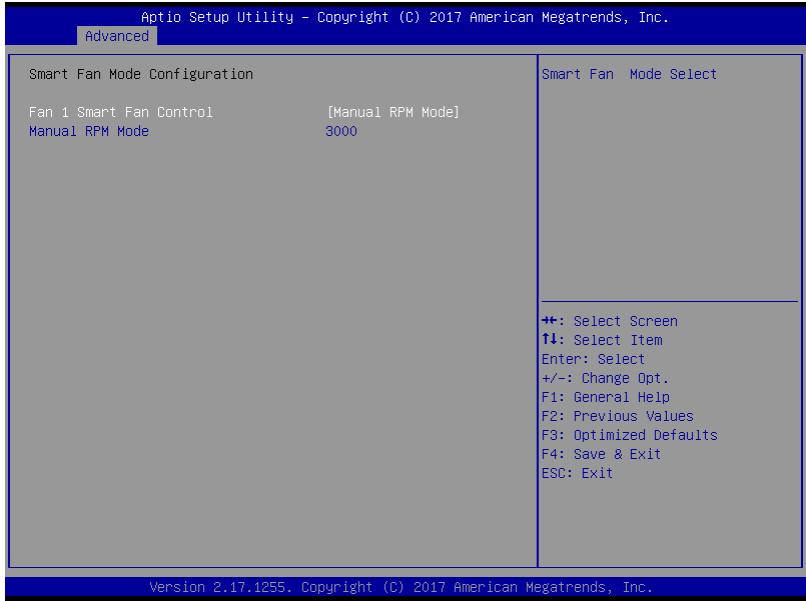

Options summary:

Manual Setting	3000	Optimal Default, Failsafe Default
Set Fan at fixed RPM		



Options summary:

Manual Setting	60	Optimal Default, Failsafe Default
Set Fan at fixed Duty-Cycle Min=0 Max=100 Please input Dec number:		

Aptio Setup Utility - Copyright (C) 2017 American Megatrends, Inc.

Advanced

<p>Smart Fan Mode Configuration</p> <pre> Fan 1 Smart Fan Control [Auto RPM Mode] Temperature Source [CPU(external)] Temperature 1 60 Temperature 2 50 Temperature 3 40 Temperature 4 30 RPM Percentage 1 85 RPM Percentage 2 70 RPM Percentage 3 60 RPM Percentage 4 50 RPM Percentage 5 40 </pre>	<p>Smart Fan Mode Select</p> <hr/> <pre> +/: Select Screen ↑↓: Select Item Enter: Select +/-: Change Opt. F1: General Help F2: Previous Values F3: Optimized Defaults F4: Save & Exit ESC: Exit </pre>
---	--

Version 2.17.1255. Copyright (C) 2017 American Megatrends, Inc.

Aptio Setup Utility - Copyright (C) 2017 American Megatrends, Inc.

Advanced

<p>Smart Fan Mode Configuration</p> <pre> Fan 1 Smart Fan Control [Auto RPM Mode] Temperature Source [CPU(external)] Temperature 1 60 Temperature 2 50 Temperature 3 40 Temperature 4 30 RPM Percentage 1 85 RPM Percentage 2 70 RPM Percentage 3 60 RPM Percentage 4 50 RPM Percentage 5 40 </pre>	<p>Smart Fan Mode Select</p> <hr/> <pre> +/: Select Screen ↑↓: Select Item Enter: Select +/-: Change Opt. F1: General Help F2: Previous Values F3: Optimized Defaults F4: Save & Exit ESC: Exit </pre>
---	--

Version 2.17.1255. Copyright (C) 2017 American Megatrends, Inc.

3.4.5 USB Configuration

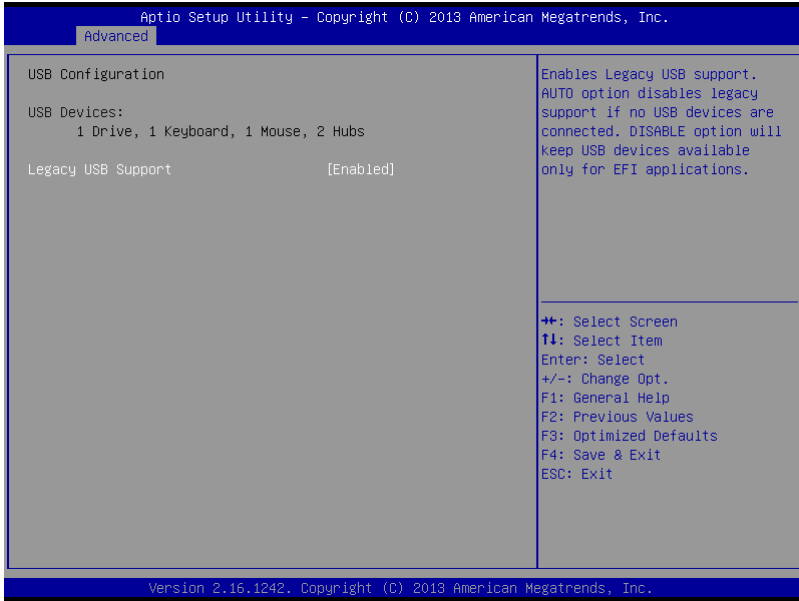

Options summary:

Legacy USB Support	Enabled	Optimal Default, Failsafe Default
	Disabled	
	Auto	
Enables BIOS Support for Legacy USB Support. When enabled, USB can be functional in legacy environment like DOS. AUTO option disables legacy support if no USB devices are connected		
Device Name (Emulation Type)	Auto	Optimal Default, Failsafe Default
	Floppy	
	Forced FDD	
	Hard Disk	
	CDROM	

If Auto. USB devices less than 530MB will be emulated as Floppy and remaining as Floppy and remaining as hard drive. Forced FDD option can be used to force a HDD formatted drive to boot as FDD(Ex. ZIP drive)

USB Port 0/1 function routing	FCH USB port 8/9	Optimal Default, Failsafe Default
	FCH USB port 0/1	

3.4.6 Digital IO Port Configuration

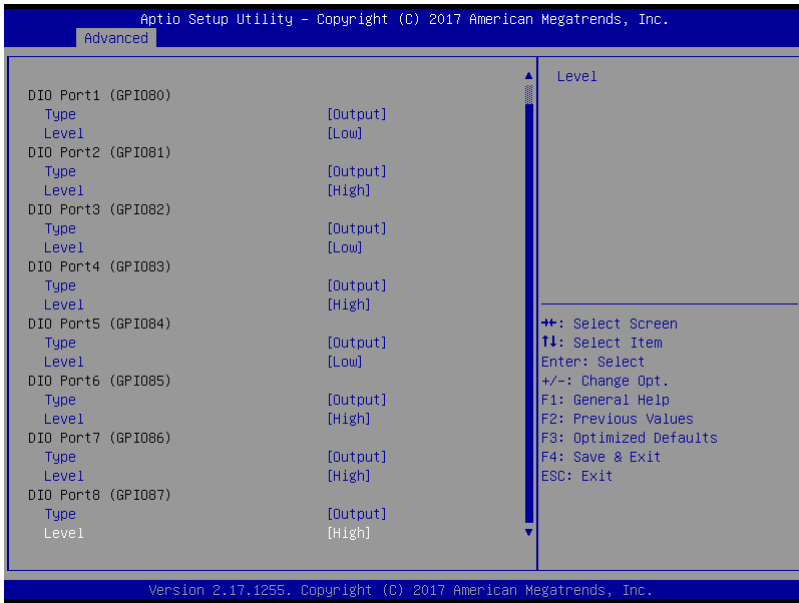

Options summary:

DIO Port*	Output	
	Input	
Set DIO as Input or Output		
Output Level	High	
	Low	
Set output level when DIO pin is output		

3.4.7 Power Management

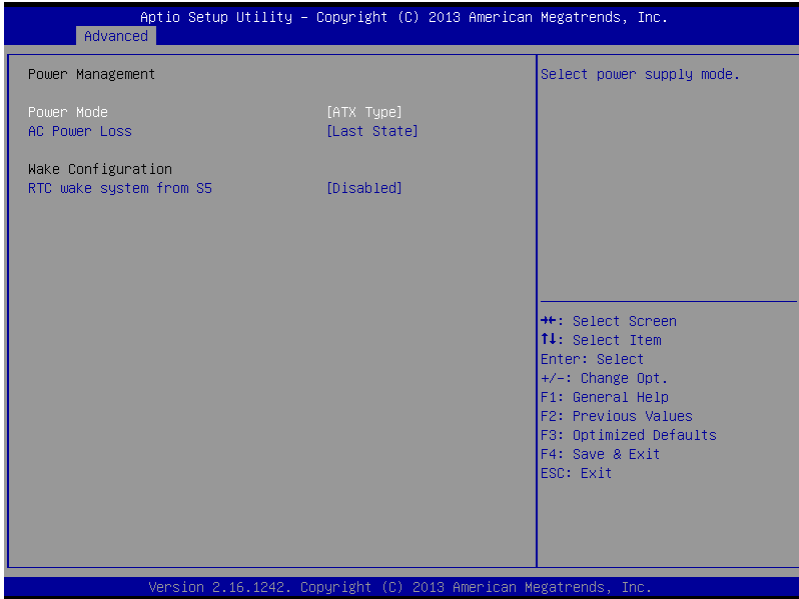

Options summary:

Power Mode	ATX Type	Optimal Default, Failsafe Default
	AT Type	
Select power supply mode.		
Restore on Power Loss	Last State	Optimal Default, Failsafe Default
	Power On	
	Power Off	
Select power state when power is re-applied after a power failure.		
RTC wake system from S5	Disabled	Optimal Default, Failsafe Default
	Fixed Time	
	Dynamic Time	

Enable or disable System wake on alarm event. When enabled, System will wake on the hr::min::sec specified

3.5 Submenu Chipset

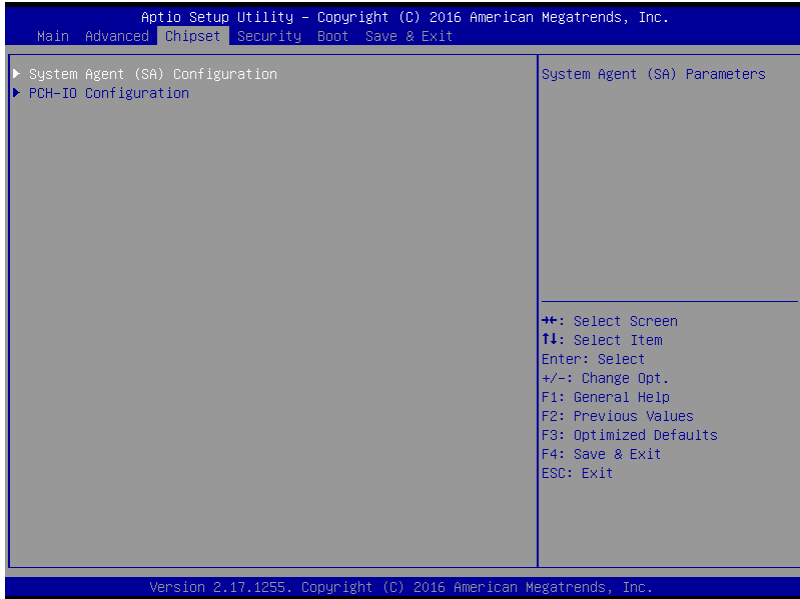

3.5.1 System Agent (SA) Configuration

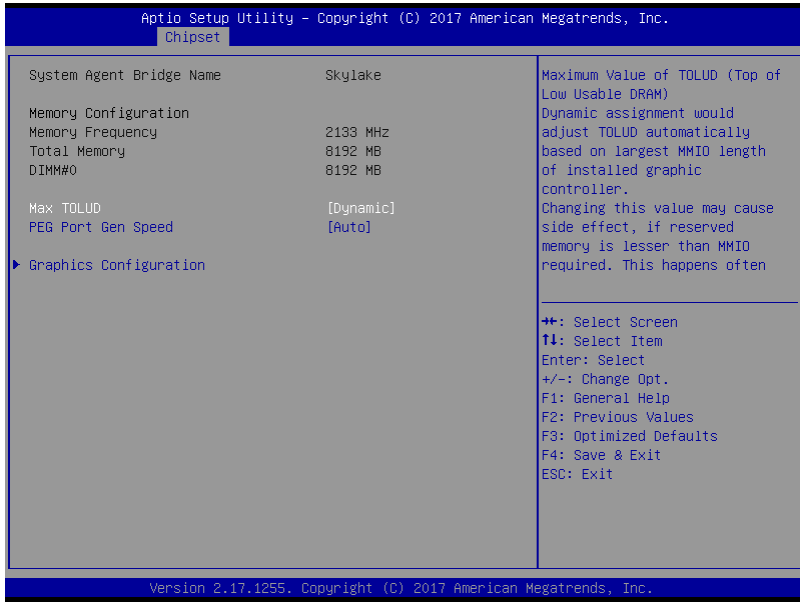

Options summary:

Max TOLUD	Dynamic	Optimal Default, Failsafe Default
	1 GB	
	1.25 GB	
	1.5 GB	
	1.75 GB	
	2 GB	
	2.25 GB	
	2.5 GB	
	2.75 GB	
	3 GB	
	3.25 GB	

Maximum Value of TOLUD Dynamic assignment would adjust TOLUD automatically based on largest MMIO length of installed graphic controller.

PEG Port Gen Speed	Auto	Optimal Default, Failsafe Default
	Gen1	
	Gen2	
	Gen3	
Configure PED 0:1:0 Max Speed		

3.5.1.1 Graphics Configuration

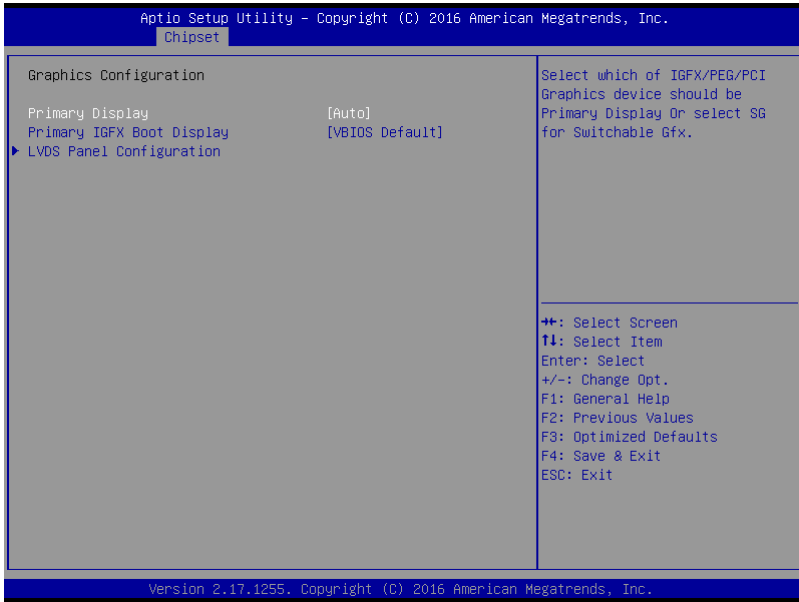

Options summary:

Primary Display	Auto	Optimal Default, Failsafe Default
	IGFX	
	PEG	
	PCIE	
Select which of IGFX/PEG Graphics device should be Primary Display.		
Primary IGFX Boot Display	VBIOS Default	Optimal Default, Failsafe Default
	CRT	
	LVDS	
	HDMI	

Select the Video Device which will be activated during POST. This has no effect if external graphic present.

Secondary boot display selection will appear based on your selection.

Secondary IGFX Boot Display	Disabled	Optimal Default, Failsafe Default
	CRT	
	HDMI	

Select Secondary Display Device

3.5.1.2 LVDS Panel Configuration

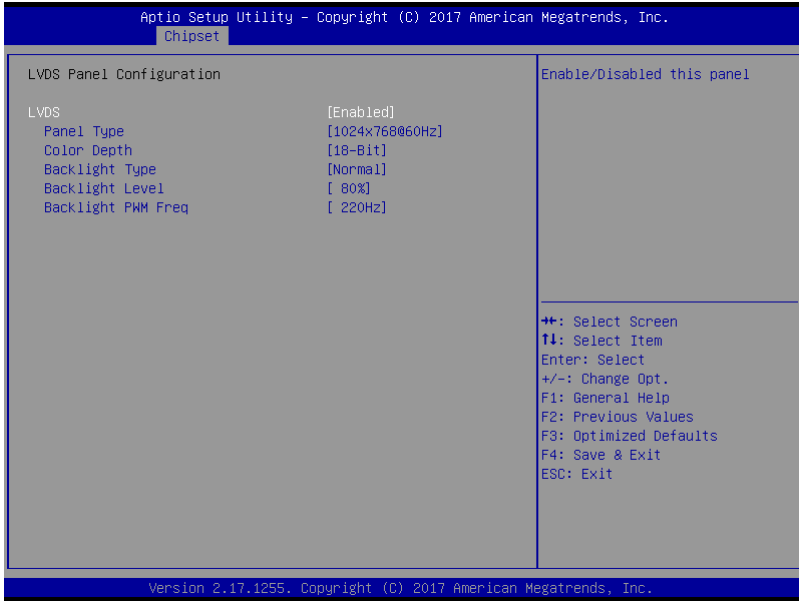

Options summary:

LVDS	Disabled	Optimal Default, Failsafe Default
	Enabled	
Enable/Disabled this panel.		
LVDS Panel Type	640x480@60Hz	Optimal Default, Failsafe Default
	800x480@60Hz	
	800x600@60Hz	
	1024x600@60Hz	
	1024x768@60Hz	
	1280x768@60Hz	
	1280x800@60Hz	
	1280x1024@60Hz	
	1366x768@60Hz	

	1440x900@60Hz	
	1600x1200@60Hz	
	1920x1080@60Hz	
	1920x1200@60Hz	
Select LCD panel used by Internal Graphics Device by selecting the appropriate setup item.		
Color Depth	18-bit	Optimal Default, Failsafe Default
	24-bit	
	36-bit	
	48-bit	
Select panel type		
Backlight Type	Normal	Optimal Default, Failsafe Default
	Inverted	
Select backlight control signal type		
Backlight Level	0%	Optimal Default, Failsafe Default
	10%	
	20%	
	30%	
	40%	
	50%	
	60%	
	70%	
	80%	
	90%	
100%		
Select backlight control level		
Backlight PWM Freq	100Hz	Optimal Default, Failsafe Default
	200Hz	
	220Hz	

	500Hz
	1KHz
	2.2KHz
	6.5KHz
Select PWM frequency of backlight control signal	

3.5.2 PCH-IO Configuration

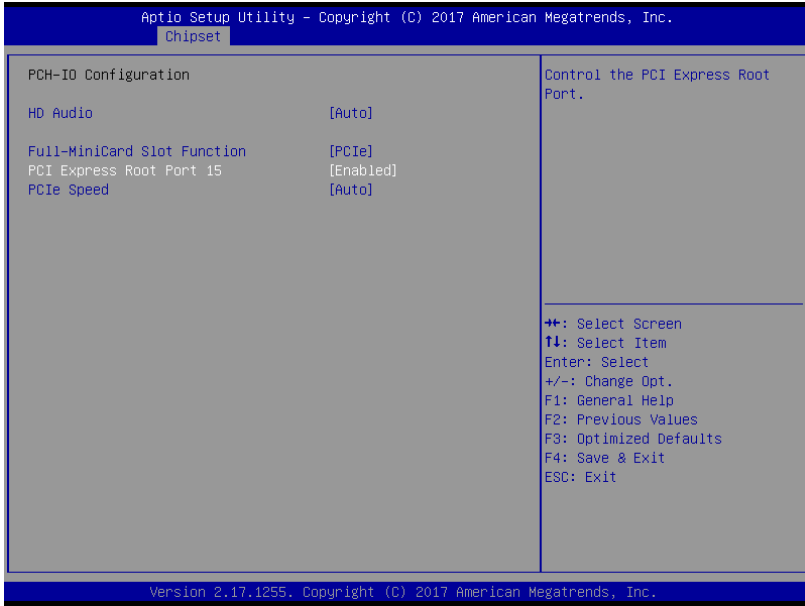

Options summary:

Full-MiniCard Slot Function	SATA	Optimal Default, Failsafe Default
	PCIe	
Switch minicard slot function (Excluding H110 SKU)		
PCI Express Root Port 15	Disabled	Optimal Default, Failsafe Default
	Enabled	
Control the PCIe root port		
PCIe Speed	Auto	Optimal Default, Failsafe Default
	Gen1	
	Gen2	
	Gen3	
Select PCI Express port speed.		

3.6 Security

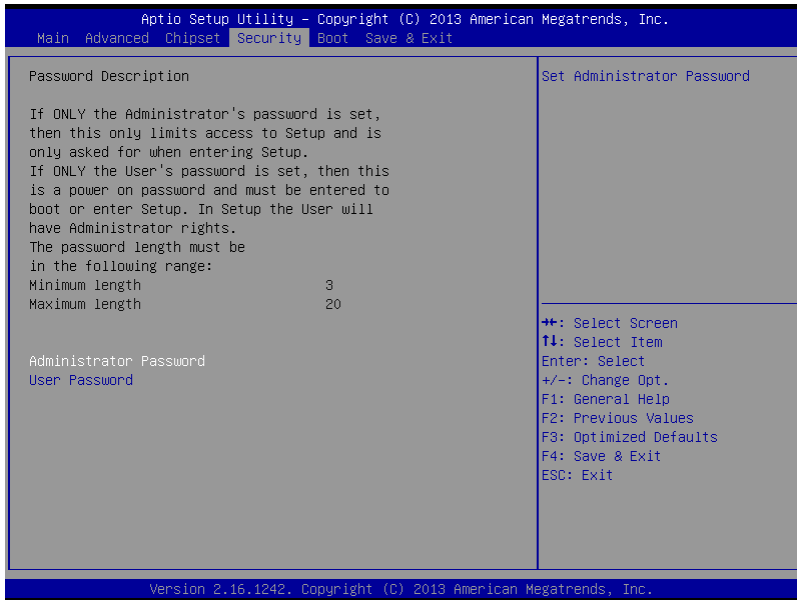

Change User/Supervisor Password

You can install a Supervisor password, and if you install a supervisor password, you can then install a user password. A user password does not provide access to many of the features in the Setup utility.

If you highlight these items and press Enter, a dialog box appears which lets you enter a password. You can enter no more than six letters or numbers. Press Enter after you have typed in the password. A second dialog box asks you to retype the password for confirmation. Press Enter after you have retyped it correctly. The password is required at boot time, or when the user enters the Setup utility.

Removing the Password

Highlight this item and type in the current password. At the next dialog box press Enter to disable password protection.

3.7 Submenu: Boot

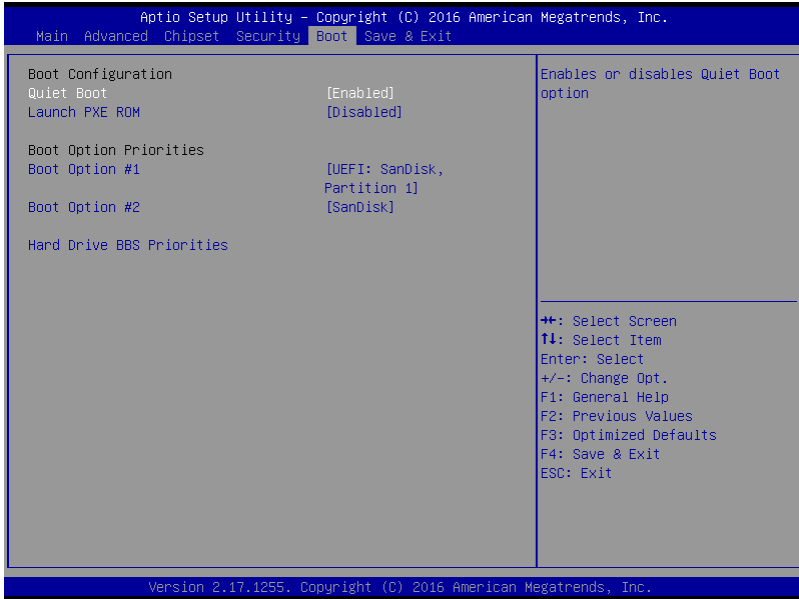

Options summary:

Quiet Boot	Disabled	Optimal Default, Failsafe Default
	Enabled	
En/Disable showing boot logo.		
Launch PXE OpROM	Disabled	Optimal Default, Failsafe Default
	Enabled	
Controls the execution of UEFI and Legacy PXE OpROM		

3.7.1 BBS Priorities

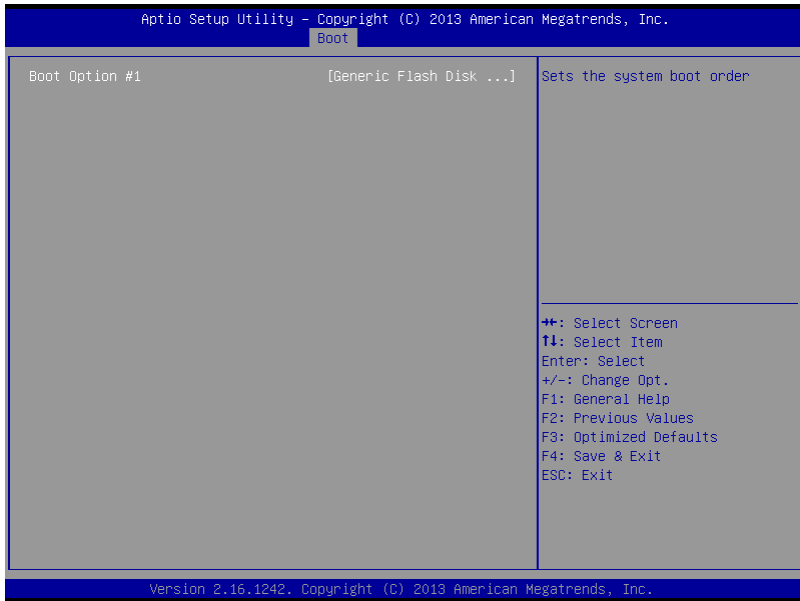

3.8 Submenu: Exit

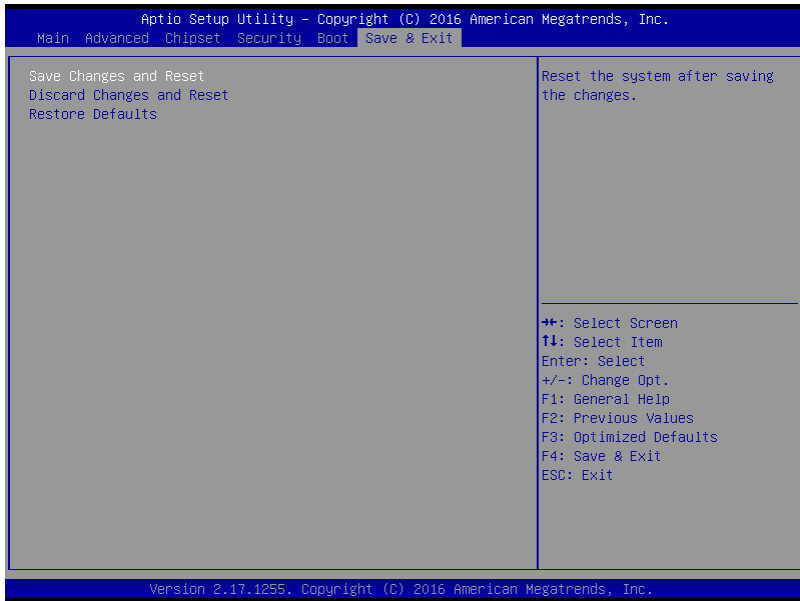

Chapter 4

Drivers Installation

4.1 Product CD/DVD

The EPIC-KBS7 comes with a product DVD that contains all the drivers and utilities you need to setup your product. Insert the DVD and follow the steps in the autorun program to install the drivers.

In case the program does not start, follow the sequence below to install the drivers.

Step 1 – Install Chipset Drivers

1. Open the **Step 1 – Chipset** folder followed by **infirst_autol.exe**
2. Follow the instructions
3. Drivers will be installed automatically

Step 2 – Install Graphics Driver

1. Open the **STEP2 - VGA** folder and select your OS
2. Open the **Setup.exe** file in the folder
3. Follow the instructions
4. Drivers will be installed automatically

Note 1:

- This motherboard supports VGA and LVDS display devices. In Single Display mode. By default, press **<Ctrl>+<Alt>+<F1>** to switch to VGA device and press **<Ctrl>+<Alt>+<F3>** to switch to LVDS device.
- Before removing the current display device, connect the display device that you want to use, and then press the hot keys to switch to that device.

Note 2: If you are using Windows® XP, you have to install the driver of dotNet Framework first (**dotnetfx35.exe** in **dotNet Framework** folder).

Step 3 – Install LAN Driver

1. Open the **STEP3 – LAN (Intel_82579)** folder and select your OS

2. Open the **.exe** file in the folder
3. Follow the instructions
4. Drivers will be installed automatically

Step 4 – Install Audio Driver

1. Open the **STEP4 – Audio** folder and select your OS
2. Open the **Setup.exe** file in the folder
3. Follow the instructions
4. Drivers will be installed automatically

Step 5 – Install ME Drivers

1. Open the **STEP5 – ME SW** folder and select your OS
2. Open the **Setup.exe** file in the folder
3. Follow the instructions
4. Drivers will be installed automatically

Step 6 – Install RAID & AHCI Drivers

Please refer to Appendix E RAID & AHCI Settings

Step 7 – Install TPM Driver

1. Open the **STEP7 – TPM** folder and select your OS
2. Open the **Setup.exe** file in the folder
3. Follow the instructions
4. Drivers will be installed automatically

Step 8 – Install Touch Driver

1. Open the **STEP8 – Touch** folder and select your OS
2. Open the **Setup.exe** file in the folder
3. Follow the instructions

4. Drivers will be installed automatically

Step 9 – Install USB 3.0 Driver

1. Open the **STEP9 – USB 3.0** folder and select your OS
2. Open the **Setup.exe** file in the folder
3. Follow the instructions
4. Drivers will be installed automatically

Appendix A

Watchdog Timer Programming

A.1 Watchdog Timer Initial Program

Table 1 : Super I/O relative register table		
	Default Value	Note
Index	0x2E(Note1)	SIO MB PnP Mode Index Register 0x2E or 0x4E
Data	0x2F(Note2)	SIO MB PnP Mode Data Register 0x2F or 0x4F

Table 2 : Watchdog relative register table					
	LDN	Register	BitNum	Value	Note
Timer Counter	0x07(Note3)	0xF6(Note4)		(Note24)	Time of watchdog timer (0~255) This register is byte access
Counting Unit	0x07(Note5)	0xF5(Note6)	3(Note7)	0(Note8)	Select time unit. 0: second 1: minute
Watchdog Enable	0x07(Note9)	0xF5(Note10)	5(Note11)	1(Note12)	0: Disable 1: Enable
Timeout Status	0x07(Note13)	0xF5(Note14)	6(Note15)	1	1: Clear timeout status
Output Mode	0x07(Note16)	0xF5(Note17)	4(Note18)	1(Note19)	Select WDTRST# output mode 0: level 1: pulse
WDTRST output	0x07(Note20)	0xFA(Note21)	0(Note22)	1(Note23)	Enable/Disable time out output via WDTRST# 0: Disable 1: Enable

```
*****
// SuperIO relative definition (Please reference to Table 1)
#define byte   SIOIndex //This parameter is represented from Note1
#define byte   SIOData //This parameter is represented from Note2
#define void   IOWriteByte(byte IOPort, byte Value);
#define byte   IOReadByte(byte IOPort);
// Watch Dog relative definition (Please reference to Table 2)
#define byte   TimerLDN //This parameter is represented from Note3
#define byte   TimerReg //This parameter is represented from Note4
#define byte   TimerVal // This parameter is represented from Note24
#define byte   UnitLDN //This parameter is represented from Note5
#define byte   UnitReg //This parameter is represented from Note6
#define byte   UnitBit //This parameter is represented from Note7
#define byte   UnitVal //This parameter is represented from Note8
#define byte   EnableLDN //This parameter is represented from Note9
#define byte   EnableReg //This parameter is represented from Note10
#define byte   EnableBit //This parameter is represented from Note11
#define byte   EnableVal //This parameter is represented from Note12
#define byte   StatusLDN // This parameter is represented from Note13
#define byte   StatusReg // This parameter is represented from Note14
#define byte   StatusBit // This parameter is represented from Note15
#define byte   ModeLDN // This parameter is represented from Note16
#define byte   ModeReg // This parameter is represented from Note17
#define byte   ModeBit // This parameter is represented from Note18
#define byte   ModeVal // This parameter is represented from Note19
#define byte   WDTRstLDN // This parameter is represented from Note20
#define byte   WDTRstReg // This parameter is represented from Note21
#define byte   WDTRstBit // This parameter is represented from Note22
#define byte   WDTRstVal // This parameter is represented from Note23
*****
```

```
*****
VOID Main(){
    // Procedure : AaeonWDTConfig
    // (byte)Timer : Time of WDT timer.(0x00~0xFF)
    // (boolean)Unit : Select time unit(0: second, 1: minute).
    AaeonWDTConfig();

    // Procedure : AaeonWDTEnable
    // This procedure will enable the WDT counting.
    AaeonWDTEnable();
}
*****
```

```

*****
// Procedure : AaeonWDTEnable
VOID  AaeonWDTEnable (){
    WDTEnableDisable(EnableLDN, EnableReg, EnableBit, 1);
}

// Procedure : AaeonWDTConfig
VOID  AaeonWDTConfig (){
    // Disable WDT counting
    WDTEnableDisable(EnableLDN, EnableReg, EnableBit, 0);
    // Clear Watchdog Timeout Status
    WDTClearTimeoutStatus();
    // WDT relative parameter setting
    WDTParameterSetting();
}

VOID  WDTEnableDisable(byte LDN, byte Register, byte BitNum, byte Value){
    SIOBitSet(LDN, Register, BitNum, Value);
}

VOID  WDTParameterSetting(){
    // Watchdog Timer counter setting
    SIOByteSet(TimerLDN, TimerReg, TimerVal);
    // WDT counting unit setting
    SIOBitSet(UnitLDN, UnitReg, UnitBit, UnitVal);
    // WDT output mode setting, level / pulse
    SIOBitSet(ModelLDN, ModeReg, ModeBit, ModeVal);
    // Watchdog timeout output via WDTRST#
    SIOBitSet(WDTRstLDN, WDTRstReg, WDTRstBit, WDTRstVal);
}

VOID  WDTClearTimeoutStatus(){
    SIOBitSet(StatusLDN, StatusReg, StatusBit, 1);
}
*****

```

```

*****
VOID  SIOEnterMBPnPMode(){
    IOWriteByte(SIOIndex, 0x87);
    IOWriteByte(SIOIndex, 0x87);
}

VOID  SIOExitMBPnPMode(){
    IOWriteByte(SIOIndex, 0xAA);
}

VOID  SIOSelectLDN(byte LDN){
    IOWriteByte(SIOIndex, 0x07); // SIO LDN Register Offset = 0x07
    IOWriteByte(SIOData, LDN);
}

VOID  SIOBitSet(byte LDN, byte Register, byte BitNum, byte Value){
    Byte TmpValue;

    SIOEnterMBPnPMode();
    SIOSelectLDN(byte LDN);
    IOWriteByte(SIOIndex, Register);
    TmpValue = IOReadByte(SIOData);
    TmpValue &= ~(1 << BitNum);
    TmpValue |= (Value << BitNum);
    IOWriteByte(SIOData, TmpValue);
    SIOExitMBPnPMode();
}

VOID  SIOByteSet(byte LDN, byte Register, byte Value){
    SIOEnterMBPnPMode();
    SIOSelectLDN(LDN);
    IOWriteByte(SIOIndex, Register);
    IOWriteByte(SIOData, Value);
    SIOExitMBPnPMode();
}
*****

```

Appendix B

































I/O Information

B.1 I/O Address Map

DESKTOP-282073Q



































Input/output (IO)

[0000000000000000 - 000000000000CF7]	PCI Express Root Complex
[0000000000000020 - 0000000000000021]	Programmable interrupt controller
[0000000000000024 - 0000000000000025]	Programmable interrupt controller
[0000000000000028 - 0000000000000029]	Programmable interrupt controller
[000000000000002C - 000000000000002D]	Programmable interrupt controller
[000000000000002E - 000000000000002F]	Motherboard resources
[0000000000000030 - 0000000000000031]	Programmable interrupt controller
[0000000000000034 - 0000000000000035]	Programmable interrupt controller
[0000000000000038 - 0000000000000039]	Programmable interrupt controller
[000000000000003C - 000000000000003D]	Programmable interrupt controller
[0000000000000040 - 0000000000000043]	System timer
[000000000000004E - 000000000000004F]	Motherboard resources
[0000000000000050 - 0000000000000053]	System timer
[0000000000000060 - 0000000000000060]	Standard PS/2 Keyboard
[0000000000000061 - 0000000000000061]	Motherboard resources
[0000000000000063 - 0000000000000063]	Motherboard resources
[0000000000000064 - 0000000000000064]	Standard PS/2 Keyboard
[0000000000000065 - 0000000000000065]	Motherboard resources
[0000000000000067 - 0000000000000067]	Motherboard resources
[0000000000000070 - 0000000000000070]	Motherboard resources
[0000000000000070 - 0000000000000077]	System CMOS/real time clock
[0000000000000080 - 0000000000000080]	Motherboard resources
[0000000000000092 - 0000000000000092]	Motherboard resources
[00000000000000A0 - 00000000000000A1]	Programmable interrupt controller
[00000000000000A4 - 00000000000000A5]	Programmable interrupt controller
[00000000000000A8 - 00000000000000A9]	Programmable interrupt controller
[00000000000000AC - 00000000000000AD]	Programmable interrupt controller
[00000000000000B0 - 00000000000000B1]	Programmable interrupt controller
[00000000000000B2 - 00000000000000B3]	Motherboard resources
[00000000000000B4 - 00000000000000B5]	Programmable interrupt controller
[00000000000000B8 - 00000000000000B9]	Programmable interrupt controller
[00000000000000BC - 00000000000000BD]	Programmable interrupt controller
[00000000000000F0 - 00000000000000F0]	Numeric data processor

	[00000000000000F0 - 00000000000000F0]	Numeric data processor
	[00000000000002E8 - 00000000000002EF]	Communications Port (COM4)
	[00000000000002F8 - 00000000000002FF]	Communications Port (COM2)
	[00000000000003B0 - 00000000000003BB]	Intel(R) HD Graphics 630
	[00000000000003C0 - 00000000000003DF]	Intel(R) HD Graphics 630
	[00000000000003E8 - 00000000000003EF]	Communications Port (COM3)
	[00000000000003F8 - 00000000000003FF]	Communications Port (COM1)
	[00000000000004D0 - 00000000000004D1]	Programmable interrupt controller
	[0000000000000680 - 000000000000069F]	Motherboard resources
	[0000000000000800 - 000000000000087F]	Motherboard resources
	[0000000000000A00 - 0000000000000A0F]	Motherboard resources
	[0000000000000A10 - 0000000000000A1F]	Motherboard resources
	[0000000000000A20 - 0000000000000A2F]	Motherboard resources
	[0000000000000D00 - 000000000000FFFF]	PCI Express Root Complex
	[000000000000164E - 000000000000164F]	Motherboard resources
	[0000000000001800 - 00000000000018FE]	Motherboard resources
	[0000000000001854 - 0000000000001857]	Motherboard resources
	[000000000000D000 - 000000000000DFFF]	Intel(R) 100 Series/C230 Series Chipset Family PCI Express Root Port #7 - A116
	[000000000000E000 - 000000000000EFFF]	Intel(R) 100 Series/C230 Series Chipset Family PCI Express Root Port #6 - A115
	[000000000000F000 - 000000000000F03F]	Intel(R) HD Graphics 630
	[000000000000F040 - 000000000000F05F]	Intel(R) 100 Series/C230 Series Chipset Family SMBus - A123
	[000000000000F060 - 000000000000F07F]	Standard SATA AHCI Controller
	[000000000000F080 - 000000000000F083]	Standard SATA AHCI Controller
	[000000000000F090 - 000000000000F097]	Standard SATA AHCI Controller
	[000000000000FF00 - 000000000000FFFE]	Motherboard resources
	[000000000000FFFF - 000000000000FFFF]	Motherboard resources
	[000000000000FFFF - 000000000000FFFF]	Motherboard resources
	[000000000000FFFF - 000000000000FFFF]	Motherboard resources
>	Interrupt request (IRQ)	
▼	Memory	
	[000000000000A000 - 000000000000BFFF]	Intel(R) HD Graphics 630
	[000000000000A000 - 000000000000BFFF]	PCI Express Root Complex
	[0000000090000000 - 00000000DFFFFFFF]	PCI Express Root Complex
	[00000000C0000000 - 00000000CFFFFFFF]	Intel(R) HD Graphics 630
	[00000000DE000000 - 00000000DEFFFFFF]	Intel(R) HD Graphics 630

B.2 Memory Address Map

Address Range	Device Name
[00000000000A0000 - 00000000000BFFFFF]	Intel(R) HD Graphics 630
[00000000000A0000 - 00000000000BFFFFF]	PCI Express Root Complex
[0000000090000000 - 00000000DFFFFFFF]	PCI Express Root Complex
[00000000C0000000 - 00000000CFFFFFFF]	Intel(R) HD Graphics 630
[00000000DE000000 - 00000000DEFFFFFFF]	Intel(R) HD Graphics 630
[00000000DF000000 - 00000000DF01FFFFF]	Intel(R) I211 Gigabit Network Connection
[00000000DF000000 - 00000000DF0FFFFF]	Intel(R) 100 Series/C230 Series Chipset Family PCI Express Root Port #7 - A116
[00000000DF020000 - 00000000DF023FFF]	Intel(R) I211 Gigabit Network Connection
[00000000DF100000 - 00000000DF11FFFFF]	Intel(R) I211 Gigabit Network Connection #2
[00000000DF100000 - 00000000DF1FFFFF]	Intel(R) 100 Series/C230 Series Chipset Family PCI Express Root Port #6 - A115
[00000000DF120000 - 00000000DF123FFF]	Intel(R) I211 Gigabit Network Connection #2
[00000000DF200000 - 00000000DF20FFFFF]	High Definition Audio Controller
[00000000DF210000 - 00000000DF21FFFFF]	Intel(R) USB 3.0 eXtensible Host Controller - 1.0 (Microsoft)
[00000000DF220000 - 00000000DF223FFF]	High Definition Audio Controller
[00000000DF224000 - 00000000DF227FFF]	Intel(R) 100 Series/C230 Series Chipset Family PMC - A121
[00000000DF228000 - 00000000DF229FFF]	Standard SATA AHCI Controller
[00000000DF22A000 - 00000000DF22A0FFF]	Intel(R) 100 Series/C230 Series Chipset Family SMBus - A123
[00000000DF22B000 - 00000000DF22B7FFF]	Standard SATA AHCI Controller
[00000000DF22C000 - 00000000DF22C0FFF]	Standard SATA AHCI Controller
[00000000DF22D000 - 00000000DF22DFFFF]	Intel(R) 100 Series/C230 Series Chipset Family Thermal subsystem - A131
[00000000DFFE0000 - 00000000DFFFFFFF]	Motherboard resources
[00000000E0000000 - 00000000EFFFFFFF]	Motherboard resources
[00000000FD000000 - 00000000FDABFFFFF]	Motherboard resources
[00000000FD000000 - 00000000FE77FFFFF]	PCI Express Root Complex
[00000000FDAC0000 - 00000000FDACFFFFF]	Motherboard resources
[00000000FDAD0000 - 00000000FDADFFFFF]	Motherboard resources
[00000000FDAE0000 - 00000000FDAEFFFFF]	Motherboard resources
[00000000FDAF0000 - 00000000FDAFFFFF]	Motherboard resources
[00000000FDB00000 - 00000000FDBFFFFF]	Motherboard resources
[00000000FE000000 - 00000000FE01FFFFF]	Motherboard resources
[00000000FE036000 - 00000000FE03BFFFF]	Motherboard resources
[00000000FE03D000 - 00000000FE03FFFFF]	Motherboard resources
[00000000FE410000 - 00000000FE77FFFFF]	Motherboard resources
[00000000FED00000 - 00000000FED003FFF]	High precision event timer





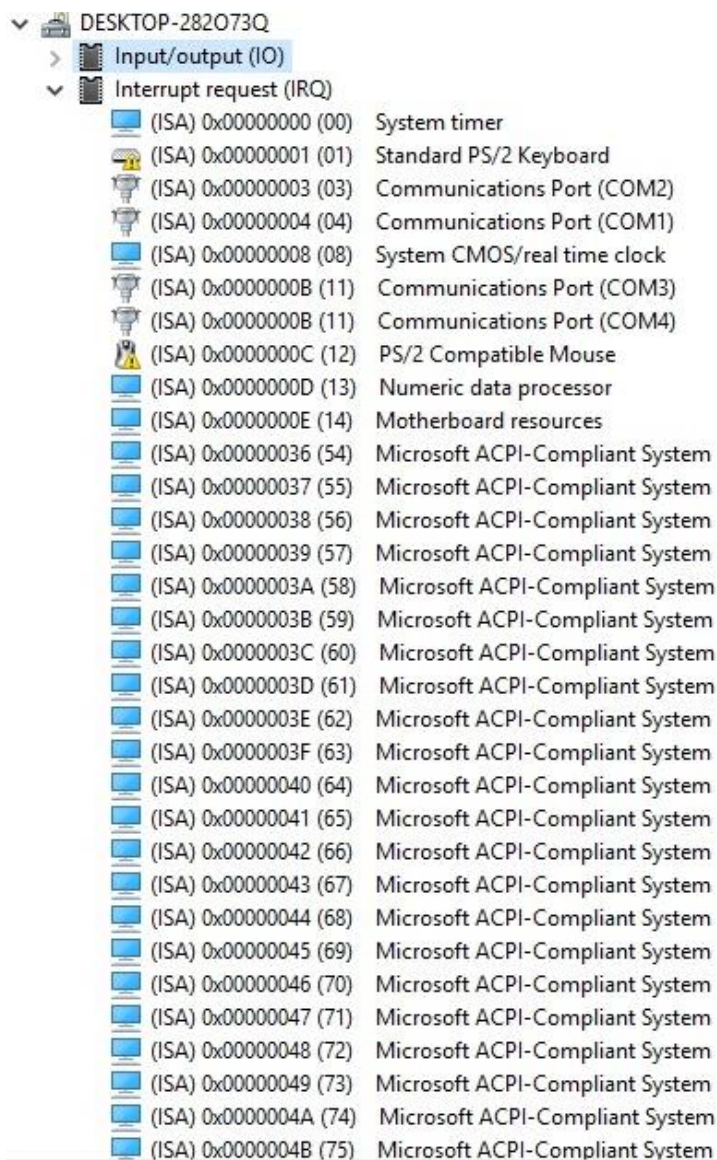



























	(ISA) 0x000001F3 (499)	Microsoft ACPI-Compliant System
	(ISA) 0x000001F4 (500)	Microsoft ACPI-Compliant System
	(ISA) 0x000001F5 (501)	Microsoft ACPI-Compliant System
	(ISA) 0x000001F6 (502)	Microsoft ACPI-Compliant System
	(ISA) 0x000001F7 (503)	Microsoft ACPI-Compliant System
	(ISA) 0x000001F8 (504)	Microsoft ACPI-Compliant System
	(ISA) 0x000001F9 (505)	Microsoft ACPI-Compliant System
	(ISA) 0x000001FA (506)	Microsoft ACPI-Compliant System
	(ISA) 0x000001FB (507)	Microsoft ACPI-Compliant System
	(ISA) 0x000001FC (508)	Microsoft ACPI-Compliant System
	(ISA) 0x000001FD (509)	Microsoft ACPI-Compliant System
	(ISA) 0x000001FE (510)	Microsoft ACPI-Compliant System
	(ISA) 0x000001FF (511)	Microsoft ACPI-Compliant System
	(PCI) 0x00000005 (05)	Intel(R) 100 Series/C230 Series Chipset Family SMBus - A123
	(PCI) 0x00000006 (06)	Intel(R) 100 Series/C230 Series Chipset Family Thermal subsystem - A131
	(PCI) 0x00000010 (16)	High Definition Audio Controller
	(PCI) 0xFFFFFFFEE (-18)	Intel(R) I211 Gigabit Network Connection #2
	(PCI) 0xFFFFFFFEF (-17)	Intel(R) I211 Gigabit Network Connection #2
	(PCI) 0xFFFFFFF0 (-16)	Intel(R) I211 Gigabit Network Connection #2
	(PCI) 0xFFFFFFF1 (-15)	Intel(R) I211 Gigabit Network Connection
	(PCI) 0xFFFFFFF2 (-14)	Intel(R) I211 Gigabit Network Connection
	(PCI) 0xFFFFFFF3 (-13)	Intel(R) I211 Gigabit Network Connection
	(PCI) 0xFFFFFFF4 (-12)	Intel(R) I211 Gigabit Network Connection
	(PCI) 0xFFFFFFF5 (-11)	Intel(R) I211 Gigabit Network Connection
	(PCI) 0xFFFFFFF6 (-10)	Intel(R) I211 Gigabit Network Connection
	(PCI) 0xFFFFFFF7 (-9)	Intel(R) I211 Gigabit Network Connection #2
	(PCI) 0xFFFFFFF8 (-8)	Intel(R) I211 Gigabit Network Connection #2
	(PCI) 0xFFFFFFF9 (-7)	Intel(R) I211 Gigabit Network Connection #2
	(PCI) 0xFFFFFFFA (-6)	Intel(R) USB 3.0 eXtensible Host Controller - 1.0 (Microsoft)
	(PCI) 0xFFFFFFF8 (-5)	Intel(R) HD Graphics 630
	(PCI) 0xFFFFFFF4 (-4)	Standard SATA AHCI Controller
	(PCI) 0xFFFFFFF3 (-3)	Intel(R) 100 Series/C230 Series Chipset Family PCI Express Root Port #7 - A116
	(PCI) 0xFFFFFFF2 (-2)	Intel(R) 100 Series/C230 Series Chipset Family PCI Express Root Port #6 - A115
> 	Memory	

B.3 IRQ Mapping Chart



The screenshot shows the Windows Device Manager for a system named 'DESKTOP-282073Q'. The 'Input/output (IO)' category is expanded, and the 'Interrupt request (IRQ)' category is also expanded. A list of 28 IRQs is displayed, each with an icon, an ISA address in parentheses, and a device name. IRQs 00 through 14 are represented by computer monitor icons, while IRQs 15 through 27 are represented by keyboard icons. IRQs 28 through 75 are represented by computer monitor icons.

(ISA) 0x00000000 (00)	System timer
(ISA) 0x00000001 (01)	Standard PS/2 Keyboard
(ISA) 0x00000003 (03)	Communications Port (COM2)
(ISA) 0x00000004 (04)	Communications Port (COM1)
(ISA) 0x00000008 (08)	System CMOS/real time clock
(ISA) 0x0000000B (11)	Communications Port (COM3)
(ISA) 0x0000000B (11)	Communications Port (COM4)
(ISA) 0x0000000C (12)	PS/2 Compatible Mouse
(ISA) 0x0000000D (13)	Numeric data processor
(ISA) 0x0000000E (14)	Motherboard resources
(ISA) 0x00000036 (54)	Microsoft ACPI-Compliant System
(ISA) 0x00000037 (55)	Microsoft ACPI-Compliant System
(ISA) 0x00000038 (56)	Microsoft ACPI-Compliant System
(ISA) 0x00000039 (57)	Microsoft ACPI-Compliant System
(ISA) 0x0000003A (58)	Microsoft ACPI-Compliant System
(ISA) 0x0000003B (59)	Microsoft ACPI-Compliant System
(ISA) 0x0000003C (60)	Microsoft ACPI-Compliant System
(ISA) 0x0000003D (61)	Microsoft ACPI-Compliant System
(ISA) 0x0000003E (62)	Microsoft ACPI-Compliant System
(ISA) 0x0000003F (63)	Microsoft ACPI-Compliant System
(ISA) 0x00000040 (64)	Microsoft ACPI-Compliant System
(ISA) 0x00000041 (65)	Microsoft ACPI-Compliant System
(ISA) 0x00000042 (66)	Microsoft ACPI-Compliant System
(ISA) 0x00000043 (67)	Microsoft ACPI-Compliant System
(ISA) 0x00000044 (68)	Microsoft ACPI-Compliant System
(ISA) 0x00000045 (69)	Microsoft ACPI-Compliant System
(ISA) 0x00000046 (70)	Microsoft ACPI-Compliant System
(ISA) 0x00000047 (71)	Microsoft ACPI-Compliant System
(ISA) 0x00000048 (72)	Microsoft ACPI-Compliant System
(ISA) 0x00000049 (73)	Microsoft ACPI-Compliant System
(ISA) 0x0000004A (74)	Microsoft ACPI-Compliant System
(ISA) 0x0000004B (75)	Microsoft ACPI-Compliant System

	(ISA) 0x000001F3 (499)	Microsoft ACPI-Compliant System
	(ISA) 0x000001F4 (500)	Microsoft ACPI-Compliant System
	(ISA) 0x000001F5 (501)	Microsoft ACPI-Compliant System
	(ISA) 0x000001F6 (502)	Microsoft ACPI-Compliant System
	(ISA) 0x000001F7 (503)	Microsoft ACPI-Compliant System
	(ISA) 0x000001F8 (504)	Microsoft ACPI-Compliant System
	(ISA) 0x000001F9 (505)	Microsoft ACPI-Compliant System
	(ISA) 0x000001FA (506)	Microsoft ACPI-Compliant System
	(ISA) 0x000001FB (507)	Microsoft ACPI-Compliant System
	(ISA) 0x000001FC (508)	Microsoft ACPI-Compliant System
	(ISA) 0x000001FD (509)	Microsoft ACPI-Compliant System
	(ISA) 0x000001FE (510)	Microsoft ACPI-Compliant System
	(ISA) 0x000001FF (511)	Microsoft ACPI-Compliant System
	(PCI) 0x00000005 (05)	Intel(R) 100 Series/C230 Series Chipset Family SMBus - A123
	(PCI) 0x00000006 (06)	Intel(R) 100 Series/C230 Series Chipset Family Thermal subsystem - A131
	(PCI) 0x00000010 (16)	High Definition Audio Controller
	(PCI) 0xFFFFFFFF (-18)	Intel(R) I211 Gigabit Network Connection #2
	(PCI) 0xFFFFFFFF (-17)	Intel(R) I211 Gigabit Network Connection #2
	(PCI) 0xFFFFFFFF0 (-16)	Intel(R) I211 Gigabit Network Connection #2
	(PCI) 0xFFFFFFFF1 (-15)	Intel(R) I211 Gigabit Network Connection
	(PCI) 0xFFFFFFFF2 (-14)	Intel(R) I211 Gigabit Network Connection
	(PCI) 0xFFFFFFFF3 (-13)	Intel(R) I211 Gigabit Network Connection
	(PCI) 0xFFFFFFFF4 (-12)	Intel(R) I211 Gigabit Network Connection
	(PCI) 0xFFFFFFFF5 (-11)	Intel(R) I211 Gigabit Network Connection
	(PCI) 0xFFFFFFFF6 (-10)	Intel(R) I211 Gigabit Network Connection
	(PCI) 0xFFFFFFFF7 (-9)	Intel(R) I211 Gigabit Network Connection #2
	(PCI) 0xFFFFFFFF8 (-8)	Intel(R) I211 Gigabit Network Connection #2
	(PCI) 0xFFFFFFFF9 (-7)	Intel(R) I211 Gigabit Network Connection #2
	(PCI) 0xFFFFFFFFFA (-6)	Intel(R) USB 3.0 eXtensible Host Controller - 1.0 (Microsoft)
	(PCI) 0xFFFFFFFFFB (-5)	Intel(R) HD Graphics 630
	(PCI) 0xFFFFFFFFFC (-4)	Standard SATA AHCI Controller
	(PCI) 0xFFFFFFFFFD (-3)	Intel(R) 100 Series/C230 Series Chipset Family PCI Express Root Port #7 - A116
	(PCI) 0xFFFFFFFFFE (-2)	Intel(R) 100 Series/C230 Series Chipset Family PCI Express Root Port #6 - A115

>  Memory

Appendix C

Mating Connector Information

B.1 Mating Connector

Connector Label	Function	Mating Connector		Available Cable	Cable P/N
		Vendor	Model no		
CN1	LVDS Inverter Connector	JST	PHR-5	NA	NA
CN2	+9~24V Vin Connector	N/A	N/A	Power Cable	1702002010
CN3	LVDS Connector	HIROSE	DF13-30DS-1.25C	N/A	N/A
CN4	External +5VSB Power Input and PS_ON#	JST	PHR-3	ATX Cable	170220020B
CN5	Audio Connector	Molex	51021-1000	Audio Cable	1709100254
CN6	External RTC Connector	Molex	51021-0200	Battery Cable	175011901C
CN7	+5Vout Connector	JST	PHR-2	2 Pins For HDD Power	1702150155
CN8	USB Port Connector	Molex	51021-0500	USB Wafer Cable	1700050207
CN9	USB Port Connector	Molex	51021-0500	USB Wafer Cable	1700050207
CN10	SATA Connector	Molex	88750-5318	SATA Cable	1709070500
CN13	SATA Connector	Molex	88750-5318	SATA Cable	1709070500
CN14	CPU Fan Connector	Molex	22-01-2035	N/A	N/A
CN16	COM Port 2 Connector	Molex	51021-0900	Serial Port Cable	1701090150
CN17	COM Port 1 Connector	Molex	51021-0900	Serial Port Cable	1701090150
CN18	COM Port 3 Connector	Molex	51021-0900	Serial Port	1701090150

				Cable	
CN24	Digital I/O Connector	Neltron	2026B-10	N/A	N/A
CN26	COM Port 4 Connector	Molex	51021-0900	Serial Port Cable	1701090150