

# EPIC-ADS7-PUC

---

EPIC System

User's Manual 1<sup>st</sup> Ed

## Copyright Notice

---

This document is copyrighted, 2023. All rights are reserved. The original manufacturer reserves the right to make improvements to the products described in this manual at any time without notice.

No part of this manual may be reproduced, copied, translated, or transmitted in any form or by any means without the prior written permission of the original manufacturer. Information provided in this manual is intended to be accurate and reliable. However, the original manufacturer assumes no responsibility for its use, or for any infringements upon the rights of third parties that may result from its use.

The material in this document is for product information only and is subject to change without notice. While reasonable efforts have been made in the preparation of this document to assure its accuracy, AAEON assumes no liabilities resulting from errors or omissions in this document, or from the use of the information contained herein.

AAEON reserves the right to make changes in the product design without notice to its users.

## Acknowledgement

---

All other products' name or trademarks are properties of their respective owners.

- Microsoft Windows is a registered trademark of Microsoft Corp.
- Intel® is a registered trademark of Intel Corporation
- Intel® Core™ is a trademark of Intel Corporation
- IBM, PC/AT, PS/2, and VGA are trademarks of International Business Machines Corporation.

All other product names or trademarks are properties of their respective owners. No ownership is implied or assumed for products, names or trademarks not herein listed by the publisher of this document.

## Packing List

---

Before setting up your product, please make sure the following items have been shipped:

Item	Quantity
● EPIC-ADS7-PUC	1
● SATA Cable	2
● SATA Power Cable	2
● Screw Pack, Thermal Pads and Accessories Kit	1
● CPU Cooler Backplate	2

Please note that the packing list may be different based on SKU. contact your distributor or sales representative if you have any queries.

If any of these items are missing or damaged, please contact your distributor or sales representative immediately.

## About this Document

---

This User's Manual contains all the essential information, such as detailed descriptions and explanations on the product's hardware and software features (if any), its specifications, dimensions, jumper/connector settings/definitions, and driver installation instructions (if any), to facilitate users in setting up their product.

Users may refer to the product page on [AAEON.com](http://AAEON.com) for the latest version of this document.

## Safety Precautions

---

Please read the following safety instructions carefully. It is advised that you keep this manual for future references

1. All cautions and warnings on the device should be noted.
2. Make sure the power source matches the power rating of the device.
3. Position the power cord so that people cannot step on it. Do not place anything over the power cord.
4. Always completely disconnect the power before working on the system's hardware.
5. No connections should be made when the system is powered as a sudden rush of power may damage sensitive electronic components.
6. If the device is not to be used for a long time, disconnect it from the power supply to avoid damage by transient over-voltage.
7. Always disconnect this device from any AC supply before cleaning.
8. While cleaning, use a damp cloth instead of liquid or spray detergents.
9. Make sure the device is installed near a power outlet and is easily accessible.
10. Keep this device away from humidity.
11. Place the device on a solid surface during installation to prevent falls
12. Do not cover the openings on the device to ensure optimal heat dissipation.
13. Watch out for high temperatures when the system is running.
14. Do not touch the heat sink or heat spreader when the system is running
15. Never pour any liquid into the openings. This could cause fire or electric shock.
16. As most electronic components are sensitive to static electrical charge, be sure to ground yourself to prevent static charge when installing the internal components. Use a grounding wrist strap and contain all electronic components in any static-shielded containers.

17. If any of the following situations arises, please the contact our service personnel:
  - i. Damaged power cord or plug
  - ii. Liquid intrusion to the device
  - iii. Exposure to moisture
  - iv. Device is not working as expected or in a manner as described in this manual
  - v. The device is dropped or damaged
  - vi. Any obvious signs of damage displayed on the device
18. **DO NOT LEAVE THIS DEVICE IN AN UNCONTROLLED ENVIRONMENT WITH TEMPERATURES BEYOND THE DEVICE'S PERMITTED STORAGE TEMPERATURES (SEE CHAPTER 1) TO PREVENT DAMAGE.**

### **Warning!**



This device complies with Part 15 FCC Rules. Operation is subject to the following two conditions: (1) this device may not cause harmful interference, and (2) this device must accept any interference received including interference that may cause undesired operation.

### **Caution:**

*There is a danger of explosion if the battery is incorrectly replaced. Replace only with the same or equivalent type recommended by the manufacturer. Dispose of used batteries according to the manufacturer's instructions and your local government's recycling or disposal directives.*

### **Attention:**

*Il y a un risque d'explosion si la batterie est remplacée de façon incorrecte. Ne la remplacer qu'avec le même modèle ou équivalent recommandé par le constructeur. Recycler les batteries usées en accord avec les instructions du fabricant et les directives gouvernementales de recyclage.*



## 产品中有毒有害物质或元素名称及含量

AAEON System

QO4-381 Rev.A0

部件名称	有毒有害物质或元素					
	铅 (Pb)	汞 (Hg)	镉 (Cd)	六价铬 (Cr(VI))	多溴联苯 (PBB)	多溴二苯 醚(PBDE)
印刷电路板及其电子组件	×	○	○	○	○	○
外部信号连接器及线材	×	○	○	○	○	○
外壳	○	○	○	○	○	○
中央处理器与内存	×	○	○	○	○	○
硬盘	×	○	○	○	○	○
液晶模块	×	○	○	○	○	○
光驱	×	○	○	○	○	○
触控模块	×	○	○	○	○	○
电源	×	○	○	○	○	○
电池	×	○	○	○	○	○

本表格依据 SJ/T 11364 的规定编制。

○：表示该有毒有害物质在该部件所有均质材料中的含量均在 GB/T 26572 标准规定的限量要求以下。

×：表示该有害物质的某一均质材料超出了 GB/T 26572 的限量要求，然而该部件

仍符合欧盟指令 2011/65/EU 的规范。

备注：

- 一、此产品所标示之环保使用期限，系指在一般正常使用状况下。
- 二、上述部件物质中央处理器、内存、硬盘、光驱、电源为选购品。
- 三、上述部件物质液晶模块、触控模块仅一体机产品适用。

**Hazardous and Toxic Materials List**

**AAEON System**

**QO4-381 Rev.A0**

Component Name	Hazardous or Toxic Materials or Elements					
	Lead (Pb)	Mercury (Hg)	Cadmium (Cd)	Hexavalent Chromium (Cr(VI))	Polybrominated biphenyls (PBBs)	Polybrominated diphenyl ethers
PCB and Components	X	O	O	O	O	O
Wires & Connectors for Ext.Connections	X	O	O	O	O	O
Chassis	O	O	O	O	O	O
CPU & RAM	X	O	O	O	O	O
HDD Drive	X	O	O	O	O	O
LCD Module	X	O	O	O	O	O
Optical Drive	X	O	O	O	O	O
Touch Control Module	X	O	O	O	O	O
PSU	X	O	O	O	O	O
Battery	X	O	O	O	O	O

This form is prepared in compliance with the provisions of SJ/T 11364.  
 O: The level of toxic or hazardous materials present in this component and its parts is below the limit specified by GB/T 26572.  
 X: The level of toxic of hazardous materials present in the component exceed the limits specified by GB/T 26572, but is still in compliance with EU Directive 2011/65/EU (RoHS 2).  
**Notes:**  
 1. The Environment Friendly Use Period indicated by labelling on this product is applicable only to use under normal conditions.  
 2. Individual components including the CPU, RAM/memory, HDD, optical drive, and PSU are optional.  
 3. LCD Module and Touch Control Module only applies to certain products which feature these components.

# Table of Contents

---

<b>Chapter 1 - Product Specifications</b> .....	<b>1</b>
1.1 Specifications .....	2
1.2 HSIO Function Table.....	4
1.3 Block Diagram .....	5
<b>Chapter 2 – Hardware Information</b> .....	<b>6</b>
2.1 Dimensions .....	7
2.2 Jumpers and Connectors.....	8
2.3 (A) EPIC-ADS7 Main Board List of Jumpers .....	10
2.3.1 Clear CMOS Jumper (JP1).....	10
2.3.2 Auto Power Button AT/ATX Selection (JP2).....	10
2.3.3 COM 2 Pin 8 Function Selection (JP4) .....	11
2.3.4 Front Panel Connector (JP6) .....	11
2.4 (B) Dual LAN Card.....	12
2.4.1 OUT2 Select (JP1).....	12
2.4.2 AGND2 Select (JP2).....	12
2.4.3 AGND1 Select (JP3) .....	12
2.4.4 OUT1 Select (JP1) .....	12
2.5 (A) EPIC-ADS7 Main Board List of Connectors .....	13
2.5.1 RTC Connector (CN1).....	15
2.5.2 SATA Connector (CN2/CN3) .....	15
2.5.3 4-Pin DC-In ATX Connector (CN4).....	16
2.5.4 SATA Power Connector (CN6).....	16
2.5.5 External +5VSB Input Connector (CN7) .....	17
2.5.6 CPU Fan Connector (CN8).....	17
2.5.7 USB 2.0 Connector (Port 5/6) (CN13).....	18
2.5.8 COM Port 1/2 (CN14).....	19

2.5.9	COM Port 3/4 (CN15) .....	21
2.5.10	LAN Port I219LM + USB 3.2 Gen 2 Connector (CN17) .....	23
2.5.11	LAN Port I225LM + USB 3.2 Gen 2 Connector (CN18) .....	24
2.5.12	HDMI Connector (CN19) .....	25
2.5.13	Digital I/O Port (CN20) .....	26
2.5.14	USB 3.2 Gen 2 Connector (CN21) .....	26
2.5.15	DP++1/DP++2 Connector (CN22) .....	27
2.5.16	Vcore Programing Connector (CN24) .....	29
2.5.17	USB 3.2 Gen 2 Connector (Type-C) (CN25) .....	30
2.5.18	eSPI Connector for Debug (CN26) .....	32
2.5.19	SPI BIOS Debug Port (CN27) .....	33
2.5.20	M.2 2230 E-Key (CN28) .....	33
2.5.21	Nano SIM Card Socket (CN29) .....	34
2.5.22	M.2 3052 B-Key (CN30) .....	34
2.5.23	PCIe [x2] FPC Connector (CN31) .....	35
2.5.24	M.2 2280 M-Key (CN32) .....	36
2.5.25	TCC (CN33) .....	37
2.5.26	SATA Power Connector (CN34) .....	37
2.5.27	CPU Socket (CPU1) .....	38
2.5.28	DDR5 SODIMM Slot (DIMM1) .....	38
2.5.29	DDR5 SODIMM Slot (DIMM2) .....	38
2.6	(B) Dual LAN Card List of Connectors .....	39
2.6.1	12V DC In (CN1) .....	39
2.6.2	RJ-45 LAN Port (CN2/CN3) .....	40
2.6.3	FPC Cable Port (CN4) .....	41
<b>Chapter 3 - AMI BIOS Setup .....</b>		<b>43</b>
3.1	System Test and Initialization .....	44
3.2	AMI BIOS Setup .....	45

3.3	Setup Submenu: Main.....	46
3.4	Setup Submenu: Advanced.....	47
3.4.1	CPU Configuration.....	48
3.4.2	PCH-FW Configuration.....	49
3.4.3	Firmware Update Configuration.....	50
3.4.4	PTT Configuration.....	51
3.4.5	Trusted Computing.....	52
3.4.6	SATA Configuration.....	54
3.4.7	Hardware Monitor.....	55
3.4.8	Smart Fan Mode Configuration.....	56
3.4.9	SIO Configuration.....	57
3.4.9.1	Serial Port 1 Configuration.....	58
3.4.9.2	Serial Port 2 Configuration.....	59
3.4.9.3	Serial Port 3 Configuration.....	60
3.4.9.4	Serial Port 4 Configuration.....	61
3.4.10	Serial Port Console Redirection.....	62
3.4.11	Legacy Console Redirection Settings.....	63
3.4.12	AAEON BIOS Robot.....	64
3.4.13	Power Management.....	66
3.4.14	Digital IO Port Configuration.....	67
3.5	Setup Submenu: Chipset.....	68
3.5.1	System Agent (SA) Configuration.....	69
3.5.2	Memory Configuration.....	70
3.5.3	VMD Setup Menu.....	71
3.5.4	LVDS Panel Configuration.....	72
3.5.5	PCH-IO Configuration.....	74
3.6	Setup Submenu: Security.....	75
3.6.1	Secure Boot.....	76

3.6.2	Key Management .....	77
3.7	Setup Submenu: Boot .....	79
3.8	Setup Submenu: Save & Exit.....	80
3.9	Setup Submenu: MEBx.....	81
3.9.1	Intel® AMT Configuration .....	82
3.9.2	Redirection Features .....	83
3.9.3	User Consent.....	84
3.9.4	Power Control .....	85
<b>Chapter 4 – Drivers Installation.....</b>		<b>86</b>
4.1	Drivers Download and Installation.....	87
<b>Appendix A - I/O Information.....</b>		<b>89</b>
A.1	I/O Address Map .....	90
A.2	IRQ Mapping Chart.....	92
A.3	Memory Address Map .....	95
<b>Appendix B – Assembly Guide.....</b>		<b>96</b>
B.1	Introduction .....	97
B.2	CPU Installation.....	97
B.3	DDR5 Module Installation (DIMM2).....	100
B.4	DDR5 Module Installation (DIMM1) .....	102
B.5	M.2 Expansion Module Installation .....	106
B.5.1	M.2 2230 E-Key Installation.....	106
B.5.2	M.2 2280 M-Key Installation .....	107
B.6	CPU Fan Installation .....	109
B.7	SSD Installation .....	111

# Chapter 1

---

Product Specifications

## 1.1 Specifications

---

### System

Form Factor	EPIC System
CPU	12 <sup>th</sup> Generation Intel® Core™ Series Processor, up to 65W
CPU Frequency	Up to 4.8GHz (Intel® Core™ i7-12700E)
Chipset	Intel® 600 Series Desktop Chipset (R680E/Q670E/H610E)
Memory Type	DDR5 4800MHz SODIMM x 2
Max. Memory Capacity	Up to 32GB (16GB SODIMM x 2)
BIOS	UEFI
Wake on LAN	Yes (I219LM + I225LM RJ-45 support only)
Watchdog Timer	255 Levels
Power Requirement	+12V DC in
Power Supply Type	AT/ATX
Power Consumption (Typical)	With i7-12700E CPU + R680E Chipset Peak: +12V @18.15A, 217.8W during 100% loading test Steady: +12V @11.15A, 133.8W
Dimension (L X W)	10.2" x 6.3" x 2.1" (260mm x 160mm x 55mm)
Operating Temperature	32°F ~ 122°F (0°C ~ 50°C) with 0.5 m/s airflow
Storage Temperature	-40°F ~ 176°F (-40°C ~ 80°C)
Operating Humidity	0% ~ 90% relative humidity, non-condensing
MTBF	380,264
Certification	CE/FCC Class A, LVD



## Display

<b>VGA/LCD Controller</b>	Intel® UHD Graphics 770/Intel® UHD Graphics 730 (by CPU SKU)
<b>Video Output</b>	3 Simultaneous Displays DP 1.4a x 2 HDMI 2.1 x 1 (up to 3840 x 2160)
<b>Backlight Inverter Supply</b>	—

## I/O

<b>Ethernet</b>	Intel® I211AT, 10/100/1000Base, RJ-45 x 2 (No PXE & active LED function support) Intel® I219LM, 10/100/1000Base, RJ-45 x 1 Intel® I225LM, 10/100/2500Base, RJ-45 x 1
<b>Audio</b>	—
<b>USB Port</b>	USB 3.2 Gen 2 x 2 (Type-C x 1, supported by SKU) USB 3.2 Gen 2 x 4 (Type-A x 4, supported by SKU) USB 2.0 x 2 (Type-A)
<b>Serial Port</b>	COM RS-232/422/485 x 2
<b>SSD</b>	SATA III x 2 with +5V SATA Onboard Power Connector
<b>Expansion</b>	M.2 3052 B-Key x 1 (PCIe 3.0 [x1] + USB 3.0 or PCIe [x2] Only) M.2 2280 M-Key x 1 (PCIe 4.0 [x4]) M.2 2230 E-Key x 1 (PCIe 3.0 [x1] + USB 2.0) 3-pin TCC x 1 (supported by SKU)
<b>DIO</b>	DIO 8-bit x 1
<b>TPM</b>	TPM 2.0 (Optional)
<b>SIM</b>	Nano SIM Slot x 1 (Supported by SKU)

**Attention:**

Please follow the environmental condition as below if using EPIC-ADS7-PUC with power adapter together. (Model: 1255X00063 // Delta DPS-150AB)

<b>EUT Rating</b>	12VDC,12.5A
<b>Operating Temperature</b>	32°F ~ 104°F (0°C ~ 40°C) with 0.5 m/s airflow
<b>Storage Temperature</b>	-40°F ~ 176°F (-40°C ~ 80°C)
<b>Operating Humidity</b>	20% ~ 80% relative humidity, non-condensing
<b>Shipping Humidity</b>	10% ~ 90% relative humidity, non-condensing
<b>Altitude</b>	0-5000 meters

## 1.2 HSIO Function Table

PCH SKU	R680E SKU	Q670E SKU	H610E SKU
SATA III	Yes (2 ports)	Yes (2 ports)	Yes (2 ports)
USB 3.2 Gen 2 x 2 (Type-C)	Yes	Yes	No
USB 3.2 (Type-A)	Yes (4 ports, up to USB 3.2 Gen 2)	Yes (4 ports, up to USB 3.2 Gen 2)	Yes (4 ports, up to USB 3.2 Gen 1)
M.2 3052 B-Key	Yes (with Nano SIM) (PCIe [x1] + USB 3.0)	Yes (with Nano SIM) (PCIe [x1] +USB 3.0)	Yes (w/o Nano SIM) (PCIe [x2])
M.2 2280 M-Key	Yes	Yes	No
M.2 2230 E-Key	Yes	Yes	Yes
Ethernet (RJ-45)	I225LM x 1 (2.5GbE) I219LM x 1 (GbE) I211AT x 2 (GbE)	I225LM x 1 (2.5GbE) I219LM x 1 (GbE) I211AT x 2 (GbE)	I225LM x 1 (2.5GbE) I219LM x 1 (GbE) I211AT x 2 (GbE)
TCC	Yes	No	No

### 1.3 Block Diagram

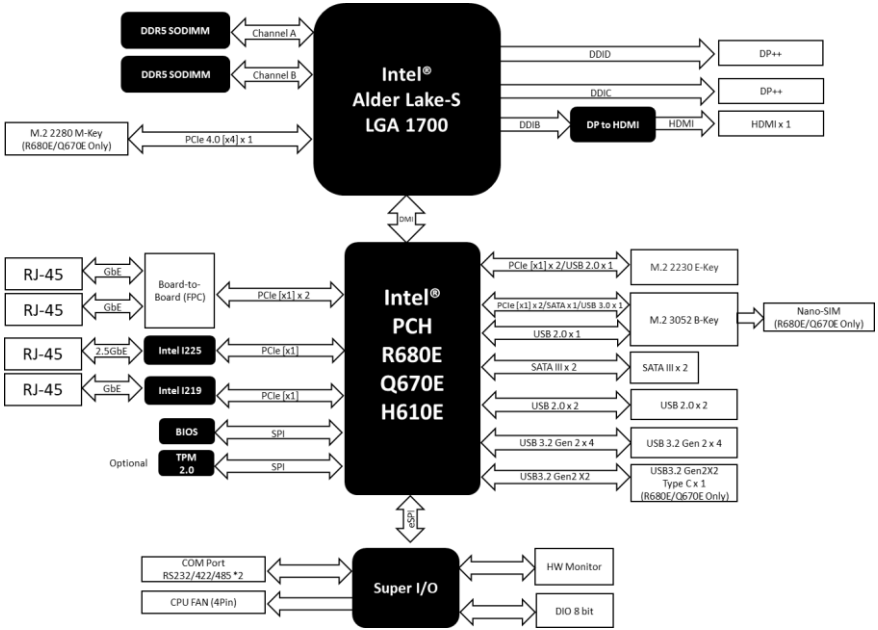

# Chapter 2

---

Hardware Information

## 2.1 Dimensions

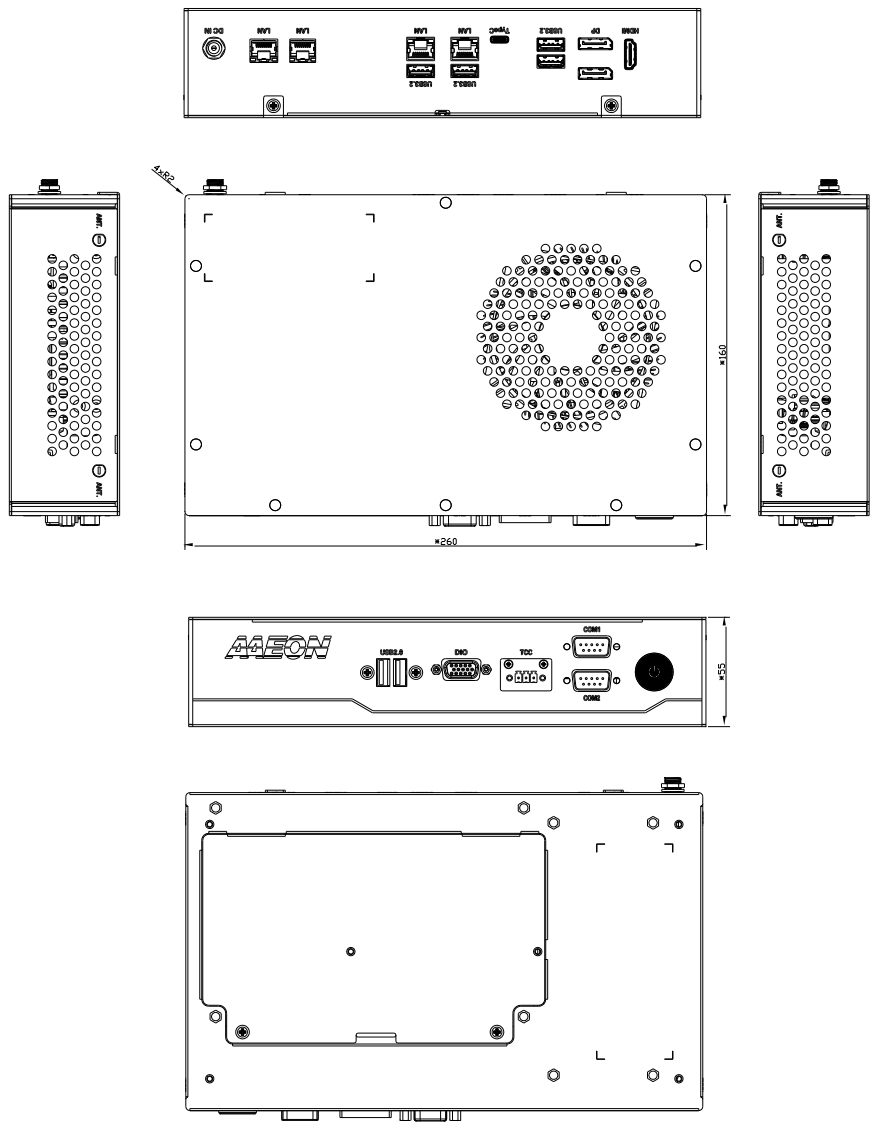

## 2.2 Jumpers and Connectors

### EPIC-ADS7 Main Board

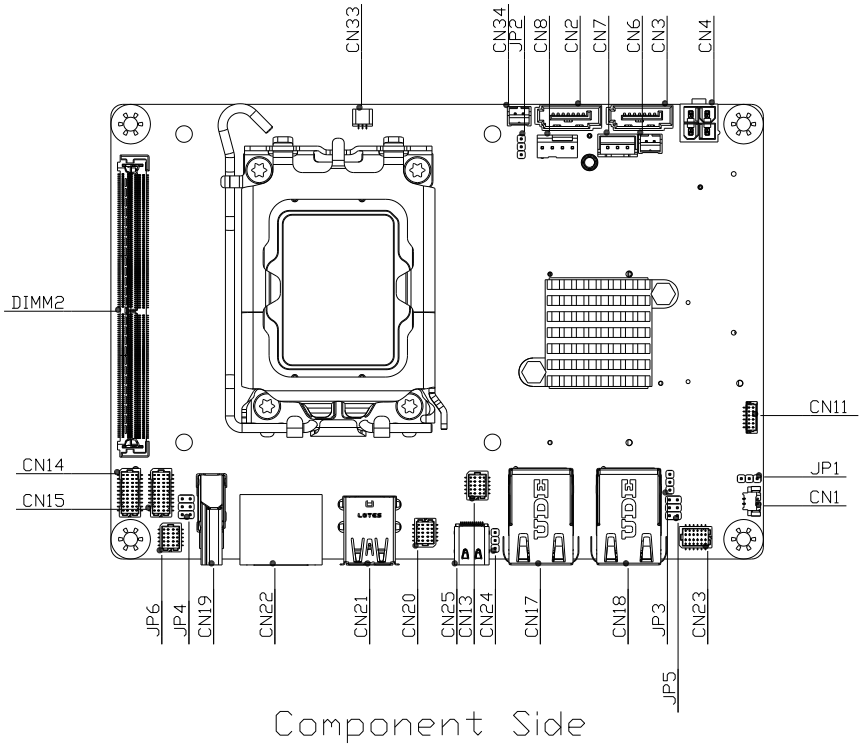

### Dual LAN Card:

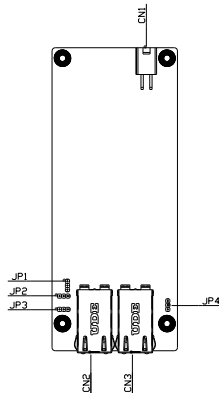

### EPIC-ADST7 Main Board

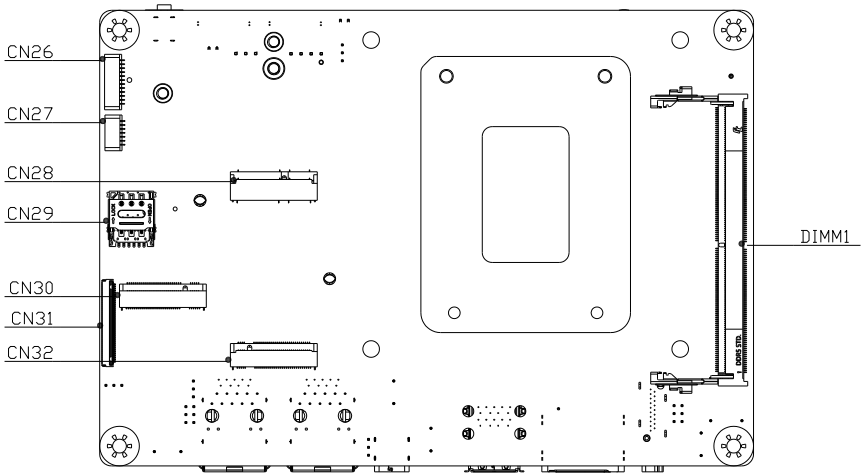

### Solder Side

#### Dual LAN Card:

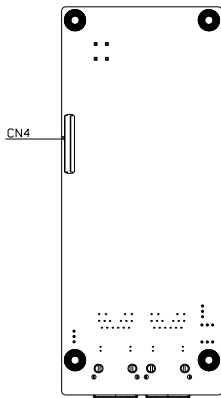

### 2.3 (A) EPIC-ADS7 Main Board List of Jumpers

The board features a number of jumpers which can be configured for your application. Please refer to the table below and following sections for all jumpers which can be configured.

Label	Function
JP1	Clear CMOS Jumper
JP2	Auto Power Button AT/ATX Selection
JP4	COM 2 Pin 8 Function Selection
JP6	Front Panel Connector

#### 2.3.1 Clear CMOS Jumper (JP1)



#### 2.3.2 Auto Power Button AT/ATX Selection (JP2)





### 2.3.3 COM 2 Pin 8 Function Selection (JP4)

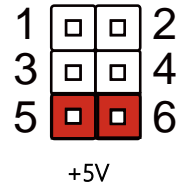
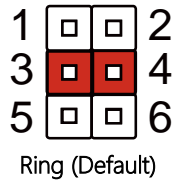
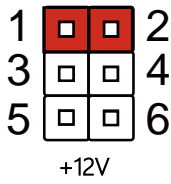

### 2.3.4 Front Panel Connector (JP6)

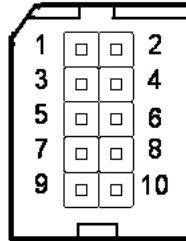

Pin	Signal	Pin	Signal
1	GND	2	EXT_PWRBTN#
3	FP_HDLED-	4	FP_HDLED+
5	FP_SPKR-	6	+V5S
7	GND	8	PWRLED+
9	GND	10	HWRST#

## 2.4 (B) Dual LAN Card

Label	Function
JP1	OUT2 Select
JP2	AGND2 Select
JP3	AGND1 Select
JP4	OUT1 Select

### 2.4.1 OUT2 Select (JP1)

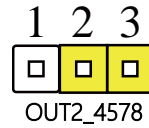
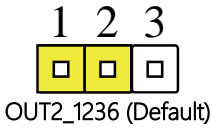

### 2.4.2 AGND2 Select (JP2)

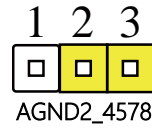
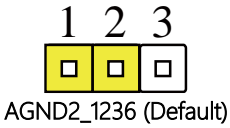

### 2.4.3 AGND1 Select (JP3)

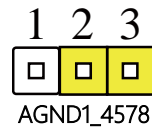
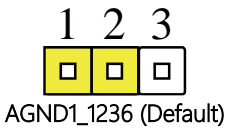

### 2.4.4 OUT1 Select (JP4)

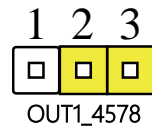
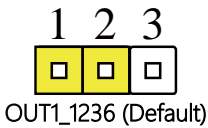

## 2.5 (A) EPIC-ADS7 Main Board List of Connectors

The EPIC-ADS7 main board has a number of connectors that allow you to configure your system to suit your application.

The table below shows the function of each of the board's connectors

Label	Function
CN1	RTC Connector
CN2	SATA Connector
CN3	SATA Connector
CN4	4-Pin DC-In ATX Connector
CN6	SATA Power Connector
CN7	External +5VSB Input Connector
CN8	CPU Fan Connector
CN13	USB 2.0 Connector
CN14	RS-232/422/485 Connector COM ½
CN15	RS-232/422/485 Connector COM ¾
CN17	LAN Port I219LM + USB 3.2 Gen 2 Connector
CN18	LAN Port I225LM + USB 3.2 Gen 2 Connector
CN19	HDMI Connector
CN20	Digital I/O Port
CN21	USB 3.2 Gen 2 Connector
CN22	DP++ 1/2 Connector
CN24	Vcore Programming Connector
CN25	USB 3.2 Gen 2 Connector (Type-C)
CN26	eSPI Connector for Debug
CN27	SPI BIOS Debug Port
CN28	M.2 2230 E-Key

Label	Function
CN29	Nano SIM Card Socket
CN30	M.2 3052 B-Key
CN31	PCIe [x2] FPC Connector
CN32	M.2 2280 M-Key
CN33	TCC
CN34	SATA Power Connector
CPU1	CPU Socket
DIMM1	DDR5 SODIMM Slot
DIMM2	DDR5 SODIMM Slot

### 2.5.1 RTC Connector (CN1)

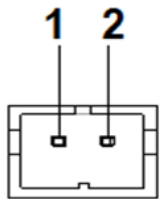

Pin	Pin Name	Signal Type	Signal Level
1	+3.3V	PWR	+3.3V
2	GND	GND	-

### 2.5.2 SATA Connector (CN2/CN3)

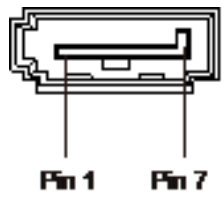

Pin	Pin Name	Signal Type
1	GND	GND
2	SATA_TX+	DIFF
3	SATA_TX-	DIFF
4	GND	GND
5	SATA_RX-	DIFF
6	SATA_RX+	DIFF
7	GND	GND

### 2.5.3 4-Pin DC-In ATX Connector (CN4)

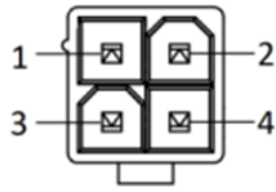

Pin	Pin Name	Signal Type	Signal Level
1	GND	GND	-
2	GND	GND	-
3	+VIN	PWR	+12V
4	+VIN	PWR	+12V

**Note:** 12V only.

### 2.5.4 SATA Power Connector (CN6)

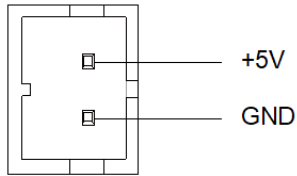

Pin	Pin Name	Signal Type	Signal Level
1	+5V	PWR	+5V (2A)
2	GND	GND	-

**Note:** CN6 offers a 2A current for SATA connector.

### 2.5.5 External +5VSB Input Connector (CN7)

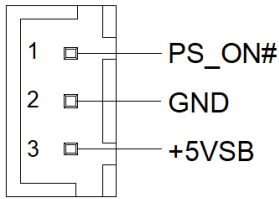

Pin	Pin Name	Signal Type	Signal Level
1	PS_ON#	OUT	+5V
2	GND	GND	-
3	+5VSB	PWR	+5V (2A)

### 2.5.6 CPU Fan Connector (CN8)

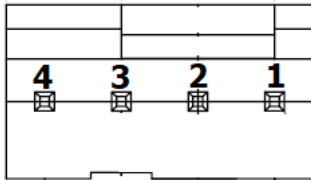

Pin	Pin Name	Signal Type	Signal Level
1	GND	GND	-
2	FAN_POWER	PWR	+12V (1A)
3	FAN_TAC	IN	-
4	FAN_CTL	OUT	-

### 2.5.7 USB 2.0 Connector (Port 5/6) (CN13)

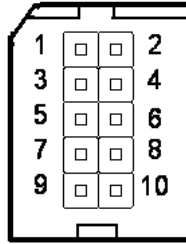

Pin	Pin Name	Pin	Signal Level
1	+5VSB (0.5A)	2	+5VSB (0.5A)
3	USB5_D-	4	USB6_D-
5	USB5_D+	6	USB6_D+
7	GND	8	GND
9	GND	10	GND



## 2.5.8 COM Port 1/2 (CN14)

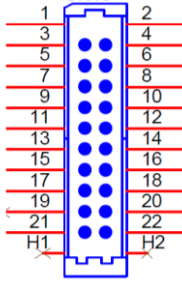

### RS-232

Pin Port 1	Pin Port 2	Pin Name	Signal Type	Signal Level
1	2	DCD	IN	-
3	4	RX	IN	-
5	6	TX	OUT	±5V
7	8	DTR	OUT	±5V
9	10	GND	GND	-
11	12	DSR	IN	-
13	14	RTS	OUT	±5V
15	16	CTS	IN	-
17	18	RI	IN	-
19	20	NC	-	-

### RS-485

Pin Port 1	Pin Port 2	Pin Name	Signal Type	Signal Level
1	2	RS485_ D-	I/O	±5V
3	4	RS485_ D+	I/O	±5V
5	6	NC	-	-
7	8	NC	-	-

RS-485				
Pin Port 1	Pin Port 2	Pin Name	Signal Type	Signal Level
9	10	GND	GND	-
11	12	NC	-	-
13	14	NC	-	-
15	16	NC	-	-
17	18	RI/+5V/+12V (0.5A)	PWR	+5V/+12V
19	20	NC	-	-

RS-422				
Pin Port 1	Pin Port 2	Pin Name	Signal Type	Signal Level
1	2	RS422_TX-	OUT	±5V
3	4	RS422_TX+	OUT	±5V
5	6	RS422_RX+	IN	-
7	8	RS422_RX-	IN	-
9	10	GND	GND	-
11	12	NC	-	-
13	14	NC	-	-
15	16	NC	-	-
17	18	RI/+5V/+12V (0.5A)	PWR	+5V/+12V
19	20	NC	-	-

**Note:** COM 2 RS-232/422/485 can be set by BIOS setting. Default is RS-232.

**Note:** Pin 17 RI only, Pin 18 function can be select by JP4.

## 2.5.9 COM Port 3/4 (CN15)

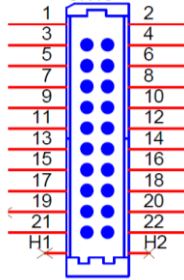

### RS-232

Pin Port 1	Pin Port 2	Pin Name	Signal Type	Signal Level
1	2	DCD	IN	-
3	4	RX	IN	-
5	6	TX	OUT	±5V
7	8	DTR	OUT	±5V
9	10	GND	GND	-
11	12	DSR	IN	-
13	14	RTS	OUT	±5V
15	16	CTS	IN	-
17	18	RI	IN	-
19	20	NC	-	-

### RS-485

Pin Port 1	Pin Port 2	Pin Name	Signal Type	Signal Level
1	2	RS485_ D-	I/O	±5V
3	4	RS485_ D+	I/O	±5V
5	6	NC	-	-
7	8	NC	-	-

## RS-485

Pin Port 1	Pin Port 2	Pin Name	Signal Type	Signal Level
9	10	GND	GND	-
11	12	NC	-	-
13	14	NC	-	-
15	16	NC	-	-
17	18	RI	IN	-
19	20	NC	-	-

## RS-422

Pin Port 1	Pin Port 2	Pin Name	Signal Type	Signal Level
1	2	RS422_TX-	OUT	±5V
3	4	RS422_TX+	OUT	±5V
5	6	RS422_RX+	IN	-
7	8	RS422_RX-	IN	-
9	10	GND	GND	-
11	12	NC	-	-
13	14	NC	-	-
15	16	NC	-	-
17	18	RI	IN	-
19	20	NC	-	-

## 2.5.10 LAN Port I219LM + USB 3.2 Gen 2 Connector (CN17)

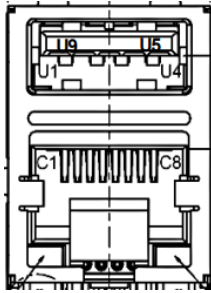

Pin	Pin Name	Signal Type	Signal Level
U1	+5VSB	PWR	5V (0.9A)
U2	USB2_1_DN	DIFF	-
U3	USB2_1_DP	DIFF	-
U4	GND	GND	GND
U5	USB3_1_RXN	DIFF	-
U6	USB3_1_RXP	DIFF	-
U7	GND	GND	GND
U8	USB3_1_TXN	DIFF	-
U9	USB3_1_TXP	DIFF	-
R2	LAN1_MDI0_P	DIFF	-
R3	LAN1_MDI0_N	DIFF	-
R4	LAN1_MDI1_P	DIFF	-
R5	LAN1_MDI1_N	DIFF	-
R6	LAN1_MDI2_P	DIFF	-
R7	LAN1_MDI2_N	DIFF	-
R8	LAN1_MDI3_P	DIFF	-
R9	LAN1_MDI3_N	DIFF	-

## 2.5.11 LAN Port I225LM + USB 3.2 Gen 2 Connector (CN18)

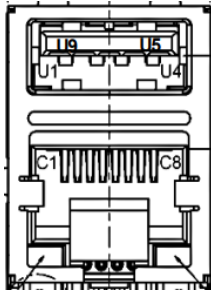

Pin	Pin Name	Signal Type	Signal Level
U1	+5VSB	PWR	5V (0.9A)
U2	USB2_2_DN	DIFF	-
U3	USB2_2_DP	DIFF	-
U4	GND	GND	GND
U5	USB3_2_RXN	DIFF	-
U6	USB3_2_RXP	DIFF	-
U7	GND	GND	GND
U8	USB3_2_TXN	DIFF	-
U9	USB3_2_TXP	DIFF	-
R2	LAN2_MDI0_P	DIFF	-
R3	LAN2_MDI0_N	DIFF	-
R4	LAN2_MDI1_P	DIFF	-
R5	LAN2_MDI1_N	DIFF	-
R6	LAN2_MDI2_P	DIFF	-
R7	LAN2_MDI2_N	DIFF	-
R8	LAN2_MDI3_P	DIFF	-
R9	LAN2_MDI3_N	DIFF	-

## 2.5.12 HDMI Connector (CN19)

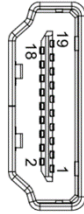

Pin	Pin Name	Signal Type	Signal Level
1	HDMI_TX2+	DIFF	-
2	GND	GND	-
3	HDMI_TX2-	DIFF	-
4	HDMI_TX1+	DIFF	-
5	GND	GND	-
6	HDMI_TX1-	DIFF	-
7	HDMI_TX0+	DIFF	-
8	GND	GND	-
9	HDMI_TX0-	DIFF	-
10	HDMI_CLK+	DIFF	-
11	GND	GND	-
12	HDMI_CLK-	DIFF	-
13	NC	-	-
14	NC	-	-
15	DDC_CLK	I/O	+5V
16	DDC_DATA	I/O	+5V
17	GND	GND	-
18	+5V	PWR	+5V
19	HDMI_HPD	-	-

### 2.5.13 Digital I/O Port (CN20)

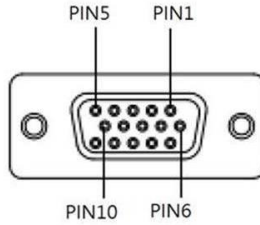

Pin	Signal	Pin	Signal
1	PD0	2	PD1
3	PD2	4	PD3
5	PD4	6	PD5
7	PD6	8	PD7
9	+V5S (0.5A)	10	GND

### 2.5.14 USB 3.2 Gen 2 Connector (CN21)

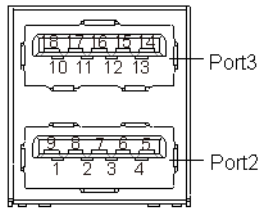

Pin	Pin Name	Signal Type	Signal Level
1	+5VSB	PWR	+5V (0.9A)
2	USB2_3D-	DIFF	-
3	USB2_3D+	DIFF	-
4	GND	GND	-
5	USB3_3_SSRX-	DIFF	-



Pin	Pin Name	Signal Type	Signal Level
6	USB3_3_SSRX+	DIFF	-
7	GND	GND	-
8	USB3_3_SSTX-	DIFF	-
9	USB3_3_SSTX+	DIFF	-
10	+5VSB	PWR	+5V (0.9A)
11	USB2_4_D-	DIFF	-
12	USB2_4_D+	DIFF	-
13	GND	GND	-
14	USB3_4_SSRX-	DIFF	-
15	USB3_4_SSRX+	DIFF	-
16	GND	GND	-
17	USB3_4_SSTX-	DIFF	-
18	USB3_4_SSTX+	DIFF	-

### 2.5.15 DP++1/DP++2 Connector (CN22)

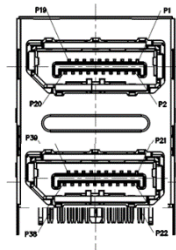

Pin	Pin Name	Signal Type	Signal Level
1	DP1_TX0_DP	DIFF	-
2	GND	GND	-
3	DP1_TX0_DN	DIFF	-

Pin	Pin Name	Signal Type	Signal Level
4	DP1_TX1_DP	DIFF	-
5	GND	GND	-
6	DP1_TX1_DN	DIFF	-
7	DP1_TX2_DP	DIFF	-
8	GND	GND	-
9	DP1_TX2_DN	DIFF	-
10	DP1_TX3_DP	DIFF	-
11	GND	GND	-
12	DP1_TX3_DN	DIFF	-
13	DDC_AUX_EN	H(HDMI/L(DP)	-
14	GND	GND	-
15	DP1_AUX_DP	I/O	-
16	GND	GND	-
17	DP1_AUX_DN	I/O	-
18	HDMI_HPD	I/O	-
19	GND	GND	-
20	+V3P3S	PWR	+3.3V
21	DP1_TX0_DP	DIFF	-
22	GND	GND	-
23	DP1_TX0_DN	DIFF	-
24	DP1_TX1_DP	DIFF	-
25	GND	GND	-
26	DP1_TX1_DN	DIFF	-
27	DP1_TX2_DP	DIFF	-
28	GND	GND	-
29	DP1_TX2_DN	DIFF	-

Pin	Pin Name	Signal Type	Signal Level
30	DP1_TX3_DP	DIFF	-
31	GND	GND	-
32	DP1_TX3_DN	DIFF	-
33	DDC_AUX_EN	H(HDMI/L(DP)	-
34	GND	GND	-
35	DP1_AUX_DP	I/O	-
36	GND	GND	-
37	DP1_AUX_DN	I/O	-
38	HDMI_HPD	I/O	-
39	GND	GND	-
40	+V3P3S	PWR	+3.3V

### 2.5.16 Vcore Programing Connector (CN24)

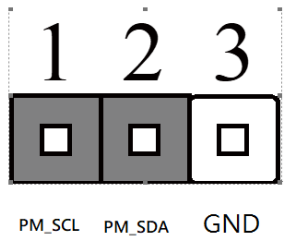

Pin	Pin Name	Signal Type	Signal Level
1	PM_SCL	IN/OUT	3.3V
2	PM_SDA	IN/OUT	3.3V
3	GND	GND	-

## 2.5.17 USB 3.2 Gen 2 Connector (Type-C) (CN25)

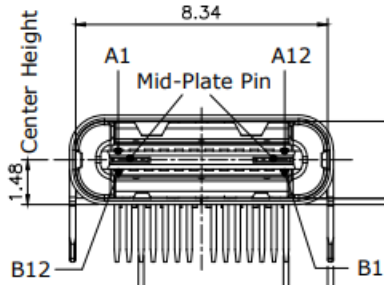

Pin	Pin Name	Signal Type	Signal Level
A1	GND	GND	GND
A2	SSTXP1	DIFF	-
A3	SSTXN1	DIFF	-
A4	+5VSB	PWR	+5V
A5	CON_CC1	IN	-
A6	USB_P0_DP_C	DIFF	-
A7	USB_P0_DN_C	DIFF	-
A8	DP2_AUXP_CON	DIFF	-
A9	+5VSB	PWR	+5V
A10	SSRXN2	DIFF	-
A11	SSRXP2	DIFF	-
A12	GND	GND	GND
B1	GND	GND	GND
B2	SSTXP2	DIFF	-
B3	SSTXN2	DIFF	-
B4	+5VSB	PWR	+5V
B5	CON_CC2	IN	-
B6	USB_P0_DP_C	DIFF	-

Pin	Pin Name	Signal Type	Signal Level
B7	USB_P0_DN_C	DIFF	-
B8	DP2_AUXN_CON	DIFF	-
B9	+5VSB	PWR	+5V
B10	SSRXN1	DIFF	-
B11	SSRXP1	DIFF	-
B12	GND	GND	GND

**Note:** Type-C supports USB 3.2 Gen 2 x 2, +5V current support 3A.

## 2.5.18 eSPI Connector for Debug (CN26)

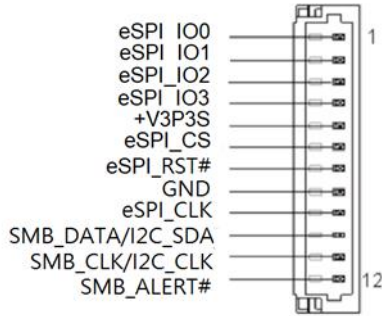

Pin	Pin Name	Signal Type	Signal Level
1	ESPI_IO0	IN/OUT	+1.8V
2	ESPI_IO1	IN/OUT	+1.8V
3	ESPI_IO2	IN/OUT	+1.8V
4	ESPI_IO3	IN/OUT	+1.8V
5	+V3P3S	PWR	+3.3V
6	ESPI_CS	IN	+1.8V
7	ESPI_RST#	OUT	+1.8V
8	GND	GND	GND
9	ESPI_CLK	OUT	-
10	SMB_DATA/ I2C_SDA	IN/OUT	+3.3V
11	SMB_CLK/ I2C_CLK	OUT	+3.3V
12	SMB_ALERT#	IN	+3.3V

### 2.5.19 SPI BIOS Debug Port (CN27)

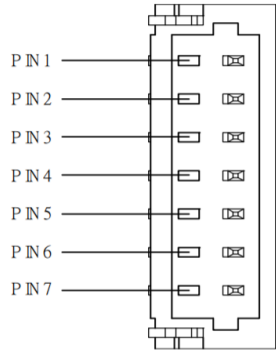

Pin	Pin Name	Signal Type	Signal Level
1	SPI_MISO	OUT	-
2	GND	GND	GND
3	SPI_CLK	IN	-
4	+3.3VSB	PWR	+3.3V
5	SPI_MOSI	IN	-
6	SPI_CS	IN	-
7	NC	-	-

### 2.5.20 M.2 2230 E-Key (CN28)

Standard specification.

## 2.5.21 Nano SIM Card Socket (CN29)

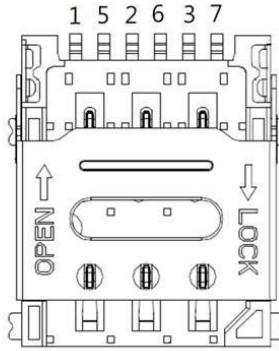

Pin	Pin Name	Signal Type
1	UIM_PWR	PWR
2	UIM_RST	IN
3	UIM_CLK	IN
5	GND	GND
6	UIM_VPP	PWR
7	UIM_DATA	I/O

## 2.5.22 M.2 3052 B-Key (CN30)

Standard specification.



## 2.5.23 PCIe [x2] FPC Connector (CN31)

Pin	Pin Name	Signal Type	Signal Level
1	+V3P3S	PWR	3.3V
2	+V3P3S	PWR	3.3V
3	+V3P3S	PWR	3.3V
4	SMB_DATA	IN/OUT	-
5	SMB_CLK	OUT	-
6	BUF_PLT_RST#	-	-
7	+V3P3A	PWR	3.3V
8	GND	GND	-
9	NC	-	-
10	NC	-	-
11	GND	GND	-
12	PCIE_6_RXP	DIFF	-
13	PCIE_6_RXN	DIFF	-
14	GND	GND	-
15	PCIE_5_RXP	DIFF	-
16	PCIE_5_RXN	DIFF	-
17	GND	GND	-
18	NC	-	-
19	NC	-	-
20	GND	GND	-
21	PCIE_6_TXN	DIFF	-
22	PCIE_6_TXP	DIFF	-
23	GND	GND	-
24	PCIE_5_TXN	DIFF	-

Pin	Pin Name	Signal Type	Signal Level
25	PCIE_5_TXP	DIFF	-
26	GND	GND	-
27	NC	-	-
28	NC	-	-
29	GND	GND	-
30	PCIE_7_CLK_DN	DIFF	-
31	PCIE_7_CLK_DP	DIFF	-
32	GND	GND	-
33	NC	-	-
34	NC	-	-
35	GND	GND	-
36	+V12V	PWR	12V
37	+V12V	PWR	12V
38	+V12V	PWR	12V
39	+V12V	PWR	12V
40	+V12V	PWR	12V

### 2.5.24 M.2 2280 M-Key (CN32)

Standard specification.

### 2.5.25 TCC (CN33)

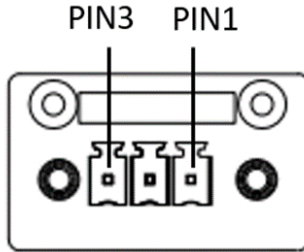

Pin	Pin Name	Signal Type	Signal Level
1	TIME_SYNC0	IN/OUT	3.3V
2	TIME_SYNC1	IN/OUT	3.3V
3	GND	GND	-

### 2.5.26 SATA Power Connector (CN34)

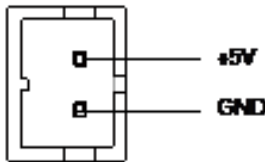

Pin	Pin Name	Signal Type	Signal Level
1	+5V	PWR	+5V(2A)
2	GND	GND	-

**Note:** CN34 offers a 2A current for SATA connector.

### 2.5.27 CPU Socket (CPU1)

---

Standard specification.

### 2.5.28 DDR5 SODIMM Slot (DIMM1)

---

Standard specification (vertical).

### 2.5.29 DDR5 SODIMM Slot (DIMM2)

---

Standard specification.

## 2.6 (B) Dual LAN Card List of Connectors

Label	Function
CN1	12V DC In
CN2	LAN 2 RJ-45 Port
CN3	LAN 1 RJ-45 Port
CN4	FPC Cable Port (Connect to EPIC-CFS7)

### 2.6.1 12V DC In (CN1)

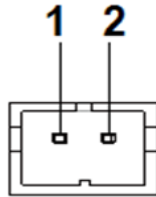

Pin	Pin Name	Signal Type	Signal Level
1	GND	GND	-
2	GND	GND	-
3	+V_IN	PWR	12V
4	+V_IN	PWR	12V

## 2.6.2 RJ-45 LAN Port (CN2/CN3)

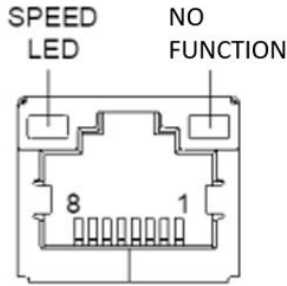

Pin	Pin Name	Signal Type
1	TRP1+	DIFF
2	TRP1-	DIFF
3	TRP2+	DIFF
4	TRP3+	DIFF

Pin	Pin Name	Signal Type
5	TRP3-	DIFF
6	TRP2-	DIFF
7	TRP4+	DIFF
8	TRP4-	DIFF

### 2.6.3 FPC Cable Port (CN4)



Pin	Pin Name	Signal Type	Signal Level
1	+V3P3S	PWR	3.3V
2	+V3P3S	PWR	3.3V
3	+V3P3S	PWR	3.3V
4	SMB_DATA	IN/OUT	-
5	SMB_CLK	OUT	-
6	BUF_PLT_RST#	-	-
7	+V3P3A	PWR	3.3V
8	GND	GND	-
9	NC	-	-
10	NC	-	-
11	GND	GND	-
12	PCIE_6_RXP	DIFF	-
13	PCIE_6_RXN	DIFF	-
14	GND	GND	-
15	PCIE_5_RXP	DIFF	-
16	PCIE_5_RXN	DIFF	-
17	GND	GND	-

Pin	Pin Name	Signal Type	Signal Level
18	NC	-	-
19	NC	-	-
20	GND	GND	-
21	PCIE_6_TXN	DIFF	-
22	PCIE_6_TXP	DIFF	-
23	GND	GND	-
24	PCIE_5_TXN	DIFF	-
25	PCIE_5_TXP	DIFF	-
26	GND	GND	-
27	NC	-	-
28	NC	-	-
29	GND	GND	-
30	PCIE_7_CLK_DN	DIFF	-
31	PCIE_7_CLK_DP	DIFF	-
32	GND	GND	-
33	NC	-	-
34	NC	-	-
35	GND	GND	-
36	+V12V	PWR	12V
37	+V12V	PWR	12V
38	+V12V	PWR	12V
39	+V12V	PWR	12V
40	+V12V	PWR	12V



# Chapter 3

---

AMI BIOS Setup

## 3.1 System Test and Initialization

---

These routines test and initialize board hardware. If the routines encounter an error during the tests, you will either hear a few short beeps or see an error message on the screen. There are two kinds of errors: fatal and non-fatal. The system can usually continue the boot up sequence with non-fatal errors.

### System configuration verification

These routines check the current system configuration stored in the CMOS memory and BIOS NVRAM. If system configuration is not found or system configuration data error is detected, system will load optimized default and re-boot with this default system configuration automatically.

There are four situations in which you will need to setup system configuration:

1. You are starting your system for the first time
2. You have changed the hardware attached to your system
3. The system configuration is reset by Clear-CMOS jumper
4. The CMOS memory has lost power and the configuration information has been erased.

The EPIC-ADS7-PUC memory has an integral lithium battery backup for data retention. However, you will need to replace the complete unit when it finally runs down.

## 3.2 AMI BIOS Setup

---

AMI BIOS ROM has a built-in Setup program that allows users to modify the basic system configuration. This type of information is stored in battery-backed CMOS RAM and BIOS NVRAM so that it retains the Setup information when the power is turned off.

### Entering Setup

Power on the computer and press <Del> or <ESC> immediately. This will allow you to enter Setup.

#### Main

Set the date, use tab to switch between date elements.

#### Advanced

Enable/disable boot option for legacy network devices.

#### Chipset

Host bridge parameters.

#### Boot

Enables/disables quiet boot option.

#### Security

Set setup administrator password.

#### Save & Exit

Exit system setup after saving the changes.

#### MEBx

Set management firmware and Intel ME configuration user interface.

### 3.3 Setup Submenu: Main

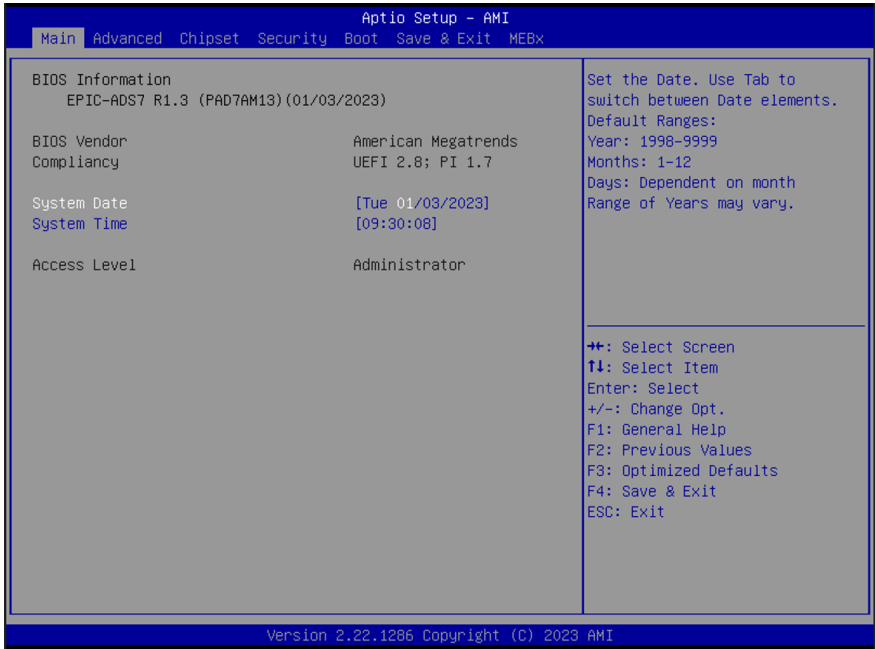

### 3.4 Setup Submenu: Advanced

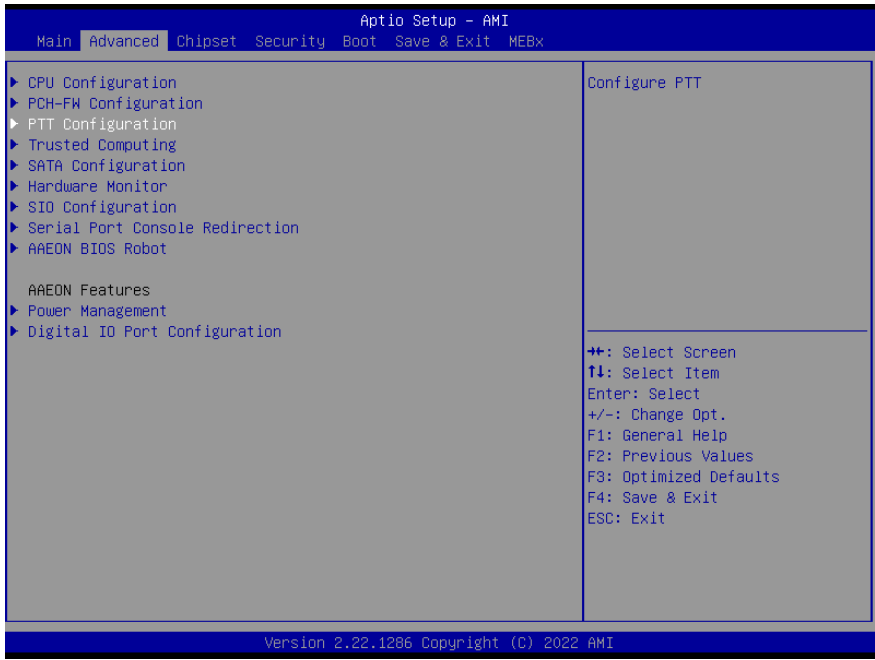

### 3.4.1 CPU Configuration

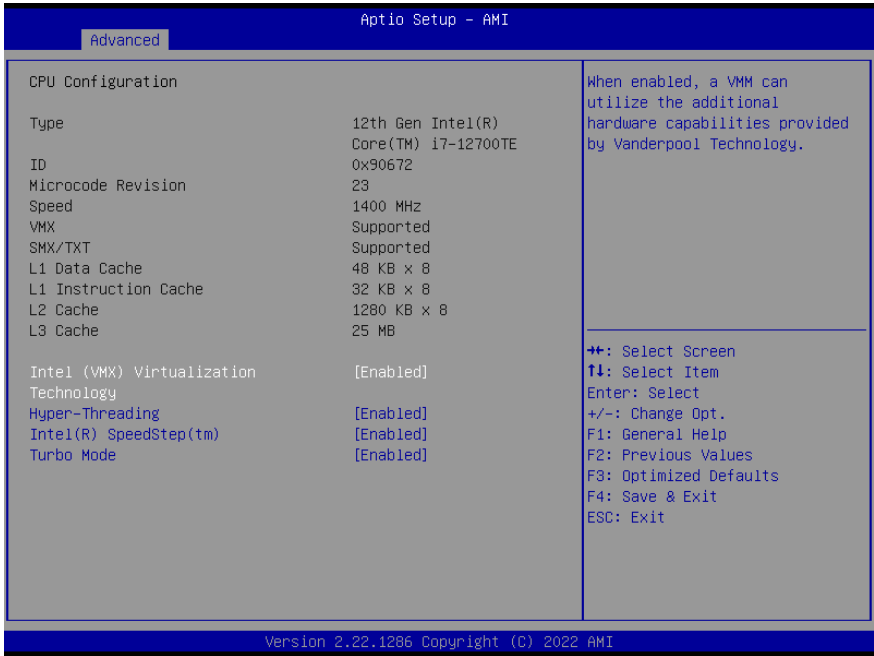

Options Summary		
Intel (VMX) Virtualization Technology	Disabled	
	Enabled	Optimal Default, Failsafe Default
When enabled, a VMM can utilize the additional hardware capabilities provided by Vanderpool Technology.		
Intel(R) SpeedStep(tm)	Disabled	
	Enabled	Optimal Default, Failsafe Default
Allows more than two frequency ranges to be supported.		
Turbo Mode	Disabled	
	Enabled	Optimal Default, Failsafe Default
Enable/Disable processor Turbo Mode (requires EMTTM enabled too). AUTO means enabled.		

## 3.4.2 PCH-FW Configuration

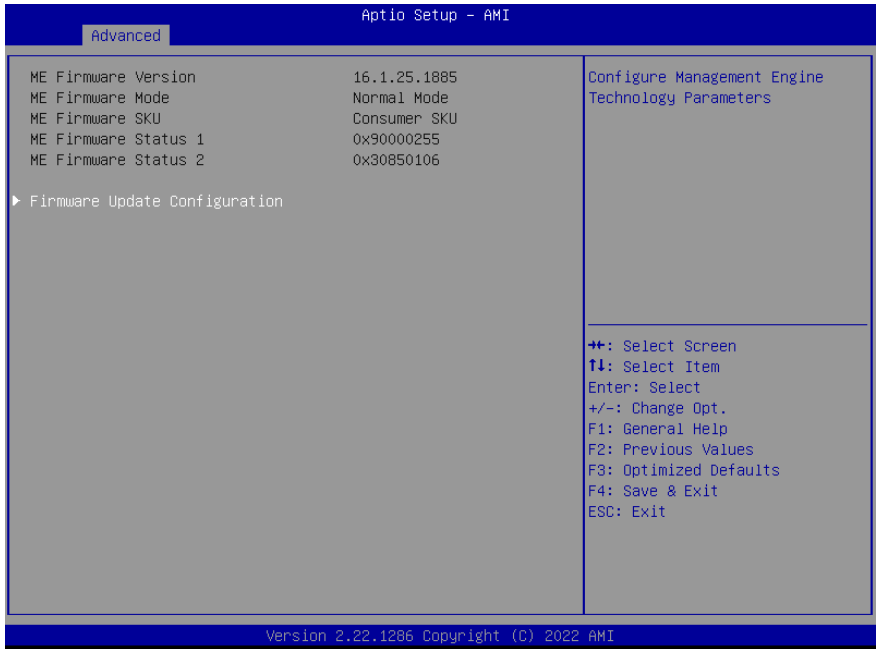

### 3.4.3 Firmware Update Configuration



Options Summary		
Me FW Image Re-Flash	Disabled	Optimal Default, Failsafe Default
	Enabled	
Enable/Disable Me FW Image Re-Flash function.		
FW Update	Disabled	
	Enabled	Optimal Default, Failsafe Default
Enable/Disable ME FW Update function.		



### 3.4.4 PTT Configuration

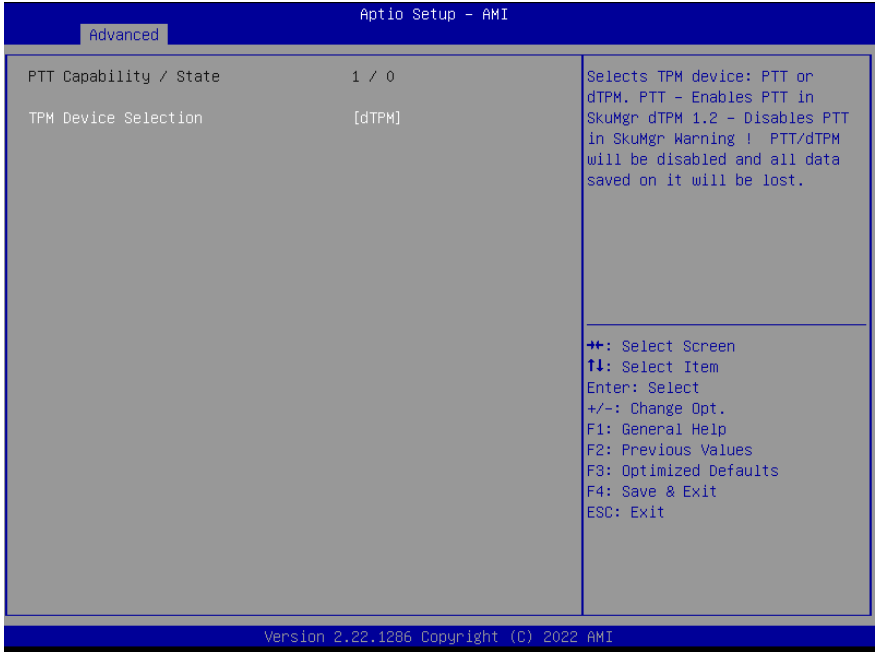

Options Summary		
TPM Device	dTPM	Optimal Default, Failsafe Default
Selection	PTT	
Selects TPM device: PTT or discrete TPM. PTT - enables PTT in SkuMgr dTPM - disables PTT is SkuMgr Warning! PTT TPM will be disabled and all data saved on it will be lost.		

### 3.4.5 Trusted Computing



Options Summary		
Security Device Support	Enable	Optimal Default, Failsafe Default
	Disable	
Enables or Disables BIOS support for security device. O.S. will not show Security Device. TCG EFI protocol and INT1A interface will not be available.		
SHA256 PCR Bank	Enabled	Optimal Default, Failsafe Default
	Disabled	
Enable or Disable SHA256 PCR Bank.		
SHA384 PCR Bank	Enabled	Optimal Default, Failsafe Default
	Disabled	
Enable or Disable SHA384 PCR Bank.		
Pending operation	None	Optimal Default, Failsafe Default
	TPM Clear	
Schedule an Operation for the Security Device. <b>NOTE:</b> Your Computer will reboot during restart in order to change State of Security Device.		

Options Summary		
Platform Hierarchy	Enabled	Optimal Default, Failsafe Default
	Disabled	
Enable or Disable Platform Hierarchy		
Storage Hierarchy	Enabled	Optimal Default, Failsafe Default
	Disabled	
Enable or Disable Storage Hierarchy		
Endorsement Hierarchy	Enabled	Optimal Default, Failsafe Default
	Disabled	
Enable or Disable Endorsement Hierarchy		
Physical Presence Spec Version	1.3	Optimal Default, Failsafe Default
	1.2	
Select to Tell O.S. to support PPI Spec Version 1.2 or 1.3. Note some HCK tests might not support 1.3.		
Device Select	Auto	
	TPM 1.2	
	TPM 2.0	Optimal Default, Failsafe Default
TPM 1.2 will restrict support to TPM 1.2 devices, TPM 2.0 will restrict support to TPM 2.0 devices, Auto will support both with the default set to TPM 2.0 devices if not found, TPM 1.2 devices will be enumerated.		

### 3.4.6 SATA Configuration

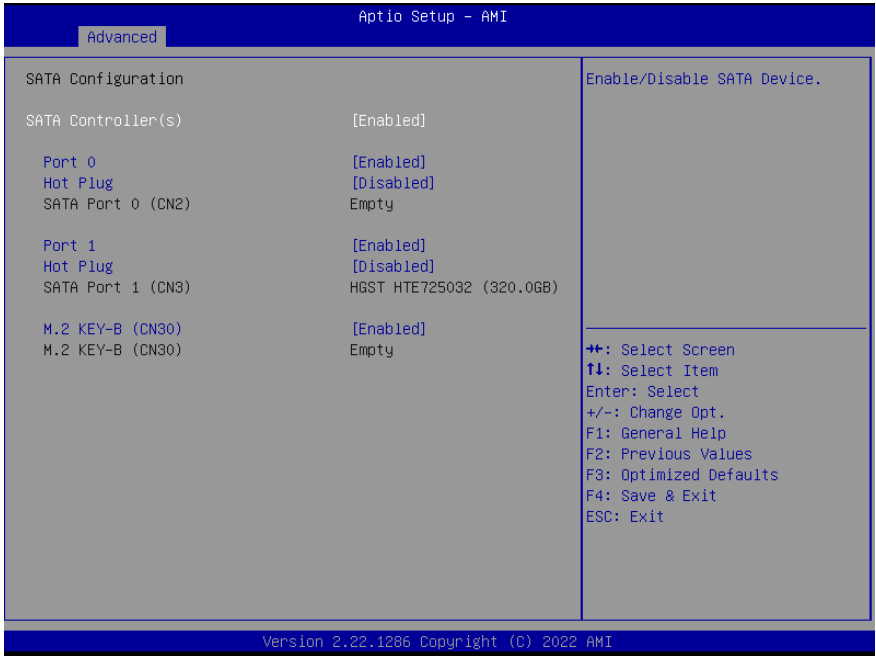

Options Summary		
SATA Controller(s)	Enabled	Optimal Default, Failsafe Default
	Disabled	
Enable/Disable SATA Device.		
Port 0	Enabled	Optimal Default, Failsafe Default
	Disabled	
Enable or Disable SATA Port.		
Hot Plug	Disabled	Optimal Default, Failsafe Default
	Enabled	
Designates this port as Hot Pluggable.		
Port 1	Enabled	Optimal Default, Failsafe Default
	Disabled	
Enable or Disable SATA Port.		
Hot Plug	Disabled	Optimal Default, Failsafe Default
	Enabled	
Designates this port as Hot Pluggable.		

Options Summary		
M.2 KEY-B (CN30)	Enabled	Optimal Default, Failsafe Default
	Disabled	
Enable or Disable SATA Port.		

### 3.4.7 Hardware Monitor

Aptio Setup - AMI

Advanced

<pre> CPU Temperature           : +47 °C System Temperature        : +42 °C System Temperature 2      : +39 °C CPU FAN                   : 2890 RPM VDDRE                     : +0.856 V +12V                      : +11.968 V +5V                       : +5.045 V VMEM                      : +5.003 V +3.3V                    : +3.392 V 3VSB                      : +3.392 V 5VSB                      : +5.016 V VBAT                     : +3.200 V  Smart Fan                 [Enabled] ▶ Smart Fan Mode Configuration                     </pre>	<p>Enable or Disable Smart Fan</p> <hr/> <pre> **+: Select Screen !1: Select Item Enter: Select +/-: Change Opt. F1: General Help F2: Previous Values F3: Optimized Defaults F4: Save &amp; Exit ESC: Exit                     </pre>
---	---

Version 2.22.1286 Copyright (C) 2022 AMI

Options Summary		
Smart Fan	Disable	
	Enable	Optimal Default, Failsafe Default
Enables or Disables Smart Fan.		

### 3.4.8 Smart Fan Mode Configuration

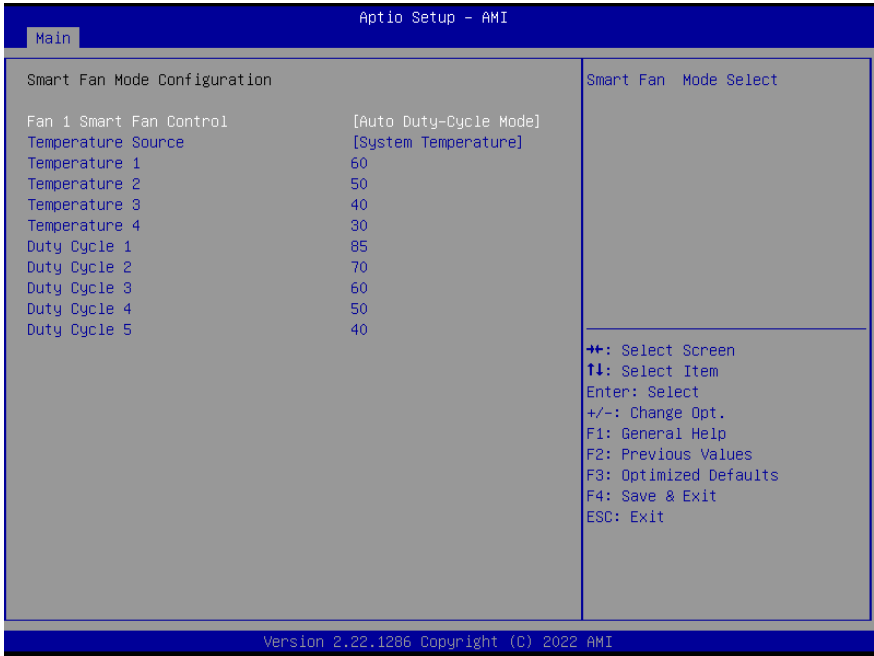

Options Summary		
Fan 1 Smart Fan Control	Manual Duty Mode	
	Auto Duty-Cycle Mode	Optimal Default, Failsafe Default
Smart Fan Mode Select		
Temperature Source	CPU Temperature	
	System Temperature	Optimal Default, Failsafe Default
	System Temperature 2	
Select the monitored temperature source for this fan.		
Temperature 1	60	
Duty Cycle 1	85	
Auto fan speed control. Fan speed will follow different temperature by different duty cycle 1-100		

### 3.4.9 SIO Configuration



### 3.4.9.1 Serial Port 1 Configuration

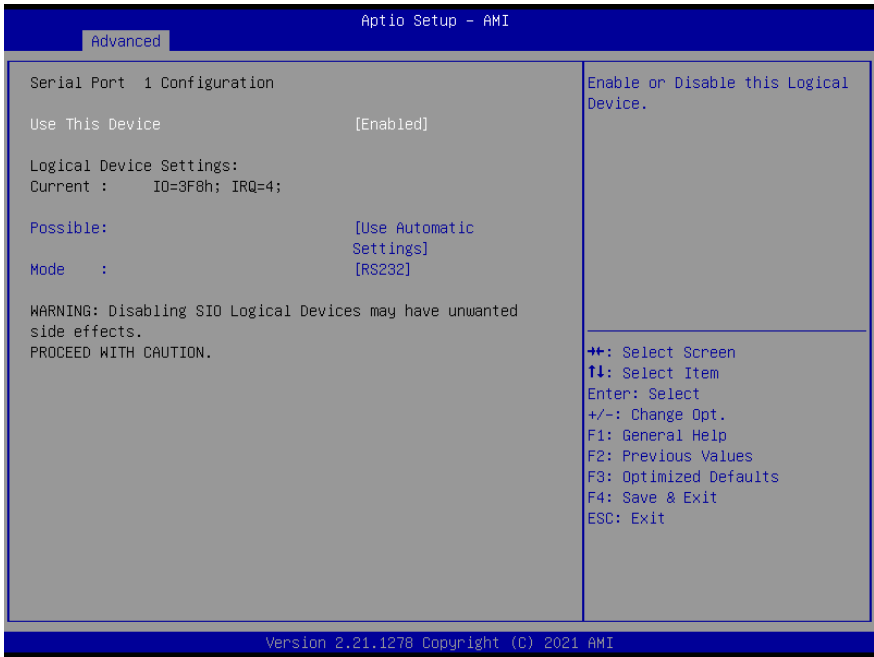

Options Summary		
Use This Device	Disable	
	Enable	Optimal Default, Failsafe Default
Enable or Disable this Logical Device.		
Possible:	Use Automatic Settings	Optimal Default, Failsafe Default
	IO=3F8h; IRQ=4	
	IO=2F8h; IRQ=3	
Allows user to change Device's Resource settings. New settings will be reflected on This Setup Page after System restarts.		
Mode:	RS232	Optimal Default, Failsafe Default
	RS422	
	RS485	
UART RS232, 422, 485 selection.		



### 3.4.9.2 Serial Port 2 Configuration



Options Summary		
Use This Device	Disable	
	Enable	Optimal Default, Failsafe Default
Enable or Disable this Logical Device.		
Possible:	Use Automatic Settings	Optimal Default, Failsafe Default
	IO=2F8h; IRQ=3	
	IO=3F8h; IRQ=4	
Allows user to change Device's Resource settings. New settings will be reflected on This Setup Page after System restarts.		
Mode:	RS232	Optimal Default, Failsafe Default
	RS422	
	RS485	
UART RS232, 422, 485 selection.		

### 3.4.9.3 Serial Port 3 Configuration

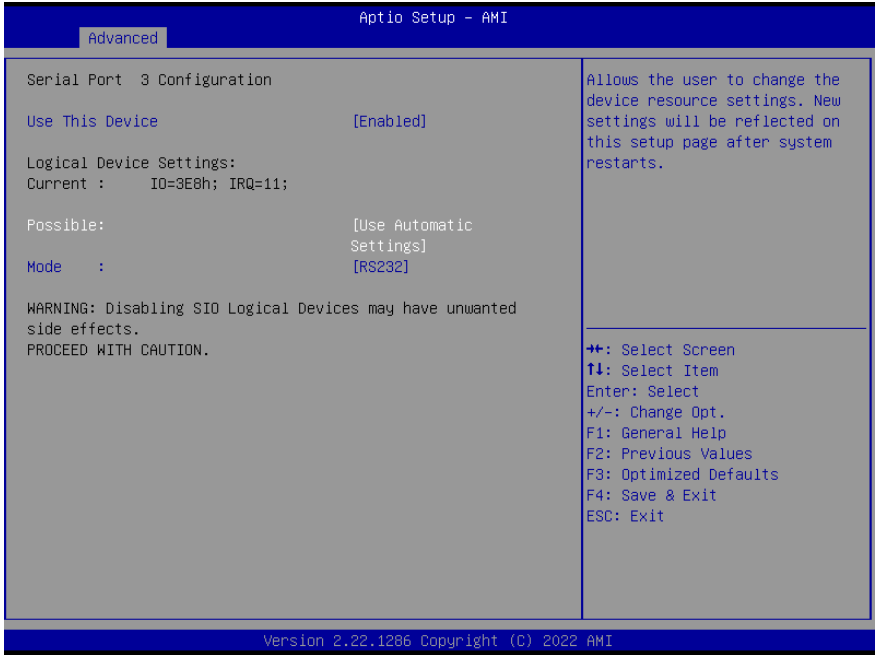

Options Summary		
Use This Device	Disable	
	Enable	Optimal Default, Failsafe Default
Enable or Disable this Logical Device.		
Possible:	Use Automatic Settings	Optimal Default, Failsafe Default
	IO=3E8h; IRQ=11	
	IO=2E8h; IRQ=11	
Allows user to change Device's Resource settings. New settings will be reflected on This Setup Page after System restarts.		
Mode:	RS232	Optimal Default, Failsafe Default
	RS422	
	RS485	
UART RS232, 422, 485 selection.		

### 3.4.9.4 Serial Port 4 Configuration



Options Summary		
Use This Device	Disable	
	Enable	Optimal Default, Failsafe Default
Enable or Disable this Logical Device.		
Possible:	Use Automatic Settings	Optimal Default, Failsafe Default
	IO=2E8h; IRQ=11	
	IO=3E8h; IRQ=11	
Allows user to change Device's Resource settings. New settings will be reflected on This Setup Page after System restarts.		
Mode:	RS232	Optimal Default, Failsafe Default
	RS422	
	RS485	
UART RS232, 422, 485 selection.		

### 3.4.10 Serial Port Console Redirection

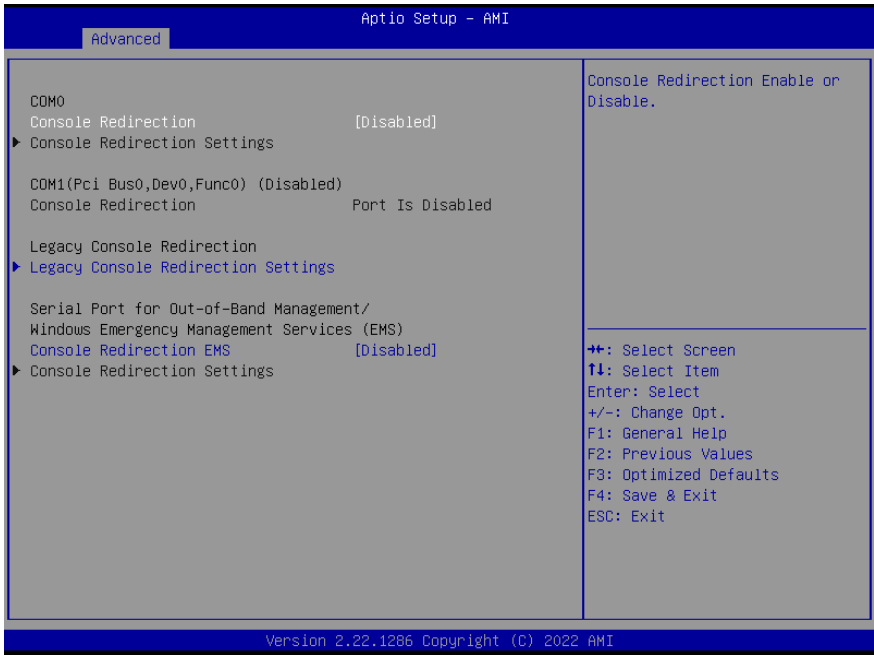

Options Summary		
Console Redirection	Disabled	Optimal Default, Failsafe Default
	Enabled	
Console Redirection Enable or Disable.		
Console Redirection EMS	Disabled	Optimal Default, Failsafe Default
	Enabled	
Console Redirection Enable or Disable.		

### 3.4.11 Legacy Console Redirection Settings

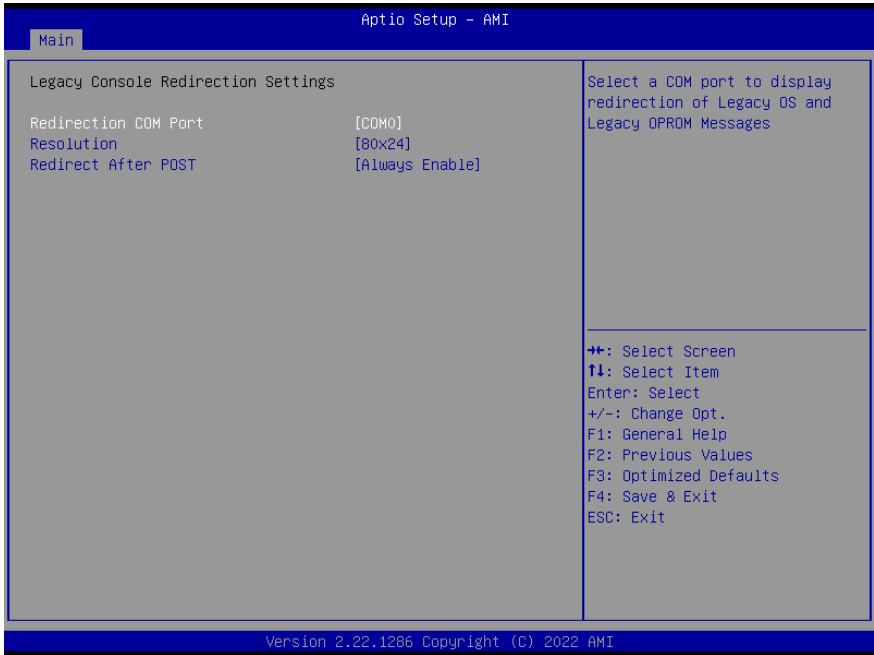

Options Summary		
Redirection COM port	COM0	Optimal Default, Failsafe Default
	COM1 (Pci Bus0, Dev0, Func0) (Disabled)	
Select a COM Port to display redirection of Legacy OS and Legacy OPROM message.		
Resolution	80x24	Optimal Default, Failsafe Default
	80x25	
On Legacy OS, the number of Rows and Columns supported redirection		
Redirect After POST	Always Enable	Optimal Default, Failsafe Default
	BootLoader	
When Bootloader is selected, then Legacy Console Redirection is disabled before booting to legacy OS. When Always Enable is selected, then Legacy Console Redirection is enabled for legacy OS. Default setting for this option is set to Always Enable.		

### 3.4.12 AAEON BIOS Robot

Aptio Setup - AMI

Advanced

AAEON BIOS Robot		Enabled - Robot set Watch Dog Timer(WDT) right after power on, before BIOS start POST process.
Sends watch dog before BIOS POST	[Disabled]	And then Robot will clear WDT on completion of POST. WDT will reset system automatically if it is not cleared before its timer counts down to zero.
POST Timer (second)	30	
Sends watch dog before booting OS	[Disabled]	
OS Timer (minute)	3	
Delayed POST (PEI phase)	[Disabled]	
Delayed time (second)	10	
Delayed POST (DXE phase)	[Disabled]	
Delayed time (second)	10	
Reset system once	[Disabled]	
Soft or hard reset	[Soft reset]	
▶ Device detecting configuration		++: Select Screen ↑↓: Select Item Enter: Select +/-: Change Opt. F1: General Help F2: Previous Values F3: Optimized Defaults F4: Save & Exit ESC: Exit

Version 2.21.1278 Copyright (C) 2021 AMI

Options Summary		
<b>Sends watch dog before BIOS POST</b>	Disabled	Optimal Default, Failsafe Default
	Enabled	
Enabled -Robot set Watch Dog Timer (WDT) right after power on, before BIOS start POST process. And then Robot will clear WDT on completion of POST. WDT will reset system automatically if it is not cleared before its timer counts down to zero.		
<b>POST Timer (second)</b>	30	Optimal Default, Failsafe Default
Timer count set to Watch Dog Timer for POST.\n\n WARNING: Do not set to a value equal or shorter than normal POST time, otherwise system may never complete POST unless clearing BIOS settings. More than 2x normal POST time is suggested.		
<b>Sends watch dog before booting OS</b>	Disabled	Optimal Default, Failsafe Default
	Enabled	
Enabled - Robot set Watch Dog Timer (WDT) after POST completion, before BIOS transfer control to OS. WARNING: Before enabling this function, a program in OS must be in responsible for clearing WDT. Also, this function should be disabled if OS is going to update itself.		

Options Summary		
<b>OS Timer (minute)</b>	3	Optimal Default, Failsafe Default
Timer count set to Watch Dog Timer for OS loading.		
<b>Delayed POST (PEI phase)</b>	Disabled	Optimal Default, Failsafe Default
	Enabled	
Enabled - Robot holds BIOS from starting POST, right after power on. This allows BIOS POST to start with stable power or start after system is physically warmed-up. Note: Robot does this before 'Sends watch dog'.		
<b>Delayed time (second)</b>	10	Optimal Default, Failsafe Default
Period of time for Robot to hold BIOS from POST.		
<b>Delayed POST (DXE phase)</b>	Disabled	Optimal Default, Failsafe Default
	Enabled	
Enabled - Robot holds BIOS before POST completion. This allows BIOS POST to start with stable power or start after system is physically warmed-up. Note: Robot does this after 'Sends watch dog before BIOS POST'.		
<b>Delayed time (second)</b>	10	Optimal Default, Failsafe Default
Period of time for Robot to hold BIOS from POST.		
<b>Reset system once</b>	Disabled	Optimal Default, Failsafe Default
	Enabled	
Enabled - Robot resets system for one time on each boot. This will send a soft or hard reset to onboard devices, thus puts devices to more stable state.		
<b>Soft or hard reset</b>	Soft reset	Optimal Default, Failsafe Default
	Hard reset"	
Select reset type robot should send on each boot.		

### 3.4.13 Power Management

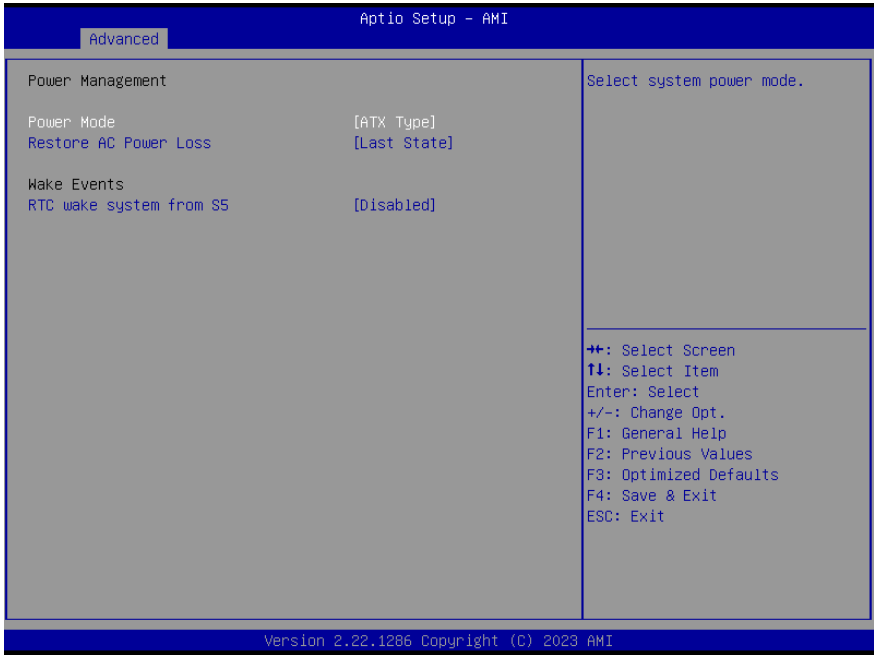

Options Summary		
Power Mode	ATX Type	Optimal Default, Failsafe Default
	AT Type	
Select power supply mode.		
Restore AC Power Loss	Last State	Optimal Default, Failsafe Default
	Always On	
	Always Off	
Select power state when power is re-applied after a power failure.		
RTC wake system from S5	Disable	Optimal Default, Failsafe Default
	Fixed Time	
	Bypass	
Fixed Time: System will wake on the hr::min::sec specified. Bypass: BIOS will not control RTC wake function during system shutdown		



### 3.4.14 Digital IO Port Configuration

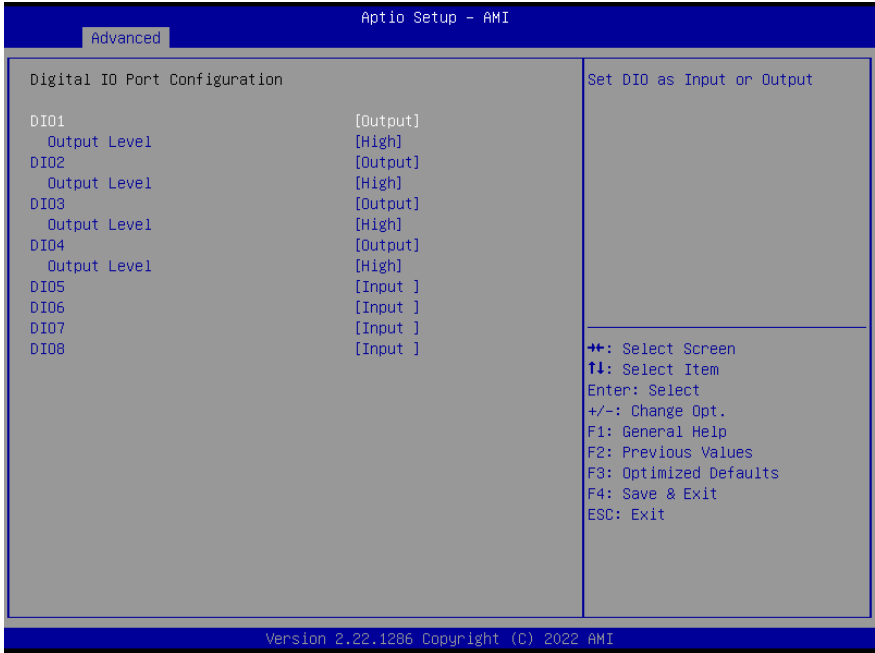

Options Summary		
DIO Port*	Output	
	Input	
Set DIO as Input or Output		
Output Level	High	
	Low	
Set output level when DIO pin is output		

### 3.5 Setup Submenu: Chipset



### 3.5.1 System Agent (SA) Configuration

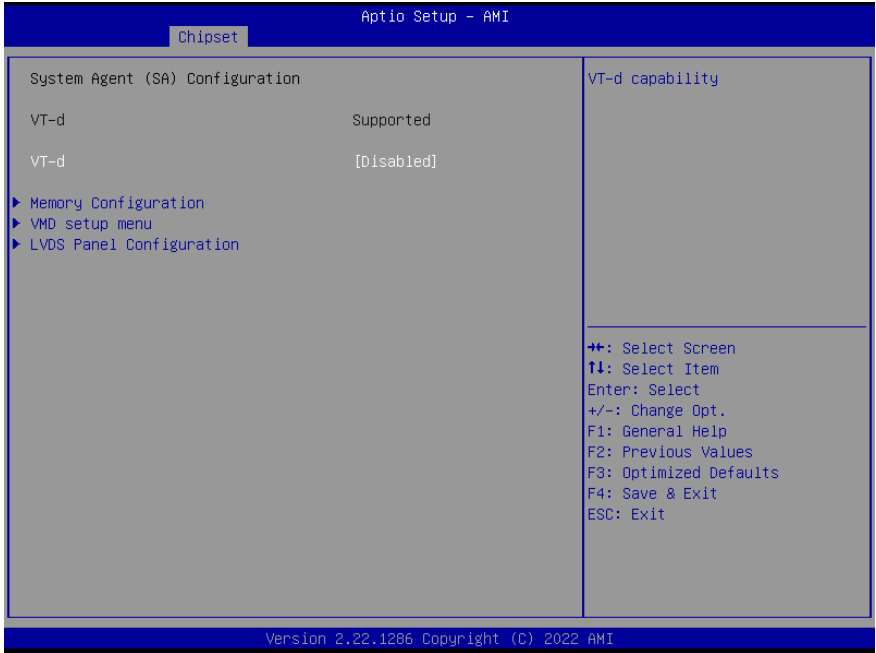

Options Summary		
VT-d	Disabled	Optimal Default, Failsafe Default
	Enabled	
VT-d capability.		

### 3.5.2 Memory Configuration

Aptio Setup - AMI

Chipset

Memory Configuration	
Total Memory	8192 MB
Memory Frequency	4800 MHz
tCL-tRCD-tRP-tRAS	40-39-39-77
MC 0 Ch 0 DIMM 0	Populated & Enabled
Size	8192 MB (DDR5)
MC 1 Ch 0 DIMM 0	Not Populated / Disabled

++: Select Screen  
↑↓: Select Item  
Enter: Select  
+/-: Change Opt.  
F1: General Help  
F2: Previous Values  
F3: Optimized Defaults  
F4: Save & Exit  
ESC: Exit

Version 2.22.1286 Copyright (C) 2022 AMI

### 3.5.3 VMD Setup Menu



Options Summary		
Enable VMD Controller	Disabled	Optimal Default, Failsafe Default
	Enabled	
Enable/Disable to VMD Controller.		

### 3.5.4 LVDS Panel Configuration

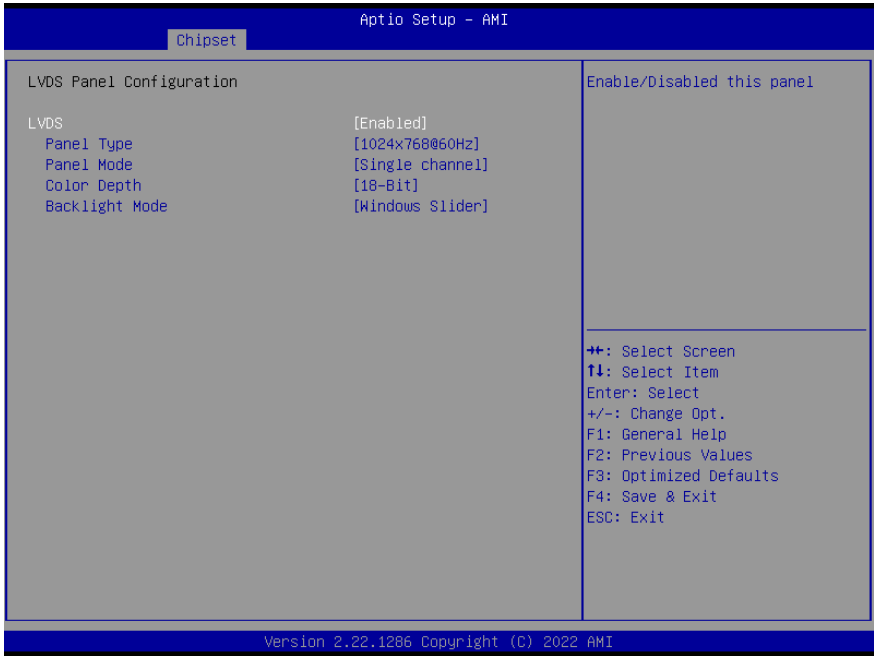

Options Summary		
LVDS	Disabled	
	Enabled	Optimal Default, Failsafe Default
Enable/Disabled this panel.		
LVDS Panel Type	640x480,18bit,60Hz	
	800x480,18bit,60Hz	
	800x600,18bit,60Hz	
	1024x600,18bit,60Hz	
	1024x768,18bit,60Hz	
	1024x768,24bit,60Hz	Optimal Default, Failsafe Default
	1280x768,24bit,60Hz	
	1280x1024,48bit,60Hz	
	1366x768,24bit,60Hz	
	1440x900,48bit,60Hz	
	1600x1200,48bit,60Hz	
	1920x1080,48bit,60Hz	
1920x1200,48bit,60Hz		

Options Summary		
Select LCD panel used by Internal Graphics Device by selecting the appropriate setup item.		
<b>Panel Mode</b>	Single Channel	Optimal Default, Failsafe Default
	Dual Channel	
Panel mode selection for Single channel or Dual channel		
<b>Color Depth</b>	18-bit	Optimal Default, Failsafe Default
	24-bit	
	36-bit	
	48-bit	
Select panel type		
<b>Backlight Mode</b>	BIOS & Application	
	Windows Slider	Optimal Default, Failsafe Default
Select backlight control signal type		

### 3.5.5 PCH-IO Configuration

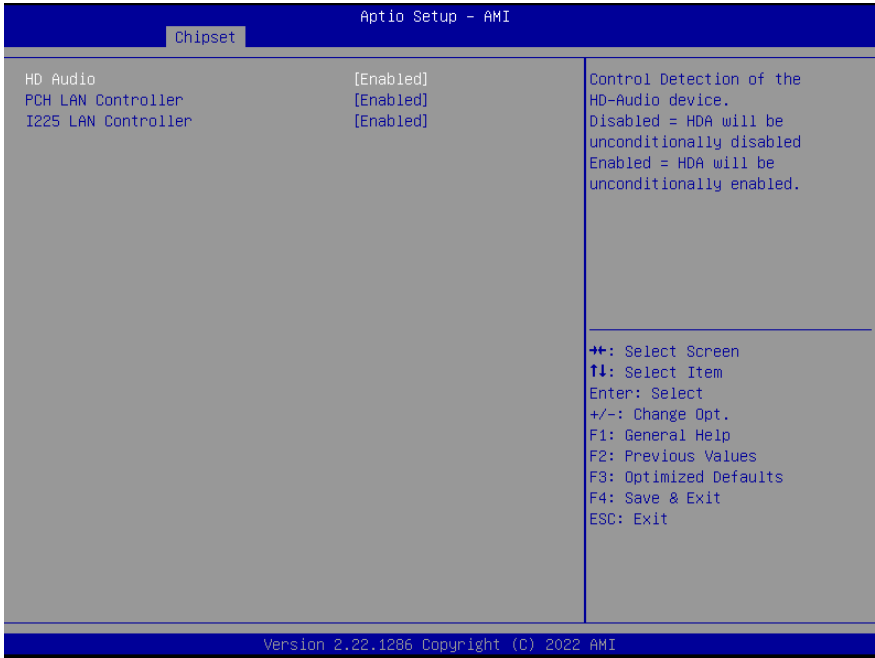

Options Summary		
HD Audio	Disabled	
	Enabled	Optimal Default, Failsafe Default
Control Detection of the HD-Audio Device. Disabled = HDA will unconditionally disabled Enabled = HDA will be unconditionally enabled.		
PCH LAN Controller	Disabled	
	Enabled	Optimal Default, Failsafe Default
Enable/Disable onboard NIC		
I225 LAN Controller	Disabled	
	Enabled	Optimal Default, Failsafe Default
Enable/Disable I225 LAN Controller		



## 3.6 Setup Submenu: Security

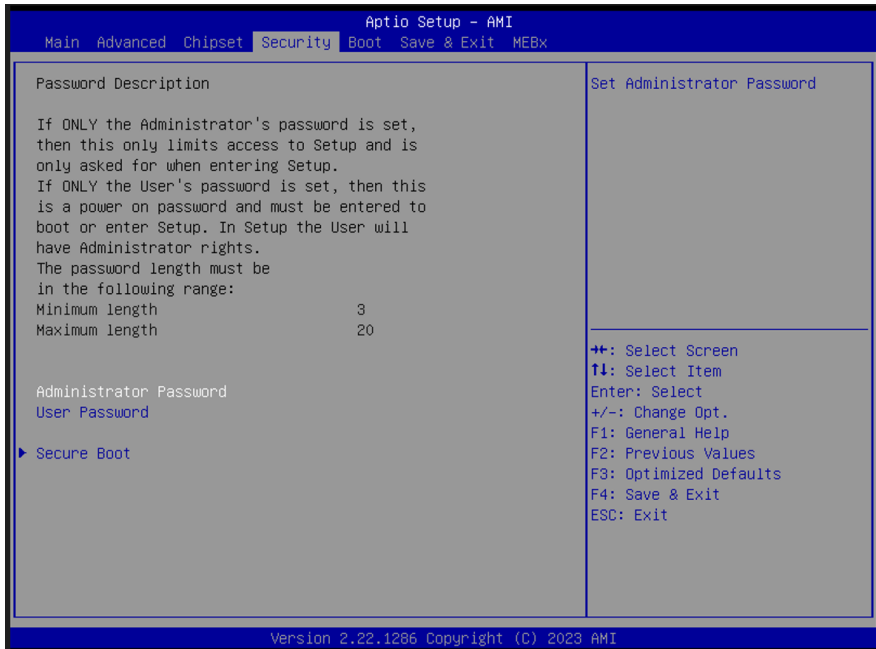

### Change User/Supervisor Password

You can install a Supervisor password, and if you install a supervisor password, you can then install a user password. A user password does not provide access to many of the features in the Setup utility.

If you highlight these items and press Enter, a dialog box appears which lets you enter a password. You can enter no more than six letters or numbers. Press Enter after you have typed in the password. A second dialog box asks you to retype the password for confirmation. Press Enter after you have retyped it correctly. The password is required at boot time, or when the user enters the Setup utility.

### Removing the Password

Highlight this item and type in the current password. At the next dialog box press Enter to disable password protection.

### 3.6.1 Secure Boot

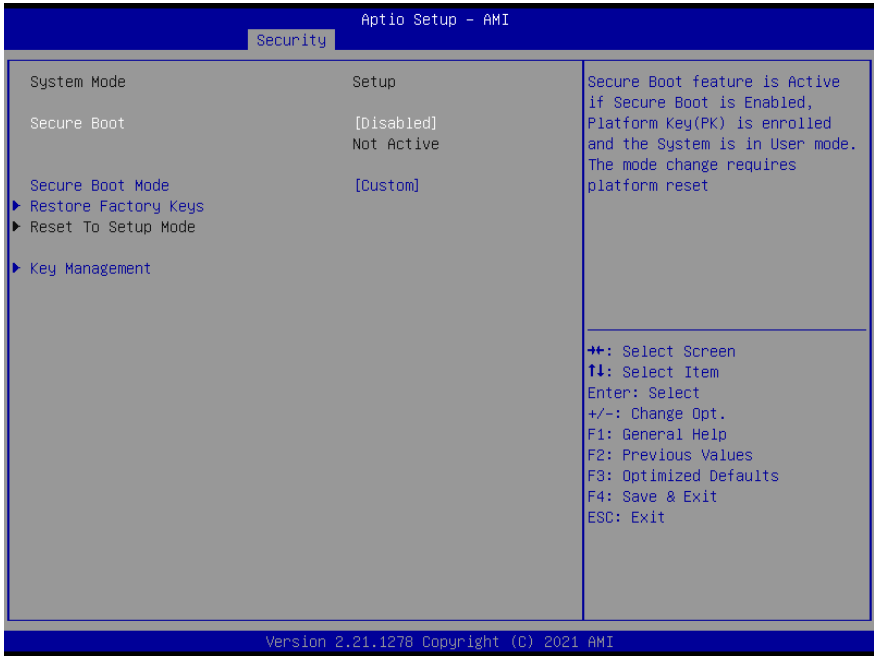

Options Summary		
<b>Secure Boot</b>	Disabled	Optimal Default, Failsafe Default
	Enabled	
Secure Boot feature is Active if Secure Boot is Enabled, Platform Key (PK) is enrolled and the System is in User mode. The mode change requires platform reset.		
<b>Secure Boot Mode</b>	Custom	Optimal Default, Failsafe Default
	Standard	
Secure Boot mode options: Standard or Custom. In Custom mode, Secure Boot Policy variables can be configured by a physically present user without full authentication.		
<b>Restore Factory Keys</b>		
Force System to User Mode. Install factory default Secure Boot key databases.		
<b>Reset to Setup Mode</b>		
Delete all Secure Boot key databases from NVRAM.		



Options Summary	
<b>Remove 'UEFI CA' from DB</b>	
Device Guard ready system must not list 'Microsoft UEFI CA' Certificate in Authorized Signature database (db).	
<b>Restore DB defaults</b>	
Restore DB variable to factory defaults.	
<b>Platform Key (PK)</b>	Details
	Export
	Update
	Delete
<b>Key Exchange Keys</b>	Details
	Export
	Update
	Append
	Delete
<b>Authorized Signatures</b>	Details
	Export
	Update
	Append
	Delete
<b>Forbidden Signatures</b>	Details
	Export
	Update
	Append
	Delete
<b>Authorized TimeStamps</b>	Update
	Append
<b>OsRecovery Signatures</b>	Update
	Append
Enroll Factory Defaults or load certificates from a file:	
1.Public Key Certificate:	
a) EFI_SIGNATURE_LIST	
b) EFI_CERT_X509 (DER)	
c) EFI_CERT_RSA2048 (bin)	
d) EFI_CERT_SHAXXX	
2.Authenticated UEFI Variable	
3.EFI PE/COFF Image (SHA256)	
Key Source: Factory, External, Mixed	

### 3.7 Setup Submenu: Boot



Options Summary		
Quiet Boot	Disabled	
	Enabled	Optimal Default, Failsafe Default
Enable/Disable Quiet Boot option.		
UEFI PXE Support	Disabled	Optimal Default, Failsafe Default
	Enabled	
Enable/Disable UEFI Network Stack.		
<b>FIXED BOOT ORDER Priorities</b>		
Sets the system boot order		

### 3.8 Setup Submenu: Save & Exit

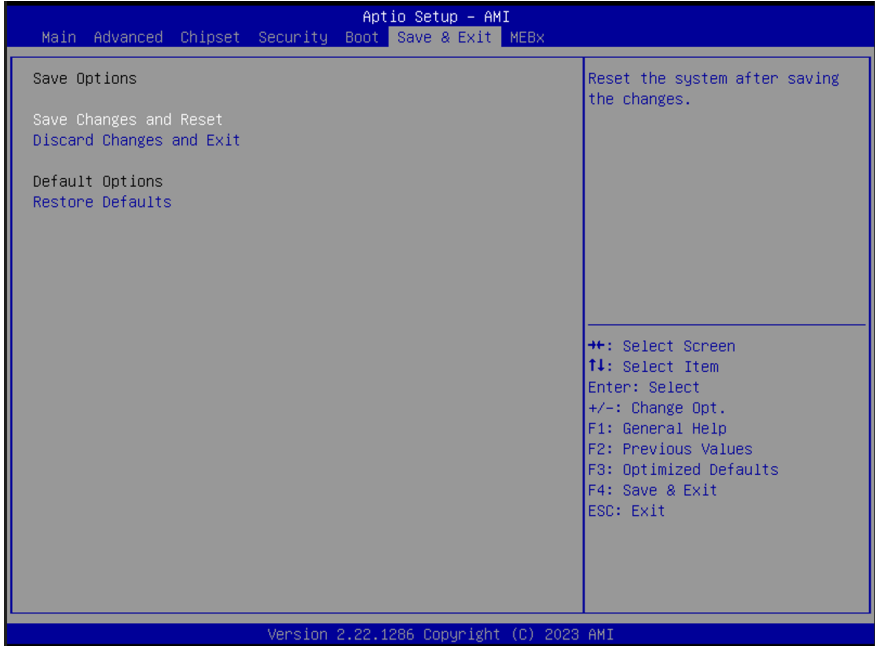

Options Summary
<b>Save Changes and Reset</b>
Reset the system after saving the changes.
<b>Discard Changes and Exit</b>
Exit system setup without saving any changes.
<b>Restore Defaults</b>
Restore/Load Default values for all the setup options.

### 3.9 Setup Submenu: MEBx



### 3.9.1 Intel® AMT Configuration



Options Summary		
Password Policy	Default Password Only	
	During Setup and Configuration	
	Anytime	Optimal Default, Failsafe Default
Network Access State	Network Active	
	Network Inactive	Optimal Default, Failsafe Default
	Full Unprovision	
Changes network state of ME. When disabling, it will also clear some other settings.		



### 3.9.2 Redirection Features

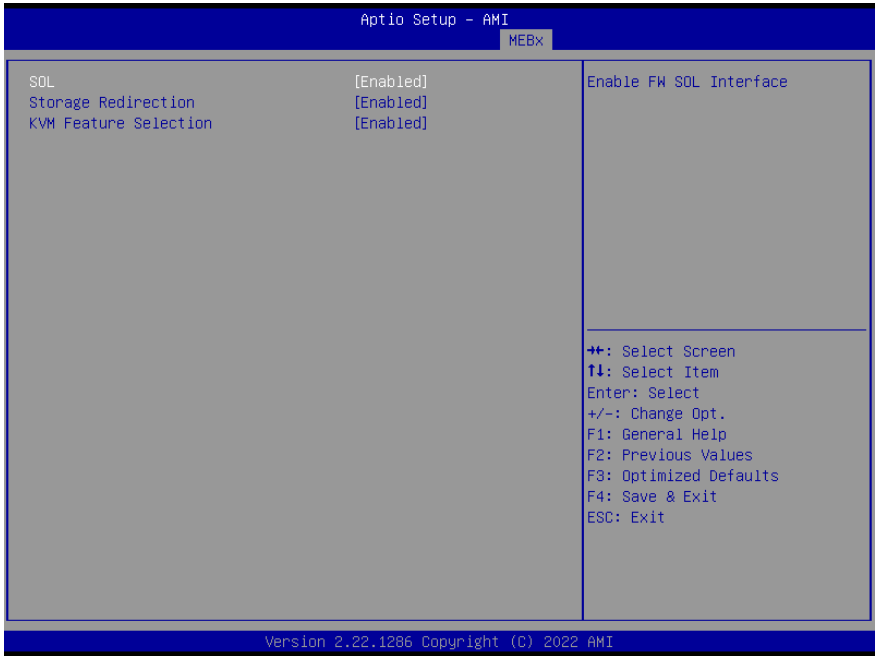

Options Summary		
SOL	Disabled	
	Enabled	Optimal Default, Failsafe Default
Enable FW SOL Interface		
Storage Redirection	Disabled	
	Enabled	Optimal Default, Failsafe Default
Enable FW Remote – Storage Redirection		
KVM Features Selection	Disabled	
	Enabled	Optimal Default, Failsafe Default
Enable FW KVM Feature		

### 3.9.3 User Consent

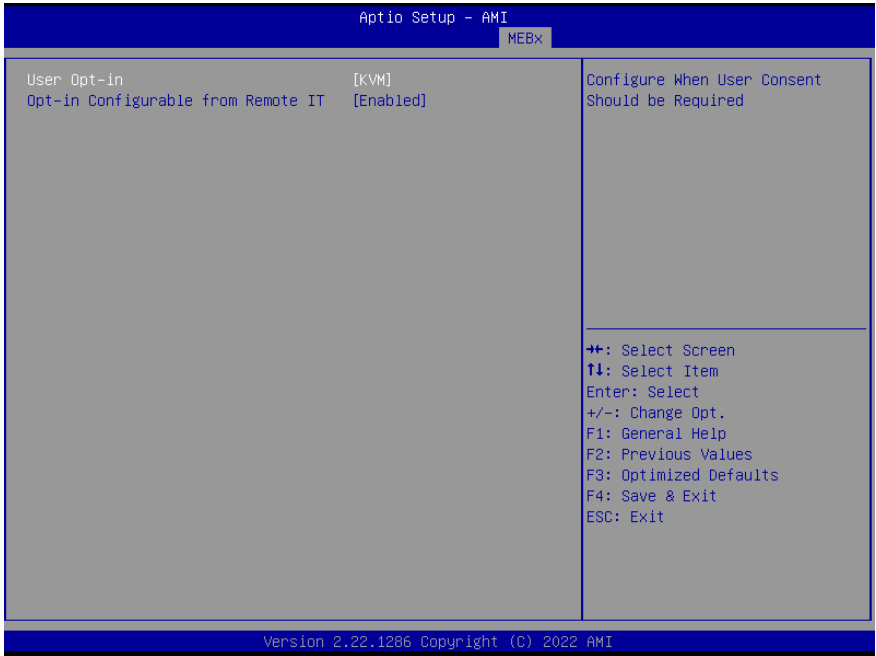

Options Summary		
User Opt-in	None	
	KVM	Optimal Default, Failsafe Default
	ALL	
Configure When User Consent Should be Required		
Opt-in Configurable from Remote IT	Disabled	
	Enabled	Optimal Default, Failsafe Default
Enable/Disable Remote Change Capability of User Consent Feature		

### 3.9.4 Power Control

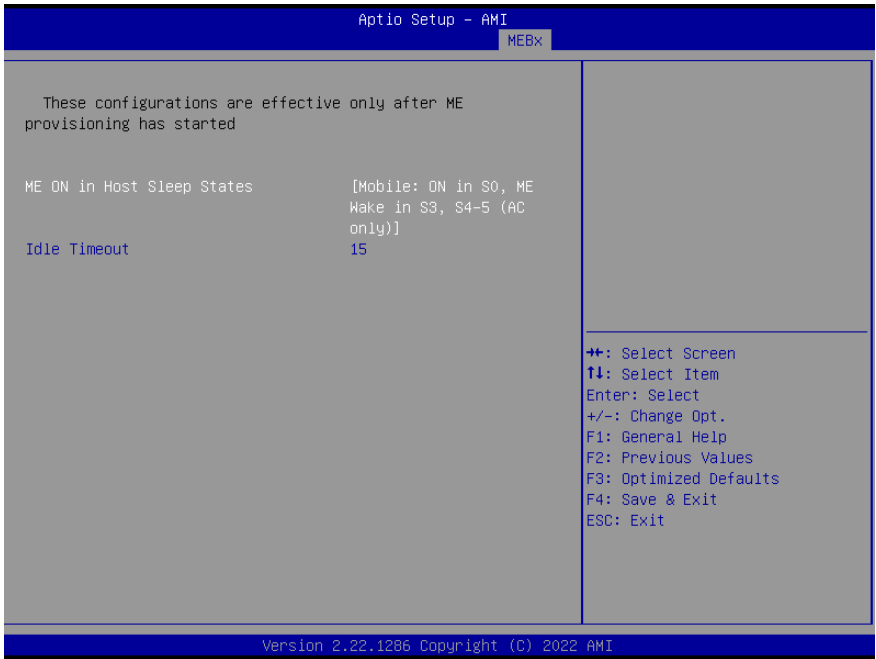

Options Summary		
ME ON in Host Sleep States	Mobile: ON in S0	Optimal Default, Failsafe Default
	Mobile: ON in S0, ME Wake in S3, S4-5(AC only)	
Idle Timeout	15	
Timeout Value (1-65536)		

# Chapter 4

---

Drivers Installation

## 4.1 Drivers Download and Installation

---

Drivers for the EPIC-ADS7-PUC can be downloaded from the product page on the AAEON website by following this link:

<https://www.aaeon.com/en/p/epic-board-alder-lake-epic-ads7-puc>

Download the driver(s) you need and follow the steps below to install them.

### Install Audio Driver (Windows 10, Windows 11)

1. Open the **Audio Driver** folder
2. Open the **Setup.exe** file
3. Follow the instructions
4. Drivers will be installed automatically

### Install Chipset Drivers (Windows 10, Windows 11)

1. Open the **Chipset** folder
2. Open the **SetupChipset.exe** file
3. Follow the instructions
4. Drivers will be installed automatically

### Install Graphics Driver (Windows 10, Windows 11)

1. Open the **Graphics** folder
2. Open the **Installer.exe** file in the folder
3. Follow the instructions
4. Drivers will be installed automatically

### Install LAN Driver (Windows 10, Windows 11)

1. Open the **LAN Driver** folder
2. Open the **Autorun.exe** file in the folder
3. Follow the instructions
4. Drivers will be installed automatically

### Install Linux Peripheral Driver (Ubuntu 20.04.3)

1. Open the **Linux Driver-Peripheral** folder
2. Follow the instructions contained within the user guides to manually install drivers.

### Install ME & TXE Drivers (Windows 10, Windows 11)

1. Open the **ME & TXE Driver** folder
2. Open the **SetupME.exe** file
3. Follow the instructions
4. Drivers will be installed automatically

### Install Peripheral Drivers (Windows 10, Windows 11)

#### Serial I/O

1. Open the **Peripheral Driver** folder
2. Unzip the **Intel Serial IO 3.0.2708.5** folder
3. Open the **SetupSerialIO.exe** file
4. Follow the instructions
5. Drivers will be installed automatically

#### Intel® Smart Sound Technology Driver

1. Open the **Peripheral Driver** folder
2. Unzip the **Intel\_SST\_ADL\_v10.29.00.7621** folder
3. Follow the instructions contained within the user guides to manually install driver

# Appendix A

---





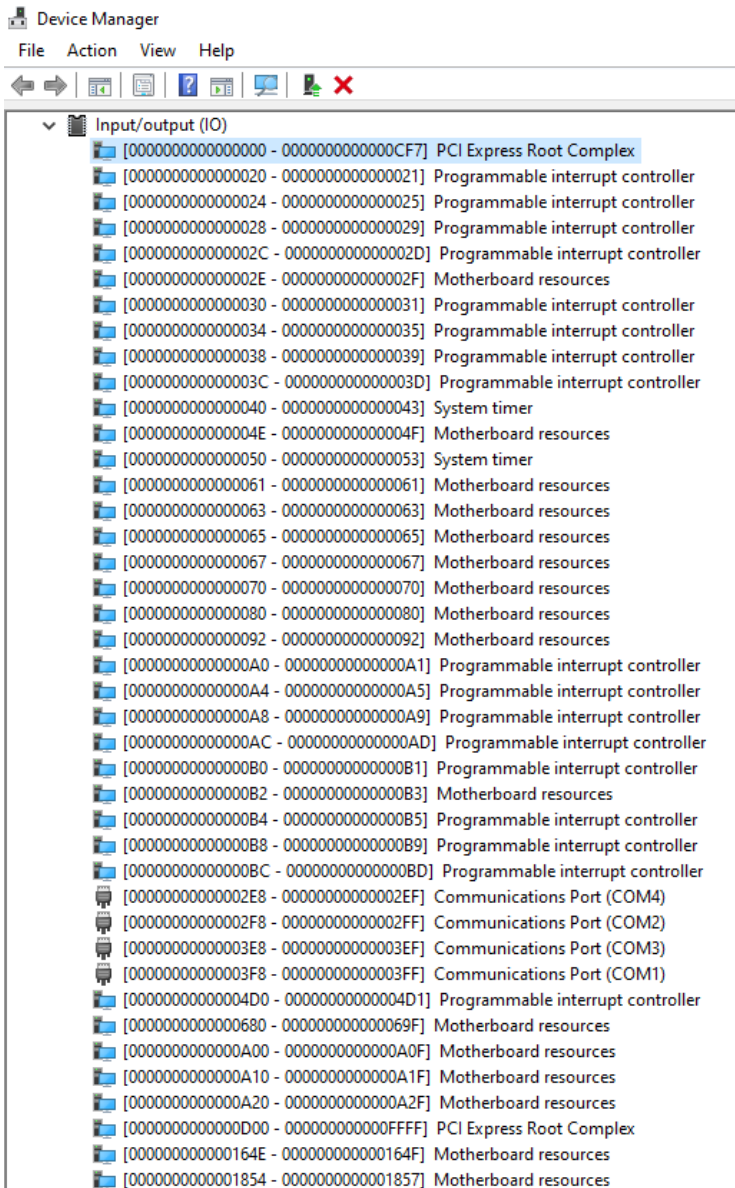

































I/O Information

## A.1 I/O Address Map



Address Range	Device Name
[0000000000000000 - 000000000000CF7]	PCI Express Root Complex
[0000000000000020 - 000000000000021]	Programmable interrupt controller
[0000000000000024 - 000000000000025]	Programmable interrupt controller
[0000000000000028 - 000000000000029]	Programmable interrupt controller
[000000000000002C - 00000000000002D]	Programmable interrupt controller
[000000000000002E - 00000000000002F]	Motherboard resources
[0000000000000030 - 000000000000031]	Programmable interrupt controller
[0000000000000034 - 000000000000035]	Programmable interrupt controller
[0000000000000038 - 000000000000039]	Programmable interrupt controller
[000000000000003C - 00000000000003D]	Programmable interrupt controller
[0000000000000040 - 000000000000043]	System timer
[000000000000004E - 00000000000004F]	Motherboard resources
[0000000000000050 - 000000000000053]	System timer
[0000000000000061 - 000000000000061]	Motherboard resources
[0000000000000063 - 000000000000063]	Motherboard resources
[0000000000000065 - 000000000000065]	Motherboard resources
[0000000000000067 - 000000000000067]	Motherboard resources
[0000000000000070 - 000000000000070]	Motherboard resources
[0000000000000080 - 000000000000080]	Motherboard resources
[0000000000000092 - 000000000000092]	Motherboard resources
[00000000000000A0 - 0000000000000A1]	Programmable interrupt controller
[00000000000000A4 - 0000000000000A5]	Programmable interrupt controller
[00000000000000A8 - 0000000000000A9]	Programmable interrupt controller
[00000000000000AC - 0000000000000AD]	Programmable interrupt controller
[00000000000000B0 - 0000000000000B1]	Programmable interrupt controller
[00000000000000B2 - 0000000000000B3]	Motherboard resources
[00000000000000B4 - 0000000000000B5]	Programmable interrupt controller
[00000000000000B8 - 0000000000000B9]	Programmable interrupt controller
[00000000000000BC - 0000000000000BD]	Programmable interrupt controller
[00000000000002E8 - 00000000000002EF]	Communications Port (COM4)
[00000000000002F8 - 00000000000002FF]	Communications Port (COM2)
[00000000000003E8 - 00000000000003EF]	Communications Port (COM3)
[00000000000003F8 - 00000000000003FF]	Communications Port (COM1)
[00000000000004D0 - 00000000000004D1]	Programmable interrupt controller
[0000000000000680 - 000000000000069F]	Motherboard resources
[0000000000000A00 - 0000000000000A0F]	Motherboard resources
[0000000000000A10 - 0000000000000A1F]	Motherboard resources
[0000000000000A20 - 0000000000000A2F]	Motherboard resources
[0000000000000D00 - 000000000000FFFF]	PCI Express Root Complex
[000000000000164E - 000000000000164F]	Motherboard resources
[0000000000001854 - 0000000000001857]	Motherboard resources



	[0000000000000038 - 0000000000000039]	Programmable interrupt controller
	[000000000000003C - 000000000000003D]	Programmable interrupt controller
	[0000000000000040 - 0000000000000043]	System timer
	[000000000000004E - 000000000000004F]	Motherboard resources
	[0000000000000050 - 0000000000000053]	System timer
	[0000000000000061 - 0000000000000061]	Motherboard resources
	[0000000000000063 - 0000000000000063]	Motherboard resources
	[0000000000000065 - 0000000000000065]	Motherboard resources
	[0000000000000067 - 0000000000000067]	Motherboard resources
	[0000000000000070 - 0000000000000070]	Motherboard resources
	[0000000000000080 - 0000000000000080]	Motherboard resources
	[0000000000000092 - 0000000000000092]	Motherboard resources
	[00000000000000A0 - 00000000000000A1]	Programmable interrupt controller
	[00000000000000A4 - 00000000000000A5]	Programmable interrupt controller
	[00000000000000A8 - 00000000000000A9]	Programmable interrupt controller
	[00000000000000AC - 00000000000000AD]	Programmable interrupt controller
	[00000000000000B0 - 00000000000000B1]	Programmable interrupt controller
	[00000000000000B2 - 00000000000000B3]	Motherboard resources
	[00000000000000B4 - 00000000000000B5]	Programmable interrupt controller
	[00000000000000B8 - 00000000000000B9]	Programmable interrupt controller
	[00000000000000BC - 00000000000000BD]	Programmable interrupt controller
	[00000000000002E8 - 00000000000002EF]	Communications Port (COM4)
	[00000000000002F8 - 00000000000002FF]	Communications Port (COM2)
	[00000000000003E8 - 00000000000003EF]	Communications Port (COM3)
	[00000000000003F8 - 00000000000003FF]	Communications Port (COM1)
	[00000000000004D0 - 00000000000004D1]	Programmable interrupt controller
	[0000000000000680 - 000000000000069F]	Motherboard resources
	[0000000000000A00 - 0000000000000A0F]	Motherboard resources
	[0000000000000A10 - 0000000000000A1F]	Motherboard resources
	[0000000000000A20 - 0000000000000A2F]	Motherboard resources
	[0000000000000D00 - 0000000000000FFF]	PCI Express Root Complex
	[000000000000164E - 000000000000164F]	Motherboard resources
	[0000000000001854 - 0000000000001857]	Motherboard resources
	[0000000000002000 - 00000000000020FE]	Motherboard resources
	[0000000000003000 - 000000000000303F]	Intel(R) UHD Graphics
	[0000000000003060 - 000000000000307F]	Standard SATA AHCI Controller
	[0000000000003080 - 0000000000003083]	Standard SATA AHCI Controller
	[0000000000003090 - 0000000000003097]	Standard SATA AHCI Controller
	[000000000000EFA0 - 000000000000EFBF]	Intel(R) SMBus - 7AA3

## A.2 IRQ Mapping Chart

The screenshot shows the Windows Device Manager window with the 'Interrupt request (IRQ)' category expanded. The list contains 32 entries, each with an icon, an ISA address in parentheses, and a device name. The first entry is 'System timer' with ISA address 0x00000000 (00). The next three entries are 'Communications Port (COM2)', 'Communications Port (COM1)', and 'Communications Port (COM3)' with ISA addresses 0x00000003 (03), 0x00000004 (04), and 0x0000000B (11) respectively. The next two entries are 'Communications Port (COM4)' with ISA address 0x0000000B (11) and 'Intel(R) Serial IO GPIO Host Controller - INTC1056' with ISA address 0x0000000E (14). The remaining 27 entries are all 'Microsoft ACPI-Compliant System' with ISA addresses ranging from 0x00000037 (55) to 0x00000059 (89).

ISA Address (Hex)	ISA Address (Dec)	Device Name
0x00000000	00	System timer
0x00000003	03	Communications Port (COM2)
0x00000004	04	Communications Port (COM1)
0x0000000B	11	Communications Port (COM3)
0x0000000B	11	Communications Port (COM4)
0x0000000E	14	Intel(R) Serial IO GPIO Host Controller - INTC1056
0x00000037	55	Microsoft ACPI-Compliant System
0x00000038	56	Microsoft ACPI-Compliant System
0x00000039	57	Microsoft ACPI-Compliant System
0x0000003A	58	Microsoft ACPI-Compliant System
0x0000003B	59	Microsoft ACPI-Compliant System
0x0000003C	60	Microsoft ACPI-Compliant System
0x0000003D	61	Microsoft ACPI-Compliant System
0x0000003E	62	Microsoft ACPI-Compliant System
0x0000003F	63	Microsoft ACPI-Compliant System
0x00000040	64	Microsoft ACPI-Compliant System
0x00000041	65	Microsoft ACPI-Compliant System
0x00000042	66	Microsoft ACPI-Compliant System
0x00000043	67	Microsoft ACPI-Compliant System
0x00000044	68	Microsoft ACPI-Compliant System
0x00000045	69	Microsoft ACPI-Compliant System
0x00000046	70	Microsoft ACPI-Compliant System
0x00000047	71	Microsoft ACPI-Compliant System
0x00000048	72	Microsoft ACPI-Compliant System
0x00000049	73	Microsoft ACPI-Compliant System
0x0000004A	74	Microsoft ACPI-Compliant System
0x0000004B	75	Microsoft ACPI-Compliant System
0x0000004C	76	Microsoft ACPI-Compliant System
0x0000004D	77	Microsoft ACPI-Compliant System
0x0000004E	78	Microsoft ACPI-Compliant System
0x0000004F	79	Microsoft ACPI-Compliant System
0x00000050	80	Microsoft ACPI-Compliant System
0x00000051	81	Microsoft ACPI-Compliant System
0x00000052	82	Microsoft ACPI-Compliant System
0x00000053	83	Microsoft ACPI-Compliant System
0x00000054	84	Microsoft ACPI-Compliant System
0x00000055	85	Microsoft ACPI-Compliant System
0x00000056	86	Microsoft ACPI-Compliant System
0x00000057	87	Microsoft ACPI-Compliant System
0x00000058	88	Microsoft ACPI-Compliant System
0x00000059	89	Microsoft ACPI-Compliant System

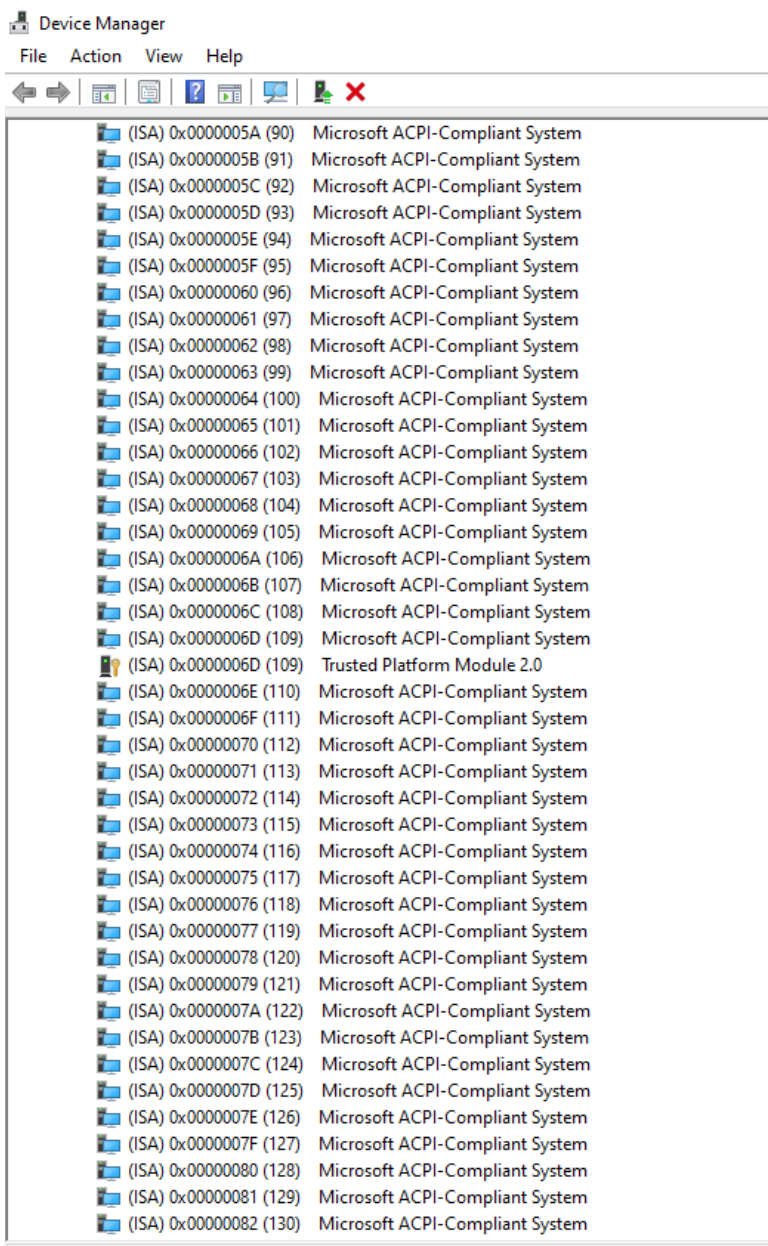

Device Manager

File Action View Help

(ISA) 0x000001EC (492)	Microsoft ACPI-Compliant System
(ISA) 0x000001ED (493)	Microsoft ACPI-Compliant System
(ISA) 0x000001EE (494)	Microsoft ACPI-Compliant System
(ISA) 0x000001EF (495)	Microsoft ACPI-Compliant System
(ISA) 0x000001F0 (496)	Microsoft ACPI-Compliant System
(ISA) 0x000001F1 (497)	Microsoft ACPI-Compliant System
(ISA) 0x000001F2 (498)	Microsoft ACPI-Compliant System
(ISA) 0x000001F3 (499)	Microsoft ACPI-Compliant System
(ISA) 0x000001F4 (500)	Microsoft ACPI-Compliant System
(ISA) 0x000001F5 (501)	Microsoft ACPI-Compliant System
(ISA) 0x000001F6 (502)	Microsoft ACPI-Compliant System
(ISA) 0x000001F7 (503)	Microsoft ACPI-Compliant System
(ISA) 0x000001F8 (504)	Microsoft ACPI-Compliant System
(ISA) 0x000001F9 (505)	Microsoft ACPI-Compliant System
(ISA) 0x000001FA (506)	Microsoft ACPI-Compliant System
(ISA) 0x000001FB (507)	Microsoft ACPI-Compliant System
(ISA) 0x000001FC (508)	Microsoft ACPI-Compliant System
(ISA) 0x000001FD (509)	Microsoft ACPI-Compliant System
(ISA) 0x000001FE (510)	Microsoft ACPI-Compliant System
(ISA) 0x000001FF (511)	Microsoft ACPI-Compliant System
(PCI) 0x00000011 (17)	High Definition Audio Controller
(PCI) 0x0000001B (27)	Intel(R) Serial IO I2C Host Controller - 7ACC
(PCI) 0x0000001D (29)	Intel(R) Serial IO I2C Host Controller - 7ACE
(PCI) 0x00000028 (40)	Intel(R) Serial IO I2C Host Controller - 7ACD
(PCI) 0x0000002B (43)	Intel(R) Serial IO I2C Host Controller - 7ACF
(PCI) 0xFFFFFED (-19)	Intel(R) Management Engine Interface #1
(PCI) 0xFFFFFEE (-18)	Intel(R) Ethernet Controller (3) I225-LM
(PCI) 0xFFFFFEF (-17)	Intel(R) Ethernet Controller (3) I225-LM
(PCI) 0xFFFFFFF0 (-16)	Intel(R) Ethernet Controller (3) I225-LM
(PCI) 0xFFFFFFF1 (-15)	Intel(R) Ethernet Controller (3) I225-LM
(PCI) 0xFFFFFFF2 (-14)	Intel(R) Ethernet Controller (3) I225-LM
(PCI) 0xFFFFFFF3 (-13)	Intel(R) Ethernet Controller (3) I225-LM
(PCI) 0xFFFFFFF4 (-12)	Intel(R) Ethernet Controller (3) I225-LM
(PCI) 0xFFFFFFF5 (-11)	Intel(R) Ethernet Controller (3) I225-LM
(PCI) 0xFFFFFFF6 (-10)	Intel(R) Ethernet Controller (3) I225-LM
(PCI) 0xFFFFFFF7 (-9)	Intel(R) Ethernet Controller (3) I225-LM
(PCI) 0xFFFFFFF8 (-8)	Intel(R) Ethernet Controller (3) I225-LM
(PCI) 0xFFFFFFF9 (-7)	Intel(R) Ethernet Controller (3) I225-LM
(PCI) 0xFFFFFFFA (-6)	Intel(R) Ethernet Controller (3) I225-LM
(PCI) 0xFFFFFFF8 (-5)	Intel(R) USB 3.20 eXtensible Host Controller - 1.20 (Microsoft)
(PCI) 0xFFFFFFFC (-4)	Intel(R) UHD Graphics
(PCI) 0xFFFFFFFD (-3)	Intel(R) Ethernet Connection (17) I219-LM

## A.3 Memory Address Map

Memory	
[0000000000A0000 - 0000000000BFFFF]	PCI Express Root Complex
[0000000080400000 - 00000000804FFFFF]	Intel(R) Ethernet Controller (3) I225-LM
[0000000080400000 - 00000000805FFFFF]	Intel(R) PCI Express Root Port #8 - 7ABF
[0000000080400000 - 00000000BFFFFFFF]	PCI Express Root Complex
[0000000080500000 - 0000000080503FFF]	Intel(R) Ethernet Controller (3) I225-LM
[0000000080600000 - 000000008061FFFF]	Intel(R) Ethernet Connection (17) I219-LM
[0000000080620000 - 0000000080621FFF]	Standard SATA AHCI Controller
[0000000080622000 - 00000000806227FF]	Standard SATA AHCI Controller
[0000000080623000 - 00000000806230FF]	Standard SATA AHCI Controller
[00000000C0000000 - 00000000CFFFFFFF]	Motherboard resources
[00000000E0690000 - 00000000E069FFFF]	Intel(R) Serial IO GPIO Host Controller - INTC1056
[00000000E06A0000 - 00000000E06AFFFF]	Intel(R) Serial IO GPIO Host Controller - INTC1056
[00000000E06B0000 - 00000000E06BFFFF]	Intel(R) Serial IO GPIO Host Controller - INTC1056
[00000000E06D0000 - 00000000E06DFFFF]	Intel(R) Serial IO GPIO Host Controller - INTC1056
[00000000E06E0000 - 00000000E06EFFFF]	Intel(R) Serial IO GPIO Host Controller - INTC1056
[00000000FE010000 - 00000000FE010FFF]	Intel(R) SPI (flash) Controller - 7AA4
[00000000FED00000 - 00000000FED003FF]	High precision event timer
[00000000FED20000 - 00000000FED7FFFF]	Motherboard resources
[00000000FED40000 - 00000000FED44FFF]	Trusted Platform Module 2.0
[00000000FED45000 - 00000000FED8FFFF]	Motherboard resources
[00000000FED90000 - 00000000FED93FFF]	Motherboard resources
[00000000FEDA0000 - 00000000FEDA0FFF]	Motherboard resources
[00000000FEDA1000 - 00000000FEDA1FFF]	Motherboard resources
[00000000FEDC0000 - 00000000FEDC7FFF]	Motherboard resources
[00000000FEE00000 - 00000000FEEFFFFFFF]	Motherboard resources
[0000004000000000 - 000000400FFFFFFF]	Intel(R) UHD Graphics
[0000006000000000 - 0000006000FFFFFFF]	Intel(R) UHD Graphics
[0000006001100000 - 000000600110FFFF]	Intel(R) USB 3.2o xTensible Host Controller - 1.20 (Microsoft)
[0000006001110000 - 0000006001117FFF]	Performance Monitor
[0000006001120000 - 00000060011200FF]	Intel(R) SMBus - 7AA3
[00000077FFEF7000 - 00000077FFEF7FFF]	Intel(R) Serial IO I2C Host Controller - 7ACF
[00000077FFEF8000 - 00000077FFEF8FFF]	Intel(R) Serial IO I2C Host Controller - 7ACE
[00000077FFEF9000 - 00000077FFEF9FFF]	Intel(R) Serial IO I2C Host Controller - 7ACD
[00000077FFFEA000 - 00000077FFFEAFFF]	Intel(R) Serial IO I2C Host Controller - 7ACC
[00000077FFEFB000 - 00000077FFEFBFFF]	Intel(R) Management Engine Interface #1
[00000077FFFC0000 - 00000077FFFCFFFF]	High Definition Audio Controller
[00000077FFFF0000 - 00000077FFFFFFFF]	High Definition Audio Controller

# Appendix B

---

Assembly Guide

## B.1 Introduction

This section details the steps needed to install various hardware components for the EPIC-ADS7-PUC. It is recommended that you read through each step before beginning installation and to make sure you have all necessary tools and components.

## B.2 CPU Installation

**Step 1:** Remove the two (2) screws located on the rear I/O side of the chassis, as shown.



**Step 2:** Remove the top cover of the chassis by sliding it towards the rear I/O side, keeping the chassis cover flat throughout.

**Note:** Do not attempt to remove chassis by pulling it upwards.

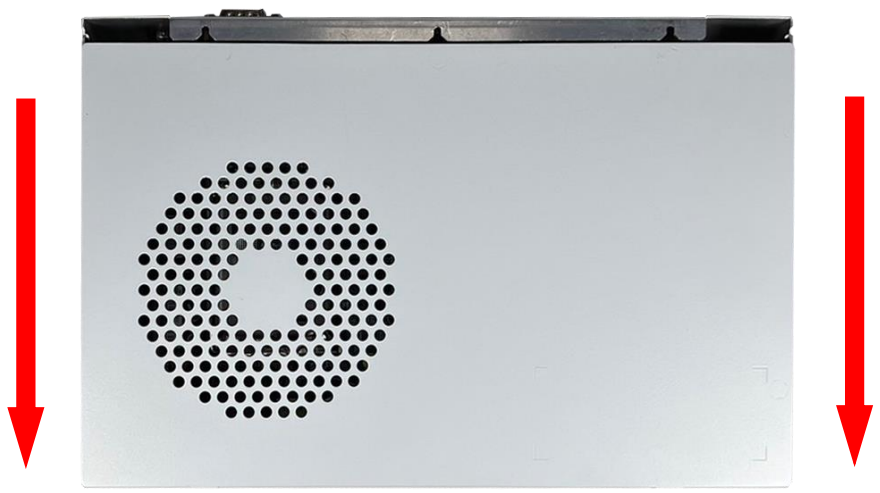



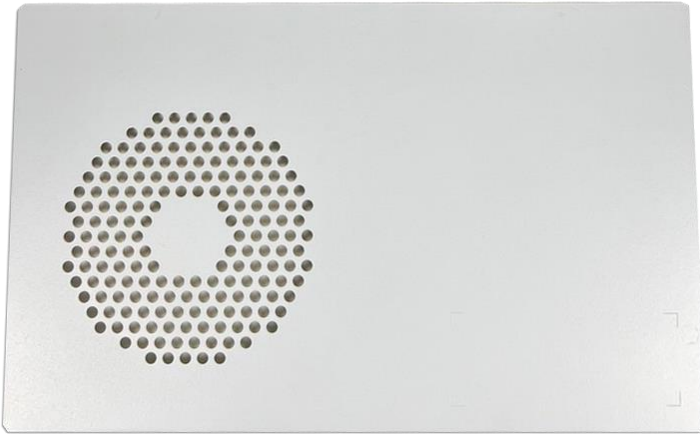
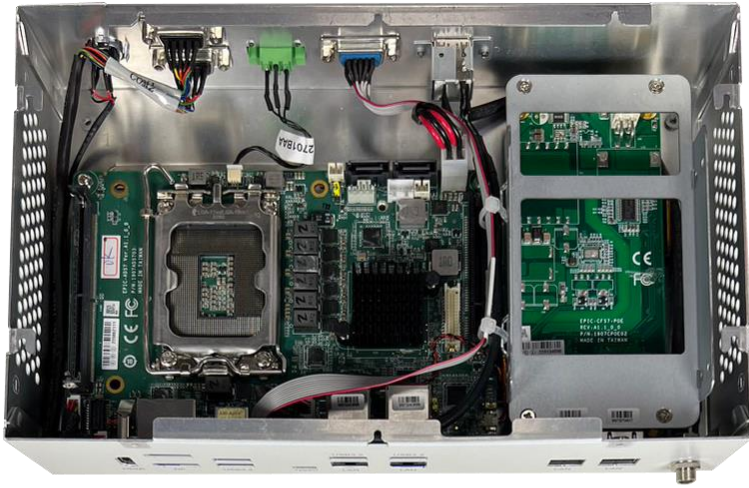

Following top cover removal, you will have access to the system's motherboard.



**Step 3:** Remove the CPU cover, then follow the below instructions:

1. Pull the metal hinge to the left of the socket and then upwards towards the rear I/O side.
2. Lift the socket bracket.
3. Insert the CPU module with the triangle image on the top of the module facing the top right corner of the CPU socket.
4. Return the socket bracket.
5. Fasten socket hinge.

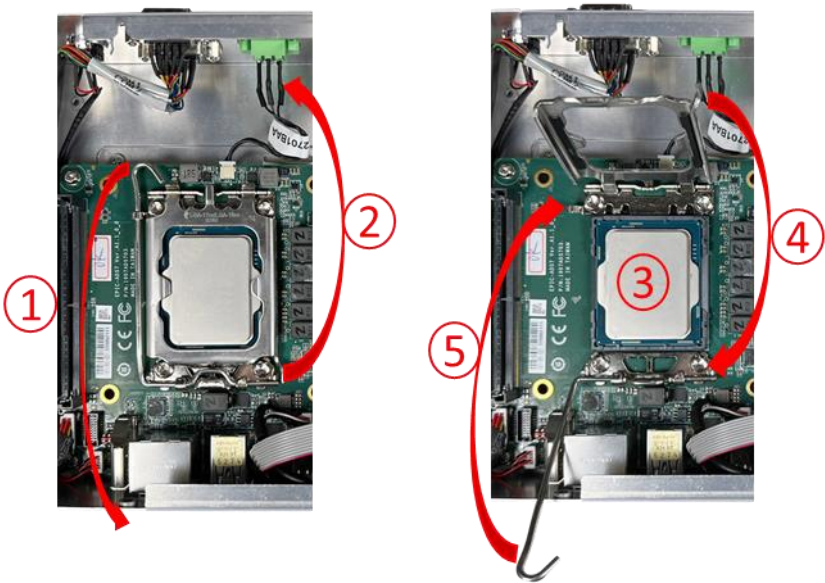

### B.3 DDR5 Module Installation (DIMM2)

To access SODIMM slot, follow the cover removal instructions given in steps 1 and 2 of section B.2.

**Step 1:** Insert the DDR5 module to the SODIMM slot at a 30° angle until you hear a sharp click.

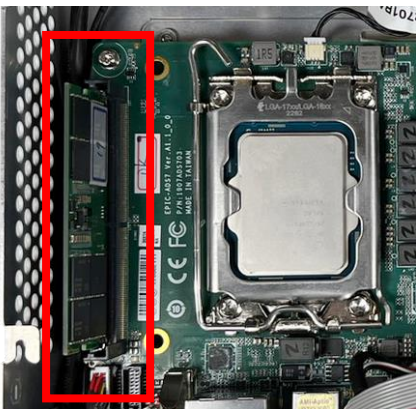

**Step 4:** Replace the top cover of the chassis by sliding it towards the top I/O side, keeping the chassis cover flat throughout.

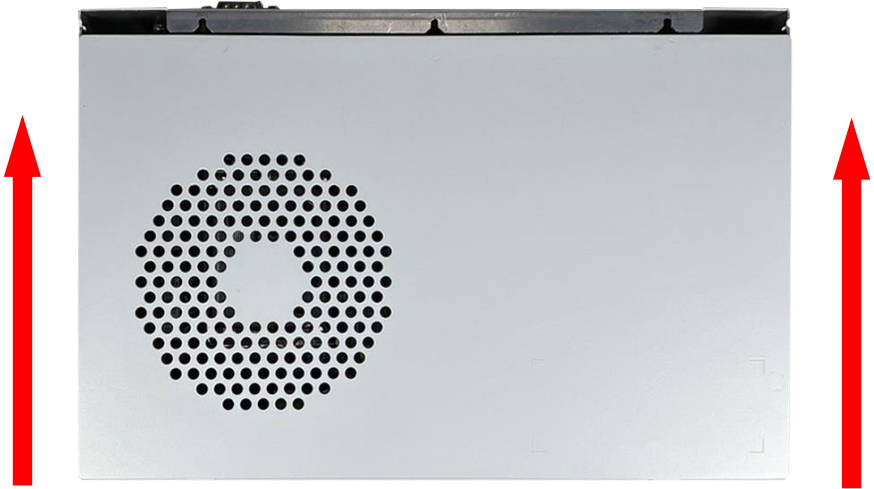

**Step 5:** Reaffix the two (2) screws that were removed from the top I/O side of the chassis during step 1.



## B.4 DDR5 Module Installation (DIMM1)

The system's second SODIMM slot is accessible via the bottom side of the chassis.

**Note:** Prior to DDR5 module installation, please follow the below instructions to apply thermal pads to the cooler backplate.

**Step 1:** Remove the two (2) screws located on the bottom chassis cover, as shown.

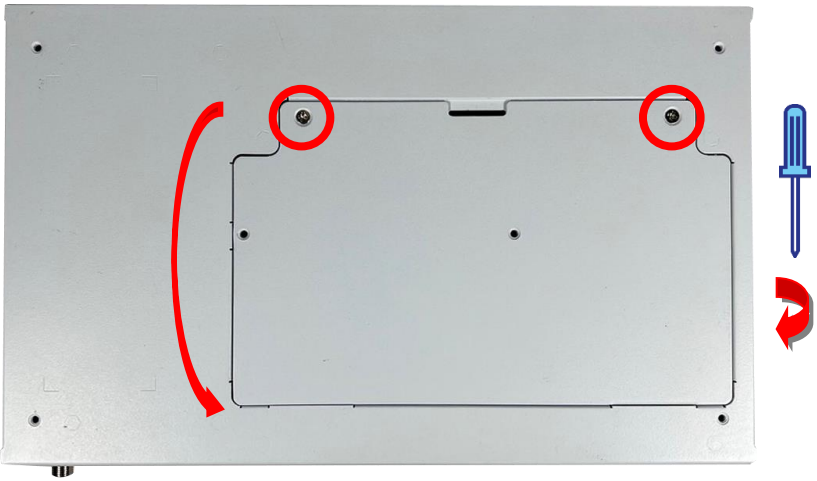

Remove the cover by lifting upwards at an angle.

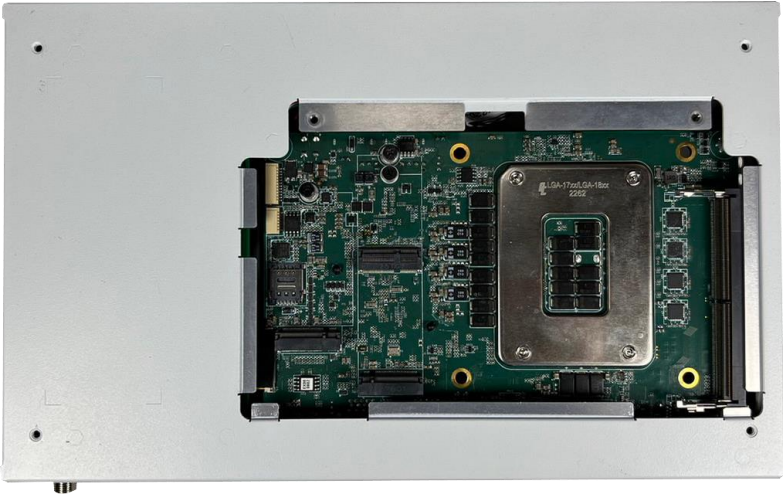

**Step 2:** Remove the covers from the cooler backplate rods (see packing list for details), and secure one either end of the CPU socket bottom, as shown.

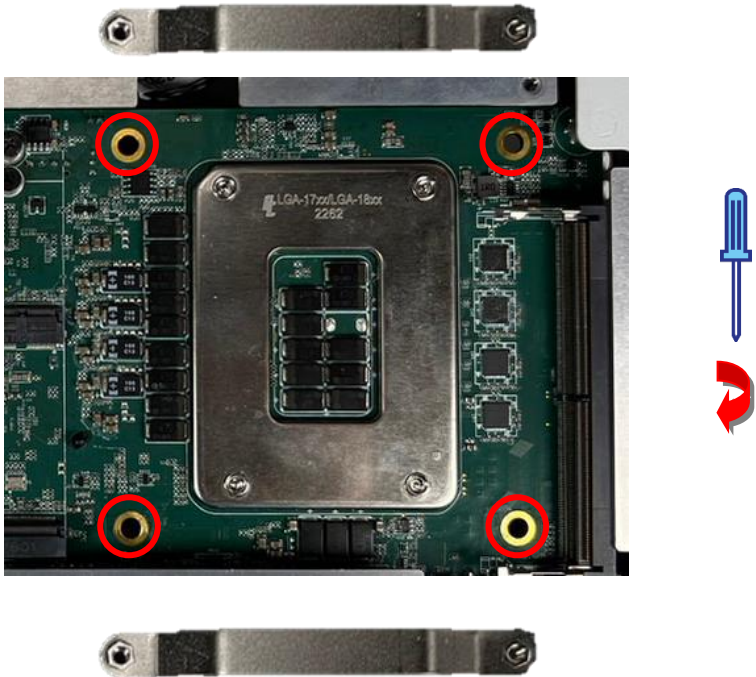



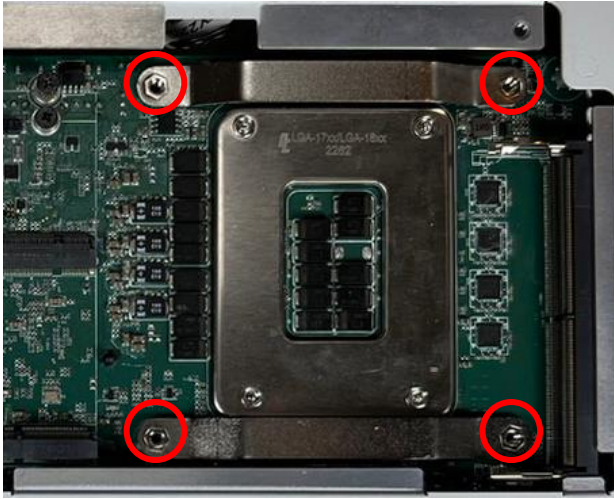

**Step 3:** Remove the plastic from the thermal pads and affix to the backplate, as shown.

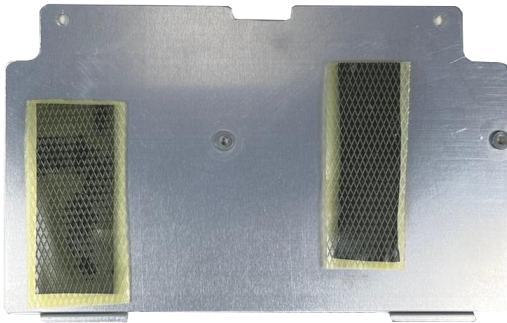







## B.5.2 M.2 2280 M-Key Installation

Follow standard procedures for expansion card installation, ensuring that the M.2 2280 module has been installed prior to beginning M.2 2280 module installation. Align the notch on the M.2 2280 module with the M.2 M-Key slot. Note the location of the mounting screws.

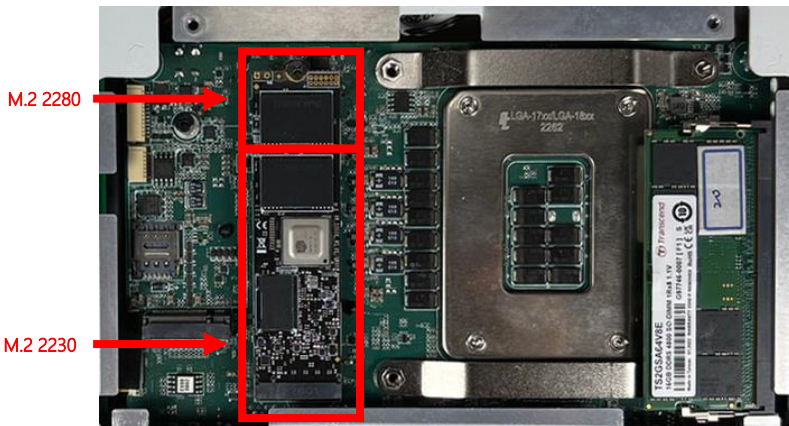
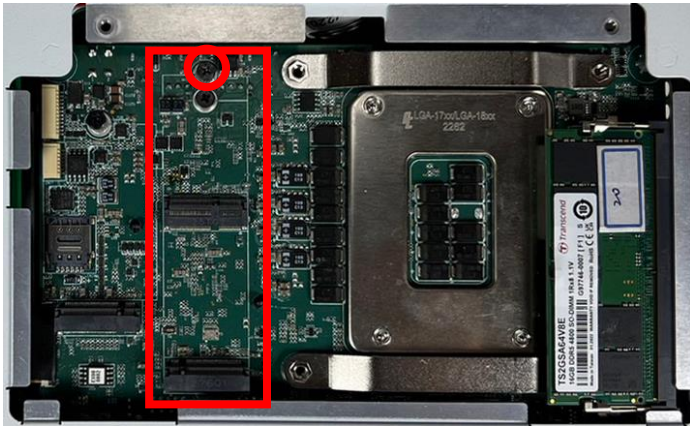

Once all expansion modules have been installed, reattach backplate to chassis and affix with the two (2) screws removed during B.4 Step 1.

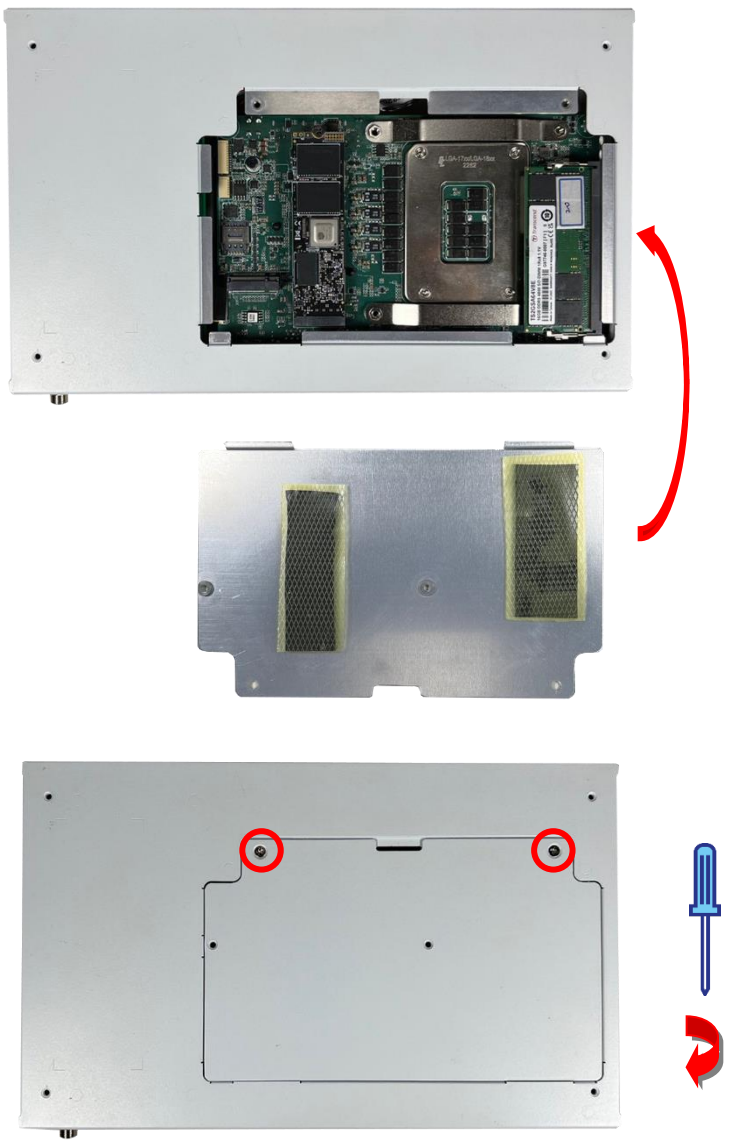

## B.6 CPU Fan Installation

### Note:

To install the CPU fan, return chassis to starting position from section B.2, accessing the relevant connector via the top side of the chassis.

**Step 1:** Remove the two (2) screws located on the top I/O side of the chassis, as shown.



**Step 2:** Remove the top cover of the chassis by sliding it towards the top I/O side, keeping the chassis cover flat throughout.

**Note:** Do not attempt to remove chassis by pulling it upwards.

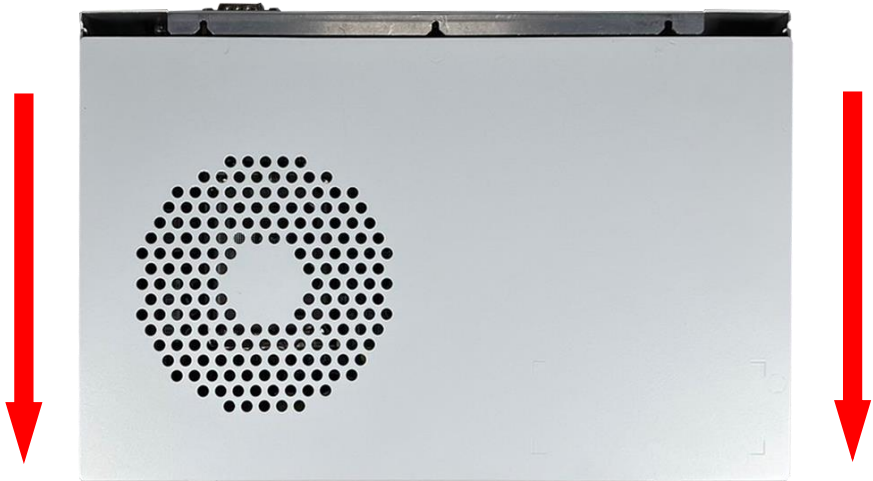

**Step 3:** Affix the cooler to the board using the four (4) screws provided, ensuring the cooler is aligned facing away from the front I/O side of the chassis.

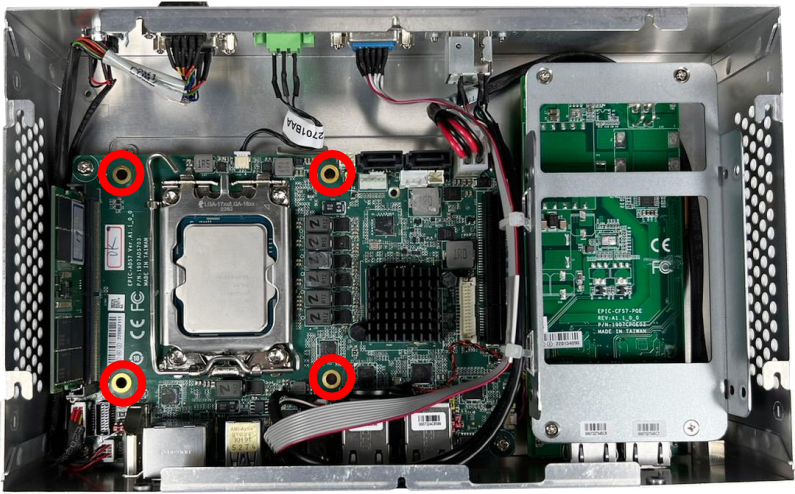

CN8

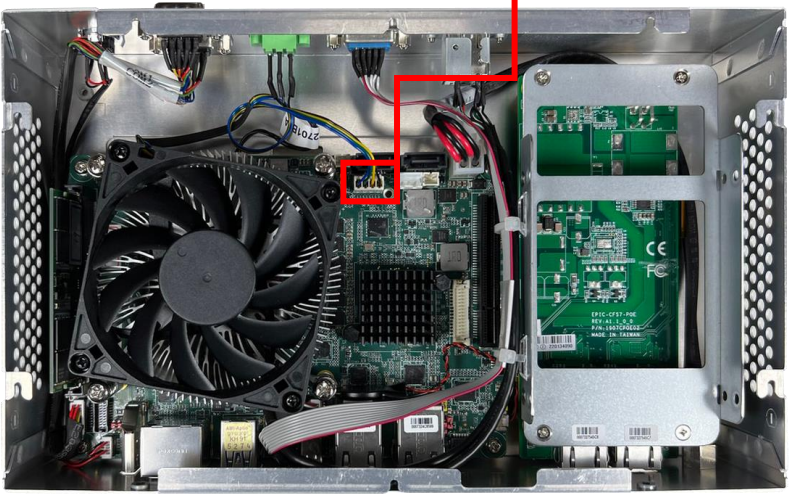

**Step 4:** Connect the cooler power cable to the CPU fan connector (CN8), as shown.

## B.7 SSD Installation

**Note:** Prior to SSD bracket removal, ensure to cut and remove any cable ties.

**Step 1:** Remove the existing SSD bracket by removing the four (4) screws as shown.

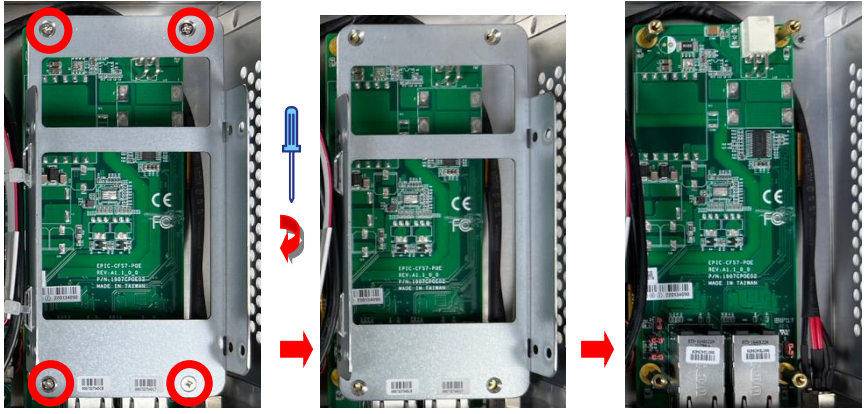

**Step 2:** Secure first SSD to the bracket using four (4) screws, followed by the second SSD on top of that, again secured via four (4) screws.

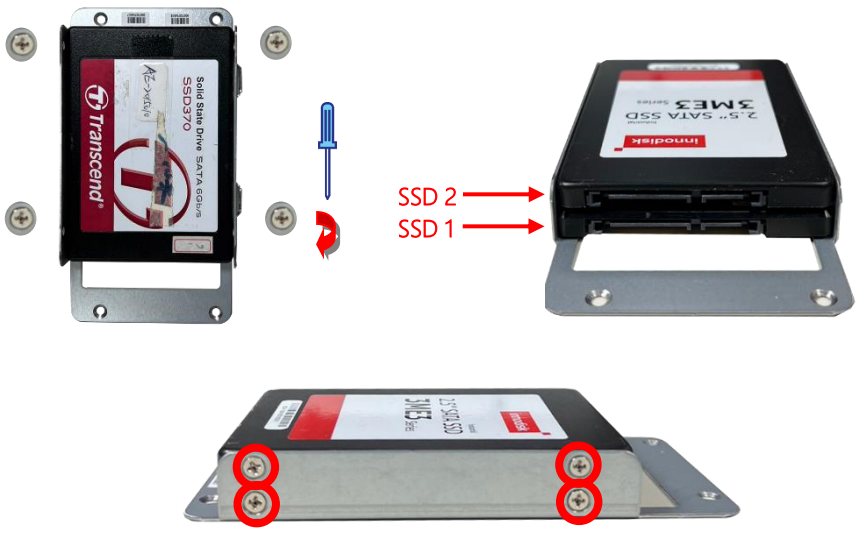



**Step 3:** Attach the SATA connector and SATA power cables to the SSDs, then reinsert the SSD bracket to the system, securing it with the four (4) screws removed during step 1.



**Step 4:** Attach the other end of the cables to their respective connectors (see section 2.5 for connector configuration).

**Step 5:** Reattach existing cables to the SSD bracket using the cable ties provided, then clip excess length with pliers as needed.

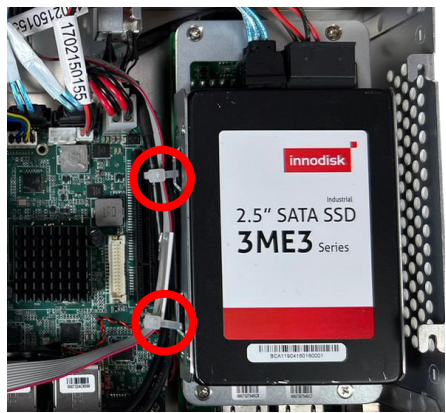

**Step 6:** Close and secure chassis cover by sliding the top cover and securing with the four (4) screws removed during step 1 of section B.6.

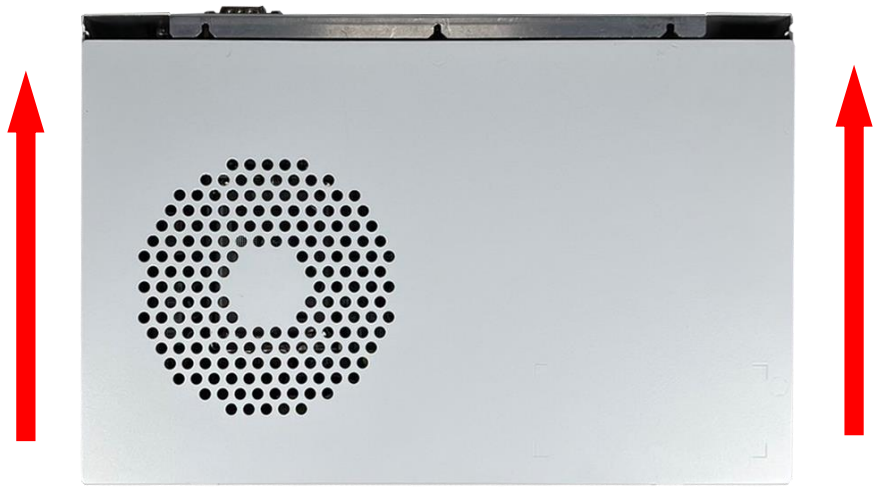

When finished, chassis should be fully closed and secure.

